

SH170R6 Series Quick Guide 【 English 】

62R-SH1700-5203 SH170R6 Series
English, Spanish, Korean,
Traditional Chinese, Japanese,
French, German Quick Guide

Front Panel

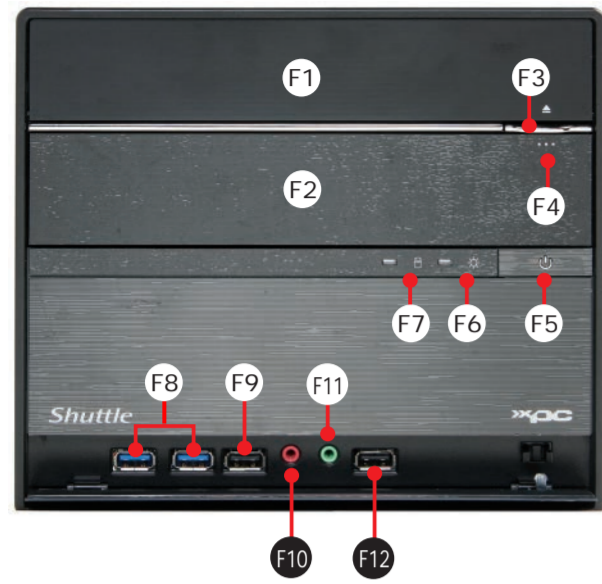

- F1. 5.25" Bay
- F2. 3.5" Bay
- F3. ODD Eject Button
- F4. 3.5" HDD Bay Cover Button
- F5. Power On Button
- F6. Power LED
- F7. HDD LED
- F8. USB 3.0 Port
- F9. USB 2.0 Port
- F10. Mic In
- F11. Headphone
- F12. USB 2.0 Port & Fast Charger

Back Panel

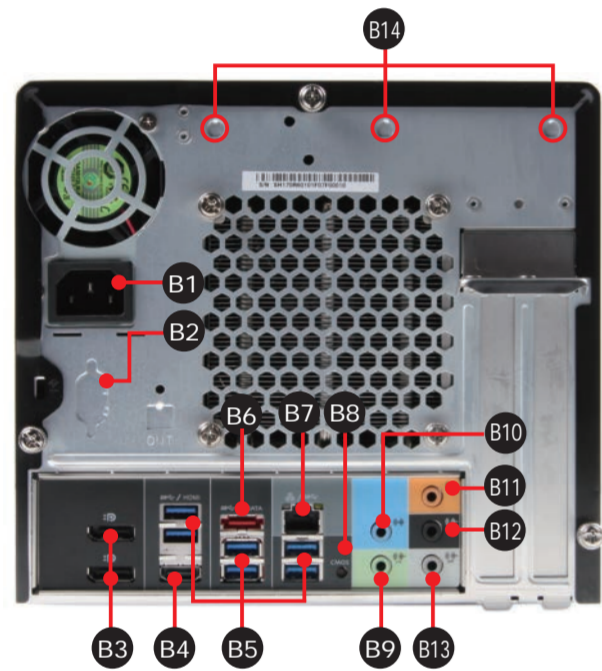

- B1. AC Power Socket
- B2. Serial Port (Optional)
- B3. DisplayPort
- B4. HDMI Port
- B5. USB 3.0 Port
- B6. eSATA Port
- B7. LAN Port
- B8. Clear CMOS Button
- B9. Front Speaker Out (L/R) Port
- B10. Line-In Port
- B11. Side Speaker Out (L/R) Port
- B12. Real Speaker Out (L/R) Port
- B13. Center/Subwoofer Speaker Out Port
- B14. Wireless LAN Perforation (Optional)

Motherboard Illustration

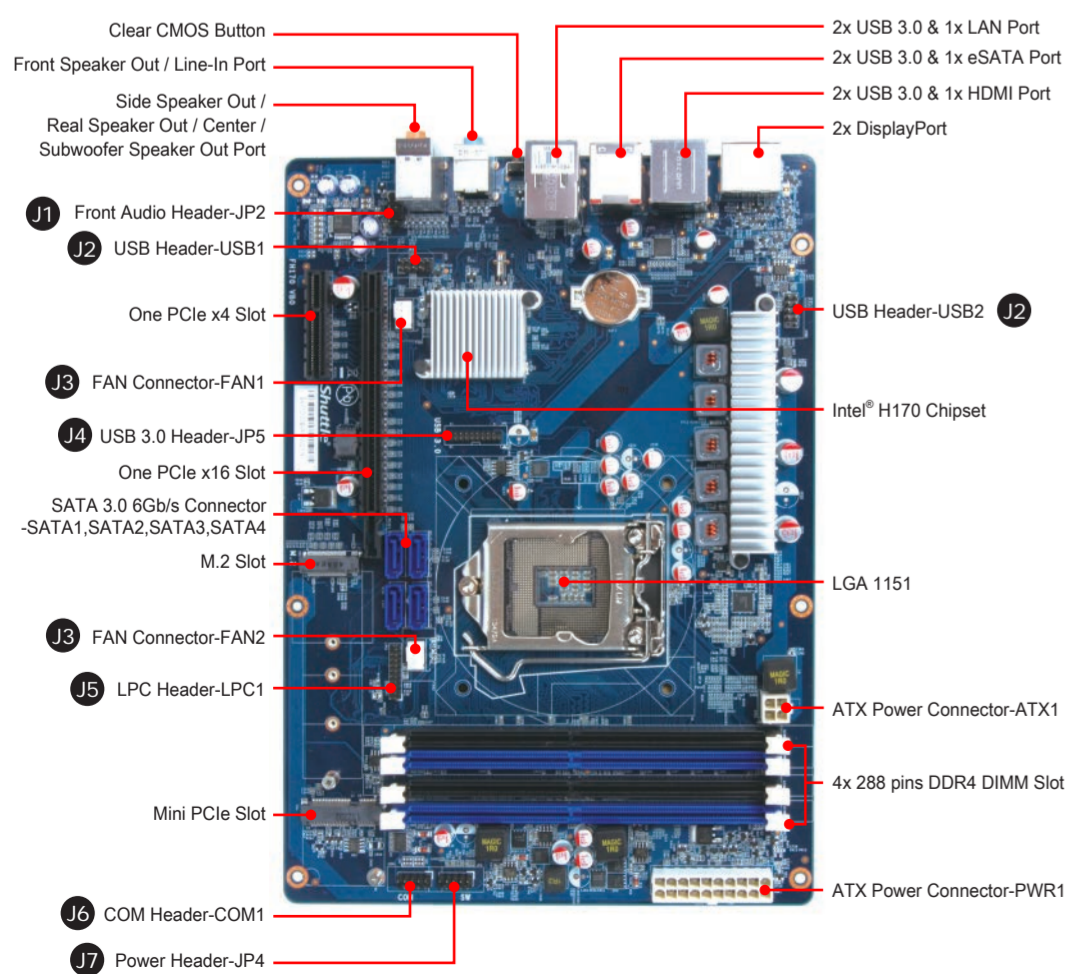

- J1. Front Audio Header-JP2
- J2. USB Header-USB1
- J3. FAN Connector-FAN1
- J4. USB 3.0 Header-JP5
- J5. LPC Header-LPC1
- J6. COM Header-COM1
- J7. Power Header-JP4

Jumper Settings

J1 Front Audio Header (JP2)

- | | |
|----------|----------------|
| 1=MIC_L | 2=GND |
| 3=MIC_R | 4=Front_Detect |
| 5=LINE_R | 6=mic_detect |
| 7=sense | 8=NULL |
| 9=LINE_L | 10=Line_Detect |

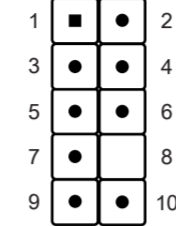

J2 USB Header (USB1,USB2)

- | | |
|----------|----------|
| 1=5V_USB | 2=5V_USB |
| 3=USB A- | 4=USB B- |
| 5=USB A+ | 6=USB B+ |
| 7=GND | 8=GND |
| 9=NULL | 10=GND |

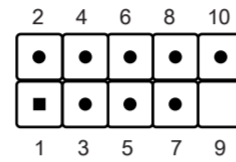

J3 Fan Connectors (FN1,FN2)

- | | |
|---------------|---|
| 1=Ground | 4 |
| 2=+12V | 3 |
| 3=SPEED_SENSE | 2 |
| 4=PWM_CTRL | 1 |



J4 USB 3.0 Header (JP5)

- | | |
|-------------|-------------|
| 1=5VCC | 2=A_RX_N |
| 3=A_RX_P | 4=Ground |
| 5=A_TX_N | 6=A_TX_P |
| 7=Ground | 8=A_Data_N |
| 9=A_Data_P | 10=OC |
| 11=B_Data_P | 12=B_Data_N |
| 13=Ground | 14=B_TX_P |
| 15=B_TX_N | 16=Ground |
| 17=B_RX_P | 18=B_RX_N |
| 19=5VCC | 20=NULL |

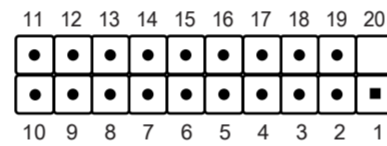

J5 LPC Header (LPC1)

- | | |
|------------|-----------|
| 1=+12V | 2=5V |
| 3=5VSB | 4=SERIRQ |
| 5=CLK_24M | 6=CLK_24M |
| 7=SIO_RST | 8=LFRAME |
| 9=LAD3 | 10=LAD2 |
| 11=-12V | 12=3VSB |
| 13=NA | 14=LDRO0 |
| 15=SIO_PME | 16=LAD1 |
| 17=LADO | 18=+3.3V |
| 19=GND | 20=NULL |

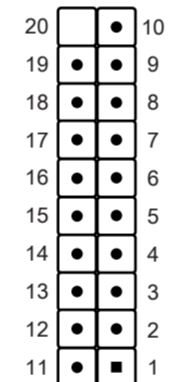

J6 COM Header (COM1)

- | | |
|----------|---------|
| 1=DCD | 2=RXD |
| 3=TXD | 4=DTR |
| 5=Ground | 6=DSR |
| 7=RTS | 8=CTS |
| 9=NA | 10=NULL |

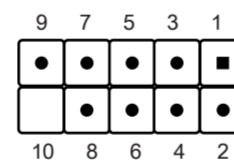

J7 Power Header (JP4)

- | | |
|-----------|-----------|
| 1=+HD_LED | 2=PWR_LED |
| 3=-HD_LED | 4=GND |
| 5=RST_SW | 6=PWR_SW |
| 7=GND | 8=GND |
| 9=NA | 10=NULL |

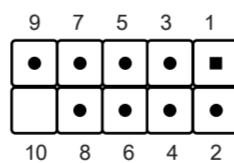

Safety Information

Read the following precautions before setting up a Shuttle XPC.

CAUTION

Incorrectly replacing the battery may damage this computer. Replace only with the same or equivalent as recommended by Shuttle. Disposal of used batteries according to the manufacturer's instructions.

Laser compliance statement

The optical disc drive in this PC is a laser product. The drive's classification label is located on the drive.

CLASS 1 LASER PRODUCT

CAUTION: INVISIBLE LASER RADIATION WHEN OPEN. AVOID EXPOSURE TO BEAM.

A. Begin Installation

For safety reasons, please ensure that the power cord is disconnected before opening the case.

- Unscrew 3 thumbscrews of the chassis cover.
- Slide the cover backwards and upwards.

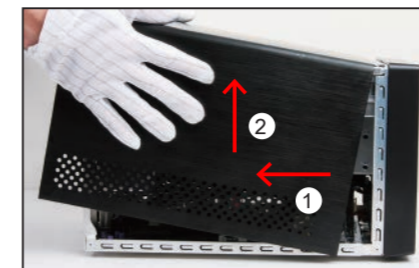

- Unfasten the rack mount screws and remove the rack.

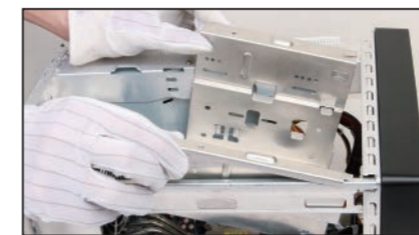

B. CPU and ICE Installation

- Unfasten the ICE fan thumbscrews on the back of the chassis.
- Unfasten the four ICE module attachment screws and unplug the fan connector.

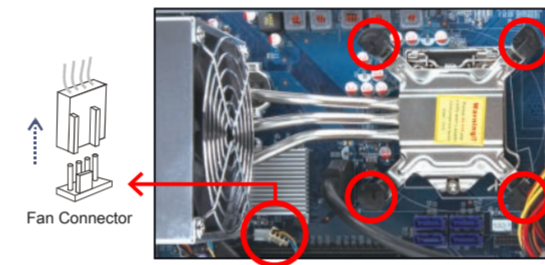

- Remove the ICE module from the chassis and put it aside.

This 1151-pin socket is easily damaged and pins bend quickly. Always use extreme care when installing a CPU and limit the number of times that you remove or change the CPU. Before installing the CPU, make sure to turn off the computer and unplug the power cord from the power outlet to prevent damage to the CPU.

Follow the steps below to correctly install the CPU into the motherboard CPU socket.

- First unlock and raise the socket lever.

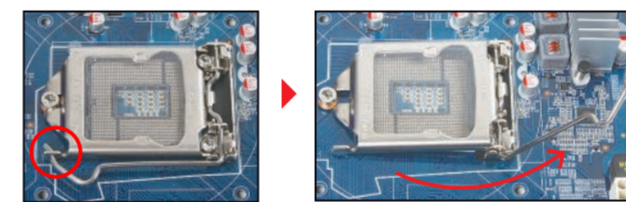

- Tear off the protective membrane from the metal load plate. Lift the metal load plate on the CPU socket.

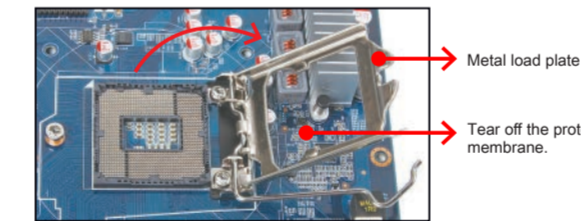

DO NOT touch socket contacts. To protect the CPU socket, always replace the protective socket cover when the CPU is not installed.

- Please orientate the CPU correctly and align the CPU notches with the socket alignment keys. Make sure the CPU sits perfectly horizontal, then push it gently into the socket.

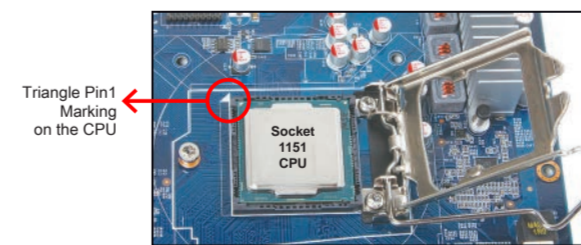

Please be aware of the CPU orientation, DO NOT force the CPU into the socket to avoid bending of pins and damage of CPU!

- Close the metal load plate, lower the CPU socket lever and lock in place.
- Spread thermal paste evenly on the CPU surface.

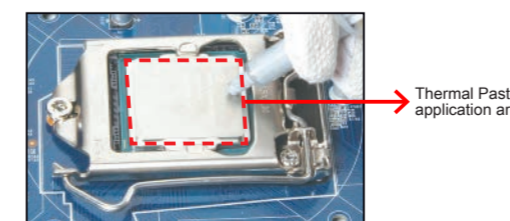

Please do not apply excess amount of thermal paste.

- Screw the ICE module to the mainboard. Note to press down on the opposite diagonal corner while tightening each screw.
- Connect the fan connector.

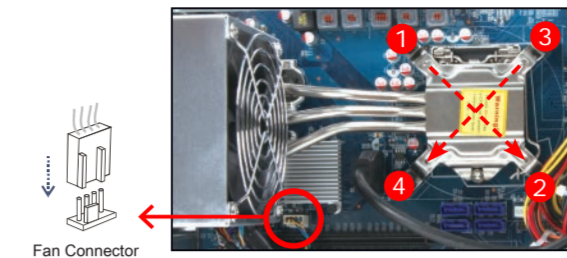

- Fasten the Smart Fan to the chassis with the four thumbscrews.

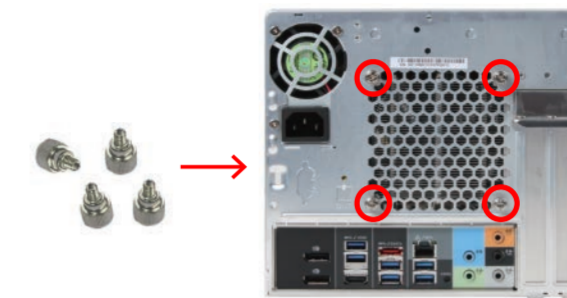

C. Memory Module Installation

Guidelines for Memory Configuration

Before installing DIMMs, read and follow these guidelines for memory configuration.

Make sure that the motherboard supports the memory. It is recommended that memory of the same capacity, brand, speed, and chips are used. (Go to Shuttle's website for the latest memory support list.) Memory modules have a foolproof design. A memory module can be installed in only one direction. If you are unable to insert the memory, switch the direction.

Dual-Channel mode Population Rule

In Dual-Channel mode, the memory modules can transmit and receive data with two data bus lines simultaneously. Enabling Dual-Channel mode can enhance the system performance. The following illustrations explain the population rules for Dual-Channel mode.

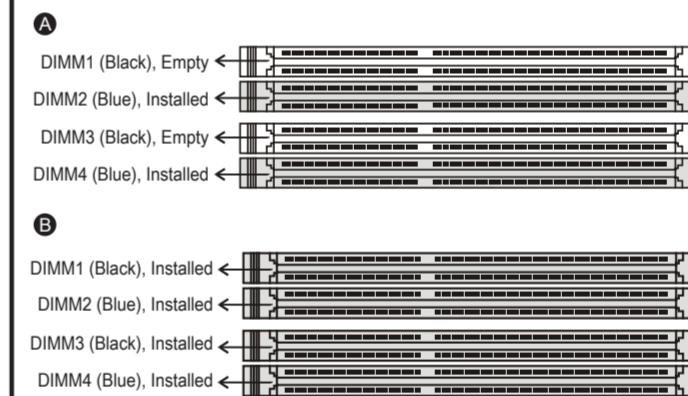

Installing a memory module

DDR4 and DDR3/DDR2 DIMMs are not compatible to each other or other DDR DIMMs. Be sure to install DDR4 DIMMs on this motherboard. Follow the steps below to correctly install your memory modules in the memory sockets.

- Unlock the DIMM latch.
- Align the memory module's cutout with the DIMM slot notch. Slide the memory module into the DIMM slot.

A DDR4 memory module has a cutout, so it only fits in one direction.

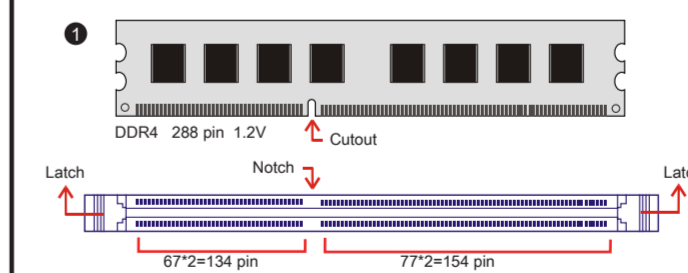

- Check that the latches are closed, and the memory module is firmly installed.

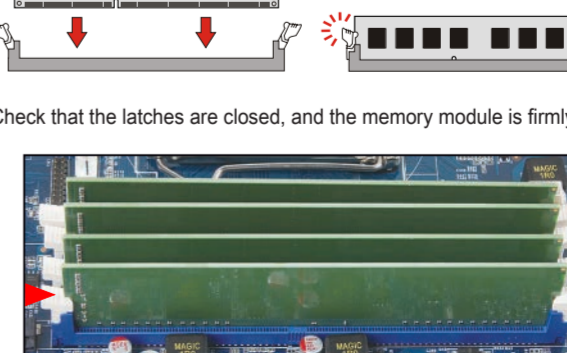

Repeat the above steps to install additional memory modules, if required.

D. Component Installation

- As shown, unfasten the screw first.
- Install the Mini PCI-E card / M.2 SSD into the Mini PCI-E slot / M.2 slot and secure with screw.



E. Installation of Drives

- Loosen the purse lock and separate the Serial ATA and power cables.
- Place the HDD and optical drive in the rack and secure with screws from the side.

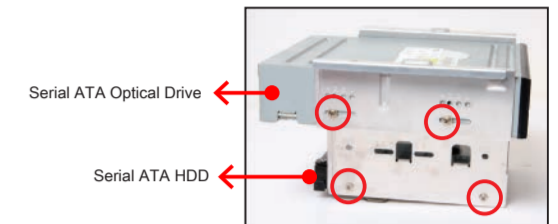

- Connect the Serial ATA Cable to the motherboard.
- Place the rack in the chassis and refasten the rack.

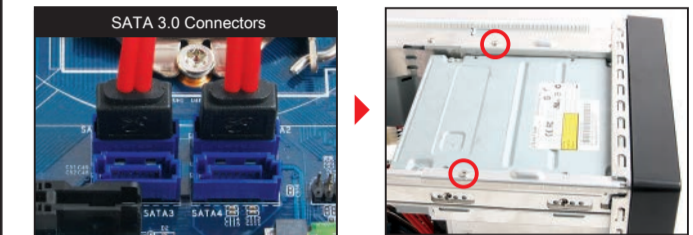

- Connect the Serial ATA and power cables to the HDD.

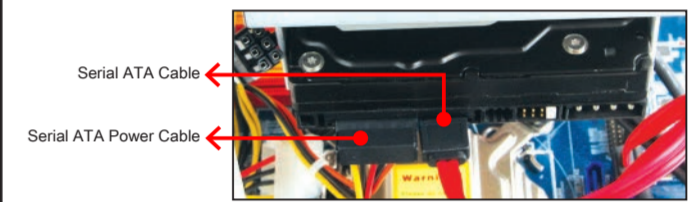

- Connect the Serial ATA and power cables to the optical drive.

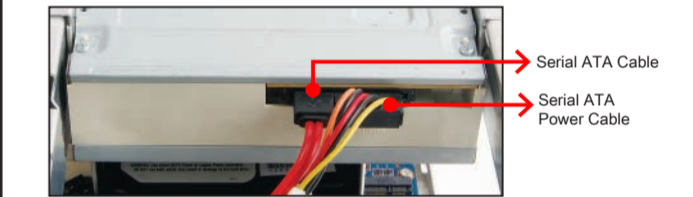

F. Installation of Expansion Cards

- Unfasten the expansion slot bracket screws. Remove the back panel bracket and put it aside.

The maximum size acceptable for display cards is 267mm x 98mm x 34.6mm.

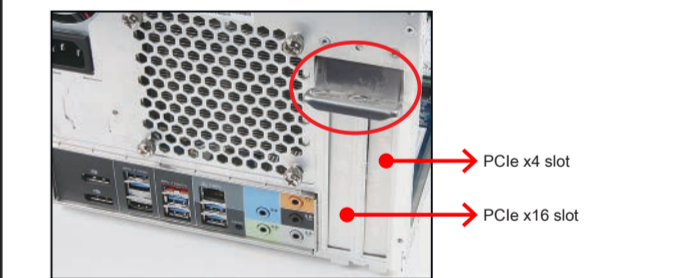

- Install the PCIe x4 / PCIe x16 card into the PCIe x4 / PCIe x16 slots.
- Secure the bracket.

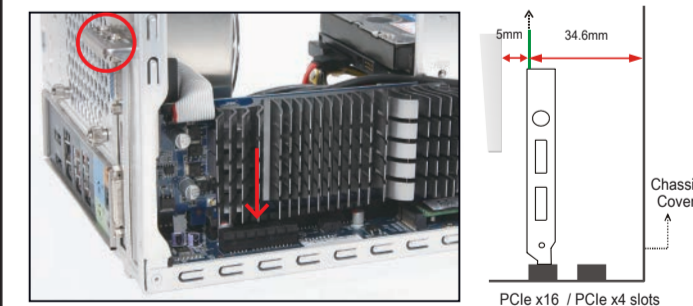

G. Complete

- Replace the cover and refasten the thumbscrews.

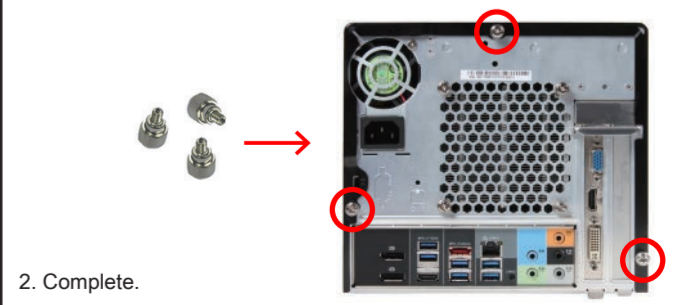

- Complete.

Please press the "Del" key while booting to enter BIOS. Here, please load the optimised BIOS settings.