



**4 x 4 / 9 x 9 HDMI HDBaseT-Lite Matrix Switch
VM3404H / VM3909H
User Manual**



EMC Information

FEDERAL COMMUNICATIONS COMMISSION INTERFERENCE STATEMENT:

This equipment has been tested and found to comply with the limits for a Class A digital device, pursuant to Part 15 of the FCC Rules. These limits are designed to provide reasonable protection against harmful interference when the equipment is operated in a commercial environment. This equipment generates, uses, and can radiate radio frequency energy and, if not installed and used in accordance with the instruction manual, may cause harmful interference to radio communications. Operation of this equipment in a residential area is likely to cause harmful interference in which case the user will be required to correct the interference at his own expense.

The device complies with Part 15 of the FCC Rules. Operation is subject to the following two conditions: (1) this device may not cause harmful interference, and (2) this device must accept any interference received, including interference that may cause undesired operation.

FCC Caution: Any changes or modifications not expressly approved by the party responsible for compliance could void the user's authority to operate this equipment.

CE Warning: This is a class A product. In a domestic environment this product may cause radio interference in which case the user may be required to take adequate measures.

KCC Statement: 이 기기는 업무용(A급) 전자파 적합기기로서 판매자 또는 사용자는 이점을 주의하시기 바라며, 가정외의 지역에서 사용하는 것을 목적으로 합니다.

RoHS

This product is RoHS compliant.

Safety

This product has been classified as Information Technology Equipment.

SJ/T 11364-2006

The following contains information that relates to China.

部件名称	有毒有害物质或元素					
	铅	汞	镉	六价铬	多溴联苯	多溴二苯醚
电器部件	●	○	○	○	○	○
机构部件	○	○	○	○	○	○

- : 表示该有毒有害物质在该部件所有均质材料中的含量均在SJ/T 11363-2006规定的限量要求之下。
- : 表示符合欧盟的豁免条款, 但该有毒有害物质至少在该部件的某一均质材料中的含量超出SJ/T 11363-2006的限量要求。
- X: 表示该有毒有害物质至少在该部件的某一均质材料中的含量超出SJ/T 11363-2006的限量要求。



User Information

Online Registration

Be sure to register your product at our online support center:

International	http://eservice.aten.com
---------------	---

Telephone Support

For telephone support, call this number:

International	886-2-8692-6959
China	86-10-5255-0110
Japan	81-3-5615-5811
Korea	82-2-467-6789
North America	1-988-999-ATEN ext 4988
United Kingdom	44-8-4481-58923

User Notice

All information, documentation, and specifications contained in this manual are subject to change without prior notification by the manufacturer. The manufacturer makes no representations or warranties, either expressed or implied, with respect to the contents hereof and specifically disclaims any warranties as to merchantability or fitness for any particular purpose. Any of the manufacturer's software described in this manual is sold or licensed *as is*. Should the programs prove defective following their purchase, the buyer (and not the manufacturer, its distributor, or its dealer), assumes the entire cost of all necessary servicing, repair and any incidental or consequential damages resulting from any defect in the software.

The manufacturer of this system is not responsible for any radio and/or TV interference caused by unauthorized modifications to this device. It is the responsibility of the user to correct such interference.

The manufacturer is not responsible for any damage incurred in the operation of this system if the correct operational voltage setting was not selected prior to operation. **PLEASE VERIFY THAT THE VOLTAGE SETTING IS CORRECT BEFORE USE.**

Package Contents

The VM3404H / VM3909H package consists of:

- ◆ 1 VM3404H / VM3909H 4 x 4 / 9 x 9 HDMI HDBaseT-Lite Matrix Switch
- ◆ 1 Power Cord
- ◆ 1 Mounting Kit
- ◆ 1 User Instructions*

Check to make sure that all the components are present and that nothing got damaged in shipping. If you encounter a problem, contact your dealer.

Read this manual thoroughly and follow the installation and operation procedures carefully to prevent any damage to the unit, and/or any of the devices connected to it.

* Features may have been added to the VM3404H / VM3909H since this manual was published. Please visit our website to download the most up-to-date version.

© Copyright 2015 ATEN® International Co., Ltd.
Manual Date: 2015-12-25

ATEN and the ATEN logo are registered trademarks of ATEN International Co., Ltd. All rights reserved.
All other brand names and trademarks are the registered property of their respective owners.

Contents

EMC Information	ii
RoHS	ii
Safety	ii
SJ/T 11364-2006.	ii
User Information	iii
Online Registration	iii
Telephone Support	iii
User Notice	iii
Package Contents	iv
Contents	v
About this Manual	ix
Conventions	x
Product Information	x

Chapter 1.

Introduction

Overview	1
Features	3
Requirements	5
Source Devices	5
Display Devices	5
Cables	5
Source Device Operating Systems	6
Browsers	6
Components	7
VM3404H Front View	7
VM3404H Rear View	8
VM3909H Front View	9
VM3909H Rear View	10

Chapter 2.

Hardware Setup

Rack Mounting	11
Grounding	13
Cable Connection	14
Installation Diagram	15

Chapter 3.

Front Panel Configuration

Overview	17
Front Panel Pushbuttons	17
Enter Password	18
Main Screen	19
Port Switching	19
Input Port Selection	19

Output Port Selection	21
LCD Menu Organization	23
Menu Pushbutton	23
IP Setting	24
IP Address / Subnet Mask	24
Gateway	24
Serial Port Setting	25
Baud Rate	25
Operation Mode	26
EDID Mode	26
CEC	27
OSD	28
Output Status	29
Security Mode	30
Password	30
Change Password	31
Save to a Profile	32
Play/Stop the Profile Schedule	33
Profile Pushbutton	34

Chapter 4.

Browser Operation

Overview	35
Logging In	35
Main Page	36
Menu Bar	36
Profile List	37
Adding/Playing a Profile	37
Profile List Options	39
Profile	39
Play Window	39
Profile Scheduling	41
Connection Profiles	43
Digital Signage Profile	43
Output Icon	44
Select Source	44
Grid View	45
Output Options	45
Video Wall Profile	46
Video Wall Options	46
Number of Displays / Bezel Dimensions	47
Blank Output	48
Independent Output	48
Grouping	49
Group	49
Display Preferences	50

Video Wall Example	51
Output Options	52
Video Options	52
System Settings	54
General	56
Fan Status	56
OSD / CEC	56
Other	56
User Account	58
Add Account	58
Permission Level	59
Port Name	61
Network	62
EDID	63
EDID Mode	64
Customized Mode	65
EDID & CEA Description	66
Customized EDID Settings	67
Firmware	70
IR Channel	71
HDCP	72
Telnet Operation	73
Configuration Menu	73
1. H – Call up the command list for help	73
2. GT – Set gateway address	74
3. IM – Set IP subnet mask	74
4. IP – Set IP address	74
5. LO – Load connections from profile	74
6. PW – Change password	74
7. RI – Read what input is connected to nn output	74
8. RO – Read what output is connected to nn input	75
9. SB – Set serial port baud rate	75
10. SS – Switch input to specified output	75
11. SV – Save the current connections into a profile	75
12. TI – Set timeout	75
13. VR – Software version information	75

Chapter 5.

RS-232 Commands

Serial Control Protocol Commands	77
RS232 Pin Assignment	77
Configuring the Serial Port	77
Verification	78
Switch Port Command	79
EDID Mode Command	81
CEC Command	83

Scaling Command	84
Echo Command	87
Read Command	88
Reset Command	88
Baud Rate Command	89
Save/Load Profile Command	90
OSD Command	91
RS232 Pin Assignment	92

Appendix

Safety Instructions	93
General	93
Rack Mounting	95
Technical Support	96
International	96
North America	96
Specifications	97
Compatible Receivers	99
Limited Warranty	99

About this Manual

This User Manual is provided to help you get the most from your VM3404H / VM3909H system. It covers all aspects of installation, configuration and operation. An overview of the information found in the manual is provided below.

Chapter 1, Introduction, introduces you to the VM3404H / VM3909H system. Its purpose, features and benefits are presented, and its front and back panel components are described.

Chapter 2, Hardware Setup, describes how to set up your VM3404H / VM3909H installation.

Chapter 3, Front Panel Configuration, explains the fundamental concepts involved in operating the VM3404H / VM3909H at the local site via the front panel LCD display using pushbuttons.

Chapter 4, Browser Operation, provides a complete description of the VM3404H / VM3909H's Browser Graphical User Interface (GUI), and how to use it to remotely configure and operate the VM3404H / VM3909H.

Chapter 5, RS-232 Protocol Commands, provides a complete list of the serial control protocol commands used when utilizing the RS-232 Serial Port so that an extra source device can be utilized in the installation.

An Appendix, provides specifications and other technical information regarding the VM3404H / VM3909H.

Conventions

This manual uses the following conventions:

- Monospaced** Indicates text that you should key in.
- [] Indicates keys you should press. For example, [Enter] means to press the **Enter** key. If keys need to be chorded, they appear together in the same bracket with a plus sign between them: [Ctrl+Alt].
 - 1. Numbered lists represent procedures with sequential steps.
 - ◆ Bullet lists provide information, but do not involve sequential steps.
 - Indicates selecting the option (on a menu or dialog box, for example), that comes next. For example, Start → Run means to open the *Start* menu, and then select *Run*.
 -  Indicates critical information.

Product Information

For information about all ATEN products and how they can help you connect without limits, visit ATEN on the Web or contact an ATEN Authorized Reseller. Visit ATEN on the Web for a list of locations and telephone numbers:

International	http://www.aten.com
North America	http://www.aten-usa.com

Chapter 1

Introduction

Overview

The ATEN VanCryst VM3404H / VM3909H 4 x 4 / 9 x 9 HDMI HDBaseT-Lite Matrix Switch is a versatile solution that provides an easy way to route high definition video and audio from any of 4/9 HDMI sources to any of 4/9 HDMI/HDBaseT displays at the same time. As a Matrix Switch, each input can be independently connected to any or all outputs, giving you the ultimate in flexibility and control in any multi-display audio/video installation.

Furthermore, with the latest HDBaseT technology, the VM3404H / VM3909H is able to extend HDMI sources up to 4K2K high-resolution video (with audio signals) over single Cat5 cable to receivers up to 60m away. The VM3404H / VM3909H also features Power over HDBaseT (POH), which can send power over Cat 5e/6 cable without an additional power supply.

When the VM3404H / VM3909H is combined with VE805R receivers, it supports both ATEN Seamless Switch™ technology and Video Wall functionality, employing FPGA matrix system architecture to seamlessly switch between multiple sources and multiple displays. With EDID Expert technology, the VM3404H / VM3909H selects the optimum EDID settings for smooth power-up and the highest quality display. It also features a high-performing scaling engine that converts the video resolution into the display's native resolution to give you the best image quality.

You can easily configure the VM3404H / VM3909H via the front panel LCD display and pushbuttons, and through the use of an IR Remote Control. The LCD provides a quick view of all port connections, and lets operators access the unit's built-in configuration utility.

Furthermore, the VM3404H / VM3909H allows convenient configuration and operation via an intuitive Graphical User Interface (GUI) using any web browser. The web GUI provides you with advanced features which include easy setup of custom Video Wall (when used in conjunction with VE805R receivers) and Digital Signage configurations that can be saved and recalled. Because your VM3404H / VM3909H can be controlled over a standard TCP/IP connection, it conveniently integrates into any existing network for easy remote access. For complete system and install integration, serial control is standard through the VM3404H / VM3909H's built-in RS-232 port that allows the switch to be controlled through a high-end controller or PC.

The VM3404H / VM3909H is an ideal solution for applications that require HDMI outputs from multiple sources to be conveniently delivered to multiple destinations, such as for stage presentations, competitions, control centers, and system installations that require real-time reports.

Features

- ◆ Supports 4 (VM3404H) or 9 (VM3909H) HDMI inputs and mirrored 4 / 9 HDMI and HDBaseT outputs
- ◆ Long Distance Transmission – supports up to 60 m (using Cat 5e/6 cables) or 70m (Cat 6a)
- ◆ HDMI (4K, 3D, Deep Color); HDCP 1.4 compatible
- ◆ Video Wall - allows you to create custom video wall layouts via intuitive web GUI

Note: The video wall feature is only available when the VM3404H / VM3909H is used in conjunction with the VE805R.

- ◆ Features a built in high-performance scaler function for best image quality
- ◆ Easily switch between multiple sources and multiple displays
- ◆ Seamless Switch – provides continuous video streams, real-time switching and stable signal transmission

Note: 1. If Seamless Switch™ is enabled, the video output will not display 4K, 3D, Deep Color or interlaced resolutions (i.e., 1080i). For these features, you must disable Seamless Switch™.

2. Seamless Switch™ is only available when the VM3404H / VM3909H is used in conjunction with the VE805R.

- ◆ EDID Expert™ – selects optimum EDID settings for smooth power-up and highest quality display
 - ◆ Configuration and control via: Front panel LCD display, pushbuttons and web GUI
 - ◆ System Operation:
 - ◆ Serial controller
 - ◆ Browser Graphical User Interface (GUI)
 - ◆ Telnet
 - ◆ Built-in bi-directional RS-232 serial port for high-end system control
 - ◆ Superior video quality – HDTV resolution of 480p, 720p, 1080i, 1080p (1920 x 1080) and 4K
 - ◆ Supports Dolby True HD and DTS HD Master audio
 - ◆ Consumer Electronics Control (CEC) support
-

- ◆ ESD protection for HDMI connections
- ◆ Firmware upgradeable
- ◆ Rack mountable all metal casing

Requirements

The following devices are required for a complete VM3404H / VM3909H installation:

Source Devices

- ◆ Computer or A/V source device with HDMI Type A output connector(s)

Note: A DVI/HDMI adapter is required when connecting a DVI source device.

Display Devices

- ◆ Display devices or receivers with an HDMI Type A input connector

Cables

- ◆ 1 HDMI cable for each source device you will be connecting
- ◆ 1 HDMI cable for each display device you will be connecting
- ◆ 1 Cat 5e cable
- ◆ 1 RS-232 serial cable

Note: No cables are included in this package. We strongly recommend that you purchase high-quality cables of appropriate length since this will affect the quality of the audio and video display. Contact your dealer to purchase the correct cable sets.

Source Device Operating Systems

Supported operating systems are shown in the table below:

OS		Version
Windows		2000 and higher
Linux	RedHat	6.0 and higher
	SuSE	8.2 and higher
	Mandriva (Mandrake)	9.0 and higher
UNIX	AIX	4.3 and higher
	FreeBSD	3.51 and higher
	Sun	Solaris 8 and higher
Novell	Netware	5.0 and higher
Mac		OS 9 and higher
DOS		6.2 and higher

Browsers

Supported web browsers are shown in the table below:

OS	Java Version	Browser	Version
Windows 8.1	V1.8.0_60	Chrome	45.0.2454.85 m
		Firefox	40.0.3
		Safari	5.1.7
		Opera	31.0.1889.174
		IE11	11
Windows 2012 R2 (64bit)	V1.8.0_60 (64bit)	IE11	11 (64bit)
Windows 2008 R2 (64bit)	V1.8.0_60 (64bit)	IE8	8
Windows 7 SP1(64bit)	V1.8.0_60 (64bit)	IE10	10 (64bit)
Windows XP	V1.8.0_60	IE8	8
CentOS 7.0 (64Bit)	V1.8.0_60 (64bit)	Firefox	40.0.3
Ubuntu 12.04	V1.8.0_60	Chrome	45.0.2454.85
Solaris 11(64bit)	V1.8.0_25	Firefox	33
Mac 10.10	V1.8.0_25	Safari	8

Components

VM3404H Front View

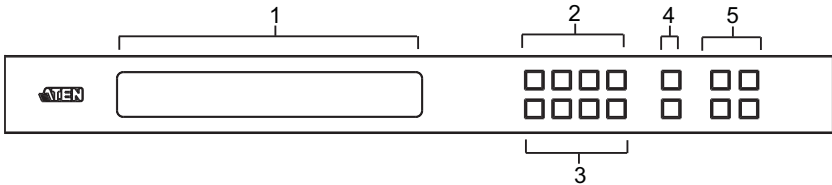

No.	Component	Description
1	LCD Display	The LCD Display gives a quick view of all port connections, and shows the various options for configuring and operating the VM3404H. For full details, see <i>Main Screen</i> , page 19.
2	Input Pushbuttons	These pushbuttons refer to the HDMI Input ports found on the VM3404H rear panel. Press to select the Input port. These pushbuttons may also correspond to menu options, connection profiles (P1–P4) and so on. Note: The INPUT (1–4) front panel pushbuttons have built-in LEDs that light to indicate they have been selected.
3	Output Pushbuttons	These pushbuttons refer to the HDMI/HDBaseT Output ports found on the VM3404H rear panel. Press to select the Output port. These pushbuttons may also correspond to connection profiles (P5–P8). Note: The OUTPUT (1–4) front panel pushbuttons have built-in LEDs that light to indicate they have been selected.
4	Prev / Next Pushbuttons	These pushbuttons allow you to cycle through the menu options on the LCD display.
5	Function Pushbuttons	The function pushbuttons (MENU , PROFILE , ENTER and CANCEL) are for navigating the LCD built-in configuration utility. For full details, see <i>Front Panel Pushbuttons</i> , page 17. Note: The MENU and PROFILE front panel pushbuttons have built-in LEDs that light to indicate they have been selected.

VM3404H Rear View

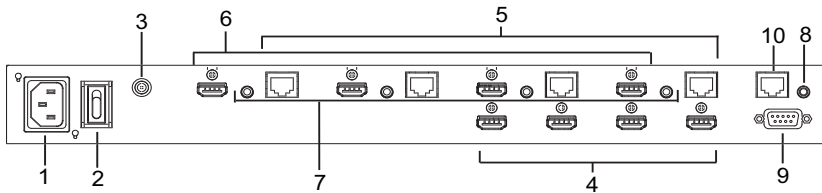

No.	Component	Description
1	Power Socket	This is a standard 3-pin AC power socket. The power cord from an AC source plugs in here.
2	Power Switch	This is a standard rocker switch that powers the unit on and off.
3	Grounding Terminal	The grounding wire attaches here. See <i>Grounding</i> , page 13, for further details.
4	HDMI Input Ports	The cables from your HDMI source devices plug into these ports.
5	HDBaseT Output Ports	The cables from your remote HDBaseT display devices or HDBaseT receivers plug into these ports.
6	HDMI Output Ports	The cables from your local HDMI display devices plug into these ports.
7	IR Channel Ports	Connect IR receivers / transmitters into the IR Channel ports for controlling the source and the display from local or remote locations.
8	IR Port	Connect an IR unit via the 3.5 mm Mini Stereo Jacks. IR signals are used to control the VM3404H.
9	RS-232 Serial Port	Connect a computer or high-end system controller via this serial port.
10	Ethernet Port	In order to access the VM3404H's Browser Graphical User Interface (GUI), the VM3404H must be connected to your network. The cable that connects the VM3404H to your LAN plugs in here. See <i>Cable Connection</i> , page 14, for further details

VM3909H Front View

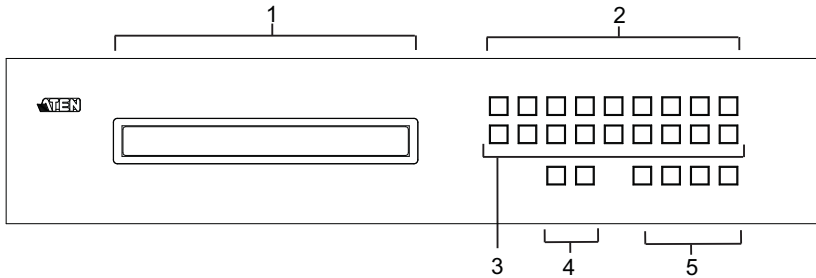

No.	Component	Description
1	LCD Display	The LCD Display gives a quick view of all port connections, and shows the various options for configuring and operating the VM3909H. For full details, see <i>Main Screen</i> , page 19.
2	Input Pushbuttons	These pushbuttons refer to the HDMI/HDBaseT Input ports found on the VM3909H rear panel. Press to select the Input port. These pushbuttons may also correspond to menu options, connection profiles (P1–P9) and so on. Note: The INPUT (1–9) front panel pushbuttons have built-in LEDs that light to indicate they have been selected.
3	Output Pushbuttons	These pushbuttons refer to the HDMI Output ports found on the VM3909H rear panel. Press to select the Output port. These pushbuttons may also correspond to connection profiles (P10–P18). Note: The OUTPUT (1–9) front panel pushbuttons have built-in LEDs that light to indicate they have been selected.
4	Prev / Next Pushbuttons	These pushbuttons allow you to cycle through the menu options on the LCD display.
5	Function Pushbuttons	The function pushbuttons (MENU , PROFILE , ENTER and CANCEL) are for navigating the LCD built-in configuration utility. For full details, see <i>Front Panel Pushbuttons</i> , page 17. Note: The MENU and PROFILE front panel pushbuttons have built-in LEDs that light to indicate they have been selected.

VM3909H Rear View

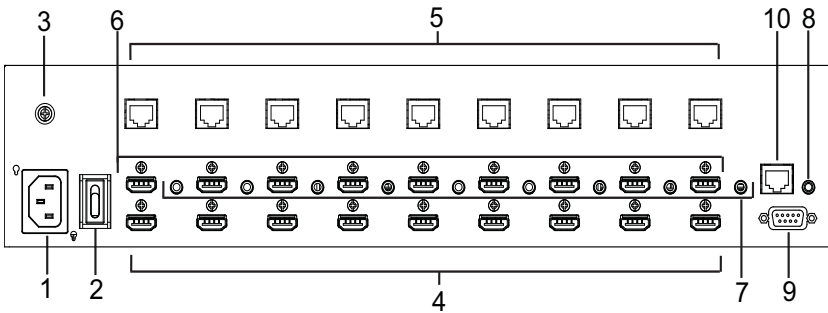

No.	Component	Description
1	Power Socket	This is a standard 3-pin AC power socket. The power cord from an AC source plugs in here.
2	Power Switch	This is a standard rocker switch that powers the unit on and off.
3	Grounding Terminal	The grounding wire attaches here. See <i>Grounding</i> , page 13, for further details.
4	HDMI Input Ports	The cables from your HDMI source devices plug into these ports.
5	HDBaseT Output Ports	The cables from your remote HDBaseT display devices or HDBaseT receivers plug into these ports.
6	HDMI Output Ports	The cables from your local HDMI display devices plug into these ports.
7	IR Channel Ports	Connect IR receivers / transmitters into the IR Channel ports for controlling the source and the display from local or remote locations.
8	IR Port	Connect an IR unit via the 3.5 mm Mini Stereo Jacks. IR signals are used to control the VM3909H.
9	RS-232 Serial Port	Connect a computer or high-end system controller via this serial port.
10	Ethernet Port	In order to access the VM3909H's Browser Graphical User Interface (GUI), the VM3909H must be connected to your network. The cable that connects the VM3909H to your LAN plugs in here. See <i>Cable Connection</i> , page 14, for further details

Chapter 2

Hardware Setup



1. Important safety information regarding the placement of this device is provided on page 93. Please review it before proceeding.
2. Make sure that the power to all devices connected to the installation are turned off. You must unplug the power cords of any computers that have the Keyboard Power On function.

Rack Mounting

The VM3404H / VM3909H can be mounted in a 19" (1U) system rack. For the most convenient front panel pushbutton configuration and operation at the local site, mount the unit at the front of the rack, as follows:

1. Use the M3 x 8 Phillips head hex screws supplied with the Mounting Kit to screw the rack mounting brackets onto the front and back of the unit.

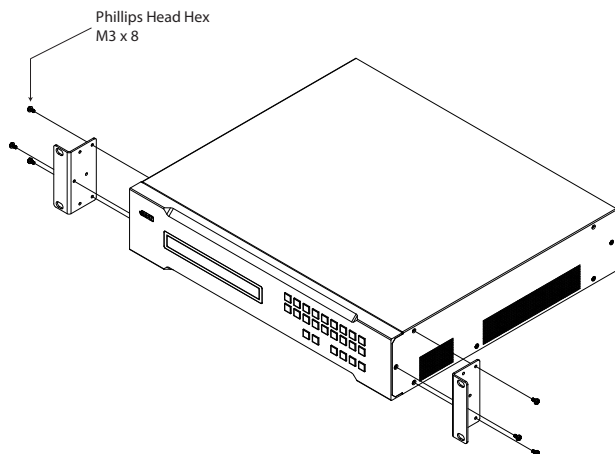

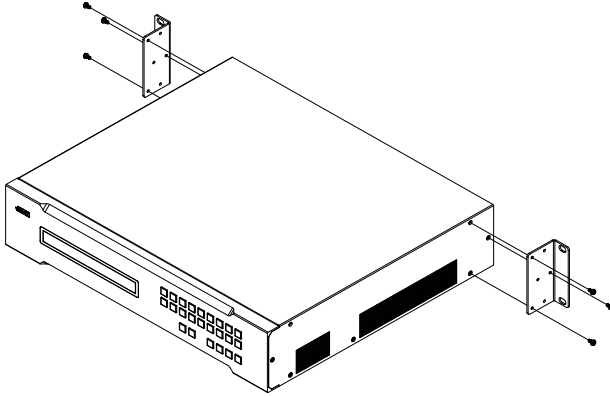

2. Position the unit in the front of the rack and align the holes in the mounting brackets with the holes in the rack.
3. Screw the mounting brackets to the rack.

Grounding

To prevent damage to your installation, it is important that all devices are properly grounded.

1. Use a grounding wire to ground the VM3404H / VM3909H by connecting one end of the wire to the grounding terminal, and the other end of the wire to a suitable grounded object.

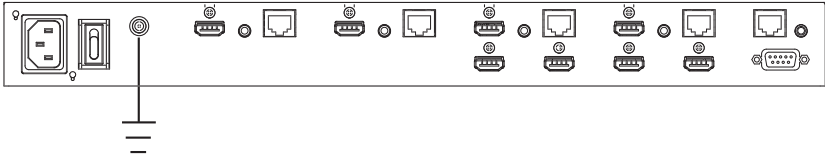

2. Make sure that all devices in your VM3404H / VM3909H installation are properly grounded.

Cable Connection

Installation of the VM3404H / VM3909H is simply a matter of connecting the appropriate cables. Refer to the installation diagram on the following page (the numbers in the diagram correspond to the steps below), and do the following:

1. Use a grounding wire to ground the unit by connecting one end of the wire to the grounding terminal, and the other end of the wire to a suitable grounded object.

Note: Do not omit this step. Proper grounding helps to prevent damage to the unit from surges or static electricity.

2. Connect up to 4 (VM3404H) or 9 (VM3909H) HDMI video sources to the **HDMI Input** ports
3. You can choose either of these two methods to transmit signals over a distance.
 1. Connect up to 4 (VM3404H) or 9 (VM3909H) HDBaseT display devices directly to the **HDBaseT Output** ports using a RJ-45 cable.
 2. Connect up to 4 (VM3404H) or 9 (VM3909H) HDMI display devices via an HDBaseT receiver. (Connect the VM3404H / VM3909H to the HDBaseT receiver using an RJ-45 cable. Then connect the receiver to the HDMI display device using an HDMI cable.)
4. (Optional) Connect up to 4 (VM3404H) or 9 (VM3909H) local HDMI display devices to the **HDMI Output** ports.
5. Connect IR receivers / transmitters to the **IR Channel** ports for controlling source and display devices from local or remote locations.
6. (Optional) If using the Browser Operation features (see *Browser Operation*, page 35), plug a Cat 5e cable from the LAN into the VM3404H / VM3909H's **Ethernet** port.
7. (Optional) If you are using the serial control function, use an appropriate RS-232 serial cable to connect the computer or serial controller to the VM3404H / VM3909H's female **RS-232 Serial** port.
8. Plug the power cord / supplied with the package into the VM3404H / VM3909H's 3-prong AC socket, and then into an AC power source.
9. Connect an IR Receiver to the **IR** port for controlling the VM3404H / VM3909H.
10. Power on the VM3404H / VM3909H and all devices in the installation.

Installation Diagram

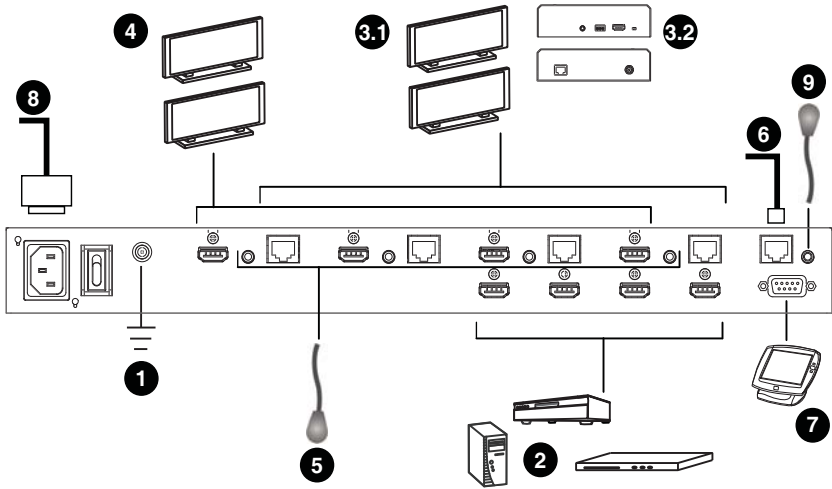

This Page Intentionally Left Blank

Chapter 3

Front Panel Configuration

Overview

The VM3404H / VM3909H can be configured and operated locally via the front panel LCD/pushbuttons and IR Remote Control; remotely over a standard TCP/IP connection via graphical user interface (GUI) using a web browser; via a remote terminal session using Telnet; or by a RS-232 serial controller.

The local front panel operation is discussed in this chapter. Web GUI Operation is discussed in Chapter 4, and RS-232 serial control is discussed in Chapter 5.

Front Panel Pushbuttons

The front panel features an LCD display and pushbuttons for convenient operation locally. This allows users to perform operations such as selecting which source shows on which display, viewing the IP settings, configuring the serial port, setting the EDID Mode / CEC / OSD /Output Status, selecting security settings, and loading/saving profiles.

Note the following front panel pushbutton functions:

- ◆ Use the **MENU** pushbutton to access the Menu page options: IP Setting, Serial Port Setting, Operation Mode, Security Mode, and Save to a Profile (see *LCD Menu Organization*, page 23).
- ◆ Use the **PROFILE** pushbutton to switch between the connection profiles which have been added to the Profile List (see *Profile List*, page 37). Pressing this pushbutton for longer than 3 seconds displays the Save to a Profile page (see *Save to a Profile*, page 32).
- ◆ Use the **CANCEL** pushbutton to go back to a previous page, return to the Main Screen, stop or exit an operation.
- ◆ Use the **ENTER** pushbutton to select options and confirm operations.
- ◆ Use the **INPUT / OUTPUT (1–9)** or **(1-4)** pushbuttons to select the Input/Output port. These pushbuttons may also correspond to menu options, connection profiles, and so on.
- ◆ Use pushbuttons **Prev / Next** to navigate the VM3404H / VM3909H menus.

Enter Password

Upon VM3404H / VM3909H startup, check the front panel LCD to view the loading progress. If the Password screen / LCD Menu fails to load, an error message displays. Reset the unit and try again.

If you are accessing the VM3404H / VM3909H for the first time, the Password screen appears as soon as the LCD loading process is done. Enter the default password 1234 to continue to the Main Screen (see *Main Screen*, page 19).



Additionally, the Password Screen appears if the VM3404H / VM3909H has been configured to require a password for Front Panel operation (see *Security Mode*, page 30).

To enter a password, do the following:

1. In the **Enter Password** field, check that the cursor is at the first asterisk (*) and flashing.
2. Use the front panel Input Port pushbuttons (1–9) or (1–4) to enter the 4-digit password. After the fourth digit has been entered correctly, the Main Screen displays.
3. Press **Cancel** to clear the password. The digits revert to 4 asterisks and the cursor goes back to the first asterisk.

-
- Note:**
1. The VM3404H / VM3909H password can be any four digit combination between 1111 to 9999 (VM3909H) or 1111 to 4444 (VM3404H). The default password is 1234.
 2. If you enter an incorrect password, the cursor goes back to the first digit and reverts to flashing. The Incorrect Password message displays at the bottom of the screen, but clears as soon as a new password is entered.
 3. If Password option is Enabled (see *Security Mode*, page 30), the LCD display time-out is 5 minutes by default.
-

Main Screen

The Main Screen shows the Input ports in the top row, which are tied to the Output ports shown in sequential order (1–9) or (1–4) at the bottom row.



- ◆ The front panel pushbutton label (1–9) or (1–4) corresponds to the **Input** ports and **Output** ports on the unit’s rear panel.
- ◆ Use the **Menu** pushbutton to view the LCD Menu (see *LCD Menu Organization*, page 23).
- ◆ Use the **Profile** pushbutton to switch between profile connections (see *Profile List*, page 37).

Port Switching

From the Main Screen, users can configure the Input-to-Output port connections to associate an Input source device to an Output display.

Input Port Selection

Use the Input Port pushbuttons to select the Input port you want to configure.



To select which input source displays on each output port, do the following:

1. Press any Input port pushbutton (1–9) or (1–4). The Output port LED(s) tied to the said Input port light(s) up (steady).

In the example below, pressing Input port **1** shows it is tied to Output ports **1** and **2**.



(Continues on next page.)

(Continued from previous page.)

2. To disconnect an Output port from an Input port, press the corresponding Output port pushbutton.

In the example below, Output port **2** has been disconnected from Input port **1**.



3. To switch to another Input port, press any Input port pushbutton. The Output port LED(s) tied to the said Input port light(s) up (steady).

In the example below, pressing Input port **2** shows it is tied to Output ports **3** and **4**.



4. To connect Output port **2** to Input port **2**, press the Output port **2** pushbutton. The Output port 2 LED flashes (0.5 sec on, 0.2 sec off). As a result, Input port **2** is now connected to Output ports **2**, **3** and **4**.



Once the signal from the selected Input port is successfully tied to the Output port, the LEDs turn off and the LCD information is updated.

Note: 1. Pressing an Input port a second time deselects it.

2. Input ports that are not configured or tied to any output port shows **NA** in the LCD screen.
 3. Pressing the **Cancel** pushbutton once stops the Input Port Selection operation, and the LCD displays the active setting. Pressing the **Cancel** pushbutton again turns all LEDs off.
 4. After 10 seconds of inactivity, all the LEDs turn off.
-

Output Port Selection

Use the Output Port pushbuttons to select the Output port you want to configure.



To select which output display corresponds to each input source device, do the following:

1. Press any Output port pushbutton (1–9) or (1–4).

In the example below, Output port **1** pushbutton has been pressed. It is not tied to any Input port.



2. If an Output port pushbutton is pressed a second time, it is deselected and the LED turns off.
3. To connect the selected Output port(s) to an Input port, press the Input port pushbutton to which you want the Output port(s) tied. The newly selected Input port LED flashes (0.5 sec on, 0.2 sec off), and the LCD information is updated.

In the example below, pressing Input port **2** ties it to Output ports **2, 3** and **4**.



4. To switch Output ports **2**, **3** and **4** to another Input port (and disconnect it from Input port **2**), press another Input port pushbutton to which you want it tied.

In the example below, Input port **3** has been pressed and is now connected to Output ports **2**, **3** and **4**.



-
- Note:**
1. Pressing an Output port a second time deselects it.
 2. Pressing the **Cancel** pushbutton once stops the Output Port Selection operation, and the LCD displays the active setting. Pressing the **Cancel** pushbutton again turns all LEDs off.
 3. After 10 seconds of inactivity, all the LEDs turn off.
-

LCD Menu Organization

The VM3404H / VM3909H has a built-in configuration utility via the front panel LCD, which can be controlled by pressing the **MENU** and front panel Input pushbuttons (1–9) or (1–4). User can cycle through the menu options, starting from IP Setting page, in the order shown in the table below:

Menu Page	Sub-Menu Page(s)	
IP Setting	IP Address	
	Subnet Mask	
	Gateway	
Serial Port Setting	Baud Rate	9600 / 19200 / 38400 / 115200
Operation Mode	EDID	Default / Port1 / Remix / Customized
	CEC	On / NA
	OSD	On / NA
	Output Status	On / NA
Security Mode	Password	Enable / Disable
	Change Password	Old Password New Password
Save to a Profile	Save to a Profile No.	01–08 (VM3404H); 01-18 (VM3909H)
Play/Stop the Profile Schedule		

Note: The highlighted values are the default settings of the VM3404H / VM3909H.

Menu Pushbutton

Press the **MENU** pushbutton to switch between the Main Screen and LCD Menu page. When the Menu is active, the MENU pushbutton's built-in LED lights up:

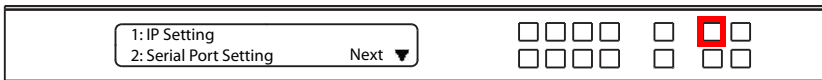

From the Menu page:

- ◆ Press **1** to go to the IP Setting page (see *IP Setting*, page 24)
- ◆ Press **2** to go to the Serial Port Setting page (see *Serial Port Setting*, page 25)

- ◆ Press **Next** to go to the next page(s) for the sub-menu pages
- ◆ Press **Menu** or **Cancel** to return to the Main Screen

IP Setting

The IP Setting page displays the VM3404H / VM3909H's IP configuration. The values in the LCD Menu are read-only and can be edited via the Browser GUI (*Network*, page 62).

IP Address / Subnet Mask

To view the VM3404H / VM3909H's IP address and Subnet Mask, do the following:

1. From the Menu page, press **1** to see the IP Setting submenu. The IP address and Subnet Mask are then shown.



Note: The VM3404H / VM3909H default IP address is 192.168.0.60. The default Subnet Mask is 255.255.255.0

2. Press **Next** to go to the next page.
3. Press **Menu** to return to the Menu page.
4. Press **Cancel** to return to the previous page without saving.

Gateway

To view the VM3404H / VM3909H's gateway address, do the following:

1. From the Menu page, press **1** to see the IP Setting submenu, then press **Next** to get to the next page. The gateway address displays.



Note: The default Gateway is 192.168.0.1.

2. Press **Prev** to go to the previous page.
3. Press **Menu** to return to the Menu page.
4. Press **Cancel** to return to the previous page without saving.

Serial Port Setting

To configure the VM3404H / VM3909H's baud rate for its serial port connection, select Serial Port Setting from the Menu page.



Baud Rate

To set the VM3404H / VM3909H's baud rate, do the following:

1. Select **Baud Rate Setting** from the Serial Port Setting submenu by pressing **1**:



2. Press pushbuttons 1–4 to make your selection.

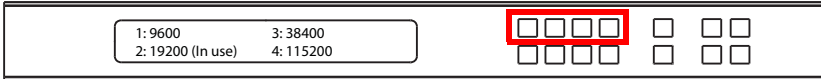

Baud Rate options are:

- ◆ 1: 9600
- ◆ 2: 19200
- ◆ 3: 38400
- ◆ 4: 115200

Note: The default baud rate is 19200.

3. Press **Menu** to return to the Menu page.
4. Press **Cancel** to return to the previous step without saving.

Operation Mode

The EDID Mode, CEC, OSD and Output Status features can be configured from the Operation Mode page.

- ◆ EDID (Extended Display Identification Data) is used to have the VM3404H / VM3909H automatically apply a preset video configuration or EDID Mode, which utilizes the best resolution across different monitors
- ◆ Consumer Electronics Control (CEC) allows interconnected HDMI devices to communicate and respond to one remote control
- ◆ The OSD, when enabled for a port, lets an attached display/monitor show real-time port switching information
- ◆ The Output Status shows whether the video/audio of an Output port is turned on or off

To configure the VM3404H / VM3909H's operation mode settings from the Main Screen, use the **Menu** pushbutton to access the Menu page, press **Next** to navigate to the next page, then press pushbutton **1** to access the Operation Mode page.

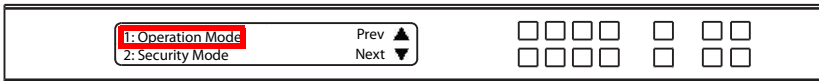

EDID Mode

To configure the EDID Mode, do the following:

1. From the Operation Mode page, press pushbutton **1**:



(Continues on next page.)

- Press pushbuttons 1–4 to make your selection.



EDID Mode options are:

EDID Option	Description
1: Port1	The EDID from port1 is passed to all video sources.
2: Default	The default EDID is passed to all video sources.
3: Remix	Uses the EDID of each connected display according to its connection when the VM3404H / VM3909H is first powered on, or immediately after pressing 3 to select the Remix option.
4: Customized	Automatically retrieves and saves the EDID settings of a connected monitor/display device to an input source port. This can be configured using the Browser GUI. See <i>Customized EDID Settings</i> , page 67.

- Press **Menu** to return to the Menu page.
- Press **Cancel** to return to the previous step without saving.

CEC

To configure the CEC setting, do the following:

- From the Operation Mode page, press pushbutton **2**:



- Press pushbuttons (1–9) or (1–4) to enable (**ON**) or disable (**NA**) the CEC feature for the output port. If the port does not support CEC, an **NA** is shown.



Note: The default CEC setting is NA.

- Press **Menu** to return to the Menu page.
- Press **Cancel** to return to the previous step without saving.

OSD

The On-Screen Display or OSD feature enables real-time text updates to appear on the display device's screen for any configuration changes made to the Output port via the VM3404H / VM3909H's front panel, IR remote control or Browser GUI.

To configure the OSD setting for each output port, do the following:

1. From the Operation Mode page, press **Next** to go to the next page, then press pushbutton **1**:



2. Press pushbuttons (1–9) or (1–4) to enable (**ON**) or disable (**NA**) the OSD feature for the output port.



Note: The default OSD setting is On.

3. Press **Menu** to return to the Menu page.
4. Press **Cancel** to return to the previous step without saving.

Output Status

To configure the Output Status settings for each output port, do the following:

1. From the Operation Mode page, press **Next** to go to the next page, then press pushbutton **2**:



2. Press pushbuttons (1–9) or (1–4) to enable (**ON**) or disable (**NA**) the video/audio of the output port.



Note: The default Output Status setting is On.

3. Press **Menu** to return to the Menu page.
4. Press **Cancel** to return to the previous step without saving.

Security Mode

The Security Mode page allows users to manage the VM3404H / VM3909H's password-related settings; the **Password** page configures the VM3404H / VM3909H to require a password for local operation after the LCD display times out or is powered off/on; the **Change Password** option allows users to set a new password for the VM3404H / VM3909H.

To configure the VM3404H / VM3909H's password settings from the Main Screen, use the **Menu** pushbutton to access the Menu page, press **Next** to navigate to the next pages, then press pushbutton **2** to access the Security Mode page.



Password

1. To set the VM3404H / VM3909H to require a password for local operation, press pushbutton **1**.



2. To require a password after the LCD display times out or is powered off/on, press pushbutton **1**. Otherwise, press pushbutton **2**.



Note: If Password is Enabled, the LCD display's default time-out is 5 minutes.

3. Press **Menu** to return to the Menu page.
4. Press **Cancel** to return to the previous step without saving.

Change Password

1. To change the password for accessing the unit, press pushbutton **2**.

2. In the Old Password field, the cursor flashes at the first digit. Enter the old password (see *Enter Password*, page 18). If the old password is entered correctly, you can proceed to the next step.

Note: If you entered an incorrect password, an error message appears and the cursor goes back to the first digit (flashing). The Incorrect Password message clears as soon as a new digit is entered.

3. In the New Password field, the cursor flashes at the first digit. Enter the new password using the front panel number pushbuttons VM3909H: (1111–9999) or VM3404H: (1111–4444).

4. Re-enter the new password in the following screen. The new password is applied by the VM3404H / VM3909H immediately.

If the password you entered does not match the one entered in the previous screen, an error message appears. Enter the new password correctly.

5. Press **Menu** to return to the Menu page.
6. Press **Cancel** to return to the previous step without saving.

Save to a Profile

The switch allows users to store up to 8 (VM3404H) or 18 (VM3909H) (numbered P1–P18) different connection profiles that can be saved and recalled later.

The active Input-to-Output port connections on the LCD Main Screen is the configuration saved to a profile. When a user loads a profile, the change is immediate and the profile number is shown on the lower right corner of the LCD screen.

To save a profile once the desired port connections are set, do the following:

1. Press the **Menu** pushbutton to access the Menu page, then **Next** to navigate to the next pages. Press pushbutton **1** to open the select Save to a Profile page.



2. On the page that opens, you are asked to give the profile a number. Use the front panel number pushbuttons to select a profile number into which you want to save the configuration.



VM3404H: Options are P1–P8 (when saving a profile via the LCD), where:

- ◆ Input port pushbuttons **1–4** correspond to Profile **P1** to **P4**
- ◆ Output port pushbuttons **1–4** correspond to Profile **P5** to **P8**

VM3909H: Options are P1–P18 (when saving a profile via the LCD), where:

- ◆ Input port pushbuttons **1–9** correspond to Profile **P1** to **P9**
- ◆ Output port pushbuttons **10–18** correspond to Profile **P10** to **P18**

3. Press **Enter** to store the configuration – the LCD shows Profile Saved.
4. Press **Menu** to return to the Menu page,
5. Press **Cancel** to return to the previous step without saving.

Note: Access the Save to a Profile page quickly by pressing the **Profile** pushbutton for longer than 3 seconds.

Play/Stop the Profile Schedule

Inputting port pushbutton **2** will Play or Stop the active Profile Schedule.



Profile Pushbutton

The **PROFILE** pushbutton lets users conveniently switch between connection profiles that have been saved or added to the Profile List (see *Profile List*, page 37).

When a Profile is in use, its profile number (P1–P18) is shown on the lower right corner of the LCD display.

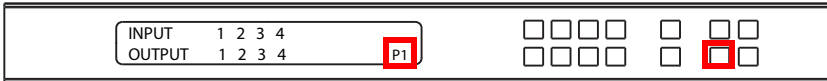

The Profile pushbutton functions as follows:

- ◆ Press the Profile pushbutton for 1–2 seconds to cycle between profiles stored in the GUI’s Profile List (from 1 up to 18) or (from 1 up to 8) depending on how many are added to the list.
- ◆ Alternatively, after pressing the Profile pushbutton (lights), use the Input/Output pushbuttons to switch to a specific profile (P1 to P18) or (P1 to P8). Note that:
 - ◆ **Input** ports 1–9 or 1-4 correspond to Profile **P1** to **P9** or **P1** to **P4**
 - ◆ **Output** ports 1–9 or 1-4 correspond to Profile **P10** to **P18** or **P5** to **P8** (where Output Port 1=Profile 9, Output Port 2=Profile 10... Output Port 9=Profile 18)

The selected pushbutton lights steady, and the VM3404H / VM3909H immediately applies the port connections configured in the selected profile.

- ◆ When the Profile pushbutton is pressed for 3 seconds or more, the LCD directs to the Save to a Profile page (see *Save to a Profile*, page 32)
- ◆ Press the **Cancel** pushbutton to exit

Note: If there are no profiles configured on the VM3404H / VM3909H device, an error message “*No Profile List defined. Profile List can be edited via the Web GUI*” is displayed when the Profile pushbutton is pressed.

A Profile’s port connections can be edited using the front panel pushbuttons (see *Port Switching*, page 19) or from the *Connections* page of the Browser GUI (see *Connection Profiles*, page 43). Additionally, the Profile List can be configured via the Profile page of the Browser GUI (see *Profile List*, page 37).

Chapter 4

Browser Operation

Overview

The VM3404H / VM3909H can be configured over a standard TCP/IP connection via its built-in Graphical User Interface (GUI). Because it can be accessed from anywhere over a network or the Internet, operators can easily log in via web browser. Security is ensured by password protection and user-configurable time-out. The VM3404H / VM3909H supports three levels of remote users with various privileges, and up to 32 users can log into the GUI at one time. For full details, see the sections that follow.

Logging In

To access the GUI, type the VM3404H / VM3909H's IP address into the address bar of any browser. If a Security Alert dialog box appears, accept the certificate – it can be trusted. The login screen appears:

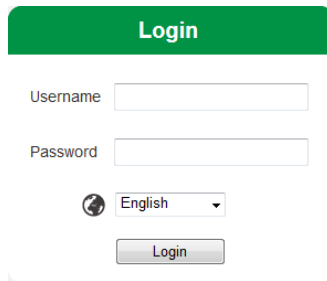

The login screen features a green header with the text "Login". Below the header, there are two input fields: "Username" and "Password". Below the "Password" field, there is a language selection dropdown menu with a globe icon and the text "English". At the bottom of the form, there is a "Login" button.

- ◆ The default IP address is **http://192.168.0.60**
- ◆ The default Username and Password are: **administrator / password**
- ◆ Enter the username and password, then click **Login**.
- ◆ The same user can not be logged in simultaneously.
- ◆ Use the drop-down menu to select the GUI language
 - ◆ English, French, German, Italian, Japanese, Korean, Portuguese, Russian, Spanish, Simplified Chinese and Traditional Chinese

Note: The username supports lower case letters only.

Main Page

The Main Page opens to the **Profile List**. This is where you configure the input to output connections by creating profiles. The page is divided into three parts: the *Menu Bar*, *Profile List*, and *Profile Scheduling*.

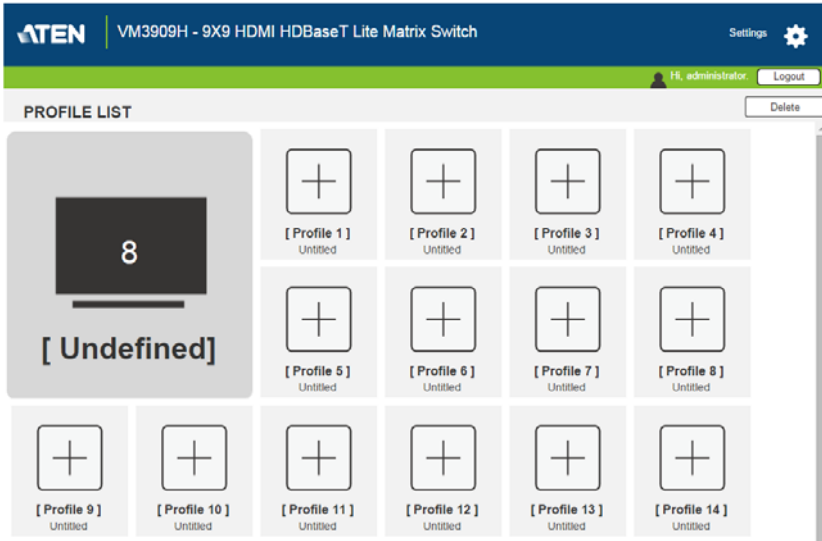

Menu Bar

The Menu Bar consists of the *Settings* icon and *Logout* button.

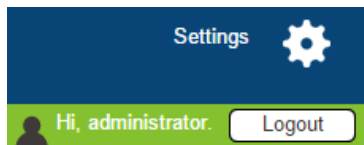

- ◆ Click **Settings** to enter the System Settings (see page 54).
- ◆ Click the **Logout** button to log out of the GUI.

Profile List

The *Profile List* lets you configure the input to output port connections by creating profiles to use. You can store up to 8 (VM3404H) or 18 (VM3909H) differently configured profiles that can be saved and played by two methods: locally via the unit's front panel pushbuttons and via the web GUI.

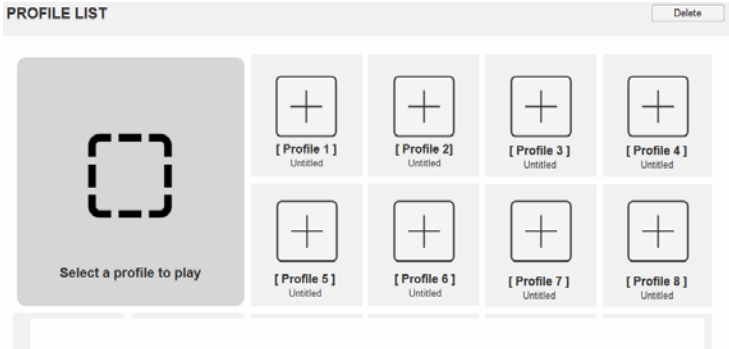

Adding/Playing a Profile

To configure a connection profile:

1. From the Profile List, click a **[Profile]**.
2. Select the profile type:



Digital Signage

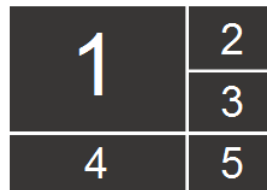

Video Wall

Digital Signage: Select this option for video that is displayed independently on separate monitors (page 43).

Video Wall: Select this option for monitors that are displayed together - tiled or as a large screen (page 46).

3. Configure the input to output connections for a Digital Signage (**page 43**) or Video Wall (**page 46**) profile.

4. New profiles appear in the *Profile List*, as shown here:

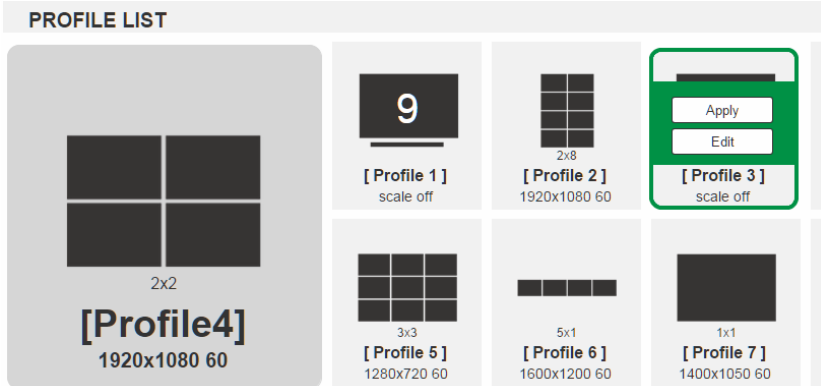

5. Select the profile and click **Apply**.

6. The profile appears in the large **Play** window and the connections start:

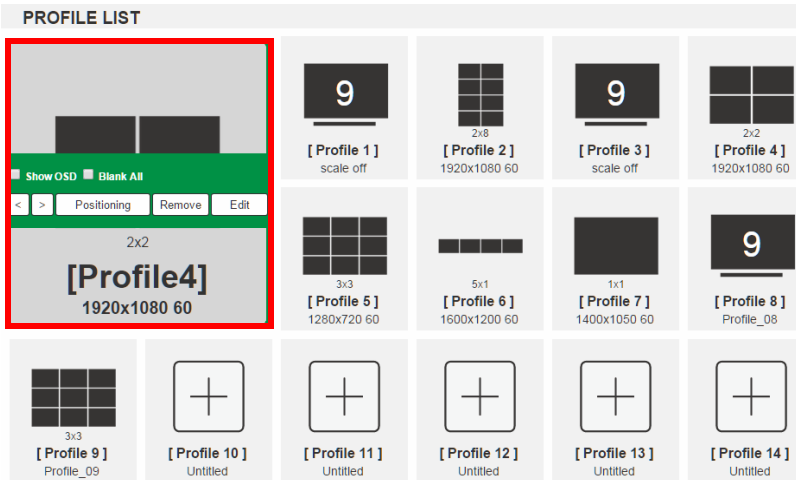

Note: More information about Profile List options are provided on the next page.

Profile List Options

Clicking a *Profile* or the *Play* window opens a pop-up menu with options.

Profile

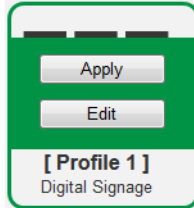

Option	Description
Apply	Click Apply to put the profile in the Play window. This allows you to start the profile connections.
Edit	Click Edit to configure the profile's input to output connections.

Play Window

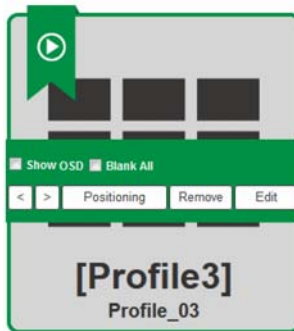





Option	Description
Show OSD	Check Show OSD to show current connection information that appears on the display.
Blank All	Check Blank All to turn off the video to all displays.
<	Click < to go back to the previous profile in the sequence, when Profile Scheduling is in use. Only available with <i>On Sequence</i> .
>	Click > to advance to the next profile in the sequence, when Profile Scheduling is in use. Only available with <i>On Sequence</i> .

Option	Description
Positioning	Click Positioning to open a window that allows you to adjust the image position on each display. For Video Wall profiles, you can also set the Bezel Dimension, which is the frame thickness between each display.
Remove	Removes the profile from the Play window.
Edit	Click Edit to configure the profile's input to output connections.

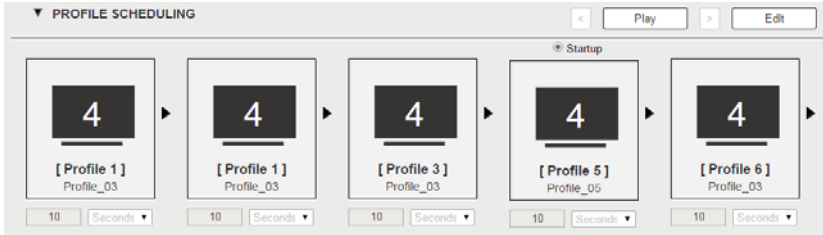
Profile Scheduling



Profile Scheduling is located below the Profile List. Scheduling allows you to queue and play connection profiles in sequence for a specific amount of time.

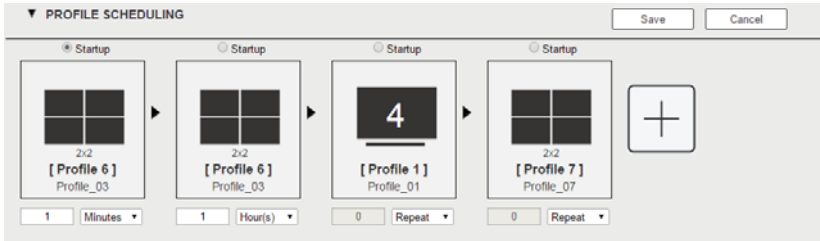

Option	Description
	Click to edit profile schedule.
	Click to play profile schedule.
	Click to stop profile schedule.
	Click to change to next or previous profile.

After selecting **Edit**, you will be presented with the following options.

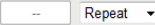

Option	Description
	<p>Click to add profiles to the schedule in the order to be played, left to right, then set the amount of time each profile plays.</p>
	<p>Click a profile for a pop-up menu to appear:</p> <ul style="list-style-type: none"> ◆ Select Startup to use the profile as the starting point for the schedule. ◆ Click Replace to replace the selected profile with another profile. ◆ Click Remove to delete the profile from the schedule. ◆ Use < > to change the profile's position in the schedule.
	<p>Use the drop-down menu to select the duration (Hours, Minutes, or Seconds) and enter the amount of time for the profile to play. After the time expires, the schedule switches to the next profile.</p> <p>Use Repeat to stop switching between schedules and stay on the currently selected profile. If Repeat isn't used, the schedule will loop back to the first profile. If Repeat is used, a specific number of hours, minutes and seconds cannot be set and later profiles will not be played.</p>
<p>Save</p>	<p>Click Save to save the schedule as it appears. After saving, the Profile Scheduling window will close.</p> <p>When a Profile Schedule is playing the <i>On Sequence</i> box will appear in the Play window.</p>
<p>Cancel</p>	<p>Click Cancel to discard changes and return to the Profile Schedule page.</p>

Connection Profiles

There are two types of profiles: *Digital Signage* and *Video Wall*. **Digital Signage** profiles are for displays where video is viewed on separate monitors. **Video Wall** profiles are for displays that are tiled together, where multiple monitors form one large screen – in various arrangements.

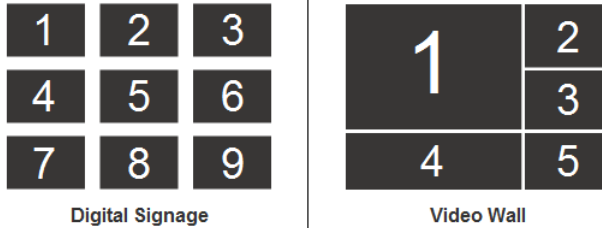

Digital Signage Profile

Each icon represents an output port and the connected display. The large number is the **Input** port selected for the display. The small number (upper-left corner) is the **Output** port for the display. Click the icons to select options.

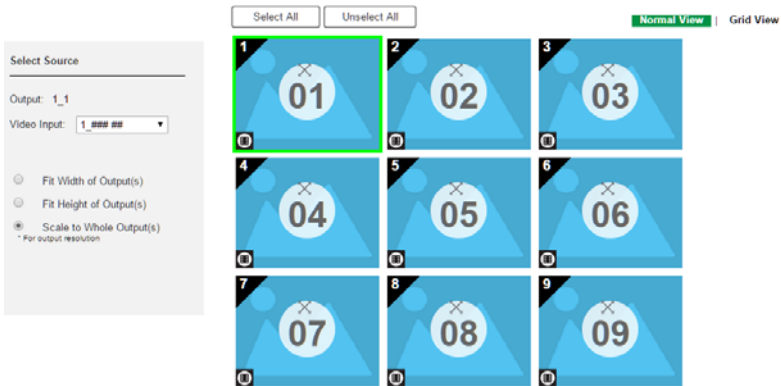

- ◆ Select icons to choose the **Video Input** from the *Select Source* menu.
- ◆ Click the PEN icon or name to edit the profile name.
- ◆ Click **Select All** to select all outputs.
- ◆ Click **Unselect All** to unselect all outputs.
- ◆ Click **Save** to save the profile or **Save as** to save as a different profile number.

- ◆ Click *Grid View* to use an alternate method for configuring connection profiles (see page 45).

Output Icon



Option	Description
Output Icon	Click an Output icon(s) to highlight it in green and use the <i>Select Source</i> menu to set the video options (see <i>Select Source</i> below). The large number is the Video Input port selected for the display. The small number (upper-left corner) is the Output port of the display.
Video	Click the video icon to turn the video off/on.

Select Source

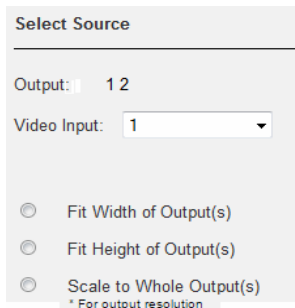

Option	Description
Select Source	The Select Source menu appears when you click an Output icon.
Output	Displays the Outputs that are selected for the configuration change.
Video Input	Use the drop-down menu to select the Video Input . Click Save or Save as to save the changes.

Option	Description
Radio Button	<ul style="list-style-type: none"> ◆ Fit Width of Output(s): fits the video to the width of the display. ◆ Fit Height of Output(s): fits the video to the height of the display. ◆ Scale to Whole Output(s): fits the video on the entire display.

Grid View

The Grid View allows you to select the **Input** to **Output** connections using a simple grid.

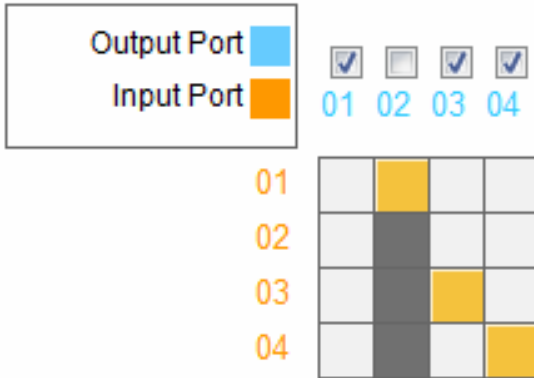

- ◆ From an *Output Port* column, click a box to select its **Input Port**. The box will turn orange.
- ◆ **Uncheck** an *Output Port* box to disable the video for that Output Port. The column will turn dark grey.
- ◆ **Check** an *Output Port* box to enable the video for that Output Port.
- ◆ Click **Save** to save the profile. Click **Save as** to save as a different profile number.

Output Options

For instructions on the *Output Options*, see *Output Options*, page 52.

Video Wall Profile

Each blank icon represents an Output port and the connected display. Use the icons to create Independent and Grouped Outputs. **Independent** Outputs will display video on a single monitor. **Grouped** Outputs will display video across multiple monitors as one large screen.

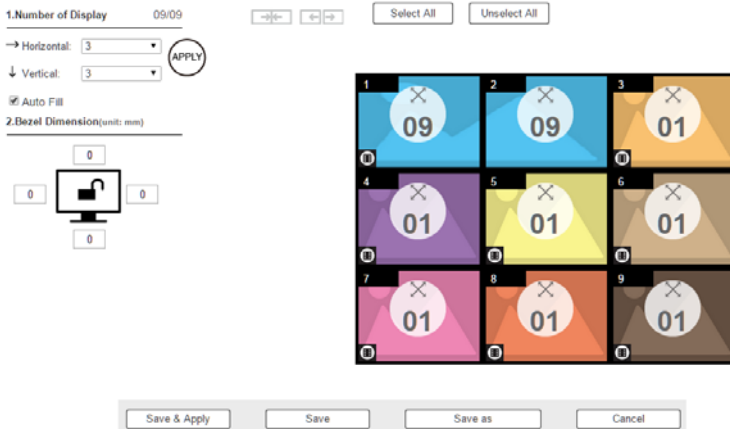

Video Wall Options

- ◆ Click an icon to choose its **Output** and **Video Input** from the *Display Preference* menu (see page 48).
- ◆ Click multiple icons to Group Outputs (see *Grouping*, page 49) and choose the **Video Input** from the *Display Preference* menu.
- ◆ Use + next to **Display Layout _1** to create additional layouts under the same profile.
- ◆ Click the PEN icon or name to edit the profile name.
- ◆ Click **Select All** to select all outputs.
- ◆ Click **Unselect All** to unselect all outputs.
- ◆ Click **Apply** to apply any changes made.
- ◆ Click **Save** to save the profile or **Save as** to save as a different profile number.
- ◆ Click **Save & Apply** to save the profile and apply any changes made to the current profile.
- ◆ Click **Cancel** to undo any changes made.

Number of Displays / Bezel Dimensions

1.Number of Display 09/09

→ Horizontal: APPLY

↓ Vertical:

Auto Fill

2.Bezel Dimension(unit: mm)

0

0

0



0

0

Option	Description
Number of Displays	Use the <i>Horizontal</i> and <i>Vertical</i> drop-down menu to select the number of displays that make up the video wall. Match this to the physical layout of the displays. Click Apply to set the layout.
Auto Fill	Click the <i>Auto Fill</i> checkbox and Apply to automatically incorporate all available outputs into the video wall.
Bezel Dimension	Use the four boxes to increase/decrease the frame size for each active display.
Monitor Lock / Unlock	Click the monitor icon to Lock the (4) bezel settings, so that when one size is changed they all change. Click the monitor icon to Unlock the (4) bezel settings, so that each size can be set independently.



Blank Output



Option	Description
Blank Icon	<p>Click Blank Output icons to highlight icons in green and use the Display Preferences menu to set the video options (see <i>Display Preferences</i>, page 50).</p> <p>Select a single icon to set the Output and Video Input for an independent display (see <i>Independent Output</i>, page 48).</p> <p>Select multiple icons and set the Video Input to group displays as one screen (see <i>Grouping</i>, page 49). <i>You must first set the Output port for each icon.</i></p>
Drop-down Menu	Use the drop-down menu to select the Output port.

Independent Output



Option	Description
Independent Output	<p>Independent Outputs are displays that have their own Video Input and Output selected. Independent Outputs:</p> <ul style="list-style-type: none"> ◆ Display their own video ◆ Icons have their own color and Video Input <p>Select an Independent Output and use the <i>Display Preferences</i> (page 50) menu select the Video Input.</p>
Drop-down Menu	Use the drop-down menu to select the Output port.
Video	Click the video icon to turn the video off/on.



Grouping



Option	Description
Grouping	Click multiple icons to Group Outputs (highlighted in green) and click → ← to group the displays into one screen*. Use the Display Preferences menu to select the Video Input for the group - each Output icon in the Group will appear with the same Video Input number and icon color (see <i>Group</i> , page 49). Note: Before grouping you must set the Output port for each icon.
Ungroup	Select a group and click ← → to ungroup the displays.

Group



Option	Description
Group	A Group (of Outputs) shares the same Video Input and displays the video together as one large screen. A Group of Outputs: <ul style="list-style-type: none"> ◆ Displays video across multiple monitors to form one screen ◆ Icons have the same color and Video Input number. ◆ Select a Group and use the <i>Display Preferences</i> menu to select the Video Input. ◆ To group outputs see <i>Grouping</i>, page 49.

Option	Description
Video 	Click the video icon to turn the video off/on.

Display Preferences

Display Preference

Output: ▼

Video Input: ▼

Fit Width of Output(s)
 Fit Height of Output(s)
 Scale to Whole Output(s)

Option	Description
Display Preferences	Click Output icons for the Display Preferences menu to appear– to select the Output and/or Video Input port.
Output	Use the drop-down menu to select the Output port (Independent and single Blank icons only). If you select multiple displays the output ports selected will appear here. You can use the output icon's drop-down menu to change the output port for the display.
Video Input	Use the drop-down menu to select the Video Input port.
Radio Button	<ul style="list-style-type: none"> ◆ Fit Width of Output(s): fits the video to the width of the display. ◆ Fit Height of Output(s): fits the video to the height of the display. ◆ Scale to Whole Output(s): fits the video on the entire display.

Video Wall Example

The example below shows a video wall with 4 displays.

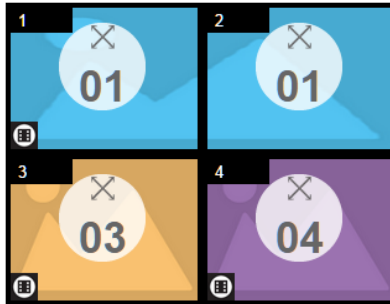

- ◆ Each Group and Independent Output has a unique color.
- ◆ This video wall has 1 **Group** and 2 **Independent** displays.
- ◆ The Group will show **Video Input 01** across both displays as one large screen.
- ◆ The Independent displays will show the video from their own **Video Input** – 03 and 04.
- ◆ Add Display Layouts to create separate video walls (see *Video Wall Options*, page 46).

Output Options

The *Output Options* page is used to configure video options.

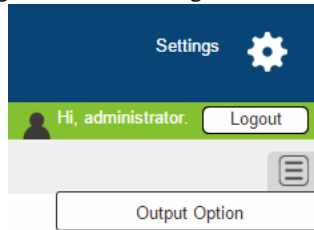

Video Options

Video Options allow you to set Seamless Switch options which determine how a display performs when the input port is changed.

Port	*Seamless Switch	Transition	Period	Scale Resolution
	Apply to All	Apply to All	Apply to All	Apply to All
Port1	<input checked="" type="checkbox"/> ON	<input type="checkbox"/> OFF	—	1920x1080@60HZ(720)
Port2	<input checked="" type="checkbox"/> ON	<input type="checkbox"/> OFF	—	1920x1080@60HZ(720)
Port3	<input checked="" type="checkbox"/> ON	<input type="checkbox"/> OFF	—	1920x1080@60HZ(720)
Port4	<input checked="" type="checkbox"/> ON	<input type="checkbox"/> OFF	—	1920x1080@60HZ(720)

*The Seamless Switch function cannot be turned off from the video wall editor.

- ◆ The *Transition*, *Period* and *Scale Resolution* apply only when Seamless Switching is on.
- ◆ **Seamless Switch:** Turning *Seamless Switch* on removes the video distortion and delay seen when an input port is switched.
 - ◆ Use the drop-down menu to apply to all ports, or the ON/OFF button to enable/disable Seamless Switching per port.
- ◆ **Transition:** Allows you to fade the video display when the input port is changed. Use the period option to set the fade speed.
 - ◆ Use the drop-down menu to apply to all ports, or ON/OFF button to enable/disable Transitions per port.
- ◆ **Period:** Sets the fade speed for the Transition option.
 - ◆ Use the drop-down menu to apply an option (*Slow*, *Normal*, or *Fast*) to all ports, or lower drop-down menus to apply options per port.
- ◆ **Scale Resolution:** Forces the port to scale the video displayed to the selected resolution.

- ◆ Use the top drop-down menu to apply an option to all ports, or lower drop-down menus to apply options per port.
- ◆ Click **Save** to save the settings. Click **Save as** to save the settings as a different profile number.

System Settings

Click the *Settings* link from the Main page for the System Settings to open on the **General** page:

Temperature & Fan Status

43°C

Slot info

Slot	Model Name	F/W Version
Video Matrix	VM3909H	V1.0.171
Port1	N/A	N/A
Port2	N/A	N/A
Port3	N/A	N/A
Port4	N/A	N/A
Port5	N/A	N/A
Port6	N/A	N/A
Port7	N/A	N/A
Port8	N/A	N/A
Port9	N/A	N/A

OSD / CEC

Port	OSD	CEC
Port1	Apply to All	Apply to All
Port1	ON	ON
Port2	ON	ON
Port3	ON	ON
Port4	ON	ON
Port5	ON	ON
Port6	ON	ON
Port7	ON	ON
Port8	ON	ON
Port9	ON	ON

* The CEC setting is only for output boards, please make sure all devices have this capability.

Other

Language: English Baud Rate: 19200

Save Cancel

- ◆ The *General* page allows you to edit Baud, language, OSD and CEC settings, and Fan information.
- ◆ The *User Account* page allows you to add and edit user accounts.
- ◆ The *Port Name* page allows you to name each input and output port.

- ◆ The *Network* page allows configuration of the network settings.
- ◆ The *EDID* page is used to set the EDID modes.
- ◆ The *Firmware* page is for upgrading the device's firmware.
- ◆ The *HDCP* page is lets users view and set HDCP key settings.
- ◆ Click **Back to Profile List** to return to the Main page.

General

The *General* page has three sections: Fan Status, OSD/CEC and Other.



Fan Status

- ◆ This section displays the VM3404H / VM3909H's three fans' statuses.

Note: If the fans have stopped working or are switched off, they will appear as follows.

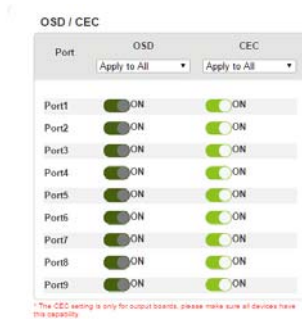

OSD / CEC

- ◆ **OSD:** Sets the default OSD option for the port. When OSD is on: real-time text updates appear on the display for 10 seconds when configuration and port changes are made to the output.
 - ◆ Use the drop-down menu to apply options to all ports, or ON/OFF button to enable/disable the OSD for a port.
- ◆ **CEC:** Consumer Electronics Control (CEC) allows interconnected HDMI devices to communicate and respond to one remote control.
 - ◆ Use the drop-down menu to apply options to all ports, or On/Off button to enable/disable CEC for a port.
- ◆ Click **Save** to save the settings or **Cancel** to exit without saving the settings.

Other

- ◆ Use the **Language** drop-down menu to select a preferred user interface language.

- ◆ Options include: English, French, German, Italian, Japanese, Korean, Portuguese, Russian, Spanish, Simplified Chinese and Traditional Chinese.
- ◆ Use the **Baud Rate** drop-down menu to select a serial port setting.
 - ◆ Options include: 9600, 19200, 38400 and 115200.

User Account

The *User Account* page lets you add, edit, or delete users and change the password for accessing the VM3404H / VM3909H's GUI.

Note: This is an Administrator only function.

User Name	Level	Description
administrator	Administrator	Default_User
user_1	Basic User	User_Account

+ Add account Edit

- ◆ **Add account**– Click the *Add account* button to add another user to the list. The VM3404H / VM3909H supports up to 32 users at one time (see page 58 for more details).
- ◆ **Edit** – Click the *Edit* button to change user information. This option allows an Administrator to edit individual accounts.

User Name	Level	Description	
Edit 111111	Administrator	111111	
Edit 12345	Administrator		
Edit administrator	Administrator	Default_user	

- ◆ **Edit** – Rename the user account, set the password, add a description, and set the user's permission level (see page 58 for more details).
- ◆ **Delete** – Removes the user account.



- ◆ The default username and password are: administrator/password.

Add Account

Use the Add Account / Edit User window to name a user, set the user's password, add a description, and set the user's permission level (see *Permission Level*, page 59) for accessing the VM3404H / VM3909H's GUI.

Username

Password

Confirm Password

Please enter 5-16 characters without *+/@=[:];'&<>?\ space

Description

Permission Level **Administrator** Connections, Open/Save Profiles, Manage users
 Advance User Connections, Open/Save Profiles
 Basic User Connections, Open Profiles

- ◆ Fill in a username or edit an existing one.
- ◆ Enter a password and re-type the password to confirm.

Note: Usernames and passwords accept multi-lingual characters, and must be 5–16 alphanumeric characters (excluding ;=[+="/?|\). Passwords are case sensitive. Usernames only support lower case letters.

- ◆ Add or edit the description for the user.
- ◆ Select the permission level that you want to grant the user (see *Permission Level*, page 59).
- ◆ Click **Create User** to save the data.
- ◆ Click **Cancel** to discard the changes and exit.
- ◆ If a user is logged into the VM3404H / VM3909H's GUI, their user settings cannot be edited, and the fields in this screen are grayed out.

Permission Level

At the bottom of the New/Edit User page is the permission section, which is used to set a user's permission level.

Username

Password

Confirm Password

Please enter 5-16 characters without "+@=|,.;'&<>?|\ space

Description

Permission Level

- Administrator** Connections, Open/Save Profiles, Manage users
- Advance User** Connections, Open/Save Profiles
- Basic User** Connections, Open Profiles

The three available permission levels are as follows:

- ◆ **Administrator** – this level provides full access and control of the VM3404H / VM3909H, in addition to full User Management privileges.
- ◆ **Advanced User** – this level provides full access and control with no User Management privileges.
- ◆ **Basic User** – this level only provides basic functions (connections and open profiles).

Port Name

The *Port Name* page lets you name the input and output ports for easy identification.

The screenshot displays two side-by-side panels for configuring ports. The left panel is titled 'Output Port' and the right panel is titled 'Input Port'. Both panels list ports from Port1 to Port9. Each port entry consists of a port number, a label, and a text input field. Below the panels are 'Save' and 'Cancel' buttons.

Port	Label	Value
Port1	01	1
Port2	02	###
Port3	03	Port_Out_3
Port4	04	Port_Out_4
Port5	05	Port_Out_5
Port6	06	Port_Out_6
Port7	07	Port_Out_7
Port8	08	#O #8
Port9	09	### #O

Port	Label	Value
Port1	01	###
Port2	02	Port_In_2
Port3	03	Port_In_3
Port4	04	Port_In_4
Port5	05	Port_In_5
Port6	06	Port_In_6
Port7	07	###
Port8	08	## #8
Port9	09	### #1

- ◆ To name an Input/Output port, enter a descriptive name of up to 16 multi-language characters (excluding ;:=[]+=/?\|) in the corresponding field and click **Save**.
- ◆ Language characters available include: English, French, German, Italian, Japanese, Korean, Portuguese, Russian, Spanish, Simplified Chinese and Traditional Chinese.
- ◆ To change an Input/Output port's name, enter another value and click **Save**.
- ◆ Input and Output port names can be the same.
- ◆ Press **Cancel** to go back a level, return to the initial screen, or exit.

Network

The *Network* page lets you configure the IP settings, website timeout, and Telnet settings for connecting to the VM3404H / VM3909H.

DHCP	<input checked="" type="radio"/> Enable <input type="radio"/> Disable
IP Address	<input type="text"/>
Subnet Mask	<input type="text"/>
Default Gateway	<input type="text"/>
Website Timeout	<input type="text" value="N/A"/> ▾
MAC Address	00:10:74:B3:00:06
Telnet	<input checked="" type="radio"/> Enable <input type="radio"/> Disable

Enable DHCP to allow the DHCP server to assign an IP address to the VM3404H / VM3909H. Select **Disable** to enter your own static IP address settings for the device.

Click **Cancel** to use the following default values:

- ◆ IP Address – 192.168.0.60
- ◆ Subnet Mask – 255.255.255.0
- ◆ Default Gateway – 192.168.0.1
- ◆ Website Timeout* – 5 minutes
- ◆ Telnet Enabled

Enter the values, then click **Save**. Changes may take a few seconds and after refreshing the page automatically redirects you to the IP address specified.

* This option controls how long an inactive web connection stays logged into the VM3404H / VM3909H. Use N/A to disable this option. Other options include 5, 10, 30 and 60 minutes. Any changes will take effect immediately.

EDID

The *EDID Settings* page lets users view and select an EDID Mode so that the VM3404H / VM3909H can use the best resolution for its display(s).

EDID Mode	EDID & CEA Description		
<input checked="" type="radio"/> ATEN Default <input type="radio"/> Port1 Mode <input type="radio"/> Remix <input type="radio"/> Customized <input type="button" value="Apply"/> Port EDID Status Port 1 Port1 Mode Port 2 Port1 Mode Port 3 Port1 Mode Port 4 Port1 Mode Port 5 Port1 Mode Port 6 Port1 Mode Port 7 Port1 Mode Port 8 Port1 Mode Port 9 Port1 Mode	EDID 1. Vendor/Product Identification 2. EDID Structure/Revision 3. Basic Display/Feature 4. Color Characteristics 5. Established Timings 6. Standard Timings 7. Detail Timing/Display Description 1 8. Detail Timing/Display Description 2 9. Monitor Description 10. Monitor Description CEA 1. Display Support 2. Video Data 3. Audio Data 4. Speaker Allocation 5. Vendor Specific Data 6. Detail Timing/Display Description 1 7. Detail Timing/Display Description 2	Model ID: 0x0001 Manufacturer ID: ATN Serial Number: 0x0000275B Manufacture Date: 2014 Week 23 Week of Manufacture: 23 Year of Manufacture: 2014	Tips ATEN Default Mode All ports' EDID are the same as the hardware default EDID. Port1 Mode All ports' EDID are the same as Port1 EDID. Remix All ports' EDID use the lowest resolution display. Customized Mode The EDID Wizard is only enabled if the EDID is in "Customized Mode".

Note: The EDID Mode can also be selected via the Front Panel pushbuttons – see *EDID Mode*, page 26.

Extended Display Identification Data (EDID) is a data format that contains a display's basic information and is used to communicate with the video source/system.

EDID Mode

In the left panel of the page, users can select a pre-configured EDID Mode using the **EDID Mode** radio buttons.

EDID Mode	EDID & CEA Description		Tips
<input checked="" type="radio"/> ATEN Default <input type="radio"/> Port1 Mode <input type="radio"/> Remix <input type="radio"/> Customized <input type="button" value="Apply"/>	EDID 1. Vendor/Product Identification 2. EDID Structure/Revision 3. Basic Display/Feature 4. Color Characteristics 5. Established Timings 6. Standard Timings 7. Detail Timing/Display Description 1 8. Detail Timing/Display Description 2 9. Monitor Description 10. Monitor Description	Model ID: 0x0001 Manufacturer ID: ATN Serial Number: 0x0000275B Manufacture Date: 2014 Week 23 Week of Manufacture: 23 Year of Manufacture: 2014	ATEN Defau All ports' EDI same as the default EDID Port1 Mode All ports' EDI same as Por
Port EDID Status Port 1 Port1 Mode Port 2 Port1 Mode Port 3 Port1 Mode Port 4 Port1 Mode Port 5 Port1 Mode Port 6 Port1 Mode Port 7 Port1 Mode Port 8 Port1 Mode Port 9 Port1 Mode	CEA 1. Display Support 2. Video Data 3. Audio Data 4. Speaker Allocation 5. Vendor Specific Data 6. Detail Timing/Display Description 1 7. Detail Timing/Display Description 2		Remix All ports' EDI lowest resok Customized The EDID W/ enabled if the "Customized

Select the EDID Mode to use and click **Apply**. The VM3404H / VM3909H uses the settings configured for that EDID mode.

Options are:

- ◆ **ATEN Default:** All ports' EDID are the same as the hardware default EDID.
- ◆ **Port 1 Mode:** All ports' EDID are the same as Port1's EDID.
- ◆ **Remix:** All ports' EDID use the best display resolution.
- ◆ **Customized:** See Customized Mode, see page 67.

Customized Mode

Use the *Customized* Mode to automatically retrieve and save the EDID settings of a connected monitor/display device to an input source port.

- ◆ In the left-most panel of the page, select **Customized** from the *EDID Mode* section and click **Apply**.
- ◆ **Port EDID Status:** Select which input source port you want to store the EDID configuration (01–08).
- ◆ **Retrieve EDID:** Click and a pop-up window appears to retrieve the EDID settings of a stored EDID configuration: *Customized EDID 01-08*, or *ATEN Default*. Select the port to retrieve:

Caution

Select a port to retrieve.

- ◆ The right panel displays a summary of the acquired EDID settings that you can edit. Click **Save** and select the configuration for the **Current** or **All Ports** for the duration of the session.

Save

Save changes to the current port or all ports?

EDID & CEA Description

The right panel of the screen lets users view the configuration of the *EDID* and *CEA* Modes selected:

The screenshot shows the 'EDID & CEA Description' configuration window. On the left, the 'EDID Mode' is set to 'Customized'. Under 'Port EDID Status', 'Port 1 Customized' is selected. The main area is divided into two columns: 'EDID' and 'CEA'. The 'EDID' column lists 10 items, with '1. Vendor/Product Identification' selected. The 'CEA' column lists 3 items: '1. Display Support', '2. Video Data', and '3. Audio Data'. The right panel displays the configuration for the selected EDID item: Model ID: 0x0001, Manufacturer ID: ATN, Serial Number: 0x00000000, Manufacture Date: 2014 Week 23, Week of Manufacture: 23, and Year of Manufacture: 2014. Buttons for 'Retrieve EDID' and 'Save' are visible at the top right.

- ◆ From the left column, click the option that you want to view and/or edit. There are two categories: **EDID** (Extended Display Identification Data) and **CEA** (Consumer Electronics Association).
- ◆ When you highlight the menu items on the left column, the right column displays the current settings for the corresponding EDID configuration. Some of the screens are read-only.
- ◆ See *Customized EDID Settings*, page 67 for more information on these two columns.

Customized EDID Settings

The EDID structure is comprised of 128 bytes in total – each heading shown in the left column corresponds to a specific number of bytes.

The pages for the pre-configured EDID Modes (Port 1, Default and Remix) cannot be edited. The pages for the Customized EDID, which can be edited, are discussed in the preceding sections:

Established Timings

This page lists video resolutions/timings that display devices can support.

EDID Mode	EDID & CEA Description	Retrieve EDID	Save
<input type="radio"/> ATEN Default <input type="radio"/> Port1 Mode <input type="radio"/> Remix <input checked="" type="radio"/> Customized <input type="button" value="Apply"/> Port EDID Status <input checked="" type="button" value="Port 1 Customized"/> <input type="button" value="Port 2 Customized"/> <input type="button" value="Port 3 Customized"/> <input type="button" value="Port 4 Customized"/>	EDID 1. Vendor/Product Identification 2. EDID Structure/Revision 3. Basic Display/Feature 4. Color Characteristics 5. Established Timings 6. Standard Timings 7. Detail Timing/Display Description 1 8. Detail Timing/Display Description 2 9. Monitor Description 10. Monitor Description CEA 1. Display Support 2. Video Data 3. Audio Data	<input checked="" type="checkbox"/> 720x400 @ 70HZ <input type="checkbox"/> 720x400 @ 88Hz <input checked="" type="checkbox"/> 640x480 @ 60Hz <input checked="" type="checkbox"/> 640x480 @ 67Hz <input checked="" type="checkbox"/> 640x480 @ 72Hz <input checked="" type="checkbox"/> 640x480 @ 75Hz <input checked="" type="checkbox"/> 800x600 @ 56Hz <input checked="" type="checkbox"/> 800x600 @ 60Hz <input checked="" type="checkbox"/> 800x600 @ 72Hz <input checked="" type="checkbox"/> 800x600 @ 75Hz <input type="checkbox"/> 832x624 @ 75Hz (Apple Macintosh II) <input type="checkbox"/> 1024x768 @ 87Hz, interlaced(1024*768) <input checked="" type="checkbox"/> 1024x768 @ 60Hz <input checked="" type="checkbox"/> 1024x768 @ 70Hz <input checked="" type="checkbox"/> 1024x768 @ 75Hz	

- ◆ Select the resolution(s) you want to use for the attached monitor/display device.
- ◆ Click **Clear** to deselect all the items.
- ◆ Click **Select All** to check all the items.
- ◆ Click **Save** to apply the changes.

Standard Timings

This page shows eight resolutions/timings that display devices can support in addition to those listed in the Established Timings page.

The screenshot shows the EDID configuration interface. On the left, there are radio buttons for 'ATEN Default', 'Port1 Mode', 'Remix', and 'Customized' (which is selected). Below these is an 'Apply' button and a 'Port EDID Status' section with 'Port 1 Customized' highlighted in green. The main area is titled 'EDID & CEA Description' and contains a list of 10 EDID items and 3 CEA items. A table of EDID options is highlighted with a red box:

H Active Pixel	V Active Pixel	R Refresh Rate	Aspect Ratio
H 1600 ▼	V 1200	R 60	4:3 ▼
H 1280 ▼	V 1024	R 60	5:4 ▼
H 1400 ▼	V 1050	R 60	4:3 ▼
H 1440 ▼	V 900	R 60	16:10 ▼
H 1680 ▼	V 1050	R 60	16:10 ▼
H 1920 ▼	V 1080	R 60	16:9 ▼
H 1280 ▼	V 800	R 60	16:10 ▼
H 1920 ▼	V 1200	R 60	16:10 ▼

- ◆ Select the *H Active Pixel* from the drop-down menu.
- ◆ Select the *Aspect Ratio* from the drop-down menu.
- ◆ Click **Save** to apply the changes.

Detail Timing / Display Description

This screen gives more video resolution options, and provides resolution/timing details.

The screenshot shows the EDID configuration interface. On the left, the 'Customized' radio button is selected. The main area is titled 'EDID & CEA Description' and contains a list of 10 EDID items and 3 CEA items. A 'Resolution' dropdown menu is highlighted with a red box. Below it, the 'Resolution Detail' table is shown:

	Horizontal	Vertical
Image Size :	mm	mm
Active PXL :	pixel	lines
Blanking Time:	pixel	lines
Sync Offset:	pixel	lines
Sync Width:	pixel	lines
Border:	pixel	lines

In the drop down menu, choose a resolution with values that fit the attached monitor/display device and click **Save**.

Monitor Description

This screen lets you specify the viewing specifications, namely horizontal and vertical scan ranges and pixel clock rate, of your monitor/display device.

EDID Mode

ATEN Default

Port1 Mode

Remix

Customized

Port EDID Status

Port 1 Customized

Port 2 Customized

Port 3 Customized

Port 4 Customized

EDID & CEA Description

EDID

1. Vendor/Product Identification
2. EDID Structure/Revision
3. Basic Display/Feature
4. Color Characteristics
5. Established Timings
6. Standard Timings
7. Detail Timing/Display Description 1
8. Detail Timing/Display Description 2
9. Monitor Description
10. Monitor Description

CEA

1. Display Support
2. Video Data
3. Audio Data

	Minutes	~	Max
Horizontal Scan Range:	15	~	102
Vertical Scan Range:	23	~	121
Pixel Clock Rate: (MHz)	80		(10-2550)

Enter the values that correspond to your device and click **Save** to apply the changes.

Firmware

The *Firmware* page lets users view information about the firmware version currently in use and upgrade it if needed. This is an Administrator only function.

Device & Slot	Model	Firmware Version
<input type="checkbox"/> Video Matrix	VM3909H	V1.0.171
<input type="checkbox"/> Port1	N/A	N/A
<input type="checkbox"/> Port2	N/A	N/A
<input type="checkbox"/> Port3	N/A	N/A
<input type="checkbox"/> Port4	N/A	N/A
<input type="checkbox"/> Port5	N/A	N/A
<input type="checkbox"/> Port6	N/A	N/A
<input type="checkbox"/> Port7	N/A	N/A
<input type="checkbox"/> Port8	N/A	N/A
<input type="checkbox"/> Port9	N/A	N/A

To upgrade the VM3404H / VM3909H's firmware, do the following:

1. Use the **Browse** button to locate the firmware upgrade file. Make sure you have the correct file saved on your PC.
2. Click **Upgrade** to begin the upgrade procedure.

Note: After updating the firmware, it's recommended that you clear your web browser's cache and then close and reopen the web browser. This will ensure the GUI refreshes and functions properly.

IR Channel

The *IR Channel* page lets users view and set IR settings between input and output ports when using HDBaseT ports. This is an Administrator and Advanced User only function.

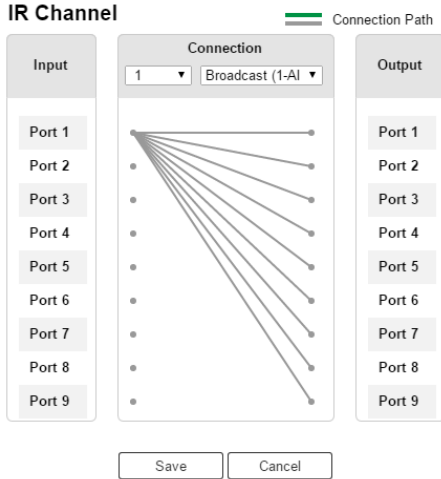

Input

Here users can see any locally connected IR adapters.

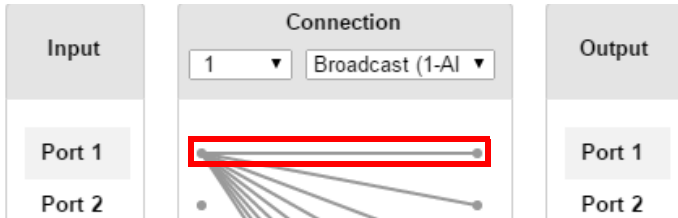

Connection

Here users can find a visual display of connection paths between inputs and outputs. Users can select *Broadcast* (one to all) and select which input port to broadcast from and to, or *Follow Video Path* which sets IR signals to follow each port's connection (see *Connection Profiles*, page 43).

Output

Here users can see any remotely connected IR adapters.

HDCP

The *HDCP* page lets users view and set HDCP key settings between input and output ports for digital copy protection and to ensure Seamless Switching between different devices. This is an Administrator and Advanced User only function.

The screenshot shows the 'HDCP Configuration' interface. It is divided into three main sections: 'Input', 'Connection', and 'Output'.
 - The 'Input' section has a dropdown menu set to 'Apply to All' and a list of ports from Port 1 to Port 9, each with a dropdown menu set to 'HDCP 1.4 Content'.
 - The 'Connection' section is a diagram showing lines connecting input ports to output ports. A green line is drawn from Port 1 to Port 1, indicating the active connection path.
 - The 'Output' section has a dropdown menu set to 'Apply to All' and a list of ports from Port 1 to Port 9, each with a checked checkbox labeled 'Fix HDCP'.
 At the bottom, there are 'Save' and 'Cancel' buttons.

Input

Here users can view whether the switch's content is HDCP or non-HDCP enabled.

This screenshot is identical to the one above, but with a red rectangular box highlighting the 'Connection' section. The green line connecting Port 1 to Port 1 is clearly visible within this highlighted area.

Connection

Here users can find a visual display of connection paths between inputs and outputs. When selecting an input, its path is displayed in green.

Output

Here users can define whether or not HDCP settings are fixed, either by individual port or by applying one setting to all ports. By prearranging and fixing keys, this setting ensures that Seamless Switching is possible even when switching between HDCP and non-HDCP enabled devices.

Telnet Operation

The VM3404H / VM3909H can be operated and configured via a remote terminal session using Telnet.

To log into the VM3404H / VM3909H by means of a Telnet session, do the following:

1. On your computer, open a terminal (command line) session.
2. At the prompt, key in the VM3404H / VM3909H's IP address in the following way:

```
telnet [IP address]:23
```
3. Press **Enter**. The login screen appears. At the login prompt, provide your Username and Password.

Note: If a user logs on using a Username that is already in session, the newest login takes effect and the previous session is replaced.

Configuration Menu

Once a Telnet connection to the VM3404H / VM3909H is established, the device's text-based Configuration Menu comes up, with the following items:

1. H – Call up the command list for help

Command list:

GT – Set gateway address

IM – Set IP subnet mask

IP – Set IP address

LO – Load connections from profile *nn*

PW – Change password

RI– Read what input is connected to *nn* output

RO – Read what output is connected to *nn* input

SB – Set the serial port baud rate

SS – Switch input to specified port

SV – Save the current connections into profile *nn*

TI – Set timeout

VR – Software version information

Ctrl-Q – Quit

2. GT – Set gateway address

GT

Old gateway address: 192.168.0.1

New gateway address:

3. IM – Set IP subnet mask

IM

Old IP subnet mask: 255.255.255.0

New IP subnet mask:

4. IP – Set IP address

IP

Old IP address: 192.168.0.60

New IP address:

5. LO – Load connections from profile

LO 01

Load profile 01 OK.

6. PW – Change password

PW

Old password: *****

New password:

7. RI – Read what input is connected to *nn* output

RI 01

Input port 02 04 08 is connected to output port 01

8. RO – Read what output is connected to *nn* input

RO 01

Output port 02 is connected to input port 01

9. SB – Set serial port baud rate

SB 96

Serial port baud rate is set to 9600

10. SS – Switch input to specified output

SS 01, 03

Switch input 01 to output 03

11. SV – Save the current connections into a profile

SV 01

Save the current connections into profile 01

12. TI – Set timeout

TI 30

Set 30 minute timeout

13. VR – Software version information

VR

Software version 1.0.

Note: For further information about these functions, please reference the equivalent Browser GUI functions earlier in this chapter.

This Page Intentionally Left Blank

Chapter 5

RS-232 Commands

Serial Control Protocol Commands

The VM3404H / VM3909H's built-in bi-directional RS-232 serial interface allows system control through a high-end controller or PC. The RS-232 commands for the VM3404H and VM3909H are the same, with the only difference being that the VM3909H has 5 additional ports.

RS232 Pin Assignment

Pin	Description	Pin	Description
1	Not connected	6	Not connected
2	RXD	7	Not connected
3	TXD	8	Not connected
4	Not connected	9	Not connected
5	GND		

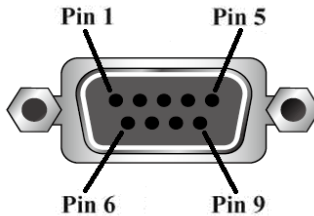

Configuring the Serial Port

The controller's serial port should be configured as follows:

Baud Rate	19200
Data Bits	8
Parity	None
Stop Bits	1
Flow Control	None

Verification

After entering a command, a verification message appears at the end of the command line as follows:

- ◆ **Command OK** - indicates that the command is correct and successfully performed by the switch
- ◆ **Command incorrect** - indicates that the command has the wrong format and/or values.

Switch Port Command

The Switch Port command allows you to switch ports on the VM3404H / VM3909H.

The formula for the Switch command is as follows:

Command + Input + Number + Output + Number + Control + [Enter]

1. For example, to switch input port 02 to output port 05, type:

sw i02 o05 [Enter]

2. To switch output port 04 to the next port, type:

sw o04 + [Enter]

3. To turn off video output on port 03, type:

sw o03 off [Enter]

The following tables show the possible values for the **Switch Port** command:

Command	Description
sw	Switch command

Input Command	Description
i	Input command

Port number	Description
xx	01-09 port

Output Command	Description
o	Output command

Port number	Description
yy	01-09 port
*	All output ports

Control	Description
on	Turn on the display
off	Turn off the display
+	Next Port
-	Previous Port

- Note:** 1. By default, input port 01 is tied to output port 01; input port 02 is tied to output port 02; and so on until port 09 (i.e., o01 i01, o02 i02).
2. Each command string can be separated with a space.
3. The **Port Number** can be skipped, and the default value will be used.
-

The following table lists the available Switch Port commands:

Command	Input Command	Input Port	Output Command	Output Port	Control	Enter	Description
sw	i	xx	o	yy *		[Enter]	Switch Input Port xx to Output Port yy (xx:01~09; yy:01~09, *)
sw			o	yy *	on off	[Enter]	Turn on Output Port yy Turn off Output Port yy (yy:01~09, *)
sw			o	yy *	+ -	[Enter]	Switch Output port yy to next Output port. Switch Output port yy to previous Output port. (yy:01~09, *)

EDID Mode Command

Extended Display Identification Data (EDID) is a data that contains a display's basic information and is used to communicate with the video source.

The formula for the EDID command is as follows:

Command + Control + [Enter]

1. For example, to use the Port1 EDID mode, type:

edid port1 [enter]

The following tables show the possible values for the **EDID** command:

Command	Description
edid	EDID Mode command

Control	Description
port1	Implement the EDID of the connected display to Port 1, and pass it to the video source.
remix	Implement the EDID of each connected display according to its connection when the VM3404H / VM3909H is first powered on, or immediately after selecting the Remix option.
default	Implements ATEN's default EDID. (default)
custom	Implements the customized mode as set in the EDID system settings. (See <i>Customized EDID Settings</i> , page 67)

Note: Each command string can be separated with a space.

The following table lists the available EDID commands:

Command	Control	Enter	Description
edid	port1	[Enter]	The EDID from Port 1 is passed to the video source.
edid	remix	[Enter]	The VM3404H / VM3909H implements the EDID of each connected display according to its connection when the VM3404H / VM3909H is first powered on, or immediately after selecting the Remix option.
edid	default	[Enter]	ATEN's default EDID is passed to the video source.

Command	Control	Enter	Description
edit	custom	[Enter]	Implements the customized mode.

CEC Command

Consumer Electronics Control (CEC) allows interconnected HDMI devices to communicate and respond to the same remote control.

The formula for the CEC command is as follows:

Command + Output + Number + Control + [Enter]

1. For example, to enable the CEC function on output port 1, type:
cec o01 on [enter]

The following tables show the possible values for the **CEC** command:

Command	Description
cec	CEC command
Output Command	Description
o	Output command
Port number	Description
yy	01-09 port (default is 01)
*	All output ports
Control	Description
off	Disable CEC (default)
on	Enable CEC

Note: Each command string can be separated with a space.

The following table lists the available CEC commands:

Command	Output	Output Port	Control	Enter	Description
cec	o	yy *	off	[Enter]	CEC off for output port yy (default) (yy:01~09, *)
cec	o	yy *	on	[Enter]	CEC on for output port yy (yy:01~09, *)

Scaling Command

The Scaling command allows you to set a resolution for scaling the display connected to an output port.

The formula for the Scaling command is as follows:

Command + Output + Number + Address + Number + Horizontal resolution + Number + Vertical Resolution + Number + [Enter]

1. For example, to turn scaling off for output port 02, type:
scaling o02 off [Enter]
2. To set the scaling for output port 04 to 1920x1080@60Hz, type:
scaling o04 1080p [Enter]
3. To set the scaling for all output ports to the connected display's native resolution, type:
scaling o* native [Enter]

The following tables show the possible values for the **Scaling** command:

Command	Description
scaling	Scaling command
Output Command	Description
o	Output command
Port Number	Description
yy	01-09 port
*	All output ports
Control	Description
off	Turn off the scaling function (by pass mode)
native	Map display's native resolution for scaling (default)
1080p	Scale to 1920x1080@60Hz
720p	Scale to 1280x720@60Hz
1920	Scale to 1920x1200@60Hz
1800	Scale to 1800x1200@60Hz
1400	Scale to 1400x1050@60Hz
1280	Scale to 1280x1024@60Hz

Control	Description
1024	Scale to 1024x768@60Hz
hor	Horizontal of scaling resolution
hhhh	Horizontal resolution
ver	Vertical of scaling resolution
vvvv	Vertical resolution
freq	Frequency of scaling resolution
fff	Scaling resolution frequency

- Note:** 1. Each command string can be separated with a space.
2. The **Port Number** command string can be skipped, and the default value will be used.

The following table lists the available Scaling commands:

Command	Output	Port Number	Control	Enter	Description
scaling	o	yy *	off	[Enter]	Turn off scaling for port yy (by pass mode) yy: 01 ~ 09 or *
scaling	o	yy *	native	[Enter]	Enable display's native resolution for scaling on output port yy (default) yy: 01 ~ 09 or *
scaling	o	yy *	1080p	[Enter]	Scale output port yy to 1920x1080@60Hz yy: 01 ~ 09 or *
scaling	o	yy *	720p	[Enter]	Scale output port yy to 1280x720@60Hz yy: 01 ~ 09 or *
scaling	o	yy *	1920	[Enter]	Scale output port yy to 1920x1200@60Hz yy: 01 ~ 09 or *
scaling	o	yy *	1800	[Enter]	Scale output port yy to 1800x1200@60Hz yy: 01 ~ 09 or *
scaling	o	yy *	1400	[Enter]	Scale output port yy to 1400x1050@60Hz yy: 01 ~ 09 or *

Command	Output	Port Number	Control	Enter	Description
scaling	o	yy *	1280	[Enter]	Scale output port yy to 1280x1024@60Hz yy: 01 ~ 09 or *
scaling	o	yy *	1024	[Enter]	Scale output port yy to 1024x768@60Hz yy: 01 ~ 09 or *
scaling	o	yy *	hor 1920 ver 1080 freq 60	[Enter]	Scale output port yy to 1920x1080@60Hz yy: 01 ~ 09 or *
scaling	o	yy *	hor 4096 ver 2048 freq 30	[Enter]	Scale output port yy to 4096x2048@30Hz yy: 01 ~ 09 or *

Echo Command

The Echo function updates the RS232 controller when operations are made via the front panel pushbuttons, web browser, or telnet. The changes echo back to the RS232 controller to keep the settings in sync with the device.

The formula for the Echo command is as follows:

Command + Control + [Enter]

1. For example, to enable the echo feature, type:

echo on [Enter]

The following tables show the possible values for the **Echo** command:

Command	Description
echo	Echo command

Control	Description
on	Turns Echo function on
off	Turns Echo function off (default)

Note: Each command string can be separated with a space.

The following table lists the available Echo commands:

Command	Control	Enter	Description
echo	on	[Enter]	Turn on Echo function
echo	off	[Enter]	Turn off Echo function

Read Command

The Read command allows you to view the current configuration, firmware and other information about the device.

The formula for the Read command is as follows:

Command + [Enter]

1. To view information about the device, type:

read [Enter]

The following table shows the possible values for the **Read** command:

Command	Description
read	Read command

Note: Each command string can be separated with a space.

The following table lists the available Read commands:

Command	Enter	Description
read	[Enter]	View information about the device

Reset Command

The Reset command allows you to reset the VM3404H / VM3909H to the default factory settings.

The formula for the Reset command is as follows:

Command + [Enter]

The following tables show the possible values for the **Reset** command:

Command	Description
reset	Reset command

Note: Each command string can be separated with a space.

The following table lists the available Reset commands:

Command	Enter	Description
reset	[Enter]	Resets the device settings

Baud Rate Command

The Baud Rate command allows you to set the RS-232 data rate for the VM3404H / VM3909H to use. Options are 9600, 19200 (default) 38400 and 115200.

The formula for the Baud Rate command is as follows:

Command + Control + [Enter]

1. For example, to set 38400 as the baud rate, type:

baud 38400 [Enter]

The following tables show the possible values for the **Baud Rate** command:

Command	Description
baud	Sets the RS-232 baud rate

Control	Description
9600	Use 9600 baud rate
19200	Use 19200 baud rate (default)
38400	Use 38400 baud rate
115200	Use 115200 baud rate

Note: Each command string can be separated with a space.

The following table lists the available Baud Rate commands:

Command	Control	Enter	Description
baud	9600 / 19200 / 38400 / 115200	[Enter]	Sets the RS-232 baud rate

Save/Load Profile Command

The Save/Load Profile command allows you to save and load connection profiles. Saving profiles will save the connections currently in use.

The formula for the Save/Load Profile command is as follows:

Command + Profile + Number + Control + [Enter]

1. For example, to save the current connection configuration to profile 02, type:

profile f 02 save [Enter]

The following tables show the possible values for the **Save/Load Profile** commands:

Command	Description
profile	Save / Load profile
Profile	Description
f	Profile command
Profile Number	Description
yy	VM3404H: 01-09 (default is 01)
	VM3909H: 01-18 (default is 01)
Control	Description
save	Save the connection configuration
load	Load a saved profile

Note: Each command string can be separated with a space.

The following table lists the available Save/Load Profile commands:

Command	Profile	Profile Number	Control	Enter	Description
profile	f	yy *	save	[Enter]	Save the connections as profile yy. VM3404H: (yy:01~08, *) VM3909H: (yy:01~18, *)
profile	f	yy *	load	[Enter]	Load profile yy. VM3404H: (yy:01~08, *) VM3909H: (yy:01~18, *)

OSD Command

To enable or disable the On-Screen Display (OSD) using the following command:

Command + Output Command + Port Number + Control + [Enter]

1. For example, to enable the OSD, type:

osd on [enter]

The following tables show the possible values for the **OSD** command:

Command	Description
osd	Enable / Disable the OSD
Output Command	Description
o	Output command
Port Number	Description
yy	01-09 port
*	All output ports
Control	Description
on	OSD is enabled (default)
off	OSD is disabled

Note: Each command string can be separated with a space.

The following table lists the available OSD commands:

Command	Output Command	Output Port	Control	Enter	Description
osd	o	yy *	on	[Enter]	OSD on
osd	o	yy *	off	[Enter]	OSD off

RS232 Pin Assignment

Pin	Description	Pin	Description
1	Not connected	6	Not connected
2	RXD	7	Not connected
3	TXD	8	Not connected
4	Not connected	9	Not connected
5	GND		

Safety Instructions

General

- ◆ Read all of these instructions. Save them for future reference.
- ◆ Follow all warnings and instructions marked on the device.
- ◆ This product is for indoor use only.
- ◆ Do not place the device on any unstable surface (cart, stand, table, etc.). If the device falls, serious damage will result.
- ◆ Do not use the device near water.
- ◆ Do not place the device near, or over, radiators or heat registers.
- ◆ The device cabinet is provided with slots and openings to allow for adequate ventilation. To ensure reliable operation, and to protect against overheating, these openings must never be blocked or covered.
- ◆ The device should never be placed on a soft surface (bed, sofa, rug, etc.) as this will block its ventilation openings. Likewise, the device should not be placed in a built in enclosure unless adequate ventilation has been provided.
- ◆ Never spill liquid of any kind on the device.
- ◆ Unplug the device from the wall outlet before cleaning. Do not use liquid or aerosol cleaners. Use a damp cloth for cleaning.
- ◆ The device should be operated from the type of power source indicated on the marking label. If you are not sure of the type of power available, consult your dealer or local power company.
- ◆ The device is designed for IT power distribution systems with 230V phase-to-phase voltage.
- ◆ To prevent damage to your installation it is important that all devices are properly grounded.
- ◆ The device is equipped with a 3-wire grounding type plug. This is a safety feature. If you are unable to insert the plug into the outlet, contact your electrician to replace your obsolete outlet. Do not attempt to defeat the purpose of the grounding-type plug. Always follow your local/national wiring codes.
- ◆ Do not allow anything to rest on the power cord or cables. Route the power cord and cables so that they cannot be stepped on or tripped over.

- ◆ If an extension cord is used with this device make sure that the total of the ampere ratings of all products used on this cord does not exceed the extension cord ampere rating. Make sure that the total of all products plugged into the wall outlet does not exceed 15 amperes.
- ◆ To help protect your system from sudden, transient increases and decreases in electrical power, use a surge suppressor, line conditioner, or un-interruptible power supply (UPS).
- ◆ Position system cables and power cables carefully; Be sure that nothing rests on any cables.
- ◆ Never push objects of any kind into or through cabinet slots. They may touch dangerous voltage points or short out parts resulting in a risk of fire or electrical shock.
- ◆ Do not attempt to service the device yourself. Refer all servicing to qualified service personnel.
- ◆ If the following conditions occur, unplug the device from the wall outlet and bring it to qualified service personnel for repair.
 - ◆ The power cord or plug has become damaged or frayed.
 - ◆ Liquid has been spilled into the device.
 - ◆ The device has been exposed to rain or water.
 - ◆ The device has been dropped, or the cabinet has been damaged.
 - ◆ The device exhibits a distinct change in performance, indicating a need for service.
 - ◆ The device does not operate normally when the operating instructions are followed.
- ◆ Only adjust those controls that are covered in the operating instructions. Improper adjustment of other controls may result in damage that will require extensive work by a qualified technician to repair.

Rack Mounting

- ◆ Before working on the rack, make sure that the stabilizers are secured to the rack, extended to the floor, and that the full weight of the rack rests on the floor. Install front and side stabilizers on a single rack or front stabilizers for joined multiple racks before working on the rack.
- ◆ Always load the rack from the bottom up, and load the heaviest item in the rack first.
- ◆ Make sure that the rack is level and stable before extending a device from the rack.
- ◆ Do not overload the AC supply branch circuit that provides power to the rack. The total rack load should not exceed 80 percent of the branch circuit rating.
- ◆ Make sure that all equipment used on the rack – including power strips and other electrical connectors – is properly grounded.
- ◆ Ensure that proper airflow is provided to devices in the rack.
- ◆ Ensure that the operating ambient temperature of the rack environment does not exceed the maximum ambient temperature specified for the equipment by the manufacturer.
- ◆ Do not step on or stand on any device when servicing other devices in a rack.

Technical Support

International

- ◆ For online technical support – including troubleshooting, documentation, and software updates: <http://eservice.aten.com>
- ◆ For telephone support, see *Telephone Support*, page iii:

North America

Email Support		support@aten-usa.com
Online Technical Support	Troubleshooting Documentation Software Updates	http://www.aten-usa.com/support
Telephone Support		1-988-999-ATEN ext 4988

When you contact us, please have the following information ready beforehand:

- ◆ Product model number, serial number, and date of purchase.
- ◆ Your computer configuration, including operating system, revision level, expansion cards, and software.
- ◆ Any error messages displayed at the time the error occurred.
- ◆ The sequence of operations that led up to the error.
- ◆ Any other information you feel may be of help.

Specifications

Function		VM3404H	VM3909H
Video Input	Interface	4 x HDMI Type A Female (Black)	9 x HDMI Type A Female (Black)
	Impedance	100 Ω	
	Max. Distance	1.8 m	
Video Output	Interface	4 x HDMI Type A Female (Black) 4 x RJ-45 Female	9 x HDMI Type A Female (Black) 9 x RJ-45 Female
	Impedance	100 Ω	
	Max. Distance	HDMI: 15 m HDBaseT (Class B): 4K@35m (Cat 5e/6) / 40m (Cat 6a); 1080p@60m (Cat 5e/6) / 70m (Cat 6a)	
Video	Max. Data Rate	10.2 Gbps (3.4 Gbps Per Lane)	
	Max. Pixel Clock	340 MHz	
	Compliance	HDMI (3D, Deep Color, 4K)	
		HDCP 1.4 Compatible	
		Consumer Electronics Control (CEC)	
	Max. Resolution	Up to 4K @ 60 Hz (4:2:0); 4K @ 30 Hz (4:4:4)	
Max. Distance	Up to 70 m*		
Control	Ethernet	1 x RJ-45 Female	
	RS-232	Connector: 1 x DB9 Female (Black) Baud Rate: 19200, Data Bits: 8, Stop Bits:1, Parity: No, Flow Control: No	
	IR Channel	4 x Mini Stereo Jack Female (Black); 30~60 kHz full range transmission	9 x Mini Stereo Jack Female (Black); 30~60 kHz full range transmission
EDID Settings		EDID Mode: Default / Port1 / Remix / Customized	
Power	Connector	1 x 3-Prong AC Socket	
	I/P Rating	100-240VAC; 50-60Hz; 1.0A	
	Consumption	110 VAC, 68.2 W	110 VAC, 134.4W
Environmental	Operating Temperature	0–50°C	
	Storage Temperature	-20–60°C	
	Humidity	0–80% RH, Non-condensing	

Function		VM3404H	VM3909H
Physical Properties	Housing	Metal	
	Weight	5.6 kg	7.33 kg
	Dimensions (L x W x H)	43.24 x 38.23 x 4.40 cm	43.24 x 38.23 x 8.80 cm
Carton Lot		1 pc	

Note: A Cat 6a RJ-45 cable is required in order to extend a signal to 70m.

Compatible Receivers

Receiver	Max. Distance	IR	4K	Seamless Switch™	Video Wall	POH
VE801R	70m*		Yes			
VE802R	70m*	Yes	Yes			Yes
VE805R (with Scaler)	70m*	Yes		Yes	Yes	
VE812R	70m		Yes			
VE814R	70m		Yes			
VE601R	70m*					

* Cat 6a Ethernet cable is required to extend the distance up to 70 meters.

Limited Warranty

IN NO EVENT SHALL THE DIRECT VENDOR'S LIABILITY EXCEED THE PRICE PAID FOR THE PRODUCT FROM DIRECT, INDIRECT, SPECIAL, INCIDENTAL, OR CONSEQUENTIAL DAMAGES RESULTING FROM THE USE OF THE PRODUCT, DISK, OR ITS DOCUMENTATION.

The direct vendor makes no warranty or representation, expressed, implied, or statutory with respect to the contents or use of this documentation, and especially disclaims its quality, performance, merchantability, or fitness for any particular purpose.

The direct vendor also reserves the right to revise or update the device or documentation without obligation to notify any individual or entity of such revisions, or update. For further inquiries, please contact your direct vendor.

EMC Information	ii
RoHS	ii
Safety	ii
SJ/T 11364-2006	ii
User Information	iii
Online Registration	iii
Telephone Support	iii
User Notice	iii
Package Contents	iv
Contents	v
About this Manual	ix
Conventions	x
Product Information	x

Chapter 1.

Introduction

Overview	1
Features	3
Requirements	5
Source Devices	5
Display Devices	5
Cables	5
Source Device Operating Systems	6
Browsers	6
Components	7
VM3404H Front View	7
VM3404H Rear View	8
VM3909H Front View	9
VM3909H Rear View	10

Chapter 2.

Hardware Setup

Rack Mounting	11
Grounding	13
Cable Connection	14
Installation Diagram	15

Chapter 3.

Front Panel Configuration

Overview	17
Front Panel Pushbuttons	17
Enter Password	18
Main Screen	19
Port Switching	19
Input Port Selection	19
Output Port Selection	21
LCD Menu Organization	23

Menu Pushbutton	23
IP Setting	24
IP Address / Subnet Mask	24
Gateway	24
Serial Port Setting	25
Baud Rate	25
Operation Mode	26
EDID Mode	26
CEC	27
OSD	28
Output Status	29
Security Mode	30
Password	30
Change Password	31
Save to a Profile	32
Play/Stop the Profile Schedule	33
Profile Pushbutton	34

Chapter 4.

Browser Operation

Overview	35
Logging In	35
Main Page	36
Menu Bar	36
Profile List	37
Adding/Playing a Profile	37
Profile List Options	39
Profile	39
Play Window	39
Profile Scheduling	41
Connection Profiles	43
Digital Signage Profile	43
Output Icon	44
Select Source	44
Grid View	45
Output Options	45
Video Wall Profile	46
Video Wall Options	46
Number of Displays / Bezel Dimensions	47
Blank Output	48
Independent Output	48
Grouping	49
Group	49
Display Preferences	50
Video Wall Example	51
Output Options	52

Video Options	52
System Settings	54
General	56
Fan Status	56
OSD / CEC	56
Other	56
User Account	58
Add Account	58
Permission Level	59
Port Name	61
Network	62
EDID	63
EDID Mode	64
Customized Mode	65
EDID & CEA Description	66
Customized EDID Settings	67
Firmware	70
IR Channel	71
HDCP	72
Telnet Operation	73
Configuration Menu	73
1. H – Call up the command list for help	73
2. GT – Set gateway address	74
3. IM – Set IP subnet mask	74
4. IP – Set IP address	74
5. LO – Load connections from profile	74
6. PW – Change password	74
7. RI – Read what input is connected to nn output	74
8. RO – Read what output is connected to nn input	75
9. SB – Set serial port baud rate	75
10. SS – Switch input to specified output	75
11. SV – Save the current connections into a profile	75
12. TI – Set timeout	75
13. VR – Software version information	75

Chapter 5.

RS-232 Commands

Serial Control Protocol Commands	77
RS232 Pin Assignment	77
Configuring the Serial Port	77
Verification	78
Switch Port Command	79
EDID Mode Command	81
CEC Command	83
Scaling Command	84
Echo Command	87

Read Command	88
Reset Command	88
Baud Rate Command	89
Save/Load Profile Command	90
OSD Command	91
RS232 Pin Assignment	92

Appendix

Safety Instructions	93
General	93
Rack Mounting	95
Technical Support	96
International	96
North America	96
Specifications	97
Compatible Receivers	99
Limited Warranty	99