

Always here to help you 始终如一地为您提供帮助

Register your product and get support at /
请登录以下网址并得到相应的帮助
www.philips.com/welcome



FC8820
FC8810



PHILIPS

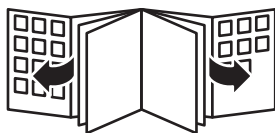

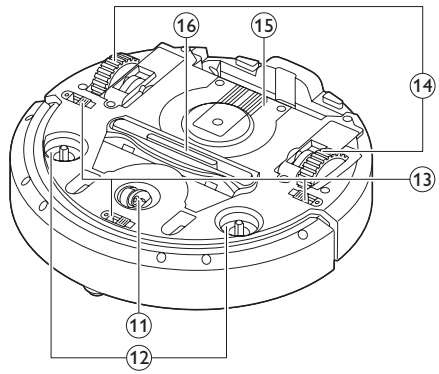
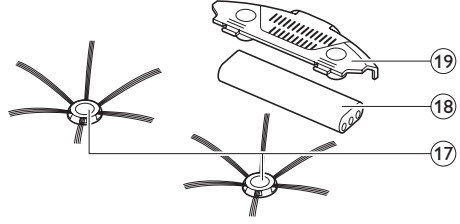
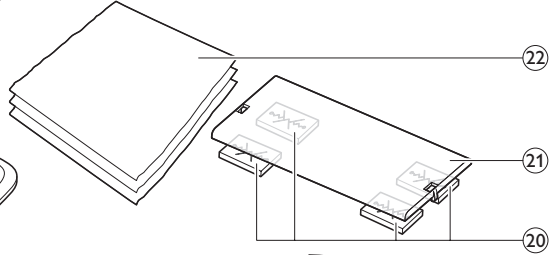
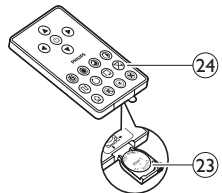
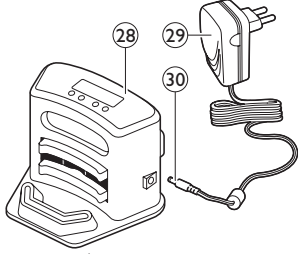
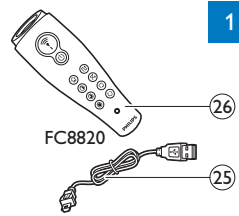
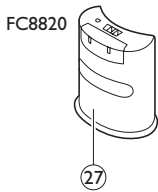
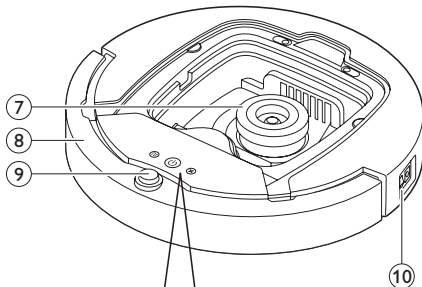
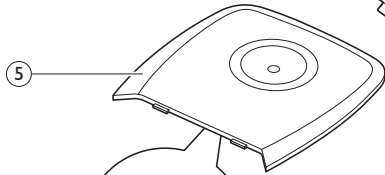
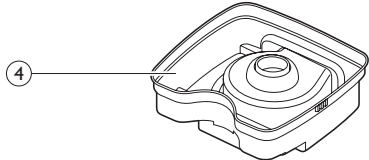
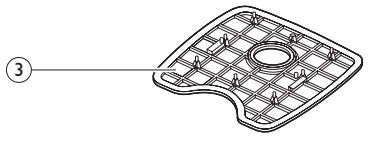
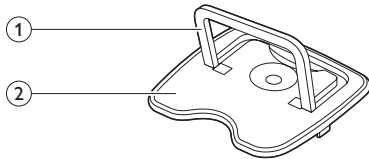

Introduction

Congratulations on your purchase and welcome to Philips!
To fully benefit from the support that Philips offers, register your product at www.philips.com/welcome.

Your robot (Fig. 1)

- 1 Handle of dust container lid
- 2 Dust container lid
- 3 Filter
- 4 Dust container
- 5 Top cover
- 6 Error codes table
- 7 Fan
- 8 Bumper
- 9 On/off button (switches robot on or to standby)
- 10 Power switch (switches robot on or off)
- 11 Front wheel
- 12 Side brush shafts
- 13 Drop-off sensors
- 14 Wheels
- 15 Battery cavity
- 16 Suction opening
- 17 Side brushes
- 18 Rechargeable battery
- 19 Battery cavity cover
- 20 Fixation blocks for dry wipes
- 21 Dry wipe holder
- 22 Dry wipes
- 23 Battery holder
- 24 Remote control
- 25 Charging cord
- 26 Pointer
- 27 Virtual wall unit
- 28 Docking station
- 29 Adapter
- 30 Small plug

Displays and control panels

Control panel of docking station

- 1 Display with time, day and programming indications
- 2 Adjusting and setting buttons
- 3 Battery indicator

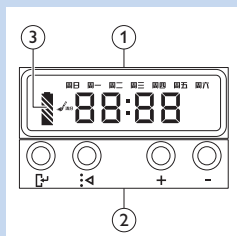

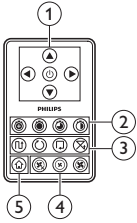

Remote control

- 1 Navigation buttons and on/off
- 2 Cleaning time buttons
- 3 Cleaning mode buttons
- 4 Fan speed buttons
- 5 Docking button

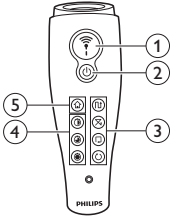

Pointer (FC8820)

- 1 Pointer button
- 2 On/off button
- 3 Cleaning mode buttons
- 4 Cleaning time buttons
- 5 Docking button

How your robot works

What your robot cleans

This robot is equipped with features that make it a suitable cleaner to help you clean the floors in your home.

The robot is especially suitable for cleaning hard floors, such as wooden, tiled or linoleum floors. It may experience problems cleaning soft floors, such as carpet or rugs. If you use the robot on a carpet or rug, please stay close by the first time to see if the robot can deal with this type of floor.

The robot also needs supervision when you use it on black and shiny hard floors.

How your robot cleans

Cleaning system

- The robot has a 3-stage cleaning system to clean your floors efficiently.
- The two side brushes help the robot clean in corners and along walls. They also help to work dirt loose from the floor.

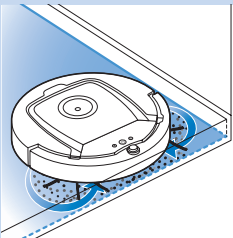

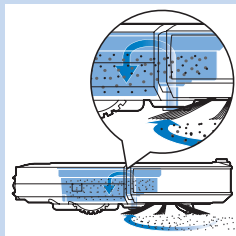

- The suction power of the robot picks up loose dirt and transports it through the suction opening into the dust container.
- The robot comes with a dry wipe holder that allows you to clean your hard floor even more thoroughly with dry wipes.

Cleaning patterns

In its auto cleaning mode, the robot uses an automatic sequence of cleaning patterns to clean each area of the room optimally.

The cleaning patterns it uses are:

- 1 Z-pattern or zigzag pattern
- 2 Random pattern
- 3 Wall-following pattern
- 4 Spiral pattern

During auto cleaning, the robot uses these patterns in a fixed sequence:

- 1 Z-pattern

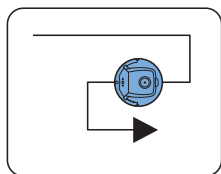

- 2 Random pattern

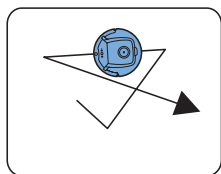

- 3 Wall-following pattern

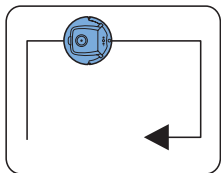

- 4 Spiral pattern

- When the robot has completed this sequence of patterns, it starts moving in Z-pattern again. The robot continues to use this sequence of patterns to clean the room until the rechargeable battery is empty, or until it is switched off manually.
- If the robot detects a particularly dirty area during its cleaning run, it switches to spiral mode and to turbo fan speed to ensure thorough dirt removal.

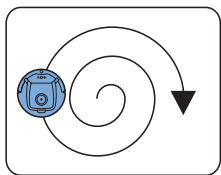

Note: You can also select each mode individually by pressing the appropriate button on the remote control or pointer (FC8820 only). For more details, see chapter 'Using your robot', section 'Cleaning modes'.

How your robot avoids height differences

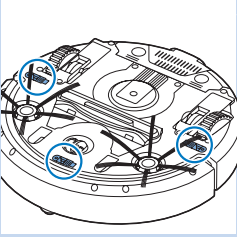

- The robot has three drop-off sensors in its bottom. It uses these drop-off sensors to detect and avoid height differences such as staircases.

Note: It is normal for the robot to move slightly over the edge of a height difference, as its front drop-off sensor is located behind the bumper.

Caution: In some cases, the drop-off sensors may not detect a staircase or other height difference in time. Therefore monitor the robot carefully the first few times you use it, and when you operate it near a staircase or another height difference.

Before first use

Mounting the side brushes

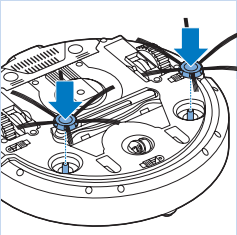

- 1 Unpack the side brushes and place the robot upside down on a table or on the floor.
- 2 Push the side brushes onto the shafts on the bottom of the robot.

Note: Make sure you attach the side brushes properly. Press them onto the shaft until you hear them lock into position with a click.

Inserting the rechargeable battery into the robot

You have to insert the rechargeable battery before use.

- 1 Press the ribbed sections on the battery cavity cover to unlock it.

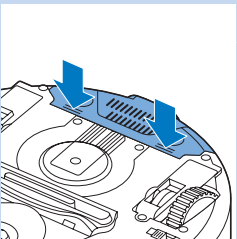

- 2 Slide the battery cavity cover off the robot.
- 3 Remove the plastic from the rechargeable battery.

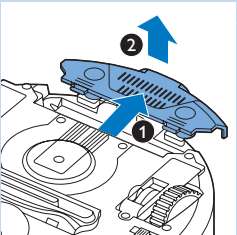

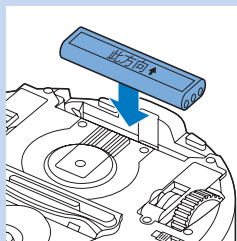

- Place the rechargeable battery into the battery cavity.

Note: Make sure that the print on the battery points upwards and that the connectors point in the right direction.

- Slide the battery cavity cover back onto the robot.

Removing the protection tag from the remote control

The remote control works on a CR2025 coin-shaped battery. This battery is protected with a protection tag that has to be removed before use.

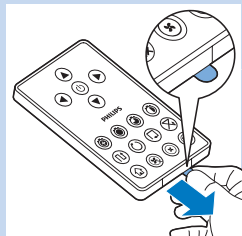

- Pull the battery protection tag out of the battery compartment of the remote control.
- Now the remote control is ready for use.

Preparing for use

Installing the docking station

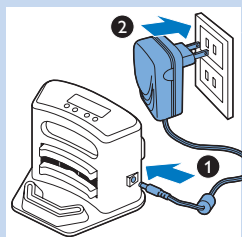

- Insert the small plug of the adapter into the socket on the docking station (1) and insert the adapter into the wall socket (2). The display of the docking station lights up.

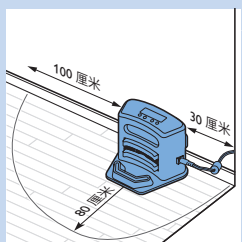

- Place the docking station on a horizontal, level floor against the wall.

Tip: To ensure the docking station stays firmly in the selected spot, you can fasten it to the wall with screws or with two strips of double-sided tape.

Note: Make sure that there are no obstacles or height differences 80cm in front, 30 cm to the right and 100cm to the left of the docking station.

Charging

When you charge the rechargeable battery for the first time and when the rechargeable battery is empty, the charging time is four hours.

Your robot can be charged in two ways:

- On the docking station, either manually or automatically during use;
- By connecting the robot directly to the mains

Note: When the rechargeable battery is fully charged, your robot can clean for up to 100 minutes.

Charging on the docking station

1 Place the robot on the plugged-in docking station.

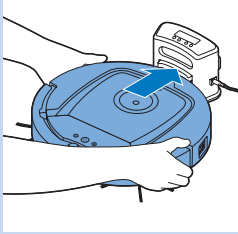

2 Press the power switch to switch on the robot.

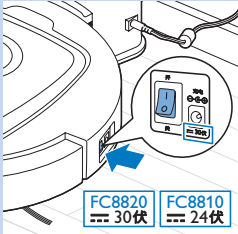

3 The battery indicator on the display of the docking station and the light in the on/off button on the robot start flashing.

Note: Because this is the first time you charge the robot, the display of the robot shows the booting indicator.

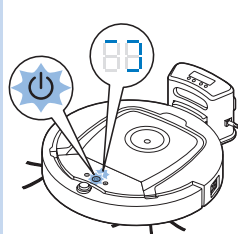

4 When the rechargeable battery is fully charged, the battery indicator on the display of the docking station and the light in the on/of button on the robot stop flashing.

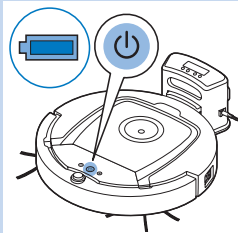

Charging automatically during use

1 When the robot has finished cleaning or when only 15% of the battery power remains, it automatically returns to the docking station to recharge. When the robot returns to the docking station, the light in the on/off button flashes.

2 When the robot is positioned correctly on the docking station, the battery indicator on the display of the docking station starts to flash.

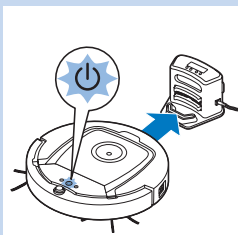

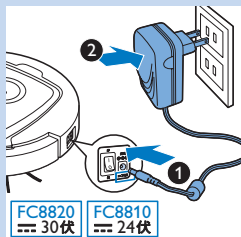

- When the rechargeable battery is fully charged, the battery indicator on the display of the docking station and the light in the on/of button on the robot stop flashing.

Note: The robot only returns to the docking station automatically when it started cleaning from the docking station.

Charging directly from the mains

- Insert the small plug of the adapter into the socket on the robot (1). Insert the adapter into a wall socket (2).
- Press the power switch to switch on the robot.
- When the robot is connected to the mains correctly, the light in the on/off button of the robot starts flashing. This indicates that the rechargeable battery is being charged.
- When the rechargeable battery is fully charged, the light in the on/off button of the robot stops flashing.

Preparing the room for a cleaning run

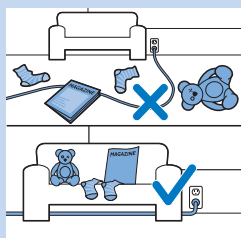

- Before you start the robot on its cleaning run, make sure that you remove all loose and fragile objects from the floor:

Using your robot

Starting and stopping

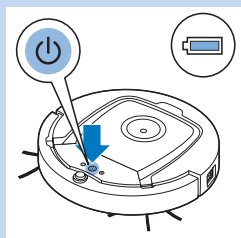

- Press the on/off button. The light in the on/off button goes on and the robot starts cleaning.
- You can press the on/off button on the robot.

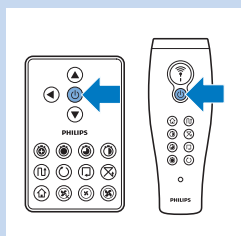

- You can also press the on off button on the remote control or on the pointer (FC8820).

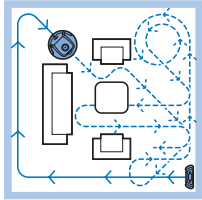

- 2 Unless you press one of the mode buttons, the robot continues cleaning in auto cleaning mode until its battery runs low. In auto cleaning mode it follows repeated sequences of Z-pattern, random, wall-following and spiral movements. For more information on the cleaning modes, see section 'Cleaning modes'.

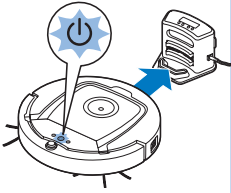

- 3 When the battery runs low, the light in the on/off button starts flashing and the robot returns to the docking station to charge.

- 4 You can also press the on/off button to interrupt or stop the cleaning run. If you press the on/off button again and there is still enough energy in the rechargeable battery, the robot continues cleaning in the auto cleaning mode.

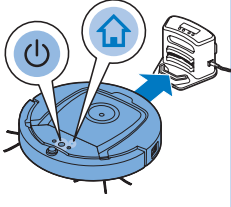

- 5 You can also make the robot return to the docking station before the rechargeable battery runs low by pressing the docking button on the remote control or the pointer (FC8820). The docking indicator on the display of the robot lights up and the robot returns to the docking station.

Note: If you did not start the robot from the docking station, it does not return to the docking station automatically when the rechargeable battery runs low. If there is still enough energy in the rechargeable battery, you can press the docking button to make the robot return to the docking station. If the rechargeable battery is completely empty, you have to place the robot on the docking station manually.

Cleaning modes

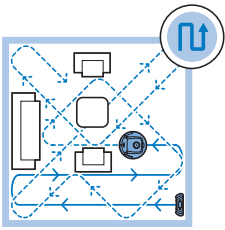

Next to the auto cleaning mode, this robot has four individual cleaning modes that can each be activated by pressing the appropriate button.

Z-pattern mode

- In Z-pattern mode, the robot cleans by making Z-shaped loops through the room to clean large areas.

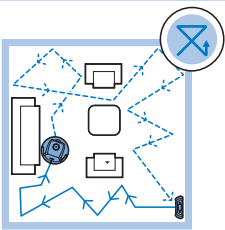

Random mode

- In this mode, the robot cleans the room in a mixed pattern of straight and crisscross movements.

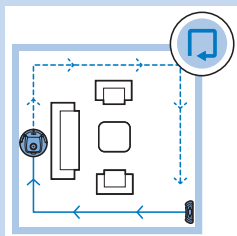

Wall-following mode

- In this mode, the robot follows the walls of the room to give the area alongside the walls an extra clean.

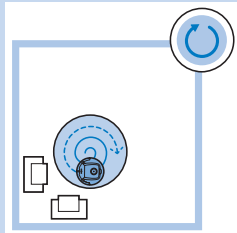

Spiral mode

- In this mode, the robot makes a spiral movement with the fan at turbo speed to clean a dirty area thoroughly.

Manual driving

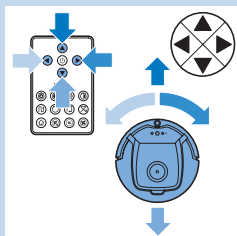

- 1 Use the arrow buttons above and below and to the left and right of the on/off button on the remote control to navigate the robot through the room.

Note: Do not press the downward arrow when the robot is close to a height difference or a staircase.

Using the cleaning time buttons

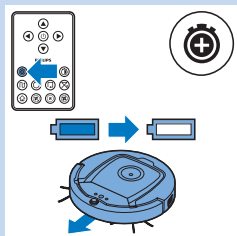

- Press the maximum cleaning time button to make the robot clean in auto cleaning mode until its rechargeable battery runs low. When the robot has finished cleaning, it returns to the docking station automatically if it started from the docking station. If the robot started from another point in the room, press the docking button to send it back to the docking station.

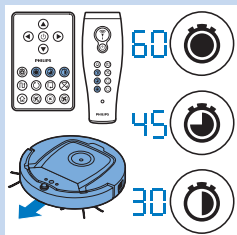

- The other cleaning time buttons allow you to let the robot operate for 60, 45 and 30 minutes respectively. When the cleaning time is finished, the robot automatically returns to the docking station when it started from the docking station. If the robot started from another point in the room, press the docking button to send it back to the docking station.

Using cleaning programs

Setting clock time and day

If you want to use cleaning programs, you have to set the clock time and the day of the week on the display of the docking station first. For the pictures that belong to the steps below, see the fold-out pages at the back.

- 1** Press the set button. The set mode indicator and the clock time indicator start flashing.
- 2** Press the select button once. The hour indication starts flashing.
- 3** Use the + and - buttons on the remote control to set the hour. The set hour appears on the display.
- 4** Press the select button to confirm the hour set. The minutes indication starts flashing.
- 5** Use the + and - buttons on the remote control to set the minutes. The set minutes appear on the display.
- 6** Press the select button to confirm the minutes set. The indication 'Su' for Sunday starts flashing.
- 7** Use the + and - buttons on the remote control to set the current day of the week.
- 8** Press the select button to confirm the day of the week.
- 9** Press the set button to confirm the clock time and day of the week setting. Both the set mode indicator and the clock time indicator stop flashing and turn solid.

Programming cleaning times

If you have set the time and the day of the week on the display of the docking station, you can program cleaning times for your robot. For the pictures that belong to the steps below, see the fold-out pages at the back. The programming options available are:

Program	Indication on display
Cleaning every day	All day indications are on
Cleaning on weekdays	Mo to Fri indications are on
Cleaning on 2 consecutive days	Indications of 2 days are on, e.g. Fri and Sa
Cleaning 1 day a week	Indication of selected day is on

- 1** Press the set button. The set mode indicator and the cleaning program indicator start flashing.
- 2** Press the select button once. The hour indication starts flashing.
- 3** Use the + and - buttons on the remote control to set the hour. The set hour appears on the display.
- 4** Press the select button to confirm the hour set. The minutes indication starts flashing.

- 5 Use the + and - buttons on the remote control to set the minutes. The set minutes appear on the display.
- 6 Press the select button to confirm the minutes set. The indication 'Su' for Sunday starts flashing.
- 7 Use the + and - buttons on the remote control to toggle between cleaning programs (see the table above for the programming options available).
- 8 Press the select button to confirm the program selected.
- 9 Press the set button to confirm the programming. Both the set mode indicator and the cleaning program indicator stop flashing and turn solid.
- 10 When you have set a cleaning program, the display shows the cleaning program indicator and the day or days selected. If you leave the robot on standby and its rechargeable battery is fully charged, it will start cleaning at the programmed time on the programmed day or days.

Fan speed buttons (FC8820)

You can use the fan speed buttons to increase the fan speed to turbo or to switch off the fan. The default setting is normal fan speed.

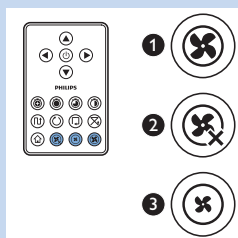

- 1 Turbo fan speed increases the suction power of the robot.
- 2 You can switch off the fan by pressing this button.
- 3 Press this button for normal fan speed.

Clap response

- When all icons on the display flash, the robot is malfunctioning. To stop the icons flashing and see what is wrong, clap your hands once. This makes the error code appear on the display. See chapter 'Error codes' for the explanation of what these error codes mean.

Using the dry wipe attachment

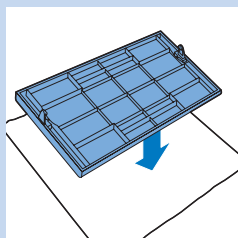

The dry wipe attachment is a feature that allows you to clean hard floors with dry wipes.

Preparing the dry wipe attachment for use

- 1 Turn the robot upside down and place it on the floor or on a table.
- 2 Place the dry wipe on a table and place the dry wipe attachment on the wipe with its fixation lugs pointing towards you.

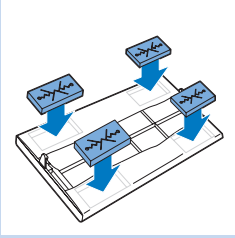

- 3 Fold both ends of the dry wipe around the dry wipe attachment and fasten the dry wipe onto the attachment by pushing the fixation blocks into the recesses.

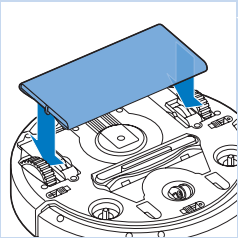

- 4 Insert the fixation lug of the dry wipe attachment into the opening just behind the wheel on one side of the robot and push until you hear it lock into place with a click. Then repeat these actions on the other side.
- 5 Turn the robot and place it on the floor on its wheels with the dry wipe attachment touching the floor.

Using the robot with the dry wipe attachment

When the dry wipe attachment is attached, you can use the robot in any mode and on all hard floors. Do not use the dry wipe attachment on carpet or rugs.

Removing the dry wipe attachment

Remove the dry wipe attachment as soon as you have finished wiping the floor.

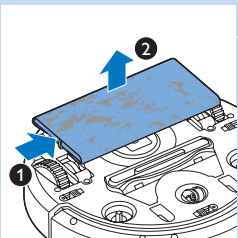

- 1 Turn the robot upside down and place it on the floor or on a table.
- 2 Push one end of the dry wipe attachment towards the wheel on the other side of the robot to release it. Then pull the attachment off the robot.

Using the pointer (FC8820)

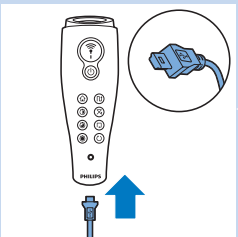

Charging the pointer

The pointer has a rechargeable battery that can be charged with the USB cable supplied.

- 1 Insert the micro-USB plug into the socket in the bottom of the pointer.
- 2 Insert the USB plug into a USB charger or a USB port on your laptop.

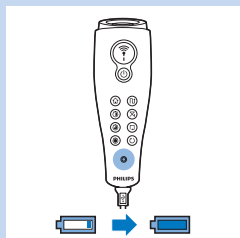

- 3** The charging light on the pointer lights up solid. Charging takes 30 minutes. When the charging light goes off, the rechargeable battery is fully charged.

Navigating the robot with the pointer

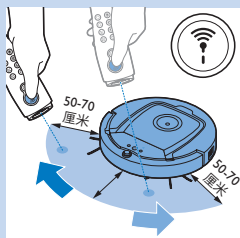

- When you press and hold the pointer button, the pointer emits a beam of infrared light. With this beam you can drag the robot in a particular direction. As long as you keep the button pressed and keep pointing in the direction you want the robot to move, it continues to move in that direction. When you release the pointer button, the robot starts cleaning in auto cleaning mode.

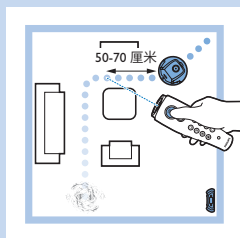

- With the pointer you can send the robot to a specific area in the room to give this area an extra-thorough clean.

Using the virtual wall unit (FC8820)

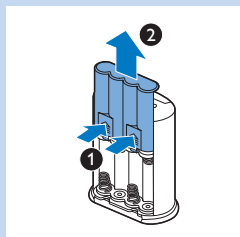

Placing the batteries in the virtual wall unit

The virtual wall unit operates on four AA batteries.

- 1** Push the two release tabs at the bottom of the back cover (1) and slide the back cover upwards and off the virtual wall unit (2).

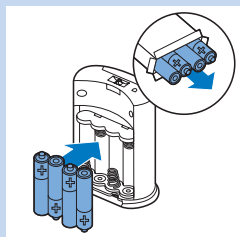

- 2** Take four new AA batteries from the pack and insert them into the battery compartment of the virtual wall unit.

Note: Make sure the + and - poles of the batteries point in the right direction.

- 3** Slide the back cover onto the virtual wall unit again.

Positioning the virtual wall unit to stop the robot

You can use the virtual wall unit to prevent the robot from entering a room or area that you want to keep it out of.

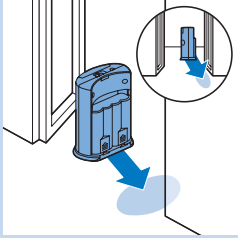

- 1 Place the unit at a spot beyond which you do not want the robot to go, e.g near an open door to a room that is off-limits to the robot or at the top of a staircase.

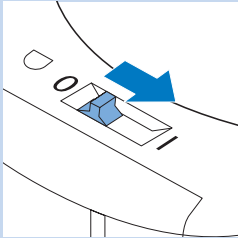

- 2 Switch on the virtual wall unit with the on/off slide on top of the unit.
- 3 Switch on the robot for a normal cleaning run.

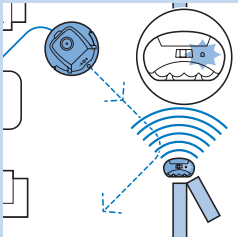

- 4 When the robot comes too close to the virtual wall unit, the light on the virtual wall unit starts flashing and the virtual wall unit emits a beam of infrared light. This beam of infrared light makes the robot change its course and move away from the virtual wall unit.

Cleaning and maintenance

Emptying and cleaning the dust container

Empty and clean the dust container when the dust container full icon on the display of the robot lights up.

- 1 Remove the top cover.

Note: Make sure the power switch is in 'off' position.

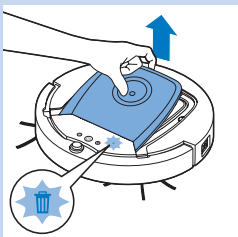

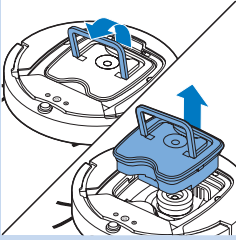

- 2** Pull up the handle of the dust container lid and lift the dust container out of the dust container compartment.

Note: When you remove or reinsert the dust container, take care not to damage the blades of the motor fan.

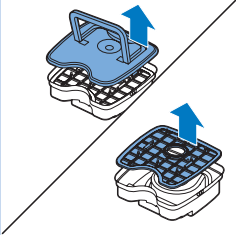

- 3** Carefully lift the lid off the dust container and take out the filter.

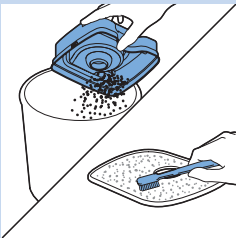

- 4** Shake the dust container over a dustbin to empty it. Clean the filter and the inside of the dust container with a cloth or a toothbrush with soft bristles. Also clean the suction opening in the bottom of the dust container.

Caution: Do not clean the dust container and the filter with water or in the dishwasher.

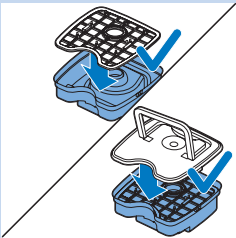

- 5** Put the filter back into the dust container. Then place the lid on the dust container.

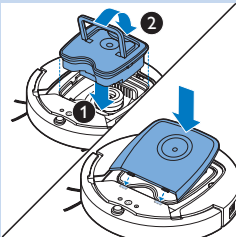

- 6** Put the dust container back into the dust container compartment and put the top cover back onto the robot.

Caution: Always make sure the filter is present inside the dust container. If you use the robot without the filter inside the dust container, the motor will be damaged.

Cleaning sensors, wheels and side brushes

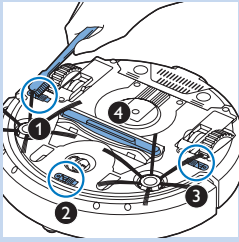

To maintain good cleaning performance, you have to clean the drop-off sensors, the wheels and the side brushes from time to time.

- 1 Make sure the power switch is in 'off' position.
- 2 Place the robot upside down on a flat surface.
- 3 Use a brush with soft bristles (e.g. a toothbrush) to remove dust or fluff from the drop-off sensors. Also check if there is any dirt or fluff blocking the suction opening.

Note: It is important that you clean the drop-off sensors regularly. If the drop-off sensors are dirty, the robot may fail to detect height differences.

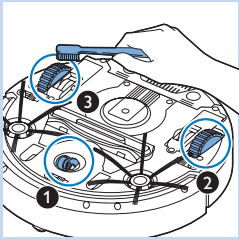

- 4 Use a brush with soft bristles (e.g. a toothbrush) to remove dust or fluff from the front wheel and side wheels.

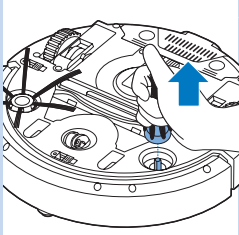

- 5 To clean the side brushes, grab them by the bristles and pull them off their shafts.

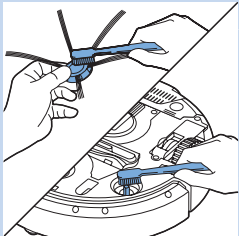

- 6 Remove fluff, hairs and threads from the shaft and from the side brush with a soft brush (e.g. a toothbrush) or a cloth.
- 7 Check the side brushes and the bottom of the robot for any sharp objects that could damage your floor.

Replacement

You can order spareparts and accessories at www.shop.philips.com/service or at your Philips dealer. You can also contact the Philips Consumer Care Centre in your country.

Replacing the filter

Replace the filter if it is very dirty or damaged. You can order a new filter under order number CP0109. See 'Emptying and cleaning the dust container' in chapter 'Cleaning and maintenance' for instructions on how to remove the old filter from the dust container and how to place a new filter in the dust container.

Replacing the side brushes

Replace the side brushes after some time to ensure proper cleaning results.

Note: Always replace the side brushes when you notice signs of wear or damage. We also recommend that you replace both side brushes at the same time. You can order spare side brushes as a set under order number CP0107.

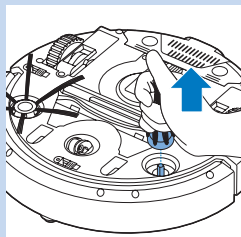

- 1 Make sure that the power switch is in 'off' position.
- 2 To replace the side brushes, grab the old side brushes by the bristles and pull them off their shafts.

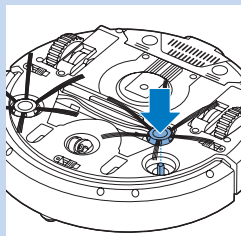

- 3 Push the new side brushes onto the shafts.

Replacing the rechargeable battery

Replace the rechargeable battery when you can no longer recharge it or when it runs out of power quickly. You can order a new rechargeable battery under order number CP0113 for FC8820 and order number CP0112 for FC8810.

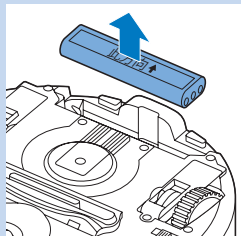

- 1 Let the robot run until the rechargeable battery is empty to make sure that the rechargeable battery is completely discharged before you remove it and dispose of it.
- 2 Push and slide the battery cavity cover off the robot and take out the old rechargeable battery.

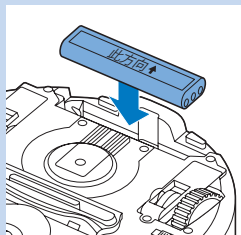

- 3 Place the new rechargeable battery in the battery cavity and slide the battery cavity cover back onto the robot.

Replacing the battery of the remote control

The remote control works on a CR2025 coin-shaped battery. Replace the battery when the robot no longer responds when you press the buttons on the remote control.

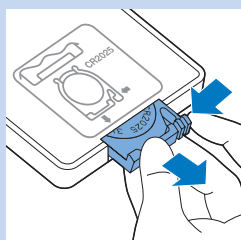

- 1 Hold the remote control upside down. Push the release button on the battery holder and at the same time slide the battery holder out of the remote control.

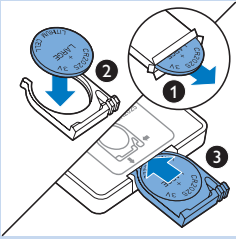

- Remove the empty battery from the battery holder and place a new battery in the battery holder. Then slide the battery holder back into the remote control.

Ordering new dry wipes

You can order new dry wipes under order number CP0123.

Troubleshooting

This chapter summarises the most common problems you could encounter with this appliance. If you are unable to solve the problem with the information below, visit www.philips.com/support for a list of frequently asked questions or contact the Consumer Care Centre in your country.

Problem	Cause	Solution
The robot does not start cleaning when I press the on/off button.	The rechargeable battery is empty.	Charge the rechargeable battery (see chapter 'Preparing for use').
	The small plug is still inserted in the socket on the robot.	The robot does not work on mains power. It only works on its rechargeable battery. Therefore, always disconnect the adapter from the robot and the mains before use.
E1 is on the display.	One or both wheels are stuck.	Set the on/off switch to 'off'. Remove the fluff, hair, thread or wire that is caught around the wheel suspension.
	One or both side brushes are stuck.	Clean the side brushes (see chapter 'Cleaning and maintenance').
E2 is on the display.	The top cover is not present or is not closed properly.	When the top cover is not present or is not closed properly, the robot does not work. Place the top cover on the robot properly.
E3 is on the display.	The bumper is stuck.	Press the on/off button to stop the robot. Lift the robot so that its bumper comes free.
E4 is on the display.	The robot was lifted while it was cleaning.	Press the on/off button to stop the robot. Then press the on/off button again to make the robot resume cleaning normally.
E5 is on the display.	The robot is cleaning a dark or black surface, which triggers the drop-off sensors. This causes the robot to move in an unusual pattern.	Press the on/off button and then move the robot to a lighter coloured piece of the floor. If the problem continues to occur on lighter coloured floors, go to www.philips.com/support or contact the Consumer Care Centre in your country.

Problem	Cause	Solution
	The robot is cleaning a floor that reflects sunlight quite strongly. This triggers the drop-off sensors and causes the robot to move in an unusual pattern.	Close the curtains to block sunlight from entering the room.
E6 is on the display.	The rechargeable battery has not been inserted correctly.	See chapter 'Before first use' for instructions on how to insert the rechargeable battery.
	The power switch is set to 'off' while the robot is on the docking station.	Set the power switch to 'on'.
The robot does not clean properly.	The bristles of one or both side brushes are crooked or bent.	Soak the brush or brushes in warm water for a while. If this does not restore the bristles to their proper shape, replace the side brushes. See chapter 'Replacement' for instructions on how to replace the side brushes.
	The filter in the dust container is dirty.	Clean the filter in the dust container with a cloth or a toothbrush with soft bristles.
		If brushing does not help to clean the filter, replace the filter with a new one (see chapter 'Replacement').
	The suction opening in the bottom of the dust container is clogged.	Clean the suction opening (see chapter 'Cleaning and maintenance').
	The front wheel is jammed with hair or other dirt.	Clean the front wheel (see chapter 'Cleaning and maintenance').
The battery can no longer be charged or runs empty very fast.	The rechargeable battery has reached the end of its life.	Replace the rechargeable battery (see chapter 'Replacement').
The battery of the remote control runs empty too fast.	Perhaps you did not insert the correct type of battery.	For the remote control, you need a CR2025 coin-shaped battery. If the problem persists, go to www.philips.com/support or contact the Consumer Care Centre in your country.

Error codes

Error code	Possible cause	Solution
E1	Wheels stuck	Remove the robot from the obstacle and press the on/off button to resume cleaning.
E2	Top cover or dust container not placed properly	Place the dust container in and the top cover on the robot properly. The error code disappears from the display automatically.
E3	Bumper stuck	Remove the robot from the obstacle. The error code disappears from the display automatically.
E4	Robot lifted up from floor	Put the robot back on the floor to make the error code disappear.
E5	Colour of floor too dark	Place the robot on a lighter area of the floor. Clean the drop-off sensors.
E6	Battery not inserted properly	Read the instructions in 'Inserting the rechargeable battery into the robot' in chapter 'Before first use'.
	Charging error	Check if the power switch is in 'on' position when the robot is on the docking station.

简介

感谢您的惠顾，欢迎光临飞利浦！为了您能充分享受飞利浦提供的支持，请在 www.philips.com/welcome 上注册您的产品。

您的吸尘器 (图 1)

- 1 集尘桶盖手柄
- 2 集尘盒盖
- 3 过滤网
- 4 集尘桶
- 5 上盖
- 6 错误代码表
- 7 风扇
- 8 缓冲型
- 9 开/关按钮（打开智能自动真空吸尘器或切换至待机模式）
- 10 电源开关（打开或关闭智能自动真空吸尘器）
- 11 前轮
- 12 侧毛刷轴
- 13 跌落传感器
- 14 滚轮
- 15 电池仓
- 16 吸口
- 17 侧毛刷
- 18 可充电电池
- 19 电池仓盖
- 20 干巾固定块
- 21 干巾架
- 22 干巾
- 23 电池舱
- 24 遥控器
- 25 充电线
- 26 指针
- 27 虚拟墙装置
- 28 底座
- 29 适配器
- 30 小插头

显示和控制面板

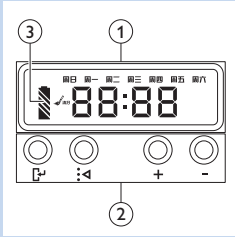

底座的控制面板

- 1 带时间、日期和设定指示的显示屏
- 2 调节和设置按钮
- 3 电量不足指示

遥控器

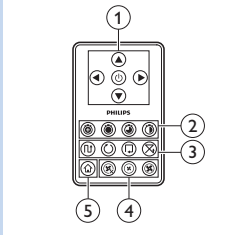

- 1 导航按钮和开/关
- 2 清洁时间按钮
- 3 清洁模式按钮
- 4 风速按钮
- 5 插接按钮

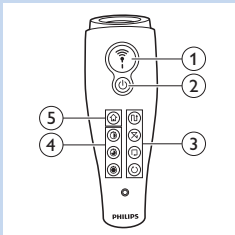

引导器 (FC8820)

- 1 引导器按钮
- 2 开/关按钮
- 3 清洁模式按钮
- 4 清洁时间按钮
- 5 插接按钮

吸尘器如何工作

吸尘器清洁哪些物体

本吸尘器具有许多功能，是一款适合帮助您在家中清洁地板的理想清洁工具。

智能自动真空吸尘器尤其适合清洁硬地板，如木地板、陶瓷地板或油毡地板。清洁软地板时可能会出现问题，例如地毯或小地毯。如果您在地毯或小地毯上使用智能自动真空吸尘器，首次使用时请守在旁边，看智能自动真空吸尘器是否能清洁此类地板。清洁反光的黑色硬地板时也需要有人监管。

吸尘器如何清洁

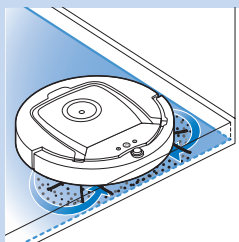

清洁系统

智能自动真空吸尘器具有 3 重清洁系统来高效清洁地板。

- 两个侧毛刷帮助吸尘器清洁角落和沿墙部分，而且还可帮助松动地板上的污垢。

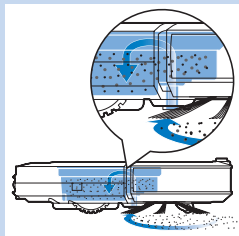

- 吸尘器的吸力可吸入松动的污垢，然后通过吸口将污垢输送到集尘桶。
- 智能自动真空吸尘器配有干巾架，用干巾可以更彻底地清洁硬地板。

清洁方向图

在自动清洁模式下，智能自动真空吸尘器使用自动顺序清洁方向图优化清洁房间内各区域。其会使用以下清洁方向图：

- 1 Z 方向图或之字形方向图
- 2 随机方向图
- 3 沿墙方向图
- 4 螺旋方向图

在自动清洁期间，智能自动真空吸尘器以固定顺序使用这些方向图：

- 1 Z 方向图

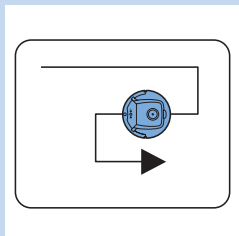

- 2 随机方向图

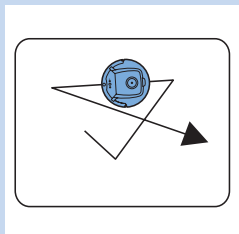

- 3 沿墙方向图

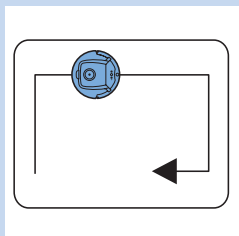

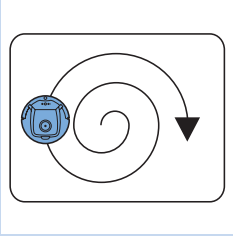

4 螺旋方向图

- 如果智能自动真空吸尘器已完成此顺序的方向图，则将重新以乙方向图开始移动。智能自动真空吸尘器继续使用该顺序的方向图清洁房间，直至充电电池的电量耗尽或将其手动关闭。
- 如果智能自动真空吸尘器在清洁操作时检测到特别脏的区域，其会切换至螺旋模式和强力风速以确保彻底清除污垢。

注意：您也可以按遥控器或引导器上的相应按钮，单独选择各模式（仅限于 FC8820）。有关详细信息，请参阅“使用智能自动真空吸尘器”中的“清洁模式”部分。

智能自动真空吸尘器如何避开高度差

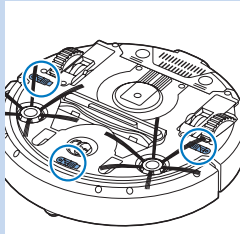

- 智能自动真空吸尘器底部具有三个跌落传感器。其使用这些跌落传感器检测和避开楼梯等高度差。

注意：智能自动真空吸尘器轻轻移动以越过高度差的边缘是正常现象，因为正面的跌落传感器位于缓冲装置后面。

警告：在某些情况下，跌落传感器可能无法及时检测到楼梯或其他高度差。因此，在最初几次使用以及在楼梯或其他高度差附近使用时，要仔细监控智能自动真空吸尘器的工作。

首次使用之前

安装侧毛刷

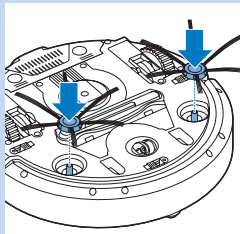

- 1 打开侧毛刷包装，将智能自动真空吸尘器正面朝下置于桌子或地板上。
- 2 将侧毛刷推入吸尘器底部的轴上。

注意：确保您已正确安装侧毛刷。将侧毛刷按在轴上，直到您听到其咔哒一声锁定到位。

将充电电池装入智能自动真空吸尘器

使用前，您必须插入充电电池。

1 按电池仓盖上的棱纹部分以将其解锁。

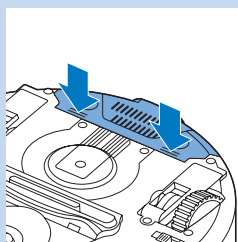

2 将电池仓盖从智能自动真空吸尘器中滑出。

3 取下充电电池上的塑料。

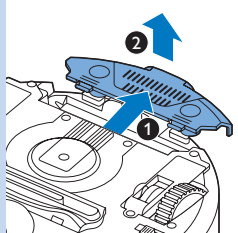

4 将充电电池放入电池仓。

注意：确保电池印刷面朝上，触点方向正确。

5 将电池仓盖滑回智能自动真空吸尘器。

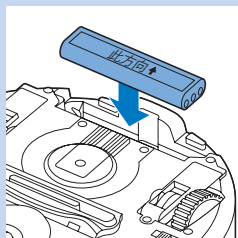

取下遥控器上的保护贴

遥控器由 CR2025 纽扣电池供电。
该电池采用保护贴保护，使用前须取下。

1 抽出遥控器电池仓中的电池保护贴。

2 遥控器就可以使用了。

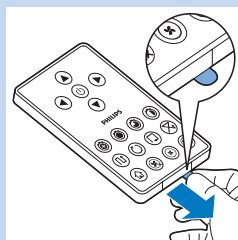

使用准备

安装底座

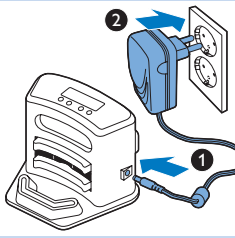

- 1 将适配器的小插头插入底座上的插孔 (1)，然后将适配器插入电源插座 (2)。底座的显示屏会亮起。

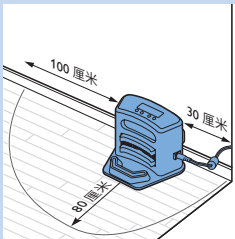

- 2 将底座放在靠墙的水平地板上。

提示：为确保底座牢固地保持在选定位置，您可以用螺钉或两条双面胶带将其固定在墙上。

注意：确保底座正面 80 厘米、右侧 30 厘米、左侧 100 厘米没有障碍物或高度差。

充电

首次为充电电池充电及电池电量耗尽时，需充电 4 小时。

智能自动真空吸尘器可使用两种方式充电：

- 使用期间在底座上手动或自动充电；
- 将智能自动真空吸尘器直接连接至电源

注意：充电电池充满电后，智能自动真空吸尘器可以清洁长达 100 分钟。

在底座上充电

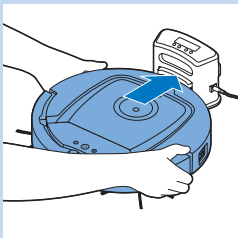

- 1 将智能自动真空吸尘器置于接电的底座上。

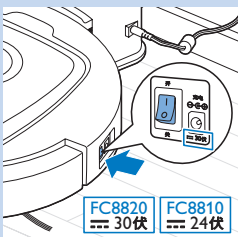

- 2 按电源开关打开智能自动真空吸尘器。

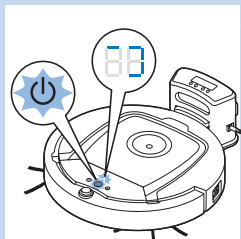

- 3 底座显示屏上的电池电量指示灯和智能自动真空吸尘器开/关按钮的指示灯将开始闪烁。

注意：因为这是首次充电，智能自动真空吸尘器的显示屏会显示启动标志。

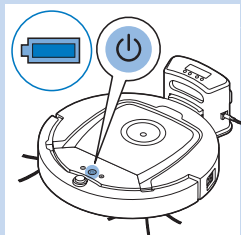

- 4 当充电电池充满电时，底座显示屏上的电池电量指示灯和智能自动真空吸尘器开/关按钮的指示灯将停止闪烁。

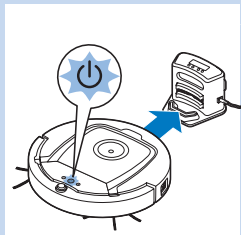

使用期间自动充电

- 1 当智能自动真空吸尘器完成清洁或电池电量只剩15%时，其会自动返回底座进行充电。返回底座后，开/关按钮的指示灯将快速闪烁。
- 2 将智能自动真空吸尘器正确置于底座上时，底座显示屏上的电池电量指示灯会开始闪烁。
- 3 当充电电池充满电时，底座显示屏上的电池电量指示灯和智能自动真空吸尘器开/关按钮的指示灯将停止闪烁。

注意：只有从底座开始清洁时，智能自动真空吸尘器才会自动返回底座。

直接插电充电

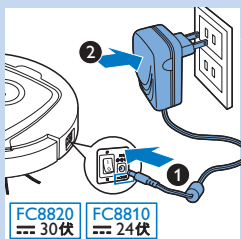

- 1 将适配器的小插头插入智能自动真空吸尘器的插座(1)。将适配器插入电源插座(2)。
- 2 按电源开关打开智能自动真空吸尘器。
- 3 当智能自动真空吸尘器正确连接至电源时，智能自动真空吸尘器开/关按钮的指示灯将开始闪烁。这表示充电电池正在充电。
- 4 充电电池充满电后，智能自动真空吸尘器的开/关按钮的指示灯将停止闪烁。

FC8820
30伏

FC8810
24伏

准备房间以进行清洁操作

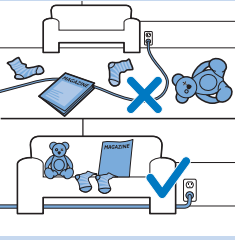

- 在启动智能自动真空吸尘器进行清洁操作之前，确保清除地板上的所有松散和易碎物体。

使用吸尘器

开始和停止

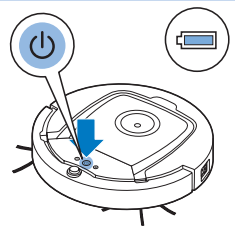

- 1 按开/关按钮。开/关按钮的指示灯亮起，智能自动真空吸尘器开始清洁。
 - 您可以按智能自动真空吸尘器上的开/关按钮。

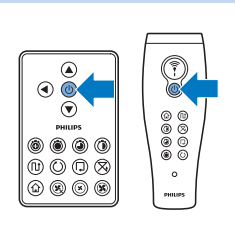

- 您也可以按遥控器或引导器上的开关按钮 (FC8820)。

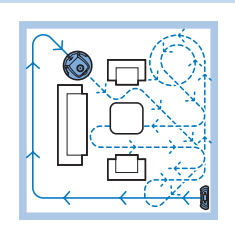

- 2 除非您按任一模式按钮，否则智能自动真空吸尘器会以自动清洁模式继续清洁，直至电池电量不足为止。在自动模式下，其按照 Z 方向图、随机、沿墙和螺旋移动的重复顺序进行清洁。有关清洁模式的详细信息，请参阅“清洁模式”部分。

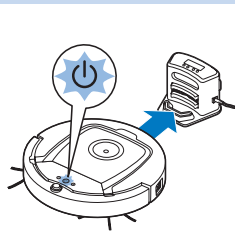

- 3 如果电池电量不足，开/关按钮的指示灯将开始闪烁，智能自动真空吸尘器会返回底座进行充电。

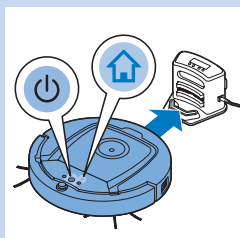

4 您也可以按开/关按钮中断或停止清洁操作。如果再次按开/关按钮且充电电池仍有足够的电量，则智能自动真空吸尘器将继续以自动清洁模式进行清洁。

5 您也可以按遥控器或引导器上的插接按钮，使智能自动真空吸尘器在充电电池电量不足前返回底座 (FC8820)。智能自动真空吸尘器显示屏上的插接指示灯会亮起，其会返回底座。

注意： 如果您未从底座启动智能自动真空吸尘器，其不会在充电电池电量不足时自动返回底座。如果充电电池仍有足够的电量，您可以按插接按钮使其返回底座。如果充电电池的电量完全耗尽，则必须将其手动放回底座。

清洁模式

除了自动清洁模式，该智能自动真空吸尘器还提供四种单独清洁模式，每种模式均可通过按相应按钮启动。

Z 方向图模式

- 在 Z 方向图模式下，智能自动真空吸尘器将在整个房间中进行 Z 形环状运动以清洁大片区域。

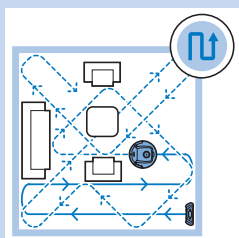

随机模式

- 在该模式下，智能自动真空吸尘器将使用直线运动和交叉运动的混合模式清洁房间。

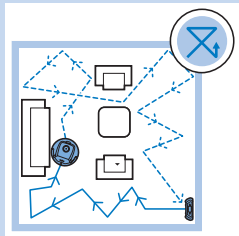

沿墙模式

- 在该模式下，智能自动真空吸尘器将沿着房间的墙壁对墙边区域进行特别清洁。

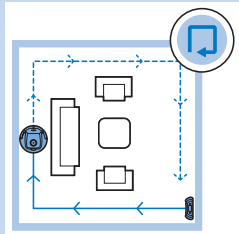

螺旋模式

- 在该模式下，智能自动真空吸尘器将以强力风速进行螺旋运动，对脏污区进行彻底清洁。

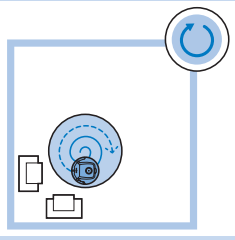

手动驱动

- 1 使用遥控器开/关按钮的上、下、左、右箭头按钮在房间内对智能自动真空吸尘器进行导航。

注意：请勿在智能自动真空吸尘器靠近高度差或楼梯时按向下箭头。

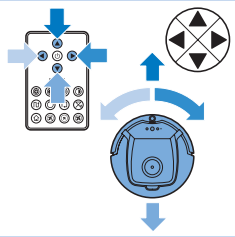

使用清洁时间按钮

- 按最长清洁时间按钮以使智能自动真空吸尘器在自动模式下清洁，直至充电电池电量不足为止。智能自动真空吸尘器完成清洁后，如果是从底座开始清洁，则其会自动返回底座。如果智能自动真空吸尘器从房间内其他位置开始清洁，则需按插接按钮才能使其返回底座。

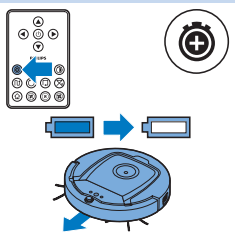

按其他清洁时间按钮可使智能自动真空吸尘器分别运行 60、45 和 30 分钟。清洁时间结束后，如果智能自动真空吸尘器是从底座开始清洁，则会自动返回底座。如果智能自动真空吸尘器从房间内其他位置开始清洁，则需按插接按钮才能使其返回底座。

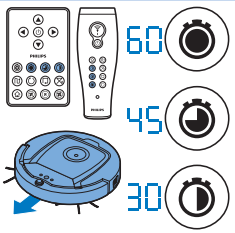

使用清洁程序

设置时钟时间和日期

如果您要使用清洁程序，则必须先底座显示屏上设置时钟时间和星期几。要查看以下步骤的图片，请参阅后面的折页。

- 1** 按设置按钮。设置模式标志和时钟时间标志将开始闪烁。
- 2** 按一次选择按钮。小时显示将开始闪烁。
- 3** 使用遥控器上的 + 和 - 按钮设置小时。显示屏上会显示设置的小时。
- 4** 按选择按钮可确认小时设置。分钟显示将开始闪烁。
- 5** 使用遥控器上的 + 和 - 按钮设置分钟。显示屏上会显示设置的分钟。
- 6** 按选择按钮可确认分钟设置。代表周日的“Su”显示将开始闪烁。
- 7** 使用遥控器上的 + 和 - 按钮可设置当前星期几。
- 8** 按选择按钮可确认星期几。
- 9** 按设置按钮可确认时钟时间和星期几设置。设置模式标志和时钟时间标志将停止闪烁，然后持续亮起。

设定清洁时间

如果您已经在底座显示屏上设置了时间和星期几，则可以为智能自动真空吸尘器设定清洁时间。要查看以下步骤的图片，请参阅后面的折页。可用设定选项：

设定	显示屏上的指示
每天清洁	全天指示亮起
工作日清洁	周一至周五指示亮起
连续清洁 2 天	2 天指示亮起，例如周五和周六
一周清洁 1 天	选定的日期指示亮起

- 1 按设置按钮。设置模式标志和清洁设定标志将开始闪烁。
- 2 按一次选择按钮。小时显示将开始闪烁。
- 3 使用遥控器上的 + 和 - 按钮设置小时。显示屏上会显示设置的小时。
- 4 按选择按钮可确认小时设置。分钟显示将开始闪烁。
- 5 使用遥控器上的 + 和 - 按钮设置分钟。显示屏上会显示设置的分钟。
- 6 按选择按钮可确认分钟设置。代表周日的“Su”显示将开始闪烁。
- 7 使用遥控器上的 + 和 - 按钮可在清洗程序之间切换（有关可用设定选项，请参阅上表）。
- 8 按选择按钮确认选定的程序。
- 9 按设置按钮确认设定。设置模式标志和清洁程序标志停止闪烁，然后持续亮起。
- 10 设置清洁程序后，显示屏会显示选定的清洁程序标志和日期。如果使智能自动真空吸尘器处于待机状态且充电电池已充满电，其便会在设定日期的设定时间开始清洁。

风速按钮 (FC8820)

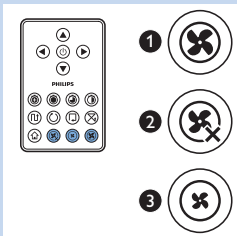

您可以使用风速按钮将风速提升至强力或关闭风扇。默认设置为正常风速。

- 1 强力风速可增加智能自动真空吸尘器的吸力。
- 2 按该按钮可以关闭风扇。
- 3 按该按钮可获得正常风速。

拍手响应

- 当显示屏上的所有图标闪烁时，表明智能自动真空吸尘器出现了故障。要使图标停止闪烁并判断问题所在，可以拍一下手。这会使错误代码出现在显示屏上。有关这些错误代码的含义说明，请参阅“错误代码”一章。

使用干巾附件

干巾附件是一项可以使用干巾清洁硬地板的功能。

干巾附件使用准备

- 1 将智能自动真空吸尘器翻转过来，置于地板或桌子上。
- 2 将干巾置于桌上，将干巾附件放在干巾上，固定凸缘朝向自己。
- 3 将干巾两端围绕干巾附件折起来，将固定块按入凹槽，将干巾固定在附件上。
- 4 将干巾附件的凸缘插入智能自动真空吸尘器一侧滚轮后面的开口并推入，直至其“咔哒”一声锁定到位。然后，在另一侧重复这些动作。
- 5 将智能自动真空吸尘器翻转过来放在地板上，使带有干巾附件的滚轮接触地板。

使用带干巾附件的智能自动真空吸尘器

装上干巾附件后，便可以在所有硬地板上以任何模式使用智能自动真空吸尘器。不要在地毯或小地毯上使用干巾附件。

拆卸干巾附件

擦净地板后便可以卸下干巾附件。

- 1 将智能自动真空吸尘器翻转过来，置于地板或桌子上。
- 2 将干巾附件的一端向智能自动真空吸尘器另一侧的滚轮方向推动即可将其释放。然后，拉出干巾附件。

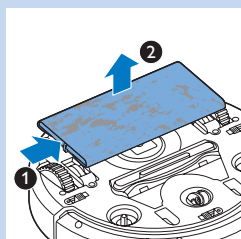
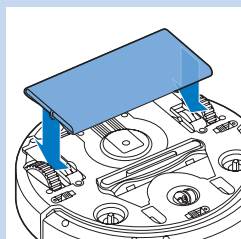
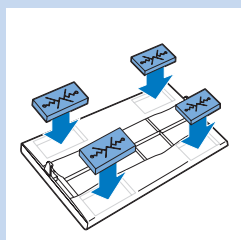
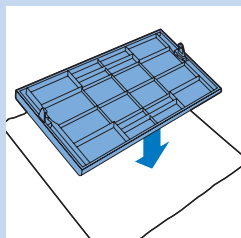

使用引导器 (FC8820)

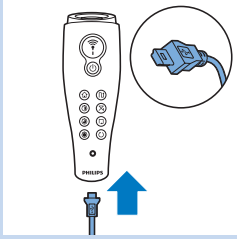

为引导器充电

引导器具有充电电池，可使用随附的 USB 线进行充电。

- 1** 将微型 USB 插头插入引导器底部的插孔。
- 2** 将 USB 插头插入 USB 充电器或笔记本电脑的 USB 端口。

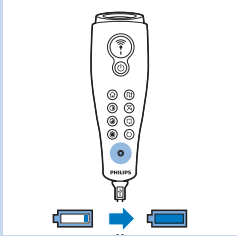

- 3** 引导器上的充电指示灯会持续亮起。充电需要 30 分钟。充电指示灯熄灭时，表明充电电池已充满电。

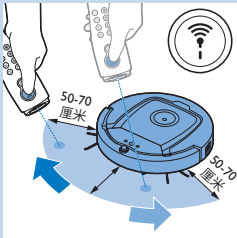

用引导器为智能自动真空吸尘器导航

- 按住引导器按钮时，它会发射红外光束。您可以用这束光以特定方向拖动智能自动真空吸尘器。只要按住按钮并保持您想要智能自动真空吸尘器移动的方向，其便会以该方向持续移动。松开引导器的按钮后，其便会以自动清洁模式开始清洁。

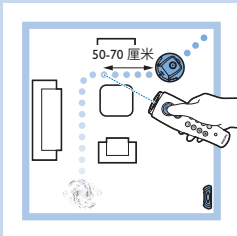

- 使用引导器可以将智能自动真空吸尘器引导至房间内的特定区域，进行彻底清洁。

使用虚拟墙装置 (FC8820)

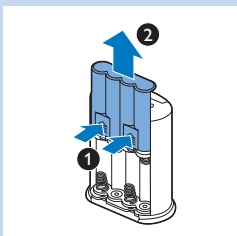

将电池装入虚拟墙装置

虚拟墙装置使用四节 AA 电池。

- 1** 推动后盖底部的两个释放钮 (1)，将后盖向上滑动，从虚拟墙装置上取下 (2)。

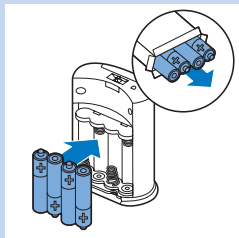

- 2 拆开四节 AA 电池的包装，将其装入虚拟墙装置的电池仓。

注意：确保电池的 + 和 - 极方向正确。

- 3 将后盖重新滑入虚拟墙装置。

定位虚拟墙装置以阻止智能自动真空吸尘器

您可以使用虚拟墙装置防止智能自动真空吸尘器进入您不想让其接近的房间或区域。

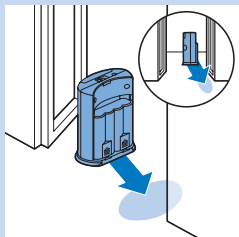

- 1 将装置置于距离您不想让智能自动真空吸尘器进入区域较远的位置，例如，置于打开的房门（禁止其进入的房间）附近或楼梯顶端。

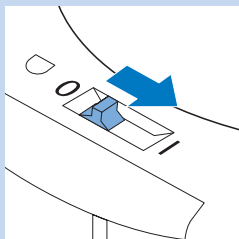

- 2 用虚拟墙装置顶部的开/关滑钮将其打开。

- 3 打开智能自动真空吸尘器进行正常清洁操作。

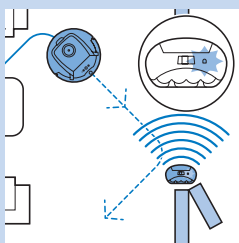

- 4 当智能自动真空吸尘器距离虚拟墙装置过近时，虚拟墙装置上的指示灯将开始闪烁，同时其会发射红外光束。该红外光束可使智能自动真空吸尘器改变移动路线，远离虚拟墙装置。

清洁和保养

倒空并清洁集尘桶

智能自动真空吸尘器上的集尘桶已满图标亮起时，倒空并清洁集尘桶。

- 1 取下上盖。

注意：确保电源开关处于“关”位置。

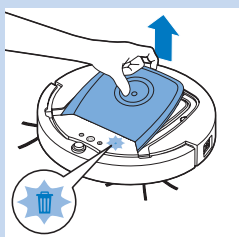

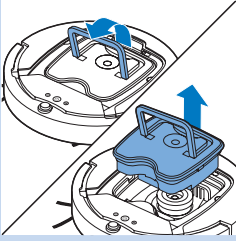

2 上拉集尘桶盖手柄，从集尘桶仓中提出集尘桶。

注意：取下或重新插入集尘桶时，小心不要损坏马达风扇的刀片。

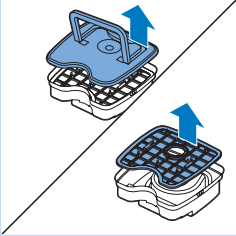

3 小心地提起集尘桶的盖子并取出滤网。

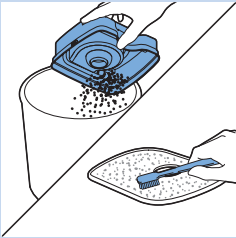

4 在垃圾箱上晃动集尘桶将其倒空。用布或软毛牙刷清洁集尘桶的滤网和内侧。同时清洁集尘桶底部的吸口。

警告：切勿用水或在洗碗机中清洁集尘桶和滤网。

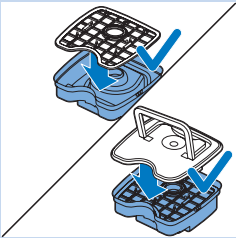

5 将滤网放回集尘桶。然后将盖子放在集尘桶上。

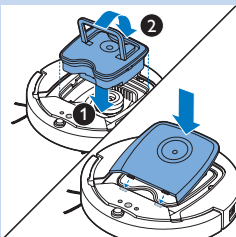

6 将集尘桶放回集尘桶仓，盖好智能自动真空吸尘器的上盖。

警告：务必确保集尘桶内已放置好滤网。如果您在集尘桶内未放置滤网的情况下使用吸尘器，马达会受到损坏。

清洁传感器、滚轮和侧毛刷

为保持良好的清洁效果，您必须经常清洁跌落传感器、滚轮和侧毛刷。

- 1** 确保电源开关处于“关”位置。
 - 2** 将吸尘器倒置在平面上。
 - 3** 使用软毛刷（例如牙刷）清除跌落传感器上的灰尘或绒毛。同时检查是否有灰尘或绒毛堵塞吸口。
- 注意：务必定期清洁跌落传感器。如果跌落传感器变脏，吸尘器可能无法检测到高度差异。
- 4** 使用软毛刷（例如牙刷）清除前轮和侧轮上的灰尘和绒毛。

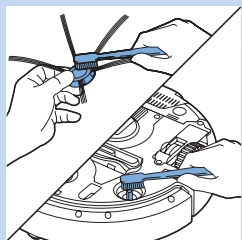
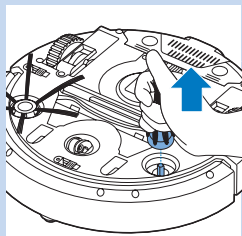
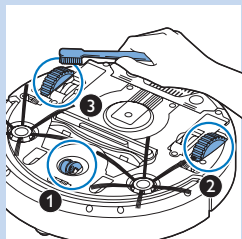
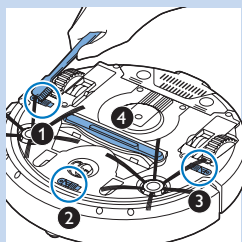

- 5** 要清洁侧毛刷，请抓住刷毛并将其从轴上取下。

- 6** 使用柔软的毛刷（例如牙刷）或布清除轴和侧毛刷中的绒毛、头毛发和线头。
- 7** 检查智能自动真空吸尘器的侧毛刷和底部是否存在可能会损坏地板的尖锐物体。

更换

您可以在 www.shop.philips.com/service 或飞利浦经销商处订购零部件和附件。也可以联系您所在国家/地区的飞利浦客户服务中心。

更换过滤器

如果滤网很脏或已损坏，请进行更换。您可以通过订购号 CP0109 订购新滤网。有关如何从集尘桶中取出旧滤网及如何放入新滤网的说明，请参阅“清洁和保养”一章中的“倒空并清洁集尘桶”。

更换侧毛刷

一段时间后，请更换侧毛刷，以确保正常的清洁效果。

注意：发现磨损或损坏迹象时务必更换侧毛刷。同时，建议您同时更换两个侧毛刷。您可以通过订购号 CP0107 订购一组备用侧毛刷。

- 1** 确保电源开关处于“关”位置。
- 2** 要更换侧毛刷，请抓住旧侧毛刷的刷毛将其从轴上取下。
- 3** 将新侧毛刷推到轴上。

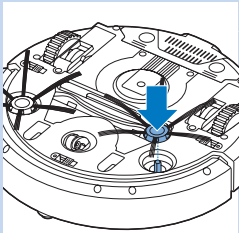
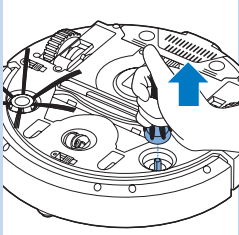

更换充电电池

当充电电池无法再充电或耗电很快时，请更换充电电池。您可以订购新充电电池，FC8820 的订购号为 CP0113；FC8810 的订购号为 CP0112。

- 1** 让智能自动真空吸尘器运转，直至充电电池电量完全耗尽，以确保在您取出并弃置充电电池前，其已完全放电。
- 2** 推动电池仓盖将其从智能自动真空吸尘器中滑出，取出旧充电电池。

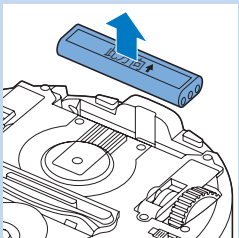

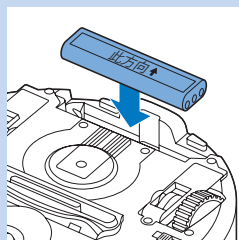

- 3 将新充电电池装入电池仓，将电池仓盖滑入智能自动真空吸尘器。

更换遥控器的电池

遥控器由 CR2025 纽扣电池供电。按遥控器上的按钮，智能自动真空吸尘器不再响应时，请更换电池。

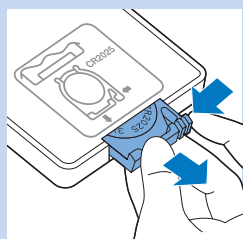

- 1 将遥控器翻转过来。推电池仓上的释放钮，同时将电池仓从遥控器中滑出。

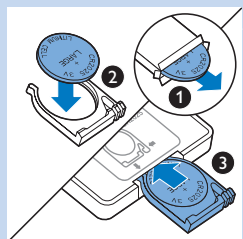

- 2 从电池仓中取出电量耗尽的电池，装入新电池。然后将电池仓滑入遥控器。

订购新干巾

您可以通过订购号 CP0123 订购新干巾。

本章归纳了使用本产品时最常见的一些问题。如果您无法根据以下信息解决问题，请访问 www.philips.com/support 查阅常见问题列表，或联系您所在国家/地区的客户服务中心。

问题	原因	解决方法
按开/关按钮时智能自动真空吸尘器无法开始清洁。	充电电池的电量已耗尽。	为充电电池充电（请参阅“使用准备”一章）。
	小插头仍插在吸尘器上的转换插座中。	吸尘器接通电源不工作。它只能通过充电电池工作。因此，使用前请务必将适配器从吸尘器和电源上断开。
显示屏上显示 E1。	一个或多个滚轮被卡住。	将开/关按钮设为“关”。清除滚轮悬架周围吸附的绒毛、毛发、线头或线丝。
	一个或两个侧毛刷被卡住。	清洁侧毛刷（请参阅“清洁和保养”一章）。
显示屏上显示 E2。	上盖不存在或未盖好。	上盖不存在或未盖好时，智能自动真空吸尘器无法工作。盖好上盖。
显示屏上显示 E3。	缓冲装置被卡住。	按开/关按钮停止智能自动真空吸尘器。将其提起以释放其缓冲装置。
显示屏上显示 E4。	清洁时吸尘器被提起。	按开/关按钮停止智能自动真空吸尘器。然后，再次按开/关按钮使其继续清洁。
显示屏上显示 E5。	吸尘器在清洁深色或黑色地板时会触发跌落传感器。这将导致吸尘器沿异常的方向图移动。	按开/关按钮，然后将智能自动真空吸尘器移至较浅色地板。如果移到较浅色地板后问题仍然存在，请转至 www.philips.com/support 或联系您所在国家/地区的客户服务中心。
	吸尘器在清洁地板时，后者强烈地反射太阳光，这可能会触发跌落传感器，导致吸尘器沿异常的方向图移动。	关闭窗帘，阻止太阳光射入房间。
显示屏上显示 E6。	充电电池没装好。	有关如何装入充电电池的说明，请参阅“首次使用之前”一章。
	智能自动真空吸尘器在底座上时，电源开关设为“关”。	将电源开关设为“开”。
吸尘器无法正确清洁。	一个或两个侧毛刷的刷毛已变形或弯曲。	将毛刷在温水中浸泡一会儿，如果这样做不能使刷毛复原，则请更换侧毛刷。有关如何更换侧毛刷的说明，请参阅“更换”一章。

问题	原因	解决方法
	集尘桶中的滤网变脏。	用布或软毛牙刷清洁集尘桶中的滤网。 如果刷洗无助于清洁滤网，请用新滤网更换（请参阅“更换”一章）。
	集尘桶底部吸口被堵塞。	清洁吸口（请参阅“清洁和保养”一章）。
	前轮被毛发或其他污垢卡住。	清洁前轮（见“清洁和保养”一章）。
电池无法充电或耗电非常快。	充电电池达到了其寿命的终点。	更换充电电池（请参阅“更换”一章）。
遥控器的电池耗电太快。	可能是您没有插入正确类型的电池。	遥控器必须使用 CR2025 纽扣电池。如果问题仍然存在，请转到 www.philips.com/support 或联系您所在国家/地区的客户服务中心。

错误代码

错误代码	可能的原因	解决方法
E1	滚轮卡住	将智能自动真空吸尘器从障碍物处移开，按开/关按钮使其继续清洁。
E2	顶盖或集尘桶未放好	放入集尘桶并盖好智能自动真空吸尘器的上盖。错误代码会从显示屏上自动消失。
E3	缓冲装置卡住	将智能自动真空吸尘器从障碍物处移开。错误代码会从显示屏上自动消失。
E4	从地板提起了智能自动真空吸尘器	将智能自动真空吸尘器放在地板上以使错误代码消失。
E5	地板颜色太暗	将智能自动真空吸尘器置于地板的浅色区。清洁跌落传感器。
E6	电池未装好	阅读“首次使用之前”一章中“将充电电池装入智能自动真空吸尘器”中的说明。
	充电错误	当智能自动真空吸尘器在底座上时，检查电源开关是否处于“开”位置。



底座充电-设置时钟

	储存
	增加
	降低
	选择

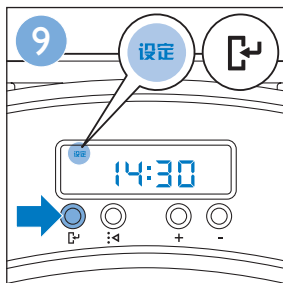
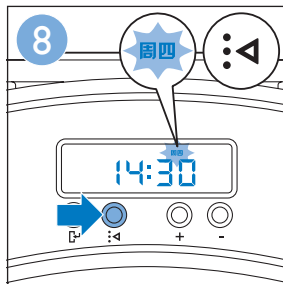
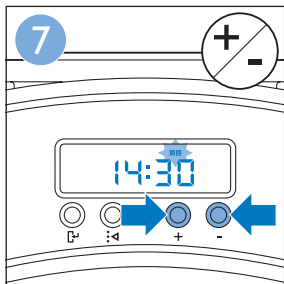
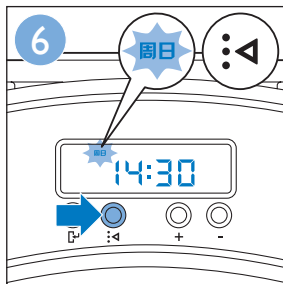
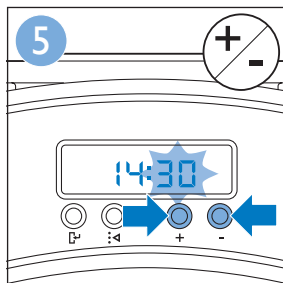
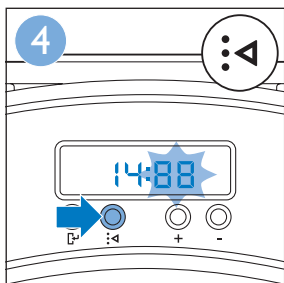
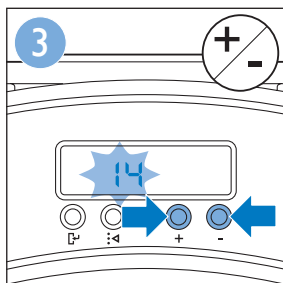
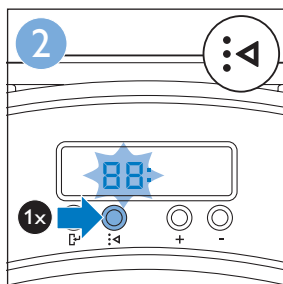
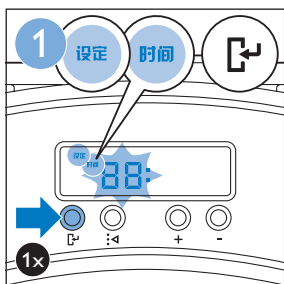



底座充电-制订清洁计划

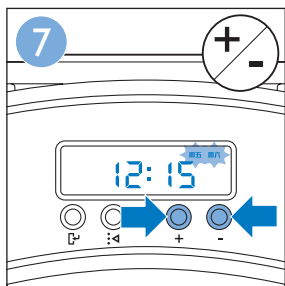
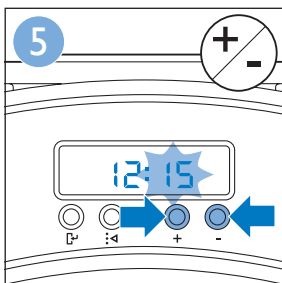
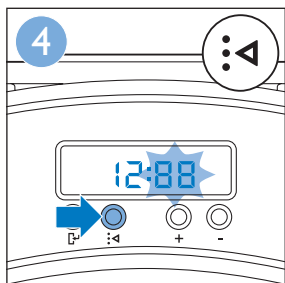
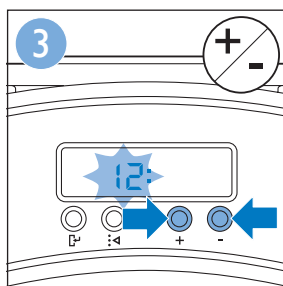
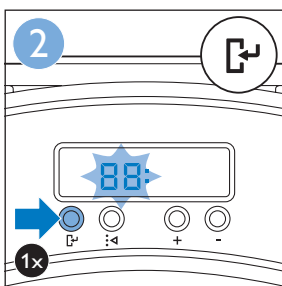
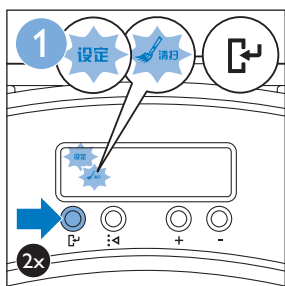

周日	周一	周二	周三	周四	周五	周六
周日	周一	周二	周三	周四	周五	周六
周日	周一	周二	周三	周四	周五	周六
周日	周一	周二	周三	周四	周五	周六
周日	周一	周二	周三	周四	周五	周六

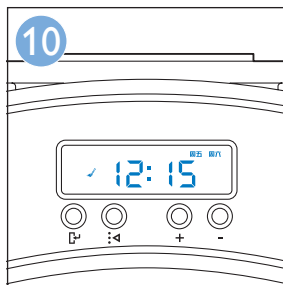
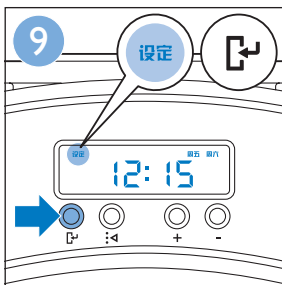





www.philips.com

 100% recycled paper
100% 循环再造纸

4222.003.4135.3