

Always there to help you

Register your product and get support at
www.philips.com/welcome



HTB3520

HTB3550

HTB3580

Quick start guide

PHILIPS



EN Before using your product, read all accompanying safety information

ZH-CN 使用产品前，请阅读所有随附的安全信息

ZH-TW 使用您的產品前，請先閱讀所有附隨的安全資訊

MS Sebelum menggunakan produk anda, baca semua maklumat keselamatan yang disertakan

TH ก่อนใช้งานผลิตภัณฑ์ของคุณ โปรดอ่านข้อมูลด้านความปลอดภัยที่มีให้โดยละเอียด



HTB3520

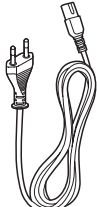
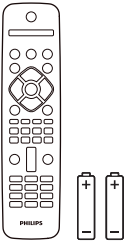
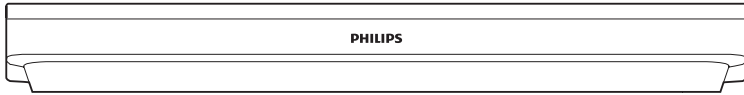

Power Cord

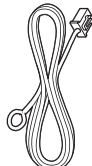

FM Antenna



HDMI

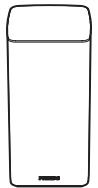
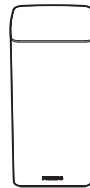
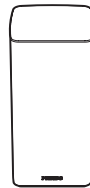
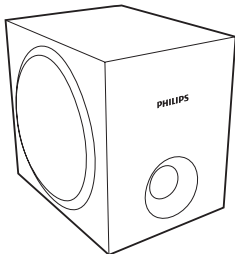
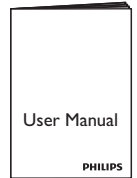

HTB3550

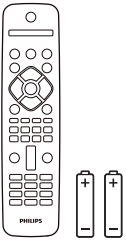
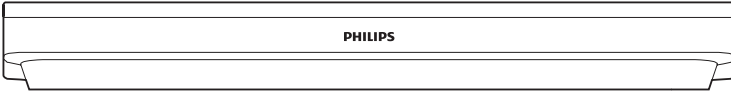

FM Antenna



HDMI

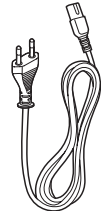

Power Cord

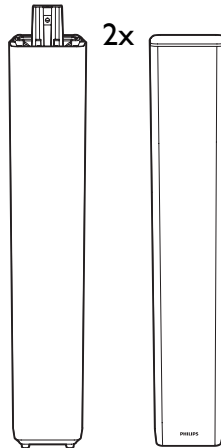
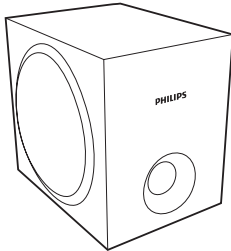

2x

2x



8x



2x

2x

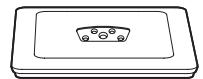
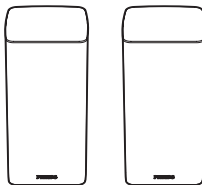

HTB3580

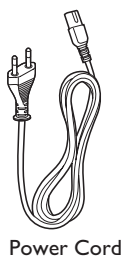
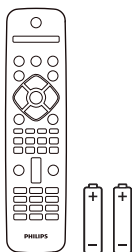
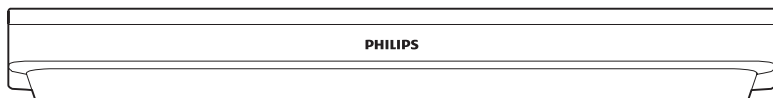

Power Cord

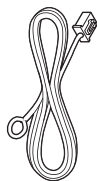

FM Antenna



HDMI

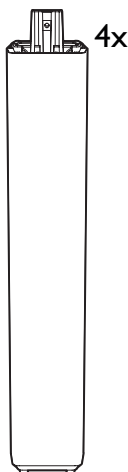
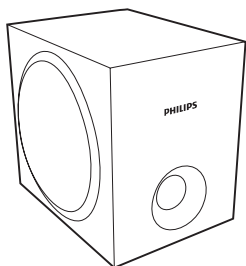
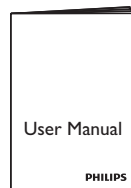

4x

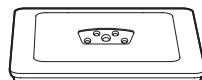

1

EN Stand mount the speakers
Applied to HTB3550 and
HTB3580 only

ZH-CN 桌架和扬声器
仅适用于 HTB3550 和 HTB3580

ZH-TW 將喇叭安裝到立架上
僅適用於 HTB3550 和 HTB3580

MS Dirikan dirian pembesar suara
Hanya digunakan pada HTB3550 dan
HTB3580 sahaja

TH วางลำโพงบนขาตั้ง
ใช้ได้กับ HTB3550 และ HTB3580
เท่านั้น

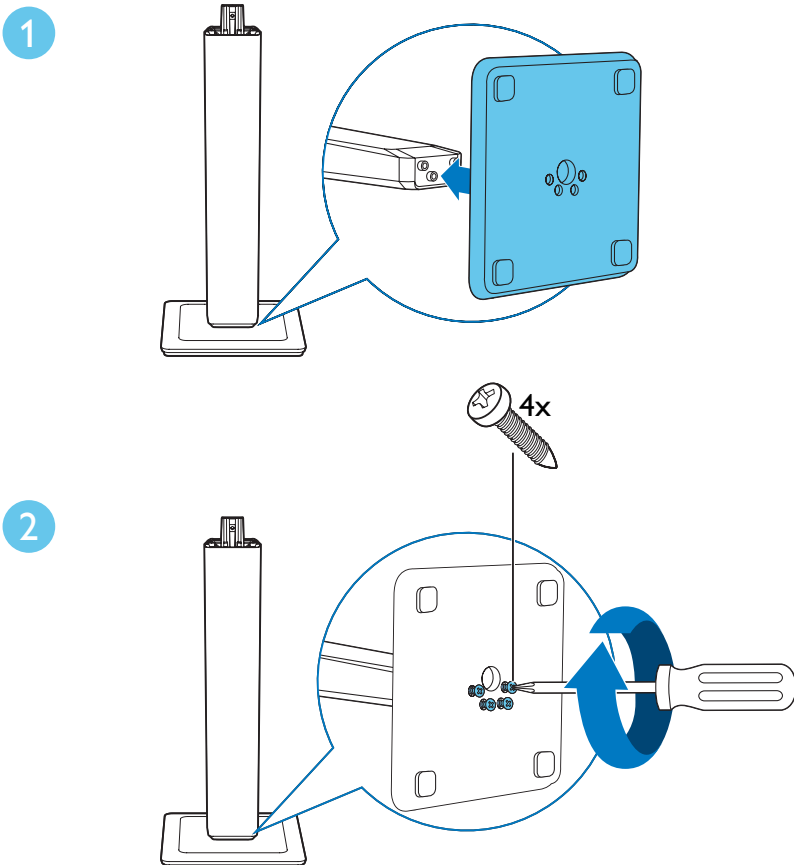

3

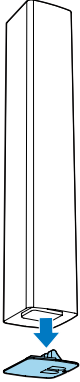

4

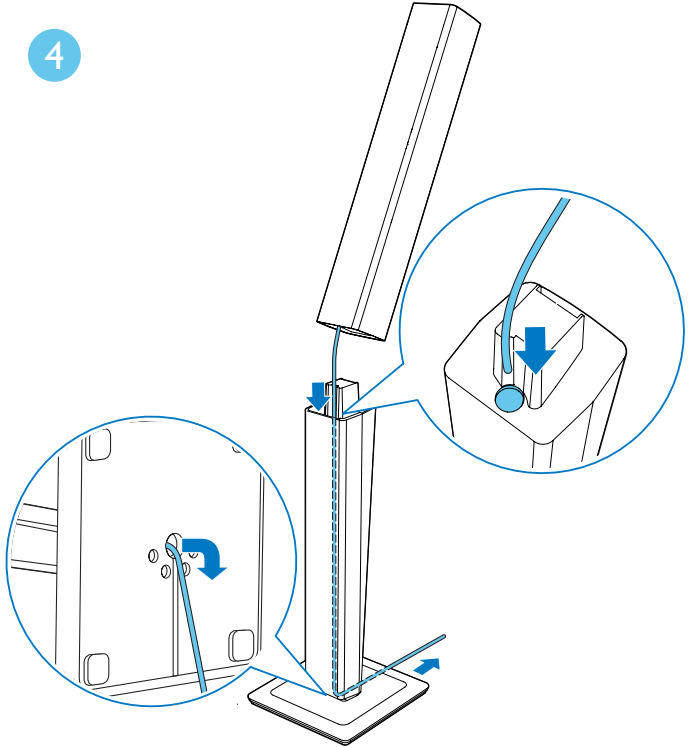

5

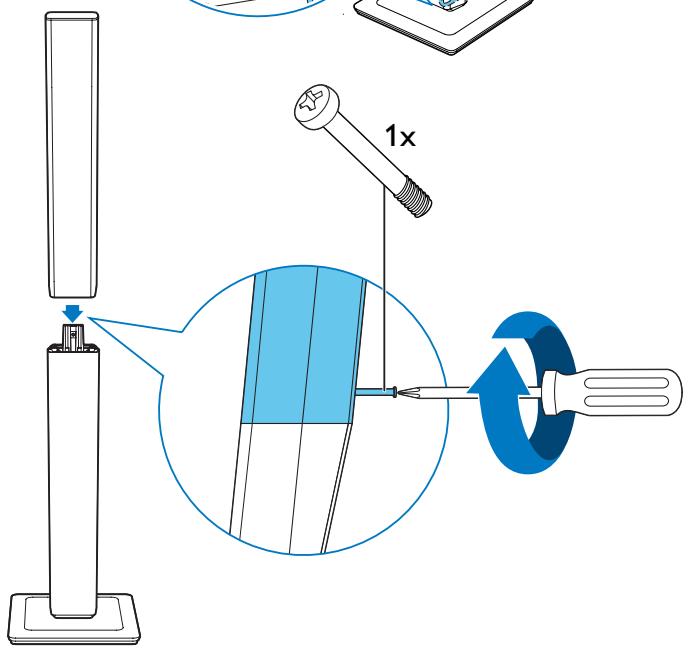

2

EN Connect and position the home theater

ZH-CN 连接和放置家庭影院

ZH-TW 連線並將家庭劇院定位擺好

MS Sambungkan dan posisikan sistem teater rumah

TH เชื่อมต่อและวางตำแหน่งโฮมเธียเตอร์

HTB3520

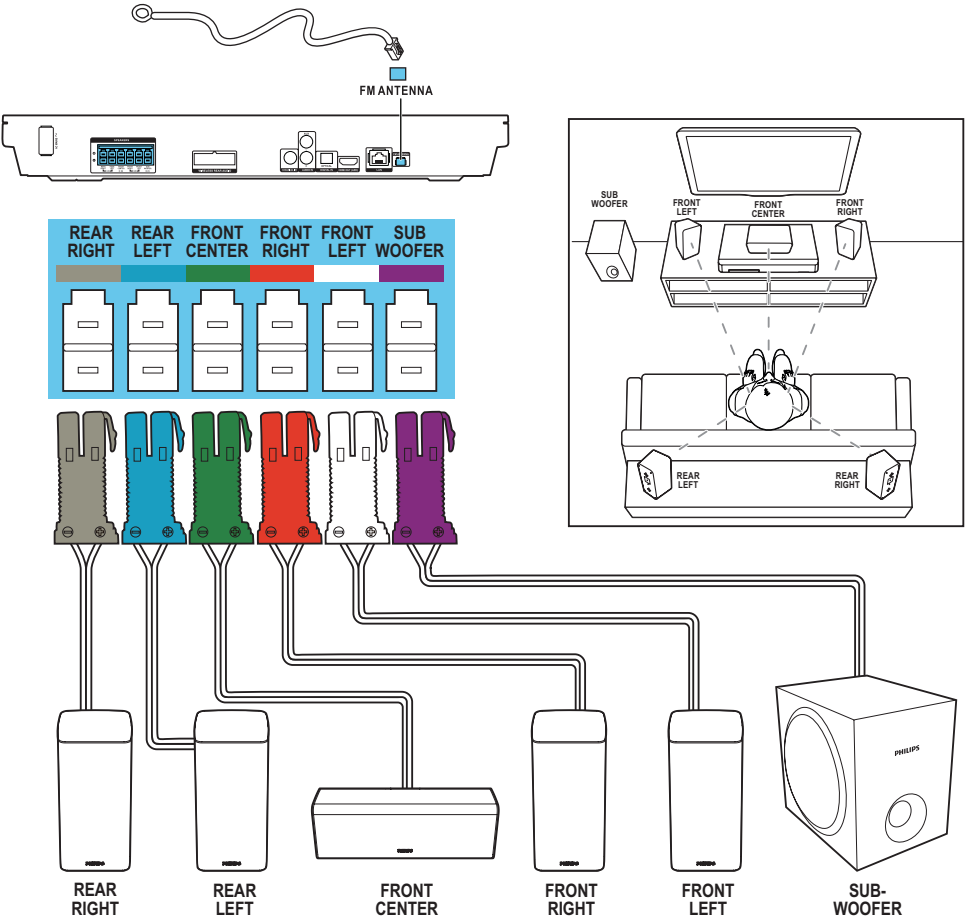

HTB3550

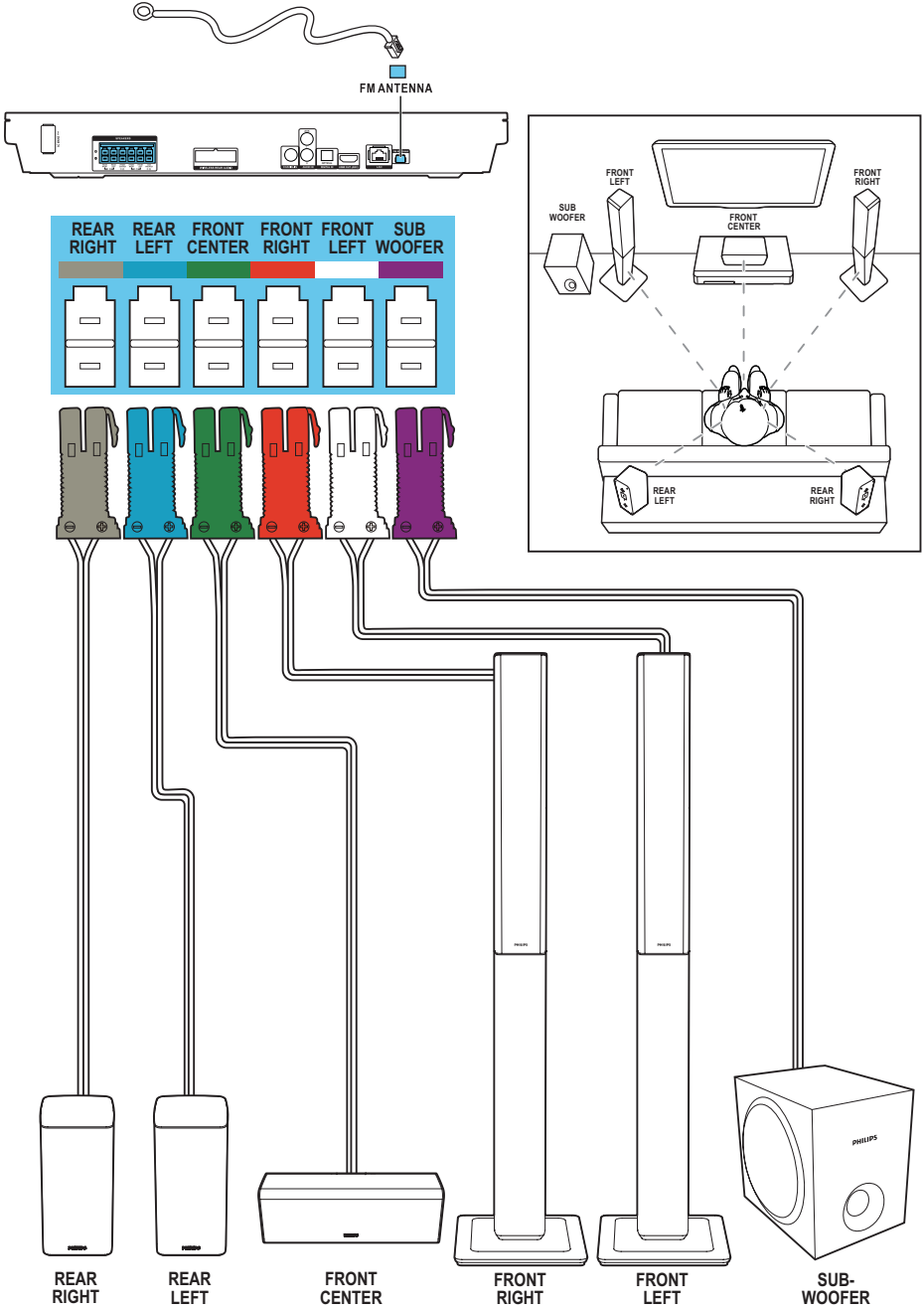

HTB3580

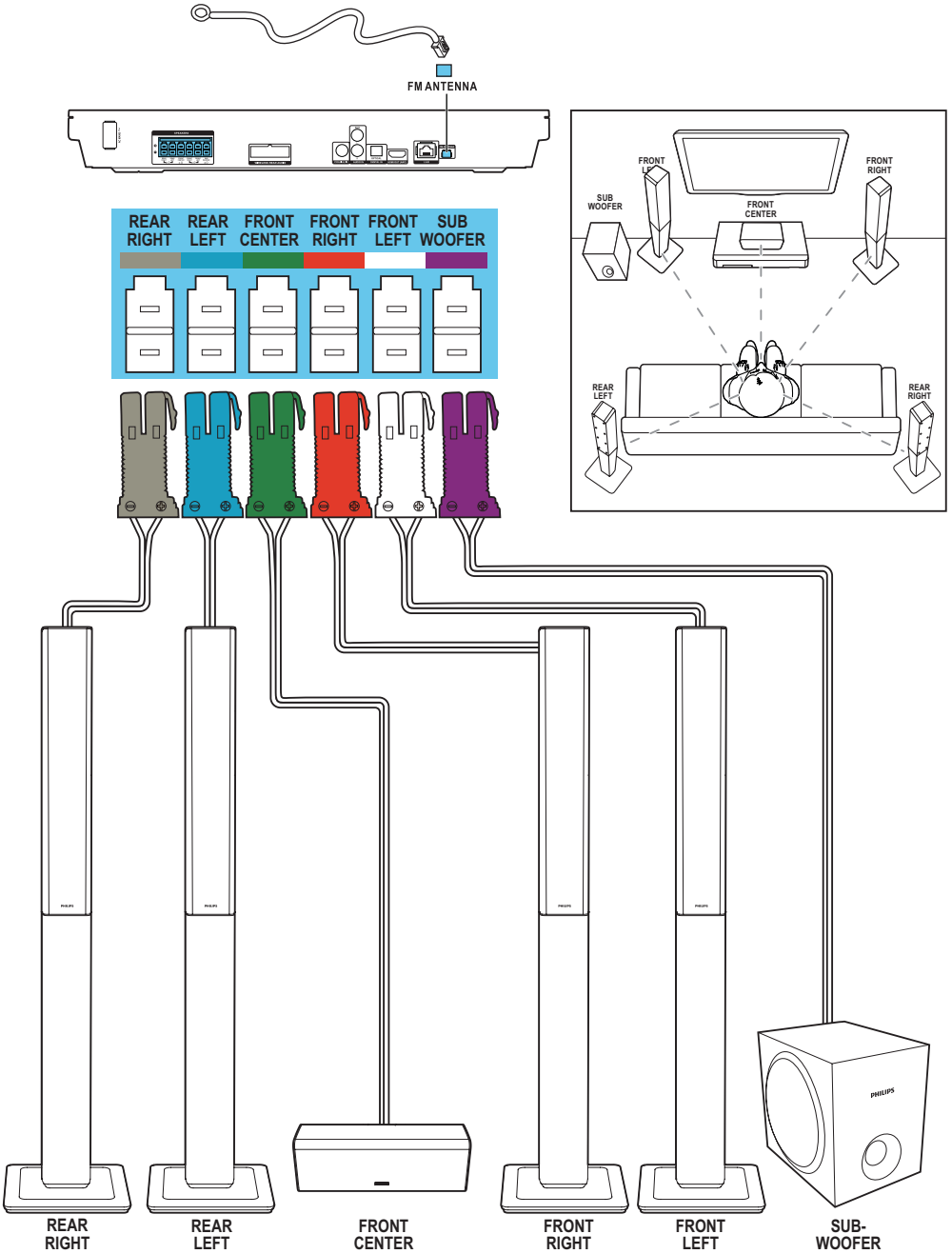

3

- EN** Connect to TV in one of these ways
- ZH-CN** 通过这些方式连接至电视
- ZH-TW** 用這些方式之一連線到電視
- MS** Sambung kepada TV dalam salah satu cara berikut
- TH** เชื่อมต่อที่วีด้วยวิธีใดวิธีหนึ่งดังนี้

HDMI ARC

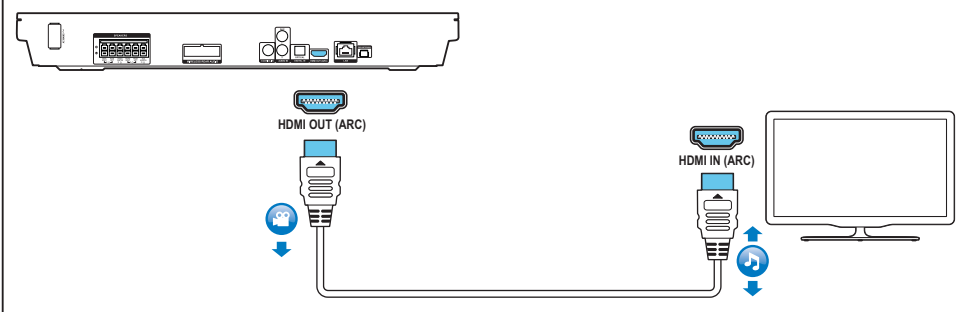

HDMI + OPTICAL

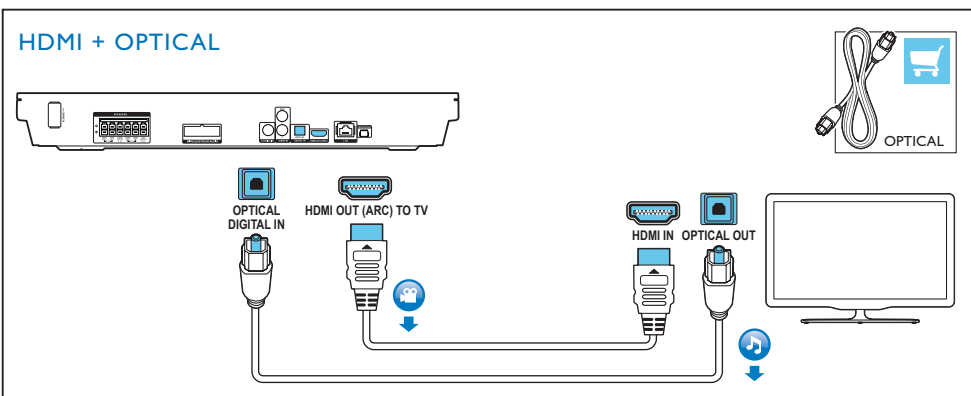

HDMI + COAXIAL



COAXIAL IN
HDMI OUT (ARC)

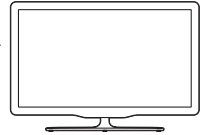

HDMI + AUDIO L/R

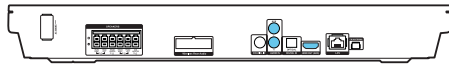

L
R
AUDIO IN
HDMI OUT (ARC TO TV)

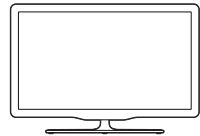
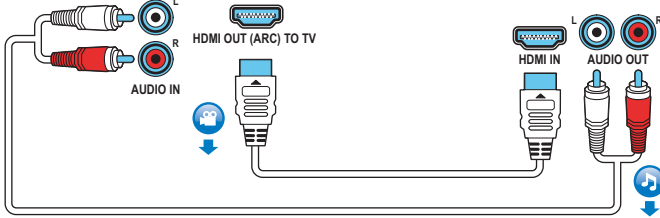

4

EN Switch on the home theater

ZH-CN 打开家庭影院

ZH-TW 開啟家庭劇院

MS Hidupkan teater rumah

TH เปิดโฮมเธียเตอร์

1

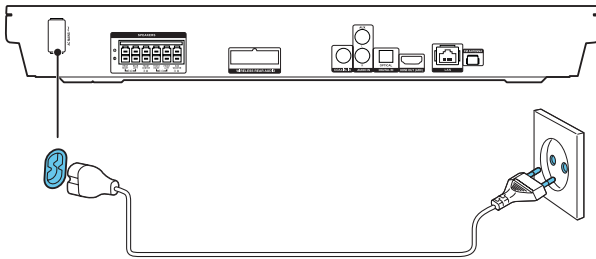

2

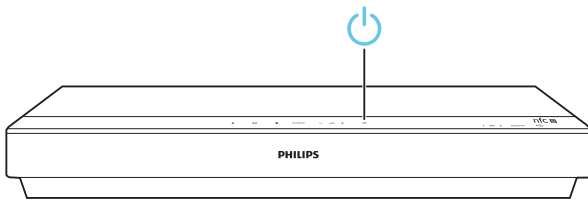

3

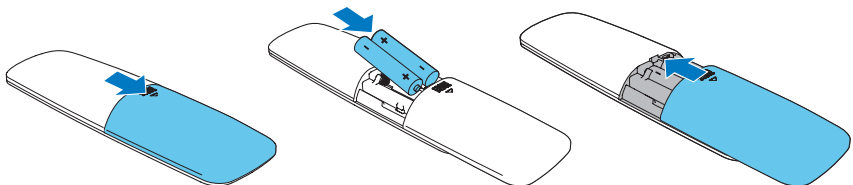

5

- EN** Complete the first time setup
- ZH-CN** 完成首次设置
- ZH-TW** 完成首次設定
- MS** Lengkapi persediaan kali pertama
- TH** ตั้งค่าครั้งแรกให้เสร็จสมบูรณ์

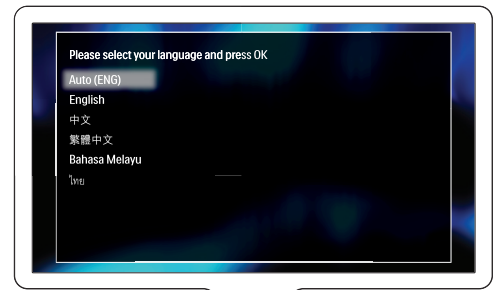
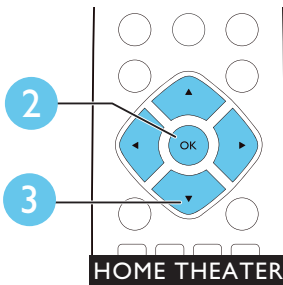
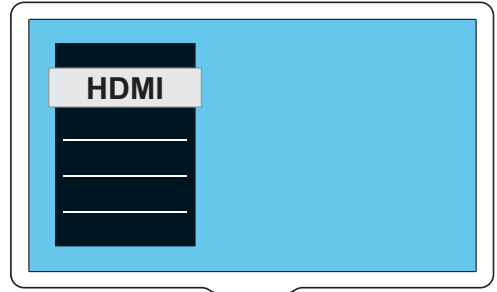
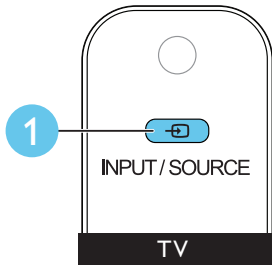

6

EN Use your home theater

ZH-CN 使用家庭影院

ZH-TW 使用您的家庭劇院

MS Gunakan teater rumah anda

TH ใช้โฮมเธียเตอร์ของคุณ

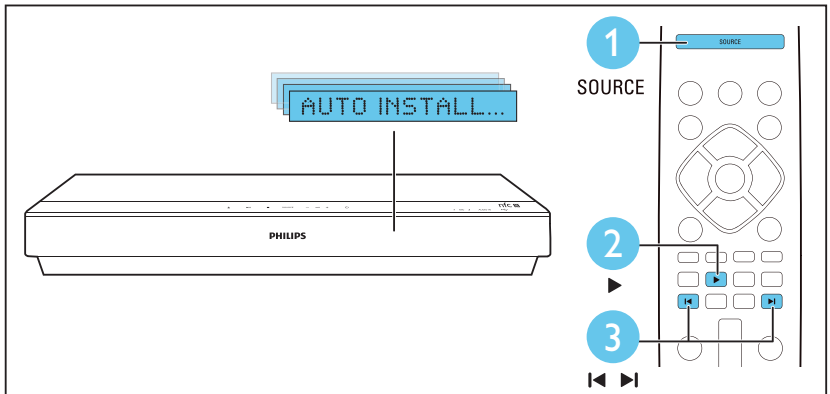
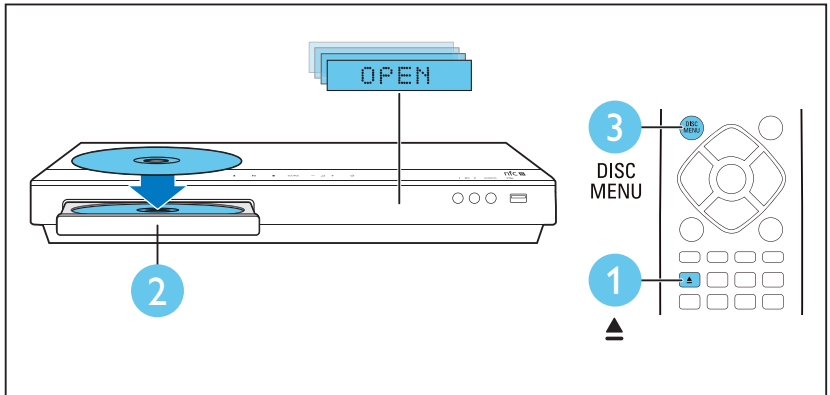

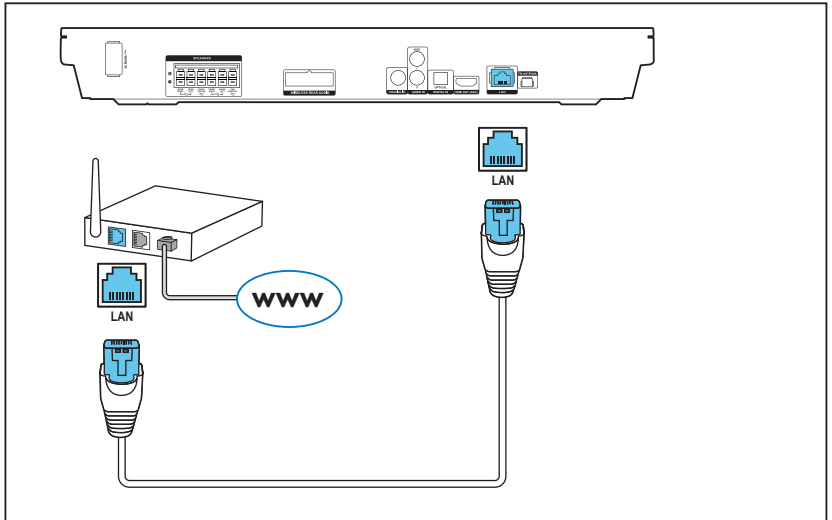
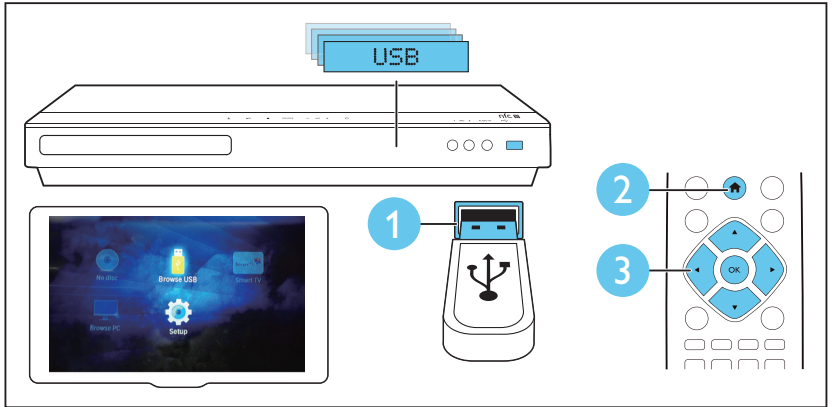
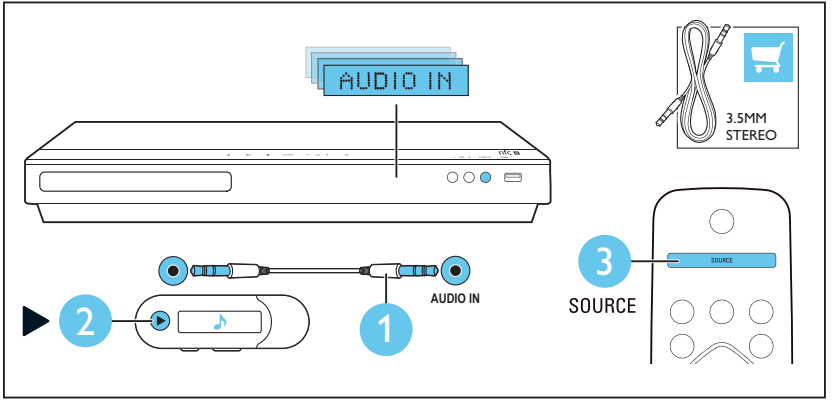

7

EN Play audio through Bluetooth or connect Bluetooth via NFC

ZH-CN 通过蓝牙播放音频或通过 NFC 连接蓝牙

ZH-TW 透過藍牙播放音訊或透過 NFC 連接藍牙

MS Mainkan audio melalui Bluetooth atau sambungkan Bluetooth melalui NFC

TH การเล่นเสียงผ่าน Bluetooth หรือเชื่อมต่อ Bluetooth ผ่าน NFC

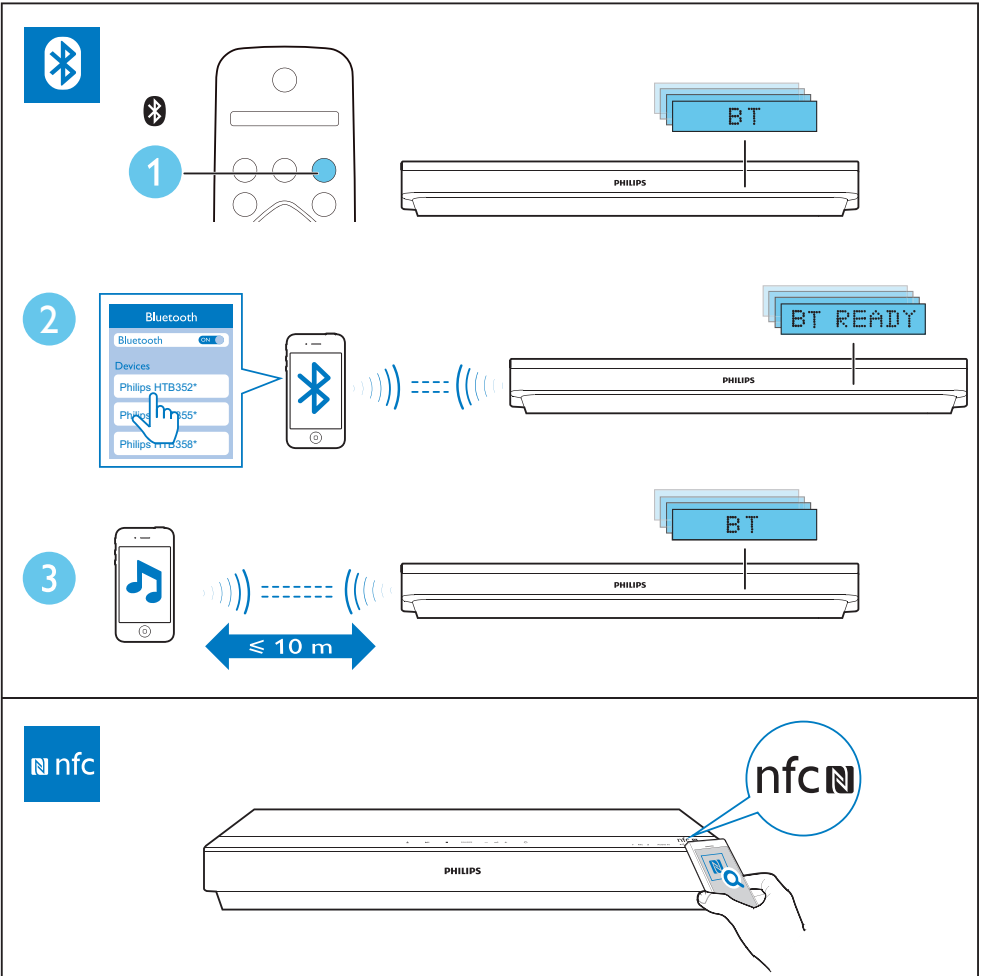



EN For more information about using this product, visit www.philips.com/support

ZH-CN 访问 www.philips.com/support 更详尽地了解本产品

ZH-TW 如果要瞭解產品的更多資訊，請瀏覽 www.philips.com/support。

MS-MY Untuk mendapatkan maklumat lanjut dalam menggunakan produk ini, lawati www.philips.com/support

TH สำหรับข้อมูลเพิ่มเติมเกี่ยวกับการใช้ผลิตภัณฑ์นี้ โปรดเยี่ยมชม www.philips.com/support



www.philips.com/support



Specifications are subject to change without notice

© 2014 Koninklijke Philips N.V. All rights reserved.

Trademarks are the property of Koninklijke Philips N.V. or their respective owners.

HTB3520/3550/3580_98_QSG_V1.0

