

# NETGEAR®

## AC1200 WiFi Range Extender

Model EX6130

User Manual



May 2017  
202-11627-02

350 East Plumeria Drive  
San Jose, CA 95134  
USA

## Support

Thank you for purchasing this NETGEAR product. You can visit [www.netgear.com/support](http://www.netgear.com/support) to register your product, get help, access the latest downloads and user manuals, and join our community. We recommend that you use only official NETGEAR support resources.

## Conformity

For the current EU Declaration of Conformity, visit [http://kb.netgear.com/app/answers/detail/a\\_id/11621](http://kb.netgear.com/app/answers/detail/a_id/11621).

## Compliance

For regulatory compliance information, visit <http://www.netgear.com/about/regulatory>.

See the regulatory compliance document before connecting the power supply.

## Trademarks

© NETGEAR, Inc. NETGEAR and the NETGEAR Logo are trademarks of NETGEAR, Inc. Any non-NETGEAR trademarks are used for reference purposes only.

# Table of Contents

## Chapter 1 Overview

Meet Your Extender .....	6
Front Panel .....	6
Side Panels .....	7
When to Use Your Extender .....	7
How the Extender Works .....	8

## Chapter 2 Get Started

Use the Extender in Extender Mode .....	10
Place the Extender and Apply Power .....	10
Connect to an Existing WiFi Network .....	10
Find the Best Location .....	14
Connect an Ethernet-Enabled Device .....	14
Use the Extender in Access Point Mode .....	15
Log In to the Extender After Installation .....	16
Run Smart Setup Installation .....	16

## Chapter 3 Optimize Extender Performance

Boost Your Video Streaming With FastLane Technology .....	20
Adjust the WiFi Coverage .....	21

## Chapter 4 Network Settings

View Connected Devices .....	24
View WiFi Settings .....	24
Change the Extender WiFi Network Names .....	25
Change the Extender WiFi Password .....	26
Turn Off the SSID Broadcast to Create a Hidden Network .....	27
Disable or Enable the WiFi Radios .....	28
Change the WiFi Speed .....	29
Disable or Enable 20/40 MHz Coexistence for 2.4 GHz WiFi .....	30
Use WPS to Add a Computer to the Extender's WiFi Network .....	31
Use WPS With the Push Button Method .....	32
Use WPS With the PIN Method .....	33
Deny Access to a Computer or WiFi Device .....	34
Set Up an Access Schedule .....	35
Change the Extender's Device Name .....	36
Set Up the Extender to Use a Static IP Address .....	37
Use the Extender With MAC Filtering or Access Control .....	37

## Chapter 5 Maintain and Monitor the Extender

Change the Extender Login User Name and Password .....	40
Turn Password Protection Off and On .....	41
Recover a Forgotten User Name or Password.....	41
Automatically Adjust for Daylight Saving Time.....	42
Manually Set the Extender Clock .....	42
Change the Extender's Time Zone .....	43
Back Up and Restore the Extender Configuration .....	44
Back Up the Configuration Settings.....	44
Restore the Configuration Settings .....	45
Return the Extender to Its Factory Default Settings.....	46
Use the Factory Reset Button to Reset the Extender .....	47
Log In to the Extender to Reset the Extender .....	48
Update the Firmware .....	49
Restart the Extender Remotely.....	50

## Chapter 6 FAQs and Troubleshooting

FAQs .....	53
Cannot Connect to the Extender .....	53
Cannot Join a WiFi Network and Receive an Error Message.....	54

## Appendix A Factory Settings and Technical Specifications

Factory Default Settings .....	56
Technical and Environmental Specifications .....	57

# Overview

---

# 1

The NETGEAR WiFi Range Extender increases the distance of a WiFi network by boosting the existing WiFi signal and enhancing the overall signal quality over long distances. An extender repeats the signals from an existing WiFi router or access point.

This chapter covers the following topics:

- *Meet Your Extender*
- *When to Use Your Extender*
- *How the Extender Works*

---

**Note:** For more information about the topics covered in this manual, visit the support website at [support.netgear.com](http://support.netgear.com).

---

---

**Note:** Firmware updates with new features and bug fixes are made available from time to time at [downloadcenter.netgear.com](http://downloadcenter.netgear.com). Some products can regularly check the site and download new firmware, or you can check for and download new firmware manually.

---

## Meet Your Extender

Before you install your extender, familiarize yourself with its LEDs, buttons, and port.

### Front Panel

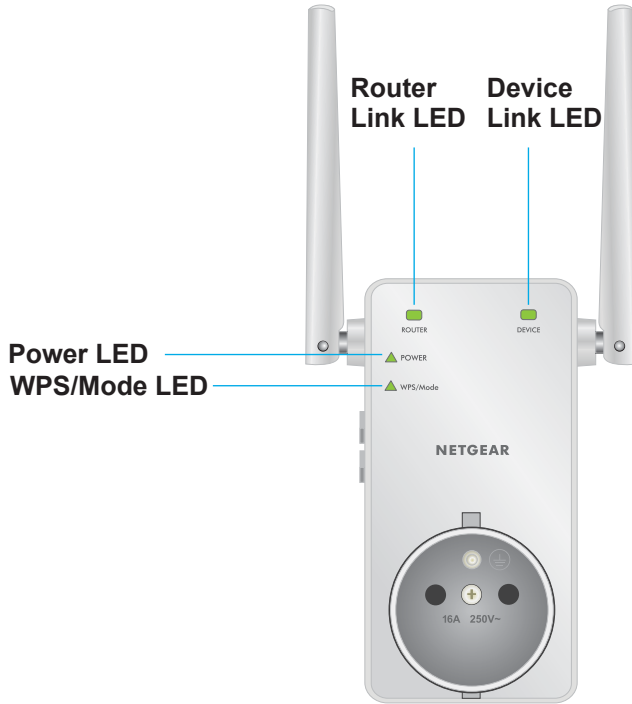

**Figure 1. Front panel LEDs**

The following table describes the LEDs.

**Table 1. Front panel LEDs**



LED	Description
Router Link LED  ROUTER	This LED indicates the connection between the extender and the router or access point: <ul style="list-style-type: none"> <li>• <b>Solid green.</b> Best connection.</li> <li>• <b>Solid amber.</b> Good connection.</li> <li>• <b>Solid red.</b> Poor connection.</li> <li>• <b>Off.</b> No connection.</li> </ul>
Device Link LED  DEVICE	This LED indicates the connection between the extender and a computer or WiFi device: <ul style="list-style-type: none"> <li>• <b>Solid green.</b> Best connection.</li> <li>• <b>Solid amber.</b> Good connection.</li> <li>• <b>Solid red.</b> Poor connection.</li> <li>• <b>Off.</b> No connection.</li> </ul>

Table 1. Front panel LEDs (continued)

LED	Description
Power LED ▲ POWER	<ul style="list-style-type: none"> <li>• <b>Solid amber.</b> The extender is booting.</li> <li>• <b>Solid green.</b> The extender is powered on.</li> <li>• <b>Blinking green.</b> The extender is switching between extender mode and access point mode.</li> <li>• <b>Off.</b> The extender is powered off.</li> </ul>
WPS/Mode LED ▲ WPS/Mode	<ul style="list-style-type: none"> <li>• <b>Solid green.</b> The extender is in extender mode.</li> <li>• <b>Blinking green.</b> A WPS connection is being established or the extender is switching between extender mode and access point mode.</li> <li>• <b>Off.</b> The extender is in access point mode.</li> </ul>

## Side Panels

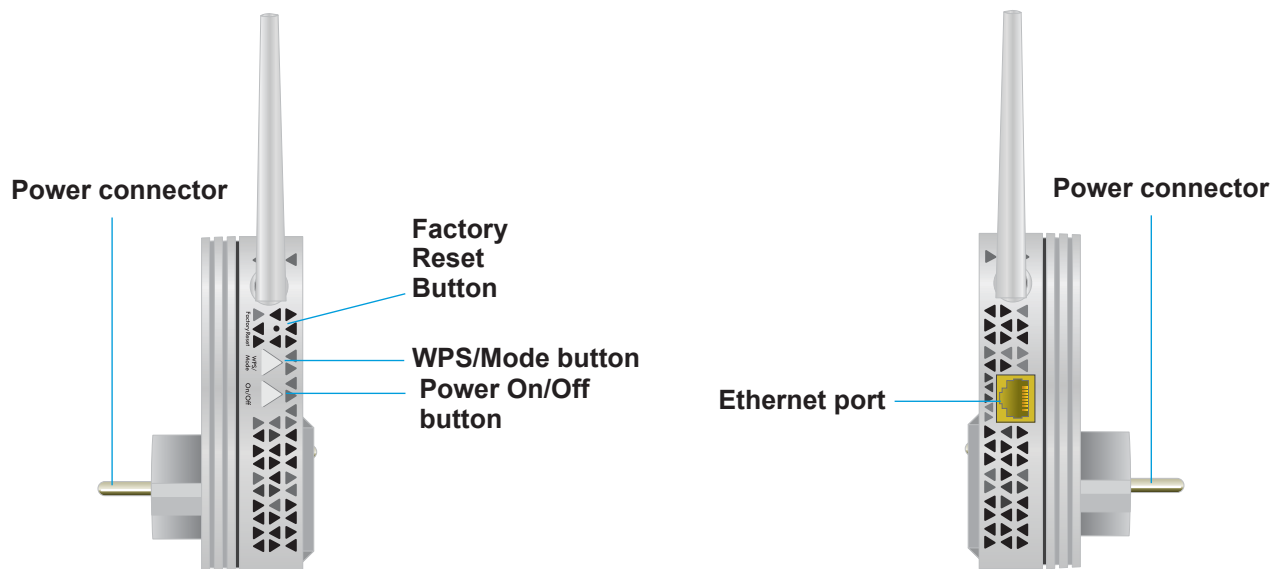

Figure 2. Buttons and port on the side panels

## When to Use Your Extender

We recommend that you connect through the extender network only when the WiFi device is in a “dead zone” where the connection from the existing network is poor or nonexistent. Data traffic routed through the extender is inherently slower than traffic routed directly from the network.

## How the Extender Works

The extender works like a bridge between a WiFi router (or a WiFi access point) and a WiFi device outside the range of the WiFi router. The extender performs two main jobs:

- The extender connects to a working WiFi network.

When the extender connects over WiFi to an existing network, it functions as a network client, similar to how a WiFi device connects to a network.

- The extender acts as an access point for WiFi devices.

The extender broadcasts its own WiFi network that WiFi devices can join. In its role as an access point, the extender performs tasks that WiFi routers do, such as broadcasting its network name (SSID).

The extender must do each of these jobs so that both ends of the bridge are in place.

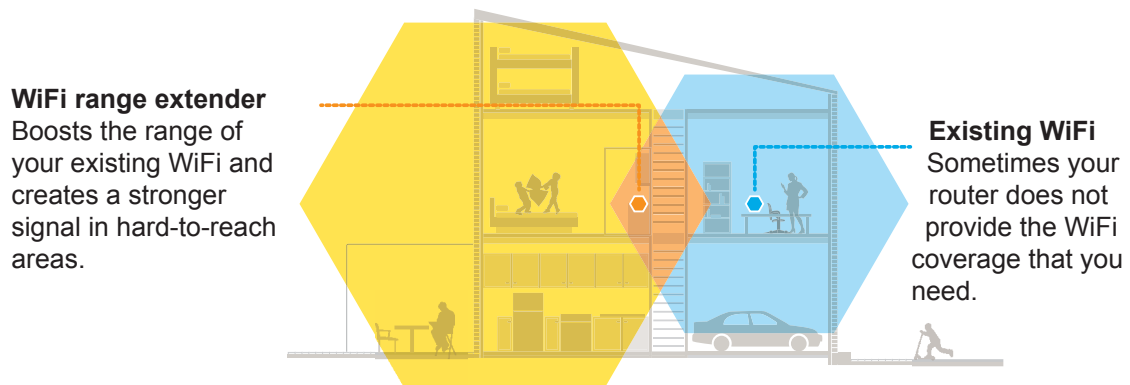

Figure 3. Range extender in a home



## 2 Get Started

---

# 2

This chapter covers the following topics:

- *Use the Extender in Extender Mode*
- *Use the Extender in Access Point Mode*
- *Log In to the Extender After Installation*
- *Run Smart Setup Installation*

## Use the Extender in Extender Mode

Place the extender, apply power, and connect the extender to your WiFi network.

---

**Note:** You can also use the extender as a WiFi access point and create a new WiFi hotspot by using a wired Ethernet connection. See *Use the Extender in Access Point Mode* on page 15.

---

## Place the Extender and Apply Power

➤ **To place the extender and apply power:**

1. Place your extender in the same room as your WiFi router.  
Proximity to the WiFi router is required only during the initial setup process.
2. Plug the extender into an electrical outlet.
3. Wait for the Power LED to light amber and then turn green.

If the Power LED does not light, press the **Power On/Off** button on the side of the extender.

## Connect to an Existing WiFi Network

To extend the range of your WiFi network, you must connect the extender to your existing WiFi network. You can do this in one of two ways:

- **Connect with WPS.** For more information, see *Connect With WPS* on page 10.
- **Connect with the NETGEAR installation assistant.** For more information, see *Connect With the NETGEAR Installation Assistant* on page 12.

### Connect With WPS

Wi-Fi Protected Setup (WPS) lets you join a secure WiFi network without typing the network name and password.

---

**Note:** WPS does not support WEP network security. If you are using WEP security, follow the instructions in *Connect With the NETGEAR Installation Assistant* on page 12.

---

➤ **To use WPS to connect the extender to your WiFi router:**

1. Press the **WPS/Mode** button on the extender for less than five seconds until the WPS/Mode LED blinks.

**Note:** If you press the **WPS/Mode** button for more than five seconds, the extender switches to access point mode. When the extender switches to access point mode, the WPS/Mode LED and Power LED blink and then the WPS/Mode LED turns off and the Power LED lights solid green.

2. Within two minutes, press the **WPS** button on your router or access point.

When the extender connects to your existing WiFi network, the WPS/Mode LED on the extender lights solid green and the Router Link LED lights. If the Router Link LED does not light, try again. If it still does not light, see [Connect With the NETGEAR Installation Assistant](#) on page 12.

3. If your WiFi router supports the 5 GHz band, repeat Steps 1 and 2 to connect the extender to the 5 GHz band.
4. Unplug the extender and move it to a new location that is about halfway between your router and the area with a poor router WiFi signal.



The location that you choose must be within the range of your existing WiFi router network.

5. Plug the extender into an electrical outlet and wait for the Power LED to light green.
6. Use the Router Link LED to help you choose a spot where the extender-to-router connection is optimal.
7. If the Router Link LED doesn't light amber or green, plug the extender into an outlet closer to the router and try again.

Keep moving the extender to outlets closer to the router until the Router Link LED lights amber or green.

8. On your computer or WiFi device, find and connect to the new extended WiFi network.

The extender creates two new extended WiFi networks. The extender's new WiFi network names are based on your existing WiFi network name, with `_2GEXT` and `_5GEXT` at the end of the name.

For example:

- **Existing WiFi network name.** MyNetworkName
- **New extended network names.** MyNetworkName\_2GEXT and MyNetworkName\_5GEXT

Use the same WiFi password that you use for your WiFi router.

9. Test the extended WiFi range by moving your computer or WiFi device to the area with a poor router WiFi signal:
  - a. Leave your computer or WiFi device in the area with a poor router WiFi signal and return to the extender.
  - b. Check the Device Link LED on the extender:
    - If the Device Link LED is solid green or amber, your extended WiFi network reaches the area with a poor router WiFi signal and your network setup is complete.
    - If the Device Link LED is red, your extended WiFi network does not reach the area with a poor router WiFi signal.

You must move the computer or WiFi device closer to the extender until the Device Link LED turns solid green or amber.

### Connect With the NETGEAR Installation Assistant

You can use the NETGEAR installation assistant to connect your extender to your existing WiFi router network.

➤ **To connect using the NETGEAR installation assistant:**

1. Use a WiFi network manager on a computer or WiFi device to find and connect to the extender WiFi network NETGEAR\_EXT.

After the connection with the computer or WiFi device is established, the Device Link LED lights.
2. Launch web browser.
3. Enter **www.mywifiext.net** in the address field of the browser.

The New Extender Setup page displays.
4. Click the **NEW EXTENDER SETUP** button.

The Create Account page displays.
5. Complete the fields on the page to set up your login credentials and click the **NEXT** button.
6. Select your country or region and click the **Continue** button.

The installation assistant detects if your extender is set to extender mode or access point (AP) mode.
7. If a message displays asking if you want to enable AP mode, click the **NO** button.
8. If a message displays asking if you want to enable extender mode, click the **YES** button.

The extender searches for WiFi networks in your area and displays a list.
9. Select a WiFi network to extend and click the **NEXT** button.

If you do not want to extend both WiFi bands, clear the **2.4 GHz WiFi Networks** or the **5 GHz WiFi Networks** check box.

10. In the **Password (Network Key)** field, type the existing WiFi network password (also called passphrase or security key) and click the **NEXT** button.
11. Set the network name (SSID) and password for your new extender WiFi network and click the **NEXT** button.

---

**Note:** We recommend that you use a network name (SSID) for your extender that is different from the network name (SSID) that your router uses.

---

Wait for the page to display a list of available extended WiFi networks, which might take up to one minute.

12. Connect your computer or WiFi device to the new extender WiFi network using the extender SSID and password that you created.
13. Make sure that your computer or WiFi device is successfully connected before you click the **Continue** button.
14. Click the **Continue** button.

A page displays confirming that the extender successfully connected to the existing WiFi network.

15. Click the **Next** button.

The registration page displays.

16. Complete the registration fields and click the **Finish** button to complete the setup.

If you do not want to register your extender, click the **Skip Registration** link. Note that you must register your extender before you can use NETGEAR telephone support.

The Status page displays.

17. Unplug the extender and move it to a location that is about halfway between your router and the area with a poor router WiFi signal.



The location that you choose must be within the range of your existing WiFi router network.

18. Plug the extender into an electrical outlet and wait for the Power LED to light green.

If the Power LED does not light, press the **Power On/Off** button.

19. Use the Router Link LED to help you choose a spot where the extender-to-router connection is optimal.

20. If the Router Link LED doesn't light amber or green, plug the extender into an outlet closer to the router and try again.

Keep moving the extender to outlets closer to the router until the Router Link LED lights amber or green.

21. Reconnect your computer or WiFi device to the new extended WiFi network.
22. Test the extended WiFi range by moving your computer or WiFi device to the area with a poor router WiFi signal:
- Leave your computer or WiFi device in the area with a poor router WiFi signal and return to the extender.
  - Check the Device Link LED on the extender:
    - If the Device Link LED is solid green or amber, your extended WiFi network reaches the area with a poor router WiFi signal and your network setup is complete.
    - If the Device Link LED is red, your extended WiFi network does not reach the area with a poor router WiFi signal.

You must move the computer or WiFi device closer to the extender until the Device Link LED turns solid green or amber.

## Find the Best Location

If the WiFi signal is weak, the first time you join the extender network, the Router Link LED or Device Link LED is amber or red. If this happens, adjust the position of the extender:

- If the Router Link LED is amber or red, move the extender closer to the router.
- If the Device Link LED is amber or red, move the computer or WiFi device closer to the extender.

## Connect an Ethernet-Enabled Device

After the extender is connected to your existing WiFi network, you can connect a wired device to the extender using an Ethernet cable. The device can then access your existing network through the extender's WiFi connection.



Figure 4. Connect a device to the extender's Ethernet port

## Use the Extender in Access Point Mode

You can use the extender as a WiFi access point, which creates a new WiFi hotspot by using a wired Ethernet connection.

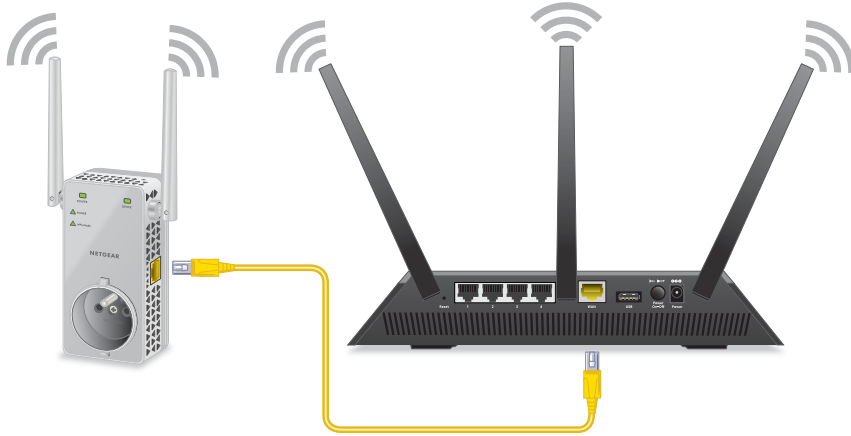

Figure 5. Extender in access point mode

### ➤ To use the extender in access point mode:

1. Use an Ethernet cable to connect the Ethernet port on the extender to an Ethernet LAN port on a router or a remote Ethernet LAN jack with LAN access.
2. Plug the extender into an electrical outlet and wait for the Power LED to light green.
3. If the Power LED does not light, press the **Power On/Off** button on the extender.
4. To make sure that the extender is in access point mode, check to see if the WPS/Mode LED is off.
5. If the WPS/Mode LED is lit, press the **WPS/Mode** button for more than five seconds.

While the extender switches to access point mode, the WPS/Mode LED and Power LED blink for up to 50 seconds. When the extender is in access point mode, the WPS/Mode LED turns off and the Power LED lights solid green.

6. Use a WiFi network manager on a computer or WiFi device to find and connect to the NETGEAR\_EXT (SSID) WiFi network.

After the connection with the computer or WiFi device is established, the Device Link LED lights.

7. Launch a web browser and enter **www.mywifiext.net** in the address field.  
The New Extender Setup page displays.
8. Click the **NEW EXTENDER SETUP** button.  
The Create Account page displays.
9. Complete the fields on the page to set up your login credentials and click the **NEXT** button.
10. Select your country or region and click the **Continue** button.

The installation assistant detects if your extender is set to extender mode or access point (AP) mode.

11. If a message displays asking if you want to enable extender mode, click the **NO** button.
12. If a message displays asking if you want to enable AP mode, click the **YES** button.
13. Set the network name (SSID), security option, and password for each access point network and click the **NEXT** button.

Your settings are applied and the extender is ready to be used as an access point.

14. Use a WiFi network manager on the computer or WiFi device to connect to the new access point WiFi network.
15. Click the **Continue** button.

A page displays confirming that the extender successfully connected to the existing WiFi network.

16. Click the **Next** button.

The registration page displays.

17. Follow the onscreen instructions to register your extender.

## Log In to the Extender After Installation

After installation, you can log in to the extender to view or change the extender's settings.

### ➤ To log in to the extender:

1. Use a WiFi network manager on a computer or WiFi device to find and connect to the new extended WiFi network.

After the connection with the computer or WiFi device is established, the Device Link LED lights solid green.

2. Launch a web browser.
3. Enter **www.mywifiext.net** in the address field of the browser.

A login window opens.

4. Enter your email address and password and click the **LOG IN** button.

The Status page displays.

## Run Smart Setup Installation

You can use Smart Setup to change the extender settings. This is an easy way to connect the extender to a different router or to change the extender WiFi network name (SSID) or WiFi password.



➤ **To run Smart Setup:**

1. Use a WiFi network manager on a computer or WiFi device to find and connect to the new extended WiFi network.

After the connection with the computer or WiFi device is established, the Device Link LED lights solid green.

2. Launch a web browser.
3. Enter **www.mywifiext.net** in the address field of the browser.  
A login window opens.
4. Enter your email address and password and click the **LOG IN** button.

The Status page displays.

5. Click the **SMART SETUP** button.

The Welcome page displays.

6. Click the **WiFi RANGE EXTENDER** button.

The extender scans for WiFi signals and finds the WiFi networks in your area and displays a list.

7. Select a WiFi network to extend and click the **NEXT** button.

If you do not want to extend both WiFi bands, clear the **2.4 GHz WiFi Networks** or the **5 GHz WiFi Networks** check box.

8. In the **Password (Network Key)** field, type the existing WiFi network password (also called passphrase or security key) and click the **NEXT** button.

9. Set the network name (SSID) and password for your new extender WiFi network and click the **NEXT** button.

---

**Note:** We recommend that you use a network name (SSID) for your extender that is different from the network name (SSID) that your router uses.

---

Wait for the page to display a list of available extended WiFi networks, which might take up to one minute.

10. Connect your computer or WiFi device to the new extender WiFi network using the extender SSID and password that you created.

11. Make sure that your computer or WiFi device is successfully connected before you click the **Continue** button.

12. Click the **Continue** button.

A page displays confirming that the extender successfully connected to the existing WiFi network.

13. Click the **Next** button.

The registration page displays.

14. Complete the registration fields and click the **Finish** button to complete the setup.

If you do not want to register your extender, click the **Skip Registration** link. Note that you must register your extender before you can use NETGEAR telephone support.

The Status page displays.

# Optimize Extender Performance

---

# 3

This chapter covers the following topics:

- *Boost Your Video Streaming With FastLane Technology*
- *Adjust the WiFi Coverage*

## Boost Your Video Streaming With FastLane Technology

Get the most out of your HD entertainment with FastLane technology. With FastLane technology, the extender connects to your router using one band and connects to your devices using another band. Because a band is dedicated to each function, performance is enhanced.

If all your devices and your WiFi router support only the 2.4 GHz band, or all your devices and your WiFi router support only the 5 GHz band, do not enable FastLane Technology.

When you enable FastLane Technology, two options are available:

- Use the 2.4 GHz band to connect the extender to the WiFi devices and use the 5 GHz band to connect the extender to the WiFi router. Use this mode if your WiFi router supports the 5 GHz band but the devices that you want to use for gaming and streaming support the 2.4 GHz band.
- Use the 5 GHz band to connect the extender to the WiFi devices and use the 2.4 GHz band to connect the extender to the WiFi router. Use this mode if the devices that you want to use for gaming and streaming support the 5 GHz band but your WiFi router supports the 2.4 GHz band.

➤ **To activate FastLane mode:**

1. On a computer or WiFi device that is connected to the extender network, launch a web browser.
2. In the address field of your browser, enter **www.mywifiext.net**.  
A login window opens.
3. Enter your email address and password and click the **LOG IN** button.  
The Status page displays.
4. If your browser displays the **Menu** icon , click it.  
The extender menu displays.

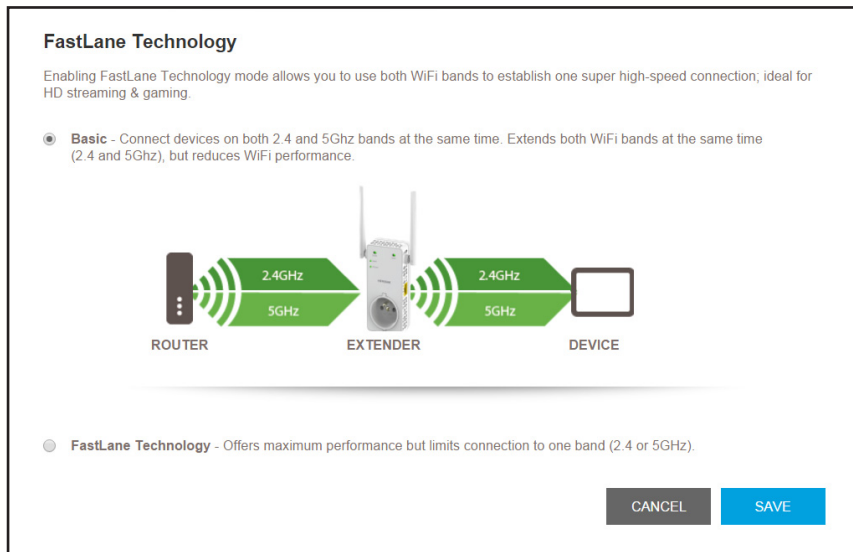
5. Select **Do More > FastLane**.

## 6. Select a radio button:

- **Router-to-Extender in 2.4 GHz only and Extender-to-Device in 5 GHz only**
- **Router to Extender in 5 GHz only and Extender-to-Device in 2.4 GHz only**

7. Click the **SAVE** button.

Your settings are saved.

## Adjust the WiFi Coverage

You can set the extender's WiFi coverage depending on how large you want your coverage area to be.

### ➤ To adjust the WiFi coverage:

1. On a computer or WiFi device that is connected to the extender network, launch a web browser.
2. In the address field of your browser, enter **www.mywifiext.net**.  
A login window opens.
3. Enter your email address and password and click the **LOG IN** button.  
The Status page displays.
4. If your browser displays the **Menu** icon , click it.  
The extender menu displays.

5. Select **Do More > WiFi Coverage**.

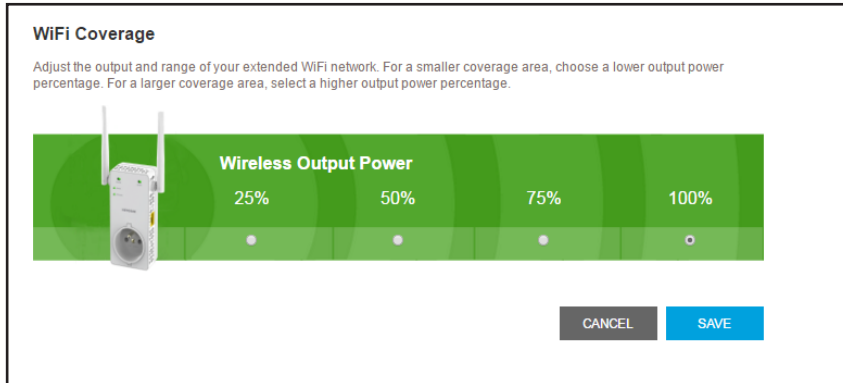

6. Select a Wireless Output Power radio button.

If your extender is covering a small area, select a lower-output power percentage. If your extender is covering a large area, select a higher-output power percentage.

7. Click the **SAVE** button.

Your settings are saved.

# 4 Network Settings

---

# 4

This chapter covers the following topics:

- *View Connected Devices*
- *View WiFi Settings*
- *Change the Extender WiFi Network Names*
- *Change the Extender WiFi Password*
- *Turn Off the SSID Broadcast to Create a Hidden Network*
- *Disable or Enable the WiFi Radios*
- *Change the WiFi Speed*
- *Disable or Enable 20/40 MHz Coexistence for 2.4 GHz WiFi*
- *Use WPS to Add a Computer to the Extender's WiFi Network*
- *Deny Access to a Computer or WiFi Device*
- *Set Up an Access Schedule*
- *Change the Extender's Device Name*
- *Set Up the Extender to Use a Static IP Address*
- *Use the Extender With MAC Filtering or Access Control*

## View Connected Devices

You can view a list of devices that are connected to the extender network.

➤ **To view connected devices:**

1. On a computer or WiFi device that is connected to the extender network, launch a web browser.
2. In the address field of your browser, enter **www.mywifiext.net**.

A login window opens.

3. Enter your email address and password and click the **LOG IN** button.  
The Status page displays.

4. If your browser displays the **Menu** icon , click it.

The extender menu displays.

5. Select **Settings > Connected Devices**.

**Connected Devices**

WiFi Extender

IP Address	Network Name (SSID)	MAC Address	Virtual MAC Address
192.168.1.57	AC790-A58A_2GEXT	2C:30:33:F4:B5:05	2E:30:33:F4:B5:05
192.168.1.57	AC790-A58A_5GEXT	2C:30:33:F4:B5:04	2E:30:33:F4:B5:04

Wired Devices Refresh

IP Address	Device Name	MAC Address	Virtual MAC Address

WiFi Devices Refresh

Enable Access Control

IP Address	Device Name	MAC Address	Virtual MAC Address
192.168.1.88	TIPHAM-T440P	7C:7A:91:53:5B:C4	02:0F:B5:53:5B:C4

CANCEL
SAVE

## View WiFi Settings

➤ **To view the WiFi settings:**

1. On a computer or WiFi device that is connected to the extender network, launch a web browser.
2. In the address field of your browser, enter **www.mywifiext.net**.

A login window opens.



3. Enter your email address and password and click the **LOG IN** button.  
The Status page displays.
4. If your browser displays the **Menu** icon , click it.  
The extender menu displays.
5. Select **Settings > Wireless**.

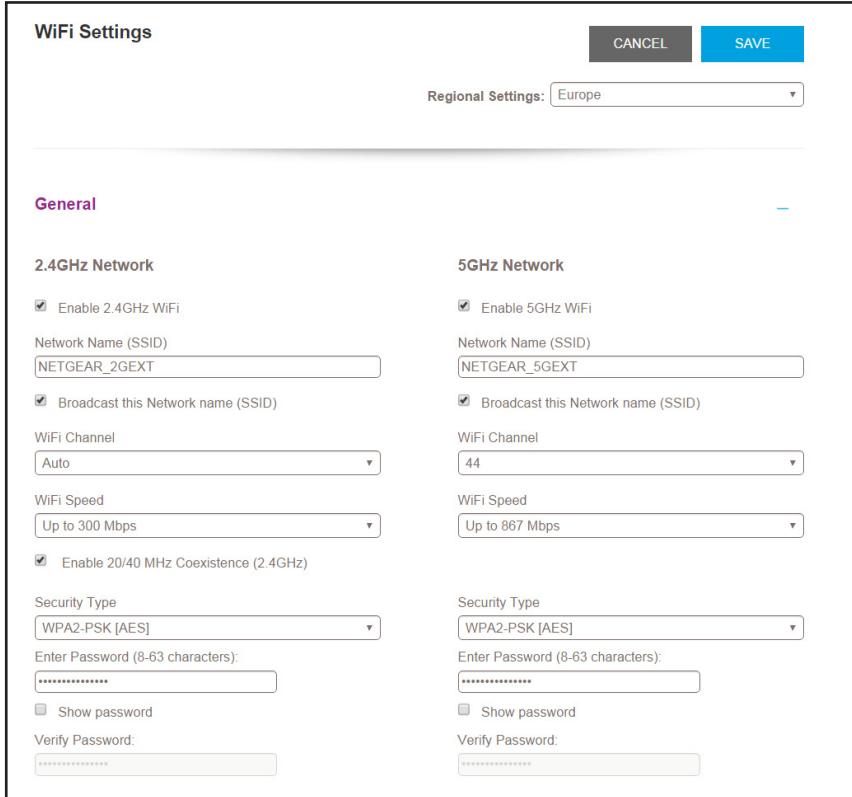

**WiFi Settings** CANCEL SAVE

Regional Settings: Europe

---

**General**

<p><b>2.4GHz Network</b></p> <p><input checked="" type="checkbox"/> Enable 2.4GHz WiFi</p> <p>Network Name (SSID) <input type="text" value="NETGEAR_2GEXT"/></p> <p><input checked="" type="checkbox"/> Broadcast this Network name (SSID)</p> <p>WiFi Channel <span>Auto</span></p> <p>WiFi Speed <span>Up to 300 Mbps</span></p> <p><input checked="" type="checkbox"/> Enable 20/40 MHz Coexistence (2.4GHz)</p> <p>Security Type <span>WPA2-PSK [AES]</span></p> <p>Enter Password (8-63 characters): <input type="password" value="*****"/></p> <p><input type="checkbox"/> Show password</p> <p>Verify Password: <input type="password" value="*****"/></p>	<p><b>5GHz Network</b></p> <p><input checked="" type="checkbox"/> Enable 5GHz WiFi</p> <p>Network Name (SSID) <input type="text" value="NETGEAR_5GEXT"/></p> <p><input checked="" type="checkbox"/> Broadcast this Network name (SSID)</p> <p>WiFi Channel <span>44</span></p> <p>WiFi Speed <span>Up to 867 Mbps</span></p> <p>Security Type <span>WPA2-PSK [AES]</span></p> <p>Enter Password (8-63 characters): <input type="password" value="*****"/></p> <p><input type="checkbox"/> Show password</p> <p>Verify Password: <input type="password" value="*****"/></p>
---	--

## Change the Extender WiFi Network Names

- **To change the extender's WiFi network names:**
  1. On a computer or WiFi device that is connected to the extender network, launch a web browser.
  2. In the address field of your browser, enter **www.mywifiext.net**.  
A login window opens.
  3. Enter your email address and password and click the **LOG IN** button.  
The Status page displays.
  4. If your browser displays the **Menu** icon , click it.  
The extender menu displays.

5. Select **Settings > Wireless**.

6. In each **Network Name (SSID)** field, type a network name.

7. Click the **SAVE** button.

Your settings are saved.

8. Reconnect your extender to the extender WiFi network.

## Change the Extender WiFi Password

➤ **To change the extender's WiFi password:**

1. On a computer or WiFi device that is connected to the extender network, launch a web browser.

2. In the address field of your browser, enter **www.mywifiext.net**.

A login window opens.

3. Enter your email address and password and click the **LOG IN** button.

The Status page displays.

4. If your browser displays the **Menu** icon , click it.

The extender menu displays.

## 5. Select **Settings > Wireless**.

6. In each **Enter Password** field, type a new password.

7. Type the new password in the **Verify Password** field.

8. Click the **SAVE** button.

Your settings are saved.

9. Reconnect your computer or WiFi device to the extender WiFi network using the new password.

## Turn Off the SSID Broadcast to Create a Hidden Network

By default, the extender broadcasts its WiFi signal so that its WiFi network names (SSIDs) are easy for you to find from your computer, tablet, or smartphone. You can turn off the SSID broadcast to create a hidden WiFi network. To connect to a hidden network you must know its SSID and password and manually enter them.

### ➤ To turn off the SSID broadcast to create a hidden network:

1. On a computer or WiFi device that is connected to the extender network, launch a web browser.
2. In the address field of your browser, enter **www.mywifiext.net**.

A login window opens.

3. Enter your email address and password and click the **LOG IN** button.  
The Status page displays.
4. If your browser displays the **Menu** icon , click it.  
The extender menu displays.
5. Select **Settings > Wireless**.

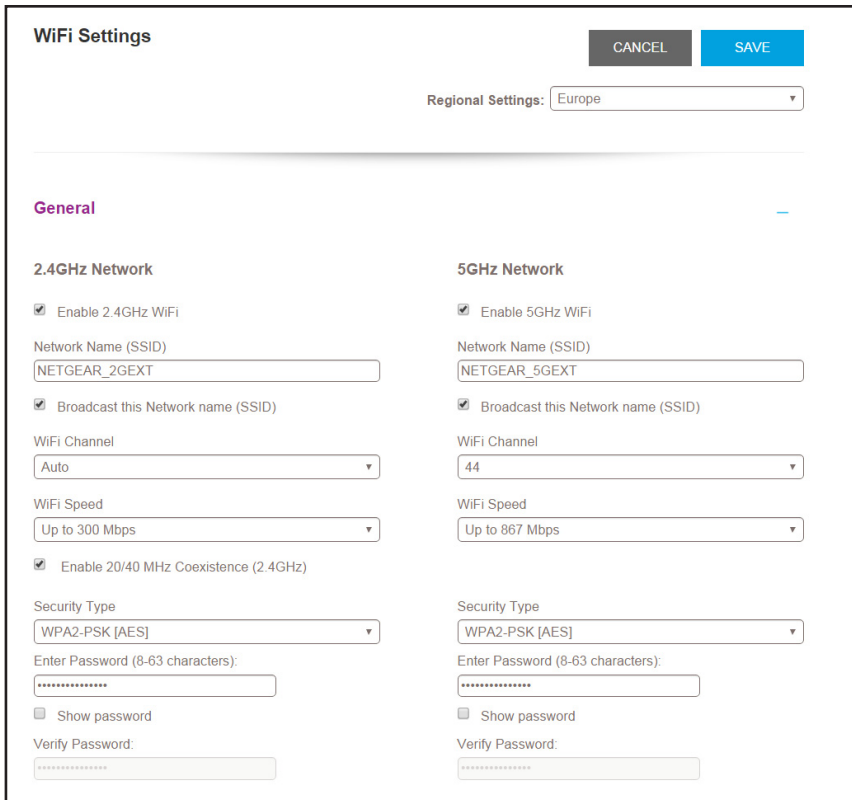

6. Clear the **Broadcast the Network name (SSID)** check box for each network.
7. Click the **SAVE** button.  
Your settings are saved.

## Disable or Enable the WiFi Radios

By default, the extender's WiFi radios broadcast signals in the 2.4 GHz and 5 GHz bands. If you disable the WiFi radios, then no one can connect with WiFi to the extender.

### ➤ To enable or disable the WiFi radios:

1. On a computer or WiFi device that is connected to the extender network, launch a web browser.
2. In the address field of your browser, enter **www.mywifiext.net**.  
A login window opens.

- Enter your email address and password and click the **LOG IN** button.  
The Status page displays.
- If your browser displays the **Menu** icon , click it.  
The extender menu displays.
- Select **Settings > Wireless**.

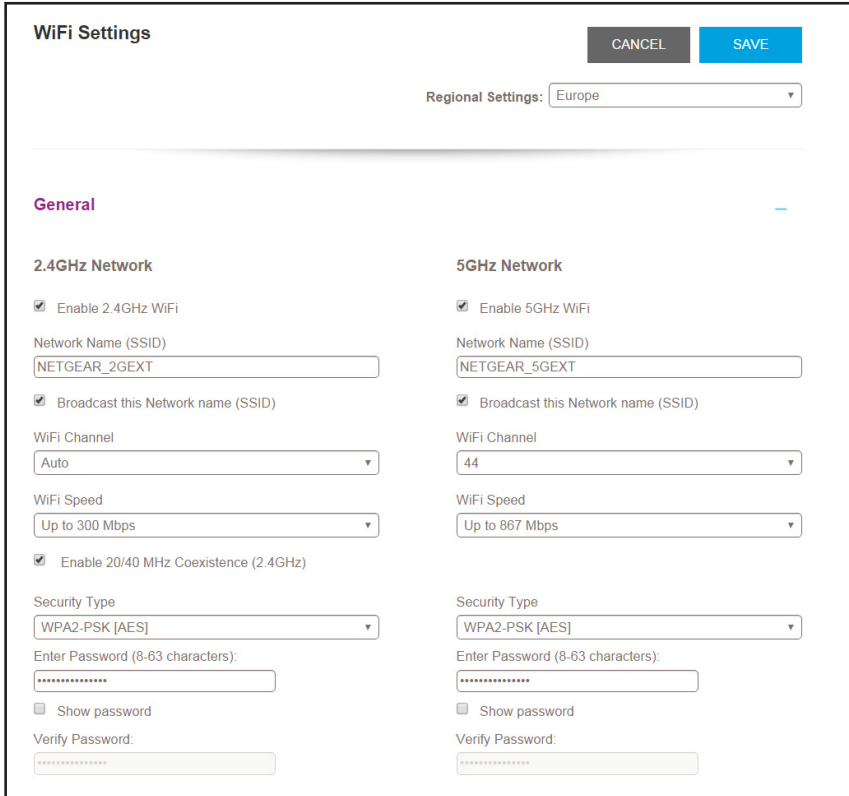

- Select or clear the **Enable 2.4 GHz WiFi** check box.
- Select or clear the **Enable 5 GHz WiFi** check box.
- Click the **SAVE** button.

Your settings are saved.

## Change the WiFi Speed

### ➤ To change the WiFi speed:

- On a computer or WiFi device that is connected to the extender network, launch a web browser.
- In the address field of your browser, enter **www.mywifiext.net**.  
A login window opens.
- Enter your email address and password and click the **LOG IN** button.

The Status page displays.

4. If your browser displays the **Menu** icon , click it.

The extender menu displays.

5. Select **Settings > Wireless**.

6. In each **WiFi Speed** menu, select a speed.

7. Click the **SAVE** button.

Your settings are saved.

## Disable or Enable 20/40 MHz Coexistence for 2.4 GHz WiFi

The extender's 2.4 GHz WiFi network can run in either 40 MHz mode or 20 MHz mode. When this feature is enabled, the extender uses 40 MHz mode unless a nearby WiFi network is using 40 MHz mode. If that happens, the extender uses 20 MHz mode to coexist with that network.

- **To enable or disable 20/40 MHz coexistence for 2.4 GHz WiFi:**

1. On a computer or WiFi device that is connected to the extender network, launch a web browser.

- In the address field of your browser, enter **www.mywifiext.net**.  
A login window opens.
- Enter your email address and password and click the **LOG IN** button.  
The Status page displays.
- If your browser displays the **Menu** icon , click it.  
The extender menu displays.
- Select **Settings > Wireless**.

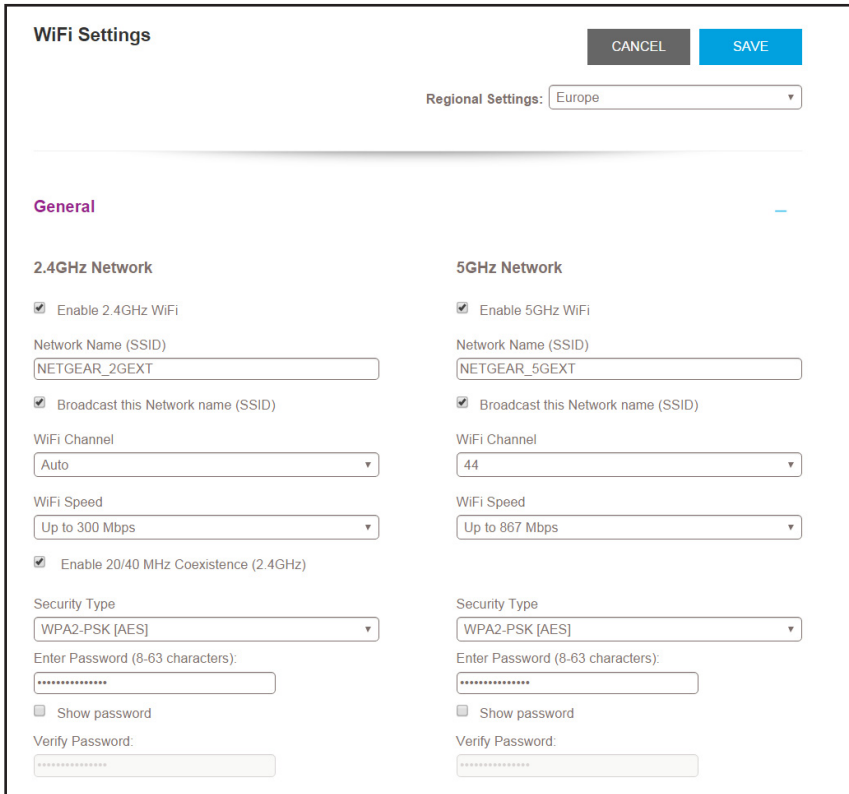

**WiFi Settings** CANCEL SAVE

Regional Settings: Europe

**General**

**2.4GHz Network**

- Enable 2.4GHz WiFi
- Network Name (SSID): NETGEAR\_2GEXT
- Broadcast this Network name (SSID)
- WiFi Channel: Auto
- WiFi Speed: Up to 300 Mbps
- Enable 20/40 MHz Coexistence (2.4GHz)
- Security Type: WPA2-PSK [AES]
- Enter Password (8-63 characters):
- Show password
- Verify Password:

**5GHz Network**

- Enable 5GHz WiFi
- Network Name (SSID): NETGEAR\_5GEXT
- Broadcast this Network name (SSID)
- WiFi Channel: 44
- WiFi Speed: Up to 867 Mbps
- Security Type: WPA2-PSK [AES]
- Enter Password (8-63 characters):
- Show password
- Verify Password:

- Select or clear the **Enable 20/40 MHz Coexistence (2.4GHz)** check box.
- Click the **SAVE** button.  
Your settings are saved.

## Use WPS to Add a Computer to the Extender's WiFi Network

WPS (WiFi Protected Setup) lets you connect a computer or WiFi device to the extender's network without entering the WiFi network passphrase or key. Instead, you use a **WPS** button or enter a PIN to connect.

If you use the push button method, the WiFi device that you are trying to connect must include a physical button or a software button. If you use the PIN method, you must know the PIN of the WiFi device that you are trying to connect.

WPS supports WPA and WPA2 WiFi security. If your extender network is open (no WiFi security is set), connecting with WPS automatically sets WPA + WPA2 WiFi security on the extender network and generates a random passphrase. You can view this passphrase on the WiFi Settings page (for more information, see [View WiFi Settings](#) on page 24).

For information about using WPS to connect the extender to a WiFi network during setup, see [Use the Extender in Access Point Mode](#) on page 15.

## Use WPS With the Push Button Method

For you to use the push button method to connect a WiFi device to the extender's WiFi network, the WiFi device that you are trying to connect must include a physical **WPS** button or an onscreen **WPS** button that you can click.

➤ **To use WPS to add a computer or WiFi device to the extender's WiFi network:**

1. On a computer or WiFi device that is connected to the extender network, launch a web browser.
2. In the address field of your browser, enter **www.mywifiext.net**.

A login window opens.

3. Enter your email address and password and click the **LOG IN** button.

The Status page displays.

4. If your browser displays the **Menu** icon ☰, click it.

The extender menu displays.

5. Select **Settings > Do More > Connect Devices (WPS)**.

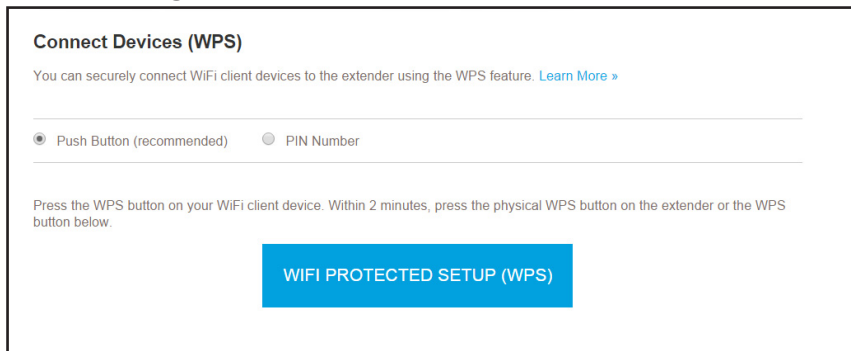

6. Leave the **Push Button (recommended)** radio button selected.

7. Click the **WIFI PROTECTED SETUP (WPS)** button.

For two minutes, the extender attempts to add the computer or WiFi device to its WiFi network.



8. Within two minutes, go to the computer or WiFi device and press or click its **WPS** button.
9. To verify that the WiFi device is connected to the extender's WiFi network, select **Settings > Connected Devices**.

The WiFi device displays onscreen.

## Use WPS With the PIN Method

To use the PIN method to connect a WiFi device to the extender's WiFi network, you must know the PIN of the WiFi device that you are trying to connect.

### ➤ To add a computer or WiFi device to the extender's WiFi network:

1. On a computer or WiFi device that is connected to the extender network, launch a web browser.
2. In the address field of your browser, enter **www.mywifiext.net**.

A login window opens.

3. Enter your email address and password and click the **LOG IN** button.

The Status page displays.

4. If your browser displays the **Menu** icon , click it.

The extender menu displays.

5. Select **Settings > Do More > Connect Devices (WPS)**.

The Connect Devices (WPS) page displays.

6. Select the **PIN Number** radio button.

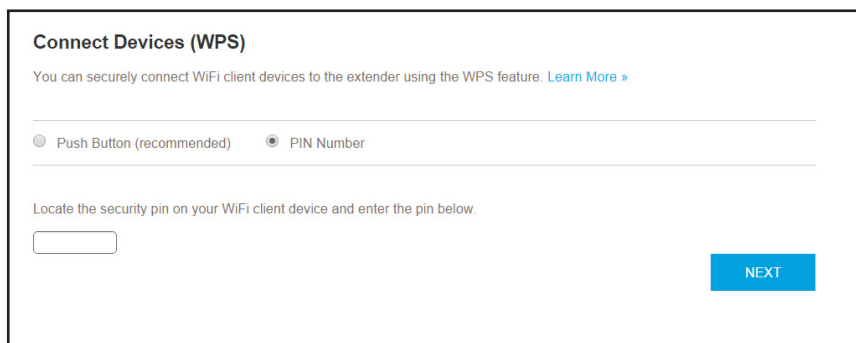

**Connect Devices (WPS)**

You can securely connect WiFi client devices to the extender using the WPS feature. [Learn More >](#)

Push Button (recommended)  PIN Number

Locate the security pin on your WiFi client device and enter the pin below.

**NEXT**

7. Type the PIN of the WiFi device in the field.
  8. Click the **NEXT** button.
- For four minutes, the extender attempts to find the computer or WiFi device.
9. Within four minutes, go to the WiFi device and use its WPS software to join the WiFi network.
  10. To verify that the WiFi device is connected to the extender's WiFi network, select **Settings > Connected Devices**.

The WiFi device displays onscreen.

## Deny Access to a Computer or WiFi Device

By default, access control is disabled so that it is easy for you to connect to the extender's WiFi networks.

You can deny network access to specific computers and WiFi devices based on their MAC addresses. Each network device is assigned a MAC address, which is a unique 12-character physical address, containing the hexadecimal characters 0–9, a–f, or A–F only, and separated by colons (for example, 00:09:AB:CD:EF:01). Typically, the MAC address is on the label of the WiFi device. If you cannot access the label, you can display the MAC address using the network configuration utilities of the computer. You might also find the MAC addresses on the Connected Devices page (see [View Connected Devices](#) on page 24).

### ➤ To use WiFi access control to deny access:

1. On a computer or WiFi device that is connected to the extender network, launch a web browser.
2. In the address field of your browser, enter **www.mywifiext.net**.  
A login window opens.
3. Enter your email address and password and click the **LOG IN** button.  
The Status page displays.
4. If your browser displays the **Menu** icon , click it.  
The extender menu displays.
5. Select **Settings > Connected Devices**.

**Connected Devices**

WiFi Extender

IP Address	Network Name (SSID)	MAC Address	Virtual MAC Address
192.168.1.101	Millers_2GEXT	00:00:00:00:00:01	02:00:00:00:00:01
192.168.1.101	Millers_5GEXT	00:00:00:00:00:10	02:00:00:00:00:10

Wired Devices Refresh

IP Address	Device Name	MAC Address	Virtual MAC Address
192.168.1.102	techpubs	00:1A:6B:6D:8F:19	02:0F:B5:6D:8F:19

WiFi Devices Refresh

Enable Access Control

IP Address	Device Name	MAC Address	Virtual MAC Address

CANCEL
SAVE

6. In the WiFi Devices section, select the **Enable Access Control** check box.

The WiFi devices table displays the names and MAC addresses of WiFi devices that are connected to the extender.

7. Select the **Deny** check box for the device.
8. Click the **SAVE** button.

Your settings are saved and that device cannot connect to the extender's WiFi network.

## Set Up an Access Schedule

You can control access to all users during specific periods of the day. You can set up an access schedule that prevents Internet access through the extender network based on the times that you set.

### ➤ To set up an access schedule:

1. On a computer or WiFi device that is connected to the extender network, launch a web browser.
2. In the address field of your browser, enter **www.mywifiext.net**.

A login window opens.

3. Enter your email address and password and click the **LOG IN** button.

The Status page displays.

4. If your browser displays the **Menu** icon ☰, click it.

The extender menu displays.

5. Select **Do More > Access Schedule**.

**Access Schedule**

You can use this feature to control access to all users during specific periods of the day. You can also use this feature for parental controls or security. Access Schedule disables your Internet access based on times you set. **Note:** Access schedule works only in extender mode. [Learn More >](#)

---

Access Schedule On
  Access Schedule Off

---

**Time Zone**

(GMT) Greenwich Mean Time: Dublin, Edinburgh, Lisbon, London

Automatically adjust for daylight savings time

6. Select the **Access Schedule On** radio button.

The page adjusts.

7. In the **Days** menu and the **Time** menu, select the day and time when you want to disable Internet access.
8. Click the **Add Time** button to add the time that you specified to the Scheduled Times table.
9. Click the **SAVE** button.

Your settings are saved.

## Change the Extender's Device Name

The default name is EX6130.

### ➤ To change the extender's device name:

1. On a computer or WiFi device that is connected to the extender network, launch a web browser.
2. In the address field of your browser, enter **www.mywifiext.net**.

A login window opens.

3. Enter your email address and password and click the **LOG IN** button.

The Status page displays.

4. If your browser displays the **Menu** icon , click it.

The extender menu displays.

5. Select **Settings > Wireless**.

The WiFi Settings page displays.

6. Scroll down and click the **IP Address** heading.

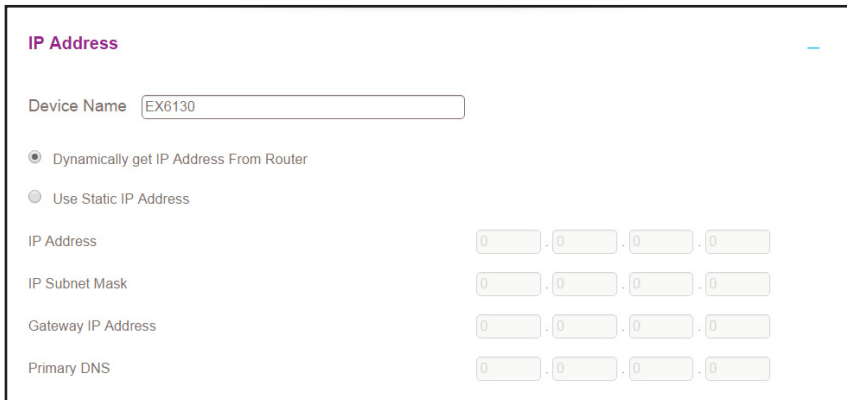

7. In the **Device Name** field, type a name.
8. Click the **SAVE** button.

Your settings are saved.

## Set Up the Extender to Use a Static IP Address

The extender comes set up to use a dynamic IP address, which is the correct setting for most home networks.

➤ **To set up the extender to use a static IP address:**

1. On a computer or WiFi device that is connected to the extender network, launch a web browser.

2. In the address field of your browser, enter **www.mywifiext.net**.

A login window opens.

3. Enter your email address and password and click the **LOG IN** button.

The Status page displays.

4. If your browser displays the **Menu** icon ☰, click it.

The extender menu displays.

5. Select **Settings > Wireless**.

The WiFi Settings page displays.

6. Scroll down and click the **IP Address** heading.

By default, the **Dynamically get IP Address From Router** radio button is selected.

7. Select the **Use Static IP Address** radio button.

8. Complete the fields to specify the IP network IP addresses.

9. Click the **SAVE** button.

Your settings are saved.

## Use the Extender With MAC Filtering or Access Control

When the WiFi device connects through the extender to your router, the MAC address of the WiFi device that is shown on the router is translated to another MAC address. If your router's

MAC filter, WiFi access control, or ACL is enabled, the WiFi device connects to the extender but cannot get an IP address from the extender and cannot access the Internet. To allow the WiFi device to receive an IP address from the extender and access the Internet, you must provide the translated MAC address to the router.

➤ **To add a translated MAC address to your router:**

1. Log in to your router and disable the MAC filter, WiFi access control, or ACL.  
For information about how to disable your router's MAC filter, WiFi access control, or ACL, see your router's documentation.
2. Power on the extender and connect all of your WiFi devices to the extender.
3. Make sure that the Link Rate LED remains lit.
4. Log in to your extender:
  - a. Launch a web browser.
  - b. Enter **www.mywifiext.net** in the address field of the browser.  
A login window opens.
  - c. Enter your email address and password and click the **LOG IN** button.  
The Status page displays.
5. If your browser displays the **Menu** icon , click it.  
The extender menu displays.
6. Select **Settings > Connected Devices**.  
The Connected Devices section displays the MAC addresses and virtual MAC addresses for computers and WiFi devices that are connected to the extender network.
7. On the router, add the extender's virtual MAC address and all the virtual MAC addresses connected to the extender network to your router's MAC filter table.
8. Enable the router's MAC filter, WiFi access control, or ACL.

# Maintain and Monitor the Extender

---

# 5

This chapter covers the following topics:

- *Change the Extender Login User Name and Password*
- *Turn Password Protection Off and On*
- *Recover a Forgotten User Name or Password*
- *Automatically Adjust for Daylight Saving Time*
- *Manually Set the Extender Clock*
- *Change the Extender's Time Zone*
- *Back Up and Restore the Extender Configuration*
- *Return the Extender to Its Factory Default Settings*
- *Update the Firmware*
- *Restart the Extender Remotely*

## Change the Extender Login User Name and Password

You can change the user name and password to log in to the extender.

➤ **To change the extender login user name and password:**

1. On a computer or WiFi device that is connected to the extender network, launch a web browser.

2. In the address field of your browser, enter **www.mywifiext.net**.

A login window opens.

3. Enter your email address and password and click the **LOG IN** button.

The Status page displays.

4. If your browser displays the **Menu** icon , click it.

The extender menu displays.

5. Select **Settings > Password**.

**Password Settings**

Turn on or off password protection or change a password to protect unauthorized access to the extender web menu and Smart Setup.

---

Password On
  Password Off

---

New User Name

New Password (8-32 characters):

Verify Password:

Select a question ▼

Answer

Select a question ▼

6. In the **New User Name** field, type the user's email address.

7. Type the password in the **New Password** field and the **Verify Password** field.

8. Select questions and enter the answers.

9. Click the **SAVE** button.

Your settings are saved.



## Turn Password Protection Off and On

We recommend that you leave password protection on to help keep your network secure. You can turn password protection off and on.

### ➤ To turn password protection off or on:

1. On a computer or WiFi device that is connected to the extender network, launch a web browser.
2. In the address field of your browser, enter **www.mywifiext.net**.  
A login window opens.
3. Enter your email address and password and click the **LOG IN** button.  
The Status page displays.
4. If your browser displays the **Menu** icon , click it.  
The extender menu displays.
5. Select **Settings > Password Settings**.  
The Password Settings page displays.
6. Select the **Password Off** or **Password On** radio button.
7. Click the **SAVE** button.  
Your settings are saved.

## Recover a Forgotten User Name or Password

If you changed the password to access the extender and set up password recovery, you can recover your password if you lose it.

### ➤ To recover your password to access the extender:

1. On a computer or WiFi device that is connected to the extender network, launch a web browser.
2. In the address field of your browser, enter **www.mywifiext.net**.  
You are prompted to enter a user name and password.
3. Click the **Username & Password Help** link.  
A page displays requesting the answers to your security questions.  
If you forgot the answers to your security questions, restore the extender's factory settings and set up your login credentials again. See *Return the Extender to Its Factory Default Settings* on page 46.
4. Enter the saved answers to your security questions.
5. Click the **NEXT** button.

Your email and password are displayed.

6. Click the **BACK** button.  
A login window opens.
7. Log in to the extender.

## Automatically Adjust for Daylight Saving Time

1. On a computer or WiFi device that is connected to the extender network, launch a web browser.
2. In the address field of your browser, enter **www.mywifiext.net**.  
A login window opens.
3. Enter your email address and password and click the **LOG IN** button.  
The Status page displays.
4. If your browser displays the **Menu** icon , click it.  
The extender menu displays.
5. Select **Do More > Access Schedule**.  
The Access Schedule page displays.
6. Select the **Automatically adjust for daylight savings** time check box.
7. Click the **SAVE** button.  
Your settings are saved.

## Manually Set the Extender Clock

If you set up an access schedule, set the extender clock so that the access schedule is accurate.

### ➤ To manually set the extender clock:

1. On a computer or WiFi device that is connected to the extender network, launch a web browser.
2. In the address field of your browser, enter **www.mywifiext.net**.  
A login window opens.
3. Enter your email address and password and click the **LOG IN** button.  
The Status page displays.
4. If your browser displays the **Menu** icon , click it.  
The extender menu displays.

## 5. Select **Do More > Access Schedule**.

### Access Schedule

You can use this feature to control access to all users during specific periods of the day. You can also use this feature for parental controls or security. Access Schedule disables your Internet access based on times you set. **Note: Access schedule works only in extender mode.** [Learn More >](#)

Access Schedule On     Access Schedule Off

---

Days:       Time:

24 Hours     From  to

---

### Scheduled Times

Your Internet connection will be disabled during the following times:

From	To	Days	Delete

---

### Extender Clock

Set the internal WiFi Extender clock. Your settings need to be accurate in order for WiFi access schedules to work correctly. If you choose to manually set the clock, after a power cycle the access schedule will be disabled until the clock is set again.

Automatic (recommended)     Manual

Current Time:

---

### Time Zone

Automatically adjust for daylight savings time

6. In the Extender Clock section, select the **Manual** radio button.
7. To specify the time, complete the fields or click the **Sync Clock** button to synchronize the extender time to the time on the computer or WiFi device that you are using.
8. Click the **SAVE** button.

Your settings are saved.

## Change the Extender's Time Zone

### ➤ To change the extender's time zone:

1. On a computer or WiFi device that is connected to the extender network, launch a web browser.
2. In the address field of your browser, enter **www.mywifiext.net**.

A login window opens.

- Enter your email address and password and click the **LOG IN** button.  
The Status page displays.
- If your browser displays the **Menu** icon , click it.  
The extender menu displays.
- Select **Do More > Access Schedule**.

**Access Schedule**

You can use this feature to control access to all users during specific periods of the day. You can also use this feature for parental controls or security. Access Schedule disables your Internet access based on times you set. Note: Access schedule works only in extender mode. [Learn More >](#)

---

Access Schedule On
  Access Schedule Off

---

**Time Zone**

---

(GMT) Greenwich Mean Time: Dublin, Edinburgh, Lisbon, London ▼

Automatically adjust for daylight savings time

CANCEL
SAVE

- In the Time Zone section, select your time zone from the menu.
- If you want the extender to automatically adjust for daylight saving time, select the **Automatically adjust for daylight savings time** check box.
- Click the **SAVE** button.  
Your settings are saved.

## Back Up and Restore the Extender Configuration

When the extender works correctly after initial setup, we recommend that you back up the extender configuration settings. After you back up the settings, if you change the extender configuration settings but are not content with the new settings, you can restore the extender configuration to the backed-up settings.

### Back Up the Configuration Settings

You can back up the configuration file of the extender.

- **To back up the extender configuration settings:**
  - On a computer or WiFi device that is connected to the extender network, launch a web browser.
  - In the address field of your browser, enter **www.mywifiext.net**.  
A login window opens.

3. Enter your email address and password and click the **LOG IN** button.  
The Status page displays.
4. If your browser displays the **Menu** icon , click it.  
The extender menu displays.
5. Select **Settings > Other**.

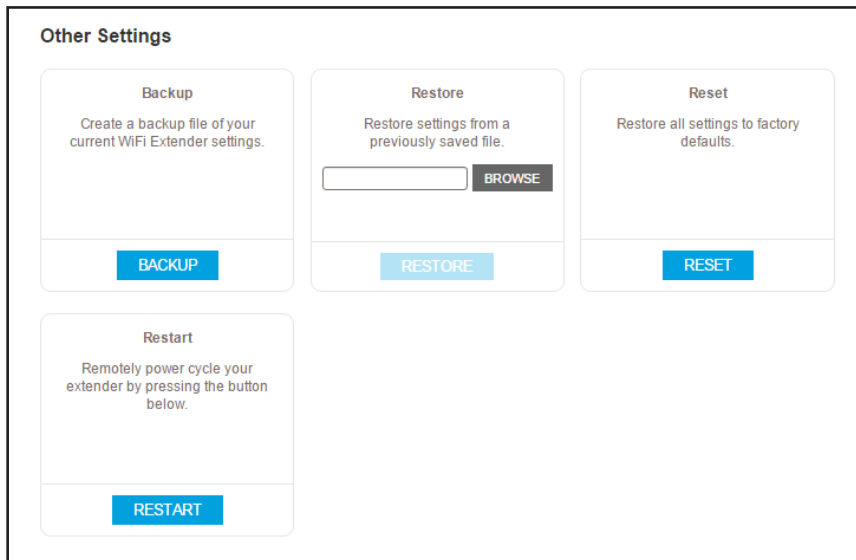

6. Click the **BACKUP** button.  
Your browser extracts the configuration file from the extender. By default, the name of the backup file is `NETGEAR_Ex6130.cfg`.
7. If your browser is not set up to save downloaded files automatically, locate where you want to save the file.
8. Click the **OK** button.  
The extender configuration settings are backed up.

## Restore the Configuration Settings

You can restore the configuration file of the extender to a previously saved configuration file.

### ➤ To restore the extender configuration settings:

1. On a computer or WiFi device that is connected to the extender network, launch a web browser.
2. In the address field of your browser, enter **www.mywifiext.net**.  
A login window opens.
3. Enter your email address and password and click the **LOG IN** button.  
The Status page displays.

- If your browser displays the **Menu** icon , click it.  
The extender menu displays.
- Select **Settings > Other**.

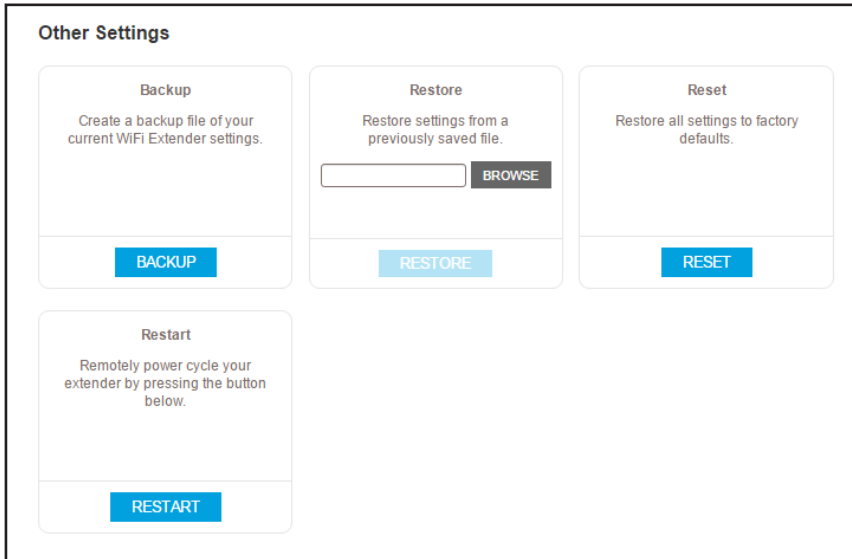

- Click the **BROWSE** button.
- Locate and select the previously saved backup file.  
By default, the name of the backup file is `NETGEAR_EX6000.cfg`.



**CAUTION:**

After you click the **RESTORE** button, do not try to go online, turn off the extender, shut down the computer, or do anything else to the extender until it finishes restarting.

- Click the **RESTORE** button.  
A confirmation pop-up window opens.
- Confirm your decision.  
The extender configuration is restored and the extender restarts. This process takes about one minute.

## Return the Extender to Its Factory Default Settings

Under some circumstances (for example, if you lose track of the changes that you made to the extender settings), you might want to erase the configuration and reset the extender to factory default settings.

To reset the extender to factory default settings, you can either use the **Factory Reset** button on the side panel or log in to the extender and reset it.

For a list of factory default settings, see *Factory Default Settings* on page 56.

## Use the Factory Reset Button to Reset the Extender

- To use the **Factory Reset** button to return the extender to factory default settings:



### CAUTION:

This process erases any settings that you configured in the extender.

1. Insert a straightened paper clip into the hole of the **Factory Reset** button and hold it for about seven seconds.

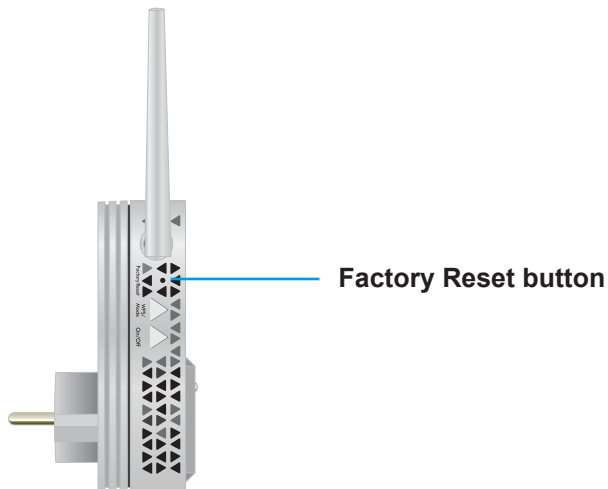

2. Release the button.



### CAUTION:

Do not try to go online, turn off the extender, shut down the computer, or do anything else to the extender until it finishes restarting.

The extender resets and restarts. This process takes about one minute.

## Log In to the Extender to Reset the Extender

- To log in to the extender and reset the extender to factory settings:



### CAUTION:

This process erases any settings that you configured in the extender.

1. On a computer or WiFi device that is connected to the extender network, launch a web browser.
2. In the address field of your browser, enter **www.mywifiext.net**.  
A login window opens.
3. Enter your email address and password and click the **LOG IN** button.  
The Status page displays.
4. If your browser displays the **Menu** icon ☰, click it.  
The extender menu displays.
5. Select **Settings > Other Settings**.

The screenshot shows the 'Other Settings' page with the following content:

- Backup:** Create a backup file of your current WiFi Extender settings. Button: **BACKUP**
- Restore:** Restore settings from a previously saved file. Includes a text input field and a **BROWSE** button. Button: **RESTORE**
- Reset:** Restore all settings to factory defaults. Button: **RESET**
- Restart:** Remotely power cycle your extender by pressing the button below. Button: **RESTART**



### CAUTION:

After you click the **RESET** button, do not try to go online, turn off the extender, shut down the computer, or do anything else to the extender until it finishes restarting.

6. Click the **RESET** button.  
A confirmation pop-up window opens.



7. Confirm your decision.

The extender returns to its factory settings and restarts. This process takes about one minute.

## Update the Firmware

Unless you changed the settings on the Firmware Update page previously, the extender is set up to check for new firmware automatically at login.

➤ **To check manually for new firmware and, if available, update the firmware:**

1. On a computer or WiFi device that is connected to the extender network, launch a web browser.

2. In the address field of your browser, enter **www.mywifiext.net**.

A login window opens.

3. Enter your email address and password and click the **LOG IN** button.

The Status page displays.

4. If your browser displays the **Menu** icon ☰, click it.

The extender menu displays.

5. Select **Settings > Firmware Update**.

6. Click the **CHECK ONLINE** button.

7. If new firmware is available, follow the onscreen prompts to download it onto your computer.

**Note:** You might need to unzip the firmware file.

8. Click the **BROWSE** button.

9. Locate and select the new firmware file.

The firmware file name ends with a `.chk` extension.

**CAUTION:**

After you click the **UPLOAD** button, do not try to go online, turn off the extender, shut down the computer, or do anything else to the extender until it finishes restarting.

10. Click the **UPLOAD** button.

The firmware update starts and the extender restarts. The firmware update process takes about two minutes.

## Restart the Extender Remotely

You can log in to the extender and restart it. When the extender restarts, all computers and WiFi devices that are connected to its WiFi network are automatically disconnected.

➤ **To restart the extender remotely:**

1. On a computer or WiFi device that is connected to the extender network, launch a web browser.
2. In the address field of your browser, enter **www.mywifiext.net**.

A login window opens.

3. Enter your email address and password and click the **LOG IN** button.

The Status page displays.

4. If your browser displays the **Menu** icon , click it.

The extender menu displays.

5. Select **Settings > Other Settings**.

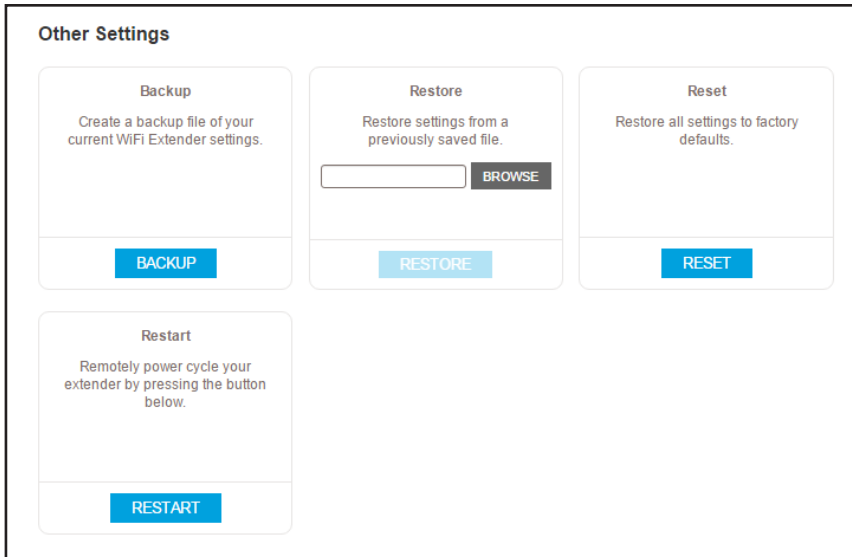

**Other Settings**

<p><b>Backup</b></p> <p>Create a backup file of your current WiFi Extender settings.</p> <p><b>BACKUP</b></p>	<p><b>Restore</b></p> <p>Restore settings from a previously saved file.</p> <p><input type="text"/> <b>BROWSE</b></p> <p><b>RESTORE</b></p>	<p><b>Reset</b></p> <p>Restore all settings to factory defaults.</p> <p><b>RESET</b></p>
<p><b>Restart</b></p> <p>Remotely power cycle your extender by pressing the button below.</p> <p><b>RESTART</b></p>		

6. Click the **RESTART** button and click the **Yes** button to confirm.  
The extender restarts, which takes about two minutes.

# FAQs and Troubleshooting

---

# 6

This chapter covers the following topics:

- *FAQs*
- *Cannot Connect to the Extender*
- *Cannot Join a WiFi Network and Receive an Error Message*

## FAQs

This section provides answers for difficulties you might experience with the extender.

### **The web browser setup keeps asking me for my network password (passphrase) or security key, and I am sure that I entered the correct password. What can I do?**

The extender is probably placed at the borderline of the range covered by the router or access point. For more information about where to place the extender, see *Find the Best Location* on page 14.

If you are using WEP security, make sure that you are typing the network password in the correct field.

### **Can I set up the extender in extender mode if I connect it to the router or access point with an Ethernet cable?**

No. The extender is designed to use a WiFi connection to the router or access point if it is in extender mode. If the extender is in access point mode, you can connect it to the router or access point with an Ethernet connection. For more information about access point mode, see *Use the Extender in Access Point Mode* on page 15.

### **I forgot my login email address and password. What can I do?**

In the login window, click the **Username & Password Help** link and answer the security questions that you set up during the initial setup. For more information, see *Recover a Forgotten User Name or Password* on page 41.

If you forgot the answers to your security questions, you can restore the extender's factory settings and perform the setup again.

#### ➤ **To restore factory settings:**

1. Use a sharp object such as a pen or paper clip to press and hold the **Factory Reset** button on the extender for seven seconds until the Power LED lights amber.
2. Release the **Factory Reset** button and wait for the extender to reboot.

The extender resets and returns to the factory default settings.

## Cannot Connect to the Extender

If you cannot connect to the extender, determine what prevents you from connecting:

- If you forgot your user name or password, click the **Username & Password Help** link. For more information, see *FAQs* on page 53.
- If your browser displays an error page, include **http://** in the address field of your browser by typing **http://www.mywifiext.net**.
- If you already set up the extender but can no longer connect to it over WiFi, check to see if the Device Link LED is off or red. If it is, try moving your computer or WiFi device closer to the extender.

- If you cannot get a WiFi connection working, you can use an Ethernet cable to connect your computer to the extender.

## Cannot Join a WiFi Network and Receive an Error Message

To join a WiFi network, you must know its network name (also called the SSID) so that you can select it. If the network is secure, you must know the passphrase or key. If the extender does not connect to the network that you select, the cause might be one of the following:

- It is possible that you typed the network name, passphrase, or key incorrectly. Use Smart Setup (see *Run Smart Setup Installation* on page 16) to select a WiFi network and retype the passphrase or key. The passphrase or key is case-sensitive. For example, PASSWORD25 is not the same as Password25 or password25.
- If the extender cannot detect your WiFi network, check to see if your WiFi network is still working. Make sure that the WiFi router is turned on. If possible, move the extender closer to the WiFi router.
- If the extender Device Link LED is red, the WiFi connection between the WiFi router and the extender is poor. You can establish the best connection with a clear line of sight between the extender and the WiFi router. Make sure that no physical obstacles exist between the extender and the WiFi router, and try to move the extender closer to the WiFi router.

If you use Smart Setup, and the extender does not connect to the WiFi router, does not connect to the Internet, or cannot get an IP address from the WiFi router, Smart Setup displays a message to notify you that the extender is not configured.

To run Smart Setup again, click the **YES** button. To manually configure the extender, click the **NO, I'LL CONNECT MANUALLY** button.

# A

## Factory Settings and Technical Specifications

---

This appendix covers the following topics:

- *Factory Default Settings*
- *Technical and Environmental Specifications*

## Factory Default Settings

To reset the extender to factory default settings, you can use the **Factory Reset** button on the side panel or you can log in and click the onscreen **RESET** button. For more information, see [Return the Extender to Its Factory Default Settings](#) on page 46.

The following table shows the factory default settings.

**Table 2. Factory default settings**

Feature	Default Settings
Smart Setup	Enabled
WiFi communication	Enabled
WiFi network name (SSID)	NETGEAR_EXT
Security	Disabled
Transmission speed	Auto <sup>1</sup>
Country/region	Varies by region
Operating mode	802.11a/b/g/n/ac
Data rate in the 2.4 GHz band	Up to 300 Mbps
Data rate in the 5 GHz band	Up to 867 Mbps
DHCP	Client enabled

1. Maximum WiFi signal rate (IEEE Standard 802.11). Actual throughput can vary. Network conditions and environmental factors, including volume of network traffic, building materials and construction, and network overhead lower actual data throughput rate.



## Technical and Environmental Specifications

The following table shows the technical and environmental specifications.

**Table 3. Technical specifications**

Technical Specifications	
Network protocol and standards compatibility	Data and routing protocols: TCP/IP, DHCP server and client, DNS relay
Physical specifications	<ul style="list-style-type: none"> <li>• Dimensions: 144 x 55 x 43mm (5.67 x 2.17 x 1.69 in.)</li> <li>• Weight: 195 g (0.43 lb)</li> </ul>
Environmental	<ul style="list-style-type: none"> <li>• Operating temperature: 32° to 140°F (0° to 40°C)</li> <li>• Operating humidity: 90% maximum relative humidity, noncondensing</li> </ul>
Interface	<ul style="list-style-type: none"> <li>• Local: 10BASE-T, 100BASE-TX, RJ-45</li> <li>• 802.11ac, 802.11a, 802.11n, 802.11g, 802.11b</li> </ul>