



# MULTIMEDIA PROJECTOR

# 4K500ST

# User's Manual



Safety Instructions

Before Use

Basic Guide

Installation Procedure

Connection Procedure

Projection Procedure

Convenient Features

Advanced Guide

Using Menus

Menu Settings

Advanced Projection

Other Information

Maintenance

Product Specifications

Troubleshooting

ENG

# How to Use This Manual

Thank you for purchasing a Canon projector.

The 4K500ST Multimedia Projector (hereinafter referred to as “the projector”) is a high-performance projector that is capable of projecting a high-resolution computer screen and high-quality digital image on a large screen.

## This Manual

This is the user’s manual for the 4K500ST Multimedia Projector. The “Basic Guide” section describes installation and basic use of the projector. Descriptions of menus and how to connect the projector to a network are given in the “Advanced Guide” section. Read this manual thoroughly to make the most of your projector.

Installation of the projector should be performed by a qualified technician, if possible. Contact the Canon Customer Support Center for further information.

## Symbols of Button Operations

The projector can be operated using the buttons on the remote control or on the side of the projector. The remote control allows you to operate all functions of the projector.

In this document, the button’s operations are shown as below.

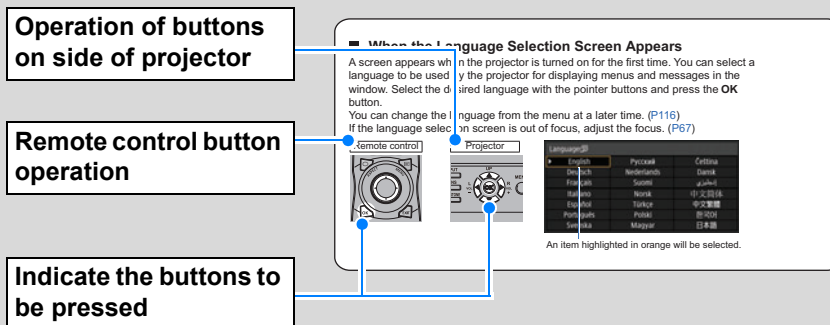

## Symbols Used in This Manual

Sections labeled with these symbols give the following kinds of information.

⚠ A precaution about operation or restriction is given here.

📄 Indicates supplemental information to note in use.

# Table of Contents

<b>How to Use This Manual</b> .....	2
<b>Projector Highlights</b> .....	4
<b>Safety Instructions</b> .....	5
Precautions for Use .....	12
Installation and Handling	
Precautions .....	13
Precautions on the Lamp .....	14
Precautions for the Batteries of the	
Remote Control .....	15
<b>For Safe Use</b> .....	17
<b>Before Installation</b> .....	18
Precautions When Carrying/Shipping	
the Projector .....	18
Precautions for Installation.....	18
<b>Open Source Software</b> .....	23
<b>Before Use</b> .....	24
Included Accessories .....	24
Part Names .....	25
Preparing the Remote Control.....	32
<b>Basic Guide</b> .....	35
<b>Installation Procedure</b> .....	36
Setting Up the Projector .....	36
Ceiling Mounting .....	38
Parts Lineup .....	39
Mounting Position.....	40
Assembly and Installation.....	42
Adjust the Projection Angle .....	48
Relationship between Projecting	
Distance and Image Size .....	50
Lens Shift Function .....	51
<b>Connection Procedure</b> .....	53
Connecting a Computer .....	53
Connecting AV Equipment.....	54
Multi Input 4K Projection.....	55
Plugging the Projector In .....	59
<b>Projection Procedure</b> .....	60
Step 1 Turn the Projector On .....	60
Step 2 Select an Input Signal.....	63
Step 3 Adjust the Image .....	65
Step 4 Select an Aspect Ratio (Screen	
Aspect) Matching the Screen.....	72
Step 5 Adjusting Keystone	
Distortion .....	73
Step 6 Select the Image Quality (Image	
Mode) .....	76
Step 7 Turn the Projector Off.....	79
<b>Convenient Features</b> .....	80
<b>Advanced Guide</b> .....	83
<b>Using Menus</b> .....	84
Menu Configuration .....	84
Basic Menu Operations .....	85
<b>Menu Settings</b> .....	87
Input settings .....	87
Image adjustment .....	90
Install settings.....	97
System settings .....	108
Network settings .....	122
Completing Computer Settings for a	
Network Connection .....	130
Checking Projector Information .....	148
<b>Advanced Projection</b> .....	149
Projecting from Multiple Projectors at	
Once (Edge Blending) .....	149
Advanced Registration to Adjust	
Projected Images .....	153
Adjusting Peripheral Focus .....	157
<b>Other Information</b> .....	159
<b>Maintenance</b> .....	160
Cleaning the Projector.....	160
Cleaning the Air Filter.....	160
Replacing the Air Filter.....	161
Replacing the Lamp.....	163
Replacement Lamp .....	164
Lamp Replacement Procedure .....	165
<b>Product Specifications</b> .....	168
Displayed Test Patterns .....	168
Supported Signal Types .....	169
Specifications.....	174
<b>Troubleshooting</b> .....	180
LED Indicator Details .....	180
Symptoms and Solutions .....	181
<b>Index</b> .....	186
<b>Option</b> .....	188

# Projector Highlights

## 4K Projection Using 4096 x 2400 LCOS Panels

Outstanding projection resolution of up to 4096 x 2400 is possible, using three 0.76 inch liquid crystal on silicon (LCOS) panels in conjunction with dual high-performance image processors and a new 4K-compatible wide zoom lens.

## Bright Yet Compact

Projects images at a bright 5,000 lumens but is also compact, at 470 x 533.5 x 175 mm (18.5 x 6.9 x 21.0 in., W x D x H). ([P174](#))

## Supports Fully Digital Input

Projects multiple sources of input in 4K, with two terminals for HDMI and four for DVI input. A single HDMI terminal can be used for 3840 x 2160 (30 Hz) video signals. ([P55](#))

## Peripheral Focus Adjustment

Image focus can be adjusted on the edges of the screen, enabling use in dome projection. ([P102](#), [P157](#))

## Edge Blending

Blend the overlapping edges of images from multiple projectors to make the overall image more seamless. ([P103](#))

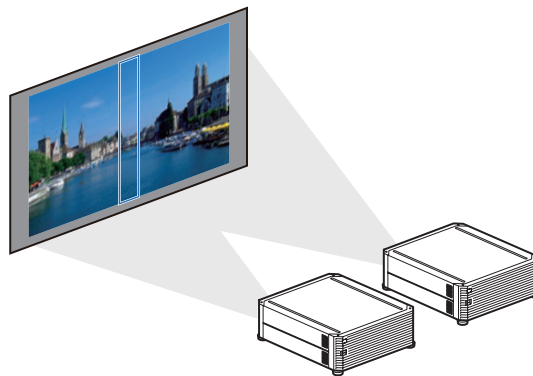

## High-Precision Image Registration

Precise correction of red, green, or blue misalignment in different areas of the screen is possible by color and area. ([P101](#))

## Superior Video Viewing Experience





Refinements in motion blur reduction make video projection more enjoyable to watch. ([P115](#))

# Safety Instructions

Before installing and operating the projector, read this manual thoroughly. This projector provides many convenient features and functions. Operating the projector properly enables you to manage those features and maintain it in good condition for many years to come.

Improper operation may result in not only shortening the product life, but also malfunctions, fire hazards, or other accidents.

If your projector does not seem to be operating properly, read this manual again, check operations and cable connections, and try the solutions in the “Troubleshooting” section in the back of this manual. If the problem still persists, contact the Canon Customer Support Center.

	<b>CAUTION</b> <b>RISK OF ELECTRIC SHOCK</b> <b>DO NOT OPEN</b>	
<b>CAUTION: TO REDUCE THE RISK OF ELECTRIC SHOCK, DO NOT REMOVE COVER (OR BACK). NO USER-SERVICEABLE PARTS INSIDE EXCEPT LAMP REPLACEMENT. REFER SERVICING TO QUALIFIED SERVICE PERSONNEL.</b>		
	THIS SYMBOL INDICATES THAT DANGEROUS VOLTAGE CONSTITUTING A RISK OF ELECTRIC SHOCK IS PRESENT WITHIN THIS UNIT.	
	THIS SYMBOL INDICATES THAT THERE ARE IMPORTANT OPERATING AND MAINTENANCE INSTRUCTIONS FOR THIS UNIT IN THE OWNER'S MANUAL.	

<b>CAUTION</b> Not for use in a computer room as defined in the Standard for the Protection of Electronic Computer / Data Processing Equipment, ANSI / NFPA 75.
--

### Safety Precautions

#### WARNING:

- **THIS APPARATUS MUST BE GROUNDED.**
- **TO REDUCE THE RISK OF FIRE OR ELECTRIC SHOCK, DO NOT EXPOSE THIS APPLIANCE TO RAIN OR MOISTURE.**
- This projector produces intense light from the projection lens. Do not stare directly into the lens, otherwise eye damage could result. Be especially careful that children do not stare directly into the beam.
- Install the projector in a proper position. Otherwise it may result in a fire hazard.
- Allowing the proper amount of space on the top, sides, and rear of the projector cabinet is critical for proper air circulation and cooling of the unit. The diagrams shown here indicates the minimum space required. If the projector is to be built into a compartment or similarly enclosed, these minimum distances must be maintained.

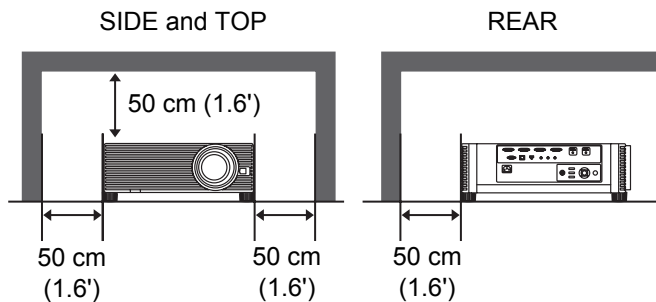

- Do not cover the ventilation slots on the projector. Heat build-up can reduce the service life of your projector, and can also be dangerous.
- If the projector is unused for an extended time, unplug the projector from the power outlet.
- Do not project the same image for a long time.

An afterimage may remain on the LCD panels due to the characteristics of the panels of the projector.

### CAUTION ON HANGING FROM THE CEILING

When hanging the projector from the ceiling, clean the air intake vents and top of the projector periodically with a vacuum cleaner. If you leave the projector unclean for a long time, the cooling fans can be clogged with dust, and it may cause a breakdown or a disaster.

**DO NOT SET THE PROJECTOR IN GREASY, WET, OR SMOKY CONDITIONS SUCH AS IN A KITCHEN TO PREVENT A BREAKDOWN OR A DISASTER. IF THE PROJECTOR COMES IN CONTACT WITH OIL OR CHEMICALS, IT MAY BECOME DETERIORATED.**

## ■ READ AND KEEP THIS OWNER'S MANUAL FOR LATER USE.

All the safety and operating instructions should be read before beginning to operate the product.

Read all of the instructions given here and retain them for later use. Unplug this projector from the AC power supply before cleaning. Do not use liquid or aerosol cleaners on the projector. Use a damp cloth for cleaning.

Follow all warnings and instructions marked on the projector.

For added protection of the projector during a lightning storm, or when it is left unattended or unused for long periods of time, unplug it from the wall outlet. This will prevent damage due to lightning and power surges.

---

Do not expose this unit to rain or use near water... for example, in a wet basement, near a swimming pool, etc...

Do not use attachments not recommended by the manufacturer as they may result in hazards.

Do not place this projector on an unstable cart, stand, or table. The projector may fall, causing serious injury to a child or adult, and serious damage to the projector. Use only with a cart or stand recommended by the manufacturer, or sold with the projector. Wall or shelf mounting should be carried out in accordance with the manufacturer's directions, and should use a mounting kit approved by the manufacturers.

An appliance and cart combination should be moved with care. Sudden stops, excessive force, and uneven surfaces may cause the appliance and cart combination to overturn.



Slots and openings in the rear and front of the cabinet are provided for ventilation, to insure reliable operation of the equipment and to protect it from overheating.

The openings should never be covered with cloth or other materials, and the bottom opening should not be blocked by placing the projector on a bed, sofa, rug, or other similar surface. This projector should never be placed near or over a radiator or heat register.

This projector should not be placed in a built-in installation such as a book case unless proper ventilation is provided.

## Safety Instructions

Never push objects of any kind into this projector through cabinet slots as they may touch dangerous voltage points or short out parts that could result in a fire or electric shock. Never spill liquid of any kind onto the projector.

Do not install the projector near the ventilation duct of air-conditioning equipment.

This projector should be operated using only the type of power source indicated on the marking label. If you are not sure of the type of power supplied, contact the Canon Customer Support Center or local power company.

Do not overload wall outlets and extension cords as this can result in fire or electric shock. Do not allow anything to rest on the power cord. Do not locate this projector where the cord may be damaged by people walking on it.

Do not attempt to service this projector yourself as opening or removing covers may expose you to dangerous voltages or other hazards. Refer all servicing to qualified service personnel.

Unplug this projector from the wall outlet and refer servicing to qualified service personnel under the following conditions:

- a. When the power cord or plug is damaged or frayed.
- b. If liquid has been spilled into the projector.
- c. If the projector has been exposed to rain or water.
- d. If the projector does not operate normally after following the operating instructions. Adjust only those controls that are covered in the operating instructions as improper adjustment of other controls may result in damage and will often require extensive work by a qualified technician to restore the projector to normal operating condition.
- e. If the projector has been dropped or the cabinet has been damaged.
- f. When the projector exhibits a distinct change in performance-this indicates a need for servicing.

When replacement parts are required, be sure the service technician uses replacement parts specified by the manufacturer that have the same characteristics as the original parts. Unauthorized substitutions may result in fire, electric shock, or injury.

Upon completion of any service or repairs to this projector, ask the service technician to perform routine safety checks to determine that the projector is in safe operating condition.



## AC Power Cord Requirement

The AC Power Cord supplied with this projector meets the requirements for use in the country you purchased it.

### AC Power Cord for the United States and Canada:

The AC Power Cord used in the United States and Canada is listed by the Underwriters Laboratories (UL) and certified by the Canadian Standard Association (CSA).

The AC Power Cord has a grounding-type AC line plug. This is a safety feature to ensure the plug fits into the power outlet. Do not try to tamper with this safety feature. Should you be unable to insert the plug into the outlet, contact your electrician.

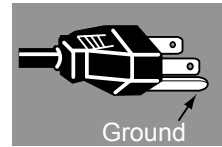

### THE SOCKET-OUTLET SHOULD BE INSTALLED NEAR THE EQUIPMENT AND EASILY ACCESSIBLE.



For the U.S. and Canada, LAMP (S) INSIDE THIS PRODUCT CONTAIN MERCURY AND MUST BE RECYCLED OR DISPOSED OF ACCORDING TO LOCAL, MUNICIPAL, STATE, PROVINCIAL, OR FEDERAL LAWS. For lamp recycling and disposal information please call 1-800-OK-CANON for the U.S. and Canada.



### Only for European Union and EEA (Norway, Iceland and Liechtenstein)

These symbols indicate that this product is not to be disposed of with your household waste, according to the WEEE Directive (2012/19/EU), the Battery Directive (2006/66/EC) and/or national legislation implementing those Directives.



If a chemical symbol is printed beneath the symbol shown above, in accordance with the Battery Directive, this indicates that a heavy metal (Hg = Mercury, Cd = Cadmium, Pb = Lead) is present in this battery or accumulator at a concentration above an applicable threshold specified in the Battery Directive.

This product should be handed over to a designated collection point, e.g., on an authorized one-for-one basis when you buy a new similar product or to an authorized collection site for recycling waste electrical and electronic equipment (EEE) and batteries and accumulators. Improper handling of this type of waste could have a possible impact on the environment and human health due to potentially hazardous substances that are generally associated with EEE. Your cooperation in the correct disposal of this product will contribute to the effective usage of natural resources.

For more information about the recycling of this product, please contact your local city office, waste authority, approved scheme or your household waste disposal service or visit

[www.canon-europe.com/weee](http://www.canon-europe.com/weee), or [www.canon-europe.com/battery](http://www.canon-europe.com/battery).

## **Federal Communication Commission Notice**

Model: 4K500ST

This device complies with Part 15 of the FCC Rules. Operation is subject to the following two conditions:

1. This device may not cause harmful interference, and
2. This device must accept any interference received, including interference that may cause undesired operation.





Note: This equipment has been tested and found to comply with the limits for a Class A digital device, pursuant to Part 15 of the FCC Rules. These limits are designed to provide reasonable protection against harmful interference when the equipment is operated in a commercial environment. This equipment generates, uses, and can radiate radio frequency energy and, if not installed and used in accordance with the instruction manual, may cause harmful interference to radio communications. Operation of this equipment in a residential area is likely to cause harmful interference in which case the user will be required to correct the interference at his own expense. The cable with a ferrite core provided with the projector must be used with this equipment in order to comply with Class A of the FCC Rules. Use of a shielded cable is required to comply with Class A of FCC Rules. Do not make any changes or modifications to the equipment unless otherwise specified in the instructions. If such changes or modifications should be made, you could be required to stop operation of the equipment.

Warning:

This is a class A product. In a domestic environment this product may cause radio interference in which case the user may be required to take adequate measures. The cable with a ferrite core provided with the projector must be used with this equipment in order to comply with Class A .  
Use of a shielded cable is required to comply with Class A .

## Safety Symbols in this Manual

This section describes the safety symbols used in this manual. Important projector safety information is identified by the following symbols. Always observe the safety information by these symbols.

 <b>Warning</b>	Denotes the risk of death or serious injury from improper handling if the information is not observed. To ensure safe use, always observe this information.
 <b>Caution</b>	Denotes the risk of injury from improper handling if the information is not observed. To ensure safe use, always observe this information.
 Prohibition	Denotes prohibited actions.
 Caution	Denotes required actions or information that must be observed.

# Precautions for Use

As this section contains important safety-related information, be sure to read the following carefully beforehand in order to use your projector correctly and safely.

## Warning

During installation, keep the projector plug easily accessible so that the projector can be unplugged immediately if necessary, or keep a circuit breaker within reach.

If the following situations occur, turn the power off, remove the power plug from the power outlet and contact the Canon Customer Support Center. Failure to do so could cause a fire or result in an electric shock.

- If smoke is emitted
- If an unusual smell or noise is emitted
- If water or other liquid has entered the projector
- If metal or any other foreign material has entered the projector
- If the projector is knocked over or dropped and the cabinet is damaged

Pay attention to the following points for handling the power cord. Failure to do so may cause a fire, electric shock or personal injury.



Prohibition

- Do not place any objects on the power cord and do not allow it to become trapped under the projector.
- Do not cover the power cord with a carpet.
- Do not modify or excessively bend, twist, pull, wind, or bundle the power cord.
- Keep the power cord away from heaters and other sources of heat.
- Do not use a damaged power cord. If the power cord is damaged, purchase a replacement from your dealer.
- The power cord included with this projector is for use exclusively with this product. Do not use this cord for other products.
  
- Be sure to connect the ground wire of the power cord to ground.
- Be sure to connect the ground wire before connecting the power plug to the outlet. Also when you disconnect the ground wire, be sure to unplug the power plug from the outlet beforehand.

## Warning

Pay attention to the following points regarding the power source, power plug and handling of the connector. Failure to do so may cause a fire, electric shock or personal injury.



- Do not use any power source with a voltage other than the voltage indicated (AC 100–240 V).
- Do not pull the power cord and be sure to hold the power plug or connector when removing. Incorrect handling may damage the power cord.
- Do not insert any metal objects into the contact parts of the power plug or connector.
- Do not remove the power plug or connector with wet hands.



- Insert the power plug and connector securely up to the base. Additionally, do not use a damaged power plug or an outlet that is loose.
- When using an extension cord, do not exceed the cord's rated capacity.



- Periodically inspect the power plug and outlet and remove any dust or dirt from between the plug and the outlet.

## Installation and Handling Precautions

Pay attention to the following points regarding installation and handling of the projector. Failure to do so may cause a fire, electric shock or personal injury.

- Do not use the projector where it might get wet, such as outdoors or by bathtubs or showers.
- Do not place containers containing a liquid on top of the projector.
- Do not touch the projector itself, the power cord, or the cable if lightning strikes.
- Do not move the projector until you have switched off the power, removed the power plug from the power outlet and unplugged any other cables.
- Unplug the projector before cleaning or maintenance.

### **Warning**

Pay attention to the following points regarding installation and handling of the projector. Failure to do so may cause a fire, electric shock or personal injury.



Prohibition

- Do not remove the cabinet from the projector or disassemble it. The interior of the projector contains high-voltage components as well as parts that are hot. If inspection, maintenance or repair is required, contact the Canon Customer Support Center.
- Do not disassemble or modify the projector (including consumable parts) or the remote control.
- Do not look directly into the exhaust vents during use.



Prohibition

- Do not insert any object into vents in the projector, such as the air intake vent or exhaust vents.
- Do not place a pressurized can in front of the exhaust vents. The pressure of the contents of the can may increase due to heat from the exhaust vents and this could result in an explosion.
- When cleaning off dust or dirt from the projector lens etc., do not use any kind of spray that is flammable. As the temperature of the lamp inside the projector is high, it could ignite, causing a fire.
- As strong light beams are emitted while the projector is in use, do not look directly into the projector lens. Doing so could cause an eye injury. Pay particular attention to prevent small children from doing so.
- When setting the projector on a high surface for projection, be sure the surface is flat and stable.
- For ceiling mounting precautions, refer to the installation manual included with the ceiling mount (sold separately).

## Precautions on the Lamp

This projector uses a high-pressure mercury lamp, which must be handled carefully and correctly as described below.

The mercury lamp has the following characteristics.

- The lamp will gradually become darker over time.
- Impact, abrasion, or use of worn-out lamps may cause lamps to rupture (accompanied by a loud noise) or burn out.
- Lamps are more likely to rupture after the lamp replacement message is displayed (see “Replacing the Lamp” (P163)). Replace the lamp with a new one as soon as possible.
- Useful life of lamps varies widely from lamp to lamp and depending on the environment of use. Some lamps may fail or rupture soon after they are first used.
- Be prepared by keeping a spare lamp.

## Warning

Note the following precautions during lamp replacement or when a lamp has ruptured. Failure to do so could result in an electric shock or personal injury.

- Before replacing the lamp, always unplug the projector and wait at least an hour.
- Ruptured lamps may scatter shards of glass inside the projector. Contact the Canon Customer Support Center for cleaning and inspection of the projector interior and lamp replacement.

Precautions when replacing lamps that stop working



Caution

- If illumination suddenly stops, either when you turn the projector on or after it has been on for a while, the lamp may have ruptured. In this case, never attempt to replace the lamp by yourself. Always request service from the Canon Customer Support Center.
- With ceiling-mounted projectors, the lamp may fall out when you open the lamp cover, or during replacement. During replacement, stand to the side of the lamp cover, not directly under it.
- If the lamp ruptures, dust and gas (containing mercury vapor) may come out of the exhaust vents. If this happens, immediately open the windows and doors to provide ventilation to the room.
- If you accidentally inhale gas from the lamp or get any pieces in your eyes or mouth, consult a doctor immediately.

## Precautions for the Batteries of the Remote Control

Pay attention to the following points regarding handling of batteries. Failing to do so could result in a fire or personal injury.



Prohibition

- Do not heat, short circuit or disassemble the batteries, or place them in a fire.
- Do not attempt to recharge the batteries that are included with the remote control.



Caution

- Remove the batteries when they are flat or when the remote control will not be used for a long period of time.
- When replacing the batteries, replace both at the same time. Also, do not use two batteries of a different type at the same time.
- Insert the batteries with the + and - terminals in the correct directions.
- If any liquid from inside the batteries leaks out and contacts your skin, be sure to wash the liquid off thoroughly.

### **Caution**

Pay attention to the following points regarding installation and handling of the projector.

- If the projector will not be used for a long period of time, be sure to remove the power plug from the power outlet to ensure safety. Failure to do so presents a risk of fire if dust accumulates on the plug or outlet.
- Parts of the cabinet around and above the exhaust vents may become hot during projection. Touching these areas during operation could cause burns to the hands. Pay particular attention in preventing young children from touching these parts. Additionally, do not place any metal objects around or above the exhaust vents. Due to the heat from the projector, doing so could cause an accident or personal injury.
- Do not place the projector where it may be exposed to oily smoke or steam, such as near kitchen counters or humidifiers. Doing so may cause fire or electric shock.
- Do not place any heavy objects on top of the projector or sit / stand on it. Pay particular attention to prevent small children from doing so. The projector may be knocked over and this could result in damage or a personal injury.
- Do not place the projector on an unstable or slanted surface. Doing so may cause the projector to fall or be knocked over and could result in a personal injury.
- Do not place any objects in front of the lens during projection. Doing so could cause a fire.
- Presenters in front of the projector should stand where the light does not seem too bright, and where their shadow does not fall on the screen.



Prohibition

When handling the lamp, pay attention to the following points.

- Be sure not to handle the lamp immediately after it has been used. Be sure to switch off the power and wait for approximately 1 hour for the lamp and the projector to cool down sufficiently. Failure to do so could result in a burn or personal injury due to heat from the lamp or projector.



Prohibition



## Caution

Pay attention to the following points when carrying or transporting the projector.



Caution

- This projector is a precision instrument. Do not knock it over or subject it to impacts. Doing so may cause a malfunction.
- Do not reuse any packaging or shock-absorbent materials that were supplied with the projector at the time of purchase for transporting or shipping the projector. Protection of the projector cannot be guaranteed if used packaging or shock-absorbent materials are reused. Fragments from shock-absorbent material may also enter the interior of the projector which could cause a malfunction.
- Disconnect the cables connected to the projector. Carrying the projector while the cables are attached may cause an accident.
- Retract the adjustable feet before moving the projector. Leaving the feet extended may cause damage.

Pay attention to the following points when installing or using the projector.



Caution

- Do not touch the lens with bare hands. Doing so may result in deterioration of image quality.
- If the projector is abruptly taken from a cool to a warm location, condensation may form on the lens or mirrors, which may cause a blurred image. Wait until the condensation has evaporated for the image projected to return to normal.
- Do not install the projector in a location where the temperature is high or low. Doing so may cause a malfunction. For guidelines on operating temperatures, see "Product Specifications".
- Do not place any objects on top of the projector that may change shape or color due to heat.
- Projector settings must be adjusted when using the projector at high altitudes or in upward or downward projection. Failure to adjust the settings may shorten the lamp life or damage the lamp. For details, contact the Canon Customer Support Center.
- Do not install the projector near high-voltage electrical power lines or an electrical power source.
- Do not use the projector on a soft surface such as carpet or sponge mat, etc. Doing so could cause heat to build up inside the projector and this could result in a malfunction.
- Do not block the air intake or exhaust vents of the cooling fan. If the air intake or exhaust vent is blocked, heat cannot be released from inside the projector, which may shorten the useful life of the lamp or cause malfunction.
- Installing the projector in the wrong direction may cause a malfunction or accident. Do not install the projector with one side raised, or with the projector tilted toward the left or right.
- Install the projector with sufficient space between air intakes and exhaust vents and walls. Failure to do so could cause a malfunction.
- Do not install the projector in a location that is damp, or where there is a lot of dust, oily smoke or tobacco smoke. Doing so could cause contamination of optical components such as the lens and the mirror and may result in deterioration of image quality.

# Before Installation

## Precautions When Carrying/Shipping the Projector

Prepare the projector as described below before carrying it.



- Disconnect the cables connected to the projector. Carrying the projector with the cables attached may cause an accident.
- Retract the adjustable feet before moving the projector. Leaving the feet extended may cause damage.
- Do not carry or move the projector alone. Have at least one assistant.

## Precautions for Installation

Be sure to read “Safety Instructions” and “For Safe Use” (P5 – P17). Also take the following precautions during installation.



- Do not strike the projector or subject it to impact. Doing so may cause a malfunction.
- Do not install the projector so that it is inclined or standing vertically. The projector may be damaged if it tips over.
- Do not block the air intake or exhaust vents of the cooling fan. Blocking the vents may trap heat inside the projector, which may shorten the useful life of the lamp or damage the projector.

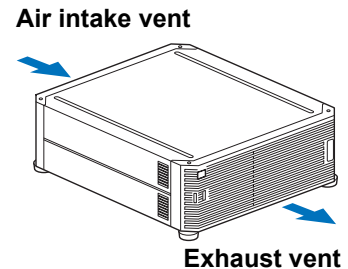

### ■ Do Not Use in the Following Environments

- **Locations with excessive humidity, dust, oily smoke or tobacco smoke**  
Adhesion to the lens, mirrors or other optical parts may reduce image quality.
- **Near high-voltage power lines or sources of electrical power**  
This may cause malfunction.
- **On soft surfaces such as carpets or cushioned mats**  
Heat may build up inside the projector and damage it.
- **Locations with excessive temperature or humidity**  
This may damage the projector. Acceptable ranges for operating and storage temperature and humidity are as follows.

Operating temperature	Operating humidity	Storage temperature
0°C (32°F) – 40°C (104°F)	Up to 85%	-20°C (-4°F) – 60°C (140°F)

## ■ Do Not Touch the Lens with Bare Hands

Do not touch the lens with bare hands. Doing so may adversely affect picture quality.

## ■ Allow a 30 Min. Warm Up before Focus Adjustment (P67), if Possible

The focus position may not stabilize immediately after startup, due to lamp heat. When adjusting focus, it is also helpful to use the test pattern (10) (P107, P168).

## ■ Install at a Sufficient Distance from Walls and Other Obstructions



Caution

If the air intake or exhaust vent is blocked, heat will accumulate inside the projector, possibly resulting in a shortened projector lifetime or a malfunction. Do not install in a closet, on a bookshelf, or in other narrow spaces with poor ventilation. Install in a well-ventilated location. (Ensure a minimum clearance of 50 cm (1.6 ft.) above, on both sides, and behind the projector, as shown below.)

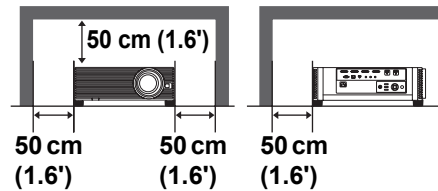
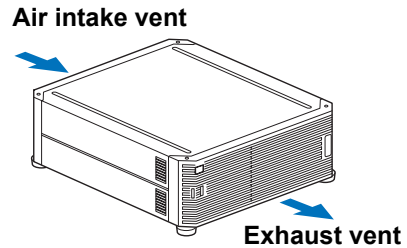

## ■ Be Careful of Condensation

If the temperature of the room rises suddenly, moisture in the air may condense on the projector lens and mirror, causing the image to become blurred. Wait until the condensation has evaporated for the image projected to return to normal.

## ■ At Altitudes above 2,300 m (7,545.8'), Adjust the Settings

Projector settings must be adjusted when using the projector at altitudes of 2,300 m (7,545.8') or higher. Specifically, refer to instructions for [High altitude] (P102) in the [Install settings] menu.

### ■ When Using Mounted on the Ceiling



When the projector is used mounted on the ceiling or installed in a high location, it is necessary to periodically clean the air intake and exhaust vents, and the area around the air filter. Dust that accumulates in intake or exhaust vents may impair ventilation, raising the temperature inside and posing a risk of damage or fire. Use a vacuum cleaner or similar means to remove dust from the intake vent and exhaust vent.

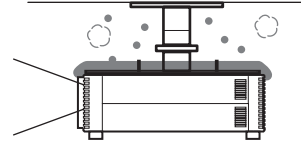

## ■ Install Facing in the Correct Direction



Caution

- The projector can be installed facing any direction\*<sup>1</sup>, as shown below. However, projection upward or downward may shorten the useful life of the lamp. [Install settings] of the projector must also be adjusted. Specifically, for upward or downward projection, refer to instructions for [Vertical projection] (P102) in the [Install settings] menu.
- Do not attempt to install the projector for upward or downward projection by yourself. Always request installation by a qualified technician or the Canon Customer Support Center.

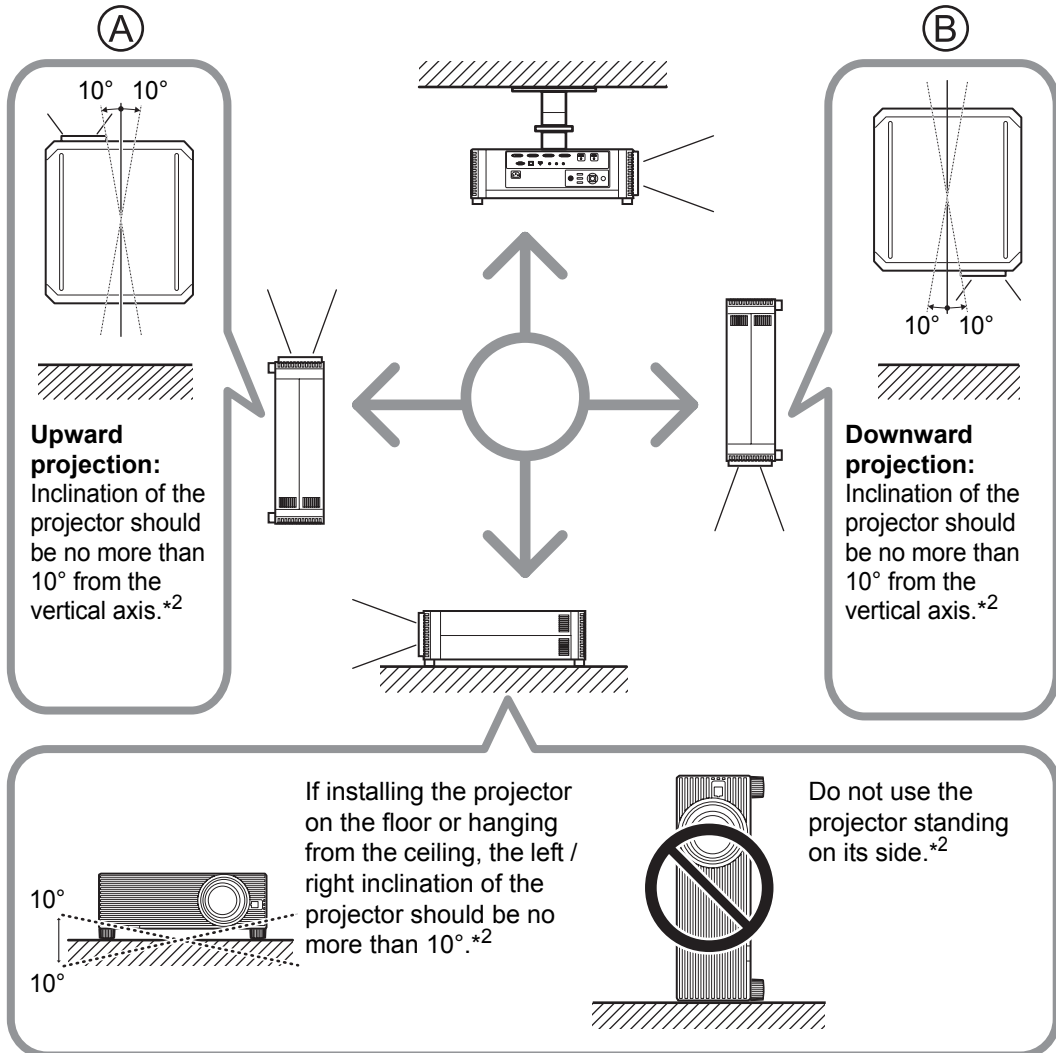

\*1 No optional accessories are available for installing the projector in ways other than ceiling installation (P37, P188).

\*2 Failure to do so may damage the lamp.



- When installing the projector facing upward or downward, specify which way the projector is facing in [Install settings] > [Professional settings] > [Vertical projection]. (P102)
- When mounting the projector on the ceiling, it is more convenient to install the projector right-side up, with the adjustable feet facing down.

### Copyright Notice

Please note that enlarging or reducing the size of an image for commercial purposes or public presentation may infringe on the legally protected copyright or the copyright holder of the original material.

### Ensure Network Security

Take measures to ensure network security. Note that Canon is not liable in any way for direct or indirect loss from network security incidents, such as unauthorized access.

### Examples of Security Measures

- Use in an intranet environment.
- Assign a private IP address.
- Use behind a firewall.
- Change passwords regularly.

### About Trademarks

- Ethernet is a registered trademark of Xerox Corporation.
- Microsoft, Windows, Windows Vista, Windows 7, Windows 8 and Windows 8.1 are registered trademarks or trademarks of Microsoft Corporation in the United States and / or other countries.
- Mac, Mac OS and Macintosh are trademarks of Apple Inc., registered in the United States and / or other countries.
- HDMI, the HDMI logo and High-Definition Multimedia Interface are trademarks or registered trademarks of HDMI Licensing, LLC.
- PJLink is a registered trademark of JBMIA and pending trademark in some countries.
- PJLink is a registered trademark, or an application has been submitted for trademark, in Japan, the United States and / or other countries or regions.
- AMX is a trademark of AMX Corporation.
- Crestron®, Crestron RoomView®, and Crestron Connected™ are registered trademarks of Crestron Electronics, Inc.
- All other trademarks are the property of their respective owners.

The product contains Open Source Software modules. For details, see “ThirdPartySoftware.pdf” (Third-Party Software License) in the OpenSourceSoftware folder in the LICENSE folder on the Setup CD-ROM. Each module’s license conditions are also available in the same folder.

## ■ Software under the GNU General Public License Version 2

Contained programs are free software; you can redistribute them and/or modify them under the terms of the GNU General Public License attached to each copy of the program.

Each program is distributed in the hope that it will be useful, but WITHOUT ANY WARRANTY; without even the implied warranty of MERCHANTABILITY or FITNESS FOR A PARTICULAR PURPOSE. Please see “NO WARRANTY” and “NO SUPPORT” stated below. For more detail, please see full text of the GNU General Public License.

### **NO WARRANTY**

BECAUSE THE PROGRAM IS LICENSED FREE OF CHARGE, THERE IS NO WARRANTY FOR THE PROGRAM, TO THE EXTENT PERMITTED BY APPLICABLE LAW. EXCEPT WHEN OTHERWISE STATED IN WRITING THE COPYRIGHT HOLDERS AND/OR OTHER PARTIES PROVIDE THE PROGRAM “AS IS” WITHOUT WARRANTY OF ANY KIND, EITHER EXPRESSED OR IMPLIED, INCLUDING, BUT NOT LIMITED TO, THE IMPLIED WARRANTIES OF MERCHANTABILITY AND FITNESS FOR A PARTICULAR PURPOSE. THE ENTIRE RISK AS TO THE QUALITY AND PERFORMANCE OF THE PROGRAM IS WITH YOU. SHOULD THE PROGRAM PROVE DEFECTIVE, YOU ASSUME THE COST OF ALL NECESSARY SERVICING, REPAIR OR CORRECTION.

IN NO EVENT UNLESS REQUIRED BY APPLICABLE LAW OR AGREED TO IN WRITING WILL ANY COPYRIGHT HOLDER, OR ANY OTHER PARTY WHO MAY MODIFY AND/OR REDISTRIBUTE THE PROGRAM AS PERMITTED ABOVE, BE LIABLE TO YOU FOR DAMAGES, INCLUDING ANY GENERAL, SPECIAL, INCIDENTAL OR CONSEQUENTIAL DAMAGES ARISING OUT OF THE USE OR INABILITY TO USE THE PROGRAM (INCLUDING BUT NOT LIMITED TO LOSS OF DATA OR DATA BEING RENDERED INACCURATE OR LOSSES SUSTAINED BY YOU OR THIRD PARTIES OR A FAILURE OF THE PROGRAM TO OPERATE WITH ANY OTHER PROGRAMS), EVEN IF SUCH HOLDER OR OTHER PARTY HAS BEEN ADVISED OF THE POSSIBILITY OF SUCH DAMAGES.

### **NO SUPPORT**

Canon Inc., and all its subsidiaries or its dealers do not make any support service regarding the source code. Canon Inc., and all its subsidiaries or its dealers shall not respond to any questions or enquiries, from you or any other customers, regarding the source code.

# Before Use

## Included Accessories

Before use, make sure the following items are included in the package.

- Remote control

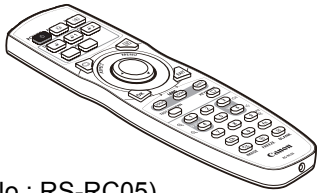

(part No.: RS-RC05)

- Batteries for the remote control

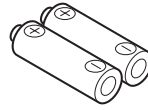

(AA size x2)



Optional remote controls are also available (RS-RC04). However, some buttons are not supported with this projector. The RS-RC05 can also be used as a wired remote. (P33)

- Power cord  
(1.8 m / 5.9')

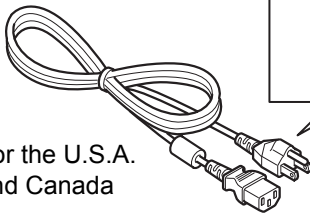

For the U.S.A.  
and Canada

For Continental  
Europe

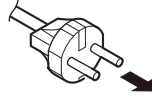

- Lens cap

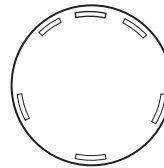

- Important Information

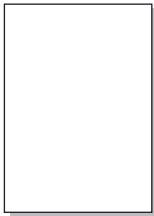

- Warranty Card

- User's Manual (CD-ROM)

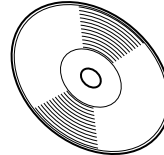

■ **Always remove the lens cap before projection.**

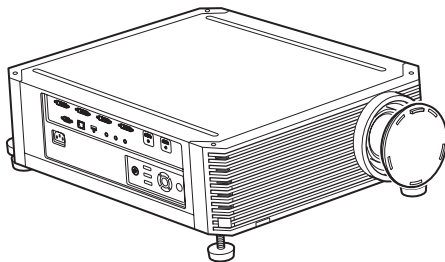



# Part Names

## Projector

### ■ Front Side

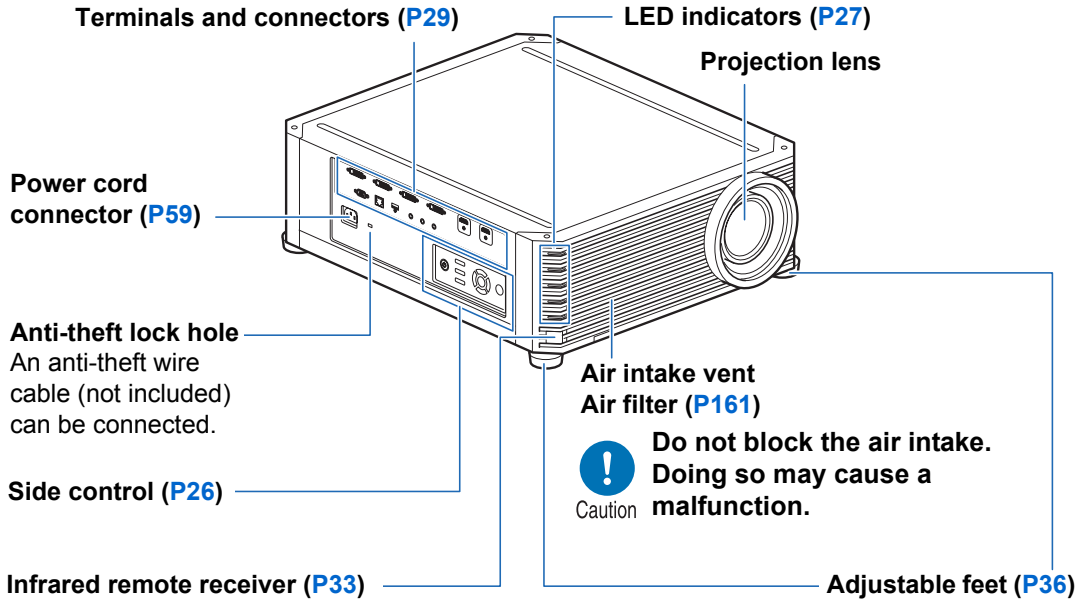

### ■ Rear Side

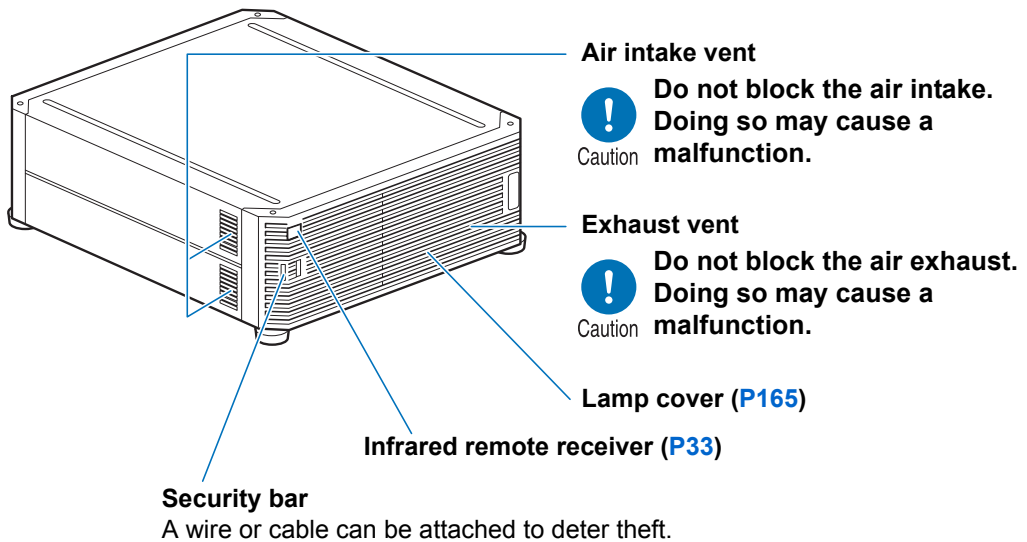

## Side Control

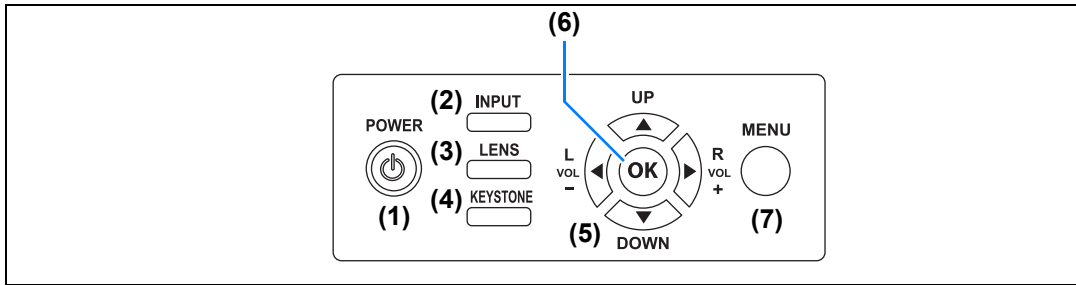

- (1) **POWER button (P60, P79)**  
Turns the projector on or off.
- (2) **INPUT button (P63)**  
Switches the input signal.
- (3) **LENS button (P67)**  
Each time the button is pressed, the adjustment window changes, from focus (P67) to zoom (image size) (P68) to lens shift (image position) (P70).  
To adjust the image, use the [▲] / [▼] or [◀] / [▶] buttons.  
After the focus adjustment window, the marginal focus adjustment window is also displayed for adjusting focus of image edges (P157), depending on the [Marginal focus] setting (P102).
- (4) **KEYSTONE button (P73)**  
Corrects keystone distortion.
- (5) **Pointer / VOL buttons (P85)**  
Up, down, left, or right in menu navigation or other operations.  
Adjust the sound volume.  
[◀] VOL- button: Decreases the volume.  
[▶] VOL+ button: Increases the volume.
- (6) **OK button (P86)**  
Determines the item selected from the menu.
- (7) **MENU button (P84)**  
Displays a menu on the screen.

## LED Indicators

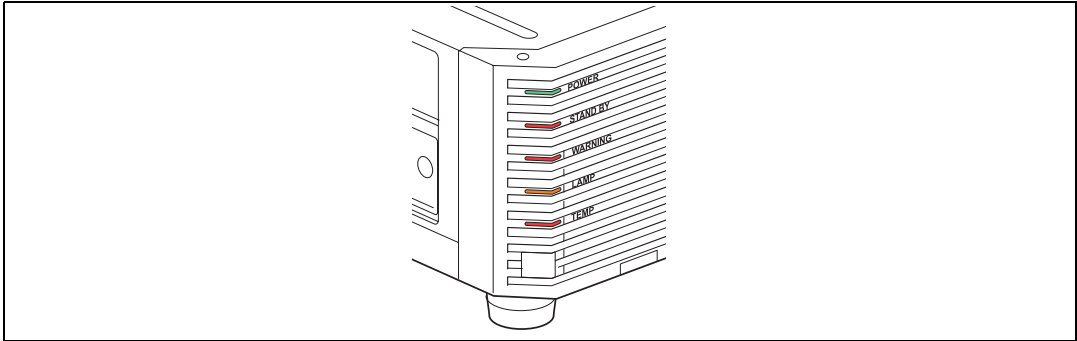



The projector status is shown by the LED indicators (off / lit / flashing).







































































- POWER (green) : Lights up or flashes under normal conditions when the power is on.
- STAND BY (red) : Lights up or flashes during standby or when the projector is shutting down.
- WARNING (red) : Lights up or flashes when an error occurs.
- LAMP (orange) : Lights up or flashes when a problem occurs with the lamp or lamp cover.
- TEMP (red) : Lights up or flashes when the internal temperature is high.

## ■ LED Indicator Displays

The LED indicators flash or illuminate to indicate the operating status of the projector.

For details on warnings, see “LED Indicator Details” (P180).

Legend: Example of when the POWER indicator is on; : Off : Lit : Flashing

LED indicator					Operating status
POWER (green)	STANDBY (red)	WARNING (red)	LAMP (orange)	TEMP (red)	
					A projector is not plugged in.
					In standby mode.
					Resuming operation (projection) after standby (flashes once).
					Cooling down while entering standby or power management mode from power on.
					Power is on. (Projecting.)
					In power management mode, with the lamp off.
					The time for replacing the lamp is near. (In standby mode.)
					The time for replacing the lamp is near. (During projection)
					Internal temperature is high. (In standby mode.)
					Internal temperature is high. (During projection)
					A lamp error has occurred.
					A temperature error has occurred.
					The lamp cover is open.
					<ul style="list-style-type: none"> <li>• An air filter error has occurred (flashes 3 times).</li> <li>• A fan error has occurred (flashes 4 times).</li> <li>• A power error has occurred (flashes 5 times).</li> </ul>



Caution

- A flashing LAMP indicator means that it is almost time to replace the lamp. Prepare a replacement lamp.
- Lamps that are still used after the timing for lamp replacement are more likely to rupture. Replace the lamp with a new one as soon as possible.

# Input Terminal

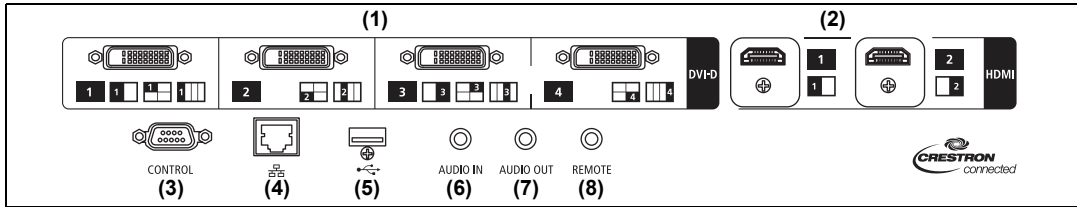

- (1) **Digital PC / DVI-D terminal (DVI-D) (P53)**  
Connects the external monitor output from a computer.  
Receives digital PC signal (Digital PC).
- (2) **HDMI terminal (HDMI) (P53, P54)**  
Receives digital video signals (HDMI).  
Carries both video and audio signals across a single cable.
- (3) **Service port (CONTROL) (P177)**  
Used for executing user commands (P178 – P179).
- (4) **LAN port (P122)**  
Connects the LAN cable (shielded twisted pair).  
Used to connect the projector to a network.
- (5) **USB port (P119)**  
Connects a USB flash drive. Used for firmware updates.
- (6) **AUDIO IN terminal (AUDIO IN) (P53, P54)**  
Receives audio input. Audio supplied to this terminal is played through the internal speaker when you select [Audio in] as the source audio terminal for the selected source video.
- (7) **AUDIO OUT terminal (AUDIO OUT) (P53, P54)**  
Outputs the audio to external AV equipment. This outputs the audio signal that corresponds to the projected image signal.
- (8) **Terminal for wired remote control (REMOTE) (P33)**  
This terminal is used to connect the remote control using a cable.

# Remote Control

The remote control allows you to operate all functions of the projector.

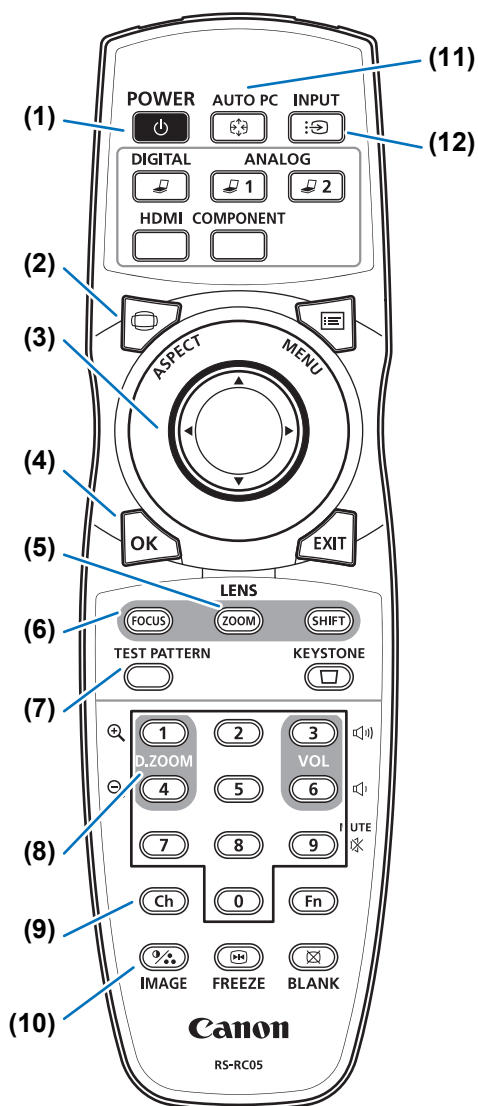

**(1) POWER button (P60, P79)**

Turns the projector on or off.

**(2) ASPECT button (P72, P88)**

Changes the aspect ratio mode.

**(3) Pointer buttons (P85)**

Selects the upper, lower, left or right item in the menu. Also used to assign a channel to the remote control.

**(4) OK button (P86)**

Determines the item selected from the menu.

**(5) ZOOM button (P68)**

Adjusts the image size.

[▲] / [▶] buttons:

Increase the image size.

[▼] / [◀] buttons:

Decrease the image size.

**(6) FOCUS button (P67)**

Adjusts focusing.

[▲] / [▶] buttons:

Moves the focus position further away.

[▼] / [◀] buttons:

Moves the focus position nearer.

By pressing the **FOCUS** button twice, you can also adjust the focus at image edges (P157), depending on the [Marginal focus] setting (P102).

**(7) TEST PATTERN button (P107)**

Displays the test pattern.

**(8) D.ZOOM button**

Not used with this product.

**(9) Ch button (P113)**

Changes the remote control channel when the remote control is used via the infrared transmitter.

**(10) IMAGE button (P76)**

Switches the image mode (image quality).

**(11) AUTO PC button**

Not used with this product.

**(12) INPUT button (P63)**

Switches the input signal.

**(13) Change input buttons**

Change the input signal between Digital PC and HDMI.

**ANALOG 1, ANALOG 2** and **COMPONENT** are not used with this product.

**(14) MENU button (P84)**

Displays a menu on the screen.

**(15) EXIT button (P86)**

Cancels functions such as menu display or test pattern during operation and returns to the image display.

**(16) SHIFT button (P70)**

Moves the lens up, down, left or right.  
[▲] / [▼] / [◀] / [▶] buttons:  
Move the lens.

**(17) KEYSTONE button (P73)**

Corrects keystone distortion.  
The [Keystone] setting enables both horizontal/vertical keystone correction (by adjusting top/bottom/left/right length) and corner correction.

**(18) VOL button**

Adjusts the sound volume.

[▶] button, [3] button:  
Increases the volume.

[◀] button, [6] button:  
Decreases the volume.

**(19) MUTE button**

Mutes the sound.

**(20) Numerical buttons (P118, P124, P126)**

Enter password and TCP/IP setting values.

**(21) Fn button**

Not used with this product.

**(22) BLANK button (P80)**

Temporarily blacks out the image.

**(23) FREEZE button (P80)**

Freezes the projected image.

**(24) Terminal for wired remote control (P33)**

Connects a cable to the projector for remote control operation.

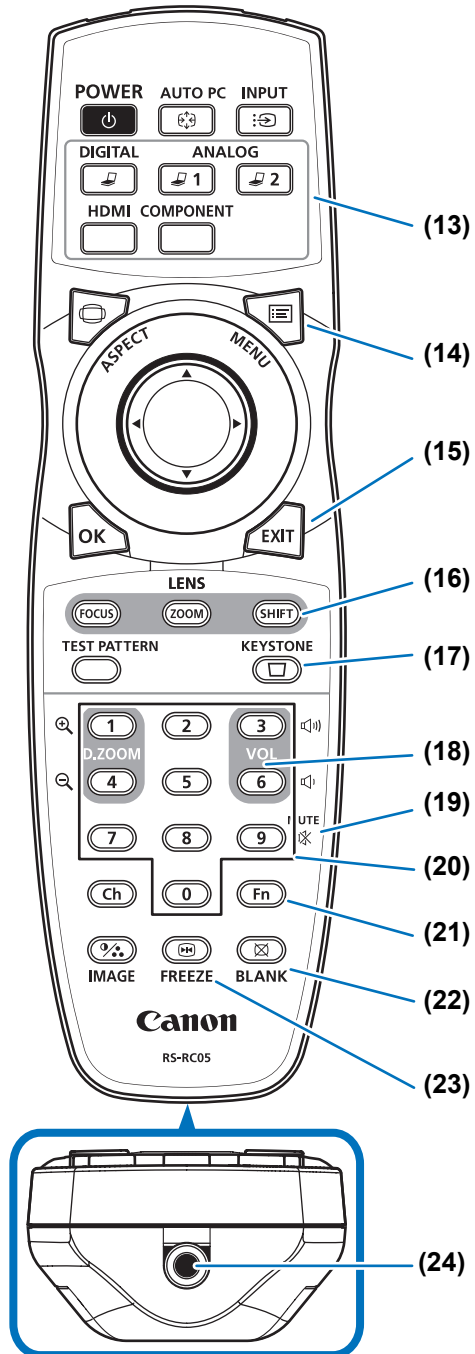

## Preparing the Remote Control

### ■ Installing Remote Control Batteries

- 1 Open the battery compartment lid.**  
Raise the battery cover tab while pushing it.

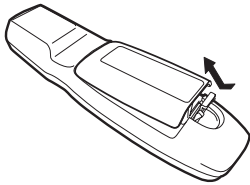

- 2 Insert batteries.**  
Insert 2 new AA batteries in the compartment with the + and – terminals positioned correctly.

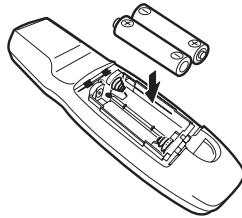

- 3 Close the compartment lid.**  
Insert the tab into the remote control notch (1) and push the battery cover down (2).

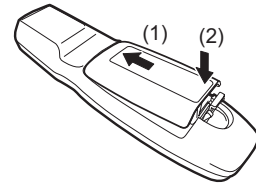

- If buttons on the remote control are inoperative when you attempt to operate the projector, replace the batteries with new ones.
- Do not drop the remote control or subject it to impact.
- Do not spill any liquids on the remote control. Doing so may cause a malfunction.



Warning



Prohibition



Caution

**Pay attention to the following points when handling the batteries. Failing to do so could result in a fire or personal injury.**

- Do not heat, short circuit or disassemble the batteries, or place them in a fire.
- Do not attempt to recharge the batteries that are included with the remote control.
- Remove the batteries when they are flat or when the remote control will not be used for a long period of time.
- When replacing the batteries, replace both at the same time. Also, do not use two batteries of a different type at the same time.
- Insert the batteries with the + and - terminals in the correct directions.
- If any liquid from inside the batteries leaks out and contacts your skin, be sure to wash the liquid off thoroughly.



## ■ Remote Control Operating Range

The remote control is an infrared type. Point it at the infrared remote receiver on the front or rear of the projector to operate it.

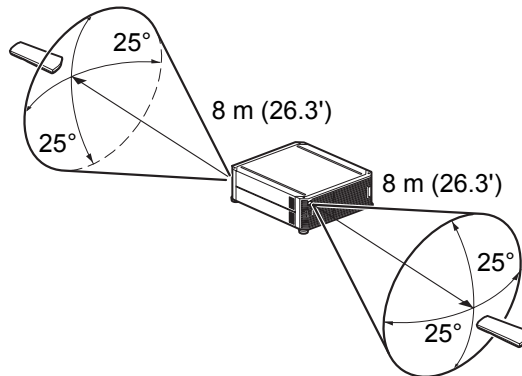

- Use the remote control within an angle of 25° in any direction from directly in front of the infrared remote receiver.
- The remote control may be inoperative if there is an obstacle between the remote control and the projector or the infrared remote receiver on the projector is exposed to direct sunlight or strong light of lighting equipment.
- When you use 2 or more projectors at the same time, you can change the channel settings to prevent the 2 remote controls from interfering with each other. (P113)

## ■ Using the Remote (RS-RC05) in a Wired Connection

The remote control can also be used in a wired connection with the projector. Use a cable with a  $\varnothing 3.5$  mm stereo mini jack (not included).

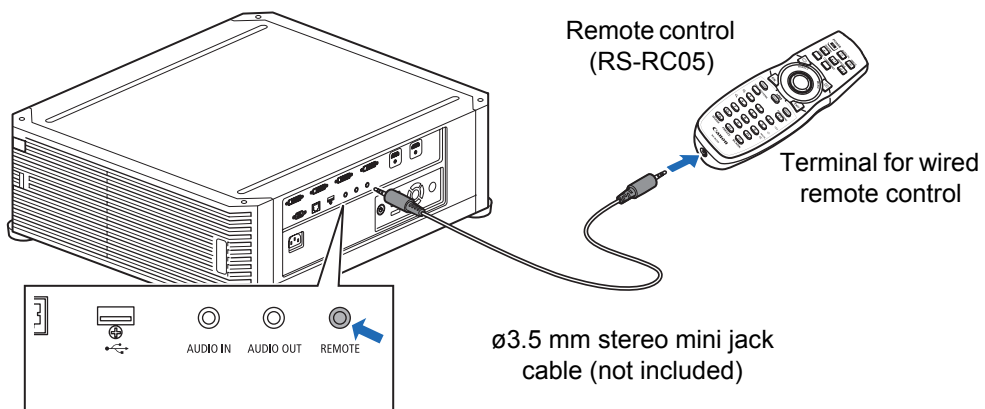

- Infrared operations cannot be performed if a cable is connected to the projector or the remote control.
- Use a cable with a  $\varnothing 3.5$  mm stereo mini jack (not included) with a length of 30 m (98.4') or less.



# Basic Guide

Safety Instructions

Before Use

Installation Procedure

Connection Procedure

Projection Procedure

Convenient Features

Using Menu

Menu Settings

Advanced Projection

Maintenance

Product Specifications

Troubleshooting

Basic Guide

Advanced Guide

Other Information

# Installation Procedure

Before setting up the projector, be sure to read “Before Installation” (P18).

## Setting Up the Projector

### ■ Positioning the Projector in Front of the Screen

Place the projector in front of the screen.



- To avoid keystone distortion, install the projector so that it is at right angles to the screen.
- The screen must not be exposed to direct sunlight or light from lighting equipment. In a bright room, it is recommended that lights be turned off, curtains be drawn, and other steps taken to make the screen easier to see.

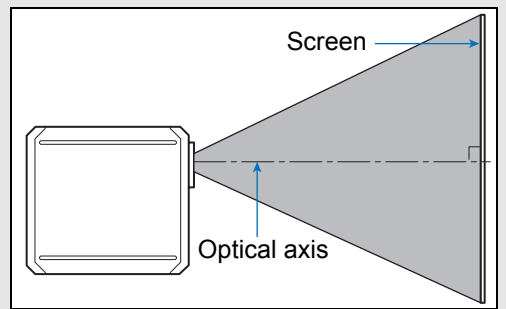

### ■ Floor Installation

To adjust the projection position when the projector is installed on the floor, use the lens shift function (P51, P70) to adjust up / down / left / right.

For information about the relationship between screen size and projection distance, refer to [page 50](#).

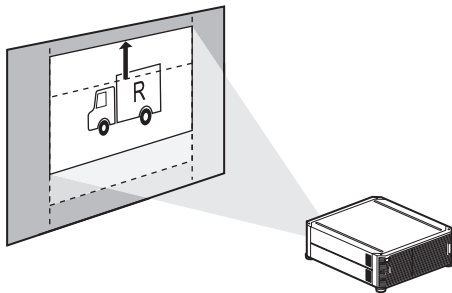

Lens shift

## ■ Installation on High Surfaces

Using the lens shift function (P51), you can project images toward a lower level. When setting the projector on a high surface for projection, make sure the surface is flat and stable, and install the projector right-side up with the adjustable feet facing down.

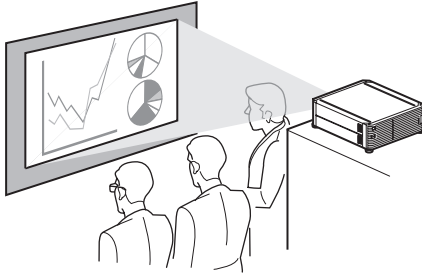

Caution

Failure to do so poses a risk of the projector falling and causing accidents or injury.

## ■ Ceiling Mounting or Rear Projection

You can mount the projector on the ceiling (ceiling mounting) or place it behind the screen (rear projection) if you use a translucent screen.

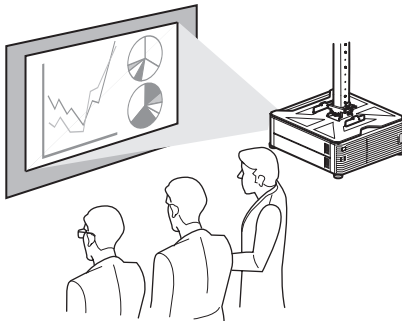

Ceiling mounting

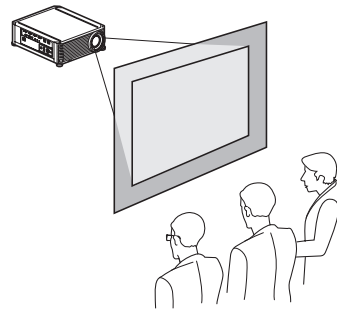

Rear projection



Remove the caps on top of the projector before installing a ceiling attachment.



When mounting the projector on the ceiling, it is more convenient to install the projector right-side up, with the adjustable feet facing down.

## Ceiling Mounting

### Ceiling Attachment Part No.: RS-CL15 (Option)

#### Warning

Make sure the followings when you install and handle the ceiling attachment. Otherwise, it may result in fire, electric shock or injury.



Caution

- Make sure to prepare stable scaffolding when installing the ceiling attachment.
- Make sure to fully insert the power plug and connectors when connecting the projector. Never use a damaged plug or loosen outlet.



Prohibition

- Make sure to tighten screws for the ceiling attachment securely and never loosen or remove them.
- Never look into a lens when adjusting the projection because a high-intensity light is projected from the projector. It may result in eye damage.
- During projection, never put an object in front of the projector's lens.

#### Caution

Make sure the followings when you install and handle the ceiling attachment.



Caution

- Make sure to ask the Canon Customer Support Center if you want to install the ceiling attachment. An inappropriate installation may cause an accident.

# Parts Lineup

## ■ Parts Included with RS-CL15

**Weight: RS-CL15 (6.9 kg/15.2 lbs)**

- Ceiling-mount bracket and Joint fitting

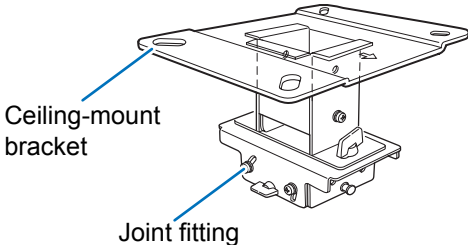

- Base bracket

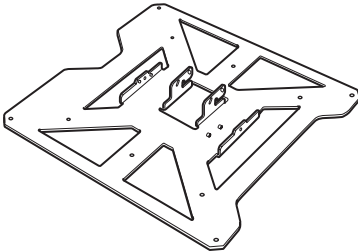

The Ceiling-mount bracket must be separated from the Joint fitting, before installation.

- Template sheet for a ceiling-mount hole: 2 shts.

A

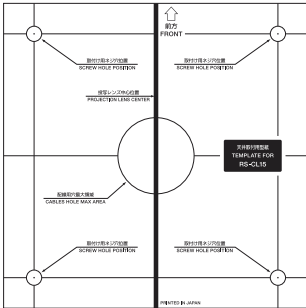

B 4K500ST

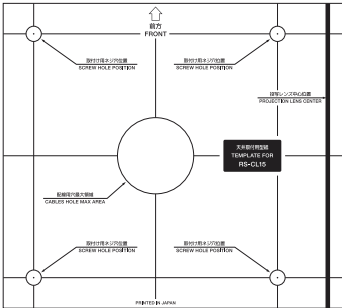

Use the template sheet (B) for the projector.

- M6 screw (25 mm/1.0") : 4 pcs.



- Anti-fall wires: 2 pcs.



- M4 screw (15 mm/0.6") : 10 pcs.



- Washer (Toothed Lock Washer): 1 pc.



- M5 screw (12 mm/0.5") with washer: 4 pcs.



- Assembly/Installation Manual (this manual): 1

### ■ Extension pipe RS-CL08 / RS-CL09 (option)

**Weight: RS-CL08 (2.2 kg/4.9 lbs)/RS-CL09 (3.4 kg/7.5 lbs)**

Use an optional extension pipe (RS-CL08 / RS-CL09) according to the ceiling height. For details, contact our local agent.

RS-CL08

Outer/inner pipes and outer/inner covers

M5 screw (12 mm/0.5") : 4 pcs.

M3 screw (10 mm/0.4") : 1 pc.

\* The length is adjustable between 35 cm/1.1' and 55 cm/1.9' in steps of 5 cm/0.2'.

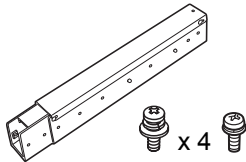

RS-CL09

Outer/inner pipes and outer/inner covers

M5 screw (12 mm/0.5") : 4 pcs.

M3 screw (10 mm/0.4") : 1 pc.

\* The length is adjustable between 55 cm/1.9' and 95 cm/3.1' in steps of 5 cm/0.2'.

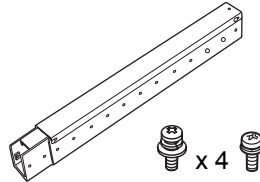

## Mounting Position

Install the projector straight in front of the screen. You can adjust the screen position using the lens shift feature.



- Before mounting the Ceiling Attachment, be sure to check the strength of the ceiling. The ceiling should be strong enough to support the projector and Ceiling Attachment (and optional extension pipe). If the ceiling is not strong enough, be sure to reinforce it. The projector may fall and you may get injured.
- Make sure to perform the installation operation by at least two persons. Please be careful not to drop any object and pinch a finger during the installation operation.
- To prevent falling caused by earthquake or vibration, take anti-fall measures using tension wires or the like for installation. The projector may fall and you may get injured.
- At least 50 cm (1.6') around the intake and 50 cm (1.6') around the vent should be clear. Otherwise, it may damage the projector due to bad exhaust ventilation.



Caution



Installation Dimensions

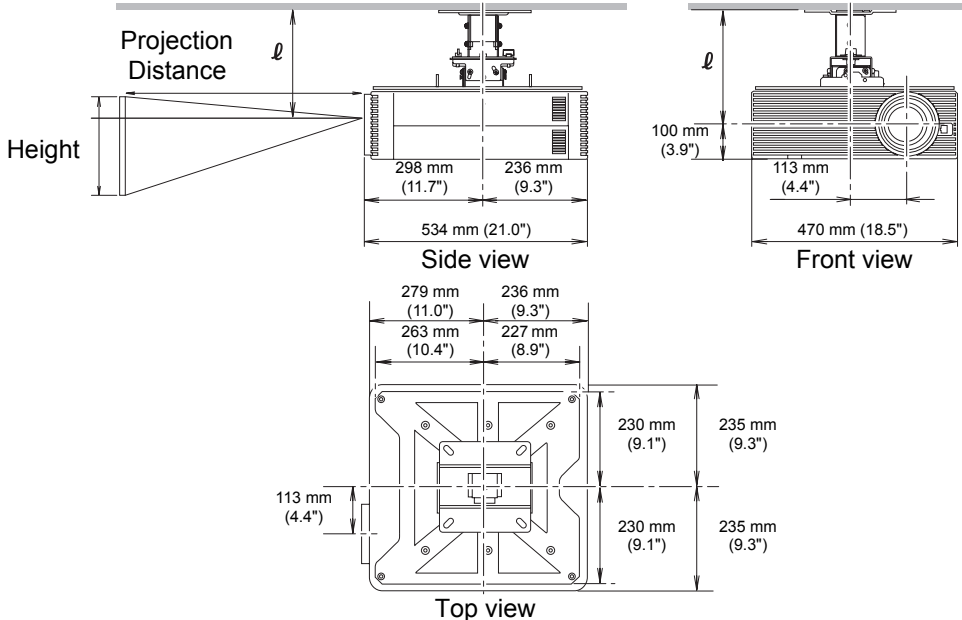

Distance from ceiling to lens center ( $\ell$ )

RS-CL15	When RS-CL08 is used	When RS-CL09 is used
22.9 cm (9.0")	57.9 cm (22.8") to 77.9 cm (30.7")	77.9 cm (30.7") to 117.9 cm (46.4")

Ceiling-mount bracket

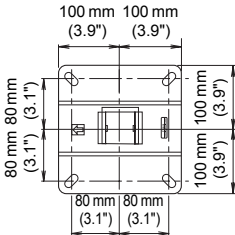

# Assembly and Installation

## ■ Installation to flat and level Ceiling

### Preparation: Separate the Joint fitting from the Ceiling-mount bracket temporarily

Remove four M5 screws to separate Joint fitting from the Ceiling-mount bracket.

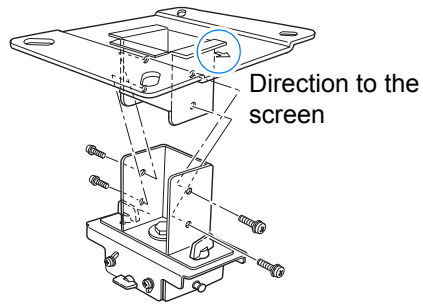

### 1 Make a hole in the ceiling

- Use the template sheet (B) to make holes in the ceiling for securing the Ceiling-mount bracket.
- Make holes to thread cables through.



Caution

- Always use the included template sheet (B) to determine where to make holes.
- The template sheet (B) is labeled with the direction to the screen, as well as the optical axis (center of the lens).

### 2 Secure the Ceiling-mount bracket to the ceiling

Use four M13 screws, to secure the Ceiling-mount bracket to the ceiling with the arrow facing toward the screen.

- Before securing the Ceiling-mount bracket, be sure to remove the template sheet (B).
- The M13 screws are not included in the supplied parts. Prepare the M13 screws suitable for the ceiling structure.

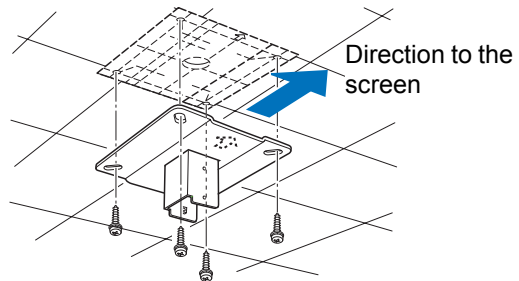

### 3 Attach the Base bracket to the projector

- 1 Remove the four screws at each corner on top of the projector.
- 2 Install the attached M6 screws at the four screw fastening positions on the Base bracket. Attach the included toothed lock washer in the back-left position, as shown at right.

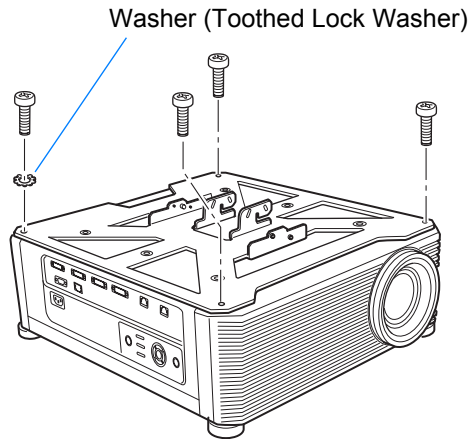

### 4 Attach the anti-fall wire

Secure the terminal clamp with the attached M4 screw at (A) on the Base bracket.

- Make sure to fasten and tighten the screw securely.

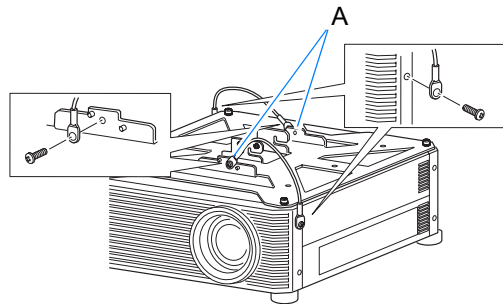

### 5 Pull cables out of the cable hole in the ceiling

- As depicted in the diagram, let cables pass through the hole on ceiling-mount clamp.
- If cables are too thick, make a hole at a different position than the hole on the ceiling-mount clamp, and let them pass through the new hole.

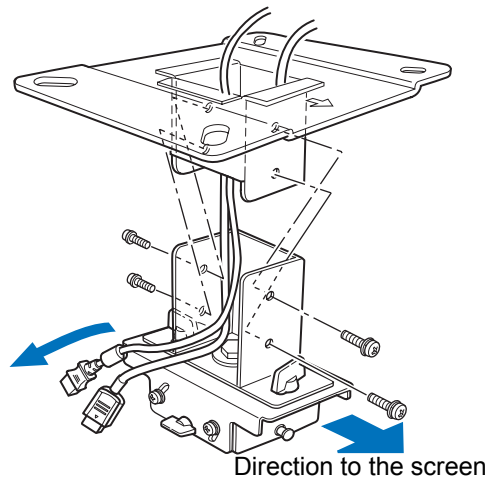

### 6 Attach the Joint fitting to the Ceiling-mount bracket

Secure the Ceiling-mount bracket using the four M5 screws removed during preparation.

### 7 Hook the Base bracket to the Joint fitting and secure it temporarily

Hook the Base bracket on the protrusion (A) of the Joint fitting, and secure it temporarily using the four supplied M5 screws (B).

- Pull out the cables.
- Be sure to secure screws (B) tightly after making the adjustment discussed in “Adjust the Projection Angle” (P48).

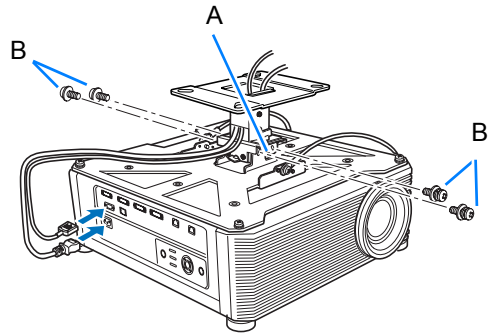

### 8 Connect cables

Connect cables to the projector.

After completion of installation, adjust the projection angle (P48).

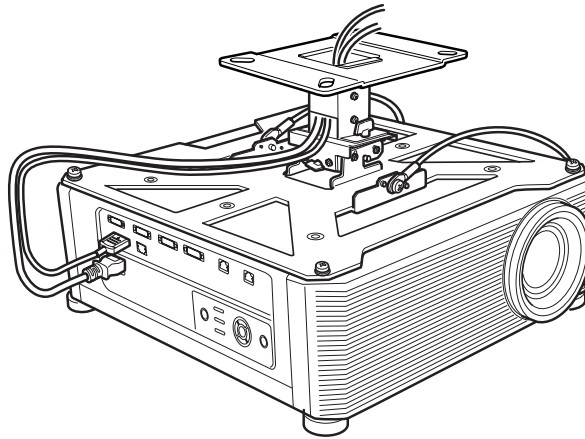

## ■ Installation to a High Ceiling

Use optional extension pipe RS-CL08 or RS-CL09 for high ceiling.

### Preparation: Adjust the pipe length according to the ceiling height

- 1 Remove the covers of outer and inner pipes by slightly sliding them and lift up as shown.
  - 2 Remove four M5 screws from the sides of the outer pipe, adjust the inner pipe length according to the projector installation height, and then secure the four M5 screws.
- When attaching screws in step 2, insert the screws and leave an unused screw hole between them. When the extension pipe is stretched to its maximum length, insert the screws in two adjacent screw holes.

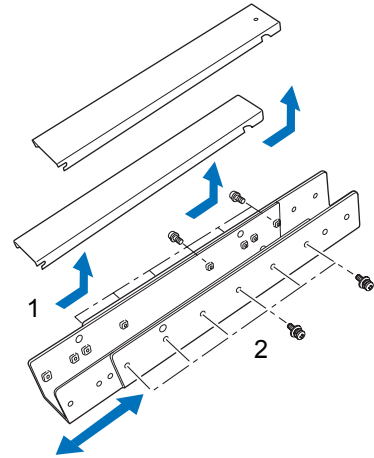

Extended length when extension pipe is attached (when lens shift is 0%)

Mounting hole position	Distance from ceiling to lens axis ( $\ell$ )	
	RS-CL08	RS-CL09
a	57.9 cm (22.8")	77.9 cm (30.7")
b	62.9 cm (24.8")	82.9 cm (32.6")
c	67.9 cm (26.7")	87.9 cm (34.6")
d	72.9 cm (28.7")	92.9 cm (36.6")
e	77.9 cm (30.7")	97.9 cm (38.5")
f	/	102.9 cm (40.5")
g		107.9 cm (42.5")
h		112.9 cm (44.4")
i		117.9 cm (46.4")

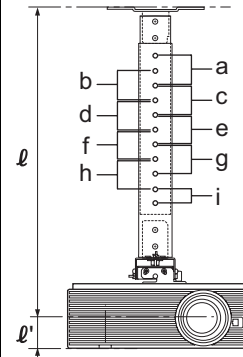

- 1 Separate the Joint fitting from the Ceiling-mount bracket temporarily (Preparation on page 42)
- 2 Make a hole in the ceiling (Step 1 on page 42)
- 3 Secure the Ceiling-mount bracket to the ceiling (Step 2 on page 42)
- 4 Attach the Base bracket to the projector (Step 3 on page 43)
- 5 Attach the anti-fall wire (Step 4 on page 43)

## Installation Procedure

### 6 Attach the top of the extension pipe to the Ceiling-mount bracket

Secure to the extension pipe using the four supplied M5 screws.

- The open end of the pipe should face the open end of the Ceiling-mount bracket as shown.

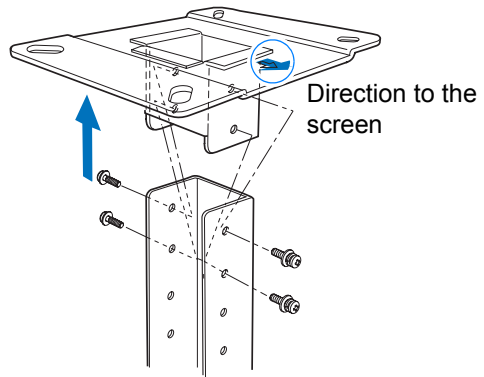
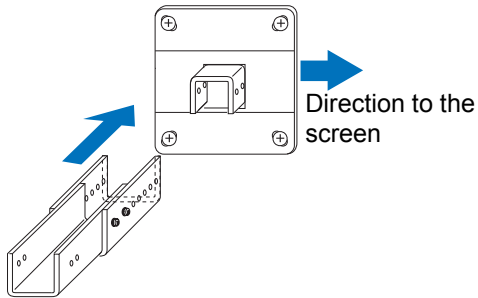

### 7 Attach the Joint fitting to the bottom of the extension pipe

Use the four M5 screws removed from the Ceiling-mount bracket during preparation.

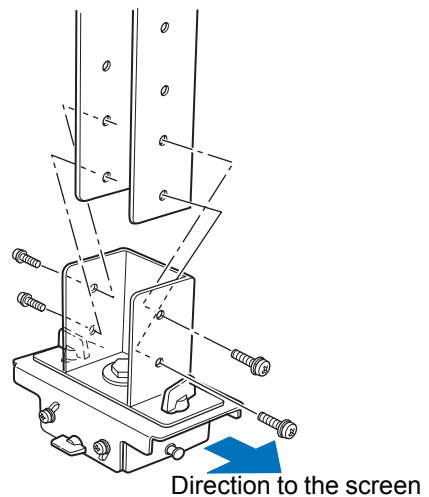

## 8 Hook the Base bracket to the Joint fitting and secure it temporarily

Hook the Base bracket on the protrusion (A) of the Joint fitting, and secure it temporarily using the four supplied M5 screws (B).

- Pull out the cables.
- Be sure to secure screws (B) tightly after making the adjustment discussed in “Adjust the Projection Angle” (P48).

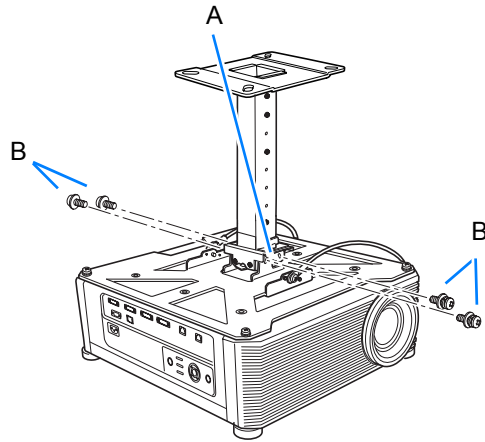

## 9 Put the cables in to the pipe and attach the covers

Thread any cables that are too thick for the ceiling-mount bracket hole through a separate hole you have opened.

- 1 Pull the cables out of the cable hole in the ceiling.
- 2 Put the cables inside the pipe.
- 3 Close the inner cover of the pipe and then close outer cover of the pipe.

Secure to the extension pipe using the supplied M3 screw.

- 4 Connect the cables to the projector.

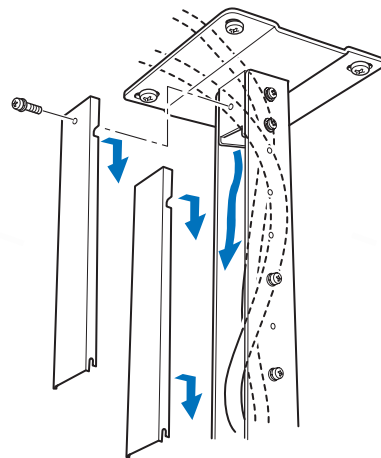

# Adjust the Projection Angle

Turn on the projector, project an image, and then adjust the projection angle and screen slant angle.



- After completion of adjustment, tighten the screws and check that every fitting is secured firmly.
- Be sure to hold the projector from falling until the Ceiling-mount bracket and Base bracket are secured firmly.

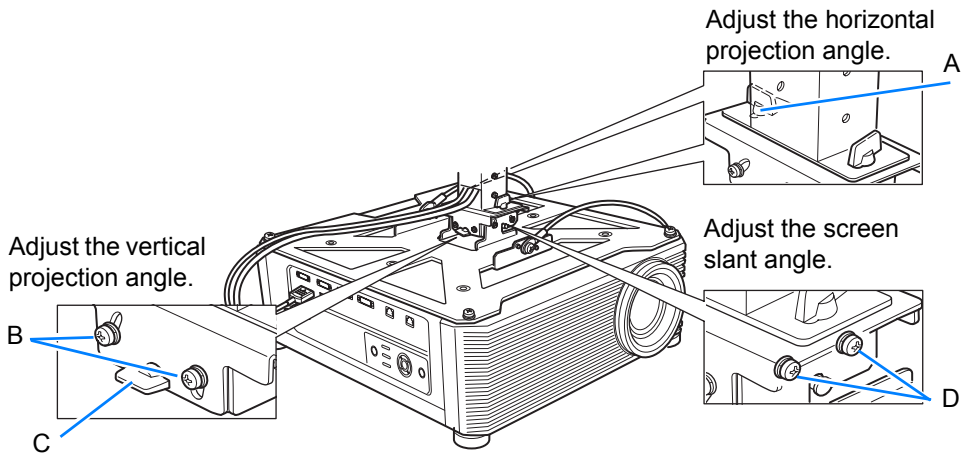

## ■ Adjust the horizontal projection angle

- 1 Loosen two wing screws (A). Move the projector horizontally to adjust the horizontal projection angle.
- 2 When the projector is correctly positioned, tighten the wing screws.

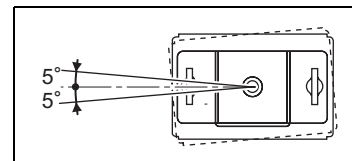
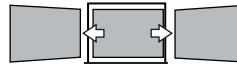

## ■ Adjust the vertical projection angle

- 1 First loosen four screws (B) and then loosen two wing screws (C). Move the projector vertically to adjust the vertical projection angle.
- 2 When the projector is correctly positioned, first tighten the wing screws (C) and next tighten the four screws (B).

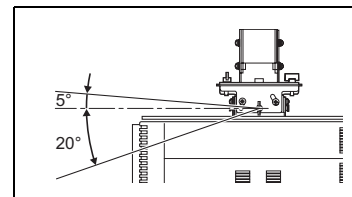
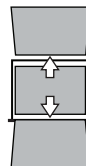



## ■ Adjust the screen inclination

- 1 Loosen four screws (D), and then adjust the slant angle of the projector.
- 2 When the projector is correctly positioned, tighten the four screws (D).

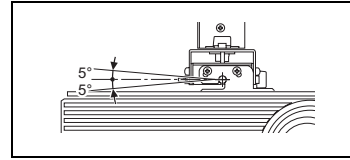
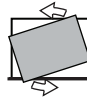

### Precautions when replacing lamps that stop working

- If illumination suddenly stops, either when you turn the projector on or after it has been on for a while, the lamp may have ruptured. In this case, never attempt to replace the lamp by yourself. Always request service from the Canon Customer Support Center.
- With ceiling-mounted projectors, the lamp may fall out when you open the lamp cover, or during replacement. During replacement, stand to the side of the lamp cover, not directly under it.
- If the lamp ruptures, dust and gas (containing mercury vapor) may come out of the exhaust vents. If this happens, immediately open the windows and doors to provide ventilation to the room.
- If you accidentally inhale gas from the lamp or get any pieces in your eyes or mouth, consult a doctor immediately.



## Relationship between Projecting Distance and Image Size

The projected image size is determined by the distance to the screen (projection distance), the size of the image (P68), and the level of focus (P67). Refer to the following table and decide the distance between the projector and screen.

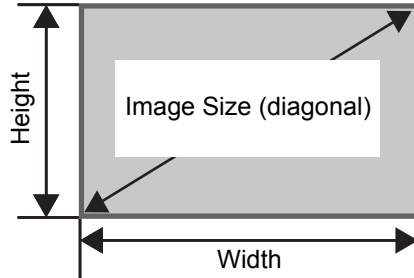

### 4K500ST

Image Size (Dia.)	4096 x 2160		4096 x 2400		Projection distance [m (feet)]	
	Width [cm (in)]	Height [cm (in)]	Width [cm (in)]	Height [cm (in)]	Wide limit	Tele limit
40	90 (35.4)	47 (18.5)	88 (34.6)	51 (20.1)	0.9 (3.0)	1.1 (3.6)
60	135 (53.1)	71 (28.0)	131 (51.6)	77 (30.3)	1.3 (4.3)	1.7 (5.6)
80	180 (70.9)	95 (37.4)	175 (68.9)	103 (40.6)	1.8 (5.9)	2.3 (7.5)
100	225 (88.6)	118 (46.5)	219 (86.2)	128 (50.4)	2.2 (7.2)	2.9 (9.5)
120	270 (106.3)	142 (55.9)	263 (103.5)	154 (60.6)	2.7 (8.9)	3.5 (11.5)
140	315 (124.0)	166 (65.4)	307 (120.9)	180 (70.9)	3.1 (10.2)	4.1 (13.5)
160	359 (141.3)	190 (74.8)	351 (138.2)	205 (80.7)	3.6 (11.8)	4.7 (15.4)
180	404 (159.1)	213 (83.9)	394 (155.1)	231 (90.9)	4.0 (13.1)	5.3 (17.4)
200	449 (176.8)	237 (93.3)	438 (172.4)	257 (101.2)	4.5 (14.7)	5.8 (19.0)
220	494 (194.5)	261 (102.8)	482 (189.8)	282 (111.0)	4.9 (16.1)	6.4 (21.0)
240	539 (212.2)	284 (111.8)	526 (207.1)	308 (121.3)	5.4 (17.7)	7.0 (23.0)
260	584 (229.9)	308 (121.3)	570 (224.4)	334 (131.5)	5.9 (19.4)	7.6 (24.9)
280	629 (247.6)	332 (130.7)	614 (241.7)	360 (141.7)	6.3 (20.7)	8.2 (26.9)
300	674 (265.4)	355 (139.8)	657 (258.7)	385 (151.9)	6.8 (22.3)	8.8 (28.9)
350	786 (309.4)	415 (163.4)	767 (302.0)	449 (176.8)	7.9 (25.9)	10.3 (33.8)
400	899 (353.9)	474 (186.6)	877 (345.3)	514 (202.4)	9.0 (29.5)	11.8 (38.7)
450	1011 (398.0)	533 (209.8)	986 (388.2)	578 (227.6)	10.2 (33.5)	13.2 (43.3)
500	1123 (442.1)	592 (233.1)	1096 (431.5)	642 (252.8)	11.3 (37.1)	14.7 (48.2)
550	1236 (497.2)	652 (256.7)	1205 (474.4)	706 (278.0)	12.4 (40.7)	16.2 (53.1)
600	1348 (530.7)	711 (279.9)	1315 (517.7)	770 (303.1)	13.6 (45.3)	17.7 (58.1)

# Lens Shift Function

You can reposition the image in all directions by pressing the **SHIFT** button on the remote control, which moves the lens up, down, left, or right. For instructions, refer to "Adjusting the Image Position" (P70).

## Amount of Lens Shift

The amount of lens shift is indicated as a percentage relative to the image height and width. The lens shift ranges for the projector are as follows.

A (Amount of vertical shift)	±60%
B (Amount of horizontal shift)	±10%

The lens can be shifted up or down and to the left or right. Performance using lens shift is ensured within the recommended range described below. However, peripheral dimness or blurriness may occur in the corners outside the last 10% of the horizontal lens shift range and outside the last 15% of the vertical lens shift range. In this case, adjust lens shift to within the recommended range.

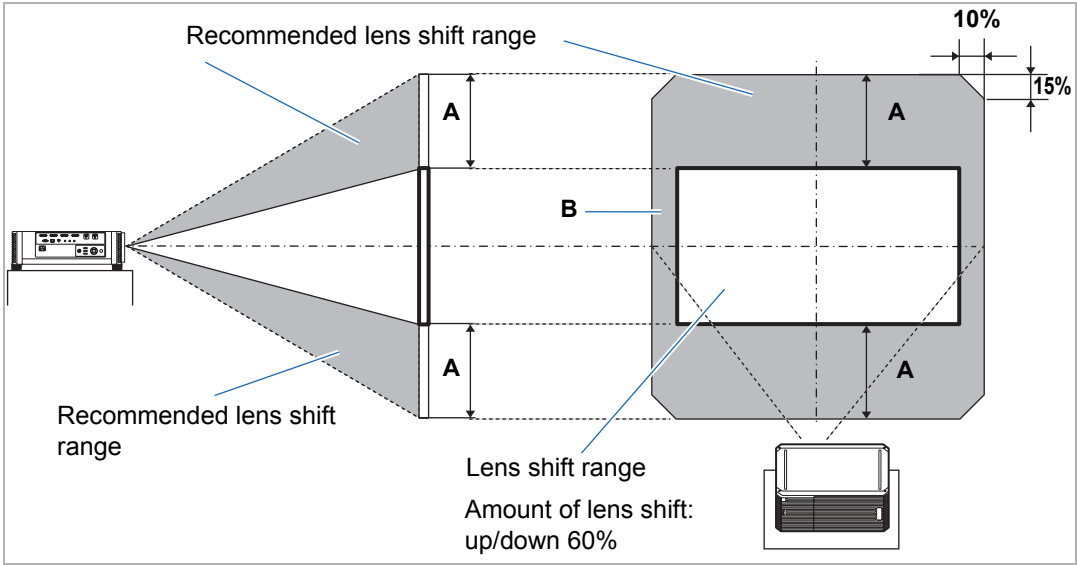

## 4K500ST

Maximum vertical (A) and horizontal (B) movement using lens shift  
(reference values [cm (in)])

Image size (Dia.)	4096 x 2400		4096 x 2160	
	A	B	A	B
40	31 (12.2)	9 (3.5)	28 (11.0)	9 (3.5)
60	46 (18.1)	13 (5.1)	43 (16.9)	13 (5.1)
80	62 (24.4)	18 (7.1)	57 (22.4)	18 (7.1)
100	77 (30.3)	22 (8.7)	71 (28.0)	22 (8.7)
120	92 (36.2)	26 (10.2)	85 (33.5)	27 (10.6)
140	108 (42.5)	31 (12.2)	100 (39.4)	31 (12.2)
160	123 (48.4)	35 (13.8)	114 (44.9)	36 (14.2)
180	139 (54.7)	39 (15.4)	128 (50.4)	40 (15.7)
200	154 (60.6)	44 (17.3)	142 (55.9)	45 (17.7)
220	169 (66.5)	48 (18.9)	156 (116.9)	49 (19.3)
240	185 (72.8)	53 (20.9)	171 (67.3)	54 (21.3)
260	200 (78.7)	57 (22.4)	185 (72.4)	58 (22.8)
280	216 (85.0)	61 (24.0)	199 (78.3)	63 (24.8)
300	231 (90.9)	66 (26.0)	213 (83.9)	67 (26.4)
350	269 (105.9)	77 (30.3)	249 (98.0)	79 (31.1)
400	308 (121.3)	88 (34.7)	284 (111.8)	90 (35.4)
450	347 (136.6)	99 (39.0)	320 (126.0)	101 (39.8)
500	385 (151.6)	110 (43.3)	355 (139.8)	112 (44.1)
550	424 (166.9)	121 (47.6)	391 (153.9)	124 (48.8)
600	462 (181.9)	132 (52.0)	427 (168.1)	135 (53.1)



- (A) values are the approximate vertical lens shift distance from the central image position within the supported lens shift range.
- (B) values are the approximate horizontal lens shift distance from the central image position within the supported lens shift range.



- Watch projected images as you perform lens shift adjustment.
- When the image no longer moves, you have reached the limit of the lens shift range.

# Connection Procedure



Caution

**Before connecting the projector to other equipment, turn off both the projector and the other equipment.**



For instructions on connecting multiple sources of input for 4K projection, refer to “Multi Input 4K Projection” (P55).

## Connecting a Computer

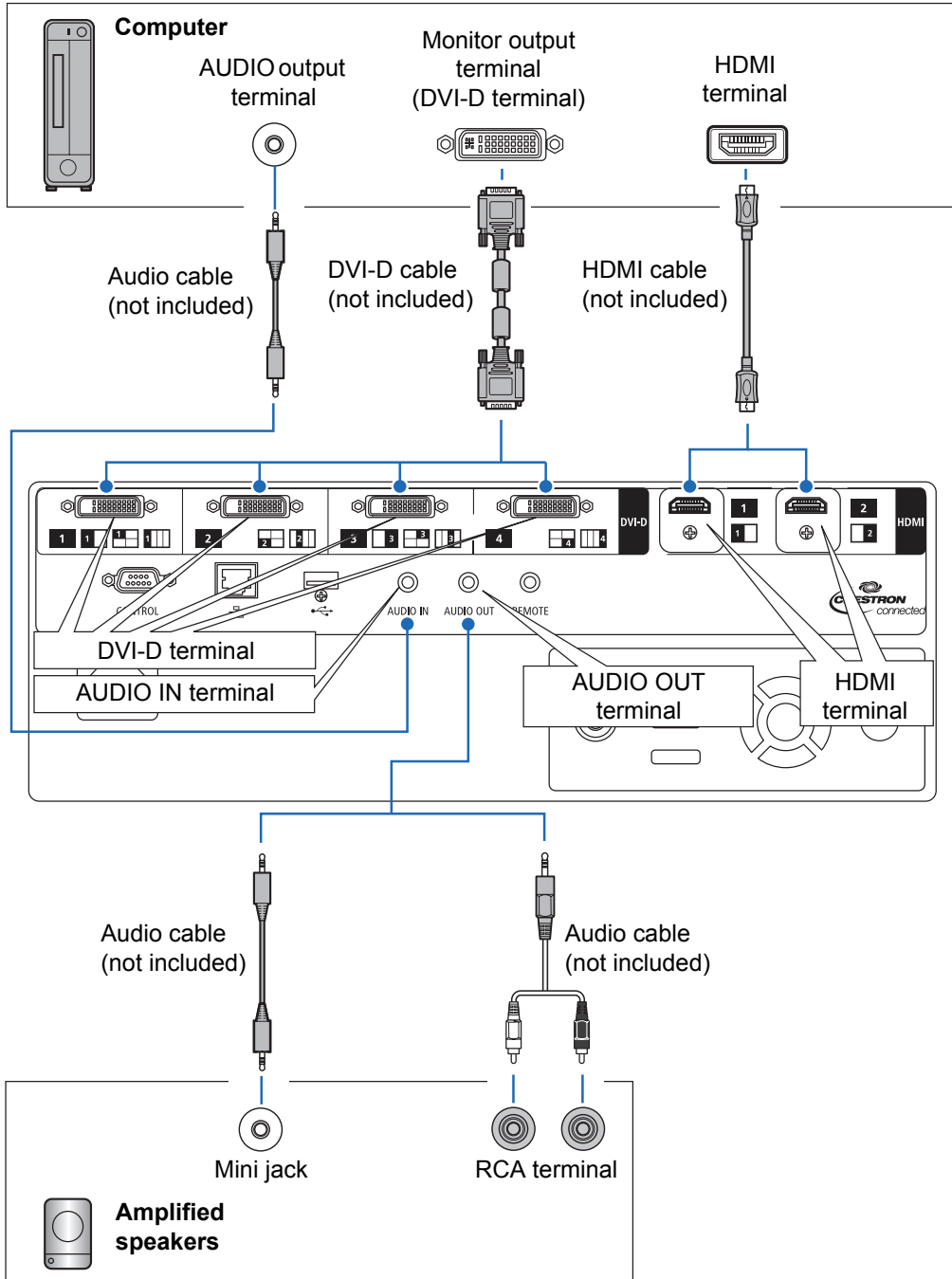

# Connecting AV Equipment

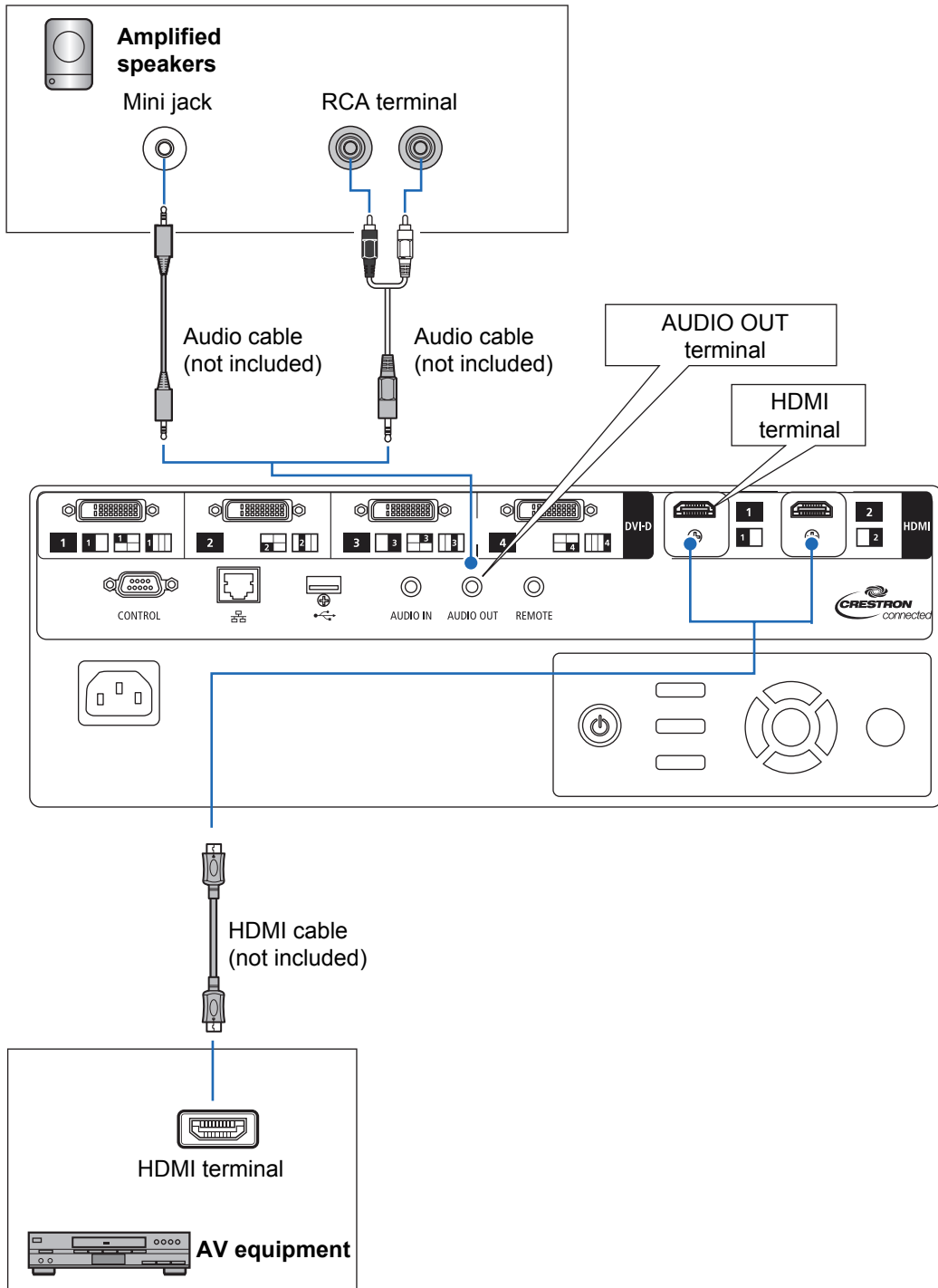

# Multi Input 4K Projection

## ■ Definition of 4K

4K refers to high-resolution video with a horizontal resolution of about 4,000 pixels, which is four times the resolution of full HD (1920 x 1080).

Although 4K is a convenient description, it encompasses several different resolutions, such as 3840 x 2160, 3840 x 2400, 4096 x 2160, and 4096 x 2400. (4096 x 2160 is also referred to as Ultra HD, and 3840 x 2400 as WQUXGA.)

The projector supports resolutions up to 4096 x 2400. For details, check the table of supported signals. (P169)

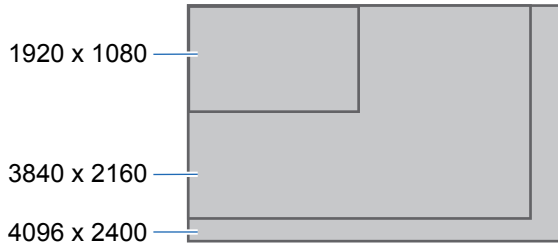

## ■ 4K Support Using Digital Signals and Multiple Inputs

The projector is equipped with DVI-D and HDMI (1.4) inputs for digital signals. However, these signals cannot be used as-is for 4K projection.

DVI-D is classified as single-link or dual-link, depending on the dot clock. Projecting resolutions with a dot clock higher than 165 MHz requires a dual-link plug and cable.

The following resolutions are supported.

- 1920 x 1200 (single-link; vertical frequency: 60 Hz)
- 2560 x 1600 (dual-link; vertical frequency: 60 Hz)
- 4096 x 2160 (dual-link; vertical frequency: 24 Hz)

However, most current computers are limited to a maximum DVI-D output resolution of 2560 x 1600.

For HDMI 1.4, the following resolutions are supported.

- 1920 x 1080 (vertical frequency: 60 Hz)
- 3840 x 2160 (vertical frequency: 24 Hz / 25 Hz / 30 Hz)
- 4096 x 2160 (vertical frequency: 24 Hz)

To avoid the limitation with DVI-D that a single signal line cannot carry video with a resolution of 4096 x 2400 (vertical frequency: 60 Hz) even with a dual-link cable, the projector enables you to project multiple lines of input at once. This feature is called Multi Input mode.

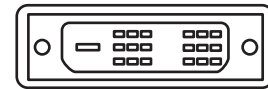

Single-link plug

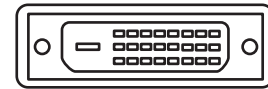

Dual-link plug

Number of dual-link cables	1	4
Compatible video signals	4096 x 2160 (vertical frequency: 24 Hz)	4096 x 2400 (vertical frequency: 60 Hz)

### ■ Connections for Multi Input Mode

Multi Input mode requires that the computer's video output (whether dual-link compatible DVI-D or HDMI) support split-screen display or display in four quadrants. To connect the projector to computers, use up to four DVI cables and two HDMI cables.

Refer to the following figure.

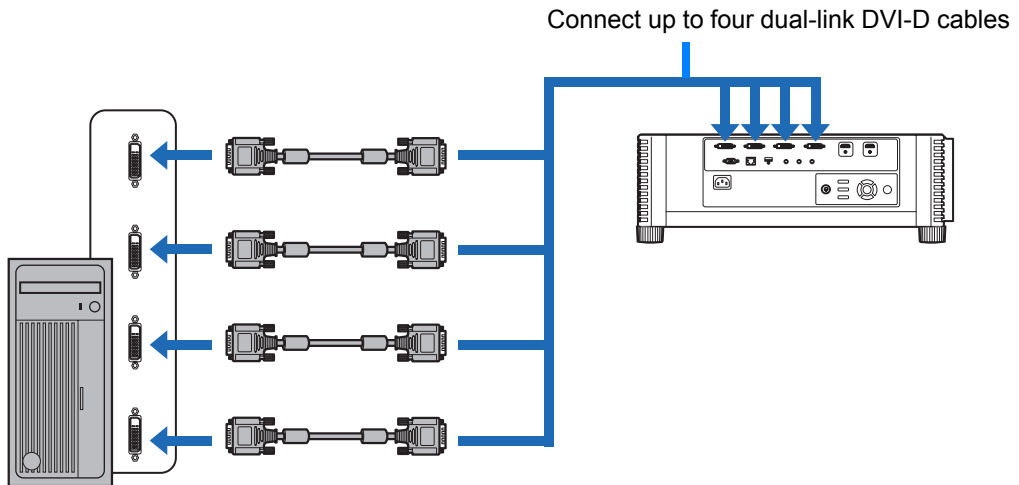

**Connect workstations by using four dual-link DVI cables**

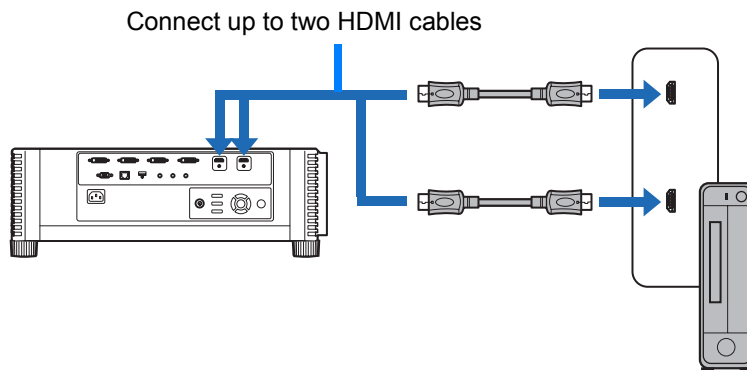

**Connect desktop computers by using two HDMI cables**

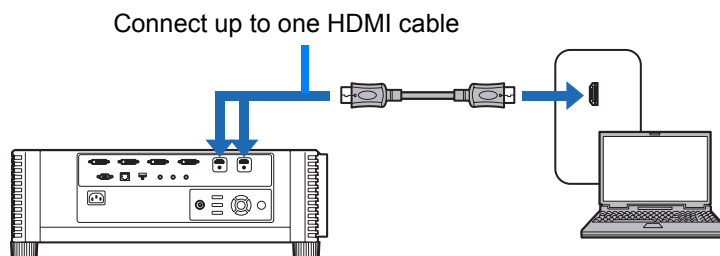

**Connect notebook computers by using one HDMI cable**



You cannot project on two or four screens when the projector is connected to multiple computers or pieces of AV equipment.



## ■ Settings for Multi Input Mode

Select how to combine four DVI inputs or two HDMI inputs to form an image. Check computer video output settings in advance, because you must match the display layout (whether split-screen display or display in four quadrants).



### Multi Input Mode

Specify the type of image (including resolution) supplied to the terminals. Use [Normal] for most signals. For specific signals, use [Single], [1x2], [2x2], or [1x4] as needed. For details, check the table of supported signals. (P169)

- [Normal] setting  
Supports many typical images, including [Single], [1x2], [2x2], and [1x4].
- [Single] setting  
Supports many specialized signals from a single piece of connected equipment.
- [1x2] setting  
Supports many specialized signals when two signals are supplied.
- [2x2] setting  
Supports many specialized signals when four signals are supplied, for projection in a 2x2 layout.
- [1x4] setting  
Supports many specialized signals when four signals are supplied, for projection side by side.

**1** In the [Install settings] menu, select [Professional settings] > [Multi input mode select].



**2** Select the input mode to use.

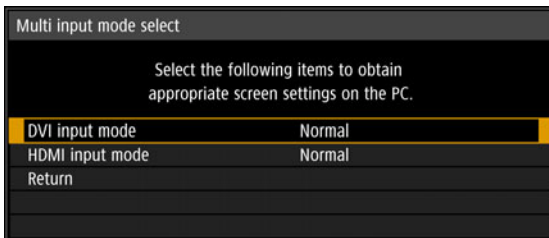

## Connection Procedure

### DVI input mode

Specify the combination of DVI input. Choose from [Normal], [Single], or [1x2], [2x2], or [1x4].

- Normal
- Single
- DVI 1x2
- DVI 2x2
- DVI 1x4

### HDMI input mode

Specify the combination of HDMI input. Choose from [Normal], [Single], or [1x2].

- Normal
- Single
- HDMI 1x2

These examples show projection in the case of [1x2], [2x2], and [1x4].

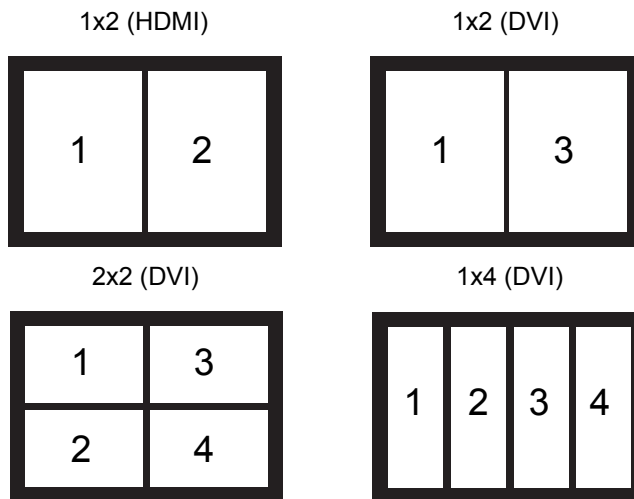

When this setting is set to [Normal], the EDID (unique ID that conveys to computers the model name and setting values of connected display devices) is a list that consists of video signals used with one or multiple projector terminals. On the video output equipment, you can specify video signals for use with a different number of terminals.



[Multi input mode select] window is displayed automatically if the input terminals do not match the settings configured by using the **INPUT** button.

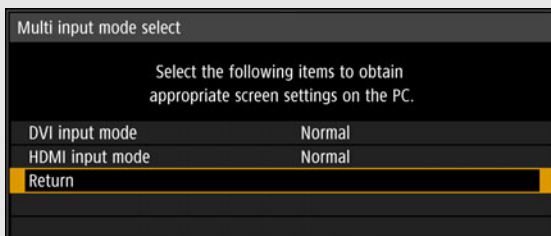

## ■ 4K Projection Notes

Colors may appear distorted when images are viewed from the side on some screens, but this does not indicate a problem with the projector. For best results, use a matte screen with a wide viewing angle.

## Plugging the Projector In

Connect the power cord to the projector and plug it in.

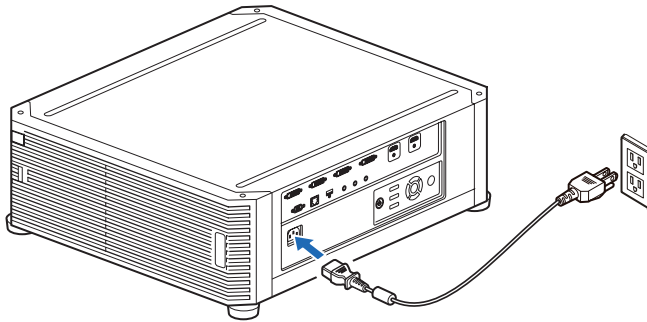

- **Be sure to connect the ground wire of the power cord to ground.**
- **Be sure to connect the ground wire before connecting the power plug to the outlet. Also when you disconnect the ground wire, be sure to unplug the power plug from the outlet beforehand.**



- Fully insert the power cord plug into the socket.
- After turning off the projector, wait at least 5 minutes before turning it on again. Turning the projector on immediately after turning it off may shorten the lamp life.
- Unplug the power cord when the projector is not in use.

# Projection Procedure

## Step 1 Turn the Projector On

### 1 Check the connection between the projector and the computer or AV equipment. (P53, P54)

For instructions on connecting the power cord, refer to “Plugging the Projector In” (P59).

### 2 Press the **POWER** button.

The [POWER] indicator initially flashes green, after which it remains lit.

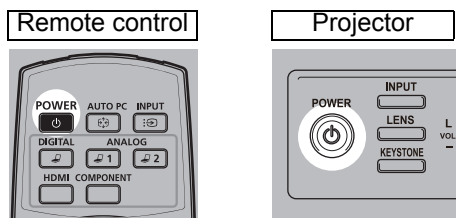

The countdown window is displayed for approximately 20 seconds, and then the projection is started. Press the **OK** or **EXIT** button to hide the countdown window.



- Network functions are not available until about 40 seconds after you plug the projector in.
- Some noise may appear in the projected image during the first few minutes, until the image stabilizes.
- A window appears when the projector is turned on for the first time. You can select a language to be used by the projector for displaying menus and messages in the window. Select the desired language with the pointer buttons and press the **OK** button. (P61)  
You can change the language from the menu at a later time. (P116)

### 3 Turn on the computer or AV equipment power.

Images from the computer or AV equipment are now projected.

#### Changing Operations When Projector is Turned On

You can change operations when the projector is turned on as follows.

- You can turn on the projector by connecting the power cord, without pressing the **POWER** button. (P115)
- You can change the countdown window. (P109)
- You can skip the countdown window. (P109)

#### When the Projector Is Left Idle

If no signal is received, the power management feature automatically turns off the projector after a certain period of inactivity (by default, 15 minutes). (P114)

## ■ When the Language Selection Screen Appears

A screen appears when the projector is turned on for the first time. You can select a language to be used by the projector for displaying menus and messages in the window. Select the desired language with the pointer buttons and press the **OK** button.

You can change the language from the menu at a later time. (P116)

If the language selection screen is out of focus, adjust the focus. (P67)

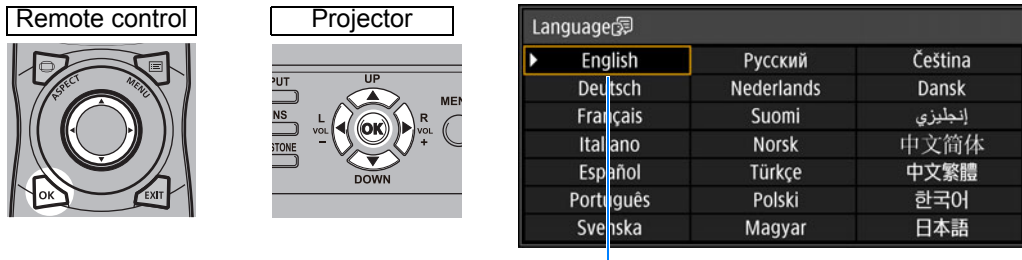

An item highlighted in orange will be selected.

## ■ When the Password Input Screen Appears

If you have set a password, the password input screen appears. Enter your password. (P117)

## ■ When “No signal” Appears

With a notebook computer, the user must turn on the external monitor output. (P62)  
Press the **INPUT** button to select the input signal. (P63)

## ■ When Notebook Computer Screen Does Not Appear

Set your notebook computer to output signals to an external monitor. For more details, refer to “Changing Notebook Computer Screen Output” (P62).

## ■ Adjusting Image

- Set the display resolution of the computer to the highest resolution or the resolution closest to that setting. (P65)
- Use the **ZOOM** button on the remote control to resize the projected image. (P68)
- If the image is blurry, use the **FOCUS** button on the remote control to adjust focus. (P67)
- Correct any keystone distortion by pressing the **KEYSTONE** button. (P73)
- Select a screen mode (aspect) according to the aspect ratio of the screen, type of input image signal etc. (P72)
- Select an image mode depending on the projected image. (P76)



The image can also be adjusted by projecting a test pattern (P168).

### Changing Notebook Computer Screen Output

For projection from a notebook computer, the computer settings must be adjusted to switch display output.

This operation is not required for a desktop computer.

#### ■ Turning on External Monitor Output

You can turn on the external monitor output via keyboard operation.

To turn on the external monitor output with most computers, press the function key ([F1] to [F12]) which is marked with the external monitor icon while holding down the [Fn] key.

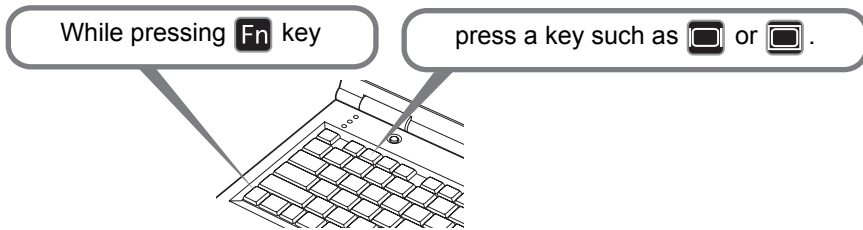

- The function key you use and the method used to turn on the external monitor output vary depending on the model. For details, see the manual for your notebook computer.
- With Windows 8.1, Windows 8 or Windows 7, you can turn on image output by holding down the Windows logo key and pressing the [P] key.

## Step 2 Select an Input Signal

Select the input signal in the [Input] menu when you want to project a digital PC or AV equipment signal, or to switch between inputs when multiple computers or multiple sets of AV equipment are connected.

Skip this step if you have not changed the input signal since the last projection.

### 1 Press the **INPUT** button to display the window shown below.

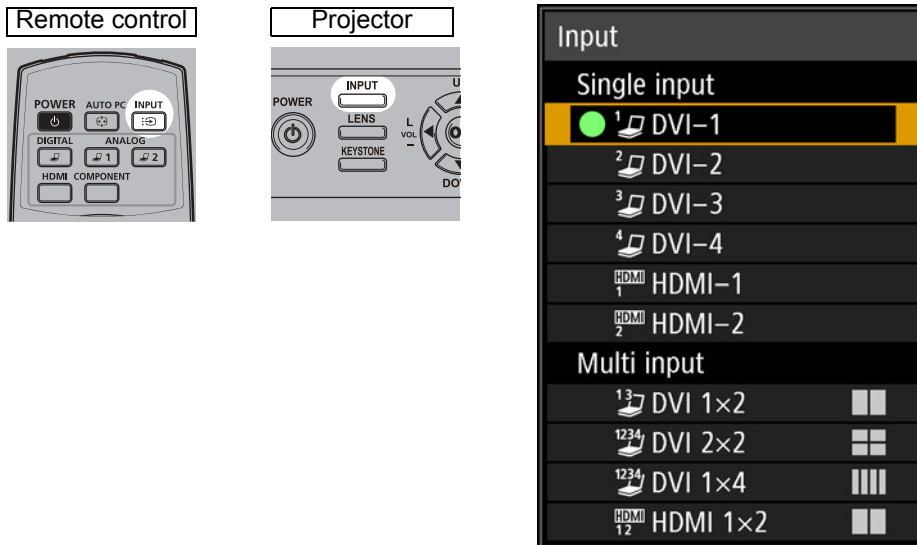

The currently active input signal is marked with a green circle and enclosed by a orange border.

Names of input signals available for projection are displayed in white, and unavailable signal names are grayed out.

### 2 Press the **[▲]** / **[▼]** buttons to select the input signal.

You can also switch from one DVI-D input source to the next by pressing the **DIGITAL** button, or from one HDMI input source to the next by pressing the **HDMI** button.

### 3 Press the **OK** button to confirm the input signal type.

## Projection Procedure



- You can also switch to your preferred input signal for projection by pressing buttons on the remote control to switch input signals (specifically, the **DIGITAL** or **HDMI** button).
- In multi input mode, the projector combines two or four sources of input for projection together. As sources of input for projection at 4K or other resolutions, choose from [DVI 1x2], [DVI 2x2], [DVI 1x4], or [HDMI 1x2]. (P55)
- Signals you supply for Multi Input mode must meet certain conditions. If the signals do not meet these requirements, a [!] icon is displayed.

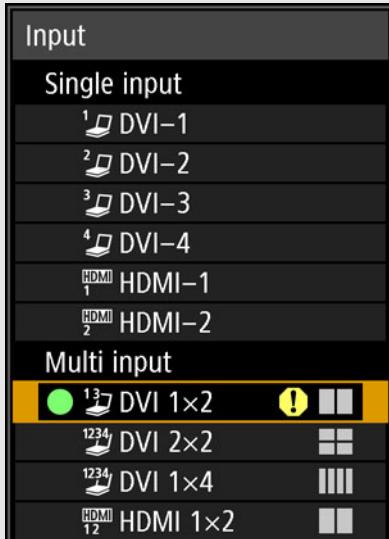



## Step 3 Adjust the Image

### Setting the Display Resolution of the Computer

Based on the maximum resolution of the projector, set the display resolution of the computer to the resolution closest to the output signal resolution of the projector. (P169)

#### Maximum resolution

- 4096 x 2160: When [Panel drive mode] is set to [4096x2160].
- 4096 x 2400: When [Panel drive mode] is set to [4096x2400].

#### ■ Windows 8.1 / Windows 8

- 1** Move the cursor toward the upper or lower right corner to access the menu.
- 2** Click [Settings], and then click [Control Panel].
- 3** From [Control Panel Home] - [Appearance and Personalization], select [Adjust screen resolution].
- 4** Click the [Resolution] tab, and move the slider to select the resolution closest to the maximum output signal resolution of the projector.
- 5** Click the [OK] button.

#### ■ Windows 7

- 1** Open the [Control Panel] from the start menu, then select [Appearance and Personalization] - [Adjust screen resolution] in the [Control Panel Home].
- 2** Click the [Resolution] tab, and move the slider to select the resolution closest to the maximum output signal resolution of the projector.
- 3** Click the [OK] button.

### ■ Windows Vista

- 1** Open the [Control Panel] from the start menu, then select [Appearance and Personalization] - [Adjust screen resolution] in the [Control Panel Home].
- 2** Select the resolution closest to the maximum output signal resolution of the projector from the [Resolution] list.
- 3** Click the [OK] button.

### ■ Mac OS X

- 1** Open the Apple Menu and select [System Preferences].
- 2** In the [System Preferences] window, click the [Displays] icon to display the Display window.
- 3** Select the [Display] tab and select the resolution closest to the maximum output signal resolution of the projector from the [Resolutions] list.
- 4** Close the [System Preferences] window.

## Focusing, Resizing, or Moving the Image

### ■ Adjusting Image Focus

To adjust the focus, press the **FOCUS** button on the remote control or the **LENS** button on the projector.

- 1 Press either the **FOCUS** button on the remote control or the **LENS** button on the projector to display the focus adjustment window.

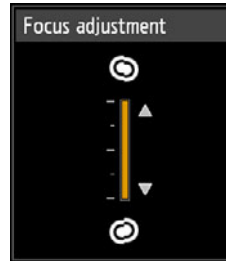
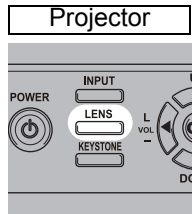
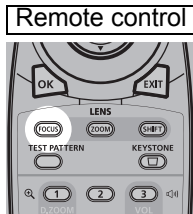

- 2 Press the pointer buttons to adjust the focus.

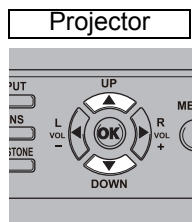
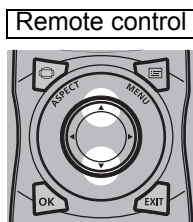

To adjust the focus, use the [▲] / [▼] button on the remote control or projector.

- 3 When the focus is adjusted optimally, press the **OK** button or the **FOCUS** button.



If the screen is curved, you can adjust the focus of the image edges. Refer to “Marginal focus” (P102) and “Adjusting Peripheral Focus” (P157).

## ■ Adjusting Image Size

The size of the projected image can be adjusted by pressing the **ZOOM** button on the remote control or the **LENS** button on the projector. Change the projector installation position if your desired image is too large or too small to adjust it with the zoom function. (P36)

- 1 Press the ZOOM button on the remote control to display the zoom adjustment window.**

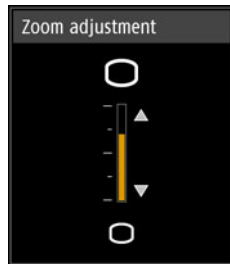
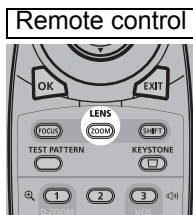

Press the **LENS** button on the projector repeatedly to switch between windows for parameters adjusted by controlling the lens. To access the zoom adjustment window, press the **LENS** button twice (or three times if you have set [Marginal focus] to [On]).

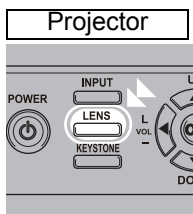

Press twice.

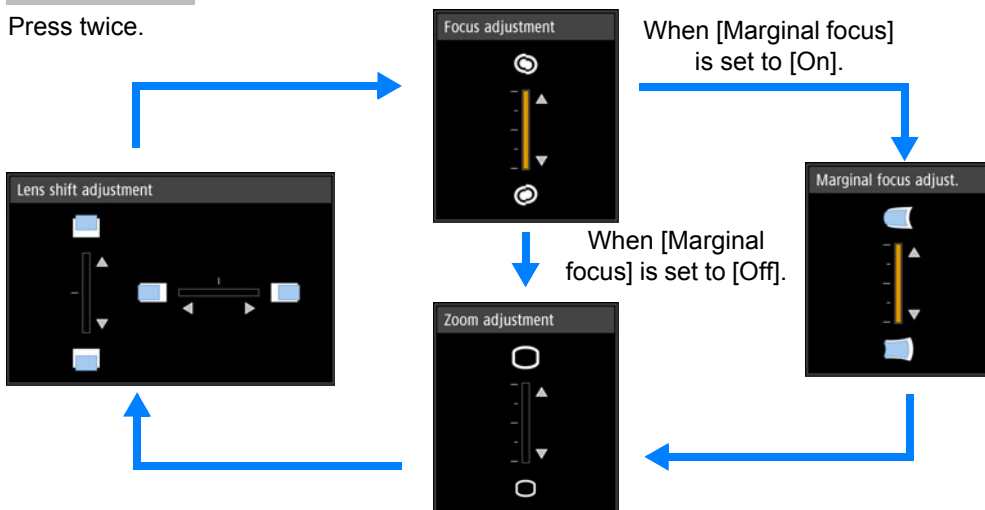

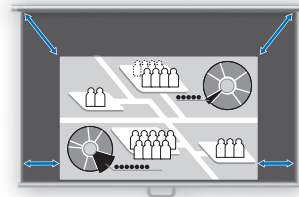
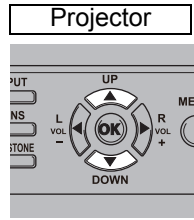
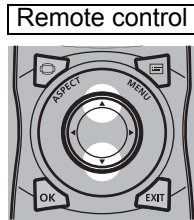
**2 Press the pointer buttons to adjust the image size.**

Screen

To enlarge the image, use the [▲] button on the remote control or projector.  
To reduce the image, use the [▼] button on the remote control or projector.

**3 When the desired image size is selected, press the OK button or the ZOOM button.**

## ■ Adjusting the Image Position

To adjust the screen position up, down, left, or right, press the **SHIFT** button on the remote control or the **LENS** button on the projector. It can change the projected screen to the most suitable position by moving the position of the lens up/down/left/right. (P51)

- 1 Press the **SHIFT** button on the remote control to display the lens shift adjustment window.

Remote control

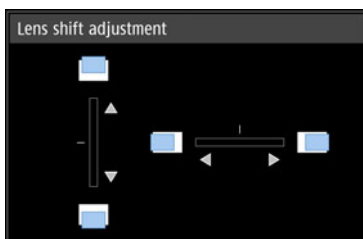
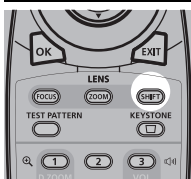

Press the **LENS** button on the projector repeatedly to switch between windows for parameters adjusted by controlling the lens.

To access the lens shift adjustment window, press the **LENS** button three times (or four times if you have set [Marginal focus] to [On]).

Projector

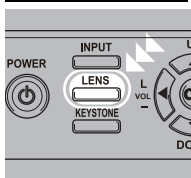

Press three times.

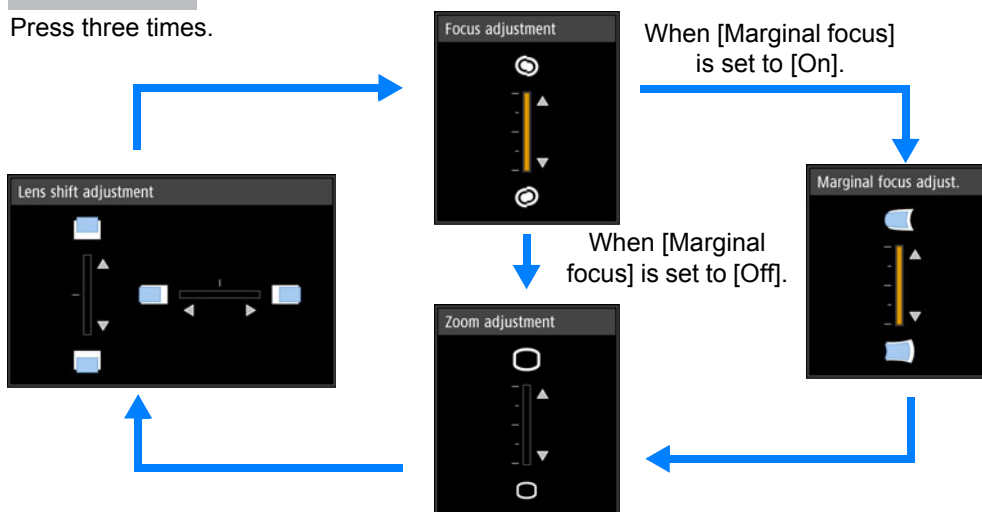

## 2 Press the pointer buttons to adjust.

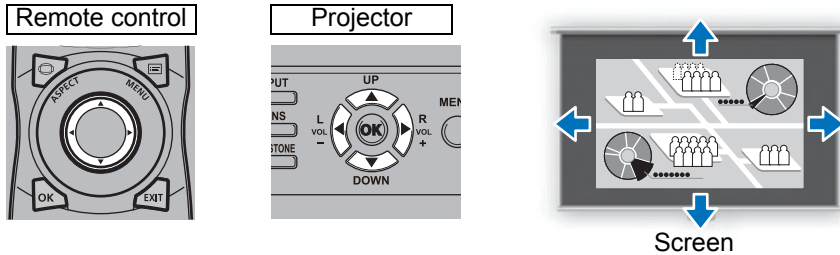

To raise or lower the image, use the [▲] / [▼] buttons on the remote control or projector.

To move the image left or right, use the [◀] / [▶] buttons on the remote control or projector.

To continue moving the image in a specific direction, hold down the corresponding button.

## 3 When the desired position is reached, press the OK button.

### Resetting the Position

The lens position after movement with the lens shift function is not returned when the power is turned off. To return it to its original position, perform reset.

During screen position adjustment, press and hold the **SHIFT** button on the remote control or the **LENS** button on the projector to display the [Lens shift reset] window. Two options are available: 50% (home position) or 0%. Use the pointer buttons to select an option, and then press the **OK** button.

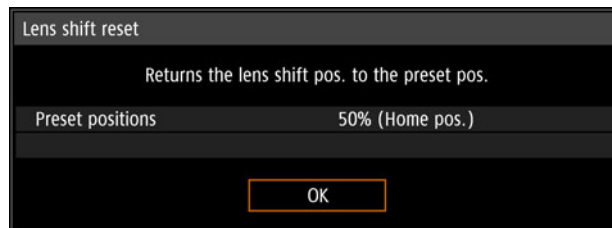

- ❗ • The lens position may be reset slightly misaligned from the position you chose, whether 50% (home position) or 0%.
- For precise positioning, use the lens shift function to fine-tune the position.

## Step 4 Select an Aspect Ratio (Screen Aspect) Matching the Screen

Select an optimum screen mode (aspect) according to the aspect ratio of the screen, type of input image signal and so on for the projection to make best use of the screen size.

**[Aspect]:** In general, select [Auto].

You may need to change the setting depending on the resolution of the computer or other AV equipment connected.

### Select the Aspect

Select [Aspect] based on the input signal type, aspect ratio of the screen and resolution.

### Types of Aspect Ratios

#### ■ Auto

An image is projected at the aspect ratio of the input signal. Select this mode for normal image projection.

#### ■ True size

The image is projected with the original resolution of the input signal. Screens of computers with a lower display resolution than the projector are displayed smaller but clearer than in other aspect ratios.



There may be some cases when this cannot be selected, depending on the input signal and/or resolution.

### Selecting an Aspect Ratio

Press the **ASPECT** button on the remote control and select an appropriate aspect ratio. Press the **ASPECT** button to change the aspect ratio type.

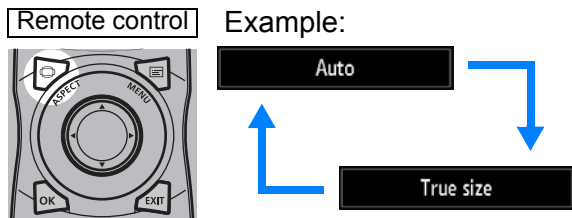

You can also select any aspect ratio from [Aspect] in the menu. (P88)



## Step 5 Adjusting Keystone Distortion

To correct keystone distortion, press the **KEYSTONE** button.

Two types of correction are available: horizontal/vertical correction and corner correction.

Use horizontal/vertical keystone correction to adjust image width or height distortion separately, and use corner correction to adjust the position of each corner of the image.

For instructions on switching keystone correction, refer to “Keystone” (P98).



- Keystone correction may not be effective in some lens shift positions.
- If keystone distortion is excessive and cannot be fully corrected, straighten the projector so that it faces the screen directly.
- Signals are processed digitally when keystone distortion is corrected. The image may look different from the original one. In addition, the aspect ratio of the image may change.

### ■ Horizontal/Vertical Keystone Correction

- 1 Press the **KEYSTONE** button on the remote control or projector to display the horizontal-vertical keystone adjustment window. (When [Keystone] is set to [Horizontal-vertical keystone].)

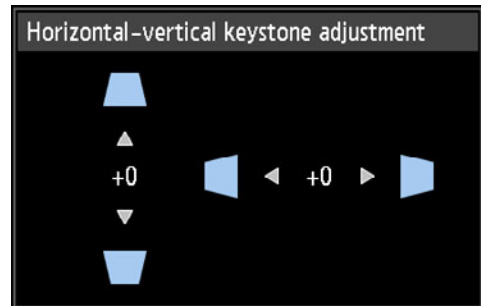
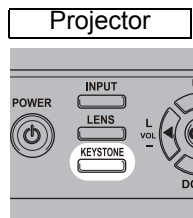
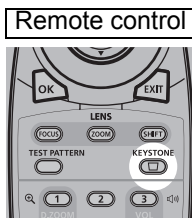

## 2 Press the pointer buttons to adjust the dimensions.

Remote control

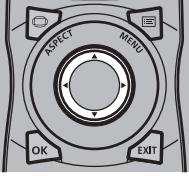

Projector

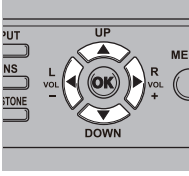

To correct top distortion, press the [▲] button.

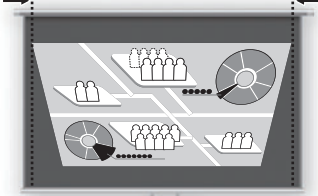

To correct bottom distortion, press the [▼] button.

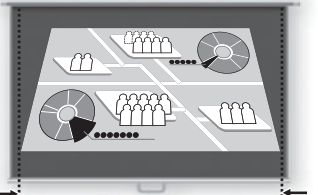

To correct distortion on the left, press the [◀] button.

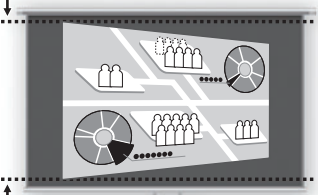

To correct distortion on the right, press the [▶] button.

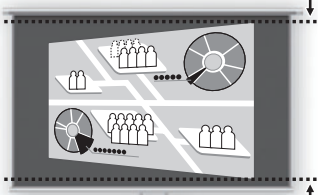

Screen

## 3 When keystone distortion has been corrected, press the OK button.

### ■ Corner Adjustment

#### 1 Press the KEYSTONE button on the remote control or projector to display the corner adjustment window. (When [Keystone] is set to [Corner adjustment].)

Remote control

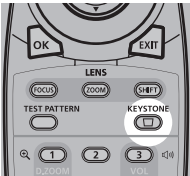

Projector

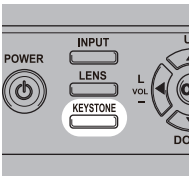

Corner adjustment

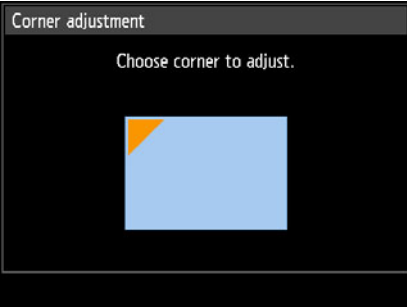

- 2 Press the pointer button of the corner for correction, and then press the OK button.

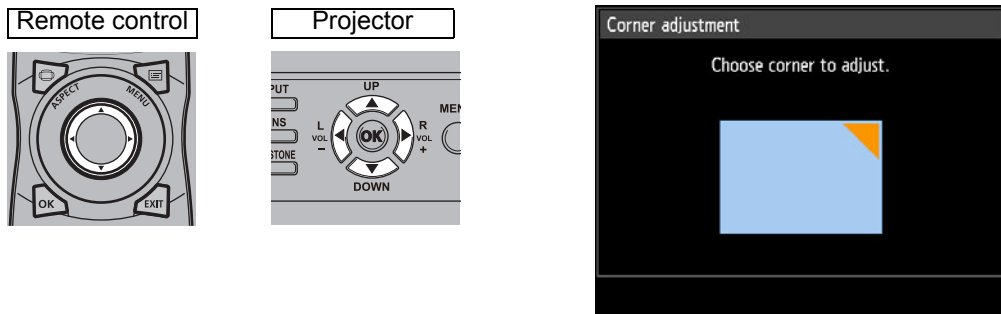

- 3 Press the pointer buttons to adjust the corner.

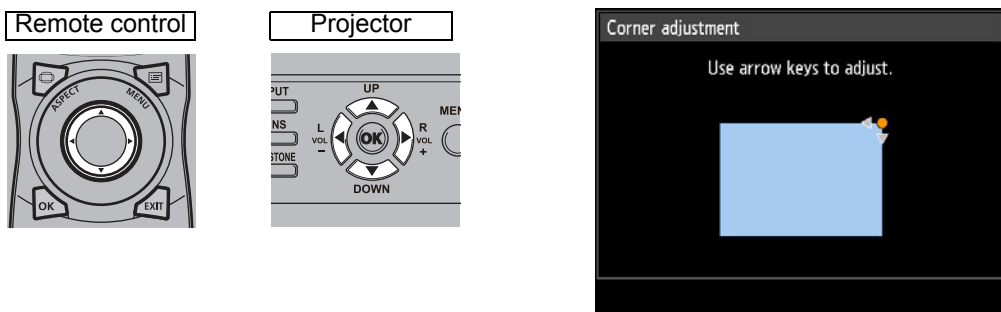

- 4 When you have finished correcting, press the OK button.

### ■ Resetting the Keystone Adjustment

Reset adjustment as follows.

First, press the **KEYSTONE** button on the remote control twice to display the [Keystone reset] window.

Next, select [OK] with the [◀] button, and then press the **OK** button.

Your specified keystone adjustment is now reset.

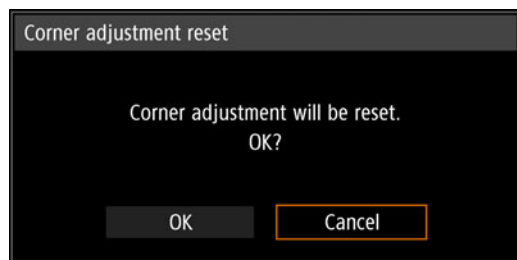
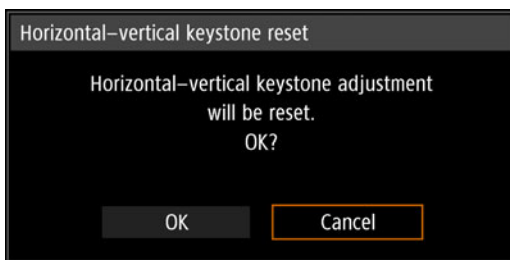

## Step 6 Select the Image Quality (Image Mode)

You can select an image mode to suit the projected image.

In each image mode, you can further adjust the brightness (P92), contrast, sharpness, gamma, color adjustment (P93), advanced adjustment (P93), and lamp mode. (P96)

### Image Modes

Available image modes vary depending on the selected input signal.

○: Compatible —: Not compatible

Image mode	Compatible input signals		Functions (1) Ambient Light in Room (2) Types of Images (3) Good For
	Digital PC	HDMI	
Standard	○	○	(1) Bright (2) Computer screens, or media played with video software (3) Whites and natural colors
Presentation	○	○	(1) Bright (2) Images mainly consisting of text (3) Keeps the screen bright
Dynamic	—	○	(1) Bright (2) Media played with video software (3) Keeps the screen bright
Video	—	○	(1) Somewhat dark (2) Video from camcorders (3) Close to the color space of TVs
Photo/sRGB	○	○	(1) Somewhat dark (2) Digital photos from sRGB-compatible cameras (3) Conforms to the sRGB standard
DICOM SIM	○	○	(1) Adjust gamma to suit the surrounding brightness. (2) Monochrome (medical images, for example) (3) Adjusted to the GSDF curve specified in DICOM Standard Part 14
User 1 – 3	○	○	Up to 3 user-selected combinations of image quality settings can be stored in the memory (P92). Stored settings can be selected as an image mode.

## ■ Selecting an Image Mode

Press the **IMAGE** button on the remote control to select.

The image mode changes each time the **IMAGE** button is pressed. (The displayed image modes vary depending on the selected input signal.)

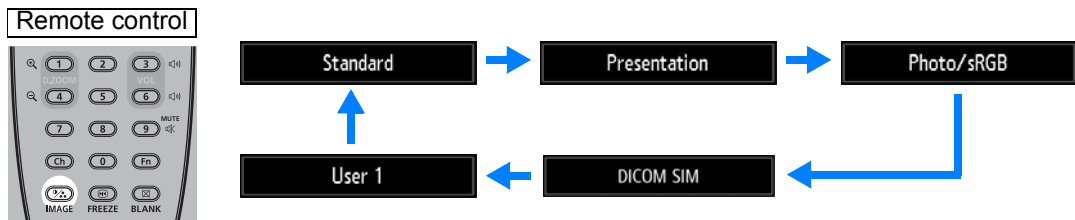

You can also select any image mode from the [Image mode] menu. (P91)

- User settings 1 - 3 are displayed when the desired image settings have been created and stored using the user memory function in the image adjustment menu. (P91)

## Projecting an Image in the DICOM SIM Mode

In the DICOM simulation mode (hereinafter referred to as “DICOM SIM”), this projector can project a monochrome medical image such as an X ray radiography, CT image, MRI image, etc. in the tone similar to the DICOM (Digital Imaging and Communications in Medicine) standard. Typically, to project the image according to the DICOM standard, it requires the grayscale tone correction using a luminance meter according to the environment. In this projector, there are 21 types of tone settings for various ambient lights. You can correct the tone in a simplified manner by selecting the DICOM test pattern (P168).

It is suited to project an image in a medical lecture, academic conference, in-hospital conference, etc.

**This projector is not the display monitor for a medical image. It cannot be used for the radiological image reading or medical examination.**



Caution

- It is recommended to check the tone everytime when using this projector since it does not have the tone correction and calibration functions against the secular change.
- It may take approximately 30 minutes until the projection brightness of this projector becomes stabled.

### ■ Switching the mode to the DICOM SIM Mode

- 1 Press the **IMAGE** button on the remote control until **[DICOM SIM]** is displayed or select **[DICOM SIM]** from **[Image mode]** in the **[Image adjustment]** menu.

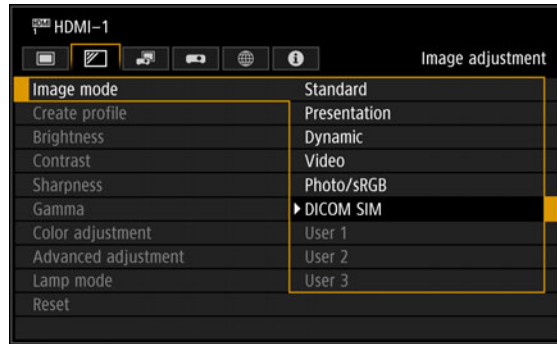

- 2 Press the **TEST PATTERN** button on the remote control until **[DICOM]** is displayed or select **[On]** from **[Test pattern]** in the **[Install settings]** menu.



- 3 As you watch the test pattern, adjust the items in the following menus.

- Brightness
- Contrast
- Sharpness
- Gamma

- 4 Press the **OK** button after the setting.



Perform one of the followings to obtain an appropriate projection:

- Darken the ambient light
- Reduce the image size
- Reduce the projection distance

## Step 7 Turn the Projector Off

- 1 Press the **POWER** button to display the window shown below.

Remote control

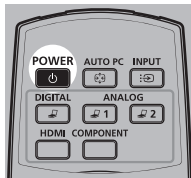

Projector

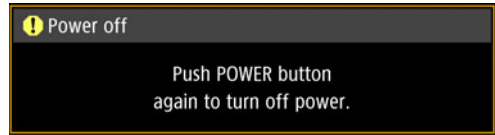
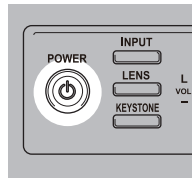

- 2 When this window is displayed, press the **POWER** button again to turn off the power.

After you turn the projector off, the lamp goes off, the [STAND BY] indicator flashes in red, and the projector starts cooling down. After cooling down, the projector enters standby mode. In standby mode, the [STAND BY] indicator remains lit instead of flashing.



If you want to continue projecting without turning off the power, press a button other than **POWER**, or else wait until the confirmation message disappears.



- The projector cannot be turned on while the lamp is cooling down.
- After turning off the projector, wait at least 5 minutes before turning it on again. It may shorten the lamp life if you turn on the projector immediately after turning it off.
- Using the projector for extended periods may shorten the life of the lamp and internal optical components.
- Unplug the projector if it will not be used for an extended period.

# Convenient Features

This section describes features convenient during presentations and in other situations.

## Temporarily Blacking Out an Image

Projection can be temporarily blanked after a presentation, or to divert the audience's attention away from the screen.



Press the **BLANK** button to black out the image.  
Press the **BLANK** button again to show the image.

- You can set the screen state while blanking out the image in the menu. (P109)
- The lamp remains illuminated while the image is blanked out.

## Freezing the Picture

Projection can be temporarily frozen during computer operations that would be distracting, or to pause playback of video or animation.



Press the **FREEZE** button to freeze the moving image. The projector shows the following icon.  
Press the **FREEZE** button again to return to the original display.

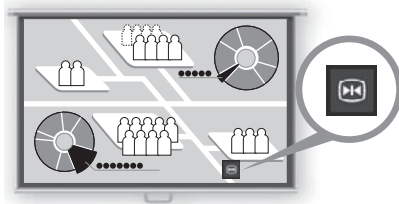

Screen

- It is also cancelled when the input signal is terminated.

## Projecting a Test Pattern from the Menu

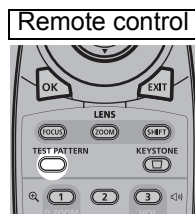

Even without any input signals, the projector can project a test pattern. Test patterns can be projected during installation to check how the projector is installed.

To project a test pattern, press the **TEST PATTERN** button on the remote control.

To stop test pattern projection, press the **TEST PATTERN** button again.

For details on projecting test patterns, see “Install settings” (P97) or “Displayed Test Patterns” (P168).



## Specifying Power-Saving Settings

Set power-saving settings as needed.

The following four settings are available. For details, refer to the page describing each function.

- **Lamp mode (P96)**  
Adjust lamp and fan power consumption in the image mode.
- **Power management mode (P114)**  
Automatically turns off the lamp or the power after a certain period if the projector is idle without an input signal.
- **Power management duration (P114)**  
Specify the period after which the lamp or the projector should go off automatically if left idle without an input signal when [Power management mode] is set to [Lamp off] or [Standby].
- **Network standby settings (P125)**  
Conserves energy in standby mode.



# Advanced Guide

Safety Instructions

Before Use

Installation Procedure

Connection Procedure

Projection Procedure

Convenient Features

Using Menus

Menu Settings

Advanced Projection

Maintenance

Product Specifications

Troubleshooting

Basic Guide

Advanced Guide

Other Information

# Using Menus

Use the menus to set the operation of the projector in detail.

## Menu Configuration

The menu screen is divided into 6 tabs as shown below.

 **[Input settings] tab (P87)**  
You can set the type of signal or the method of projection of the images input.

 **[Image adjustment] tab (P90)**  
You can adjust the image quality and colors according to your preference.

 **[Install settings] tab (P97)**  
This setting is used when installing the projector.

 **[System settings] tab (P108)**  
You can set the operation of the projector.

 **[Network settings] tab (P123)**  
These settings are for when using the projector from a PC via a network.  
For the network settings, refer to “Network settings” (P122).

 **[Information] tab (P148)**  
You can check information about the signal types of the images projected and other information.

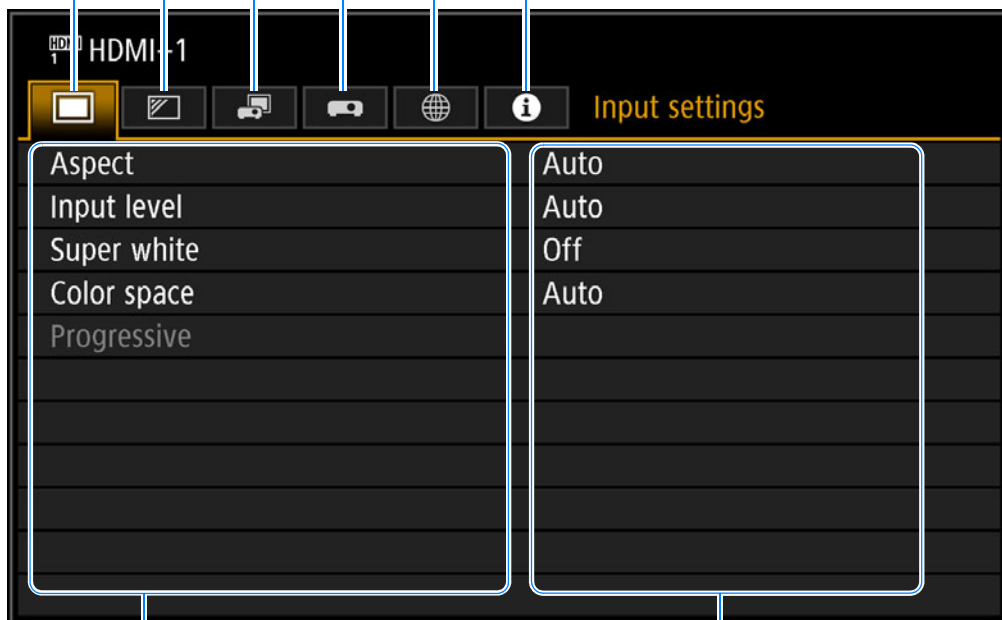

Contents of menu

Menu items

# Basic Menu Operations

- 1** Press the MENU button to display the menu window.

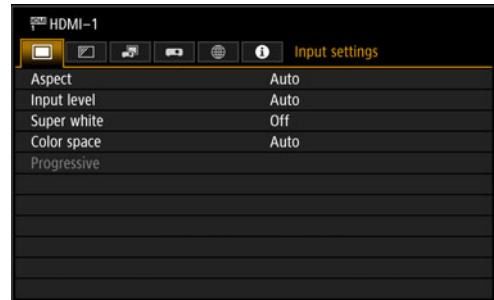
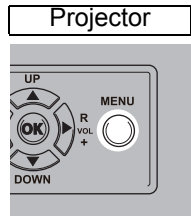

- 2** Press the [◀] / [▶] buttons to select a tab.

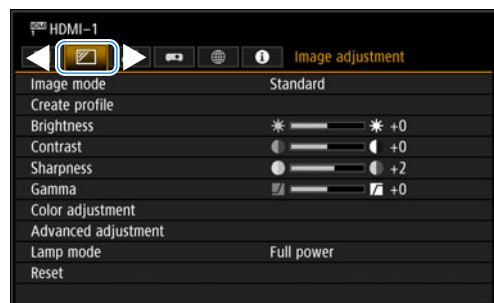
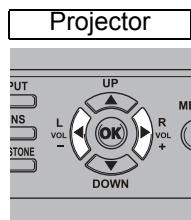
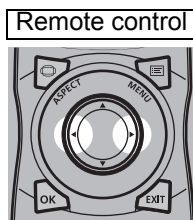

- If the tab position is not highlighted in orange, press the [▲] / [▼] buttons to move the current selection to the top.

- 3** Press the [▲] / [▼] buttons to select an item.

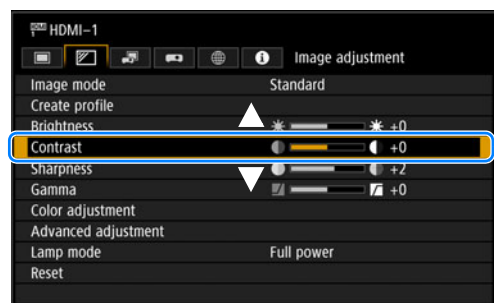
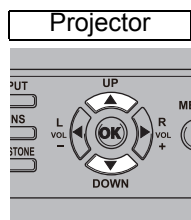
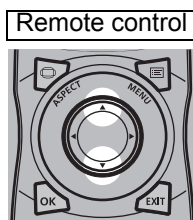

- 4** Select contents.

How to select the contents varies depending on the item.

## Selecting from a list Example: Aspect (P88)

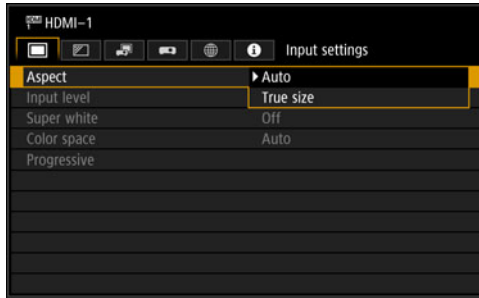

1. Select [Aspect].
2. Press the **OK** button or [▶] button to display a list of the contents.
3. Use the [▲] / [▼] buttons to select the desired contents.
4. When you have found the contents you desired, press the **OK** button or [▶].

## Adjusting with the [◀] / [▶] buttons Example: Contrast (P92)

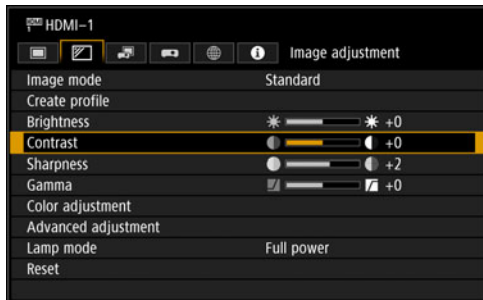

1. Select [Contrast].
2. Use the [◀] / [▶] buttons to adjust the setting.

## Selecting from a different screen (1) Example: Register network password (P124)



1. Select [Register network password]. A different screen is displayed.
2. Use the [▲] / [▶] / [▼] / [◀] buttons or number buttons on the remote control to enter the projector network password.

## Selecting from a different screen (2) Example: Random noise reduction (P94)

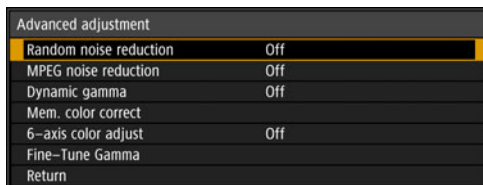

1. Select [Advanced adjustment].
2. Press the **OK** button to display a different screen.
3. Select [Random noise reduction].
4. Use the [▲] / [▼] buttons to select the setting.
5. When you have completed the settings, press the **OK** button.

- 5 Pressing the **MENU** button causes the menu screen to disappear. The menu screen will also disappear if the **EXIT** button is pressed.

# Menu Settings

## Input settings

This section describes settings for aspect ratio, etc.

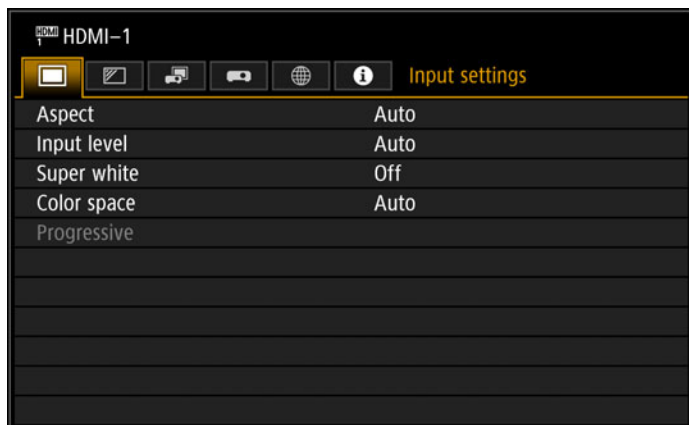

(When the input signal is HDMI-1)

Menu	Function	Details
Aspect	Select an image aspect ratio.	<a href="#">P88</a>
Input level	Select the input level for HDMI signal.	<a href="#">P88</a>
Super white	Select super white mode compatibility for HDMI signals.	<a href="#">P88</a>
Color space	Select the color space for HDMI signal.	<a href="#">P89</a>
Progressive	Select progressive processing for still images in cinematic content or moving images in videos.	<a href="#">P89</a>

Menus that are not available are grayed out or hidden.

### Aspect



> [Input settings] > **[Aspect]**

Select a projection aspect ratio for images.

Option	Function
Auto	An image is projected at the aspect ratio of the input signal.
True size	The image is projected with the original resolution of the input signal.

Menus that are not available are hidden.



The **ASPECT** button on the remote control can also be used to select the [Aspect] settings.

### Input level



> [Input settings] > **[Input level]**

Adjust the input level for content projected via HDMI.

Option	Function
Auto	Automatically switches the input level based on the input signal.
Normal	Limits the input level to 16 - 235.
Expanded	Enables a full input level of 0 - 255.



- This setting is only available with RGB HDMI signals.
- In [Auto] mode, the signal level is selected automatically. (Some equipment may not support this.)
- If HDMI output can be set to [Normal] or [Expanded], we recommend [Expanded]. The contrast of images will be improved and dark scenes will be rendered more realistically. In this case, set [Input Level] to [Auto] or [Expanded].  
For more detailed information, refer to the user's manual for the AV equipment connected to the projector.

### Super white



> [Input settings] > **[Super white]**

Select to project white signals in HDMI input that are in a range of 16-235 at 100%-109% brightness (235-255).

Option	Function
Off	Disable super white. Project white signals with an input level of 235 at 100% brightness. All white signals with an input value exceeding 235 are also projected at 100% brightness.
On	Convert input signals in a range of 16-235 so that an input level of 255 is projected as white 109% at 100% brightness.



- Super white has no effect when [Input level] is set to [Expanded].
- Switch this setting to [Off] if projection looks distorted or unnatural when it is [On].
- Setting this option to [On] will darken the overall image.



## Color space



> [Input settings] > **[Color space]**

Select the color space for HDMI signal.

Option	Function
Auto	Selects the optimal color format for input signals.
RGB	Forces the projector to handle the input signal as an RGB signal.
YCbCr	Forces the projector to handle the input signal as a color difference signal.

## Progressive



> [Input settings] > **[Progressive]**

Performs progressive processing optimized for still images in cinematic content or moving images in videos, when interlaced HDMI signals (1080i, 1035i, 576i, or 480i) are supplied.

Option	Function
Off	Does not perform progressive processing.
Film/auto	Suitable for still images or typical moving images. Performs progressive processing for video or cinematic content.
Video 1	Suitable for projecting video with high image quality and relatively slow movement. Performs progressive processing optimized for HD video.
Video 2	Suitable for projecting video with faster movement. Performs progressive processing optimized for fast-moving video.
25p/30p (PsF)	Performs progressive processing optimized for 1080 Psf/25 or 1080 Psf/30 video (25 or 30 fps, respectively).



Select [Off] when flickers and horizontal lines are noticeable in media that has a lot of fast-moving action.

## Image adjustment

This section describes image quality settings such as brightness, contrast, and sharpness.

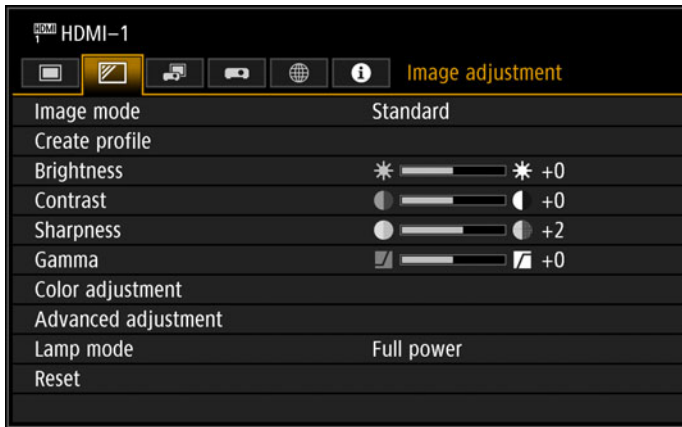

(When the input signal is HDMI-1)

Menu	Function	Details
Image mode *	Select overall image quality to suit the projected image.	<a href="#">P91</a>
Create profile	Save desired image quality settings as profiles.	<a href="#">P92</a>
Baseline image mode	Shows the image mode that is basis of the profile.	<a href="#">P92</a>
Brightness *	Adjust image brightness.	<a href="#">P92</a>
Contrast *	Adjust image contrast.	<a href="#">P92</a>
Sharpness *	Adjust image sharpness.	<a href="#">P92</a>
Gamma *	Correct loss of detail in shadows or highlights.	<a href="#">P92</a>
Color adjustment *	Fine-tune image colors.	<a href="#">P93</a>
Advanced adjustment *	Fine-tune noise reduction and color tone.	<a href="#">P93</a>
Lamp mode *	Select the lamp brightness.	<a href="#">P96</a>
Reset	Restore the current image quality settings to defaults.	<a href="#">P96</a>

Menus that are not available are grayed out or hidden.

\* Adjustments are stored as modified settings for the current input signal and image mode.

## Image mode

 > [Image adjustment] > **[Image mode]**

Select the overall image quality for projected images. Can also be selected by pressing the **IMAGE** button on the remote control.

Option	Function		
	Room Brightness	Types of Images	Good For
Standard	Bright	Computer screens, or media played with video software	Whites and natural colors
Presentation	Bright	Images mainly consisting of text	Keeps the screen bright
Dynamic	Bright	Video content	Keeps the screen bright
Video	Somewhat dark	Video from camcorders	Close to the color space of TVs
Photo/sRGB	Somewhat dark	Digital photos from sRGB-compatible cameras	Conforms to the sRGB standard
DICOM SIM	Adjust gamma to suit the surrounding brightness.	Medical or other monochrome images	Conforms to gamma values used for medical images * Conforms to DICOM Standard Part 14. However, the projector cannot be used in diagnosis or similar applications.
User 1 - 3	Up to 3 user profiles can be stored for your selected image quality settings (P92). Stored profiles are available in this setting as an image mode.		

Menus that are not available are grayed out or hidden.



- You can adjust the image quality by adjusting the following items in each image mode: [Brightness], [Contrast], [Sharpness], [Gamma], [Color adjustment], [Advanced adjustment], and [Lamp mode]
- If flickering occurs in Presentation mode, try switching to sRGB or Standard mode.

### Create profile

 > [Image adjustment] > **[Create profile]**

Save desired image quality settings in up to 3 user profiles.



- The saved settings consist of the brightness, contrast, sharpness, gamma, color adjustment, advanced adjustment, and lamp mode.
- Although only 3 user profiles are displayed, separate profiles apply depending on whether DVI-D or HDMI signals are supplied. As a result, it is possible to save up to 6 settings.
- The image mode name which was the basis for the settings change is also saved in the user memory. When a user memory is selected as the image mode, the image mode that was the base for that user memory is displayed in the menu as [Baseline image mode].

### Brightness

 > [Image adjustment] > **[Brightness]**

Adjust image brightness.

### Contrast

 > [Image adjustment] > **[Contrast]**

Sharpen or soften image contrast.

### Sharpness

 > [Image adjustment] > **[Sharpness]**

Adjust image sharpness.

### Gamma

 > [Image adjustment] > **[Gamma]**

Correct image areas that are too dark or too bright to see clearly.



For more detailed adjustment, use Fine-Tune Gamma ([P96](#)).

## Color adjustment

 > [Image adjustment] > **[Color adjustment]**

Adjust color-related settings such as color level, color balance, and color temperature.



(In image modes other than DICOM SIM.)

Submenu	Function
Color level	Adjusts the intensity of colors.
Color balance	Adjusts the color balance of a purplish or greenish image.
Color temperature	Adjusts the white color temperature.
R / G / B Gain	Adjust the gain of each color.
R / G / B Offset	Adjusts the color offset of each color.



In [DICOM SIM] image mode, [Color temperature] is not adjusted with numeric values but set to one of the following five presets.

Preset 1: Adjust brightness relative to DICOM Standard Part 14.

Preset 2: Adjust color tone relative to DICOM Standard Part 14.

Preset 3: Adjust color to conform to DICOM Standard Part 14.

Preset 4 (Clear Base): Adjust color to suit the color of X-ray film.

Preset 5 (Blue Base): Adjust color to suit the color of X-ray film.

## Advanced adjustment

 > [Image adjustment] > **[Advanced adjustment]**

Fine-tune noise reduction and color tone.

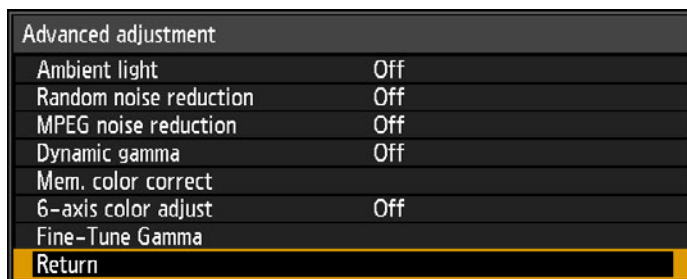

## Ambient light

Minimize the effect of ambient light on the screen.

Submenu	Function	
Off	Projects an image with no correction.	
Adjust	Type	<b>Tungsten</b> For ambient light from conventional light bulbs or fluorescent light of this color.
		<b>Fluorescent</b> For ambient light from a “day white” fluorescent source.
	Level	<b>L</b> For an ordinary brightness of ambient light.
		<b>H</b> For bright ambient light.

### Examples of Ambient Light Level Settings

Level	Example Location
<b>L</b>	Projection room, sports bar, etc.
<b>H</b>	Conference room, lecture room, etc.



The [Ambient light] setting is available in [Photo/sRGB] image mode.

## Random noise reduction

Reduce random image noise\*.

\* Effective on noise with an irregular frequency or amplitude.

Option	Function
Off	Disables random noise reduction.
Weak	Specify one of three levels of intensity of the random noise reduction.
Middle	
Strong	



Select [Weak] for fast-moving images or [Strong] for slow-moving images.

## MPEG noise reduction

Reduce MPEG image noise.

Option	Function
Off	Disables MPEG noise reduction.
Weak	Specify one of three levels of intensity of the MPEG noise reduction.
Middle	
Strong	

### Dynamic gamma

You can adjust the gradation representation of light and dark portions of an image automatically.

Option	Function
Off	Disable dynamic gamma adjustment.
Weak	Specify one of three levels of dynamic gamma adjustment.
Middle	
Strong	

### Mem. color correct (Flesh/Sky/Green)

Enhances skin tones, blue skies, and greens, so that these colors are more consistent with people's remembered impressions.

Option	Function
Off	Disable correction.
Weak	Specify the level of correction.
Middle	
Strong	

### 6-axis color adjust

Fine-tune RGB (red, green, blue) and CMY (cyan, magenta, yellow) hues in images.

Submenu	Function
Off	Disables 6-axis color adjustment.

Adjust

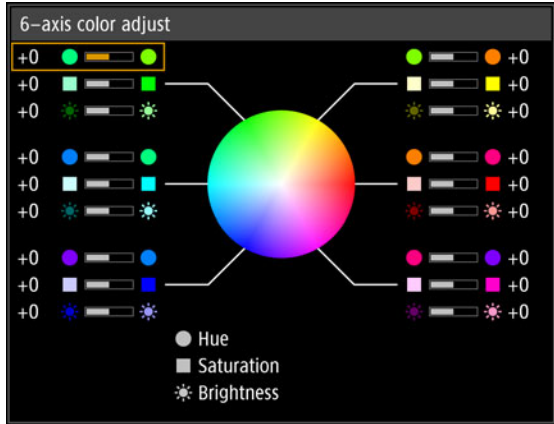

Use the [▲] / [▼] buttons to select [○ Hue], [□ Saturation], or [★ Brightness], and use the [◀] / [▶] buttons for adjustment.

Reset	Returns all adjustment values to zero.
-------	--

## Fine-Tune Gamma

Adjust white, red, green, and blue gamma curves. Red, green, and blue can be adjusted separately. Adjustments to white are also applied to the three other colors. Note that adjusting any color will overwrite previous adjustments.

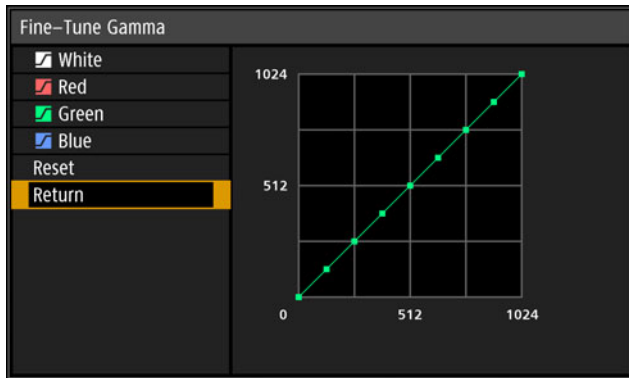

- [Fine-Tune Gamma] is available in image modes other than [DICOM SIM] (Optimal image mode: [Photo/sRGB]).
- For details on gamma correction, see [page 92](#).
- Use input signals or a test pattern for adjustment.



Image resolution may seem lower when [Random noise reduction] or [MPEG noise reduction] is applied.

## Lamp mode



> [Image adjustment] > **[Lamp mode]**

Reducing the lamp brightness reduces power consumption and cooling fan noise.

Option	Function
Full power	Projects images at full brightness.
Power saver	Reduces lamp brightness to save energy.

## Reset



> [Image adjustment] > **[Reset]**

Restore the current image quality settings to defaults.

Option	Function
OK	Resets the image adjustment settings.
Cancel	Cancels resetting of the image adjustment settings.



- Performing reset when [Image mode] is set to a profile from [User 1] to [User 3] will restore the settings originally saved for that user profile.
- Only the setting for the combination of input signal and image mode for the current projection is reset.



## Install settings

Adjust projection to suit the screen or the type of images, or how the projector is installed.

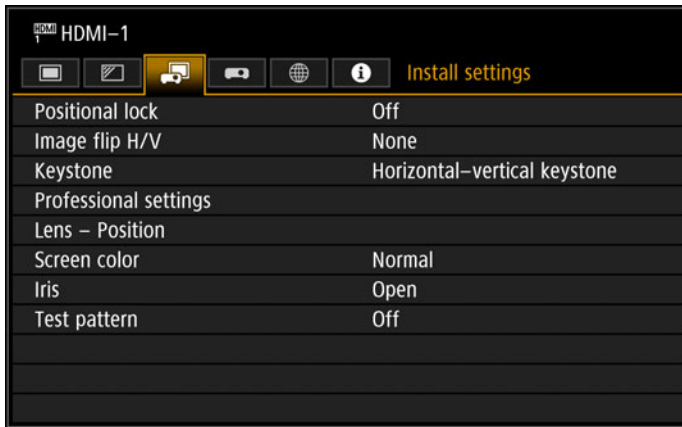

(When the input signal is HDMI-1)

Menu	Function	Details
Positional lock	Operation of installation related functions can be prohibited.	<a href="#">P98</a>
Image flip H/V	Specify settings for projection from behind the screen, from the ceiling, or both.	<a href="#">P98</a>
Keystone	Set the type of keystone correction.	<a href="#">P98</a>
Professional settings	Specify advanced installation settings.	<a href="#">P99</a>
Lens - Position	Store information about the lens position (including focus, zoom, and lens shift settings), which can be used to restore the lens to these positions.	<a href="#">P106</a>
Screen color	Adjust projection colors to suit the screen color.	<a href="#">P106</a>
Iris	Reduce the difference in brightness among models when multiple projectors are used together, by adjusting the lens aperture.	<a href="#">P107</a>
Test pattern	Project a test pattern to check the resolution and color of projection during installation.	<a href="#">P107</a>

## Positional lock

 > [Install settings] > **[Positional lock]**

Operation of installation-related functions can be prohibited.

- Image flip H/V • Keystone • Professional settings • Lens - Position (Save position, Lens shift reset)

Option	Function
Off	The positional lock is not used.
On	Prevents adjustment of installation-related functions.

## Image flip H/V

 > [Install settings] > **[Image flip H/V]**

Specify the orientation of how the projector is installed.

Option	Function
None	Select for normal projection, without inversion.
Ceiling mounted	Select when the projector is installed upside-down on the ceiling. The projected image is inverted in the vertical direction.
Rear	Select this to project an image from behind the screen. The projected image is inverted in the horizontal direction.
Rear, Ceiling mounted	Select when the projector is installed upside-down on the ceiling and behind the screen. The projected image is inverted in both vertical and horizontal directions.



- To hang the projector from the ceiling, use the optional bracket. Contact the Canon Customer Support Center for more detailed information.
- Image flipping will reset any adjustment for keystone distortion. In this case, redo the adjustment.
- Adjusting the [Image flip H/V] setting does not alter button assignments in the projector's side controls.

## Keystone

 > [Install settings] > **[Keystone]**

Two types of keystone correction are available: horizontal/vertical keystone and corner adjustment. Keystone correction can also be reset. Keystone correction can also be applied by pressing the **KEYSTONE** button.

Option	Function
Horizontal-vertical keystone	Apply horizontal-vertical keystone correction. Image height and length is adjusted.
Corner adjustment	Apply corner adjustment. Each corner of the image can be repositioned.
Reset	Resets the specified keystone value.

## Professional settings

 > [Install settings] > [Professional settings]

Specify advanced installation settings.

Professional settings	
Panel drive mode	4096x2160
Multi input mode select	
DVI optimizer	
RGB alignment	
High altitude	Off
Vertical projection	Off
Fan speed setting	Normal
Marginal focus	Off
Edge blending	Off
Return	

### Panel drive mode

Select the LCD panel vertical resolution to use.

Option	Function
4096x2160	Use a resolution of 4096 x 2160 lines.
4096x2400	Use a resolution of 4096 x 2400 lines. Select this option only when a signal with a resolution of 4096 x 2400 is supplied.



- Changing the panel drive mode resets the following values.
  - Horizontal-vertical keystone
  - Corner adjustment
- Adjustment values stored for edge blending vary depending on the panel drive mode.

### Multi input mode select

Select how to combine four DVI inputs or two HDMI inputs to form an image.

Submenu	Function	
DVI input mode	Normal	For use with [Single], [DVI 1x2], [DVI 2x2], or [DVI 1x4] DVI input.
	Single	For use with one DVI input signal (one connection).
	DVI 1x2	For use with two DVI input signals.
	DVI 2x2	For use with four DVI input signals projected in a 2x2 layout.
	DVI 1x4	For use with four DVI input signals projected side by side.
HDMI input mode	Normal	For use with [Single] or [HDMI 1x2] HDMI input.
	Single	For use with one HDMI input signal (one connection).
	HDMI 1x2	For use with two HDMI input signals.



Colors may appear distorted when images are viewed from the side on some screens with [DVI 1x4] or [HDMI 1x2]. For best results, use a matte screen with a wide viewing angle.

## DVI optimizer

Optimizes images from DVI signals.

Submenu	Function
DVI dual link auto setting	<b>On</b> Automatically determine whether DVI terminals are used in single- or dual-link mode and switch settings accordingly.
	<b>Off</b> Disable automatic determination of single- or dual-link mode from DVI terminals, and project images in single-link mode.
DVI-1 equalizer setting	Adjust the equalizer value for DVI terminals. Choose lower values for higher amplification, or higher values for lower amplification. Example of equalizer settings <ul style="list-style-type: none"> <li>• Decrease values to amplify signals that have been attenuated by a long cable.</li> <li>• Signals may be too strong if noise occurs when using a short cable, or when using an active cable, signal corrector, or repeater. If so, increase values to attenuate and correct the signals.</li> </ul>
DVI-2 equalizer setting	
DVI-3 equalizer setting	
DVI-4 equalizer setting	



- When a dual-link cable is used, any noise in the signal line may prevent normal projection. If this occurs, set [DVI dual link auto setting] to [Off].
- In some cases when DVI terminals are used, the cable may not be a good match for the projector, which may cause video noise or prevent the signal from being detected. If this occurs, adjust values in each setting from [DVI-1 equalizer setting] to [DVI-4 equalizer setting].

## RGB alignment

Correct color misalignment.

Submenu	Function									
Registration	Color misalignment affecting the entire image can be corrected by moving red, green, or blue components into position, in 1-pixel increments.									
Advanced registration	<p>Precise correction of red, green, or blue misalignment in different areas of the screen is possible by color and area. For detailed instructions, refer to “Advanced Registration to Adjust Projected Images” (P153).</p> <p>[Off]            Disable local correction of color misalignment. [Adjust]        Display a menu for local correction of color misalignment.</p> <div data-bbox="400 556 1089 726" data-label="Image"> </div> <table border="1"> <thead> <tr> <th>Submenu</th> <th>Function</th> </tr> </thead> <tbody> <tr> <td rowspan="2">5-point adjustment</td> <td><b>Off</b>      Disable adjustment.</td> </tr> <tr> <td><b>Adjust</b>    Enter 5-point adjustment mode (in screen corners and at the center).</td> </tr> <tr> <td>Manual adjustment</td> <td>Precise adjustment based on 54 points (in a 6 x 9 grid).</td> </tr> <tr> <td>Reset</td> <td>Restore the original position, before adjustment.</td> </tr> </tbody> </table> <p> With advanced registration, checkered or halftone image areas may be affected by uneven colors or image artifacts.</p>	Submenu	Function	5-point adjustment	<b>Off</b> Disable adjustment.	<b>Adjust</b> Enter 5-point adjustment mode (in screen corners and at the center).	Manual adjustment	Precise adjustment based on 54 points (in a 6 x 9 grid).	Reset	Restore the original position, before adjustment.
Submenu	Function									
5-point adjustment	<b>Off</b> Disable adjustment.									
	<b>Adjust</b> Enter 5-point adjustment mode (in screen corners and at the center).									
Manual adjustment	Precise adjustment based on 54 points (in a 6 x 9 grid).									
Reset	Restore the original position, before adjustment.									

-  [Registration] and [Advanced registration] settings are retained even if you change the panel drive mode.
- 5-point adjustment enables basic correction of color misalignment across the screen, by moving adjustment points in the center and each corner. To correct registration only in certain areas, try manual adjustment.
- Any values you set in 5-point adjustment are retained if you subsequently perform manual adjustment. For more precise correction after 5-point adjustment, perform manual adjustment.
- Any manual adjustment values you set before switching to 5-point adjustment are cleared.

### High altitude

Switch the fan mode to suit installation at low or high altitudes (above 2,300 m [7,545.8 ft.]).

Option	Function
Off	Setting for altitudes lower than 2,300 m (7,545.8 ft.).
On	Setting for altitudes of 2,300 m (7,545.8 ft.) or higher.



Incorrect settings may shorten the useful life of the lamp or other parts.

### Vertical projection

You can ensure adequate cooling by switching the fan mode to suit upward- or downward-facing installations.

Option	Function
Off	Does not alter the fan mode.
Upward	Setting for use when the projector faces upward.
Downward	Setting for downward projection.



- Be sure to perform this setting to use vertical projection.
- Projecting vertically without using this setting will shorten the useful life of the lamp and other parts.
- Even if you complete this setting, vertical projection will result in a shorter useful life of the lamp and other parts than horizontal projection.

### Fan speed setting

To ensure that optical parts last as long as possible, you can increase the fan speed.

Option	Function
Normal	Sets the fan to a slower speed. Use when quiet operation is required.
High speed	Increases the fan speed, for a relatively longer useful life of optical parts. Although the fan will be louder, use this setting if the useful life of optical parts is most important.

### Marginal focus

In dome projection, image focus can be adjusted on the edges of the screen, and the remote control can be used to activate and deactivate this focus adjustment. For detailed instructions, refer to “Adjusting Peripheral Focus” (P157).

Option	Function
Off	Disable remote focusing of image edges.
On	Enable remote focusing of image edges. To access the adjustment window, press the <b>LENS</b> button on the projector repeatedly or press the <b>FOCUS</b> button on the remote control.
Reset	Restore edge focusing to the standard position.



Setting this function to [Off] only prevents display of the adjustment window. Adjustment values are still retained. Use this setting to prevent remote focusing of image edges.

## Edge blending

Brightness and colors of overlapping edges of images from multiple projectors, which form a blending area, can be adjusted for a more seamless appearance. For detailed instructions, see “Projecting from Multiple Projectors at Once (Edge Blending)” (P149).

[Off] Disable blending.

[Adjust] Display the menu for blending area adjustment.

Edge blending		
Side	Width	Start position
Left	0	0
Right	0	0
Top	0	0
Bottom	0	0
Color blending adjustment		
	Off	
Black level adjustment		
	Off	
Marker		
	Off	
Reset		
Return		

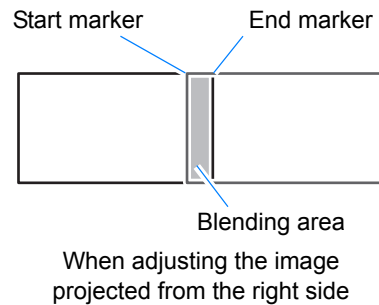

⚠ Adjustment may not eliminate different colors or brightnesses in the blending area.



For best edge-blending results, use all projectors in the same image mode (Optimal image mode: [Photo/sRGB].) and make the following adjustments.

- (1) Brightness, contrast, R/G/B gain, R/G/B offset, black level, color blending, color temperature, color level, color balance, sharpness, gamma
- (2) Color adjustment, by using 6-axis color adjustment
- (3) Gamma adjustment, by fine-tuning gamma
- (4) Corner adjustment, using keystone correction

## Menu Settings

Submenu	Function	
Side	<b>Submenu</b>	<b>Function</b>
	Left	Select the direction of the blending area to adjust.
	Right	
	Top	
	Bottom	
	Width	Specify the width between the start and end markers.
Start position	Moves the position of the start marker. <ul style="list-style-type: none"> <li>• Large blending areas may cover input signal dialog boxes and other interface elements. In this case, momentarily set edge blending to [Off] and check the display.</li> <li>• Although the starting marker is normally aligned with the image edge, it can also be aligned toward the center of the image. In this case, the black blending area will lie outside of the starting marker.</li> </ul>	
Color blending adjustment	Adjust unwanted colors or discrepancies between colors in the blending area.	
	<b>Submenu</b>	<b>Function</b>
	Off	Do not adjust colors of blended images.
	Adjust	Adjust unwanted colors or discrepancies between colors in the blending area.
<b>Option</b>		<b>Function</b>
White		Simultaneously adjust red, green, and blue to correct unwanted colors or discrepancies in the blending area.
Red/Green/Blue	Individually adjust red, green, and blue to correct unwanted colors or discrepancies in the blending area.	



Submenu	Function						
Black level adjustment	<p>Because black is lighter in the blending area than in other areas, you can adjust the black level outside the blending area to make this difference in brightness less noticeable.</p> <p>Area A: Black level cannot be adjusted.                      Area B: Adjust to a black level different from that of area D.                      Area C: Adjust to provide a smooth transition relative to the black levels of areas B and D.</p>						
	<p><b>Off</b> Do not adjust the black level.</p>						
	<p><b>Area</b> Adjust areas C - A to smoothen the boundaries of the blending area.</p> <table border="1"> <thead> <tr> <th>Submenu</th> <th>Function</th> </tr> </thead> <tbody> <tr> <td><b>Side</b></td> <td>Select the direction to adjust from Left/Right/Top/Bottom.</td> </tr> <tr> <td><b>A-Width/ B-Width/ C-Width</b></td> <td>Adjust the widths of areas A - C.</td> </tr> </tbody> </table>	Submenu	Function	<b>Side</b>	Select the direction to adjust from Left/Right/Top/Bottom.	<b>A-Width/ B-Width/ C-Width</b>	Adjust the widths of areas A - C.
	Submenu	Function					
<b>Side</b>	Select the direction to adjust from Left/Right/Top/Bottom.						
<b>A-Width/ B-Width/ C-Width</b>	Adjust the widths of areas A - C.						
<p><b>Black level</b> Adjust the black level brightness and color of areas B and D.</p> <table border="1"> <thead> <tr> <th>Submenu</th> <th>Function</th> </tr> </thead> <tbody> <tr> <td><b>B/D-area base</b></td> <td>Adjust the black level brightness of B/D areas.</td> </tr> <tr> <td><b>B/D-area red / green / blue</b></td> <td>Adjust the red, green, and blue components of B/D area black levels individually.</td> </tr> </tbody> </table> <p> Adjustment values are restored even if the dialog box is no longer displayed after you select [Adjust] again after setting [Black level adjustment] to [Off].</p>	Submenu	Function	<b>B/D-area base</b>	Adjust the black level brightness of B/D areas.	<b>B/D-area red / green / blue</b>	Adjust the red, green, and blue components of B/D area black levels individually.	
Submenu	Function						
<b>B/D-area base</b>	Adjust the black level brightness of B/D areas.						
<b>B/D-area red / green / blue</b>	Adjust the red, green, and blue components of B/D area black levels individually.						
Marker	<p>Show the blending area markers.</p> <table border="1"> <thead> <tr> <th>Option</th> <th>Function</th> </tr> </thead> <tbody> <tr> <td>Off</td> <td>Hide the blending area markers.</td> </tr> <tr> <td>On</td> <td>Show the blending area markers. The start marker is red, and the end marker is green.</td> </tr> </tbody> </table>	Option	Function	Off	Hide the blending area markers.	On	Show the blending area markers. The start marker is red, and the end marker is green.
	Option	Function					
	Off	Hide the blending area markers.					
On	Show the blending area markers. The start marker is red, and the end marker is green.						
Reset	Reset the marker settings.						

## Lens - Position



> [Install settings] > **[Lens - Position]**

The projector can store information about the lens position. Up to three sets of lens information (including, focus, zoom, and lens shift settings) can be saved, and the lens can be restored to these positions as needed.

Submenu	Function
Load position 1-3	Restores the lens to the positions saved using [Save position 1] - [Save position 3].
Save position 1-3	Saves the lens position as one of the available positions (1-3).
Lens shift reset	Restores the lens to the original position.



- When saved lens positions are restored, images may be slightly misaligned, relative to the saved position.
- Specifying a somewhat smaller image size than the screen size (image area) enables you to switch among multiple lens positions without the image extending off the screen.
- When precise positioning is needed, use lens shift, zoom, and focus functions to fine-tune the position.



- [Save position] and [Lens shift reset] are not available when [Positional lock] is set to [On] (P98).
- [Load position] is grayed out and not available unless positions have been stored to a [Save position].
- The following setting values are stored: focus, zoom, lens shift, keystone, corner adjustment, and screen color.

## Screen color



> [Install settings] > **[Screen color]**

You can adjust the color quality of the images projected according to the color of the projection screen.

Submenu	Function
Normal	Select this if a standard type of projection screen is used. The images are projected in a light quality similar to that of natural light.
Greenboard	Select if a dark green surface such as a blackboard is used as the screen. The color quality similar to [Normal] is obtained on the greenboard.
Adjust	Select to fine-tune red, green and blue.

## Iris

 > [Install settings] > **[Iris]**

The difference in brightness among models can be reduced when multiple projectors are used together, by adjusting the lens aperture.

Submenu	Function
Open	Disables aperture adjustment.
Close 1-3	Specify the aperture value in a range of 1-3.



The [Iris] setting does not affect power consumption.

## Test pattern

 > [Install settings] > **[Test pattern]**

You can project a test pattern ([P168](#)) to check resolution, color, and other details even without supplying an input signal. Also available by pressing the **TEST PATTERN** button on the remote control.

Option	Function
Off	Disable test pattern display.
On	Enable test pattern display.



- While the test pattern menu is displayed, you can use the [▲] / [▼] buttons to switch patterns. Additionally, options of test pattern that have options can be changed with the [◀] / [▶] buttons.
- The test pattern menu is no longer displayed after a little while, but you can view it again by pressing the [▲] / [▼] buttons.

## System settings

Customize projector and remote control operation, beeping, and other details after startup, during standby, and in other situations.

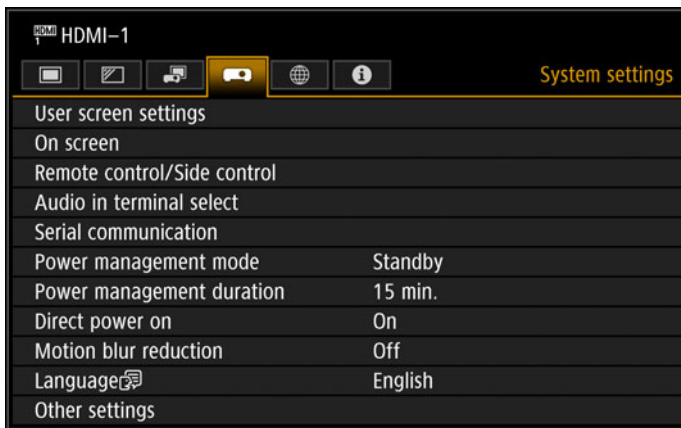

(When the input signal is HDMI-1)

Menu	Function	Details
User screen settings	Customize user screens shown at startup, when no signal is detected, and in other situations.	P109
On screen	Set the display position and whether to show or hide menus, help information, and warning or caution icons.	P110
Remote control/Side control	Specify operation with remote control or projector buttons.	P112
Audio in terminal select	Select the terminal for audio input.	P113
Serial communication	Display serial communication setting values.	P114
Power management mode	You can specify to turn off the lamp or projector automatically after a certain period if the projector and remote control are not used and there is no input signal.	P114
Power management duration	Specify how long before the lamp is turned off or the projector enters standby, depending on the [Power management mode] setting.	P114
Direct power on	You can turn on the projector by connecting the power cable without pressing the <b>POWER</b> button.	P115
Motion blur reduction	Motion blur is blurring that occurs during video playback. Motion blur reduction can make this blurring less noticeable.	P115
Language	You can select the language in which the menus are displayed.	P116
Other settings	Set a password, reset counters for lamp or air filter replacement, and access other settings and information.	P117

## User screen settings

 > [System settings] > [User screen settings]

Capture a logo and specify logo display settings.

User screen settings	
Logo capture	
Logo position	Center
No signal screen	Blue
Screen when blank	Black
Projector on	Canon logo
Return	

### Logo capture

Registers the current image as a user logo. Registered user logos can be shown when no signal is received, when the **BLANK** button is pressed, or as the startup image.

Option	Function
OK	Display the image for logo registration. Align the image with the red boundary lines indicating the portion that will be stored, and then press the <b>OK</b> button. The portion of the image within the boundary lines is now registered.
Cancel	Cancels logo registration.

### Logo position

Specify the position of registered user logos as follows.

You can specify the position after a logo has been registered. Choose from upper left, upper right, center, lower left, or lower right.

### No signal screen

Customize the screen shown when no input signals are received.

Option	Function
Black	The screen is all black.
Blue	The screen is all blue.
User logo	The user logo is projected.

### Screen when blank

Select the screen shown when projection is temporarily blanked out by pressing the **BLANK** button on the remote control.

Option	Function
Black	The screen is all black.
Blue	The screen is all blue.
User logo	The user logo is projected.

### Projector on

Select a logo to project after startup until input signals can be projected.

Option	Function
Skip	A black screen is projected.
Canon logo	Displays the Canon logo that was registered in advance at the factory.
User logo	The user logo is projected.

## On screen

 > [System settings] > **[On screen]**

Specify display details for on-screen menus, help, and warning or precaution icons.

On screen	
Menu position	Center
Menu display time	Normal
Guide	On
Show input status	On
Lamp warning display	On
Air filter warning display	On
Overheat warning display	Off
Return	

### Menu position

Reposition menu display.

Choose from upper left, upper right, center, lower left, or lower right.



Only [Center] is available when edge blending is used. Other display positions are grayed out and not available.

### Menu display time

Extend menu display from the standard 10 or 30 seconds to 3 minutes.

Option	Function
Normal	The menu is displayed for 10 or 30 seconds.
Extended	The menu is displayed for 3 minutes.

The following display times are also changed.

Item	[Normal]	[Extended]
MENU screen	30 seconds	3 minutes
- Input (P63) - Keystone adjustment (P73) - Keystone reset (P75) - Focus (P67), Zoom (P68), Lens shift (P70), Lens shift reset (P71) - Marginal focus (P102) - Aspect (P72) - Image mode (P76) - Gamma (P92) - Volume adjustment (P26, P31)	10 seconds	3 minutes



RGB alignment is shown for 3 minutes, regardless of the [Normal] or [Extended] option.

## Guide

Shows the guide screen.

Option	Function
Off	Hides the guide screen.
On	Shows the guide screen.



The guide screen is shown at the following cases.

- No input signal is detected.
- An invalid button is pressed in [BLANK] or [FREEZE] mode. (P31)
- When positional lock (P98) is set to [On] and buttons locked by this feature are pressed.

## Show input status

Specify whether signal status is shown when there is no signal or when you are completing signal settings.

Option	Function
Off	The input status is not displayed.
On	The input status is displayed.

## Lamp warning display

Specify whether to show a lamp replacement message after the lamp has been used for a specified period.

Option	Function
Off	The prepare lamp message and the lamp warning are not displayed.
On	The prepare lamp message and the lamp warning are displayed.



- When it is almost time to replace the lamp, the projector's [LAMP] indicator will flash. For details, see "LED Indicator Displays" (P28).
- Setting display to [Off] will disable both the message to prepare a replacement lamp and the warning to replace the lamp. To review the replacement timing, check the lamp counter (P118).
- Lamps that are still used after the timing for lamp replacement are more likely to rupture. Replace the lamp with a new one as soon as possible.

## Air filter warning display

A message advising you to perform cleaning can be set to display when the filter needs cleaning.

Option	Function
Off	The air filter warning is not displayed.
On	The air filter warning is displayed.



Setting [Air filter warning display] to [Off] will disable display of the warning to clean the air filter. We recommend checking the air filter counter (P119) occasionally to know when to replace the filter.

## Overheat warning display

Specify whether the icon warning of high temperature is shown when the internal temperature is high and the projector may overheat.

Option	Function
Off	Disable high temperature warning icon display.
On	Enable high temperature warning icon display.

## Remote control/Side control

 > [System settings] > **[Remote control/Side control]**

Specify which operations are available using buttons on the remote control or in the projector's side controls.

Remote control/Side control	
Beep	On
Key repeat	On
Key lock	Off
Remote control channel	Independent
Return	

### Beep

You can select whether a beep sounds or not when you operate the projector.

Option	Function
Off	Disables the beep.
On	Enables the beep.



The beep will not sound if you mute the projector sound with the **MUTE** button on the remote control.

### Key repeat

Key repeat enables projector or remote control buttons to be held down instead of pressing them repeatedly.

Option	Function
Off	Key repeat is not enabled.
On	Key repeat is enabled.

### Key lock

Lock the projector to prevent direct or remote control operation.

Option	Function
Off	Disables the key lock.
Main unit	Operation is not possible using the main unit. Use the remote control.
Remote (wireless)	Disables infrared remote control operations (P33). Use buttons on the main unit. Operation is also possible with a wired remote control.



### To Unlock Key Lock Function

Turn off the projector and unplug the power plug. Hold down the **OK** button on the main unit and plug in the power cord, as you continue to hold down the **OK** button. In a moment, a beep will sound, and the controls will be unlocked.



When you access this setting from the projector's side controls, [Main unit] is not available. Similarly, when you access the setting from the remote control, [Remote (wireless)] is not available.

### Remote control channel

Separate channels can be assigned to up to four projectors so that a single remote control can be used with each projector.

#### Selecting the Projector Channel

If a wired remote control is used, there is no need to set the remote control channel.

Option	Function
Ch1 Ch2 Ch3 Ch4	Select the remote control channel to use with this projector.
Independent	Can be controlled from a remote control set to any channel.

#### Selecting a Channel on the Remote Control

After changing the projector channel from the menu, always change the remote control channel accordingly.

Ch1	Hold down both the <b>Ch</b> button and [1] button for 3 seconds.
Ch2	Hold down both the <b>Ch</b> button and [2] button for 3 seconds.
Ch3	Hold down both the <b>Ch</b> button and [3] button for 3 seconds.
Ch4	Hold down both the <b>Ch</b> button and [4] button for 3 seconds.
Independent	Hold down both the <b>Ch</b> button and [0] button for 3 seconds.

### Audio in terminal select



> [System settings] > **[Audio in terminal select]**

Select the terminal for audio input.

Option	Function
Off	No audio is output.
Audio in	Use audio signals from AUDIO IN for audio output.
HDMI-1	Only available when the input signal is set to [HDMI-1] or [HDMI 1x2]. Audio signals from HDMI 1 are output.
HDMI-2	Only available when the input signal is set to [HDMI-2] or [HDMI 1x2]. Audio signals from HDMI 2 are output.

### Serial communication

 > [System settings] > **[Serial communication]**

You can check setting values for the service port (CONTROL) used for serial communication.

Option	Function
Stop bit	Length of mark representing the end of data bits.
Baud rate	Modulation rate, in bits per second.
Data bits	Number of bits of data.
Parity	Number of parity bits.

### Power management mode

 > [System settings] > **[Power management mode]**

You can specify to turn off the lamp or projector automatically after a certain period if the projector and remote control are not used and there is no input signal.

Option	Function
Disabled	Disable power management mode.
Lamp off	Only turns the lamp off.
Standby	Turns the projector off and puts it in standby.



- After the lamp is turned off, projection resumes when:
  - the same input signal is restored.
  - the remote control or projector is operated.
  - the power is turned on.
- After the projector enters standby, restoring projection requires the same steps as when turning the projector on normally.
- When [Disabled] is selected, [Direct power on] (P115) is not available.

### Power management duration

 > [System settings] > **[Power management duration]**

Specify how long before the lamp is turned off or the projector enters standby, depending on the [Power management mode] setting.

Option	Function
5 min. - 60 min.	After 30 seconds without an input signal when the projector is idle, the projector starts displaying a countdown of the selected time.



- If conditions that would start countdown are met while you are blanking projection, blanking is canceled.
- Once countdown begins, audio output stops.

## Direct power on



> [System settings] > **[Direct power on]**

You can turn on the projector by connecting the power cable without pressing the **POWER** button.

Option	Function
Off	The <b>POWER</b> button must be pressed to turn the projector on.
On	You can turn on the projector by connecting the power cable only.



- Before enabling direct power on, be sure to set [Power management mode] to an option other than [Disabled]. When [Disabled] is selected, [Direct power on] is not available.
- After turning off the projector, wait at least 5 minutes before turning it on again. It may shorten the lamp life if you turn on the projector immediately after turning it off.

## Motion blur reduction



> [System settings] > **[Motion blur reduction]**

Motion blur is blurring that occurs during video playback. Motion blur reduction can make this blurring less noticeable.

Option	Function
Off	Motion blur reduction is not performed.
Weak	Reduce motion blur for fast-moving images. Note that images may be slightly darker, and flickering may occur.
Strong	Reduce motion blur for images moving faster than with [Weak]. Note that images may be darker, and flickering may occur.



- If setting the projector to [Strong] or [Weak] produces distracting flickering, set it to [Off].
- [Motion blur reduction] is not available in [DICOM SIM] image mode. The menu is grayed out.

## Language

 > [System settings] > **[Language]**

Select the menu display language.

Language		
<b>English</b> English	<b>Русский</b> Russian	<b>Čeština</b> Czech
<b>Deutsch</b> German	<b>Nederlands</b> Dutch	<b>Dansk</b> Danish
<b>Français</b> French	<b>Suomi</b> Finnish	<b>إنجليزي</b> Arabic
<b>Italiano</b> Italian	<b>Norsk</b> Norwegian	<b>中文简体</b> Chinese (Simplified)
<b>Español</b> Spanish	<b>Türkçe</b> Turkish	<b>中文繁體</b> Chinese (Traditional)
<b>Português</b> Portuguese	<b>Polski</b> Polish	<b>한국어</b> Korean
<b>Svenska</b> Swedish	<b>Magyar</b> Hungarian	<b>日本語</b> Japanese

## Other settings

 > [System settings] > **[Other settings]**

Lock operation with a password, set a password, reset counters for lamp or air filter replacement, and access other settings and information.

Other settings	
Password settings	Off
Register password	
Adjust panel characteristics	
Lamp counter	
Air filter counter	
Power counter	3
Firmware	01.000000
Factory defaults	
Return	

### Password settings

Disables the projector unless the correct password is entered.

Option	Function
Off	The projector can be used even if no password is entered.
On	The projector cannot be used unless you enter your password.

#### To Cancel the Password

Cancellation on the Projector	Turn off the projector and unplug the power plug. Hold down the <b>MENU</b> button on the side control and connect the power plug. Make sure to keep holding down the <b>MENU</b> button until a beep sounds. When the projector beeps, the password is canceled. (The entered password is also reset.)
Cancellation on the Remote Control	To forcibly cancel the password from the remote control, in standby state press the <b>MENU</b> button 3 times, then press the <b>POWER</b> button.



- You cannot set [On] unless you have completed [Register password]. Once you set a password, the password entry screen appears at power-on. Enter a 4 digit password.  
Enter the password using the [▲] / [▶] / [▼] / [◀] buttons or number buttons on the remote control.  
If the password is valid, the projection starts. If you enter a wrong password three times, the power will be turned off.
- The projector also goes off after 3 minutes of inactivity on the password input screen.

## Register password

You can register a password for starting projection.

Enter a 4 digit password.

Enter the password using the pointer buttons [▲] (1) / [▶] (2) / [▼] (3) / [◀] (4) or the number buttons on the remote control.

The 4-digit password is entered from the left to right digits. When the final digit is entered, the password is automatically registered.

Press the **MENU** button to abort the registration.

## Adjust panel characteristics

Adjust projection to compensate for how long the projector has been used, the projection environment, and other factors.

Submenu	Function					
Gamma restore	Restore the original gamma if, after the projector has been used for some time, you notice that tone curves have changed, or if neutral colors have become tinted. Gamma restore can only be used when the lamp has been on for approximately 30 minutes or longer.					
	<table border="1"> <thead> <tr> <th>Submenu</th> <th>Function</th> </tr> </thead> <tbody> <tr> <td>Off</td> <td>Returns to the factory default without performing Gamma restore.</td> </tr> <tr> <td>Adjust</td> <td>Restore the original gamma and apply the result.</td> </tr> </tbody> </table>	Submenu	Function	Off	Returns to the factory default without performing Gamma restore.	Adjust
Submenu	Function					
Off	Returns to the factory default without performing Gamma restore.					
Adjust	Restore the original gamma and apply the result.					
	<ul style="list-style-type: none"> <li>Restoring gamma will restore tone curves and neutral colors as closely as possible to defaults, but original projection cannot be matched exactly.</li> <li>If Gamma restore is performed, the adjustment screen will be projected for approximately 8 minutes.</li> <li>To stop Gamma restore, press the <b>POWER</b> or <b>EXIT</b> button. Cancellation will return the setting to [Off].</li> </ul>					
Adjust panel temperature	Used when the gamma has changed in response to other changes, such as changes in ambient temperature. Compensates for changes in gradation caused by a change in LCOS panel temperature.					
	<table border="1"> <thead> <tr> <th>Submenu</th> <th>Function</th> </tr> </thead> <tbody> <tr> <td>Off</td> <td>Do not adjust the panels to suit the temperature.</td> </tr> <tr> <td>Adjust</td> <td>Adjust the panels to suit the temperature.</td> </tr> </tbody> </table>	Submenu	Function	Off	Do not adjust the panels to suit the temperature.	Adjust
Submenu	Function					
Off	Do not adjust the panels to suit the temperature.					
Adjust	Adjust the panels to suit the temperature.					

## Lamp counter

You can reset the lamp counter that indicates the time for lamp replacement.

For details on lamp counter display, see "Replacing the Lamp" (P163).

- Do not reset the lamp counter except when you have replaced the lamp. Otherwise, the lamp counter cannot indicate the correct timing for replacing the lamp.
- Lamps are more likely to rupture once the lamp replacement message has been displayed (P163). Replace the lamp with a new one as soon as possible.

## Air filter counter

This resets the counter which reminds you of the time for cleaning and replacing the air filter.

 For details on replacing or cleaning the filter, see [P160](#) - [P163](#).

## Power counter

Display the total time that the projector has been on.

 This value is not reset even if [Factory defaults] is executed.

## Firmware

Update the projector firmware.

Check the version indicated before updating the firmware.

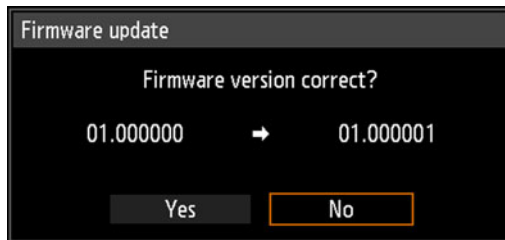

Update the projector firmware as follows.

1. Download updated firmware from the Canon website and store it at the root directory on a USB flash drive.
2. Insert the USB flash drive in the USB port.
3. Follow the instructions shown to complete the update process.

-  • Firmware versions shown here are for illustration only and differ from actual versions.
- In some cases, it may not be possible to download updates. For details, contact the Canon Customer Support Center.

 Firmware updating takes a few minutes. During the update, the LED indicator will flash in red. Do not turn off the projector while the LED is flashing. After the update, the projector will automatically turn itself off and enter standby mode.

## Factory defaults

You can reset the menu item settings and restore the system settings to the factory defaults.

Option	Function
OK	Settings are reset to default.
Cancel	Settings are not reset to default.

## Main factory defaults

### Input settings

Submenu	Default Value
Aspect	Auto
Input level	Auto
Super white	On
Color space	Auto
Progressive	Film/auto

### Image adjustment

Submenu	Default Value
Image Mode	Standard
Advanced adjustment	
Ambient light	Off
Random noise reduction	Off
MPEG noise reduction	Off
Dynamic gamma	*
Mem. color correct	*
6-axis color adjust	Off
Lamp mode	Full power

### Install settings

Submenu	Default Value
Positional lock	Off
Image flip H/V	None
Keystone	Horizontal-vertical keystone
Professional settings	
Panel drive mode	4096x2160
Multi input mode select	Normal
DVI optimizer	
DVI dual link auto setting	On
DVI equalizer setting	12
RGB alignment	
Registration	0
Advanced registration	Off
High altitude	Off
Vertical projection	Off
Fan speed setting	Normal
Marginal focus	Off
Edge blending	Off
Screen color	Normal
Iris	Open
Test pattern	Off

\* [Low] in [Dynamic] or [Video] image mode with HDMI input.



**Main factory defaults**

System settings

Submenu	Default Value
User screen settings	
Logo capture	Cancel
Logo position	Center
No signal screen	Blue
Screen when blank	Black
Projector on	Canon logo
On screen	
Menu position	Center
Menu display time	Normal
Guide	On
Show input status	On
Lamp warning display	On
Air filter warning display	On
Overheat warning display	Off
Remote control/Side control	
Beep	On
Key repeat	On
Key lock	Off
Remote control channel	Independent
Audio in terminal select	
DVI-1	Audio in
DVI-2	Audio in
DVI-3	Audio in
DVI-4	Audio in
DVI 1x2	Audio in
DVI 2x2	Audio in

Submenu	Default Value
DVI 1x4	Audio in
HDMI-1	HDMI-1
HDMI-2	HDMI-2
HDMI 1x2	HDMI-1
Power management mode	Standby
Power management duration	15 min.
Direct power on	Off
Motion blur reduction	Off
Other settings	
Password settings	Off
Adjust panel characteristics	
Gamma restore	Off
Adjust panel temperature	Off

Network settings

Submenu	Default Value
Network settings lock	Lock
Network password setting	On
Network standby settings	Low-power
Network function	Off
Detailed settings	
DHCP	Off
PJLink	On
AMX Device Discovery	Off
Crestron RoomView	Off



This function does not reset the following values.

- Selected input signal
- Remote control channel
- Lens - Position
- User profile
- Adjust panel temperature
- Lamp counter
- Network settings
- Professional settings (Registration, Advanced registration, High altitude, Vertical projection)
- Marginal focus setting value
- Power counter
- Language
- Air filter counter
- Gamma restore value

# Network settings

## Network Connection Overview

Connecting the projector to a network enables you to control the projector from a computer and receive notification of projector errors via email.

Depending on the method of network connection, preparation on the computer side may be necessary. The following is an explanation of preparation on the computer side.

## Connection Methods

To connect the projector to a computer network, use a LAN cable.

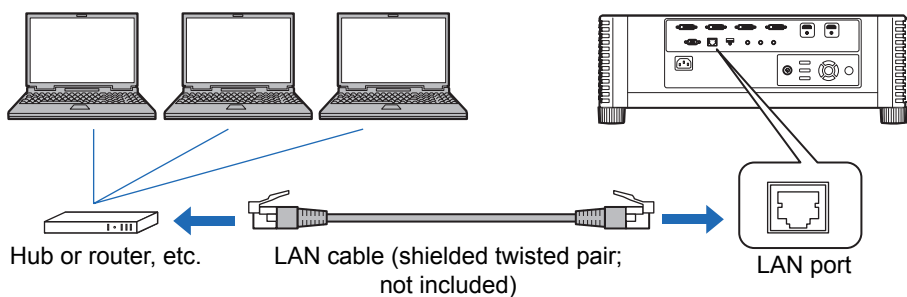

- When the [Network function] setting of the projector is set to [Off] (Network Connections is disabled), switch it to [On] to enable it. (P125)
- Referring to “Checking Projector Information” (P148), check that the projector IP address does not overlap with other computers that are on the same LAN. To set a projector IP address, follow the instructions in “Completing Computer Settings for a Network Connection” (P130) and use the web screen, or use projector TCP/IP settings. (P126)
- When you connect the computer to the network for the first time, it is also necessary to perform settings on the computer. In this case, consult the network administrator regarding the necessary settings.



In a network environment where a DHCP server is operating, choose [On] on the projector [DHCP] screen to enable the DHCP function and connect it. (P126)

## Completing Projector Settings

Settings described in this section apply to the network connections, setting a network password, and other aspects of networked projection.

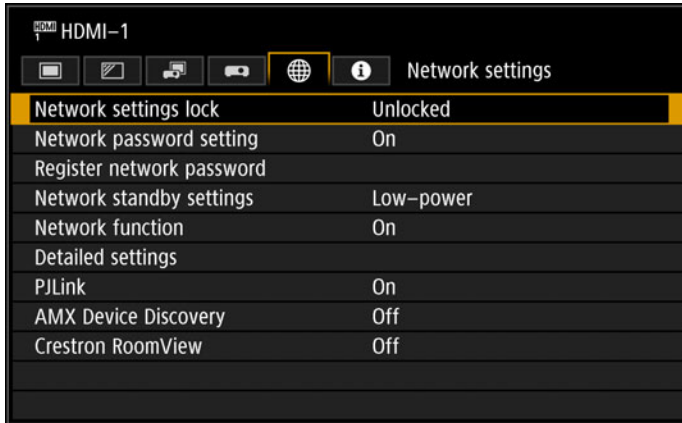

(When the input signal is HDMI-1)

Menu	Function	Details
Network settings lock	Lock network settings to prevent changes.	<a href="#">P124</a>
Network password setting	Specify whether network settings are password-protected.	<a href="#">P124</a>
Register network password	Set a network password.	<a href="#">P124</a>
Network standby settings	Specify the extent of network functionality in standby mode.	<a href="#">P125</a>
Network function	Enable or disable network functions.	<a href="#">P125</a>
Detailed settings	Display and set network connection details.	<a href="#">P126</a>
PJLink	Enable or disable PJLink.	<a href="#">P128</a>
AMX Device Discovery	Enable or disable AMX Device Discovery.	<a href="#">P129</a>
Crestron RoomView	Enable or disable Crestron RoomView.	<a href="#">P129</a>

### Network settings lock

 > [Network Settings] > **[Network settings lock]**

You can lock/unlock the network settings so that they cannot be changed.

Option	Function
Unlock	Cancels the lock and allows other network settings to be changed. The password must be entered in order to cancel the lock. Use the [▲]/[▶]/[▼]/[◀] buttons or number buttons on the remote control to enter the four-digit network password.
Lock	Lock the settings.

#### **Forcibly canceling the network lock**

Press these buttons in the following order to cancel the lock: [▲] [OK] [▶] [OK] [▼] [OK]. This operation resets the network password to [▲] [▲] [▲] [▲] ([1] [1] [1] [1]).



Setting [Network password setting] to [Off] leaves network settings unlocked.

### Network password setting

 > [Network settings] > **[Network password setting]**

You can set whether or not a password is required in order to change the projector network settings.

Option	Function
Off	A network password is not used.
On	A network password is used.

### Register network password

 > [Network settings] > **[Register network password]**

Use the [▲] / [▶] / [▼] / [◀] buttons or number buttons on the remote control to enter the projector network password.



## Network standby settings

 > [Network settings] > **[Network standby settings]**

Specify the network function operating status in standby mode as follows.

Option	Function
Normal	All network functions are available even in standby mode, including the web screen, control over the network, and PJLink.
Low-power	All network functions are available even in standby mode. However, the projector may be less responsive than usual when some functions are initially used.



- [Low-power] may delay access over the network for some functions. For faster access, select [Normal].
- Power consumption when Network function is [On] varies depending on whether Network standby settings is set to Normal or Low-power.

## Network function

 > [Network settings] > **[Network function]**

Enable or disable network function.

Specifying [Off] can save energy.



Option	Function
Off	Disable the network function.
On	Enable the network function.

## Detailed settings

 > [Network settings] > **[Detailed settings]**

View or manually change the IP address, gateway address, and other network connection settings. Available only when the network function is [On].

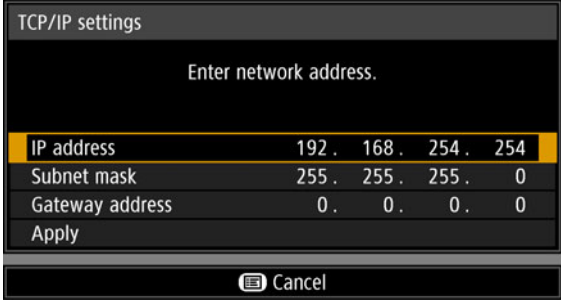
Detailed settings	
IP address	192 . 168 . 254 . 254
Gateway address	0 . 0 . 0 . 0
MAC address	00:00:00:00:00:00
DHCP	Off
TCP/IP settings	
Network setting initialization	
Return	

Menu	Function						
IP address	IP address of the projector.						
Gateway address	Gateway address of the projector.						
MAC address	MAC address of the projector.						
DHCP	<table border="1"> <thead> <tr> <th>Submenu</th> <th>Function</th> </tr> </thead> <tbody> <tr> <td>Off</td> <td>Disables the DHCP function. TCP/IP settings must be configured manually.</td> </tr> <tr> <td>On</td> <td>Enables the DHCP function. Searches the DHCP server. TCP/IP settings cannot be configured (IP address, subnet mask, and gateway address), because the IP address is acquired from the DHCP server.</td> </tr> </tbody> </table>	Submenu	Function	Off	Disables the DHCP function. TCP/IP settings must be configured manually.	On	Enables the DHCP function. Searches the DHCP server. TCP/IP settings cannot be configured (IP address, subnet mask, and gateway address), because the IP address is acquired from the DHCP server.
	Submenu	Function					
Off	Disables the DHCP function. TCP/IP settings must be configured manually.						
On	Enables the DHCP function. Searches the DHCP server. TCP/IP settings cannot be configured (IP address, subnet mask, and gateway address), because the IP address is acquired from the DHCP server.						
TCP/IP settings	<p>Change or specify the IP address, subnet mask, and gateway address used for connections.</p>  <p><b>TCP/IP settings</b></p> <p>Enter network address.</p> <p>IP address 192 . 168 . 254 . 254</p> <p>Subnet mask 255 . 255 . 255 . 0</p> <p>Gateway address 0 . 0 . 0 . 0</p> <p>Apply</p> <p> Cancel</p> <ul style="list-style-type: none"> <li>• This menu is not available (grayed out) when [DHCP] (P126) is [On].</li> <li>• If an invalid value is entered, the message “Invalid entry” appears. If this occurs, enter a valid value.</li> </ul>						

Menu	Function
Network setting initialization	<p>The following network settings are initialized.</p> <p><b>Settings configured from the projector menu</b></p> <ul style="list-style-type: none"> <li>• Network settings lock (P124)</li> <li>• Network password setting (P124)</li> <li>• Register network password (P124)</li> <li>• Network standby settings (P125)</li> <li>• Network function (P125)</li> <li>• Detailed settings (P126)</li> <li>• PJLink (P128)</li> <li>• AMX Device Discovery (P129)</li> <li>• Crestron RoomView (P129)</li> </ul> <p><b>Settings configured from the web screen</b></p> <ul style="list-style-type: none"> <li>• [Password] (P136)</li> <li>• [Network] (P137)</li> <li>• [Mail] (P138)</li> <li>• [Mail auth] (P139)</li> <li>• [SNMP] (P140)</li> <li>• [Projector info.] (P141)</li> <li>• [PJLink] (P142)</li> </ul>

### PJLink



> [Network settings] > [PJLink]

You can enable or disable the PJLink network function of the projector.

When the function is turned on, control is possible via the network using commands that meet PJLink standards.

Option	Function
Off	Disables the PJLink function.
On	Enables the PJLink function.



- The projector conforms to Class 1 as defined in PJLink standards established by the Japan Business Machine and Information System Industries Association (JBMIA). This projector supports all commands that are defined by PJLink Class 1, and has been verified as conforming to the PJLink standard Class 1 definition.
- For details on using PJLink, see “Setting PJLink [PJLink]” (P142).

#### What is PJLink?

In September 2003, the PJLink Working Group was established under the Data Projector Committee. During the first year, this PJLink Working Group standardized PJLink as a new interface specification for projectors.

PJLink is a unified standard for operation and control of projectors.

It allows centralized control of projectors and operation from a controller for all projectors regardless of manufacturer.

The objective is for JBMIA to improve convenience for users and expand the use of projectors through early systemization for network monitoring and control of projectors, which will become the mainstream in the future.

Class 1: Standardization of control and monitoring specifications for basic projector functions

Basic projector control: Power control, input selection, etc.

Acquisition of projector information and status: Power status, input selection status, error status, lamp use time, etc.

JBMIA: Japan Business Machine and Information System Industries Association.

The JBMIA is an organization which was launched in 1960 and changed its name on April 1, 2002.

PJLink website: <http://pjlink.jbmia.or.jp/english/>



PJLink is a registered trademark of JBMIA and pending trademark in some countries.

PJLink is a registered trademark, or an application has been submitted for trademark, in Japan, the United States and / or other countries or regions.



## AMX Device Discovery

 > [Network settings] > **[AMX Device Discovery]**

This setting enables other equipment compatible with AMX Device Discovery to detect the projector over a network. For networks without AMX Device Discovery, select [Off].

Option	Function
Off	Disables AMX Device Discovery.
On	Enables AMX Device Discovery. The projector will periodically send out AMX beacon packets over the network.



For details on AMX Device Discovery, visit the AMX website.  
<http://www.amx.com/>

## Crestron RoomView

 > [Network settings] > **[Crestron RoomView]**

Crestron RoomView enables centralized management of multiple projectors over a network. Networked projectors can be remotely controlled to troubleshoot issues, check the useful life of lamps, or turn the projectors on or off. Specify whether to use Crestron RoomView.

Option	Function
Off	Disable Crestron RoomView.
On	Enables Crestron RoomView. A port for RoomView will be opened, and the projector will respond to CIP packets. Communication is possible via the RoomView Express/Server application or via Crestron Controller. (P142)



For details on Crestron RoomView, visit the Crestron® website.  
<http://www.crestron.com/>

# Completing Computer Settings for a Network Connection

## Specifying an IP Address

Instructions for setting a computer's IP address are as follows for each operating system.

### ■ Windows 8.1 / Windows 8

**1 Right-click on the start screen background and click [All Apps] in the lower right.**

- Windows 8.1 Users:  
Click the down arrow in the lower left of the start screen.

**2 Click [Control Panel].**

- From the Desktop:  
Press Win+X.  
In the shortcut menu displayed in the lower left, click [Control Panel].

**3 Click [View network status and tasks].**

- In Icon View:  
Click [Network and Sharing Center].

**4 Click [Change adapter settings].**

**5 Right-click [Ethernet], and then click [Properties].**

**6 In the [This connection uses the following items] list, select [Internet Protocol Version 4 (TCP/IPv4)] and click the [Properties] button. Make a note of the original network settings (IP address, subnet mask, default gateway, etc).**

**7 Select [Use the following IP address] and set the IP address and subnet mask.**

The factory default IP address for the projector is "192.168.254.254". Set an IP address which is different from this.

**8 When finished, click the [OK] button, and then click the [Close] button in the [Ethernet Properties] window to close it.**

## ■ Windows 7

- 1** From the PC [Start] menu, select [Control Panel].
- 2** Click on [Network and Internet], then click on [View network status and tasks].
- 3** From the menu on the left side of the window, click on [Change adapter settings].
- 4** Right-click [Local Area Connection], and open [Properties].
- 5** Select [Internet Protocol Version 4 (TCP/IPv4)] and click the [Properties] button. Make a note of the original network settings (IP address, subnet mask, default gateway, etc).
- 6** Select [Use the following IP address] and set the IP address and subnet mask.  
The factory default IP address for the projector is “192.168.254.254”. Set an IP address which is different from this.
- 7** When the settings are completed, click the [OK] button and then click the [OK] button on the [Local Area Connection Properties] window to close it.

## ■ Windows Vista

- 1** From the PC [Start] menu, select [Control Panel].
- 2** Click on [View network status and tasks].
- 3** From the menu on the left side of the window, click on [Manage network connections].
- 4** Right-click [Local Area Connection], and open [Properties].
- 5** Select [Internet Protocol Version 4 (TCP/IPv4)] and click the [Properties] button. Make a note of the original network settings (IP address, subnet mask, default gateway, etc).
- 6** Select [Use the following IP address] and set the IP address and subnet mask.  
The factory default IP address for the projector is “192.168.254.254”. Set an IP address which is different from this.
- 7** When the settings are completed, click the [OK] button and then click the [OK] button on the [Local Area Connection Properties] window to close it.

### ■ Mac OS X

- 1 Open the Apple Menu and select [System Preferences].
- 2 In the System Preferences window, click [Network] to display the Network window.
- 3 Select [Built-in Ethernet] and click the [TCP/IP] tab. Make a note of the original network settings (IP address, subnet mask, router, DNS server, etc.).
- 4 Create a new network environment and set the IP address and subnet mask.  
The factory default IP address for the projector is “192.168.254.254”. Set an IP address which is different from this.
- 5 Click [Apply] to close the network preference window.

### ■ Resetting the IP Address Setting of the Computer

Follow the same procedure as for changing the IP address and reset the values to the original values based on the notes taken before the change.

## Setting Up the Network

### ■ Displaying the Network Configuration Screen

- 1 Turn on the computer and projector.



Network functions are not available for the first 40 seconds after projector startup.

- 2 Launch a web browser, enter “http://(projector IP address)” in the address bar, and press the Enter key.  
The projector web screen appears.

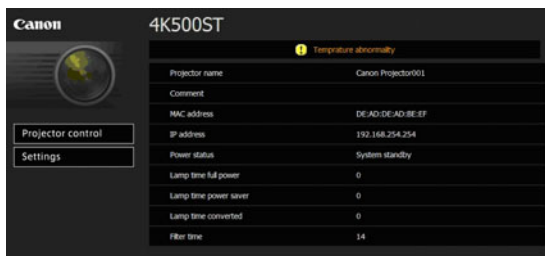

The following information is displayed.

Projector control	Displays the projector control screen.
Settings	Shows the settings screen.
Projector name	The name of the projector on the network
Comment	Relevant notes, such as where the projector is installed
MAC address	The MAC address of the projector
IP address	The IP address of the projector
Power status	The power status of the projector
Lamp time full power	Lamp operating time in [Full power] lamp mode
Lamp time power saver	Lamp operating time in [Power saver] lamp mode
Lamp time converted	Lamp operating time (converted value)
Filter time	Air filter operating time
Alert	Error message (if an error has occurred) Temperature abnormality Faulty lamp Faulty cooling fan Faulty power supply Faulty air filter unit Faulty lens connector



The factory default IP address is “192.168.254.254”. If DHCP settings are used, ask the network administrator for the projector IP address. It is possible to check the IP address from the projector menu. (P126)

- 3 Click [Settings] on the web screen.**  
The password input window appears.

## Menu Settings

- 4 Enter the user name and password on the password input window, then click [OK].

The factory default user name is “root” and the password is “system”.

The settings screen is displayed. Complete the network settings on this screen.

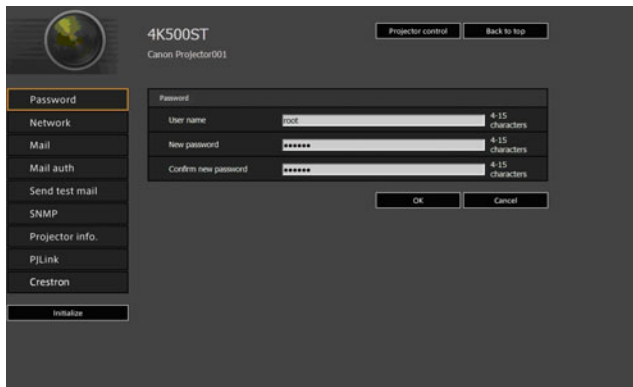

The screenshot shows the settings interface for a Canon 4K500ST projector. The title bar includes '4K500ST' and 'Canon Projector001'. A sidebar on the left lists menu items: Password, Network, Mail, Mail auth, Send test mail, SNMP, Projector info., PJLink, Crestron, and Initialize. The 'Password' menu item is selected. The main area displays a 'Password' configuration window with three input fields: 'User name' (containing 'root'), 'New password' (containing '\*\*\*\*\*'), and 'Confirm new password' (containing '\*\*\*\*\*'). Each field has a character count of '4-15 characters'. 'OK' and 'Cancel' buttons are at the bottom of the window.



To control the projector from the computer, click [Projector control]. (P146)

## Network Setting

- 1 Select a function to set up from the settings screen menu.

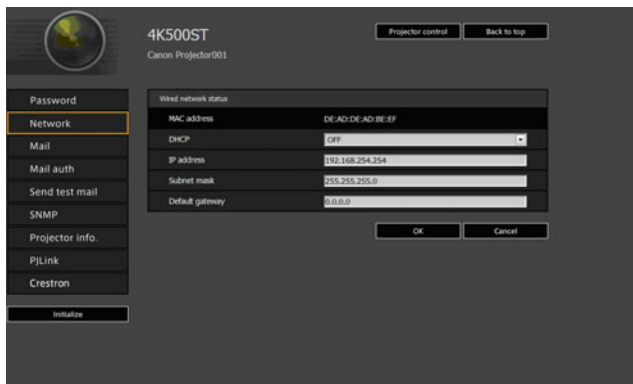

The screenshot shows the same settings interface as above, but with the 'Network' menu item selected. The main area displays a 'Wired network status' configuration window. It includes a 'Wired network status' label and a 'MAC address' field with the value 'DE-AD-DE-AD-DE-DE'. Below this is a 'DHCP' dropdown menu set to 'OFF'. The 'IP address' field contains '192.168.254.254', the 'Subnet mask' field contains '255.255.255.0', and the 'Default gateway' field contains '0.0.0.0'. 'OK' and 'Cancel' buttons are at the bottom of the window.

## 2 Enter setting details in the fields shown (1), and then click [OK] (2).

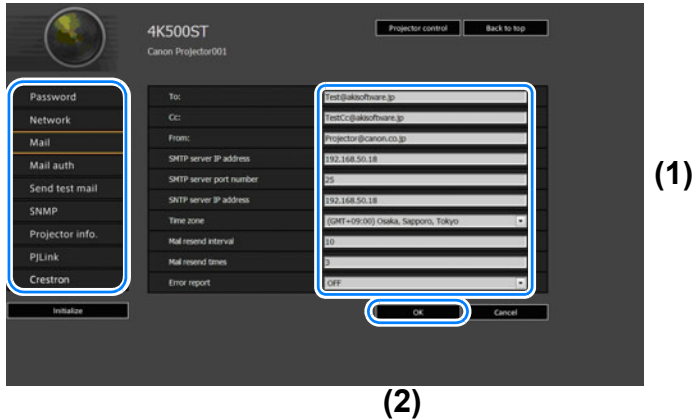

## 3 A confirmation window appears. Check the contents and if they are correct, click [Apply].

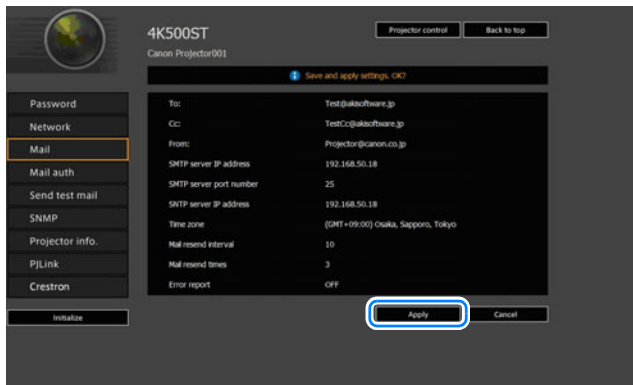

The settings are applied to the projector.

Selecting [Network] or [Password] in the menu will cause this message to be displayed: “Save completed. Please change setting and reconnect.”

If you select functions other than above, “Save completed” is displayed. Click [Back to top] to return to the top page of the web screen.

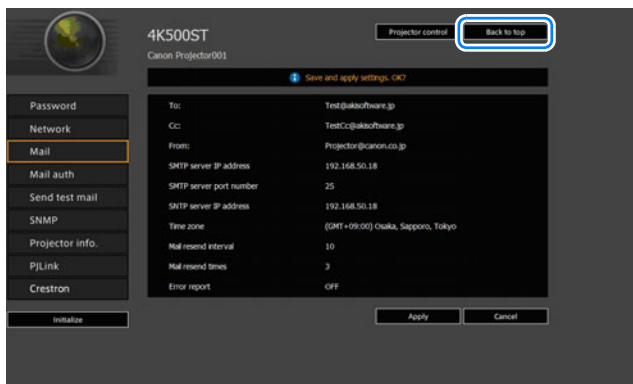

## Setting a Password [Password]

From [Password] in the settings screen, you can set a user name and password for web screen login. For the setting procedure, refer to “Network Setting” (P134).

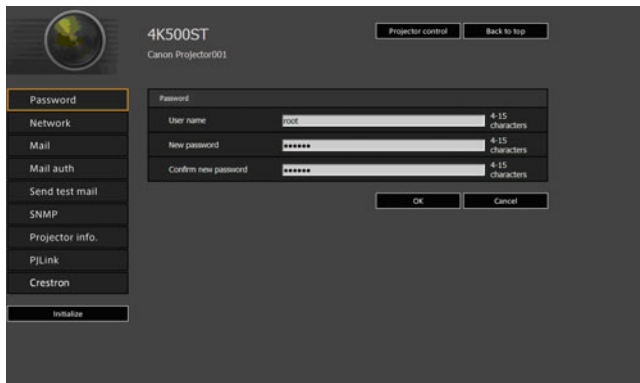

Item	Explanation	Factory default setting
User name	When logging into the web screen, enter the user name in 1-byte alphanumeric characters and symbols (4 -15 characters).	root
New password	When logging into the web screen, enter the password in 1-byte alphanumeric characters and symbols (4 -15 characters).	system
Confirm new password	For confirmation, enter the same password that you entered in [New password].	system



## Setting Basic Information [Network]

From [Network] in the settings screen, you can log into the web screen and set basic network information. For the setting procedure, refer to “Network Setting” (P134).

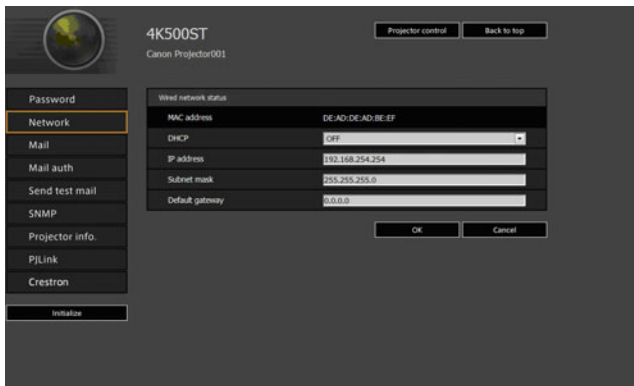

Item	Explanation	Factory default setting
MAC address	Shows the projector's MAC address.	The MAC address of the projector
DHCP	Select whether to turn the DHCP function on or off. If the function is on, because the IP address is acquired from the server, it is not possible to enter the following items. [IP address] [Subnet mask] [Default gateway]	OFF
IP address	Enter the IP address of the projector in 1-byte numbers.	192.168.254.254
Subnet mask	Enter the subnet mask in 1-byte numbers.	255.255.255.0
Default gateway	Enter the default gateway IP address in 1-byte numbers.	0.0.0.0



If settings related to TCP/IP were changed, it is necessary to disconnect and reconnect to the network.

If the network subnet mask was changed, select [Subnet mask] in the above screen and set the new subnet mask.

## Setting Up Email [Mail]

From [Mail] in the settings screen, you can set the items necessary to send error mails and test mails. For the setting procedure, refer to “Network Setting” (P134).

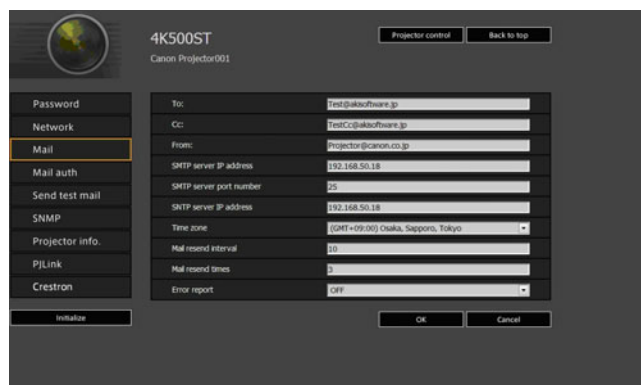

Item	Explanation	Factory default setting
To:	Enter the recipient address for error mails in 1-byte alphanumeric characters and symbols (1 - 63 characters).	MailUserAccount
Cc:	Enter the CC address for error mails in 1-byte alphanumeric characters and symbols (1 - 63 characters).	<Blank>
From:	Enter the sender address for error mails in 1-byte alphanumeric characters and symbols (1 - 63 characters).	Projector@canon.co.jp
SMTP server IP address	Enter the SMTP server IP address in 1-byte numbers.	0.0.0.0
SMTP server port number	Enter the SMTP server port number in 1-byte numbers (1 - 65535).	25
SNTP server IP address	Enter the SNTP server IP address in 1-byte numbers.	0.0.0.0
Time zone	Select the time zone where the projector is used.	(GMT) Dublin, Lisbon, London
Mail resend interval*	Enter the interval for resending mail when an error occurred (unit: seconds) within the range of 0 - 59 seconds using 1-byte numbers.	10
Mail resend times	Enter the number of times to resend mail when an error occurred within the range of 0 - 255 using 1-byte numbers.	3
Error report	Select whether to turn the error mail sending function on or off.	OFF

\* When the interval is set to 0 seconds, repeated attempts to send mail are made (as set in [Mail resend times]) without pausing between attempts.

## Mail Authentication Settings [Mail auth]

From [Mail auth] in the settings screen, you can configure the settings for authentication of mail that is sent when an error occurs. For the setting procedure, refer to “Network Setting” (P134).

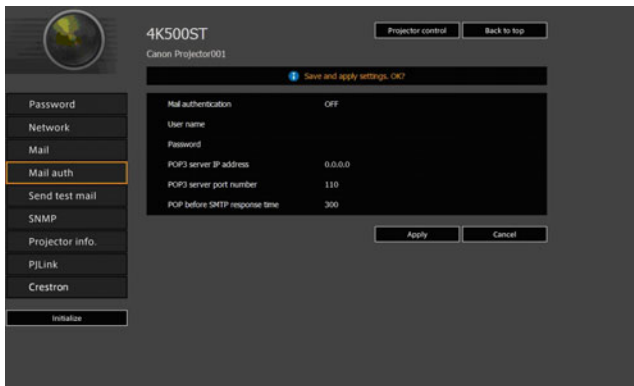

Item	Explanation	Factory default setting
Mail authentication	Select the mail authentication method. If OFF is selected, the other mail authentication settings cannot be changed.	OFF
User name	Enter the user name to use for mail authentication in 1-byte alphanumeric characters and symbols (1 - 63 characters).	<Blank>
Password	Enter the password for mail authentication in 1-byte alphanumeric characters and symbols (1 - 63 characters).	<Blank>
Confirm password	For confirmation, enter the same password as you entered in [Password].	<Blank>
POP3 server IP address	Enter the POP3 server IP address in 1-byte numbers.	0.0.0.0
POP3 server port number	Enter the POP3 server port number in 1-byte numbers (1 - 65535).	110
POP before SMTP response time	Enter the SMTP authentication timeout period after POP3 authentication (unit: milliseconds) using 1-byte numbers (0 - 9999 milliseconds).	300

## Menu Settings

### Sending a Test Mail [Send test mail]

From [Send test mail] in the settings screen, you can send a test mail to the mail address that was set in [Mail]. The settings cannot be changed from this screen.

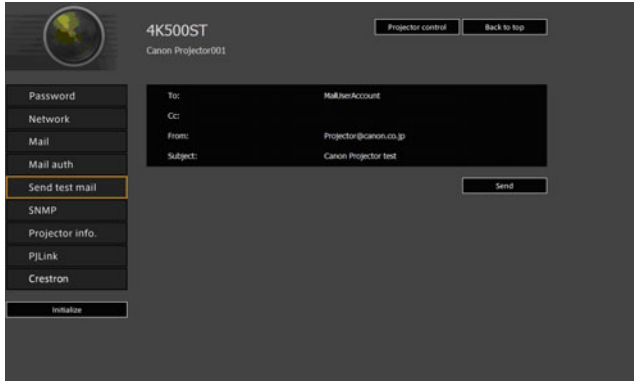

Item	Explanation
To:	The recipient address which was set from [Mail] in the settings screen (P138) is displayed.
Cc:	The CC address which was set from [Mail] in the settings screen (P138) is displayed.
From:	The sender address which was set from [Mail] in the settings screen (P138) is displayed.
Subject:	The predetermined mail title “Canon Projector test” is displayed.

### SNMP Settings [SNMP]

From [SNMP] in the settings screen, you can configure the settings related to control of projectors which use SNMP (Simple Network Management Protocol). For the setting procedure, refer to “Network Setting” (P134).

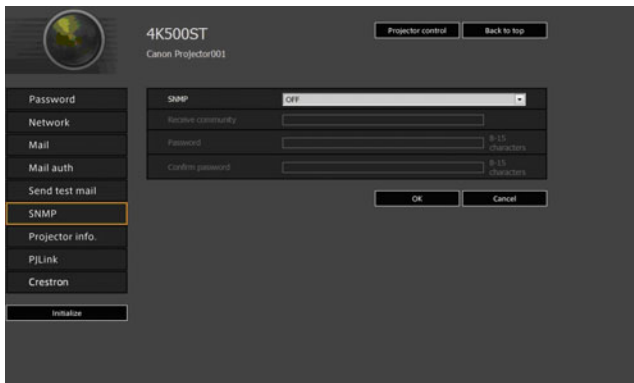

Item	Explanation	Factory default setting
SNMP	Select the SNMP function version. If OFF is selected, the SNMP function will be turned off and the other settings in this screen cannot be changed.	OFF
Receive community	Enter the community name which will receive projector information in 1-byte alphanumeric characters and symbols (1 - 15 characters).	<Blank>
Password	Enter the community settings password in 1-byte alphanumeric characters and symbols (8 - 15 characters). It can be set only when the SNMP version is V3.	<Blank>
Confirm password	For confirmation, enter the same password as you entered in [Password].	<Blank>

## Setting Projector Information [Projector info.]

From [Projector info.] in the settings screen, you can enter relevant comments such as projector names and locations where projectors are installed so that the information can be used to identify projectors when multiple projectors are installed on the network. For the setting procedure, refer to “Network Setting” (P134).

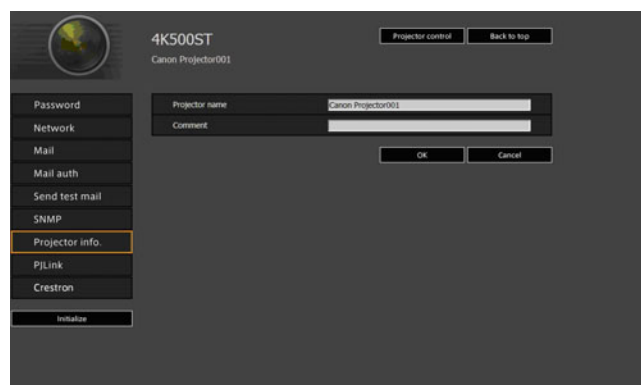

Item	Explanation	Factory default setting
Projector name	Enter the projector name in 1-byte alphanumeric characters and symbols (1 - 63 characters).	Canon Projector001
Comment	Enter any relevant notes, such as where the projector is installed.	<Blank>



Some characters such as # cannot be used for [Projector name] and [Comment].

## Setting PJLink [PJLink]

From [PJLink] in the settings screen, you can set the PJLink functions which are the standard for projector management on a network. For the setting procedure, refer to “Network Setting” (P134). For information about PJLink, refer to “What is PJLink?” (P128).

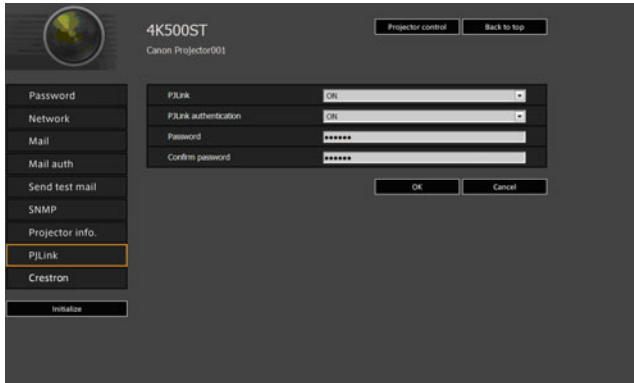

Item	Explanation	Factory default setting
PJLink	Turn the PJLink function on or off. If OFF is selected, the PJLink function will be turned off and the other settings in this screen cannot be changed.	ON
PJLink authentication	Select whether to turn the PJLink authentication function on or off. If OFF is selected, it is not possible to change the following items. [Password] [Confirm password]	ON
Password	Enter the PJLink authentication password in 1-byte alphanumeric characters (1 - 32 characters).	system
Confirm password	For confirmation, enter the same password that you entered in [Password].	system

## Setting Up a Controller Manufactured by Crestron Electronics [Crestron Controller]

The [Crestron e-Control] screen will open. For details on the Crestron Controller, visit the Crestron website.

<http://www.crestron.com/>

## Setting Errors

When a setting-related error occurs, the error name is displayed on the screen, and a “!” mark is displayed next to the input field which caused the error.

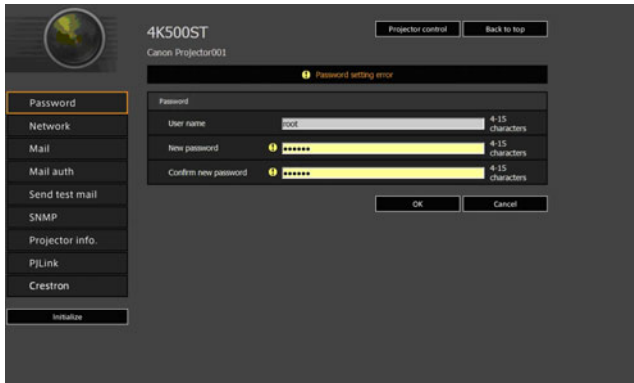

The error meanings are as shown below.

Error	Meaning
Input error	A setting outside the valid range was set on the settings screen.
Password setting error	The set password and confirmation password did not match.
Invalid SMTP	The SMTP server IP address has not been set.
System failed to connect SMTP server.	Failed to connect to the SMTP server when sending a test mail.
System failed to connect POP3 server.	Failed to connect to the POP3 server attempting to send a test mail.
System doesn't support this auth type.	An authentication type was set which is not supported by the server.
System failed to authenticate.	Authentication failed attempting to send a test mail.
The system failed to send the test mail.	Sending of test mail failed due to a connection failure with the SMTP server or an error which does not ordinarily occur.

### Resetting Network Settings to the Default Settings

- 1 Perform steps 1 - 3 on “Displaying the Network Configuration Screen” (P132) to display the settings screen.
- 2 Click [Initialize].

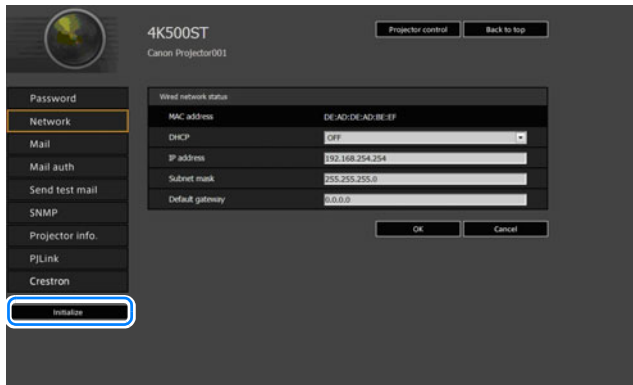

- 3 A confirmation window appears. Click [OK].



## ■ Error Notification Mails

The messages shown in the following error list are sent when an error occurs in the projector.

### Error list

Errors related to temperature	Error name	Temperature abnormality
	Text	The temperature inside the projector is too high for some reason or the outside air temperature is higher than the specified one. If the problem is inside the projector, check whether the projector is installed and operated normally, turn off the projector to cool its inside, and retry projection. If the same warning occurs again, the projector may be defective. Contact your dealer.
Errors related to the lamp	Error name	Faulty lamp
	Text	The lamp has burnt out. Replace the lamp with a new one. If the same warning occurs again, the lamp drive circuit may be defective. Contact your dealer.
Errors related to the fan	Error name	Faulty cooling fan
	Text	The cooling fan or another component may be defective. Contact your dealer.
Errors related to the air filter	Error name	Faulty air filter unit
	Text	The air filter unit is not installed properly. Check whether the air filter unit is installed properly. If it is installed properly, the air filter unit detection switch may be defective. Contact your dealer.
Errors related to the power	Error name	Faulty power supply
	Text	The voltage of part of the power supply is abnormally high or anyother problem has occurred in the power supply. Contact your dealer.

### Controlling the Projector from a Computer

When the projector is connected to a network, it is possible to control the projector from a computer via the network.

- 1 Turn on the computer and projector.**
- 2 Launch a web browser, enter “http://(projector IP address)” in the address bar, and press the Enter key.**  
The projector web screen appears.

**!** The factory default IP address is “192.168.254.254”. If DHCP settings are used, ask the network administrator for the projector IP address. It is possible to check the IP address from the projector menu.

- 3 Click [Projector control] on the web screen.**  
The password input window appears.
- 4 Enter the user name and password on the password input window, then click [OK].**  
The factory default user name is “root” and the password is “system”.  
The projector control screen appears.

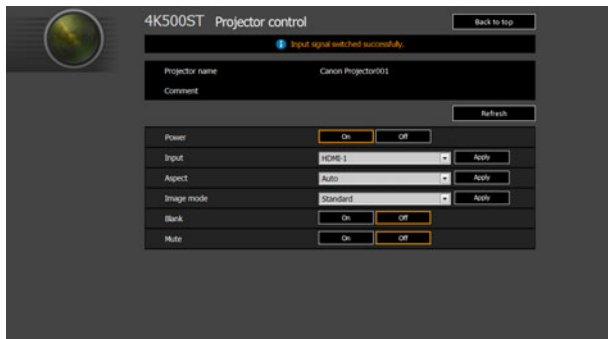

The projector can be controlled from this screen.

Item	Explanation
Projector name	The name of the connected projector is displayed. (P141)
Comment	Shows notes, such as where the projector is installed. (P141)
Refresh	Refreshes the displayed contents with the most recent information.
Power	Turns projector power on or off.
Input	Select an input signal and click [Apply] to change to that input signal. (P63)
Aspect	Select an aspect and click [Apply] to change to that aspect. (P72)
Image mode	Select an image mode and click [Apply] to change to that image mode. (P76)
Blank	Switches the blank setting on or off. (P80)
Mute	Switches the mute setting on or off. (P31)

- 5** When the operations are finished, click [Back to top] to return the initial web screen.



## Checking Projector Information

You can check information about the signal types of the images projected and other information.

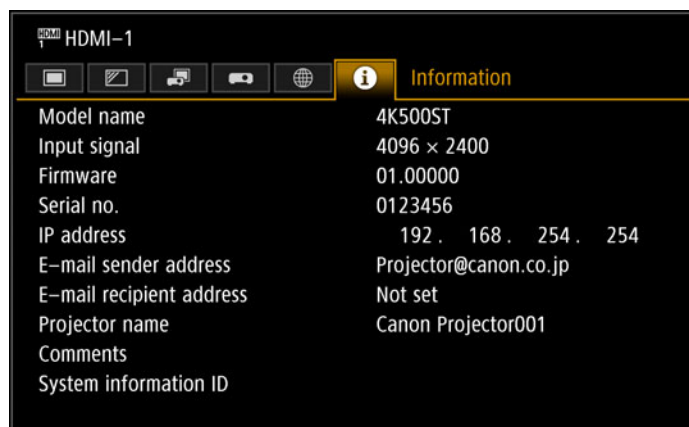

Menu	Function
Model name	Shows the model name.
Input signal	Details of the input signal currently selected Information such as the type, resolution, frequency, and color format of the signal is displayed.
Firmware	Current firmware version
Serial no.	Serial number unique to this projector
IP address	IP address used when connected to a network.
E-mail sender address*	Sender e-mail address used for sending error mails (P138)
E-mail recipient address*	Displays [Already set] or [Not set] to show whether a recipient e-mail address has been set for receiving error mails. (P138)
Projector name*	Name which identifies this projector on the network
Comments*	Comments such as the location in which the projector is installed are displayed. (P141)
System information ID	System information. Normally this is not displayed.

\* The values are not displayed when network functions are [Off].

## Projecting from Multiple Projectors at Once (Edge Blending)

Overlapping edges of images from multiple projectors used together can be blended to make the overall image more seamless.

### ■ Basic Instructions

Follow these steps when using two projectors side by side.

#### 1 In the [Install settings] menu, select [Professional settings] > [Edge blending] > [Adjust].



- If you have already completed edge blending settings, selecting [Adjust] will apply them.
- To restore the default settings before adjustment, select [Reset].

#### 2 Set [Marker] to [On].

Marker lines are projected on the images. The red marker indicates the start position for adjustment, and the green marker, the end position.

Edge blending		
Side	Width	Start position
Left	0	0
Right	0	0
Top	0	0
Bottom	0	0
Color blending adjustment	Off	
Black level adjustment	Off	
Marker	Off	
Reset		
Return		



- By default, the green and red markers are displayed in the same position, so only the red marker is visible.

#### 3 Adjust [Start position] for the side where images overlap. Move the start marker to the outer edge of the overlapping area, or press a number button on the remote control to specify the start position.

#### 4 Adjust [Width]. Move the end marker to the inner edge of the overlapping area, or press a number button on the remote control to specify the width of the area to correct.

The area between the starting and ending markers is called the blending area. Values indicated for this blending area are adjusted to match manually entered blending area values. Shading is applied to this area, and the brightness is adjusted to match portions that overlap with other areas. After you complete settings for one image, do the same thing for the other one to specify the blending area. Adjust the settings to make the blending area for each image the same.

#### 5 Set [Marker] to [Off].

### ■ Color Adjustment

In overlapping projection, portions of images in the overlapping area that pick up other colors or are miscolored may be more noticeable. You can make this overlapping area appear less distracting by performing Color blending adjustment.

- 1** In the [Install settings] menu, select [Professional settings] > [Edge blending] > [Adjust] > [Color blending adjustment] > [Adjust].
- 2** As you watch the image, adjust the value to eliminate unwanted colors in the overlapping area.



First adjust red, green, and blue together by changing the [White] value, and then adjust [Red], [Green], and [Blue] values individually.

- 3** Repeat this adjustment on all projectors.

### ■ Black Level Adjustment

In overlapping projection, dark colors are projected with less intensity than other colors in the overlapping area. You can make this overlapping area less distracting by adjusting the black level of non-overlapping image areas.

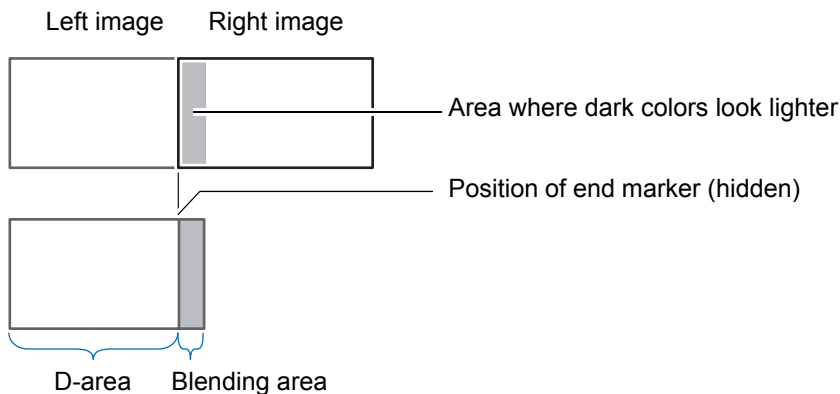

Here, the non-overlapping image area (from the end marker toward the center of the image) is called area “D.”

Normally, three areas are identified in the context of end markers: A, B, and C. In the following instructions, only area D is adjusted, and the widths of A, B, and C are left at the default value of 0.



To prepare for adjustment, set [No signal screen] to [Black], start projection with no input signal, and turn off the room lights, so that you can check dark image areas. (P109)

- 1 In the [Install settings] menu, select [Professional settings] > [Edge blending] > [Adjust] > [Black level adjustment] > [Adjust].
- 2 Select [Adjustment type] > [Black level].
- 3 After selecting [D-area base], as you watch the image, adjust the values so that the brightness and colors of the blending area and area D match.

Black level adjustment	
Adjustment type	Black level
B-area base	0
B-area red	+0
B-area green	+0
B-area blue	+0
D-area base	0
D-area red	+0
D-area green	+0
D-area blue	+0
Return	

Adjust [D-area base] to lighten the black level, and adjust [Red], [Green], and [Blue] to obtain an optimal black level color tone, as needed.

- 4 Repeat this adjustment on all projectors.

## ■ Smoother Overlapping Areas

The black level along the right edge of area D (along the blending area) may be more noticeable than that of surrounding areas.

By adjusting the black level of area B, you can make the transition smoother. To compensate, adjust each area as follows.

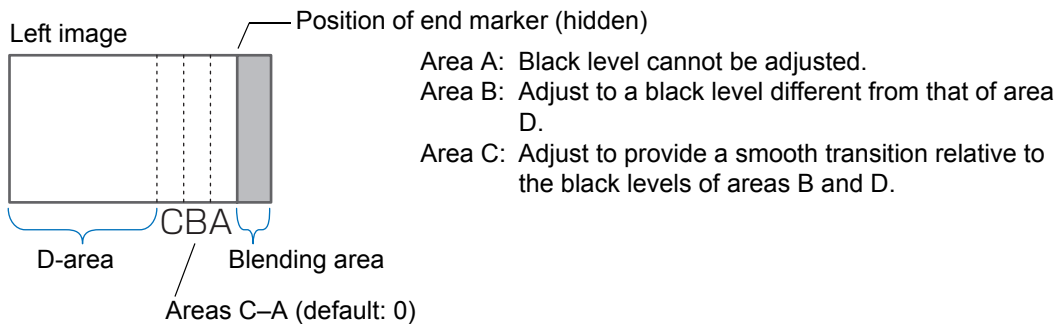

When the projected image has multiple blending areas (on the top, bottom, and each side), the width of areas A, B, and C must be adjusted to suit these blending areas.

In this example, instructions are given for adjusting area B.

- 1 In the [Install settings] menu, select [Professional settings] > [Edge blending] > [Adjust] > [Black level adjustment] > [Adjust].
- 2 Select [Adjustment type] > [Area] > [Side] > [Right].

### 3 Select [B-width], and then specify the width of area B.

Adjust the width of area B so that it roughly matches the area where the black level of area B stands out. This will make the width of area D narrower.

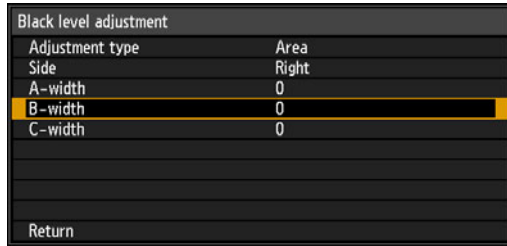

### 4 Select [Adjustment type] > [Black level]. Adjust [B-area base] as you watch the image.



- Results of adjusting the black level of area B are applied to all sides.
- Blending can be fine-tuned by adjusting [Adjustment type] > [Black level] > [Red], [Green], and [Blue].

### 5 As you watch the image, adjust the width of areas A, B, and C.

### 6 Readjust the black level of area B, as needed.

To reduce distracting colors and colors that are out of alignment in areas where the images overlap, perform [Color blending adjustment] targeting the main tone in the envisaged projected image.



If you perform adjustments using [Color blending adjustment] or other menus, that may not eliminate the distracting colors and differences in brightness in areas where the images overlap.



# Advanced Registration to Adjust Projected Images

Any values you set in 5-point adjustment are retained if you subsequently perform manual adjustment. For more precise correction after 5-point adjustment, perform manual adjustment.

This feature enables precise correction of red, green, or blue misalignment in different areas of the screen by color and area.

Two methods of registration are available: 5-point adjustment (using points in the corners and center of the screen) and more precise manual adjustment based on 54 points (in a 6 x 9 grid).



- Adjust zoom and lens shift as needed before using [Advanced registration].
- Performing keystone adjustment will prevent accurate adjustment with [Advanced registration]. If keystone adjustment is required, complete adjustment with [Advanced registration] first.

## ■ Registration Using 5-Point Adjustment

5-point adjustment enables basic correction of color misalignment across the screen, by moving adjustment points in each corner and the center.

- 1** In the [Install settings] menu, select [Professional settings] > [RGB alignment] > [Advanced registration] > [Adjust] > [5-point adjustment] > [Adjust].

The projector enters 5-point adjustment mode, and a point selection window is displayed.



- Two sizes of point selection windows are used, depending on [Panel drive mode].
- With advanced registration, checkered or halftone image areas may be affected by uneven colors or image artifacts.

## Advanced Projection

- 2 Use the [▲] / [▼] / [◀] / [▶] buttons to select the point for correction, and then press the OK button.

The projector enters color selection mode.



- 3 Select [Red] or [Blue] as the color, and then press the OK button.



- Select [Chart] to toggle between display of the point selection window and source signal.
- Accessing the 5-point adjustment window during test pattern projection will show the test pattern instead of your supplied signal.

- 4 Use the [▲] / [▼] / [◀] / [▶] buttons to align the adjustment points.



- 5 Press the OK button to return to the window for color selection mode.
- 6 Repeat this process to align the remaining colors and adjustment points.

## Manual Registration

Use manual adjustment to correct registration only in certain areas.



Any manual adjustment values set before switching to 5-point adjustment are cleared.

- 1 In the [Install settings] menu, select [Professional settings] > [RGB alignment] > [Advanced registration] > [Adjust] > [Manual adjustment]. The projector enters manual adjustment mode, and a point selection window is displayed.

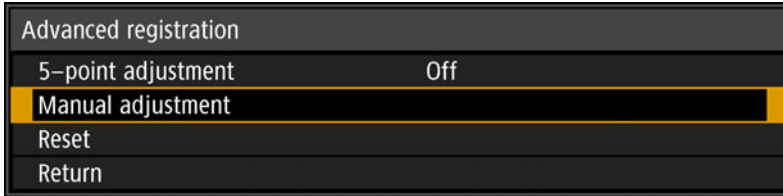

- Two sizes of point selection windows are used, depending on [Panel drive mode].
- With advanced registration, checkered or halftone image areas may be affected by uneven colors or image artifacts.

- 2 Use the [▲] / [▼] / [◀] / [▶] buttons to select the point for correction, and then press the OK button. The projector enters color selection mode.

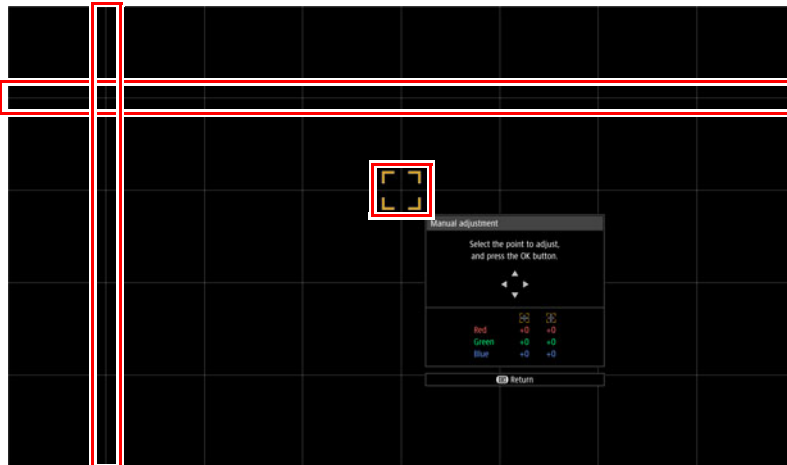

## Advanced Projection

### 3 Select [Red], [Green], or [Blue] as the color, and then press the OK button.



- Select [Chart] to toggle between display of the point selection window and source signal.
- Accessing the manual adjustment window during test pattern projection will show the test pattern instead of your supplied signal.

### 4 Use the [▲] / [▼] / [◀] / [▶] buttons to align the adjustment points.

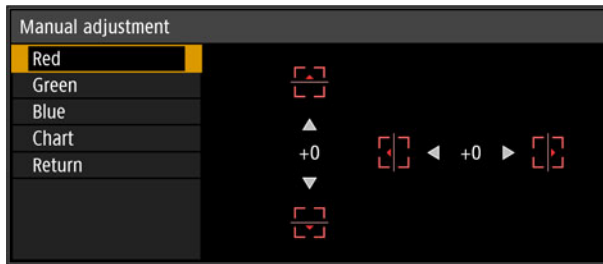

### 5 Press the OK button to return to the window for color selection mode.

### 6 Repeat this process to align the remaining colors and adjustment points.

## ■ Resetting Image Registration

Clears the values set in 5-point adjustment or manual adjustment.

### 1 In the [Install settings] menu, select [Professional settings] > [RGB alignment] > [Advanced registration] > [Adjust] > [Reset].

A confirmation message for resetting is displayed.

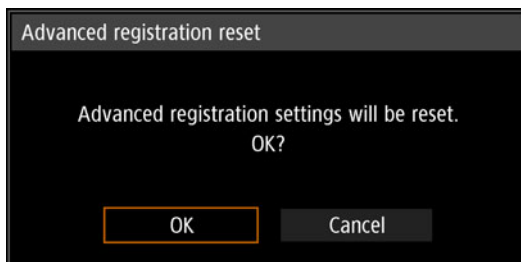

### 2 Select [OK] to reset the adjustment.

The following tasks are executed.

- Values set in 5-point adjustment are cleared.
- 5-point adjustment is deactivated.
- Values set in manual adjustment are cleared.

# Adjusting Peripheral Focus

This feature enables focus adjustment around the edges of the screen.

- Use marginal focus adjustment for curved screens, such as domes.
- Use marginal focus adjustment to bring images on flat screens into focus if image edges remain warped after you adjust the overall focus.

 [Marginal focus] must be set to [On] in advance. (P102)

## ■ Bringing Image Edges into Focus

To adjust peripheral focus, press the **FOCUS** button on the remote control or the **LENS** button on the projector.

- 1 Press the **FOCUS** button on the remote control twice to display the marginal focus adjustment window.

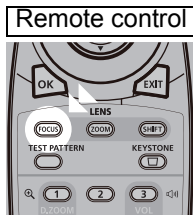

Press twice.

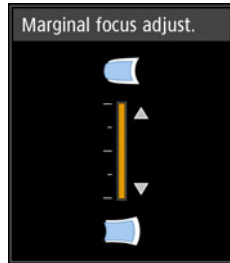

Pressing the **LENS** button on the projector repeatedly switches between windows for lens-related parameters.

Press the **LENS** button twice to display the marginal focus adjustment window.

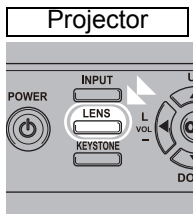

Press twice.

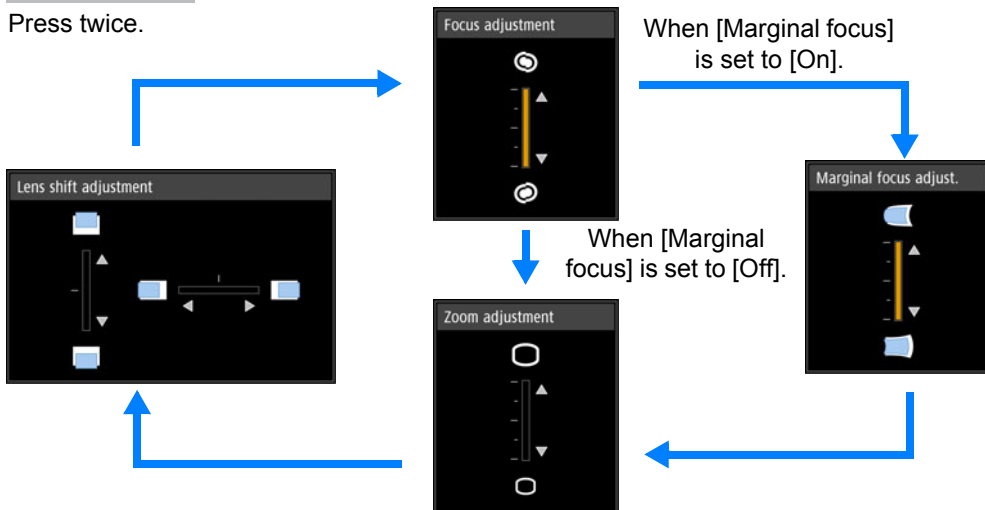

### 2 Press the pointer buttons to adjust the focus at image edges.

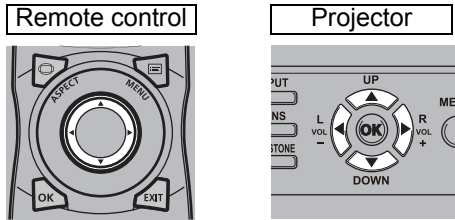

Press the [▲] / [▶] buttons to move the peripheral focus farther away.  
Press the [▲] / [◀] buttons to move the peripheral focus nearer.

### 3 Once image edges are in focus, press the OK or FOCUS button.

#### ■ Resetting Adjustment

Clears the values set in marginal focus adjustment.

In the [Install settings] menu, select [Professional settings] > [Marginal focus] > [Reset] to reset the adjustment.

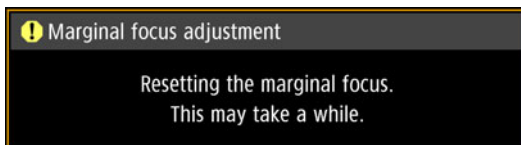

The following tasks are executed.

- Values set in marginal focus adjustment are cleared.
- [Marginal focus] is set to [Off].



Setting [Marginal focus] to [Off] will not reset the setting value for peripheral focus.

# Other Information

---

Safety Instructions

---

Before Use

## Basic Guide

---

Installation Procedure

---

Connection Procedure

---

Projection Procedure

---

Convenient Features

## Advanced Guide

---

Using Menus

---

Menu Settings

---

Advanced Projection

## Other Information

---

Maintenance

---

Product Specifications

---

Troubleshooting

## Cleaning the Projector

Clean the projector frequently to prevent dust from settling on the surface. A dirty lens may ruin the quality of the projected image.



**Before cleaning the projector, always turn it off, unplug it after the cooling fan stops, and wait at least one hour. Otherwise, you may get burned because the main unit is very hot immediately after the projector is turned off.**

Wipe the projector's main unit softly with a soft cloth. If the projector is heavily soiled, soak the cloth in water with a small amount of detergent in it, squeeze the cloth thoroughly, and then wipe the projector with it. After cleaning, wipe the projector with a dry cloth.

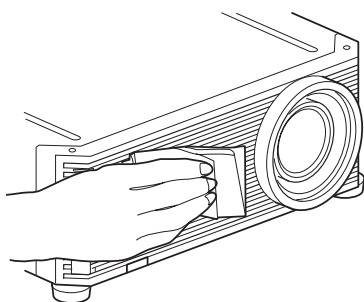

- Never use volatile cleaning liquid or benzene, as these may damage the finish of the projector.
- When using a chemical dust cloth, make sure to read the instructions thoroughly.
- When cleaning the projector's lens, use a commonly available air blower or lens cleaning paper. The lens surface is easily damaged, so do not use a hard cloth or tissues.

### Request Internal Cleaning Regularly

Dust that accumulates over long periods without cleaning may eventually cause fire or electric shock. Once a year, request internal cleaning from the Canon Customer Support Center. (Note that a fee is charged.) Cleaning before damp, rainy seasons is especially effective.

## Cleaning the Air Filter

The air filter protects the lens and mirror inside the projector from dust and dirt. Should the air filter become clogged with dust, the projector may be damaged since it will block the air flow into the projector and raise the internal temperature of the projector. The following screen is displayed when turning on the projector if the air filter needs to be cleaned. Clean the air filter if it is displayed.

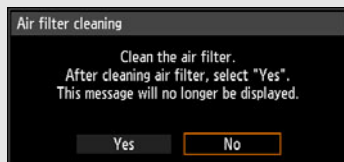

- Only the [◀], [▶], **OK**, **POWER**, **EXIT**, **FOCUS**, **ZOOM** and **SHIFT** buttons are available while this screen is displayed. (When you press the **POWER** button, the "Push POWER button again to turn off power." message appears.)
- When this screen has disappeared after being displayed for 10 seconds, all buttons become operable.



Follow the procedure below when cleaning the air filter.

- 1** Turn the power of the projector off and pull out the power plug.
- 2** Hook your finger around the air filter handle on the front of the projector and remove the air filter. Use a vacuum cleaner to clean off the dust.

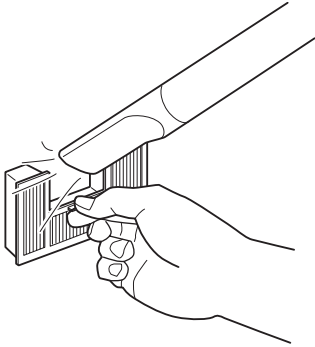

**!** Do not rinse the air filter in water. This may damage the air filter and projector.



- If the air filter cleaning screen is displayed when turning on the projector after cleaning the air filter, select [Yes] and press the **OK** button. The air filter counter is reset, and the message is no longer displayed.



- This screen is not displayed when [Air filter warning display] is set to [Off]. (P111) Reset the air filter counter manually. (P119)

## Replacing the Air Filter

Follow the procedure below when replacing the air filter.

- 1** Turn off the projector power and remove the power plug.

- 2** Pull out the filter cover tab on bottom while lifting up.

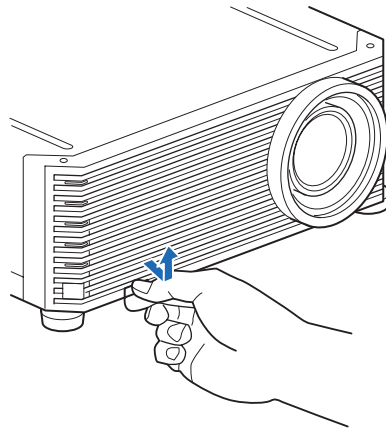

- 3** Open the filter cover and remove it.

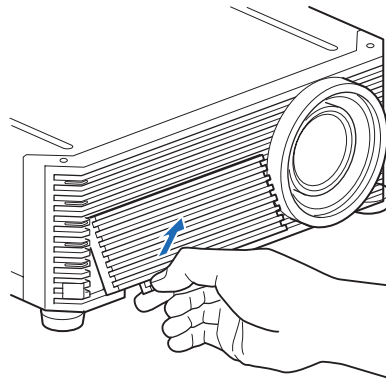

- 4** Remove the air filter.

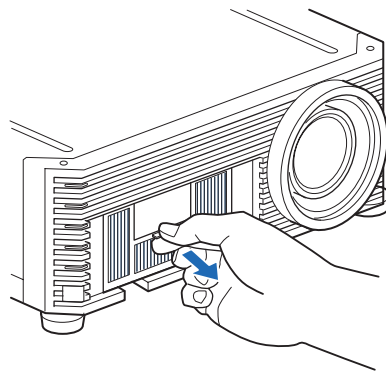

- 5** Holding the new air filter by the tab, insert the air filter in the projector.

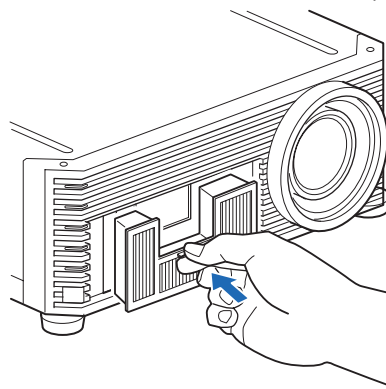

- 6** Align the filter cover tab with the groove and close the filter cover.

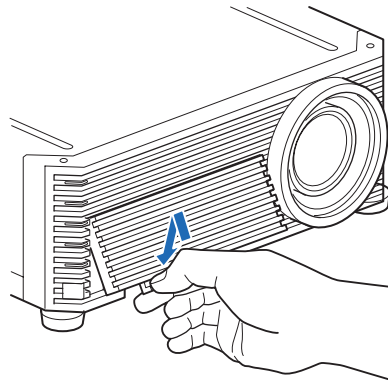

- Handle the air filter carefully. If damaged, the air filter will not work properly.
- We recommend cleaning or replacing the air filter (part no: RS-FL03) when you replace the lamp.
- Contact the Canon Customer Support Center for further information.
- Replacement air filter part number: RS-FL03
- This can also be purchased from the Canon website.

## Replacing the Lamp

When the usage time of the lamp exceeds a certain amount of time, the following message (two types) is displayed for 10 seconds every time the projector is turned on.

### 2,700 hours to less than 3,000 hours



Prepare a new lamp when this screen is displayed.

- Only the [**◀**], [**▶**], **OK**, **POWER**, **EXIT**, **FOCUS**, **ZOOM** and **SHIFT** buttons are available while this screen is displayed.
- When you press the **POWER** button, “Push POWER button again to turn off power.” message appears.
- After this screen has been displayed for 10 seconds and disappeared, all buttons become operable.
- This message will not be displayed again if you select [No] in response to the message “Do you want to display this message again?”.

### 3,000 hours or more

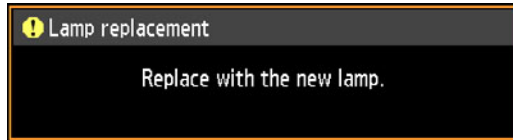

If a lamp replacement message is displayed, refer to “Lamp Replacement Procedure” (P165).

- Only the **POWER**, **OK**, **EXIT**, **FOCUS**, **ZOOM** and **SHIFT** buttons are available while this screen is displayed.
- When you press the **POWER** button, the “Push POWER button again to turn off power.” message appears.
- When this screen has disappeared after being displayed for 10 seconds, all buttons become operable.
- You can check the usage time of the lamp in [Lamp counter] in the [System settings] menu. (P118)
- This screen is not displayed when [Lamp warning display] is set to [Off]. (P111)
  - **Lamps are more likely to rupture once the lamp replacement message has been displayed. Replace the lamp with a new one as soon as possible.**
  - **Lamps should be replaced about every 3,000 hours. Note that there is no guarantee about how long lamps will last.**
  - **Useful life of lamps varies widely from lamp to lamp and depending on the environment of use. Some lamps may fail or rupture soon after they are first used.**
  - **Dispose of used lamps in accordance with local regulations.**



Caution

## Replacement Lamp

This projector uses the following lamps.

**Lamp part no.: RS-LP10**

Contact the Canon Customer Support Center when purchasing a replacement lamp.

### Precautions when replacing lamps that stop working

If the illumination suddenly stops when the projector is in use or after you turn it on, the lamp may be broken. In this case, never attempt to replace the lamp by yourself. Always request service from the Canon Customer Support Center. Additionally, with ceiling-mounted projectors, the lamp may fall out when you open the lamp cover or while you are attempting to replace it. During replacement, stand to the side of the lamp cover, not directly under it. If the lamp breaks and any glass shards or other pieces get in your eyes or mouth, consult a doctor immediately.





Caution

Before replacing the lamp, always turn off the projector, unplug it after the cooling fan stops, and wait at least one hour. Do not touch the lamp immediately after turning the projector off. It is very hot initially and poses a risk of burns.



Caution

- Be sure to use the specified lamp.
- Contact the Canon Customer Support Center for further information. This can also be purchased from the Canon website.
- Do not touch the inner glass surface when you replace the lamp. Doing so may cause deterioration to the projector's performance.
- Handle lamps with care. Impact or abrasion may cause lamps to rupture while they are in use. If a lamp ruptures, contact the Canon Customer Support Center and follow the instructions in "Precautions when replacing lamps that stop working" (P15).
- When replacing the lamp, do not remove any screws other than those specified.

## Lamp Replacement Procedure

Replace the lamp as follows.

- 1** Turn off the projector power and remove the power plug.
- 2** Loosen the lamp cover screw.

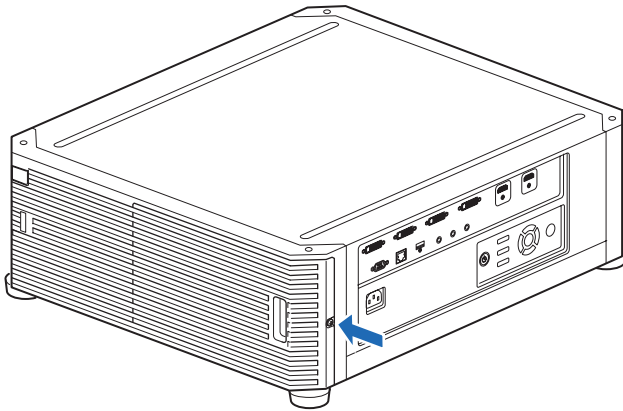

- 3** Hook your finger around the lamp cover handle, and open the cover in the direction of the arrow.

The lamp cover screw is attached to the lamp cover to prevent it from falling off.

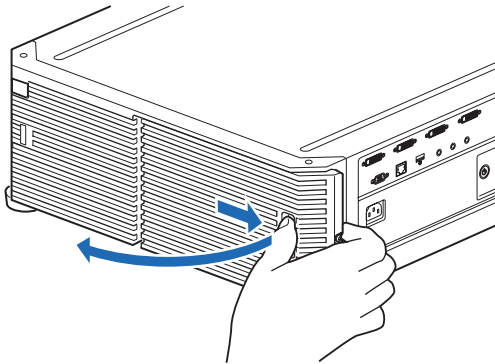

- 4** Loosen the 3 screws on the inside of the lamp unit, and then slowly pull out the lamp unit in the direction of the arrow. Even when the screws are loosened, they will remain attached to the lamp unit.

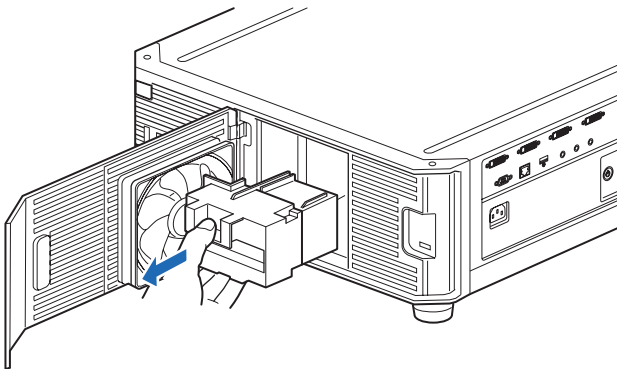
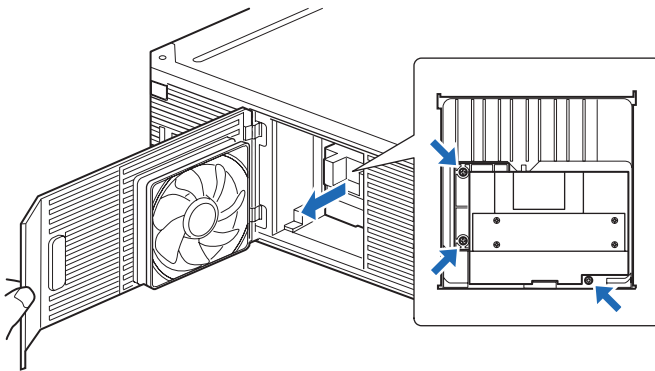

- 5** Insert the new lamp unit all the way in, and secure it with the 3 screws.
- 6** Close the lamp cover and tighten the screw.

- 7 Turn on the power. Bring up the menu and select [System settings] > [Other settings] > [Lamp counter].

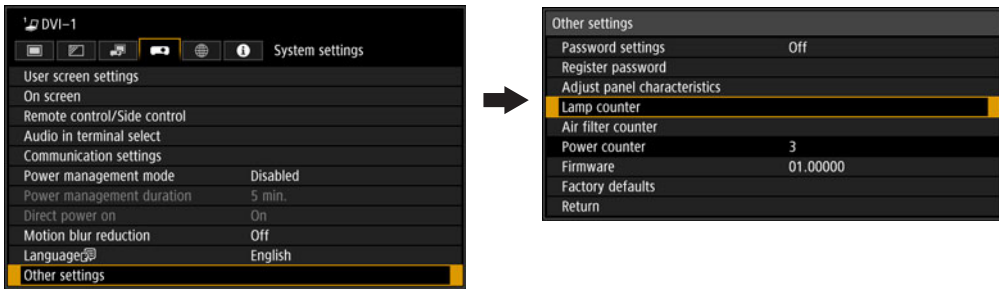

- 8 Select [Reset] - [Yes] to reset the lamp counter.

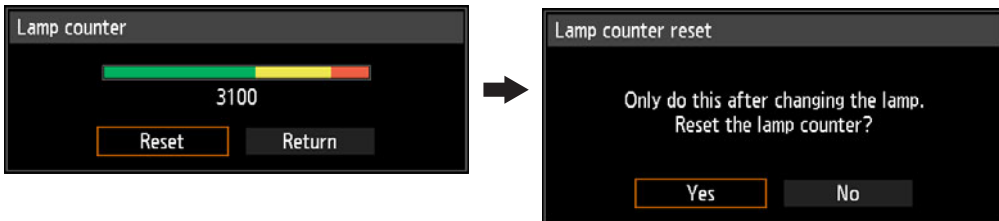

- We recommend cleaning or replacing the air filter (part no.: RS-FL03) when you replace the lamp.
- To order air filters, contact the Canon Customer Support Center.

## Displayed Test Patterns

To access the test pattern menu, from the [Install settings] menu, select [Test pattern] (P107) > [On], or press the **TEST PATTERN** button on the remote control. While the test pattern is displayed, you can use the [▲] / [▼] buttons to switch patterns. Also, if there is an option pattern available, you can use the [◀] / [▶] buttons to switch pattern.

The following test patterns can be displayed.

Use [▲] / [▼] to switch patterns

Use [◀] / [▶] to switch option patterns

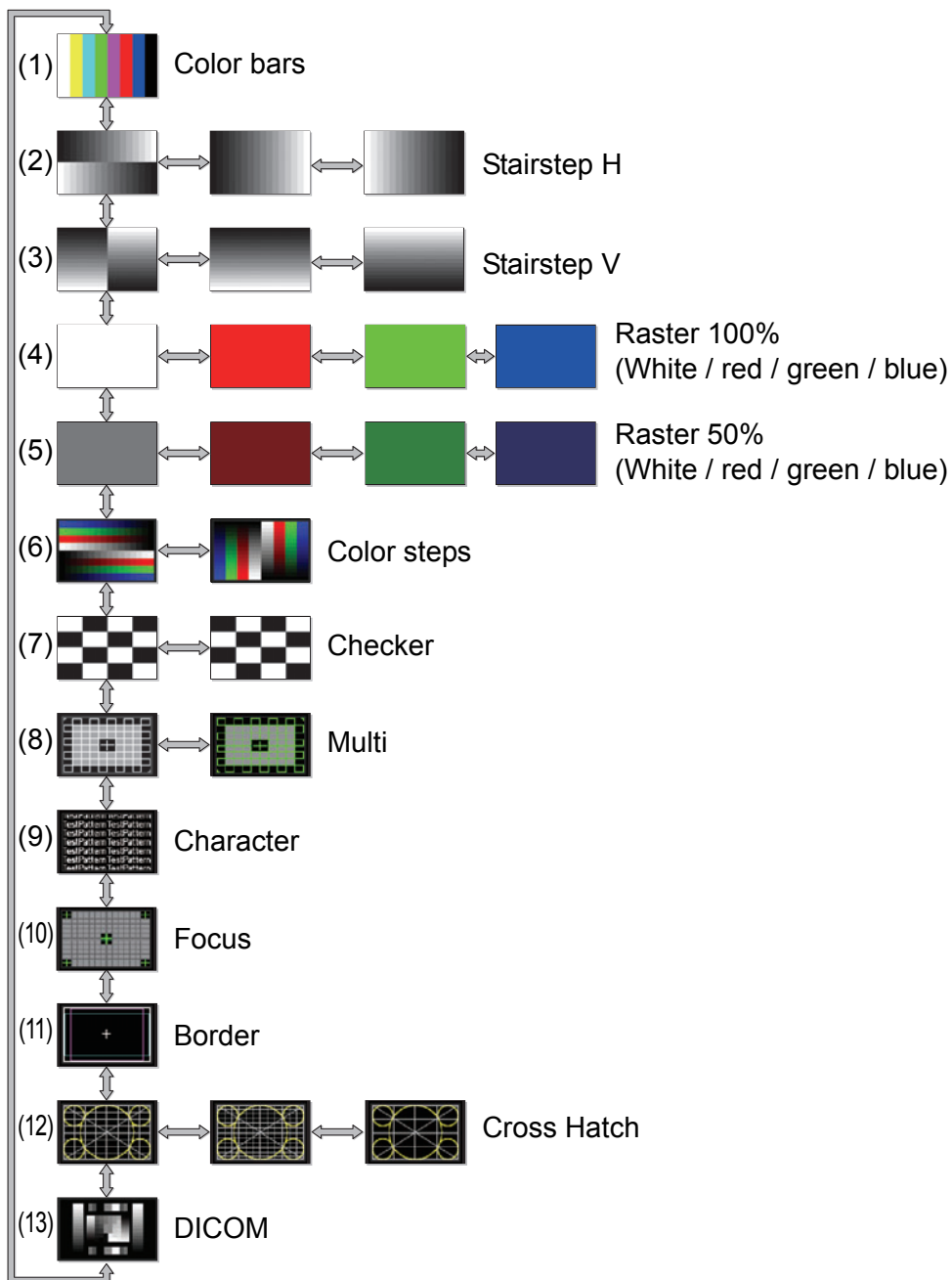



# Supported Signal Types

This projector supports the following signal types.

If your computer or AV equipment is compatible with any of these signals, the projector will determine the type of input signal automatically to project the image correctly.

## HDMI (single)



Signal resolution	Horizontal frequency [kHz]	Vertical frequency [Hz]	Dot clock [MHz]	HDMI multi input mode	Horizontal blanking interval FP*1, SW*2, BP*3	Vertical blanking interval FP*1, SW*2, BP*3
640x480	31.469	59.940	25.175	Normal, Single	16, 96, 48	10, 2, 33
720x480	31.469	59.940	27.000	Normal, Single	16, 62, 60	9, 6, 30
720x576	31.250	50.000	27.000	Normal, Single	12, 64, 68	5, 5, 39
800x600	37.879	60.317	40.000	Normal, Single	40, 128, 88	1, 4, 23
1280x720	18.000	24.000	59.400	Normal, Single	1760, 40, 220	5, 5, 20
	37.500	50.000	74.250	Normal, Single	440, 40, 220	5, 5, 20
	45.000	60.000	74.250	Normal, Single	110, 40, 220	5, 5, 20
1024x768	48.363	60.004	65.000	Normal, Single	24, 136, 160	3, 6, 29
1366x768	47.712	59.790	85.500	Single	70, 143, 213	3, 3, 24
	48.000	60.000	72.000		14, 56, 64	1, 3, 28
1440x900	55.469	59.901	88.750	Normal, Single	48, 32, 80	3, 6, 17
	55.935	59.887	106.500	Normal, Single	80, 152, 232	3, 6, 25
1280x1024	63.981	60.020	108.000	Normal, Single	48, 112, 248	1, 3, 38
1920x1080(l)	28.125	50.000	74.250	Normal, Single	528, 44, 148	4.5, 10, 30.5
	31.250	50.000	72.000		32, 168, 184	45.5, 10, 114.5
	33.750	60.000	74.250	Normal, Single	88, 44, 148	4.5, 10, 30.5
1920x1080	27.000	24.000	74.250	Normal, Single	638, 44, 148	4, 5, 36
	56.250	50.000	148.500	Normal, Single	528, 44, 148	4, 5, 36
	67.500	60.000	148.500	Normal, Single	88, 44, 148	4, 5, 36
2048x1080	66.576	59.924	147.000	Normal, Single	48, 32, 80	3, 10, 18
	67.500	60.000	148.500	Normal, Single	44, 44, 64	4, 5, 36
2560x1080	26.400	24.000	99.000	Normal, Single	998, 44, 148	4, 5, 11
	56.250	50.000	185.625	Normal, Single	548, 44, 148	4, 5, 36
	66.636	59.978	181.250		48, 32, 80	3, 10, 18
	66.000	60.000	198.000	Normal, Single	248, 44, 148	4, 5, 11
1920x1200	74.038	59.950	154.000	Normal, Single	48, 32, 80	3, 6, 26
	74.556	59.885	193.250	Normal, Single	136, 200, 336	3, 6, 36
2048x1200	74.049	59.959	163.500	Normal, Single	48, 32, 80	3, 10, 22
2560x1440	88.787	59.951	241.500	Single	48, 32, 80	3, 5, 33
2560x1600	98.713	59.972	268.500	Normal, Single	48, 32, 80	3, 6, 37
3840x2160	52.593	23.993	266.750		216, 400, 616	3, 5, 24
	52.438	23.999	209.750		48, 32, 80	3, 5, 17
	54.000	24.000	297.000	Normal, Single	1276, 88, 296	8, 10, 72
	56.250	25.000	297.000	Normal, Single	1056, 88, 296	8, 10, 72
	67.500	30.000	297.000	Normal, Single	176, 88, 296	8, 10, 72
4096x2160	52.561	23.979	284.250		224, 432, 656	3, 10, 19
	52.397	23.980	223.000		48, 32, 80	3, 10, 12
	54.000	24.000	297.000	Normal, Single	1020, 88, 296	8, 10, 72

When you apply the settings in the HDMI multi input mode column, formats in corresponding rows are identified in the EDID. No information is provided in the EDID for fields that are blank, so the computer output format must be configured manually.

# Product Specifications

## HDMI 1x2

1	2
---	---

Combined multi input resolution	Resolution at each input terminal	Horizontal frequency [kHz]	Vertical frequency [Hz]	Dot clock [MHz]	HDMI multi input mode	Horizontal blanking interval FP* <sup>1</sup> , SW* <sup>2</sup> , BP* <sup>3</sup>	Vertical blanking interval FP* <sup>1</sup> , SW* <sup>2</sup> , BP* <sup>3</sup>
1280x480	640x480	31.469	59.940	25.175	Normal, 1x2	16, 96, 48	10, 2, 33
1440x480	720x480	31.469	59.940	27.000	Normal, 1x2	16, 62, 60	9, 6, 30
1440x576	720x576	31.250	50.000	27.000	Normal, 1x2	12, 64, 68	5, 5, 39
2560x720	1280x720	37.500	50.000	74.250	Normal, 1x2	440, 40, 220	5, 5, 20
		45.000	60.000	74.250	Normal, 1x2	110, 40, 220	5, 5, 20
3840x1080	1920x1080(I)	28.125	50.000	74.250	Normal, 1x2	528, 44, 148	4.5, 10, 30.5
		33.750	60.000	74.250	Normal, 1x2	88, 44, 148	4.5, 10, 30.5
3840x1080	1920x1080	67.500	60.000	148.500	Normal, 1x2	88, 44, 148	4, 5, 36
2560x1600	1280x1600	98.611	59.910	142.000	1x2	48, 32, 80	3, 10, 33
3840x2160	1920x2160	52.512	23.956	132.750		104, 200, 304	3, 10, 19
		52.404	23.983	109.000		48, 32, 80	3, 10, 12
		54.000	24.000	148.500	1x2* <sup>5</sup>	638, 44, 148	8, 10, 72
		112.500	50.000	297.000	1x2	528, 44, 148	8, 10, 72
		133.293	59.988	277.250		48, 32, 80	3, 10, 49
		135.000	60.000	297.000	Normal, 1x2	88, 44, 148	8, 10, 72
4096x2160	2048x2160	133.320	60.000	266.640		8, 32, 40	48, 8, 6
		52.515	23.957	142.000		112, 216, 328	3, 10, 19
		52.423	23.992	115.750		48, 32, 80	3, 10, 12
		54.000	24.000	148.500	1x2	510, 44, 148	8, 10, 72
		112.500	50.000	297.000	1x2	484, 44, 64	8, 10, 72
		133.265	59.975	294.250		48, 32, 80	3, 10, 49
3200x2400	1600x2400	133.320	60.000	283.704		8, 32, 40	48, 8, 6
		135.000	60.000	297.000	Normal, 1x2	44, 44, 64	8, 10, 72
		260.500	59.948	260.500	1x2* <sup>4</sup>	48, 32, 80	3, 10, 56
3840x2400	1920x2400	148.140	60.000	296.280		8, 32, 40	55, 8, 6

When you apply the settings in the HDMI multi input mode column, formats in corresponding rows are identified in the EDID. No information is provided in the EDID for fields that are blank, so the computer output format must be configured manually.



Colors may appear distorted when images are viewed from the side on some screens, but this does not indicate a problem with the projector. For best results, use a matte screen with a wide viewing angle.

DVI (single)



Signal resolution	Horizontal frequency [kHz]	Vertical frequency [Hz]	Dot clock [MHz]	DVI multi input mode	Horizontal blanking interval FP*1, SW*2, BP*3	Vertical blanking interval FP*1, SW*2, BP*3
640x480	31.469	59.940	25.175	Normal, Single	16, 96, 48	10, 2, 33
800x600	37.879	60.317	40.000	Normal, Single	40, 128, 88	1, 4, 23
1280x720	45.000	60.000	74.250	Normal, Single	110, 40, 220	5, 5, 20
1024x768	48.363	60.004	65.000	Normal, Single	24, 136, 160	3, 6, 29
1366x768	47.712	59.790	85.500	Single	70, 143, 213	3, 3, 24
	48.000	60.000	72.000		14, 56, 64	1, 3, 28
1440x900	55.469	59.901	88.750	Normal, Single	48, 32, 80	3, 6, 17
	55.935	59.887	106.500	Normal, Single	80, 152, 232	3, 6, 25
1280x1024	63.981	60.020	108.000	Normal, Single	48, 112, 248	1, 3, 38
1920x1080	27.000	24.000	74.250	Normal, Single	638, 44, 148	4, 5, 36
	67.500	60.000	148.500	Normal, Single	88, 44, 148	4, 5, 36
2048x1080	66.576	59.924	147.000		48, 32, 80	3, 10, 18
	67.500	60.000	148.500	Normal, Single	44, 44, 64	4, 5, 36
2560x1080	66.636	59.978	181.250		48, 32, 80	3, 10, 18
	66.000	60.000	198.000	Single	248, 44, 148	4, 5, 11
1920x1200	74.038	59.950	154.000	Normal, Single	48, 32, 80	3, 6, 26
	74.556	59.885	193.250	Normal, Single	136, 200, 336	3, 6, 36
2048x1200	74.049	59.959	163.500	Normal, Single	48, 32, 80	3, 10, 22
2560x1440	88.787	59.951	241.500	Single	48, 32, 80	3, 5, 33
3840x2160	52.438	23.999	209.750	Single	48, 32, 80	3, 5, 17
4096x2160	52.397	23.980	223.000		48, 32, 80	3, 10, 12

When you apply the settings in the DVI multi input mode column, formats in corresponding rows are identified in the EDID. No information is provided in the EDID for fields that are blank, so the computer output format must be configured manually.

DVI 1x2

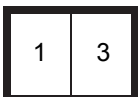

Combined multi input resolution	Resolution at each input terminal	Horizontal frequency [kHz]	Vertical frequency [Hz]	Dot clock [MHz]	DVI multi input mode	Horizontal blanking interval FP*1, SW*2, BP*3	Vertical blanking interval FP*1, SW*2, BP*3
2560x1080	1280x1080	66.493	59.850	95.750	1x2	48, 32, 80	3, 10, 18
2560x1440	1280x1440	88.715	59.902	127.750	1x2	48, 32, 80	3, 10, 28
2560x1600	1280x1600	98.611	59.910	142.000	Normal, 1x2	48, 32, 80	3, 10, 33
3840x2160	1920x2160	52.512	23.956	132.750		104, 200, 304	3, 10, 19
		52.404	23.983	109.000		48, 32, 80	3, 10, 12
		54.000	24.000	148.500	Normal*5, 1x2	638, 44, 148	8, 10, 72
4096x2160	2048x2160	52.515	23.957	142.000		112, 216, 328	3, 10, 19
		52.423	23.992	115.750		48, 32, 80	3, 10, 12
		54.000	24.000	148.500	Normal*5, 1x2	510, 44, 148	8, 10, 72

When you apply the settings in the DVI multi input mode column, formats in corresponding rows are identified in the EDID. No information is provided in the EDID for fields that are blank, so the computer output format must be configured manually.

## Product Specifications

### DVI 2x2

1	3
2	4

Combined multi input resolution	Resolution at each input terminal	Horizontal frequency [kHz]	Vertical frequency [Hz]	Dot clock [MHz]	DVI multi input mode	Horizontal blanking interval FP* <sup>1</sup> , SW* <sup>2</sup> , BP* <sup>3</sup>	Vertical blanking interval FP* <sup>1</sup> , SW* <sup>2</sup> , BP* <sup>3</sup>
3840x2160	1920x1080	27.000	24.000	74.250	Normal, 2x2	638, 44, 148	4, 5, 36
		66.587	59.934	138.500	Normal, 2x2	48, 32, 80	3, 5, 23
		67.158	59.963	173.000	Normal, 2x2	128, 200, 328	3, 5, 32
		67.500	60.000	148.500	Normal, 2x2	88, 44, 148	4, 5, 36
4096x2160	2048x1080	66.576	59.924	147.000	2x2	48, 32, 80	3, 10, 18
		67.160	59.964	183.750		128, 216, 344	3, 10, 27
		67.500	60.000	148.500	Normal, 2x2	44, 44, 64	4, 5, 36
4096x2304	2048x1152	70.992	59.909	156.750	Normal* <sup>4</sup> , 2x2* <sup>4</sup>	48, 32, 80	3, 5, 25
		71.584	59.903	197.000	Normal* <sup>4</sup> , 2x2* <sup>4</sup>	136, 216, 352	3, 5, 35
		72.000	60.000	162.000	Normal* <sup>4</sup> , 2x2* <sup>4</sup>	26, 80, 96	1, 3, 44
3200x2400	1600x1200	74.006	59.924	130.250	2x2* <sup>4</sup>	48, 32, 80	3, 4, 28
		75.000	60.000	162.000	2x2* <sup>4</sup>	64, 192, 304	1, 3, 46
3840x2400	1920x1200	74.556	59.885	193.250	Normal* <sup>4</sup> , 2x2* <sup>4</sup>	136, 200, 336	3, 6, 36
		74.038	59.950	154.000	Normal* <sup>4</sup> , 2x2* <sup>4</sup>	48, 32, 80	3, 6, 26
4096x2400	2048x1200	74.582	59.905	205.250		136, 216, 352	3, 10, 32
		74.049	59.959	163.500	Normal* <sup>4</sup> , 2x2* <sup>4</sup>	48, 32, 80	3, 10, 22

When you apply the settings in the DVI multi input mode column, formats in corresponding rows are identified in the EDID. No information is provided in the EDID for fields that are blank, so the computer output format must be configured manually.

DVI 1x4

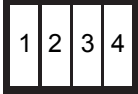

Combined multi input resolution	Resolution at each input terminal	Horizontal frequency [kHz]	Vertical frequency [Hz]	Dot clock [MHz]	DVI multi input mode	Horizontal blanking interval FP*1, SW*2, BP*3	Vertical blanking interval FP*1, SW*2, BP*3
3840x2160	960x2160	134.036	59.918	178.000		80, 104, 184	3, 10, 64
		133.259	59.973	149.250	1x4*5	48, 32, 80	3, 10, 49
		133.319	60.000	138.652		8, 32, 40	48, 8, 6
		135.000	60.000	148.500	Normal, 1x4	44, 22, 74	8, 10, 72
4096x2160	1024x2160	134.055	59.926	188.750		80, 112, 192	3, 10, 64
		133.235	59.962	157.750	1x4*5	48, 32, 80	3, 10, 49
		133.320	60.000	147.185		8, 32, 40	48, 8, 6
		135.000	60.000	148.500	Normal, 1x4	22, 22, 32	8, 10, 72
4096x2304	1024x2304	142.103	59.959	168.250	1x4*4	48, 32, 80	3, 10, 53
		143.111	59.979	201.500		80, 112, 192	3, 10, 69
		142.199	60.000	156.988	1x4*4	8, 32, 40	52, 8, 6
3840x2400	960x2400	147.991	59.940	165.750	1x4*4	48, 32, 80	3, 10, 56
		149.096	59.974	198.000		80, 104, 184	3, 10, 73
		148.139	60.000	154.065	Normal*4, 1x4*4	8, 32, 40	55, 8, 6
4096x2400	1024x2400	148.970	59.924	209.750		80, 112, 192	3, 10, 73
		148.015	59.949	175.250	1x4*4	48, 32, 80	3, 10, 56
		148.139	60.000	163.546	Normal*4, 1x4*4	8, 32, 40	55, 8, 6

When you apply the settings in the DVI multi input mode column, formats in corresponding rows are identified in the EDID. No information is provided in the EDID for fields that are blank, so the computer output format must be configured manually.

⚠ Colors may appear distorted when images are viewed from the side on some screens, but this does not indicate a problem with the projector. For best results, use a matte screen with a wide viewing angle.

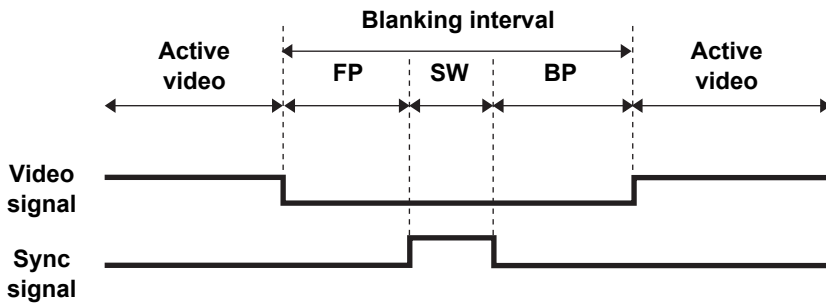

- \*1 FP: Front porch
- \*2 SW: Sync width
- \*3 BP: Back porch
- \*4 Only when [Panel drive mode] is set to [4096x2400].
- \*5 Only when [Panel drive mode] is set to [4096x2160].

# Specifications

## ■ Projector

Model name		4K500ST
Display system		RGB liquid crystal system: reflective (LCOS) : 3 panels
Optical system		Color separation by dichroic mirror / polarizing beam splitter and color composition by prism
Display device	Type / No. of panels	Reflective liquid crystal panel (LCOS) / 3 panels
	Size / Aspect ratio	0.76" / 15.36:9
	Drive system	Active matrix system
	Number dots / Total number dots	9,830,400 (4096 x 2400) x 3 panels / 29,491,200
Projection lens	Zoom ratio / Focal length / F value	1.3x / 17.2 – 22.3 mm / f2.6
	Zooming / Focus adjustment	Motorized / Motorized
	Lens shift	V: ±60% (motorized) H: ±10% (motorized)
Light source, power consumption		250-NSHA 400 W / 300 W (Lamp mode Full power / Power saver)
Image size (projection distance)		40" to 600" (0.9 m to 17.7 m / 3.0' to 58.1')
Number of colors		16,770,000 colors (full color)
Brightness*1*2 (in presentation mode)		5000 lumen
Contrast ratio*2		2500:1 (Fully white:fully black, presentation mode)
Ratio of brightness at periphery to center*2		88%
Audio output		monaural
Speaker		5W x 1
Maximum input resolution		4096 x 2400

Model name		4K500ST	
Video signals	HDMI input	HDMI (single)	640 x 480, 720 x 480, 720 x 576, 800 x 600, 1280 x 720, 1024 x 768, 1366 x 768, 1440 x 900, 1280 x 1024, 1920 x 1080, 2048 x 1080, 2560 x 1080, 1920 x 1200, 2048 x 1200, 2560 x 1440, 2560 x 1600, 3840 x 2160* <sup>3</sup> , 4096 x 2160* <sup>3</sup>
		HDMI 1 x 2	1280 x 480, 1440 x 480, 1440 x 576, 2560 x 720, 3840 x 1080, 2560 x 1600, 3840 x 2160, 4096 x 2160, 3200 x 2400* <sup>4</sup> , 3840 x 2400* <sup>5</sup>
	Digital PC input	DVI (single)	640 x 480, 800 x 600, 1280 x 720, 1024 x 768, 1366 x 768, 1440 x 900, 1280 x 1024, 1920 x 1080, 2048 x 1080, 2560 x 1080, 1920 x 1200, 2048 x 1200, 2560 x 1440, 3840 x 2160* <sup>3</sup> , 4096 x 2160* <sup>3*5</sup>
		DVI 1 x 2	2560 x 1080, 2560 x 1440, 2560 x 1600, 3840 x 2160* <sup>3</sup> , 4096 x 2160* <sup>3</sup>
		DVI 2 x 2	3840 x 2160, 4096 x 2160, 4096 x 2304* <sup>4</sup> , 3200 x 2400* <sup>4</sup> , 3840 x 2400* <sup>4</sup> , 4096 x 2400* <sup>4</sup>
		DVI 1 x 4	3840 x 2160, 4096 x 2160, 4096 x 2304* <sup>4</sup> , 3840 x 2400* <sup>4</sup> , 4096 x 2400* <sup>4</sup>
	Input terminal	DVI-D terminal	
HDMI terminal		Digital PC, Digital video	
LAN terminal		Network connection (RJ-45) 10BASE-T / 100BASE-TX / 1000BASE-T	
USB port		USB Type A	
CONTROL terminal		RS-232C (D-sub 9-pin)	
REMOTE terminal		Wired remote control (3.5ø stereo mini jack)	
AUDIO IN terminal		Audio signal (3.5ø stereo mini jack)	
AUDIO OUT terminal		Audio signal (3.5ø stereo mini jack)	
Input signal	Digital PC		TMDS (Transition Minimized Differential Signaling)
	Audio		Impedance = 47kΩ or more
Noise		39 / 34dB (Lamp mode: Full power/Power saver)	
Operating temperature		0°C (32°F) - 40°C (104°F)	
Power supply		AC100V - 240V 50 / 60Hz	
Power consumption	Full power		600W
	Power saver		470W
	Standby	Networking off	0.4W
Low-power networking on		0.8W	
Dimensions		470 mm (W) x 175 mm (H) x 533.5 mm (D) / 18.5 (W) x 6.9 (H) x 21.0 (D) in (including the projection)	
Mass		17.6 kg / 38.8 lbs	
Accessories		Remote control, remote control dry-cell batteries, power cord, lens cap, Important Information, User's Manual (CD-ROM) and Warranty Card	

## Product Specifications

- \*1 In full power lamp mode
- \*2 Compliance with ISO21118-2012
- \*3 Only low frequencies (24-30 Hz) supported
- \*4 Only supported when [Panel drive mode] is set to [4096x2400]
- \*5 EDID not supported
- \* 99.99% or more of the LCD panel pixels are effective. During projection, 0.01% or less of pixels may stay lit or unlit due to the characteristics of the LCD panel.
- \* Using the projector continuously for an extended period of time may accelerate the deterioration of optical parts.
- \* Product specifications and appearance are subject to change without notice.

## ■ Remote Control

Model number	RS-RC05
Power supply	DC 3.0V, using two AA-size batteries
Operating range	Approx. 8 m / 26.2' ±25° horizontal and vertical (to infrared remote receiver)
Dimensions	51 mm (W) x 28 mm (H) x 176 mm (D) / 2.0 (W) x 1.1 (H) x 6.9 (D) in
Weight	100 g / 3.5 oz

## ■ External View

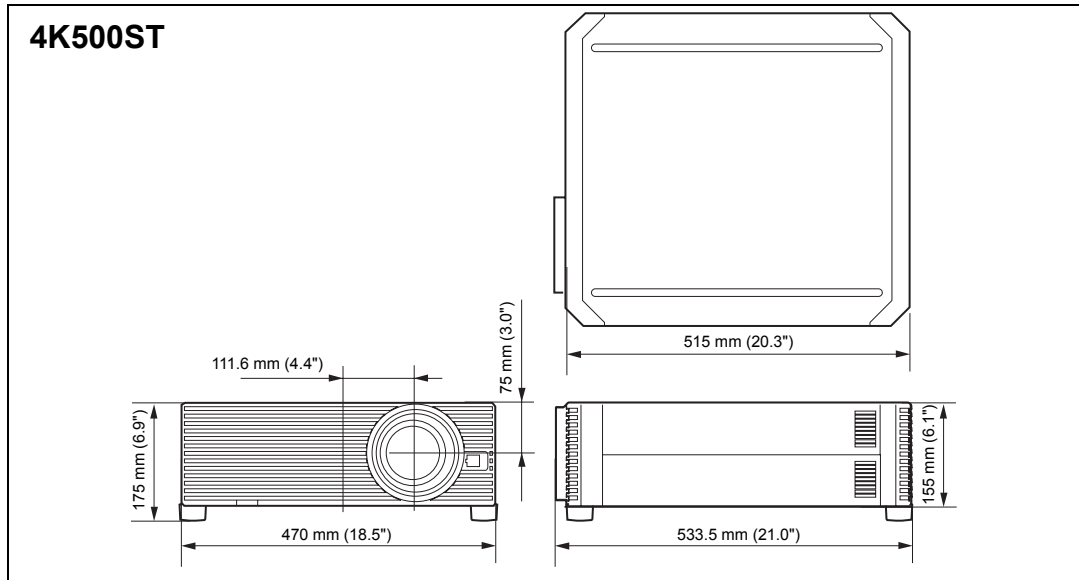



## ■ Service Port (CONTROL)

### Pin assignment

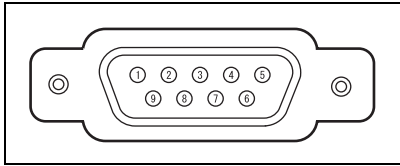

Pin No.	Signal
1	OPEN
2	RxD
3	TxD
4	OPEN
5	GND
6	OPEN
7	Internal pull-up
8	OPEN
9	OPEN

### Communication format

Communication mode : RS-232C, asynchronous, half-duplex communication

Communication speed : 19200bps

Character length : 8 bits

Stop bits : 2 bits

Parity : None

Flow control : None

## Main user commands

Commands		ASCII representation	Binary representation
Power supply	Power on	POWER=ON<CR>	50h 4Fh 57h 45h 52h 3Dh 4Fh 4Eh 0Dh
	Power off	POWER=OFF<CR>	50h 4Fh 57h 45h 52h 3Dh 4Fh 46h 46h 0Dh
Power status acquisition		GET=POWER<CR>	47h 45h 54h 3Dh 50h 4Fh 57h 45h 52h 0Dh
Input source	HDMI-1	INPUT=HDMI1<CR>	49h 4Eh 50h 55h 54h 3Dh 48h 44h 4Dh 49h 31h 0Dh
	HDMI-2	INPUT=HDMI2<CR>	49h 4Eh 50h 55h 54h 3Dh 48h 44h 4Dh 49h 32h 0Dh
	HDMI 1x2	INPUT=HDMI1X2<CR>	49h 4Eh 50h 55h 54h 3Dh 48h 44h 4Dh 49h 31h 58h 32h 0Dh
	DVI-1	INPUT=D-RGB1<CR>	49h 4Eh 50h 55h 54h 3Dh 44h 2Dh 52h 47h 42h 31h 0Dh
	DVI-2	INPUT=D-RGB2<CR>	49h 4Eh 50h 55h 54h 3Dh 44h 2Dh 52h 47h 42h 32h 0Dh
	DVI-3	INPUT=D-RGB3<CR>	49h 4Eh 50h 55h 54h 3Dh 44h 2Dh 52h 47h 42h 33h 0Dh
	DVI-4	INPUT=D-RGB4<CR>	49h 4Eh 50h 55h 54h 3Dh 44h 2Dh 52h 47h 42h 34h 0Dh
	DVI 1x2	INPUT=D-RGB1X2<CR>	49h 4Eh 50h 55h 54h 3Dh 44h 2Dh 52h 47h 42h 31h 58h 32h 0Dh
	DVI 2x2	INPUT=D-RGB2X2<CR>	49h 4Eh 50h 55h 54h 3Dh 44h 2Dh 52h 47h 42h 32h 58h 32h 0Dh
	DVI 1x4	INPUT=D-RGB1X4<CR>	49h 4Eh 50h 55h 54h 3Dh 44h 2Dh 52h 47h 42h 31h 58h 34h 0Dh
Input source acquisition		GET=INPUT<CR>	47h 45h 54h 3Dh 49h 4Eh 50h 55h 54h 0Dh
Image Mode	Standard	IMAGE=STANDARD<CR>	49h 4Dh 41h 47h 45h 3Dh 53h 54h 41h 4Eh 44h 41h 52h 44h 0Dh
	Presentation	IMAGE=PRESENTATION<CR>	49h 4Dh 41h 47h 45h 3Dh 50h 52h 45h 53h 45h 4Eh 54h 41h 54h 49h 4Fh 4Eh 0Dh
	Photo/sRGB	IMAGE=PHOTO_SRGB<CR>	49h 4Dh 41h 47h 45h 3Dh 50h 48h 4Fh 54h 4Fh 5Fh 53h 52h 47h 42h 0Dh
	DICOM SIM	IMAGE=DCM_SIM<CR>	49h 4Dh 41h 47h 45h 3Dh 44h 43h 4Dh 5Fh 53h 49h 4Dh 0Dh
	Dynamic	IMAGE=DYNAMIC<CR>	49h 4Dh 41h 47h 45h 3Dh 44h 59h 4Eh 41h 4Dh 49h 43h 0Dh
	Video	IMAGE=VIDEO<CR>	49h 4Dh 41h 47h 45h 3Dh 56h 49h 44h 45h 4Fh 0Dh
	User 1	IMAGE=USER_1<CR>	49h 4Dh 41h 47h 45h 3Dh 55h 53h 45h 52h 5Fh 31h 0Dh
	User 2	IMAGE=USER_2<CR>	49h 4Dh 41h 47h 45h 3Dh 55h 53h 45h 52h 5Fh 32h 0Dh
	User 3	IMAGE=USER_3<CR>	49h 4Dh 41h 47h 45h 3Dh 55h 53h 45h 52h 5Fh 33h 0Dh
Image mode acquisition		GET=IMAGE<CR>	47h 45h 54h 3Dh 49h 4Dh 41h 47h 45h 0Dh
Brightness	Brightness value setting	BRI=<value>CR	42h 52h 49h 3Dh <numeric code> 0Dh

Commands		ASCII representation	Binary representation
Brightness acquisition		GET=BRI<CR>	47h 45h 54h 3Dh 42h 52h 49h 0Dh
Sharpness	Sharpness value setting	SHARP=<value><CR>	53h 48h 41h 52h 50h 3Dh <numeric code> 0Dh
Sharpness acquisition		GET=SHARP<CR>	47h 45h 54h 3Dh 53h 48h 41h 52h 50h 0Dh
Contrast	Contrast value setting	CONT=<value><CR>	43h 4Fh 4Eh 54h 3Dh <numeric code> 0Dh
Contrast acquisition		GET=CONT<CR>	47h 45h 54h 3Dh 43h 4Fh 4Eh 54h 0Dh
Aspect	Auto	ASPECT=AUTO<CR>	41h 53h 50h 45h 43h 54h 3Dh 41h 55h 54h 4Fh 0Dh
	True size	ASPECT=TRUE<CR>	41h 53h 50h 45h 43h 54h 3Dh 54h 52h 55h 45h 0Dh
Aspect value acquisition		GET=ASPECT<CR>	47h 45h 54h 3Dh 41h 53h 50h 45h 43h 54h 0Dh
Lamp mode	Full power	LAMP=FULL<CR>	4Ch 41h 4Dh 50h 3Dh 46h 55h 4Ch 4Ch 0Dh
	Power saver	LAMP=ECO<CR>	4Ch 41h 4Dh 50h 3Dh 45h 43h 4Fh 0Dh
Lamp mode value acquisition		GET=LAMP<CR>	47h 45h 54h 3Dh 4Ch 41h 4Dh 50h 0Dh
Blank	Blank On	BLANK=ON<CR>	42h 4Ch 41h 4Eh 4Bh 3Dh 4Fh 4Eh 0Dh
	Blank Off	BLANK=OFF<CR>	42h 4Ch 41h 4Eh 4Bh 3Dh 4Fh 46h 46h 0Dh
Blank acquisition		GET=BLANK<CR>	47h 45h 54h 3Dh 42h 4Ch 41h 4Eh 4Bh 0Dh

## LED Indicator Details

When there is a problem with the projector, the LED indicator on the side of the projector illuminates or flashes continuously after the projector is turned off.

- Wait until the cooling fan stops and disconnect the power plug from the electrical outlet before dealing with the problem.

LED indicator status	Meaning	Cause and countermeasure
WARNING and TEMP are lit.	Temperature abnormality	The temperature inside the projector is too high for some reason or the outside air temperature is higher than the operating range. If the problem is inside the projector, check whether the projector is installed and operating normally, unplug the projector from the power outlet to cool down the projector interior and then restart projection. If the air intake or exhaust vent is blocked, remove the obstacle. If the air filter is clogged, clean or replace it. (P160, P161) If the same warning occurs again, there may be a malfunction in the projector. Contact the Canon Customer Support Center.
WARNING and LAMP are lit.	Faulty lamp	The lamp does not illuminate. If the lamp does not illuminate, replace it. If the same warning occurs again, there may be a malfunction in the lamp drive circuit. Contact the Canon Customer Support Center.
WARNING (only) flashes 3 times repeatedly.	Filter error	The air filter is not installed. Check whether or not the air filter is installed correctly. Contact the Canon Customer Support Center if the same warning occurs again.
WARNING flashes 3 times, LAMP is lit.	Faulty lamp cover	The lamp cover is open. Unplug the projector from the power outlet, then install the lamp cover correctly and turn on the projector again. If the lamp cover has been installed properly, there may be a malfunction in the lamp cover detection switch. Contact the Canon Customer Support Center.
WARNING (only) flashes 4 times repeatedly.	Faulty cooling fan	There may be a malfunction in the cooling fan or another component. Unplug the projector from the electrical outlet, then plug it back into the outlet and turn on the projector again. Contact the Canon Customer Support Center if the same warning occurs again.

LED indicator status	Meaning	Cause and countermeasure
WARNING (only) flashes 5 times repeatedly.	Faulty power supply	Abnormal voltage is applied to some parts in the power supply or another failure may have occurred. Unplug the projector from the electrical outlet, then plug it back into the outlet and turn on the projector again. Contact the Canon Customer Support Center if the same warning occurs again.

## Symptoms and Solutions

### ■ You Cannot Turn on the Projector

Cause	Countermeasure
The power cord is not connected correctly.	Check whether the power cord is connected correctly. (P59)
The power cord has just been connected.	Wait at least one second after plugging the projector in until you press the <b>POWER</b> button. You cannot turn the projector on immediately after plugging it in. (P60)
The lamp cover is open.	Unplug the projector from the power outlet, then install the lamp cover correctly and turn on the projector again.
The safety device is activated because the air intake or the exhaust vent is blocked and the internal temperature of the projector has increased.	When the safety device is active, the [POWER] indicator does not turn on when you connect the power cord. You cannot disable this safety device. Remove any obstacle that is blocking the air intake or exhaust vent and contact the Canon Customer Support Center.
The air filter is not installed correctly.	Check whether the air filter is installed correctly. (P161)
Key lock is enabled.	Check that Key lock (P112) is not enabled for the projector or the remote control.

## ■ You Cannot Project an Image from the Projector

Cause	Countermeasure
A cable is not connected correctly.	Check whether the projector is connected to the computer or AV equipment correctly. (P53 - P54)
20 seconds have not elapsed since the projector was turned on.	When the projector is turned on, the opening window is displayed for approximately 20 seconds. To project an image immediately, press the <b>OK</b> button on the remote control or side control. (P26, P30)
No image is sent from the AV equipment.	Check whether an image is played on the connected video camcorder, DVD, etc.
Connection with the input terminal has not been performed correctly.	Check whether the AV equipment is connected to the projector input terminal correctly. (P29)
No input signal type has been selected for the connected AV equipment.	Check that the same input signal has been correctly selected for the connected AV equipment from the [INPUT] menu. (P63)
The input signal type is incorrect.	Check whether the selected input signal type is correct. (P63, P169)
The BLANK function has been selected.	Press the <b>BLANK</b> button on the remote control. (P80)
No image is projected due to a problem with the computer.	Turn first the projector and then the computer off and then back on again.
The external monitor output is not set on the notebook computer correctly.	Turn on the external monitor output on the notebook computer. To turn on the external monitor output, press the [LCD] or [VGA] function key or a key with an icon for the external monitor, while holding down the [Fn] key on the keyboard of the notebook computer. With Windows 8.1 / Windows 8 / Windows 7, you can turn on image output by holding down the Windows logo key and pressing the [P] key. (P62) The combination of keys used to perform this operation varies depending on the model of notebook computer. For more detailed information, refer to the manual that came with your computer.
The displayed image is not the same as that displayed on the computer.	Check whether the dual screen (multi-display) mode is selected on the computer. If dual screen mode is selected, change the computer display output to mirroring mode. The output setting method varies among computer manufacturers. For more detailed information, refer to the manual that came with your computer.

## ■ There is no Sound

Cause	Countermeasure
The audio cable is not connected correctly.	Check the audio cable connection. (P53, P54)
The MUTE function is enabled.	Press the <b>MUTE</b> button on the remote control. (P31)
The volume level is adjusted to the minimum.	Press the <b>VOL</b> button on the remote control or the <b>VOL+</b> button on the side control to adjust the volume level. (P26, P31)
An audio cable with a built-in resistor is used.	Use an audio cable without a built-in resistor.
Audio in terminal select is [Off].	Change the Audio In terminal to the appropriate setting. (P113)

## ■ The Projected Image Is Blurred

Cause	Countermeasure
The image is out of focus.	Adjust the focus. (P67)
The distance to the screen is too short.	Check whether the distance to the screen is appropriate. (P50)
The projector is not placed straight in front of the screen.	Check whether the projector is placed obliquely to the screen. A slight error in the projection angle can be corrected through the keystone adjustment function. (P73)
The projector has been moved to a place where the temperature varies a lot.	When the projector is moved from a location where the temperature is low to a location where the temperature is high, condensation may form on the lens. The condensation will evaporate after a period of time and the projector will be able to project a normal image.
The lens is stained.	Clean the lens. (P160)
Video is blurred.	Activate motion blur reduction. (P115)
Motion blur reduction is not available.	Motion blur reduction is not available in DICOM SIM image mode.

## ■ You Cannot Project an Image Appropriately

Cause	Countermeasure
The projected image is inverted in the vertical or horizontal direction.	The ceiling mounted / rear projection setting is incorrect. Check the [Image flip H/V] setting in the [Install settings] menu. (P98)
A computer cable is used in which some pins are not connected.	Use a computer cable in which all pins are connected.

## ■ The Projector Power Turns Off

Cause	Countermeasure
The air intake or exhaust vent is blocked.	Check whether the air intake or exhaust vent is blocked. If the air intake or exhaust vent is blocked, the temperature inside the projector will increase and the power is automatically turned off to protect the projector. (The [WARNING] indicator and [TEMP] indicator are lit.) Wait until the projector temperature drops, then make sure that the intake and exhaust vents are not blocked and turn on the projector. (P25, P60)
The air filter is dirty.	Check whether the air filter is clogged with dust. If the air filter is clogged, clean or replace the air filter. (P160, P161)
The lamp has ruptured (or there is a lamp malfunction).	If the lamp has ruptured, follow the instructions in “Precautions when replacing lamps that stop working” (P15).
The operating temperature is inappropriate.	Check whether the operating temperature is between 0°C (32°F) and 40°C (104°F). (P18) Projector settings must be adjusted when using the projector at altitudes of 2,300 m (7,545.8') or higher. In the [Install settings] menu, set [High altitude] under [Professional settings] to [On]. (P102)

## ■ The Projector Cannot Join the Network

Cause	Countermeasure
The LAN cable (shielded twisted pair) is not connected correctly.	Check whether the LAN cable (shielded twisted pair) is connected to the projector correctly. (P122)
The projector has not been on long enough (less than about 40 seconds).	Network connections are not available until about 40 seconds after startup. Wait at least 40 seconds, and then try to connect again. (P132)



## ■ You Cannot Operate the Remote Control

Cause	Countermeasure
Batteries are not installed properly or they have run out.	Check whether batteries are installed correctly. If batteries are installed correctly, replace them with new batteries. (P32)
You are operating the remote control from the outside of the remote control operating range.	Check whether you are operating the remote control within the remote control operating range of the main unit of the projector. (P33)
There is an obstacle between the projector and the remote control.	Remove the obstacle between the infrared remote receiver of the main unit of the projector and the remote control or point the remote control in an obstacle-free path.
You are operating the remote control in an unsuitable operating environment.	Check whether the infrared remote receiver of the main unit of the projector is exposed to direct sunlight or strong light of lighting apparatus. (P33)
The channel setting of the remote control does not match the setting of the projector.	Check whether the channel setting of the remote control has been changed. You can check the [Remote control channel] setting in the [System settings] menu. (P113)
The key lock function is preventing operation of the remote control.	Check whether [Key lock] is enabled to disable the remote control operation. In the [System settings] menu, set [Key lock] to [Off]. (P112)

## Numerics

6-axis color adjust ..... 95

## A

Adjusting keystone distortion ..... 73

Air filter ..... 161

Ambient light ..... 94

AMX Device Discovery ..... 129

ASPECT ..... 72

Aspect ..... 72

AUDIO IN terminal ..... 29

AUDIO OUT terminal ..... 29

Auto (Aspect) ..... 72

## B

BLANK ..... 80

Brightness ..... 92

## C

Ceiling mounted ..... 37, 98

Contrast ..... 92

Corner Adjustment ..... 74

Crestron RoomView ..... 129

## D

Digital PC / DVI-D terminal ..... 29

Direct power on ..... 115

Display resolution (Preparing the  
computer) ..... 65

Dynamic gamma ..... 95

## E

Edge blending ..... 4, 103, 149

Effect of ambient light ..... 94

## F

FREEZE ..... 80

## G

Gamma ..... 92

## H

HDMI terminal ..... 29, 53, 54

## I

IMAGE ..... 77

Image adjustment ..... 84, 90

Image mode (Image quality) ..... 76

Information ..... 84, 148

INPUT ..... 63

Input signal select ..... 63

Input terminal ..... 29

    Connecting to AV equipment ..... 54

## K

Key lock ..... 112

KEystone ..... 73

Keystone ..... 73

## L

Lamp mode ..... 96

Lamp replacement ..... 163, 165

LAN port ..... 29

Language ..... 116

LED indicator ..... 27, 180

Lens shift ..... 51, 70

Logo display ..... 109

## M

Memory color correction ..... 95

MENU ..... 84

Menu ..... 84

Multi input ..... 55, 99

**N**

- Network password ..... 124
- Network settings ..... 84, 122
- Noise reduction ..... 94

**O**

- OK ..... 26, 30
- Optical zoom ..... 68

**P**

- Password ..... 117, 118
- PJLink ..... 128, 142
- POWER ..... 60, 79
- Power-Saving Settings ..... 81
- Projecting from Multiple Projectors at  
Once (Edge Blending) ..... 149
- Projector on ..... 109

**R**

- Rear projection ..... 37, 98
- Remote control ..... 30, 31, 32, 113
- Reset ..... 75, 96, 120

**S**

- Screen color ..... 106
- Selecting a language ..... 61, 116
- Setting display status ..... 87
- Sharpness ..... 92
- Side control ..... 26
- Signal type ..... 169
- Super white ..... 88
- System settings ..... 84, 108

**T**

- Test pattern ..... 168
- True size (Aspect) ..... 72
- Turning on external monitor output  
(preparing the notebook computer)  
..... 62

**U**

- USB Port ..... 29

**W**

- WARNING indicator ..... 27, 180

# Option

- Ceiling attachment  
Part No.: RS-CL15
- Ceiling-mount pipe  
(400 - 600 mm / 15.7 - 23.6 in)  
Part No.: RS-CL08\*
- Ceiling-mount pipe  
(600 - 1000 mm / 23.6 - 39.4 in)  
Part No.: RS-CL09\*
- Air filter  
Part No.: RS-FL03
- Lamp assembly with replacement air  
filter  
Part No.: RS-LP10F
- Remote control  
Part No.: RS-RC05
- Remote control  
Part No.: RS-RC04

\* Use the above materials to hang the projector from the ceiling.



**CANON INC.**

30-2, Shimomaruko 3-chome, Ohta-ku, Tokyo 146-8501, Japan

**CANON U.S.A. INC.**

One Canon Park, Melville, New York 11747, U.S.A.

For all inquires concerning this product, call toll free in the U.S. 1-800-OK-CANON

**CANON EUROPE LTD.**

3 The Square, Stockley Park, Uxbridge, Middlesex, UB11 1ET United Kingdom

**CANON EUROPA N.V.**

Bovenkerkerweg 59, 1185 XB Amstelveen, The Netherlands