



ST430K, ST550K, ST650K
Digital Signage
User Manual



Disclaimer

BenQ Corporation makes no representations or warranties, either expressed or implied, with respect to the contents of this document. BenQ Corporation reserves the right to revise this publication and to make changes from time to time in the contents thereof without obligation to notify any person of such revision or changes.

Copyright

Copyright 2016 BenQ Corporation. All rights reserved. No part of this publication may be reproduced, transmitted, transcribed, stored in a retrieval system or translated into any language or computer language, in any form or by any means, electronic, mechanical, magnetic, optical, chemical, manual or otherwise, without the prior written permission of BenQ Corporation.

Table of Contents

Safety warnings and precautions	5
Important safety instructions	6
Notes on the LCD panel of this display	6
Safety notice for remote control	7
Battery safety notice	7
BenQ ecoFACTS	8
Package contents	9
Setting up the display	10
Mounting the display	10
Installing the desktop stands (ST550K)	10
Setting up the display (ST430K, ST650K)	11
Installing the display on a wall	12
Parts of the display and their functions	14
Rear panel	14
Input/output terminals	16
Input/output terminals	18
Remote control	21
Using the remote control	23
Connection	25
Connecting audio/video signals	25
Connecting power	28
Basic operations	30
Turning the display on or off	30
Switching input signals	32
Adjusting audio volume level	32
Setting up Internet connection	32
Updating software	33
The OSD (On-Screen Display) menu	34
OSD menu overview	34

- Operations in the OSD menu..... 35
- Picture** menu..... 36
- Sound** menu..... 37
- Setting** menu..... 38
- Multimedia operation 40
 - Multimedia buttons on the remote control 40
 - Viewing files..... 41
- Working with Android OS..... 45
 - About All Apps..... 46
 - Browser 47
 - X-Sign 48
 - ES File Explorer 49
 - Multimedia 50
 - Settings 52
 - WPS Office..... 53
- Product information..... 54
 - Specifications..... 54
 - Dimensions..... 56
 - Supported input signal resolution 59
- Troubleshooting..... 61

Safety warnings and precautions



The lightning flash with arrowhead symbol, within an equilateral triangle, is intended to alert the user to the presence of uninsulated “dangerous voltage” within the product’s enclosure that may be of sufficient magnitude to constitute a risk of electric shock to persons.



The exclamation point within an equilateral triangle is intended to alert the user to the presence of important operating and maintenance (servicing) instructions in the literature accompanying the appliance.

THIS EQUIPMENT MUST BE GROUNDED

To ensure safe operation, the three-pin plug must be inserted only into a standard three-pin power outlet which is effectively grounded through normal household wiring. Extension cords used with the equipment must have three cores and be correctly wired to provide connection to the ground. Wrongly wired extension cords are a major cause of fatalities.

The fact that the equipment operates satisfactorily does not imply that the power outlet is grounded or that the installation is completely safe. For your safety, if you are in any doubt about the effective grounding of the power outlet, please consult a qualified electrician.

- The mains plug of the power supply cord shall remain readily operable. The AC receptacle (mains socket outlet) shall be installed near the equipment and shall be easily accessible. To completely disconnect this equipment from the AC mains, disconnect the power cord plug from the AC receptacle.
- Do not place this display on an uneven, sloping or unstable surface (such as a trolley) where it may fall and cause damage to itself or others.
- Do not place this display near water, like a spa or pool, or in a position which will allow the splashing or spraying of water onto the display, like in front of an open window where rain water may enter.
- Do not install this display in a confined space without proper ventilation and air circulation, such as in a closed cabinet. Allow proper space around the display for dissipating heat inside. Do not block any openings and vents on the display. Overheating may result in hazards and electric shock.
- Installation of this display should only be performed by a qualified technician. Failure to install this display properly may cause injuries and damages to the personnels and the display itself. Check the installation regularly and maintain the display periodically to ensure the best working condition.
- Use only the accessories approved or recommended by the manufacturer to mount this display. Using wrong or unsuitable accessories may cause the display to fall and result in serious personal injuries. Make sure that the surface and fixing points are strong enough to sustain the weight of the display.
- To reduce the risk of electric shock, do not remove covers. No user serviceable parts inside. Refer servicing to qualified service personnel.
- To prevent personal injuries, mounting the display or installing desktop stands is required before use.

Important safety instructions

1. Read these instructions.
2. Keep these instructions.
3. Heed all warnings.
4. Follow all instructions.
5. Do not use this apparatus near water.
6. Clean only with dry cloth.
7. Do not block any ventilation openings. Install in accordance with the manufacturer's instructions.
8. Do not install near any heat sources such as radiators, heat registers, stoves, or other apparatus (including amplifiers) that produce heat.
9. Do not defeat the safety purpose of the polarized or grounding-type plug. A polarized plug has two blades with one wider than the other. A grounding-type plug has two blades and a third grounding prong. The wide blade or the third prong are provided for your safety. If the provided plug does not fit into your outlet, consult an electrician for replacement of the obsolete outlet.
10. Protect the power cord from being walked on or pinched particularly at plugs, convenience receptacles, and the point where they exit from the apparatus.
11. Only use attachments/accessories specified by the manufacturer.
12. Use only with the cart, stand, tripod, bracket, or table specified by the manufacturer, or sold with the apparatus. When a cart is used, use caution when moving the cart/apparatus combination to avoid injury from tip-over.
13. Unplug this apparatus during lightning storms or when unused for long periods of time.
14. Refer all servicing to qualified service personnel. Servicing is required when the apparatus has been damaged in any way, such as power-supply cord or plug is damaged, liquid has been spilled or objects have fallen into the apparatus, the apparatus has been exposed to rain or moisture, does not operate normally, or has been dropped.



Notes on the LCD panel of this display

- The Liquid Crystal Display (LCD) panel of this display has a very thin protective layer of glass which is liable to marking or scratching, and cracking if struck or pressured. The liquid crystal substrate is also liable to damage under excessive force or extreme temperatures. Please handle with care.
- The response time and brightness of the LCD panel may vary with the ambient temperature.
- Avoid placing the display in direct sun or where direct sun or spot lighting will shine onto the LCD panel, as the heat may damage the panel and the external casing of the display, and the bright light will make viewing the display more difficult than necessary.
- The LCD panel consists of individual pixels to display images and is manufactured according to the design specifications. While 99.9% of these pixels work normally, 0.01% of the pixels may remain constantly lit (in red, blue or green) or unlit. This is a technical limitation of the LCD technology and is not a defect.

- LCD screens, like plasma (PDP) and conventional CRT (Cathode Ray Tube) screens, are also susceptible to 'screen burn-in' or 'image retention' which can be found on the screen as visible fixed lines and shades. To avoid such damage to the screen, avoid displaying still images (like On-Screen Display menus, TV station logos, fixed/inactive text or icons) for more than 30 minutes. Change the aspect ratio from time to time. Fill the entire screen with the image and eliminate the black bars whenever possible. Avoid displaying images in 4:3 aspect ratio over a long period of time, otherwise there may be visible burn marks on the screen as two vertical lines.

Note: Under certain circumstances, condensation may occur on the inner side of the cover glass, it's a natural phenomenon and will not affect the operation of the display. This condensation will usually disappear after around 2 hours of normal operation.

- ST series does not offer image retention function, for more information, please refer to installation guide.
- ST650K does not support portrait use; portrait use may cause display damage. BenQ warranty will not cover faulty usage.
- For ST series, when the power goes out unexpectedly, please make sure the time zone is correctly synced via the Internet, otherwise manual adjustment is needed.

Safety notice for remote control

- Do not put the remote control in the direct heat, humidity, and avoid fire.
- Do not drop the remote control.
- Do not expose the remote control to water or moisture. Failure to do so could result in malfunction.
- Confirm there is no object between the remote control and the remote sensor of the product.
- When the remote control will not be used for an extended period, remove the batteries.

Battery safety notice

The use of the wrong type of batteries may cause chemical leaks or explosion. Please note the following:

- Always ensure that the batteries are inserted with the positive and negative terminals in the correct direction as shown in the battery compartment.
- Different types of batteries have different characteristics. Do not mix different types.
- Do not mix old and new batteries. Mixing old and new batteries will shorten battery life or cause chemical leaks from the old batteries.
- When batteries fail to function, replace them immediately.
- Chemicals which leak from batteries may cause skin irritation. If any chemical matter seeps out of the batteries, wipe it up immediately using a dry cloth, and replace the batteries as soon as possible.
- Due to varying storage conditions, the battery life for the batteries included with your product may be shortened. Replace them within 3 months or as soon as you can after initial use.
- There may be local restrictions on the disposal or recycling of batteries. Consult your local regulations or waste disposal provider.

BenQ ecoFACTS

BenQ has been dedicated to the design and development of greener product as part of its aspiration to realize the ideal of the “Bringing Enjoyment 'N Quality to Life” corporate vision with the ultimate goal to achieve a low-carbon society. Besides meeting international regulatory requirement and standards pertaining to environmental management, BenQ has spared no efforts in pushing our initiatives further to incorporate life cycle design in the aspects of material selection, manufacturing, packaging, transportation, using and disposal of the products. BenQ ecoFACTS label lists key eco-friendly design highlights of each product, hoping to ensure that consumers make informed green choices at purchase. Check out BenQ's CSR Website at <http://csr.BenQ.com/> for more details on BenQ's environmental commitments and achievements.



CLASS II equipment

~ AC voltage

Package contents

Open the sales package and check the contents. If any item is missing or damaged, please contact your dealer immediately.



LCD display



Power cord x 1

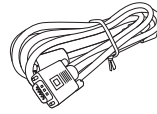

VGA cable x 1



Remote control

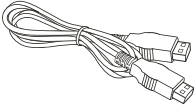

HDMI cable x 1

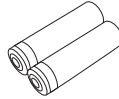

AAA battery x 2



Quick start guide

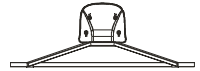

Base x 1 (ST550K)



Base x 1 (ST430K,
ST650K)

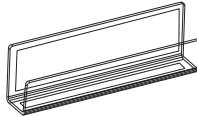

Q-cast dongle holder



- The type of power cord supplied may differ from that illustrated depending on your region of purchase.
- Before discarding the package, check that you haven't left any accessories inside the box.
- Dispose of packaging materials wisely. You can recycle the cardboard carton. Consider storing the package (if possible) for future transport of the display.
- Do not leave plastic bags within reach of young children or babies.

Setting up the display

Mounting the display

You can install the display on a vertical surface with a suitable wall mounting bracket or on a horizontal surface with the optional desktop stands. Please pay attention to the following notes during installation:

- This display should be installed by at least two adult persons. Attempting to install this display by only one person may result in danger and injuries.
- Refer the installation to qualified technicians. Improper installation may cause the display to fall or malfunction.

Installing the desktop stands (ST550K)

1. Lock the metal support and the iron base tightly with 4 pieces of $\Phi 5 \times 7$ mm flat-head machine screws until all the screw holes are aligned.
2. Make base pad holes and the screw center aligned and stick them on the metal support. Be sure to distinguish the installation direction of the right and left base pads.
3. Lock the base and the base support with 4 pieces of $\Phi 4 \times (10 + 8)$ mm H-head machine screws.
4. Lock the whole base module on the back cover of the machine with 4 pieces of $\Phi 4 \times 16$ mm B-head machine screws.

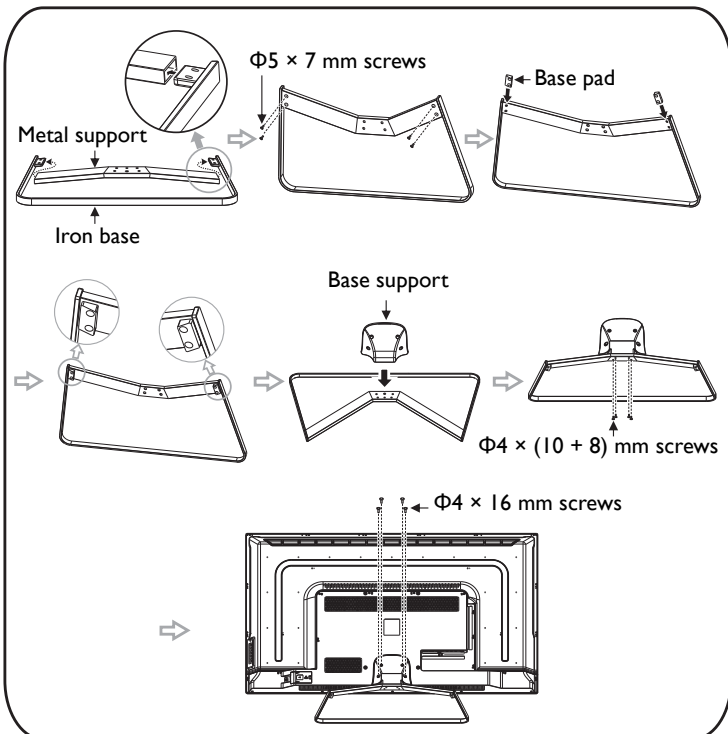

Setting up the display (ST430K, ST650K)

Item checklist

Please check if the following items are completed:

1. The supporting components for base
2. Four $\Phi 5 \times 20\text{mm}$ P head black zinc plated machine screw with spring washer
3. An installation instruction



There could be slight difference in appearance among different models in the same series. The actual product shall prevail.

Installation Steps

1. Take out the signage, the base/stand, and accessories from the carton.
2. Put the machine flat on the table first. Install the base on the back cover of the machine bottom following the arrow direction. (Fig. 1)
3. Make the positioning hole on the top of the V neck of the base aligned with the positioning raised stand on the bottom of the machine back cover. (Fig. 1)
4. Fasten the four $\Phi 5 \times 20\text{mm}$ screws. The base has to be adjusted at the figure status, otherwise it cannot be installed. (Fig. 2)

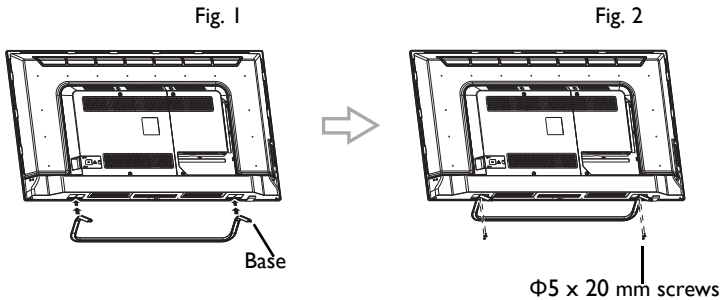

Installing the display on a wall

VESA Standard: 200 x 300 mm (4 holes)

1. Place a clean, dry and lint-free cloth on a flat, horizontal and object-free surface. Make sure that the size of the cloth is larger than the display.
2. Gently lay the display on the cloth with the LCD screen facing down.
3. Remove the desktop stands from the display if installed.
4. Identify the wall mounting screw holes on the back of the display as shown in the illustration.

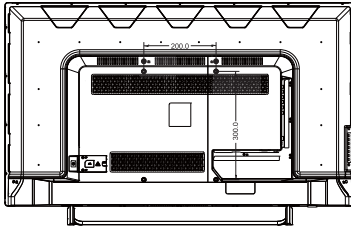

ST430K

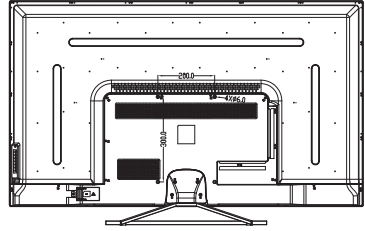

ST550K

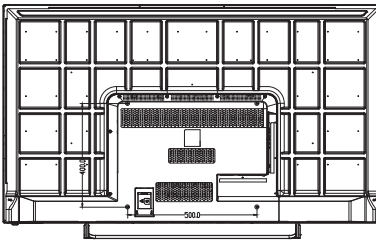

ST650K

5. Install the wall mounting bracket on the display and attach the display to the wall according to the mounting bracket's instructions. The length of the screw should exceed the thickness of the wall mounting bracket, please refer to below chart for each model. Make sure that all screws are tightened and secured properly. (Recommended torque: 16 (+2/-2) kgf/cm). The mounting means should be strong enough to bear the weight of the display.

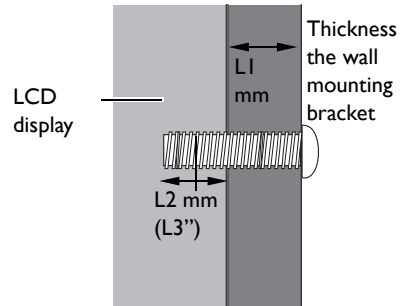

Model	L2 mm	L3"	Screw Length
ST430K	TOP: 25mm BOT: 10mm	TOP: 0.98" BOT: 0.4"	TOP: L1+25mm BOT: L1+10mm
ST550K	10mm	0.4"	L1+10mm
ST650K	25mm	0.98"	L1+25mm



- To maintain proper ventilation, keep at least 10 mm of clear space from the back cover of the display to the wall.
- Please consult a professional technician for wall mount installations. The manufacturer accepts no liability for installations not performed by a professional technician.

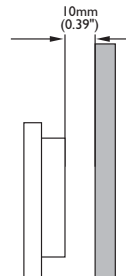

Parts of the display and their functions

Rear panel

ST430K

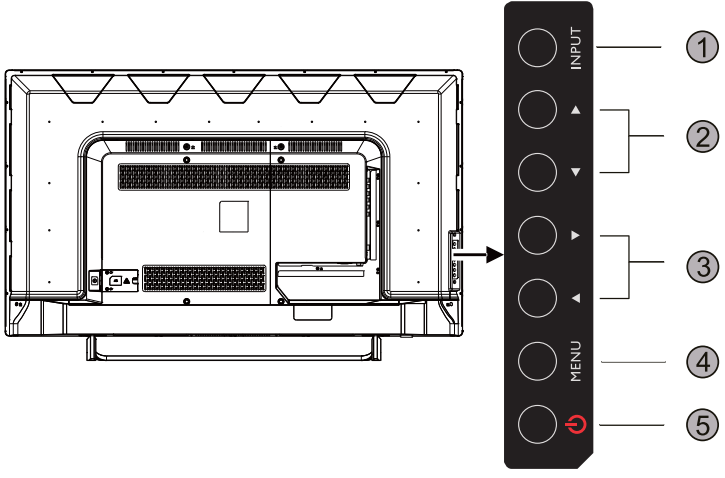

ST550K

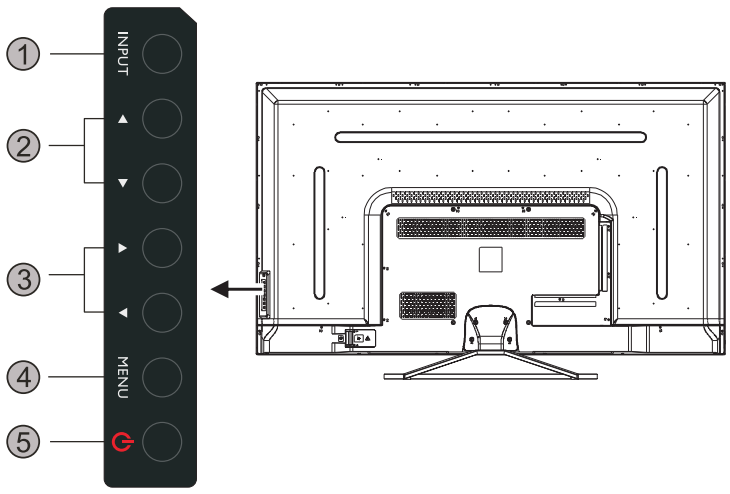

ST650K

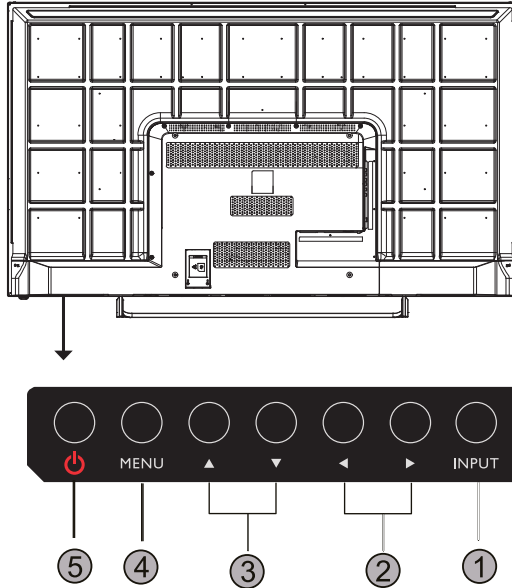

No.	Name	Description
1	INPUT	<ul style="list-style-type: none"> • Select/confirm options in On-Screen Display (OSD) menu. • Select input sources.
2	▲/▼	Scroll through settings and options in the OSD menu.
3	▶/◀	<ul style="list-style-type: none"> • Scroll through settings and options in the OSD menu. • Hot keys for audio volume adjustment.
4	MENU	Open or close the OSD menu.
5	⏻	Turn the display on or off.

Input/output terminals

ST430K

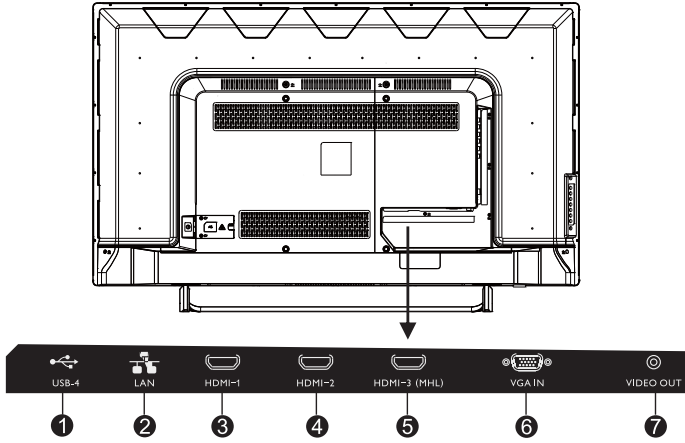

ST550K

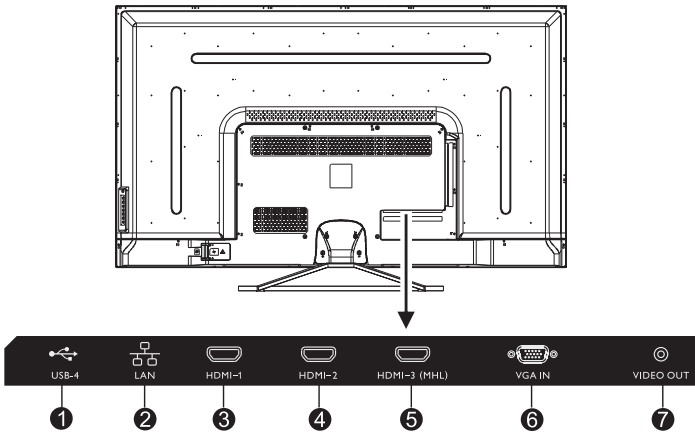

ST650K

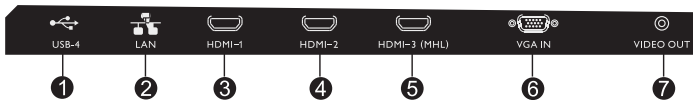
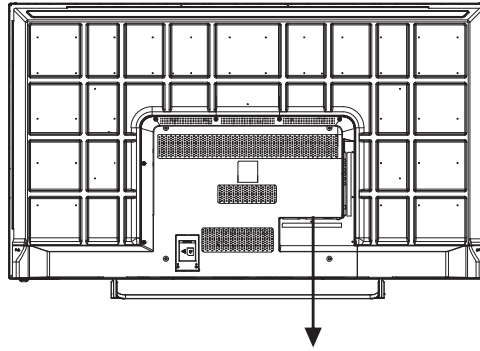

No.	Name	Description
1	USB-4	Access multimedia files on USB drives directly.
2	LAN	Receive the control signals from LAN interface /a computer, connecting RJ45 terminals (This network port is only used for the closed Android OS on this product).
3	HDMI 1	Receive 4K2K 30Hz supported signals from an external device.
4	HDMI 2	Receive 4K2K 30Hz supported signals from an external device.
5	HDMI 3(MHL)	4K2K 30Hz / MHL supported An interface which connects the handset devices and the display.
6	VGA IN	Receive analog RGB signals from an external device (such as a computer).
7	VIDEO OUT	Output composite video signals to another display.

Input/output terminals

ST430K

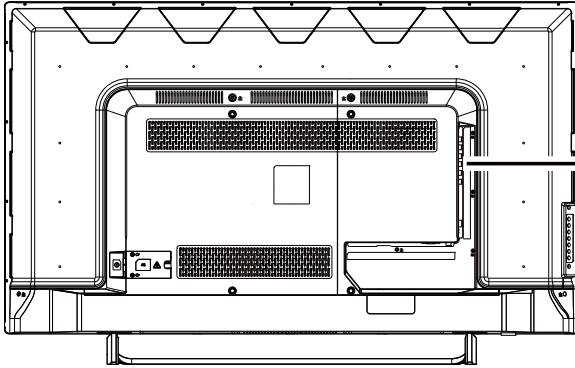

1

COAXIAL
O

2

AUDIO IN
R
L

3

COMPONENT
Pb/Cb
Y (VIDEO)

4

USB-3

5

USB-2 (3.0)

6

USB-1

7

AUDIO OUT
O

ST550K

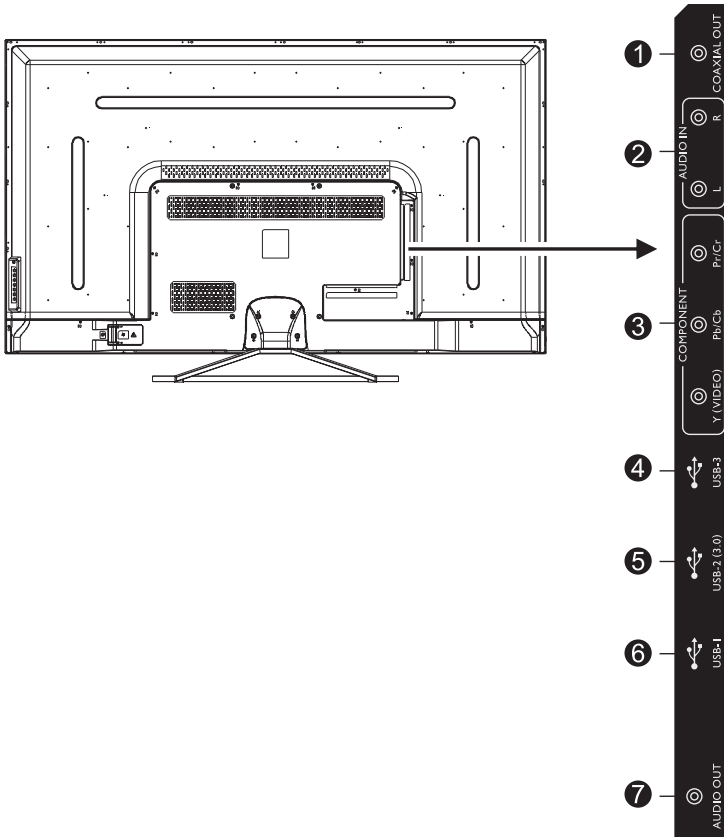

ST650K

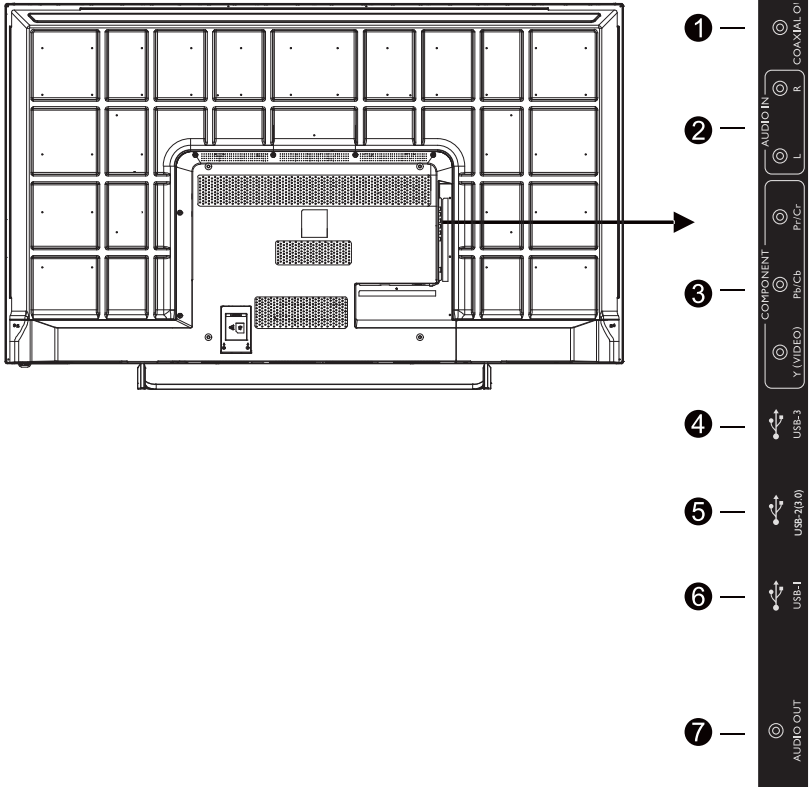

No.	Name	Description
1	COAXIAL OUT	Output digital audio signals via a coaxial cable to an external device.
2	AUDIO IN	Receive audio signals from an external device.
3	COMPONENT (YPbPr)	Receive component video signals from an external device.
4	USB 3	Access multimedia files on USB drives directly.
5	USB 2(3.0)	Access multimedia files on USB drives directly. Note: • The users cannot use the USB port to update the software. • The USB ports only support FAT / FAT32 format.
6	USB 1	Access multimedia files on USB drives directly.
7	AUDIO OUT	Output audio signals to an external device.

Remote control

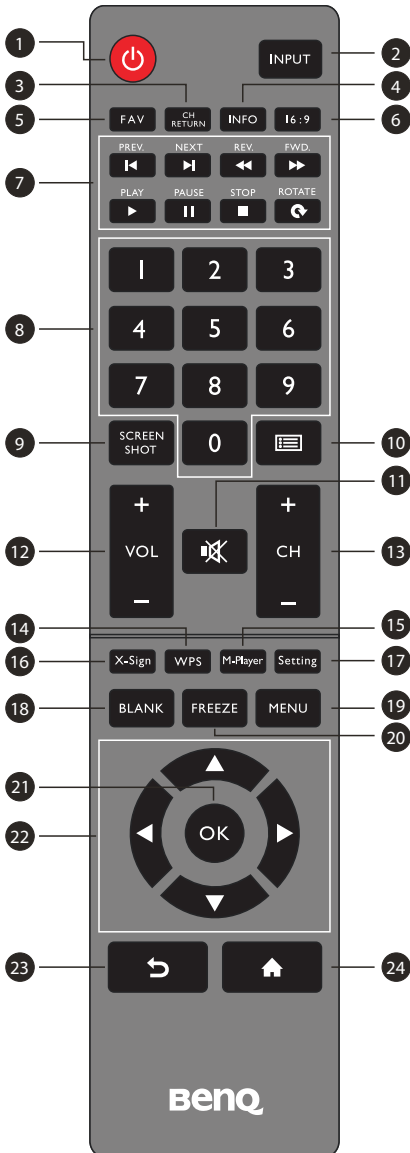

1 POWER

Turn the display on or off.

2 INPUT

Select the input source.

3 CH RETURN

TV Channel return

Note: It is only working on some specific regions.

4 INFO

Show the information of the current input source.

5 FAV

Favorite TV program

Note: It is only working on some specific regions.

6 16:9

Change the display image to the different mode under non-Android system Mode: Full, 4:3, Film, Subtitle, PC mode.

7 MULTI-MEDIA buttons

The buttons are used to operate the media functions under Multi-Media APP.

8 Numeric buttons (0-9)

Press to enter numbers.

9 SCREEN SHOT

Capture the printed screen and save to the USB drive.

10 CHLIST (≡)

Delete a character / view program list.

Note: It is only working on some specific regions.

11 MUTE

Turn on/off the sound.

12 VOL- / VOL+

Turn up/down the volume.

13 CH+ / CH-

Change program channels.

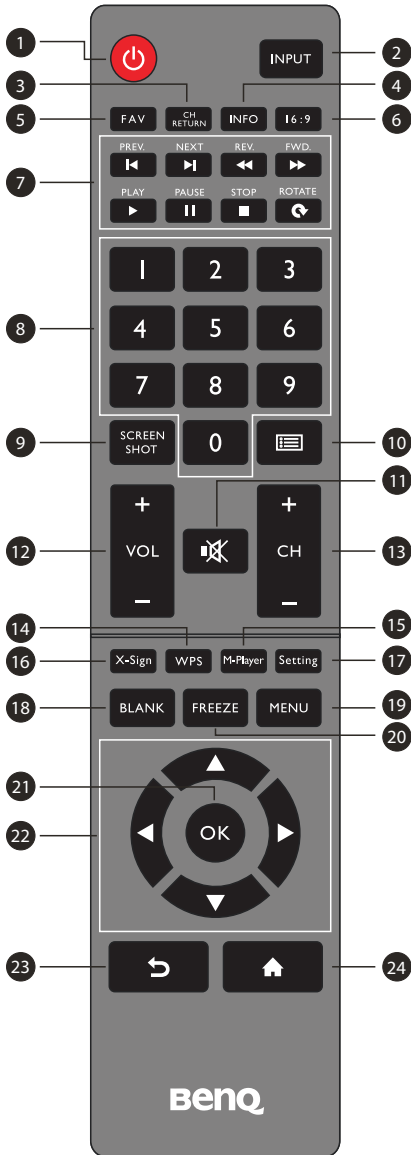

14 WPS

Open the WPS office app in Android

15 M-Player

Open the Media Player app in Android.

16 X-Sign

Open the X-Sign app in Android.

17 Setting

Open the setting function in Android.

18 BLANK

Blank and mute the screen (the screen will turn black) when the OSD menu is off. Press again to resume.

19 MENU

Activate the OSD menu.

20 FREEZE

Freeze the screen.

21 OK

Confirm the selected options or save changes.

22 CURSOR KEYS (◀/▶/▲/▼)

Scroll through settings and options in the OSD menu.

23 BACK (↶)

Press this key to return to previous page.

24 HOME (🏠)

Show the main screen of Android system.

Using the remote control

Installing remote control batteries

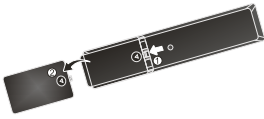

1. Open the remote control battery compartment cover.

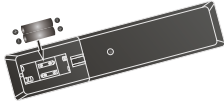

2. Insert the supplied batteries ensuring that the positive and negative marked battery terminals match the (+) and (-) marks in the battery compartment.



The supplied batteries are provided for your convenience so that you can operate the display straight away. You should replace them as soon as possible.



3. Refit the battery compartment cover.
-

Remote control usage tips

- Point and aim the top front of the remote control directly at the display's remote control sensor window when you press the buttons.
- Do not let the remote control become wet or place it in humid environments (like bathrooms).
- If the display's remote control sensor window is exposed to direct sunlight or strong light, the remote control may not operate properly. In this situation, change the light source, readjust the angle of the display or operate the remote control from a location closer to the display's remote control sensor window.

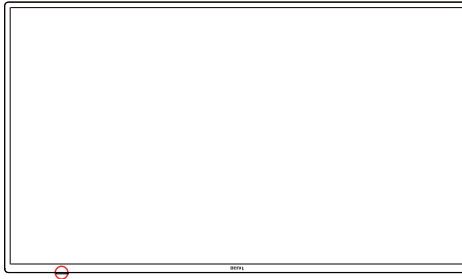

ST430K

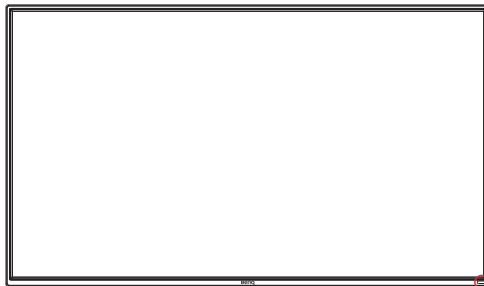
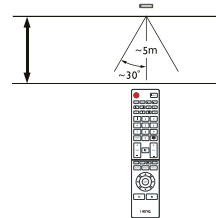

ST550K/ST650K

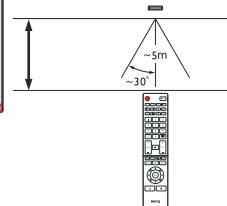

Keypad/remote control lock SOP

- Press and hold **CH+** on remote control: Enable/Disable keypad function.
- Press and hold **CH-** on remote control: Enable/Disable remote control function.

Connection

Connecting audio/video signals

Pay attention to the following notes when you connect cables:

- Please turn off all devices.
- Familiarize yourself with the audio/video ports on the display and the devices you want to use. Be aware that incorrect connections may adversely affect picture quality.
- Do not remove cables from the ports by pulling the cable itself. Always grasp and pull the connectors at the end of the cable.
- Ensure that all cables are fully inserted and firmly seated.

Connecting the VGA input

1. Connect the **VGA** jack on the display to the VGA output jack on a computer using a D-Sub (15-pin) cable.
2. To view images from this input, press the **INPUT** button and choose **VGA**.

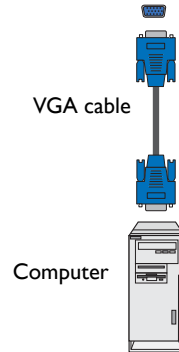

Connecting the digital inputs

1. Connect the HDMI output jack of a computer or A/V device (such as a VCR or DVD player) to the **HDMI 1** input jack on the display using an HDMI cable.
2. To view a video image from this input, press the **INPUT** button and choose **HDMI 1**.

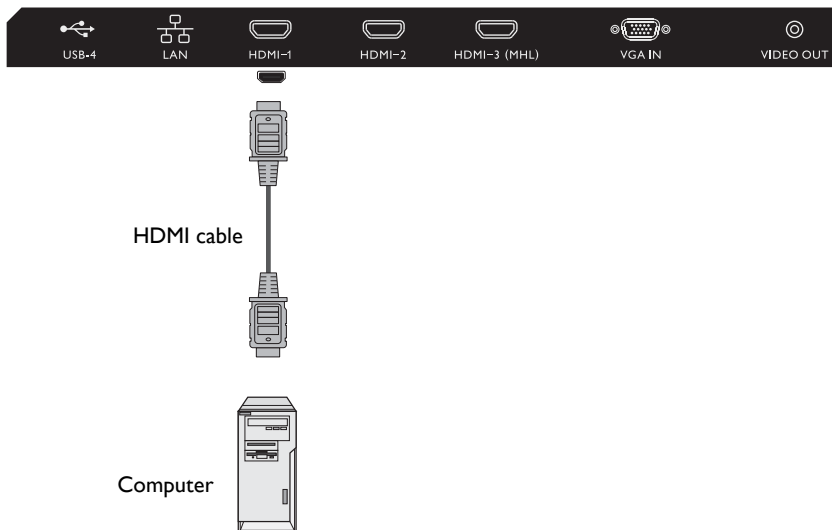

Connecting the YPbPr component video input

1. Connect the **YPbPr** jacks on the display to the component output jacks on an A/V device (such as a VCR or DVD player) using a component video cable.
2. Connect the DVD player's audio output jacks to the **L/R** jacks on the display using a suitable audio cable.
3. To view a video image from this input, press the **INPUT** button and choose **YPbPr**.

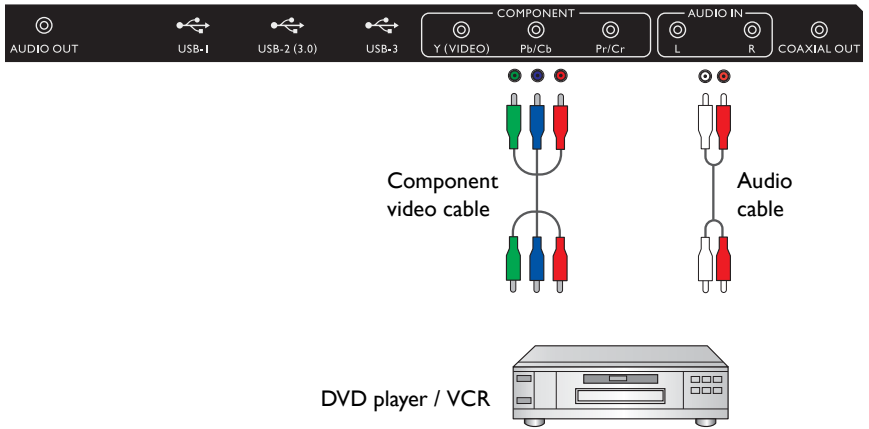

The cables are not supplied and should be purchased separately.

Connecting the multimedia inputs

To view multimedia files on the USB flash drive:

1. Plug the USB flash drive in the **USB** port.
2. When the users insert the **USB**, a notice will be popped up, which would lead the users to the Multi-media mode.

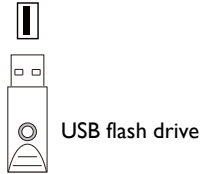

The USB ports can not be connected with the devices over 0.5A.

Connecting power

Plug one end of the power cord into the **Power** jack on the display and the other end into an appropriate power outlet (if the outlet is switched, turn on the switch).

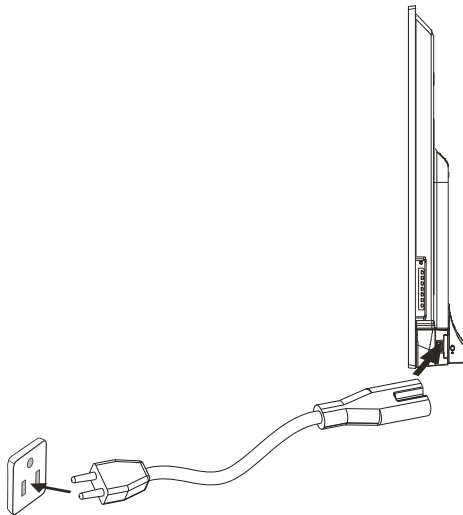

ST550K

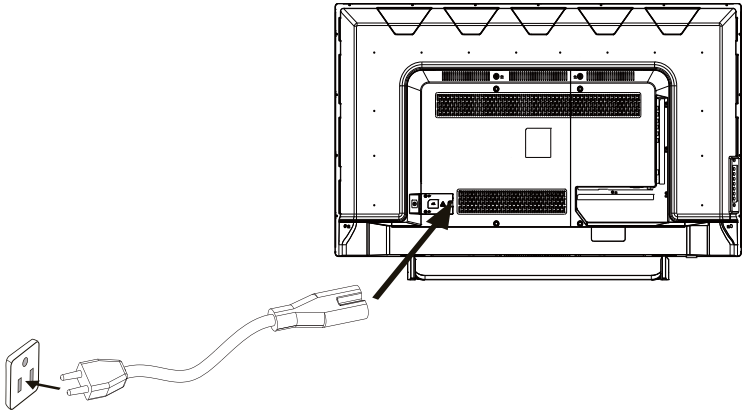

ST430K/ST650K



- The supplied power cord is suitable for use with 100-240V AC power only.
- The power cord and outlet illustrated may differ from the ones used in your region.
- Only use an appropriate power cord for your region. Never use a power cord which appears damaged or frayed, or change the plug type on the power cord.
- Be aware of the power loading when you use extension cords or multiple outlet power boards.
- There are no user serviceable parts in this display. Never unscrew or remove any covers. There are dangerous voltages inside the display. Turn off the power and unplug the power cord if you intend to move the display.

Basic operations

Turning the display on or off

ST430K

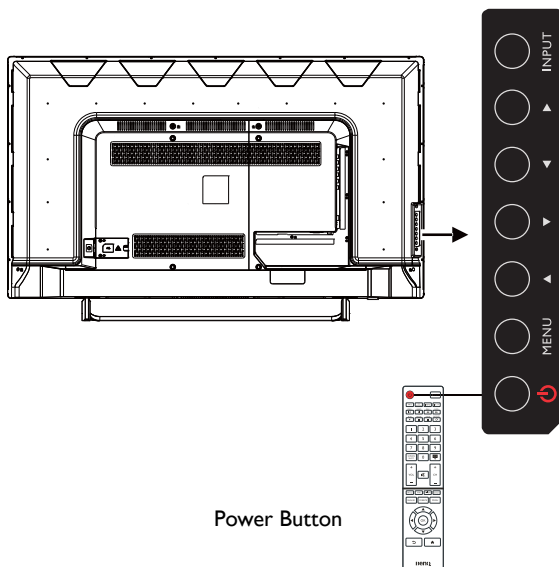

Power Button

ST550K

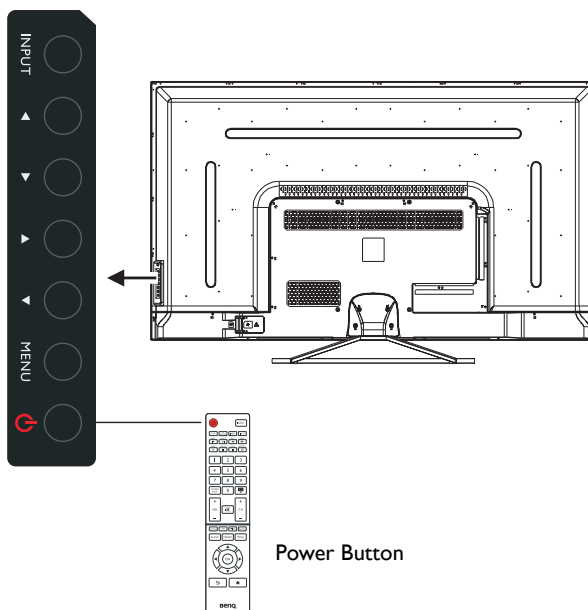

Power Button

ST650K

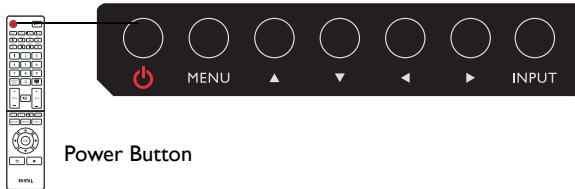
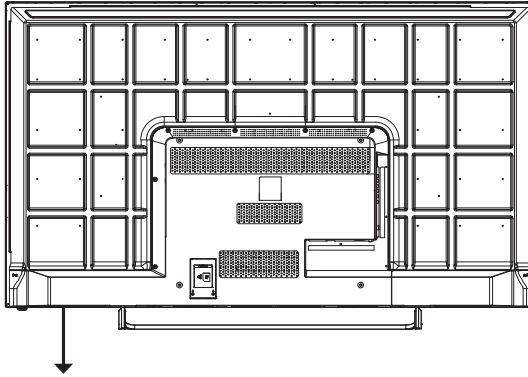

Power Button



- Only by switching on the master switch will either power button work. To turn on or off the display, press the power button on the display's control panel or on the remote control.
- Turning off the power still consumes power. The users have to un-plug the plug to completely cut off the power supply.

Switching input signals

Press the **INPUT** button and those signal selection buttons on the remote control or the **INPUT** button on the control panel to select an input signal.



Adjusting audio volume level

Press ◀ / ▶ on the control panel or **VOL-** / **VOL+** on the remote control to adjust the volume.

Setting up Internet connection

Your display must be connected to the network to download updates or surf the Internet.

Wired Connection

1. Connect one end of the Ethernet cable to the LAN port of the display.
2. Connect the other end of the Ethernet cable to the LAN port of the router.
3. Press the **INPUT** button on the remote control and select **ANDROID**.
4. On the home screen, select **All Apps** (☐) > **Settings** (⚙) > **Network**.
5. In the **Network** menu, select **Wired**.
6. In the **Wired** menu, set **Open Ethernet** to **On** to configure the network settings. Then do the following:
 - If the router setting enables obtaining IP address automatically, select **The Automatic Acquisition IP Address** and press the **OK** button. Your display will obtain the IP address automatically.
 - Otherwise, do the following to manually configure the network:
 - a. Select **IPv6** and press the **OK** button to enable/disable IPv6.
 - b. Select **IP Address** and assign a valid IP address for the device.
 - c. Select **Subnet Mask** and assign a subnet mask of the IP address for the device.
 - d. Select **Default Gateway** and assign a valid gateway for the device.

- e. Select **First DNS** and **Second DNS**, and then assign a valid DNS server address for the device.
- f. Select **save** and press the **OK** button. A successful message appears on the screen.

Wireless Connection

This display only supports BenQ WDRT8192 WiFi dongle. Please contact your local dealer for more information on configuring the wireless connection.

Updating software

Whenever a new version of the software is available, the system will automatically detect the update and will prompt you to download it every time you turn on the display.

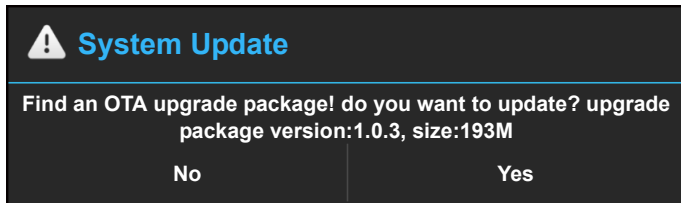

If you want to update the software, select **Yes** and press the **OK** button on the remote control. Or you can skip this step and update the software later.



- Software update process may take some time to complete.
- During the update process, do not turn off the device or disconnect the Internet connection. Any interruptions during the software update process may permanently damage your display.

The OSD (On-Screen Display) menu







OSD menu overview

Menu name	Options/functions	See page
Picture	<ul style="list-style-type: none"> • Picture Mode • Contrast • Brightness • Hue • Sharpness • Saturation • Color Temperature • Zoom Mode • Image Noise Reduction • PC Image Mode 	36
Sound	<ul style="list-style-type: none"> • Sound Mode • Bass • Treble • Balance • Surround • Coaxial Output • Alone Listen 	37
Setting	<ul style="list-style-type: none"> • Menu Time • Sleep Time • Power Mode • Boot Source • Power Save • Power Logo • Software Update (USB) • Restore To Default 	38

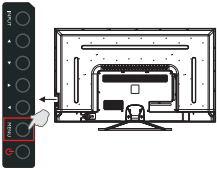
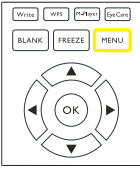
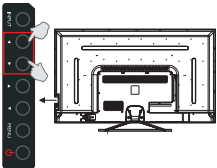

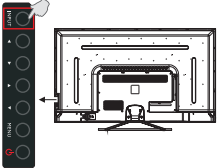
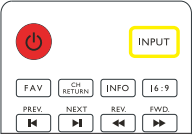
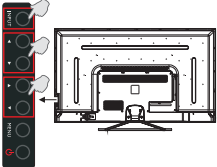
Some options are only available when a certain input signal source is selected.

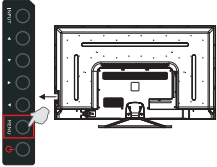
Operations in the OSD menu

Using the control panel buttons	Using the remote control
<p>1. Press MENU to open the OSD menu.</p> 	<p>1. Press MENU to open the OSD menu.</p> 
<p>2. In the OSD menu, press ▲ or ▼ to select an item.</p> 	<p>2. Press ▲ or ▼ to select an item.</p> 
<p>3. Press INPUT to confirm selections.</p> 	<p>3. Press INPUT to confirm selections.</p> 
<p>4. Press ▲ or ▼ to select a feature and press ◀ or ▶ to adjust settings. Press OK to save changes.</p> 	<p>4. Press ▲ and ▼ to select a feature and press ◀ or ▶ to adjust settings. Press OK to confirm changes.</p> 
<p>5. Press MENU to close the OSD menu.</p> 	<p>5. Press MENU to close the OSD menu.</p> 

Picture menu

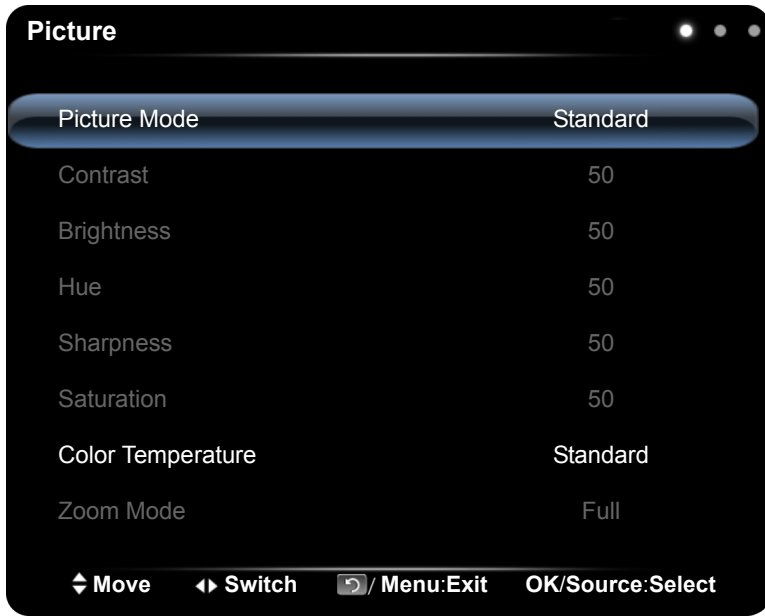

Name	Description
Picture Mode	Adjust the effects of images: Standard, Soft, User, Bright.
Contrast	Adjust the layerings of images: increase the analog value to improve the contrast and decrease the analog value to reduce the contrast (0-100).
Brightness	Adjust the brightness of images: increase the analog value to improve the brightness and decrease the analog value to reduce the brightness (0-100).
Hue	Adjust the hue of images: increase the analog value to increase green and decrease the analog value to increase purple (0-100).
Sharpness	Adjust the sharpness of images: increase the analog value to increase the definition and decrease the analog value to reduce the definition (0-100).
Saturation	Adjust the color depth of images: increase the analog value to improve the depth and decrease the analog value to reduce the depth (0-100).
Color Temperature	Adjust the color temperature of images: Standard, Warm, Cold.
Zoom Mode	Adjust the zoom mode. Zoom mode is supported by each input: <ul style="list-style-type: none"> • HDMI: PC Mode, Full, 4:3, Film, Subtitle. • VGA: Full, 4:3
Image Noise Reduction	Set the grade of noise reduction: Middle, High, Off, Low.
PC Image Mode	Adjust the screen aspect ratio in PC mode, which is valid in VGA signal source.

Sound menu

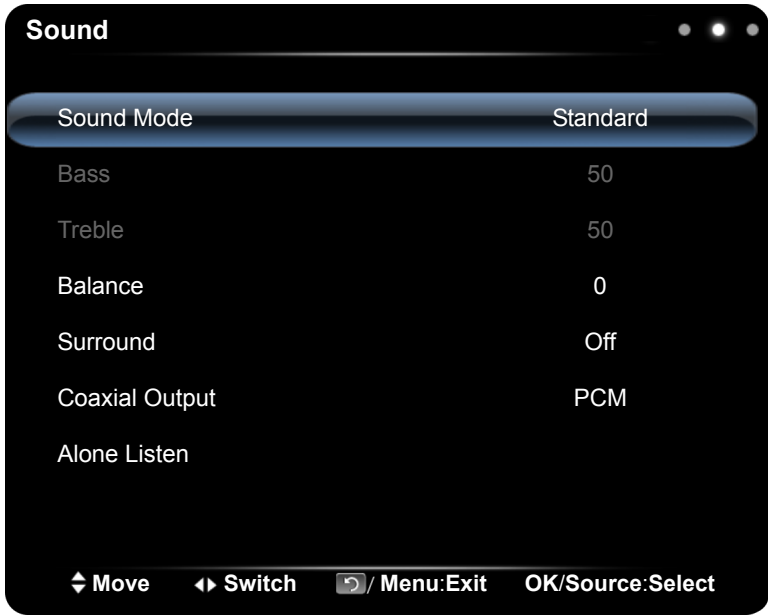

Name	Description
Sound Mode	Select the audio mode: Standard, Music, Movie, User.
Bass	Adjust the bass: increase the analog value to increase the bass and decrease the analog value to reduce the bass (0-100).
Treble	Adjust the treble: increase the analog value to increase the treble and decrease the analog value to reduce the treble (0-100).
Balance	Adjust the balance degree of the right & left sound track: move the analog value to left to increase the left volume; move the analog value to right to increase the right volume (L50-R50). Generally, the balance is set to 0.
Surround	Select to turn on/off the surrounding sound.
Coaxial Output	Select the digital audio output mode: PCM, RAW.
Alone Listen	Select this option to blank and output the audio only; press any key to exit.

Setting menu

Screen images and icons in this document are for your reference only. Actual displays may vary.

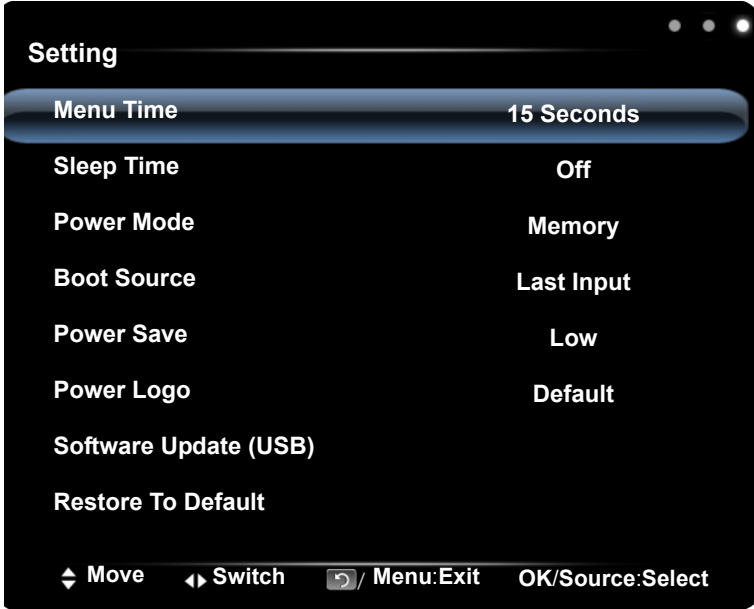

Name	Description
Menu Time	Adjust the menu display time: 5 Seconds, 10 Seconds, 15 Seconds, 20 Seconds, 30 Seconds, Always.
Sleep Time	Set the waiting time before standby: Off, 10 Minutes, 20 Minutes, 30 Minutes, 60 Minutes, 90 Minutes, 120 Minutes, 180 Minutes, 240 Minutes.
Power Mode	There are three modes: <ul style="list-style-type: none"> • Direct: Automatically power on when the supplied power cord is connected. • Secondary: Automatically enter standby mode when the supplied power cord is connected. • Memory: Automatically return to the status before power failure when the supplied power cord is connected (Power on/Power off).
Boot Source	There are eight options: Default, Android, HDMI 1, HDMI 2, HDMI 3, AV, YPbPr, VGA

Power Save	There are three modes: <ul style="list-style-type: none">• Off: The system won't go into power-saving mode or do any action without an external signal source. The system will keep the power-on state.• High: In the absence of an external signal source over five minutes, the system will enter standby mode/shutdown.• Low: In the absence of an external signal source over five minutes, the system will enter blank (LED backlight off, audio off, LED blinking). The external signal source is shown when it lights up the screen.
Power Logo	Users can decide if they want the BenQ logo to be shown when the machine is turned on: Default, On. (The function is optional, please refer to the actual product.)
Software Update (USB)	Update the Fireware by USB port.  USB 3.0 does NOT support this function.
Restore To Default	Reset all the settings to default.

Multimedia operation

The multimedia provides a variety of functions when the display is connecting to USB drives.

Playing Files in the local disk device:

1. Before playing files in the local disk, insert the USB mass storage device into the USB interface. See [Connecting the multimedia inputs on page 28](#) for details.
2. When a USB flash is inserted in ST550K, a message will pop up to inform the users to turn on the APP. The users can decide if they want to turn the APP on or not.

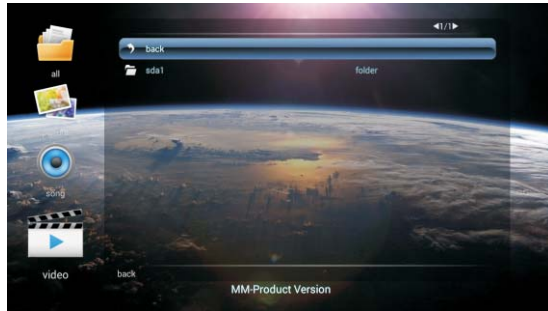

3. Select your desired menu to operate.

Multimedia buttons on the remote control

To operate the multimedia buttons, use the buttons on the remote control.

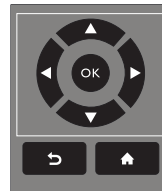

No	Name	Description
1	MENU	Switch to the OSD menu.
2	BACK	Go back to the root page of the disk selection.
3	OK	Select/deselect an item.
4	◀ / ▶ / ▲ / ▼	Directional arrows for selecting a desired item.
5	REV	Fast rewinds the current selected item.
6	▶ /	Starts/resumes/pauses playback.
7	■	Stops image playback.
8	FWD	Fast forwards the current selected item.
9	PREV	Go back to the previous selected item.
10	NEXT	Go to the next selected item.

Viewing files





To view the files on your USB flash drive, simply plug your **USB** flash drive to the USB jack on the display and select from **PICTURE**, **SONG**, **VIDEO**.





PICTURE

List all the supported image files in thumbnail view. Select the image you want to display and perform the functions as provided on the screen according to your needs.



Picture Player Menu Options

	Play the previous picture.
	Pause / Play lantern slide.
	Play the next picture.
	Zoom in the picture.

	Zoom out the picture.
	Rotate 90° left.
	Rotate 90° right.
	Show details of the picture.







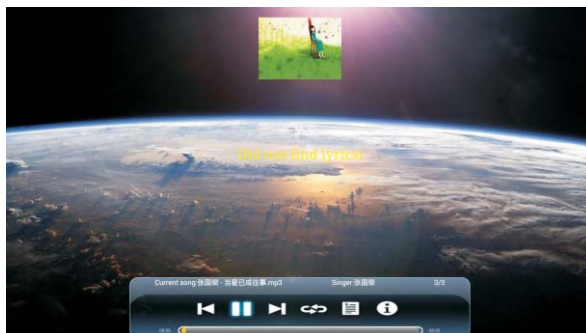

- Instead of pressing **INFO** button on the remote control, the metadata of the selection on the cursor will be revealed around 3 seconds later.
- Use **◀ / ▶ / ▲ / ▼** and **OK** to select multiple files as a playlist.
- Use **◀ / ▶** for previous/next image in the playback.

SONG

Select the track you want to play and perform the functions as provided on the screen according to your needs.



Music Player Menu Options

	Play the previous track.
	Pause / resume music playing.
	Play the next track.
	Set the repeat playing mode: All, Single, Random.
	View the playing list.
	Show details of the music.















- Instead of pressing **INFO** button on the remote control, the metadata of the selection on the cursor will be revealed around 3 seconds later.
- Use **◀ / ▶ / ▲ / ▼** and **OK** to select multiple files as a playlist.

VIDEO

Select the video file you want to play and perform the functions as provided on the screen according to your needs.

Video Player Menu Options



	Play the previous video.
	Select the speed of fast rewind.
	Pause / Play the video.
	Select the speed of fast forward.
	Play the next video.
	Select the starting time point of watching.
	View the playing list.
	Show details of the video.
	Play setup; show/hide subtitle and adjust the audio progress in this option.
	Set A-B repeat playing; set point A and point B, and the video will repeat between A and B.
	A dual-screen display: start or off dual display function.
	Select playing screen.
	Select dual display window display mode.



- Instead of pressing **INFO** button on the remote control, the metadata of the selection on the cursor will be revealed around 3 seconds later.
- Use **◀ / ▶ / ▲ / ▼** and **OK** to select multiple files as a playlist.
- Press **PREV/NEXT** multiple times for multiple rewind/forward speed.

Type	Format	Decode	Audio	Resolution	Frame Rate	Mbit/sec
Video	AVI	H.264		3840 × 2160	30	135
		XviD / MPEG2 / MPEG4		1920 × 1080	60	40
		MJPEG		1280 × 720	30	10
	MKV	H.264		3840 × 2160	30	135
		MPEG4 / RV9		1920 × 1080	60	40
	MPG	MPEG1 / MPEG2		1920 × 1080	60	40
	VOB	MPEG2		1920 × 1080	60	40
	MP4	MPEG4		3840 × 2160	30	135
		MPEG4	Mp2 / Mp3 / AAC / M4A / PCM		1920 × 1080	60
	MOV	H.264		3840 × 2160	30	135
		MPEG4		1920 × 1080	60	40
		MJPEG		1280 × 720	30	10
	3GP	MPEG4		1920 × 1080	60	40
	FLV	FLV		1920 × 1080	60	40
	TS	H.265		3840 × 2160	30	100
		H.264		3840 × 2160	30	135
		AVS / MPEG2		1920 × 1080	60	40
	TRP	H.264		3840 × 2160	30	135
MPEG2			1920 × 1080	60	40	
DAT	MPEG1		1920 × 1080	60	40	
RM	RV8 / RV9 / RV10		COOK	1920 × 1080	60	40

Type	Format	Decode	Resolution	Required DRAM size
Photo	JPG / JPEG	Baseline	15360 × 8640	3.96
		Progressive	1024 × 768	6
	PNG	Non - interlace	9600 × 6400	3.66
		Interlace	1200 × 800	3.66
	BMP	bmp	9600 × 6400	3.66

Type	Format	Decode	Note
Audio	MP3	MP3	Need to be licensed when using AC3 format
	AAC / M4A	AAC	

Working with Android OS

To switch to the Android OS, do the following:

1. Press the **INPUT** button on the remote control/control panel and select **ANDROID**. The home screen appears.

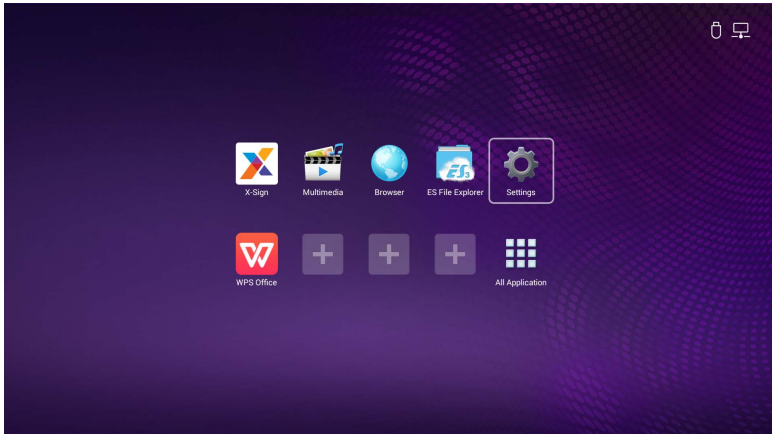

2. Select the application that you want to access.
 - Using the touch pen: Tap your desired application icon to launch the application.
 - Using the remote control: Press the ◀ or ▶ button to select your desired application and press the **OK** button to launch the application.











- Select **All Apps** (3x3 grid icon) to access to all applications.
- To return to the home screen, tap the 🏠 icon on the screen or press the Home button (🏠) on the remote control.
- The system does not support any third party applications. The closed platform ensures the proper use of the display by preventing downloads and use of unauthorized apps. This minimizes unanticipated damages or breakdowns.

About All Apps



To operate the Android OS, use the touch pen or the buttons on the remote control.

Application Name/Icon	Description
Browser ()	Access the web pages. Refer to Browser on page 47 for more information.
X-Sign ()	Edit contents with X-Sign Designer. Refer to X-Sign on page 48 for more information.
ES File Explorer ()	Manage files stored on the internal memory and the connected storage devices. Refer to ES File Explorer on page 49 for more information.
Multimedia ()	Browse the multimedia files stored on the internal memory or the connected storage devices. Refer to Multimedia on page 50 for more information.
Settings ()	Configure the network and device settings. Refer to Settings on page 52 for more information.
WPS Office ()	Read and edit the files in Office formats, including, *.doc, *.txt, *.xls, and *.ppt. Refer to WPS Office on page 53 for more information.
Gallery ()	View the images stored on the internal memory or the connected storage devices.
Music ()	Play the audio files stored on the internal memory or the connected storage devices.
Home ()	Tap to return the home screen.

Browser

Tap  to launch **Browser**. With this application, you can view web pages.



Before launching the application, make sure your display is properly connected to the Internet.

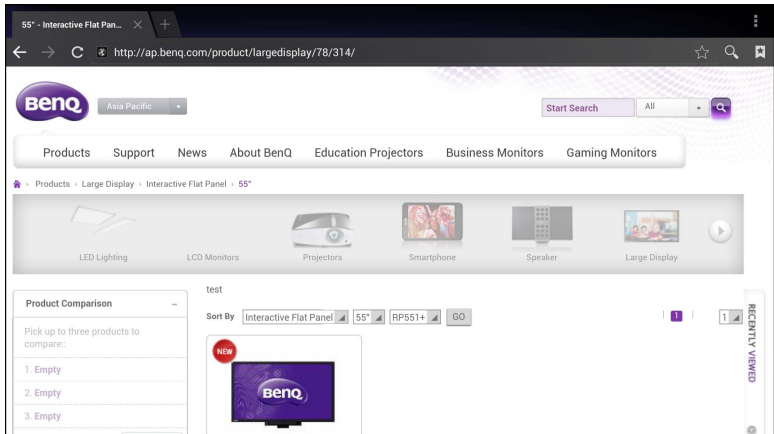

Tap the icon on the top panel to activate its function. Slide on the screen to scroll the viewed page.

Function	Description
Address Bar	Enter the web page address to view the page.
Settings (⋮)	Tap to configure the browser settings.
Back (←)	Tap to return to the previous page.
Next (→)	Tap to go to the next page.
Refresh (↻)	Tap to reload the current web page.
Favorite (☆)	Tap to save the current web page to bookmarks.
Search (🔍)	Tap to search the Internet.
Bookmarks (🔖)	Tap to select bookmarks, history, or saved favorite web pages to visit.
Close (✕)	Tap to close the current web page.

X-Sign

Tap  to launch **X-Sign**. **X-Sign** is a content player app. Users can edit contents with X-Sign Designer by their PCs or laptops.



After editing the contents, users can import the file to the display through USB flash drive. The contents will then be played automatically.









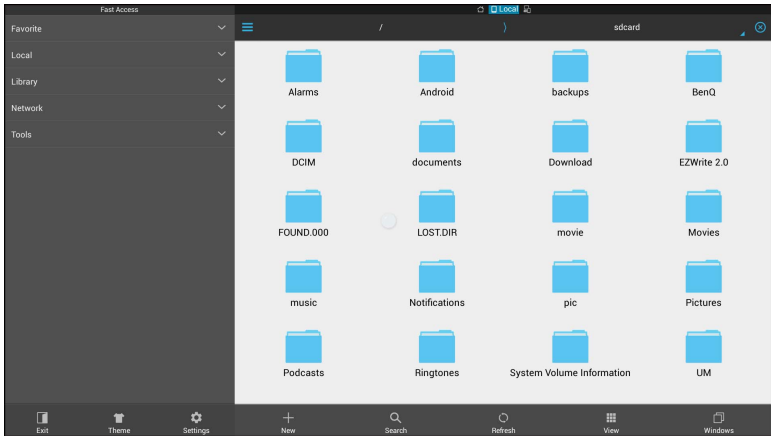

X-Sign Designer can be downloaded from BenQ website. Please refer to the postcard in the accessory pack for the instructions.

ES File Explorer

Tap  to launch **ES File Explorer**. With this application, you can manage the files and applications.



Tap the category on the left panel and select the desired folder to browse. Tap a file in the folder, then you can view or edit the file according to the available options.

Function	Description
Theme ()	Tap to change different themes.
Settings ()	Tap to access more advanced options.
New ()	Tap to create a new folder.
Search ()	Tap to search for files in the internal memory or external device.
Refresh ()	Tap to reload the current page.
View ()	Tap to toggle between the list view or icons view.
Windows ()	Tap to switch between open windows.
Exit ()	Tap to close the application.

Multimedia

Tap  to launch **Multimedia**. With this application, you can browse the photos, songs, or videos stored on the internal memory or the connected storage devices.

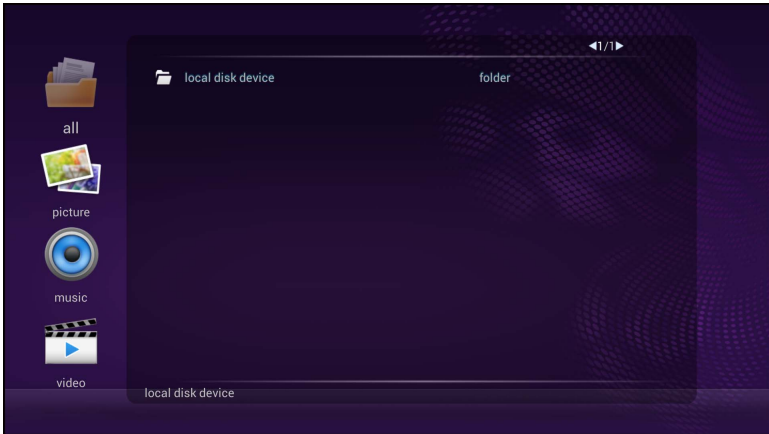

- Tap **all** to view all files.
- Tap **picture** to view the photos. Tap the desired photo to view it in full screen.
- Tap **music** to view the audio files. Tap the desired audio file to play the song/audio clip.
- Tap **video** to view the videos. Tap the desired video file to play the video clip.

Supported multimedia file formats

Video

Format	Decode	Audio	Resolution	Frame Rate	Mbit/sec
AVI	XviD / MPEG2 / MPEG4	MP2 / MP3 / AAC / M4A / PCM	1920 x 1080	60	40
	MJPEG		1280 x 720	30	10
MKV	MPEG4 / RV9		1920 x 1080	60	40
MPG	MPEG1 / MPEG2		1920 x 1080	60	40
VOB	MPEG2		1920 x 1080	60	40
MP4	MPEG4		1920 x 1080	60	40
MOV	MPEG4		1920 x 1080	60	40
	MJPEG		1280 x 720	30	10
3GP	MPEG4		1920 x 1080	60	40
FLV	FLV		1920 x 1080	60	40
TS	AVS / MPEG2	1920 x 1080	60	40	
TRP	MPEG2	1920 x 1080	60	40	
DAT	MPEG1	1920 x 1080	60	40	
RM	RV8 / RV9 / RV10	COOK	1920 x 1080	60	40

Photo

Format	Decode	Resolution	Required DRAM size
JPG / JPEG	Base-line	15360 x 8640	3.96
	Progressive	1024 x 768	6
PNG	Non-interlace	9600 x 6400	3.66
	Interlace	1200 x 800	3.66
BMP	bmp	9600 x 6400	3.66

Audio

Format	Decode	Note
MP3	MP3	Need to be licensed when using AC3 format
AAC / M4A	AAC	

Settings

Tap  to launch **Settings**. With this application, you can view and configure the settings of your device.

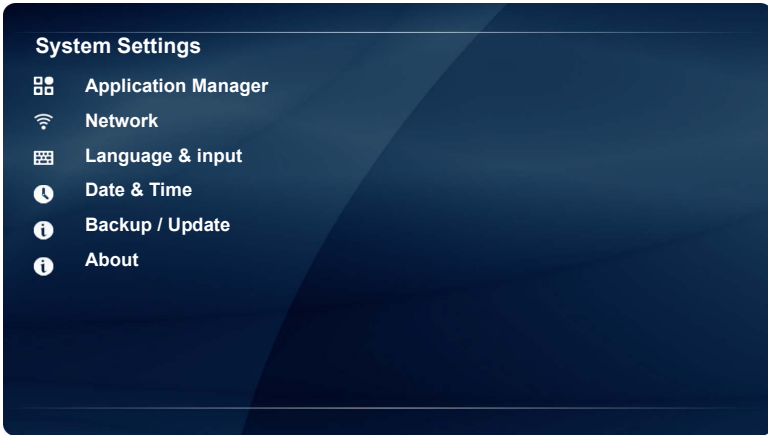

Tap the desired menu option to enter its submenu.

Menu Option	Description
Application Manager	Select this option to view the total and available storage (internal memory or USB disk drive) space.
Network	Select this option to view the network status or configure the network connection.
Language & input	Select this option to change the system language or configure the input method settings.
Date & Time	Select this option to set the date and time.
Backup / Update	Select this option to update the software, view the basic system information (i.e. software version, system time, IP address, MAC address, and memory storage) or restore all parameters to the factory default settings.
About	Select this option to view the model name and other hardware/software information.

WPS Office

Tap  to launch **WPS Office**. With this application, you can open almost any file format including PDFs and Microsoft Word, PowerPoint and Excel documents.

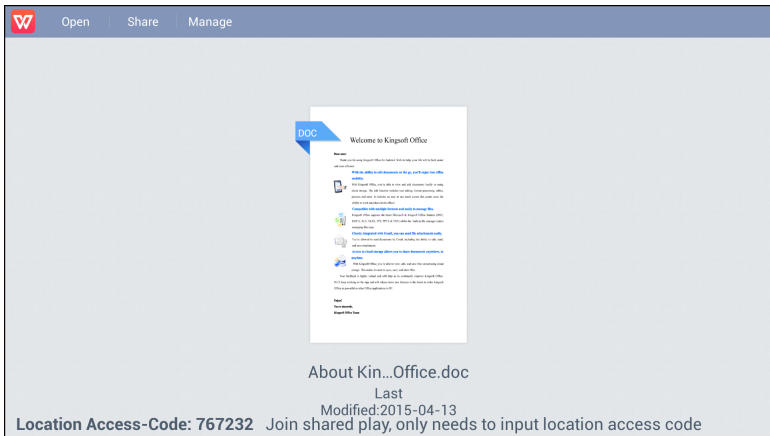

Tap the icon on the top panel to access its function.

Function	Description
Open	Tap to browse and open a file.
Share	Tap to share your files through email or other sharing applications.
Manage	Tap to edit or manage the document.

Supported Office versions and file formats

Supported Office versions: 97 / 2000 / XP / 2003 / 2007 / 2010

Supported Office software formats:

Office Software	Supported File Formats
Word	doc / docx / rtf / txt
Excel	xls / xlsx / csv
PowerPoint	ppt / pps / pot / pptx / ppsx / potx

Product information

Specifications

Item		Specifications
		ST430K/ST550K/ST650K
LCD panel	Backlight	D-LED
	Panel size	ST430K: 43" ST550K: 55" ST650K: 65"
	Pixel pitch (mm)	ST430K: 0.2451(H) × 0.2451(V) ST550K: 0.42 (H) x 0.315 (V) ST650K: 0.744 (H) × 0.744 (V)
	Native resolution (pixels)	3840 x 2160
	Brightness (cd/m ²) (typical)	ST430K: 380 ST550K: 350 ST650K: 450
	Contrast (typical)	1200:1
	Response time (ms) (typical)	ST550K: 6 ST430K/ST650K: 8
	Panel Bit	10-bit
Input	Computer	VGA (D-Sub 15-pin)
	Video	AV (RCA jacks), YPbPr, HDMI x 3
	Audio	L/R (RCA jacks)
	USB	USB2.0 x 3, USB3.0 x 1
	Control / Android	LAN
	TV Tuner	X
Output	Video	Composite Video
	Audio	COAXIAL OUT; AUDIO OUT
	External speaker out (L/R)	X
Audio	Audio W (Amp)	8 W x 2
	Internal speaker	O
Power	Supply	100 - 240 V AC, 50/60 Hz
	Consumption Max.	ST430K: 98 W ST550K: 155 W ST650K: 200 W
	Consumption Standby	< 0.5 W
Environment	Operating Temperature	5°C - 40°C
	Operating Humidity	10%- 85% (without condensation)
	Storage Temperature	-20°C - 55°C
	Storage Humidity	5% - 90% (without condensation)
	Display Orientation	ST430K & ST550K: Landscape & Portrait ST650K: Landscape

Mechanical	Weight (kg)	ST430K: 8.5/11 ST550K: 16/20 ST650K: 20.5/28.5
	Dimensions (W x H x D) (mm)	ST430K: 970 × 564 × 74mm ST550K: 1247×725×80mm/1247×791×324mm ST650K: 1462 × 844 × 88mm
	Bezel Dimension - T/B/L/R (mm)	ST430K: 11.7/19.1/11.7/11.7 (up/down/left/right) ST550K: 6.1/13.6/6.1/6.1 (up/down/left/right) ST650K: 14.5/22.2/14.5/14.5 (up/down/left/right)
Feature	DVI daisy chain	X
	RS232 control daisy chain	X
	Image setting	Standard/Soft/Bright/User
	Picture mode	O
	Sharpness enhancement	O
	Proof of image retention	X
	Dimming control	X
	Blank	O
	Freeze	O
	10-bit color processing	O
	Built-in video wall support	X
	Scheduling	O
	Source / volume control	O
	HDMI-HDCP	O
	De-Interlacing / comb Filter	O
	Ambient light sensor	X
	Power Mode	O
Boot Source	O	



Specifications and functions are subject to change without notice.

Item		ST430K/ST550K/ST650K
System	CPU	ARM Cortex A9 1.5GHz Quad core
	System Memory	2GB
	Storage	ST550K: 4GB/8GB ST430K/ST650K: 8GB
	OS	Android 4.3



- OS: This Android 4.3 operating system is not standard Android, so access to Google Play™ is not available. APK cannot be installed in the default location. Without management permission, installing function won't work. There is no guarantee that the self-installed APK can function normally.
- Storage: Content storage may vary by the product supplied for your region. Pre-installed system and apps may take up some space.

Dimensions

ST430K

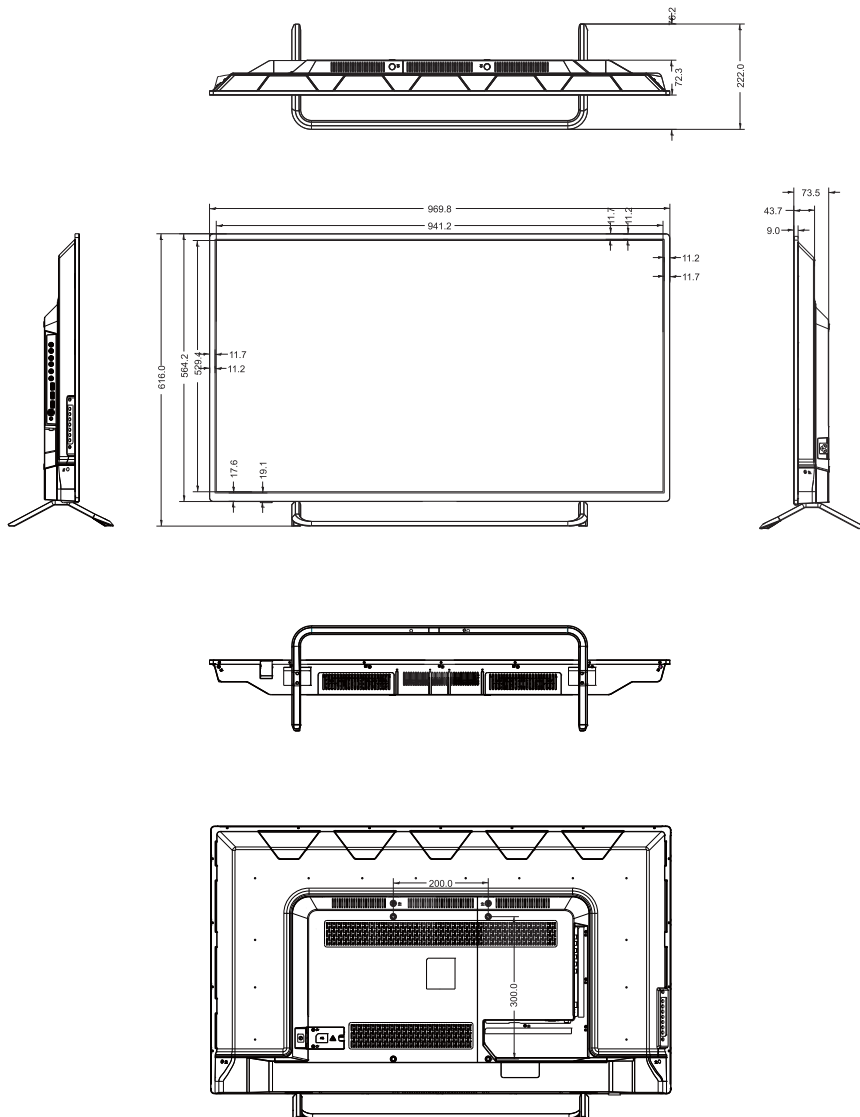

Unit: mm

ST550K

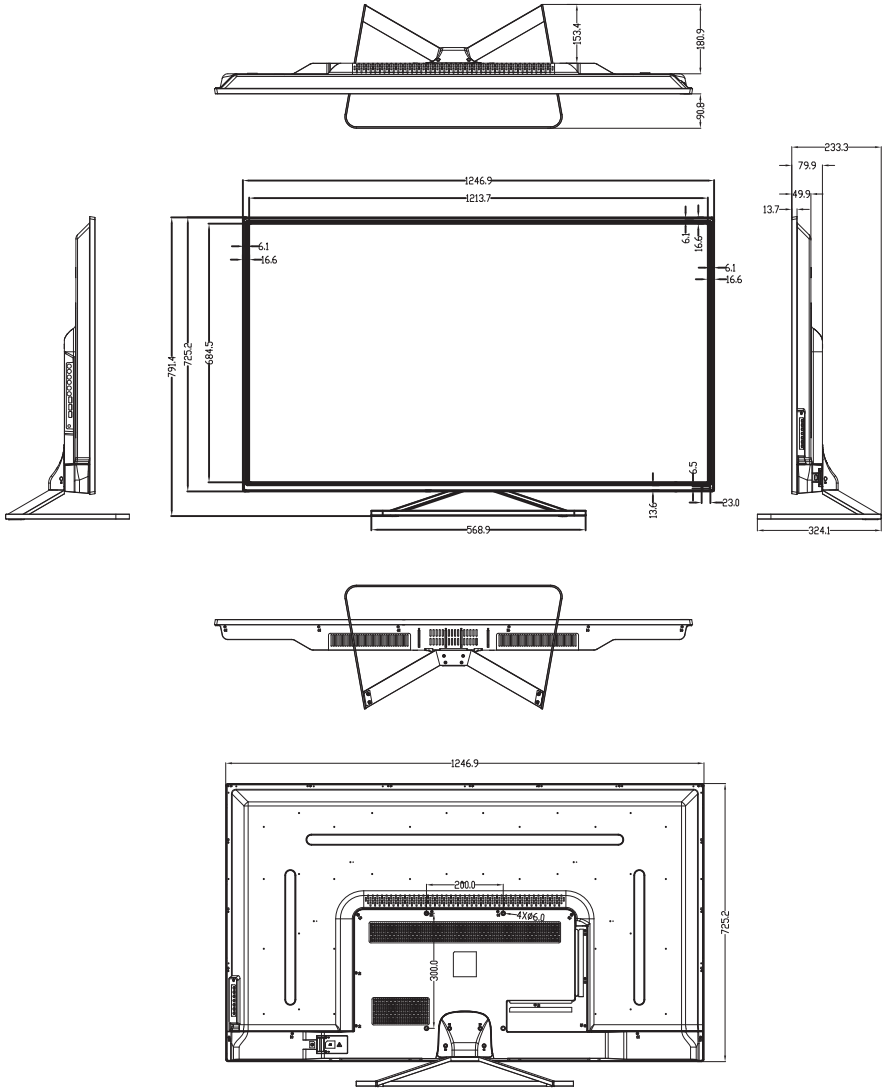

Unit: mm

ST650K

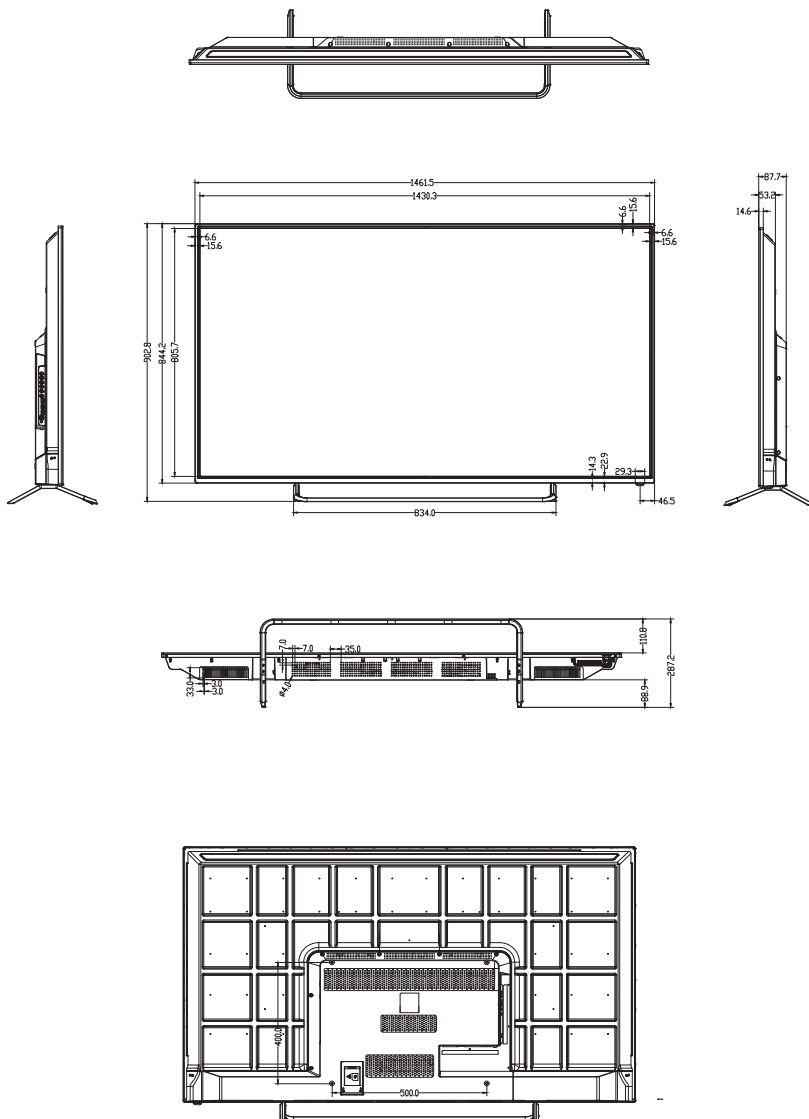

Unit: mm

Supported input signal resolution

Resolution	Input source				
	AV	S-Video	YPbPr	VGA	HDMI
640 x 480 @ 60Hz				○	
640 x 480 @ 67Hz					
640 x 480 @ 72Hz					
640 x 480 @ 75Hz					
720 x 400 @ 70Hz					
800 x 600 @ 60Hz				○	
800 x 600 @ 75Hz					
832 x 624 @ 75Hz					
1024 x 768 @ 60Hz				○	
1024 x 768 @ 75Hz					
1152 x 870 @ 75Hz					
1280 x 720 @ 60Hz				○	
1280 x 768 @ 60Hz					
1280 x 800 @ 60Hz RB					
1280 x 800 @ 60Hz					
1280 x 960 @ 60Hz					
1280 x 1024 @ 60Hz				○	
1360 x 768 @ 60Hz				○	
1366 x 768 @ 60Hz				○	
1400 x 1050 @ 60Hz					
1600 x 1200 @ 60Hz				○	
1680 x 1050 @ 60Hz RB				○	
1600 x 1050 @ 60Hz					
1920 x 1080 @ 60Hz				○	
NTSC-M	○				
NTSC-J	○				
PAL-BDGHI	○				
576i (50Hz)			○		○
480i (60Hz)			○		○
480p (60Hz)			○		○
576p (50Hz)			○		○
720p (25Hz)			○		
720p (30Hz)			○		
720p (50Hz)			○		○

720p (60Hz)			○		○
1080i (50Hz)			○		○
1080i (60Hz)			○		○
1080p (24Hz)			○		
1080p (25Hz)			○		
1080p (30Hz)			○		
1080p (24Psf)					
1080p (25Psf)					
1080p (50Hz)			○		○
1080p (60Hz)			○		○
2160p (24Hz)					○
2160p (25Hz)					○
2160p (30Hz)					○



- ○: supported
- Blank: not supported

Troubleshooting

Problem	Solution
No picture	<p>Check the following:</p> <ul style="list-style-type: none"> • Is the display turned on? Check the power indicator of the display. • Is the signal source device turned on? Turn on the device and try again. • Are there any loose cable connections? Make sure that all cables are connected firmly. • Have you chosen an unsupported output resolution on the computer? Refer to Supported input signal resolution on page 59 to select a supported resolution and try again. • Have you chosen an unsupported output resolution on the DVD or Blu-ray disc player? Refer to Supported input signal resolution on page 59 to select a supported resolution and try again.
No sound	<p>Check the following:</p> <ul style="list-style-type: none"> • Have you turned on the mute function on the display or the input source device? Turn off the mute function or increase the audio volume level and try again. • Are there any loose cable connections? Make sure that all cables are connected firmly.
The computer input image looks strange.	<ul style="list-style-type: none"> • Have you chosen an unsupported output resolution on the computer? Refer to Supported input signal resolution on page 59 to select a supported resolution and try again. • Use the Auto Tune function (See Picture menu on page 36) to let the display automatically optimize the display of computer image. • If the result of the Auto Tune function is not satisfactory, use the Phase, Horizontal Position, and Vertical Position functions to manually adjust the image.
The control panel buttons do not work.	<p>Have you locked the control panel buttons? Unlock the buttons and try again.</p>

<p>The remote control does not work.</p>	<ul style="list-style-type: none">• Have you locked the remote control function? Unlock the function and try again.• Check for incorrect battery orientation.• Check for dead batteries.• Check your distance and angle from the display.• Check whether remote control is properly being pointed at the display's remote control sensor window.• Check for any obstacle between the remote control and the remote control sensor window.• Check that the remote control sensor window is not under strong fluorescent lighting, or in direct sunlight.• Check for any devices (computer or personal digital assistant, PDA) nearby that transmit infrared signals which may cause interference to signal transmission between the remote control and the display. Turn off the infrared function of these devices.
--	--

11/18/16