



HP Spectre Pro x360 Convertible PC G2

Maintenance and Service Guide
IMPORTANT! This document is intended for
HP authorized service providers only.

© Copyright 2016 Hewlett-Packard
Development Company, L.P.

Bluetooth is a trademark owned by its proprietor and used by HP Inc. under license. Intel and Core are U.S. registered trademarks of Intel Corporation. Windows is either a registered trademark or trademark of Microsoft Corporation in the United States and/or other countries. SD Logo is a trademark of its proprietor.

The information contained herein is subject to change without notice. The only warranties for HP products and services are set forth in the express warranty statements accompanying such products and services. Nothing herein should be construed as constituting an additional warranty. HP shall not be liable for technical or editorial errors or omissions contained herein.

First Edition: January 2016

Document Part Number: 850191-001

Product notice

This guide describes features that are common to most models. Some features may not be available on your computer.

Not all features are available in all editions of Windows 10. This slate may require upgraded and/or separately purchased hardware, drivers, and/or software to take full advantage of Windows 10 functionality. See for <http://www.microsoft.com> details.

Safety warning notice

 **WARNING!** To reduce the possibility of heat-related injuries or of overheating the device, do not place the device directly on your lap or obstruct the device air vents. Use the device only on a hard, flat surface. Do not allow another hard surface, such as an adjoining optional printer, or a soft surface, such as pillows or rugs or clothing, to block airflow. Also, do not allow the AC adapter to contact the skin or a soft surface, such as pillows or rugs or clothing, during operation. The device and the AC adapter comply with the user-accessible surface temperature limits defined by the International Standard for Safety of Information Technology Equipment (IEC 60950).

Table of contents

1 Product description	1
2 External component identification	4
Locating hardware	4
Locating software	4
Display	5
Keys	6
Lights	7
Speakers	7
TouchPad	8
Left side	9
Right side	11
3 Illustrated parts catalog	12
Locating the serial number, product number, and model number	12
Computer major components	13
Miscellaneous parts	15
4 Removal and replacement preliminary requirements	17
Tools required	17
Service considerations	17
Plastic parts	17
Cables and connectors	17
Grounding guidelines	18
Electrostatic discharge damage	18
Packaging and transporting guidelines	19
Workstation guidelines	19
5 Removal and replacement procedures	21
Unlocking the device and disabling Always On Remote Management (select HP devices only)	21
Bottom cover	22
Battery	23
WLAN module	24
Solid-state drive	26
Fan	27
Speakers	28

TouchPad	29
Card reader board	30
System board	31
Heat sink	34
Keyboard	35
Display assembly	37
Audio jack board	39
Power connector cable	40
6 Using Setup Utility (BIOS)	41
Starting Setup Utility (BIOS)	41
Updating Setup Utility (BIOS)	41
Determining the BIOS version	42
Downloading a BIOS update	42
Synchronizing a tablet and keyboard (select products only)	43
7 Using HP PC Hardware Diagnostics (UEFI)	44
Downloading HP PC Hardware Diagnostics (UEFI) to a USB device	45
8 Specifications	46
9 Backing up, restoring, and recovering	47
Creating recovery media and backups	47
Creating HP Recovery media (select products only)	48
Using Windows Tools	49
Restore and recovery	49
Recovering using HP Recovery Manager	50
What you need to know before you get started	50
Using the HP Recovery partition (select products only)	51
Using HP Recovery media to recover	51
Changing the computer boot order	52
Removing the HP Recovery partition (select products only)	52
10 Statement of Volatility	53
Non-volatile memory usage	55
Questions and answers	58
Using HP Sure Start (select models only)	59
11 Power cord set requirements	60
Requirements for all countries	60

Requirements for specific countries and regions	60
12 Recycling	62
Index	63

1 Product description

Category	Description
Product Name	HP Spectre Pro x360 Convertible PC G2
Processor	<ul style="list-style-type: none">• Intel™ Core® i7-6600U 2.60-GHz (SC turbo up to 3.4-GHz) processor (1600-MHz FSB, 4.00-MB L2 cache, dual core, 15 W)• Intel Core i5-6300U 2.40-GHz (SC turbo up to 3.00-GHz) processor (1866-MHz FSB, 3.00-MB L2 cache, dual core, 15 W)• Intel Core i5-6200U 2.30-GHz (SC turbo up to 2.80-GHz) processor (1866-MHz FSB, 3.00-MB L2 cache, dual core, 15 W)
Chipset	Intel processor controller hub (PCH)
Graphics	Internal Graphics: Intel HD Graphics 520 Support for HD decode, DX12, and HDMI
Panel	13.3-in (2560×1440), BrightView, quad high-definition (QHD), white-light emitting (WLED), UWVA, TouchScreen with flush glass and MultiTouch enabled; eDP1.3+PSR at 72% Color Gamut (CG), 16:9 ultra-wide aspect ratio; typical brightness: 340 nits, (2.55-mm) 13.3-in (1920×1080), BrightView, full high-definition (FHD), WLED, UWVA, TouchScreen with flush glass and MultiTouch enabled; eDP1.2 at 72% Color Gamut (CG), 16:9 ultra-wide aspect ratio; typical brightness: 340 nits, (2.85-mm)
Memory	Support for LPDDR3-1866 dual channel Supports 8192-MB (256-MB×16×4×2 pieces) and 4096-MB (128-MB×32×4×2 pieces) configurations
Primary storage	Support for single PCIe / SATA M2 solid-state drive configuration as storage (scope M2 2260/2280 DS solid-state drive) in the following configurations: <ul style="list-style-type: none">• 512-GB solid-state drive supporting three-level cell (TLC)• 256-GB solid-state drive supporting TLC• 256-GB self-encrypting (SED), solid-state drive supporting multilevel cell (MLC) and Opal2• 180-GB solid-state drive supporting MLC• 128-GB solid-state drive supporting TLC
Audio and video	Webcam: HP TrueVision Full HD, fixed (no tilt), with activity light, 1920×1080 by 30 frames per second, with wide field of vision (88 degrees) Dual array digital microphones with appropriate beam-forming, echo-cancellation, noise-suppression software Support for voice recognition HD Audio (Conexant cx7501) Two speakers
Wireless	Integrated wireless local area network (WLAN) options by way of wireless module Two built-in WLAN antennas (in display assembly)

Category	Description
Wireless <i>(continued)</i>	Support for Intel Dual band wireless-AC 8260 802.11AC 2x2 WiFi + Bluetooth 4.0 Combo Adapter Support for Miracast and Intel WiDi Pro
External media cards	HP multiformat Micro Digital Media Reader Slot with push-push technology. Reads data from and writes data to digital memory cards such as Secure Digital® (SD).
Ports	<ul style="list-style-type: none"> • AC adapter HP Smart plug (4.5-mm barrel) • Audio: one combo audio-out (headphone)/audio-in (microphone) jack, supports jack auto-detection • miniDisplayPort 1.2 supporting maximum 3200x2000 @ 60 Hz resolution • High-definition multimedia interface (HDMI) v.1.4b, supporting up to 1920x1200 at 60 Hz • USB 3.0 (3)
Keyboard/pointing devices	Full-size, backlight, island-style keyboard Touchpad requirements: <ul style="list-style-type: none"> • ClickPad with imaging sensor • Multi-touch gestures enabled • Taps enabled as default • Support for Microsoft® Windows® 8 modern TrackPad gestures, drivers for Windows 7 Professional
Power requirements	Support for 45-W HP Smart adapter (non-PFC, RC, 3- and 2-wire, 4.5-mm) Support for a 3-cell, 56-WHr, 4096-mAhr, Li-ion battery (includes cable)
Security	Optimize for Windows 10 security features: Device Guard, NextGen Credentials, Virtual Secure Mode Support for Intel AT-p Ready support Support for BitLocker Support for Trusted Platform Module 1.2 (TP 2.0M)
Operating system	Preinstalled: Windows 10 Professional 64-bit Restore media-SSRD/SSRU: Windows 10 SSRD Windows 10 SSRU Certified: Microsoft WHQL Web-only support: <ul style="list-style-type: none"> • Windows 10 Enterprise 64-bit • Windows 10 Home 64-bit • Windows 10 Professional 64-bit • Windows 8.1 Chinese Market 64-bit • Windows 8.1 Emerging Markets 64-bit • Windows 8.1 Multilanguage 64-bit • Windows 8.1 Professional 64-bit

Category	Description
Operating system <i>(continued)</i>	<ul style="list-style-type: none">• Windows 7 64-bit
Serviceability	End user replaceable part: AC adapter

2 External component identification

Locating hardware

To find out what hardware is installed on your computer:

1. From the Start screen, type `control panel`, and then select **Control Panel**.

– or –

From the Windows desktop, right-click the **Start** button, and then select **Control Panel**.

2. Select **System and Security**, select **System**, and then click **Device Manager** in the left column.

A list displays all the devices installed on your computer.

For information about system hardware components and the system BIOS version number, press `fn+esc`.

Locating software

To find out what software is installed on your computer:

- ▲ From the Start screen, click the down arrow in the lower-left corner of the screen.

– or –

From the Windows desktop, right-click the **Start** button, and then select **Programs and Features**.

Display

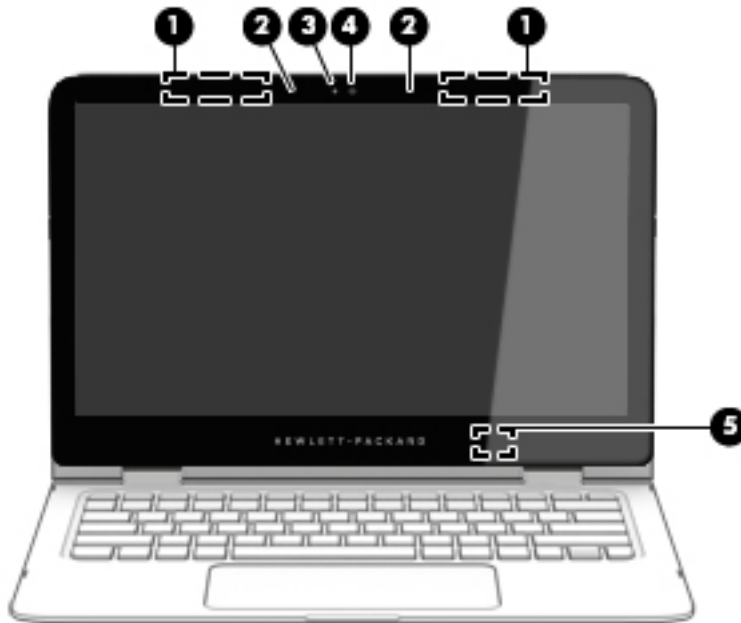

Item	Component	Description
(1)	WLAN antennas*	Send and receive wireless signals to communicate with WLANs.
(2)	Internal microphones	Record sound.
(3)	Webcam light	On: The webcam is in use.
(4)	Webcam	Records video and captures photographs. Some models allow you to video conference and chat online using streaming video. To use the webcam: <ul style="list-style-type: none">▲ From the Start screen, type <code>camera</code>, and then select Camera from the list of applications.
(5)	Internal display switch	Turns off the display and initiates Sleep if the display is closed while the power is on. NOTE: The internal display switch is not visible from the outside of the computer.

*The antennas are not visible from the outside of the computer. For optimal transmission, keep the areas immediately around the antennas free from obstructions. For wireless regulatory notices, see the section of the *Regulatory, Safety, and Environmental Notices* that applies to your country or region.

To access this document:

From the Start screen, type `support`, and then select the **HP Support Assistant** app.

– or –

From the Windows desktop, click the question mark icon in the notification area, at the far right of the taskbar.

Keys

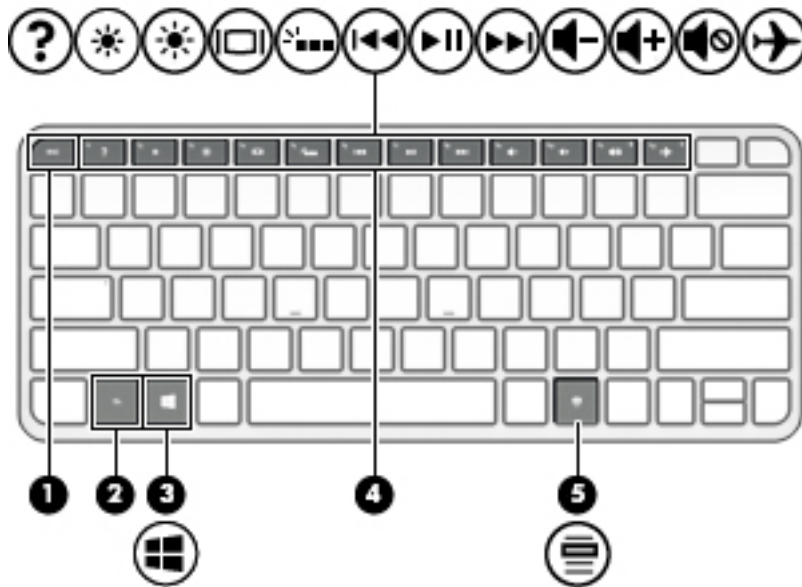

Item	Component	Description
(1)	esc key	Displays system information when pressed in combination with the fn key.
(2)	fn key	Displays system information when pressed in combination with the esc key.
(3)	Windows key	Returns you to the Start screen from an open app or the Windows desktop. NOTE: Pressing the Windows key again will return you to the previous screen.
(4)	Action keys	Execute frequently used system functions. NOTE: The f5 action key turns the radiance backlight keyboard feature off or on.
(5)	Windows applications key	Displays options for a selected object.

Lights

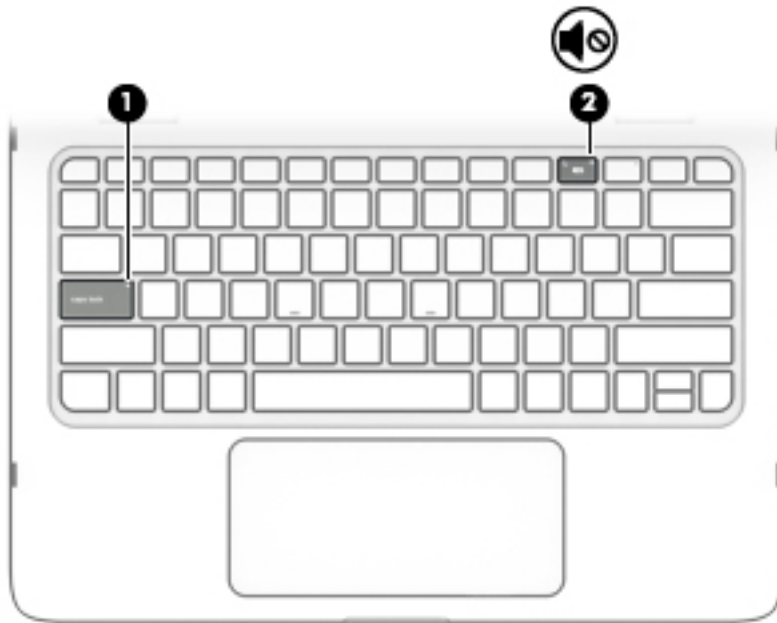

Item	Component	Description
(1)	Caps lock light	On: Caps lock is on, which switches the keys to all capital letters.
(2)	Mute light	<ul style="list-style-type: none">• Amber: Computer sound is off.• Off: Computer sound is on.

Speakers



Component	Description
Speakers	Produce sound.

TouchPad



Item	Component	Description
(1)	TouchPad zone	Reads your finger gestures to move the pointer or activate items on the screen.
(2)	TouchPad left button	Functions like the left button on an external mouse.
(3)	TouchPad right button	Functions like the right button on an external mouse.

Left side

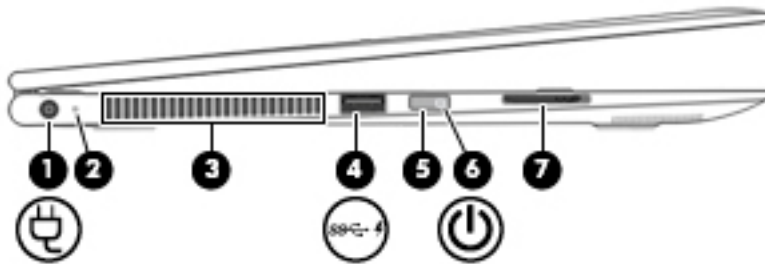

Item	Component	Description
(1)	Power connector	Connects an AC adapter.
(2)	AC adapter/battery light	<ul style="list-style-type: none"> • Solid white: The computer is connected to external power and the battery is fully charged. • Solid amber: The computer is connected to external power and the battery is charged from 0 to 99 percent. • Slowly blinking white: A battery that is the only available power source has reached a low battery level. Less than 12 percent of the battery life is left. • Quickly blinking white: A battery that is the only available power source has reached a critical battery level. Less than 7 percent of the battery life is left. • Off: The computer is running on a battery as the power source.
(3)	Vent	<p>Enables airflow to cool internal components.</p> <p>NOTE: The computer fan starts up automatically to cool internal components and prevent overheating. It is normal for the internal fan to cycle on and off during routine operation.</p>
(4)	USB 3.0 charging (powered) port	<p>Connects an optional USB device, such as a keyboard, mouse, external drive, printer, scanner or USB hub. Standard USB ports will not charge all USB devices or will charge using a low current. Some USB devices require power and require you to use a powered port.</p> <p>NOTE: USB charging ports can also charge select models of cell phones and MP3 players, even when the computer is off.</p>
(5)	Power button	<ul style="list-style-type: none"> • When the computer is off, press the button to turn on the computer. • When the computer is on, press the button briefly to initiate Sleep. • When the computer is in the Sleep state, press the button briefly to exit Sleep. • When the computer is in Hibernation, press the button briefly to exit Hibernation. <p>CAUTION: Pressing and holding down the power button will result in the loss of unsaved information.</p>

Item	Component	Description
(5)	Power button <i>(continued)</i>	<p>If the computer has stopped responding and Windows shutdown procedures are ineffective, press and hold the power button down for at least 5 seconds to turn off the computer.</p> <p>To learn more about your power settings, see your power options.</p> <ul style="list-style-type: none"> ▲ From the Start screen, type <code>power</code>, select Power and sleep settings, and then select Power and sleep from the list of applications. <p>– or –</p> <p>From the Windows desktop, right-click the Start button, and then select Power Options.</p>
(6)	Power light	<ul style="list-style-type: none"> ● On: The computer is on. ● Blinking: The computer is in the Sleep state, a power-saving state. The computer shuts off power to the display and other components. ● Off: The computer is off or in Hibernation. Hibernation is a power-saving state that uses the least amount of power.
(7)	Memory card reader	<p>Reads optional memory cards that enable you to store, manage, share or access information.</p> <p>To insert a card:</p> <ul style="list-style-type: none"> ▲ Hold the card label-side up, with connectors facing the slot, insert the card into the slot, and then push in on the card until it is firmly seated. <p>To remove a card:</p> <ul style="list-style-type: none"> ▲ Press in on the card it until it pops out.

Right side

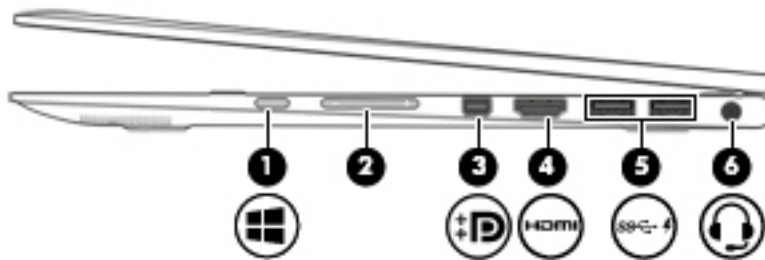

Item	Component	Description
(1)	Windows button	<p>Returns you to the Start screen from an open app or the Windows desktop.</p> <p>NOTE: Pressing the Windows button again will return you to the previous screen.</p>
(2)	Volume button	Controls speaker volume.
(3)	Mini DisplayPort	Connects an optional digital display device, such as a high-performance monitor or projector.
(4)	HDMI port	Connects an optional video or audio device, such as a high-definition television, any compatible digital or audio component, or a high-speed High-Definition Multimedia Interface (HDMI) device.
(5)	USB 3.0 charging (powered) ports	<p>Connect an optional USB device, such as a keyboard, mouse, external drive, printer, scanner or USB hub. Standard USB ports will not charge all USB devices or will charge using a low current. Some USB devices require power and require you to use a powered port.</p> <p>NOTE: USB charging ports can also charge select models of cell phones and MP3 players, even when the computer is off.</p>
(6)	Audio-out (headphone)/Audio-in (microphone) jack	<p>Connects optional powered stereo speakers, headphones, earbuds, a headset, or a television audio cable. Also connects an optional headset microphone. This jack does not support optional microphone-only devices.</p> <p>WARNING! To reduce the risk of personal injury, adjust the volume before putting on headphones, earbuds, or a headset. For additional safety information, refer to the <i>Regulatory, Safety, and Environmental Notices</i>.</p> <p>To access this document:</p> <ul style="list-style-type: none"> ▲ From the Start screen, type <code>support</code>, and then select the HP Support Assistant app. – or – From the Windows desktop, click the question mark icon in the notification area, at the far right of the taskbar. <p>NOTE: When a device is connected to the jack, the computer speakers are disabled.</p> <p>NOTE: Be sure that the device cable has a 4-conductor connector that supports both audio-out (headphone) and audio-in (microphone).</p>

3 Illustrated parts catalog

 **NOTE:** HP continually improves and changes product parts. For complete and current information on supported computer parts, go to <http://partsurfer.hp.com>, select the country or region, and then follow the on-screen instructions.

Locating the serial number, product number, and model number

The warranty **(1)**, model name **(2)**, serial number **(3)**, and product number **(4)** information are located on the bottom of the computer. This information may be needed when traveling internationally or contacting support.

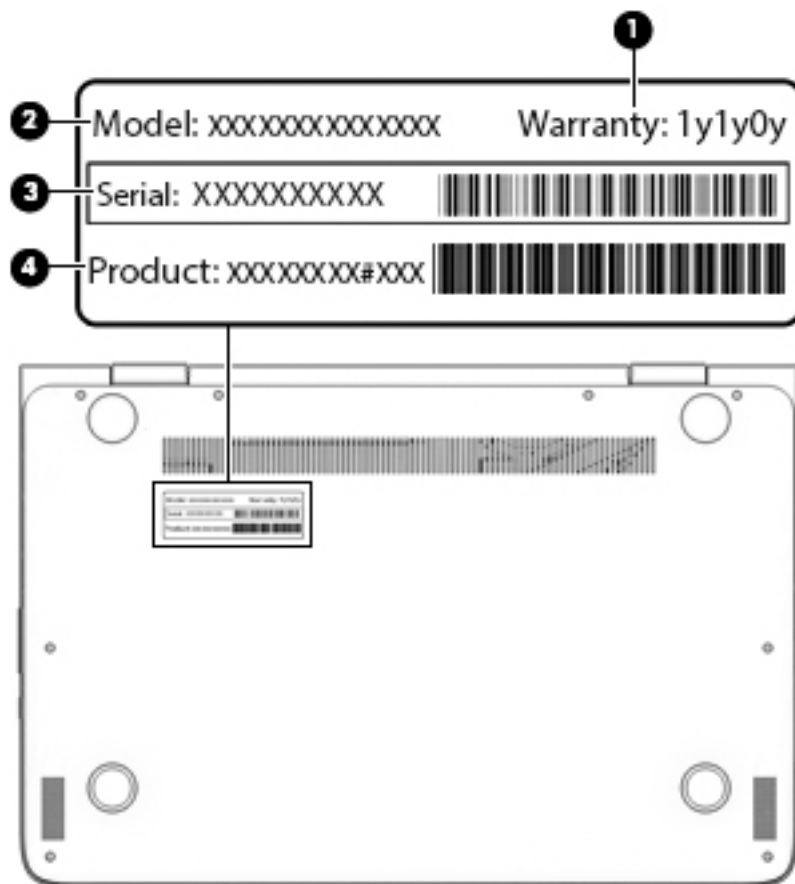

Computer major components

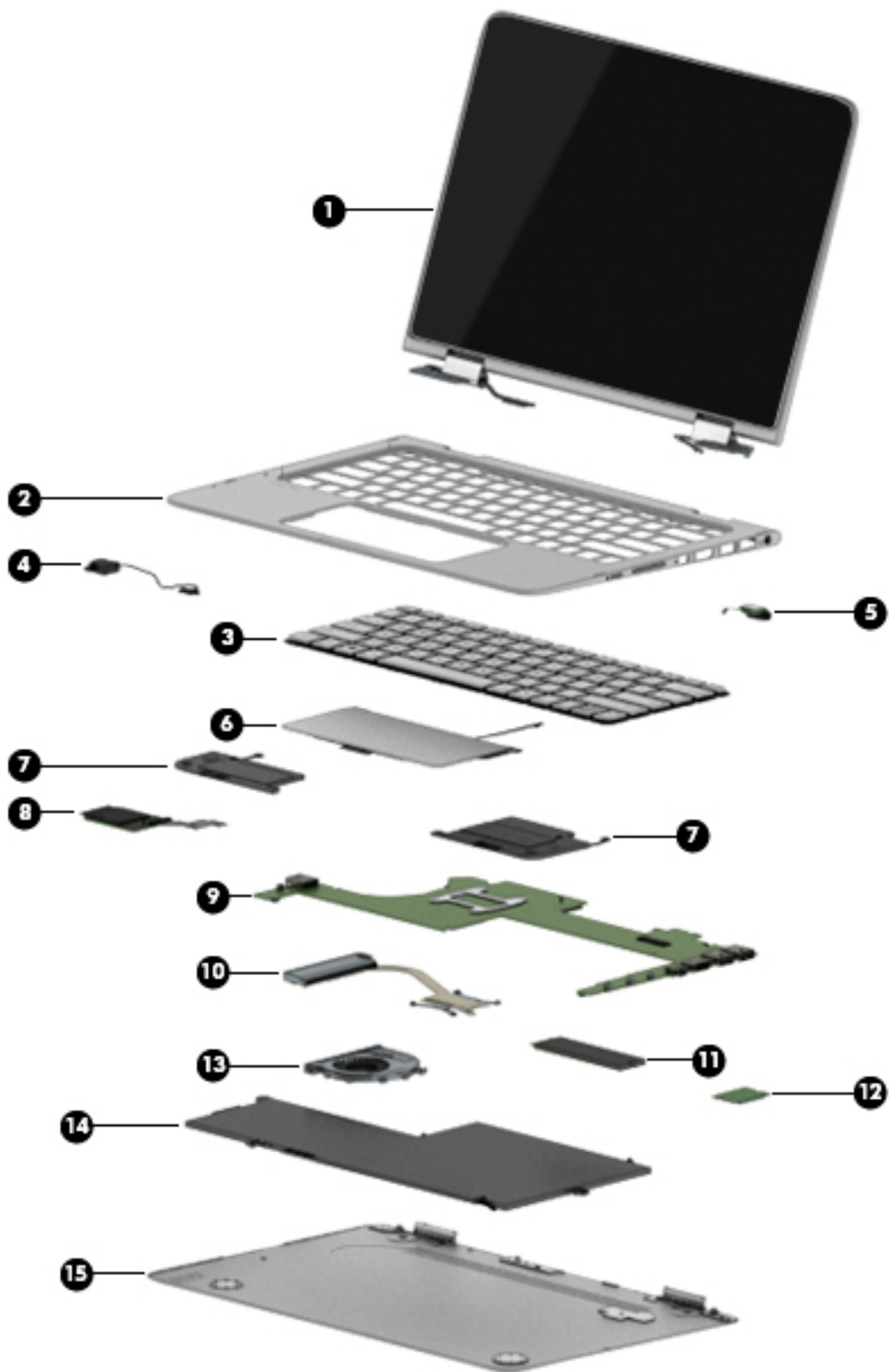

Item	Component	Spare part number
(1)	Display assembly: 13.3-in, ultra wide aspect ratio, TouchScreen (includes display panel cable, microphones, hinges, webcam, and wireless antenna cables and transceivers)	
	13.3-in, QHD, WLED, BrightView (2560×1440), UWVA, 2.55-mm display assembly	828823-001
	13.3-in, FHD, WLED, BrightView (1920×1080), UWVA, 2.55-mm display assembly	828822-001
(2)	Top cover	831855-001
(3)	Keyboard (includes keyboard cable, keyboard backlight cable, and pointing stick cable):	
	For use in Belgium	801508-A41
	For use in Canada	801508-DB1
	For use in the Czech Republic and Slovakia	801508-FL1
	For use in Denmark, Finland, and Norway	801508-DH1
	For use in France	801508-051
	For use in Germany	801508-041
	For use in Greece	801508-151
	For use in India (does not include pointing stick)	801508-D61
	For use in Israel (does not include pointing stick)	801508-BB1
	For use in Italy	801508-061
	For use in Japan (does not include pointing stick)	801508-291
	For use in Latin America	801508-161
	For use in the Netherlands	801508-B31
	For use in Portugal	801508-131
	For use in Russia	801508-251
	For use in Saudi Arabia	801508-171
	For use in South Korea	801508-AD1
	For use in Spain	801508-071
	For use in Switzerland	801508-BG1
	For use in Turkey	801508-141
	For use in the United Kingdom and Singapore	801508-031
	For use in the United States	801508-001
(4)	Power connector cable	801513-001
(5)	Audio jack board (includes cable)	828820-001
(6)	TouchPad (includes cable)	801499-001
(7)	Speakers (includes left and right speakers and cables)	801501-001
(8)	Card reader board (includes cable)	828821-001
(9)	System board (includes a graphics subsystem with UMA memory and replacement thermal material):	

Item	Component	Spare part number
	Equipped with an Intel Core i7-6600U 2.60-GHz (SC turbo up to 3.4-GHz) processor (1600-MHz FSB, 4.00-MB L2 cache, dual core, 15 W), 8.0-GB of system memory, and the Windows 10 operating system	847450-601
	Equipped with an Intel Core i5-6300U 2.40-GHz (SC turbo up to 3.00-GHz) processor (1866-MHz FSB, 3.00-MB L2 cache, dual core, 15 W), 8.0-GB of system memory, and the Windows 10 operating system	847448-601
	Equipped with an Intel Core i5-6300U 2.40-GHz (SC turbo up to 3.00-GHz) processor (1866-MHz FSB, 3.00-MB L2 cache, dual core, 15 W), 4.0-GB of system memory, and the Windows 10 operating system	847447-601
	Equipped with an Intel Core i5-6200U 2.30-GHz (SC turbo up to 2.80-GHz) processor (1866-MHz FSB, 3.00-MB L2 cache, dual core, 15 W), 8.0-GB of system memory, and the Windows 10 operating system	849426-601
	Equipped with an Intel Core i5-6200U 2.30-GHz (SC turbo up to 2.80-GHz) processor (1866-MHz FSB, 3.00-MB L2 cache, dual core, 15 W), 4.0-GB of system memory, and the Windows 10 operating system	849427-601
(10)	Heat sink (includes replacement thermal material)	828819-001
(11)	Solid-state drive:	
	512-GB, M2, SATA-3 solid-state drive supporting TLC	847455-001
	256-GB, M2, SATA-3 solid-state drive supporting TLC	847454-001
	256-GB, M2, SATA-3, SED, solid-state drive supporting Opal2	847453-001
	180-GB, M2, SATA-3 solid-state drive supporting MLC	847452-001
	128-GB, M2, SATA-3 solid-state drive supporting TLC	847451-001
(12)	Intel Dual band wireless-AC 8260 802.11 AC 2x2 WiFi + Bluetooth 4.0 Combo Adapter	806721-001
(13)	Fan (includes cable)	828818-001
(14)	Battery , 3-cell, 56-WHr, 4096-mAhr, Li-ion (includes cable)	789116-005
(15)	Bottom cover (includes 4 rubber feet)	801492-001

Miscellaneous parts

Component	Spare part number
AC adapter:	
65-W HP Smart adapter (non-PFC, 3-wire, 4.5-mm)	693711-001
45-W HP Smart adapter (non-PFC, RC, 3-wire, 4.5-mm)	741727-001
45-W HP Smart adapter (non-PFC, RC, 2-wire, 4.5-mm)	742436-001
HP HDMI-to-VGA adapter	701943-001
HP RJ45-to-USB adapter dongle	539614-001
HP USB external DVD-RW Drive	747080-001
Mouse:	
HP comfort grip wireless mouse	691922-001

Component	Spare part number
HP ultrathin Bluetooth mouse	811730-001
HP USB laser mouse	674318-001
Power cord (3-pin, black, 1.83-m):	
For use in Australia	490371-011
For use in Denmark	490371-081
For use in Europe	490371-021
For use in India	490371-D61
For use in Israel	490371-BB1
For use in Italy	490371-061
For use in Japan	490371-291
For use in North America	490371-001
For use in South Korea	490371-AD1
For use in Switzerland	490371-111
For use in the United Kingdom and Singapore	490371-031
Power cord (3-pin, black, 1.00-m):	
For use in Australia	755530-011
For use in Denmark	755530-081
For use in Europe	755530-021
For use in India	755530-D61
For use in Israel	755530-BB1
For use in Italy	755530-061
For use in Japan	755530-291
For use in North America	755530-001
For use in South Korea	755530-AD1
For use in Switzerland	755530-111
For use in the United Kingdom and Singapore	755530-031
Screw Kit	801500-001

4 Removal and replacement preliminary requirements

Tools required

You will need the following tools to complete the removal and replacement procedures:

- Flat-bladed screw driver
- Magnetic screw driver
- Phillips P0 screw driver

Service considerations

The following sections include some of the considerations that you must keep in mind during disassembly and assembly procedures.

 **NOTE:** As you remove each subassembly from the tablet, place the subassembly (and all accompanying screws) away from the work area to prevent damage.

Plastic parts

 **CAUTION:** Using excessive force during disassembly and reassembly can damage plastic parts. Use care when handling the plastic parts. Apply pressure only at the points designated in the maintenance instructions.

Cables and connectors

 **CAUTION:** When servicing the tablet, be sure that cables are placed in their proper locations during the reassembly process. Improper cable placement can damage the tablet.

Cables must be handled with extreme care to avoid damage. Apply only the tension required to unseat or seat the cables during removal and insertion. Handle cables by the connector whenever possible. In all cases, avoid bending, twisting, or tearing cables. Be sure that cables are routed in such a way that they cannot be caught or snagged by parts being removed or replaced. Handle flex cables with extreme care; these cables tear easily.

Grounding guidelines

Electrostatic discharge damage

Electronic components are sensitive to electrostatic discharge (ESD). Circuitry design and structure determine the degree of sensitivity. Networks built into many integrated circuits provide some protection, but in many cases, ESD contains enough power to alter device parameters or melt silicon junctions.

A discharge of static electricity from a finger or other conductor can destroy static-sensitive devices or microcircuitry. Even if the spark is neither felt nor heard, damage may have occurred.

An electronic device exposed to ESD may not be affected at all and can work perfectly throughout a normal cycle. Or the device may function normally for a while, then degrade in the internal layers, reducing its life expectancy.

⚠ CAUTION: To prevent damage to the tablet when you are removing or installing internal components, observe these precautions:

Keep components in their electrostatic-safe containers until you are ready to install them.

Before touching an electronic component, discharge static electricity by using the guidelines described in this section.

Avoid touching pins, leads, and circuitry. Handle electronic components as little as possible.

If you remove a component, place it in an electrostatic-safe container.

The following table shows how humidity affects the electrostatic voltage levels generated by different activities.

⚠ CAUTION: A product can be degraded by as little as 700 V.

Typical electrostatic voltage levels			
Event	Relative humidity		
	10%	40%	55%
Walking across carpet	35,000 V	15,000 V	7,500 V
Walking across vinyl floor	12,000 V	5,000 V	3,000 V
Motions of bench worker	6,000 V	800 V	400 V
Removing DIPS from plastic tube	2,000 V	700 V	400 V
Removing DIPS from vinyl tray	11,500 V	4,000 V	2,000 V
Removing DIPS from Styrofoam	14,500 V	5,000 V	3,500 V
Removing bubble pack from PCB	26,500 V	20,000 V	7,000 V
Packing PCBs in foam-lined box	21,000 V	11,000 V	5,000 V

Packaging and transporting guidelines

Follow these grounding guidelines when packaging and transporting equipment:

- To avoid hand contact, transport products in static-safe tubes, bags, or boxes.
- Protect ESD-sensitive parts and assemblies with conductive or approved containers or packaging.
- Keep ESD-sensitive parts in their containers until the parts arrive at static-free workstations.
- Place items on a grounded surface before removing items from their containers.
- Always be properly grounded when touching a component or assembly.
- Store reusable ESD-sensitive parts from assemblies in protective packaging or nonconductive foam.
- Use transporters and conveyors made of antistatic belts and roller bushings. Be sure that mechanized equipment used for moving materials is wired to ground and that proper materials are selected to avoid static charging. When grounding is not possible, use an ionizer to dissipate electric charges.

Workstation guidelines

Follow these grounding workstation guidelines:

- Cover the workstation with approved static-shielding material.
- Use a wrist strap connected to a properly grounded work surface and use properly grounded tools and equipment.
- Use conductive field service tools, such as cutters, screw drivers, and vacuums.
- When fixtures must directly contact dissipative surfaces, use fixtures made only of static-safe materials.
- Keep the work area free of nonconductive materials, such as ordinary plastic assembly aids and Styrofoam.
- Handle ESD-sensitive components, parts, and assemblies by the case or PCM laminate. Handle these items only at static-free workstations.
- Avoid contact with pins, leads, or circuitry.
- Turn off power and input signals before inserting or removing connectors or test equipment.

Equipment guidelines

Grounding equipment must include either a wrist strap or a foot strap at a grounded workstation.

- When seated, wear a wrist strap connected to a grounded system. Wrist straps are flexible straps with a minimum of one megohm $\pm 10\%$ resistance in the ground cords. To provide proper ground, wear a strap snugly against the skin at all times. On grounded mats with banana-plug connectors, use alligator clips to connect a wrist strap.
- When standing, use foot straps and a grounded floor mat. Foot straps (heel, toe, or boot straps) can be used at standing workstations and are compatible with most types of shoes or boots. On conductive floors or dissipative floor mats, use foot straps on both feet with a minimum of one megohm resistance between the operator and ground. To be effective, the conductive must be worn in contact with the skin.

The following grounding equipment is recommended to prevent electrostatic damage:

- Antistatic tape
- Antistatic smocks, aprons, and sleeve protectors
- Conductive bins and other assembly or soldering aids
- Nonconductive foam
- Conductive tabletop workstations with ground cords of one megohm resistance
- Static-dissipative tables or floor mats with hard ties to the ground
- Field service kits
- Static awareness labels
- Material-handling packages
- Nonconductive plastic bags, tubes, or boxes
- Metal tote boxes
- Electrostatic voltage levels and protective materials

The following table lists the shielding protection provided by antistatic bags and floor mats.

Material	Use	Voltage protection level
Antistatic plastics	Bags	1,500 V
Carbon-loaded plastic	Floor mats	7,500 V
Metallized laminate	Floor mats	5,000 V

5 Removal and replacement procedures

 **NOTE:** This chapter provides removal and replacement procedures for Authorized Service Provider only components. Components described in this chapter should only be accessed by an authorized service provider. Accessing these components can damage the computer or void the warranty.

There are as many as 92 screws that must be removed, replaced, and/or loosened when servicing the computer. Make special note of each screw size and location during removal and replacement.

 **NOTE:** HP continually improves and changes product parts. For complete and current information on supported parts for your computer, go to <http://partsurfer.hp.com>, select your country or region, and then follow the on-screen instructions.

Unlocking the device and disabling Always On Remote Management (select HP devices only)

HP Touchpoint Manager (HPTM) is a complete cloud-based solution for managing devices. For select HP devices with the Windows operating system, the Always On Remote Management (AORM) feature is automatically activated when HP Touchpoint Manager software is installed.

AORM can perform a secure BIOS level lock and can also securely erase internal drives (except for encrypted self-encrypting drives). The HP Touchpoint Manager website (<http://www.hptouchpointmanager.com>) provides access to the AORM lock feature. The device must be unlocked using an authorized PIN from the same website before you can access HP Computer Setup and start the Windows operating system.

 **IMPORTANT:** A service agent cannot retrieve the PIN from the HP Touchpoint Manager website. If a locked device is returned for service, the agent must contact the customer to obtain the PIN to unlock the device. If a PIN is not available, the entire system board must be replaced.

Before returning the device for service, be sure to unlock the device using the PIN from the HP Touchpoint Manager website (<http://www.hptouchpointmanager.com>), and also disable the AORM feature in HP Computer Setup.

To disable AORM:

1. Access HP Computer Setup (F10).
 - a. Turn on or restart the device, and then press **esc** while the “Press the ESC key for Startup Menu” message is displayed at the bottom of the screen.
 - b. Press **f10** to enter Computer Setup.

 **NOTE:** If the BIOS is protected with an Administrator password, enter the password.

2. Select **Advanced**, and then select **HP Touchpoint Manager Options**.
3. Clear the **Allow Activation** check box.
4. Select **Save changes and exit**.

Bottom cover

Description	Spare part number
Bottom cover (includes 4 rubber feet)	801492-001

Before disassembling the computer, follow these steps:

1. Turn off the computer. If you are unsure whether the computer is off or in Hibernation, turn the computer on, and then shut it down through the operating system.
2. Disconnect the power from the computer by unplugging the power cord from the computer.
3. Disconnect all external devices from the computer.

Remove the bottom cover:

1. Close the computer.
2. Turn the computer upside down with the front toward you.
3. Remove the two Torx5 T5M2.0×8.0 screws **(1)** and the six Torx5 T5M2.0×3.9 screws **(2)** that secure the bottom cover to the computer.

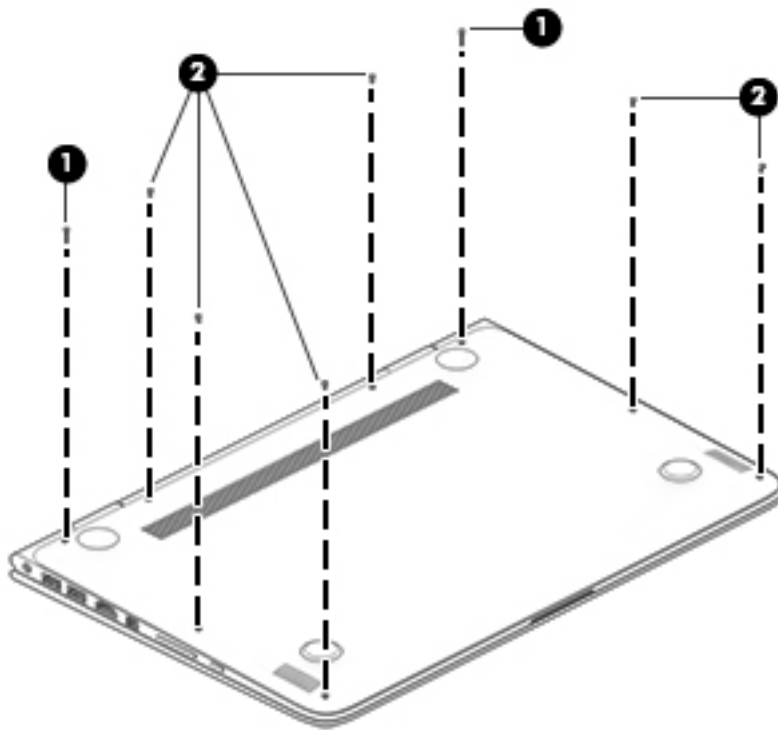

4. Separate the rear edge of the bottom cover **(1)** from the top cover until it rests at an angle.

5. Remove the bottom cover **(2)**.

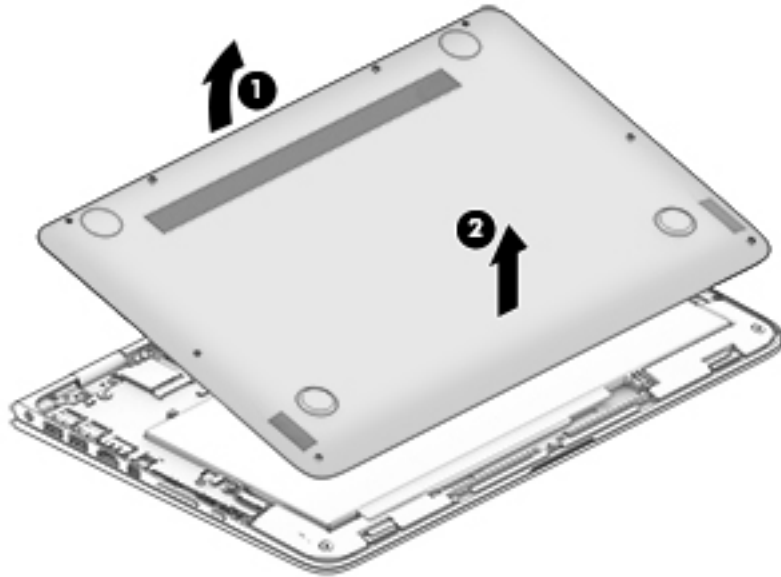

Reverse this procedure to install the bottom cover.

Battery

Description	Spare part number
Battery, 3-cell, 56-WHr, 4096-mAhr, Li-ion (includes cable)	789116-005

Before removing the battery, follow these steps:

1. Shut down the computer. If you are unsure whether the computer is off or in Hibernation, turn the computer on, and then shut it down through the operating system.
2. Disconnect all external devices connected to the computer.
3. Disconnect the power from the computer by first unplugging the power cord from the AC outlet and then unplugging the AC adapter from the computer.
4. Remove the bottom cover (see [Bottom cover on page 22](#)).

WARNING! To reduce potential safety issues, use only the battery provided with the computer, a replacement battery provided by HP, or a compatible battery purchased from HP.

CAUTION: Removing a battery that is the sole power source for the computer can cause loss of information. To prevent loss of information, save your work or shut down the computer through Windows before removing the battery.

Remove the battery:

1. Disconnect the battery cable **(1)** from the system board.
2. Release the battery cable from the routing channel **(2)** built into the battery.
3. Release the speaker cable from the routing channel **(3)** built into the battery.
4. Remove the four PM2.0×4.0 screws **(4)** that secure the battery to the top cover.

5. Remove the battery (5).

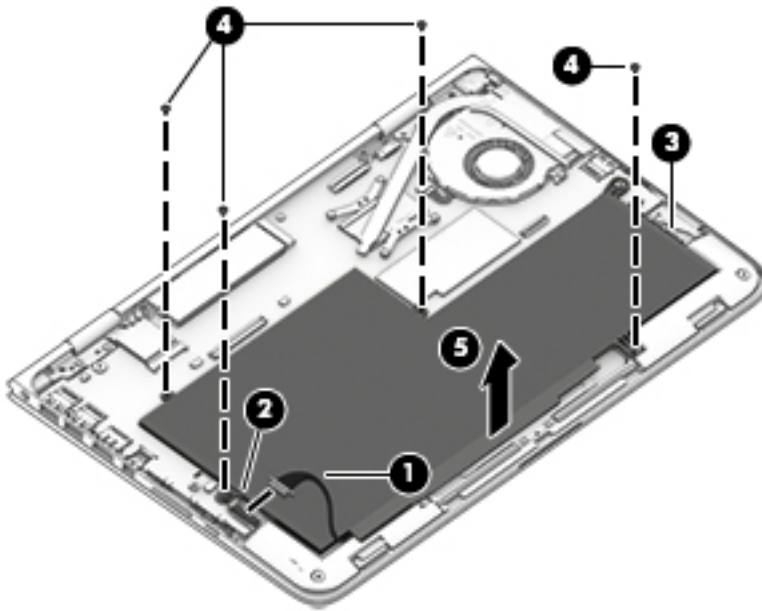

Reverse this procedure to install the battery.

WLAN module

Description	Spare part number
Intel Dual band wireless-AC 8260 802.11AC 2x2 WiFi + Bluetooth 4.0 Combo Adapter	806721-001

CAUTION: To prevent an unresponsive system, replace the wireless module only with a wireless module authorized for use in the computer by the governmental agency that regulates wireless devices in your country or region. If you replace the module and then receive a warning message, remove the module to restore device functionality, and then contact technical support.

Before removing the WLAN module, follow these steps:

1. Shut down the computer. If you are unsure whether the computer is off or in Hibernation, turn the computer on, and then shut it down through the operating system.
2. Disconnect all external devices connected to the computer.
3. Disconnect the power from the computer by first unplugging the power cord from the AC outlet and then unplugging the AC adapter from the computer.
4. Remove the bottom cover (see [Bottom cover on page 22](#)).
5. Disconnect the battery cable from the system board (see [Battery on page 23](#)).

Remove the WLAN module:

1. Disconnect the WLAN antenna cables (1) from the terminals on the WLAN module.

 **NOTE:** The WLAN antenna cable labeled “1” connects to the WLAN module “Main” terminal labeled “1”. The WLAN antenna cable labeled “2” connects to the WLAN module “Aux” terminal labeled “2”.

2. Remove the Phillips PM2.0×2.7 screw **(2)** that secures the WLAN module to the top cover. (The WLAN module tilts up.)
3. Remove the WLAN module **(3)** by pulling the module away from the slot at an angle.

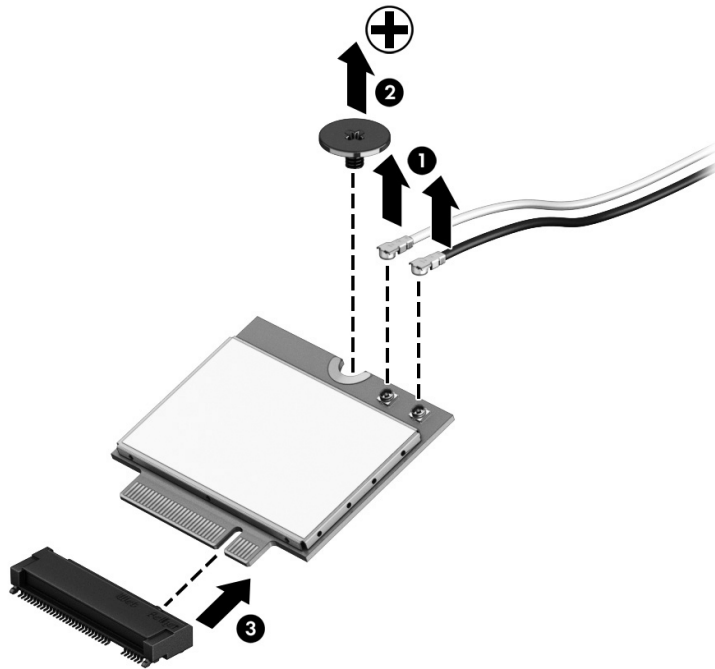

 **NOTE:** If the WLAN antenna cables are not connected to the terminals on the WLAN module, protective sleeves should be installed on the antenna connectors, as shown in the following illustration.

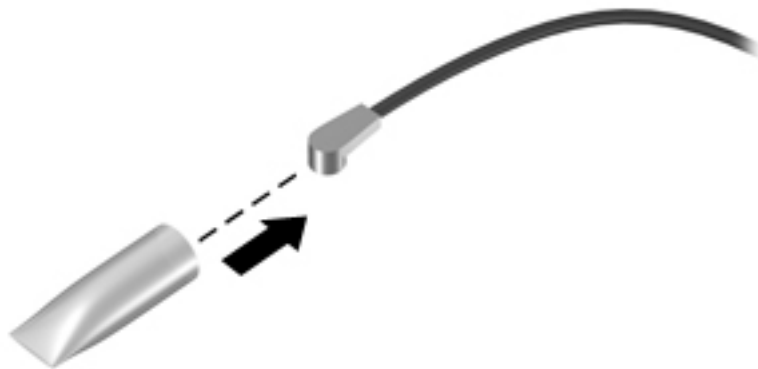

Reverse this procedure to install the WLAN module.

Solid-state drive

Description	Spare part number
512-GB, M2, SATA-3 solid-state drive supporting TLC	847455-001
256-GB, M2, SATA-3 solid-state drive supporting TLC	847454-001
256-GB, M2, SATA-3, SED solid-state drive supporting Opal2	847453-001
180-GB, M2, SATA-3 solid-state drive supporting MLC	847452-001
128-GB, M2, SATA-3 solid-state drive supporting TLC	847451-001

Before removing the solid-state drive, follow these steps:

1. Shut down the computer. If you are unsure whether the computer is off or in Hibernation, turn the computer on, and then shut it down through the operating system.
2. Disconnect all external devices connected to the computer.
3. Disconnect the power from the computer by first unplugging the power cord from the AC outlet and then unplugging the AC adapter from the computer.
4. Remove the bottom cover (see [Bottom cover on page 22](#)).
5. Disconnect the battery cable from the system board (see [Battery on page 23](#)).

Remove the solid-state drive:

1. Remove the PM2.0×2.9 screw **(1)** that secures the solid-state drive to the bottom cover. (The solid-state drive tilts up.)
2. Remove the solid-state drive **(2)** by pulling the drive away from the slot at an angle.

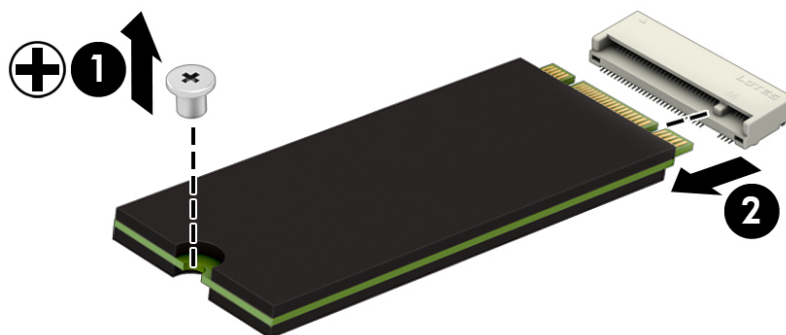

Reverse this procedure to install the solid-state drive.

Fan

Description	Spare part number
Fan (includes cable)	828818-001

 **NOTE:** To properly ventilate the computer, allow at least 7.6 cm (3 in) of clearance on the left side of the computer. The computer uses an electric fan for ventilation. The fan is controlled by a temperature sensor and is designed to turn on automatically when high temperature conditions exist. These conditions are affected by high external temperatures, system power consumption, power management/battery conservation configurations, battery fast charging, and software requirements. Exhaust air is displaced through the ventilation grill located on the left side of the computer.

Before removing the fan, follow these steps:

1. Shut down the computer. If you are unsure whether the computer is off or in Hibernation, turn the computer on, and then shut it down through the operating system.
2. Disconnect all external devices connected to the computer.
3. Disconnect the power from the computer by first unplugging the power cord from the AC outlet and then unplugging the AC adapter from the computer.
4. Remove the bottom cover (see [Bottom cover on page 22](#)).
5. Disconnect the battery cable from the system board (see [Battery on page 23](#)).

Remove the fan:

1. Disconnect the fan cable **(1)** from the system board.
2. Remove the two Phillips PM2.0×4.0 screws **(2)** that secure the fan to the top cover.
3. Remove the fan **(3)**.

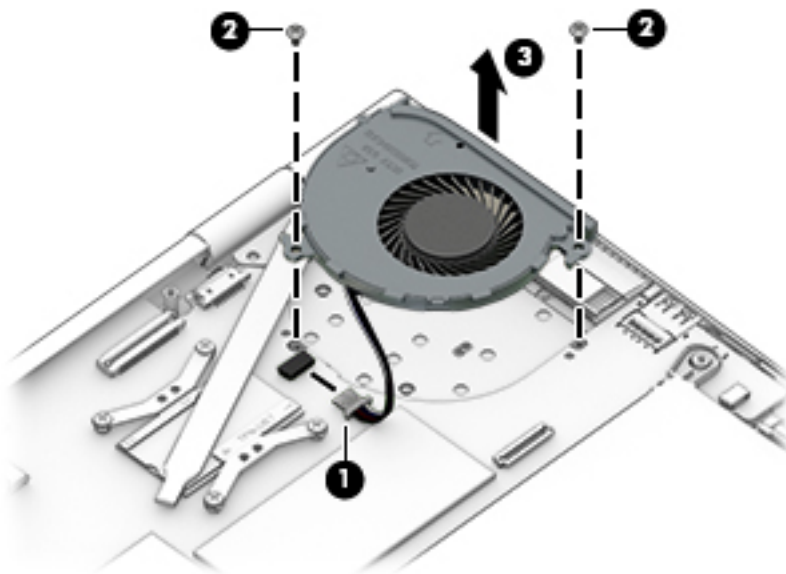

Reverse this procedure to install the fan.

Speakers

Description	Spare part number
Speakers (include left and right speakers and cables)	801501-001

Before removing the speakers, follow these steps:

1. Shut down the computer. If you are unsure whether the computer is off or in Hibernation, turn the computer on, and then shut it down through the operating system.
2. Disconnect all external devices connected to the computer.
3. Disconnect the power from the computer by first unplugging the power cord from the AC outlet and then unplugging the AC adapter from the computer.
4. Remove the bottom cover (see [Bottom cover on page 22](#)).
5. Disconnect the battery cable from the system board (see [Battery on page 23](#)).

Remove the speakers:

1. Disconnect the speaker cables **(1)** from the system board.
2. Remove the three Phillips PM2.0×2.7 screws **(2)** that secure the speakers to the top cover.
3. Remove the speakers **(3)**.

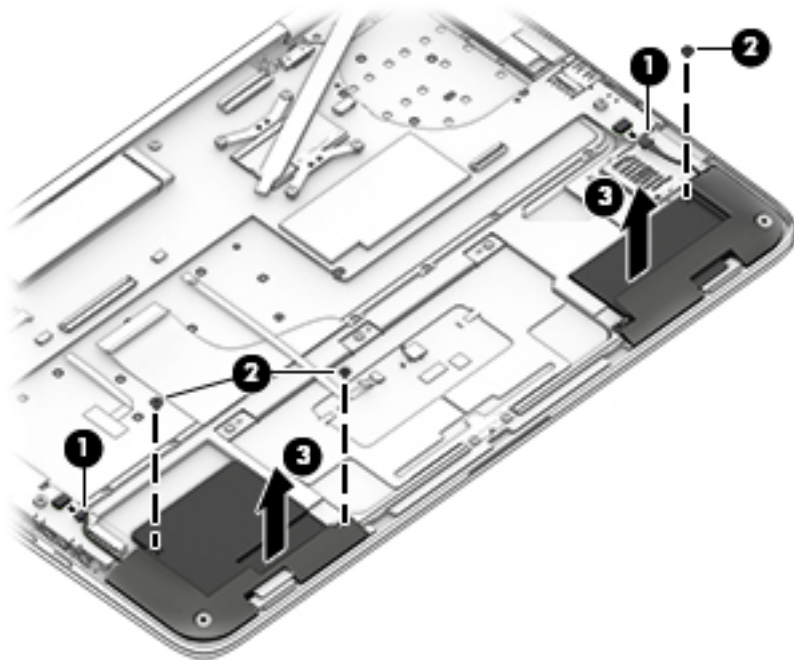

Reverse this procedure to install the speakers.

TouchPad

Description	Spare part number
TouchPad (includes cable)	801499-001

Before removing the TouchPad, follow these steps:

1. Turn off the computer. If you are unsure whether the computer is off or in Hibernation, turn the computer on, and then shut it down through the operating system.
2. Disconnect the power from the computer by unplugging the power cord from the computer.
3. Disconnect all external devices from the computer.
4. Remove the bottom cover (see [Bottom cover on page 22](#)).
5. Remove the battery (see [Battery on page 23](#)).

Remove the TouchPad:

1. Release the zero insertion force (ZIF) connector (1) to which the TouchPad cable is attached, and then disconnect the TouchPad cable from the system board.
2. Remove the five Phillips PM1.5×2.3 screws (2) that secure the TouchPad to the top cover.

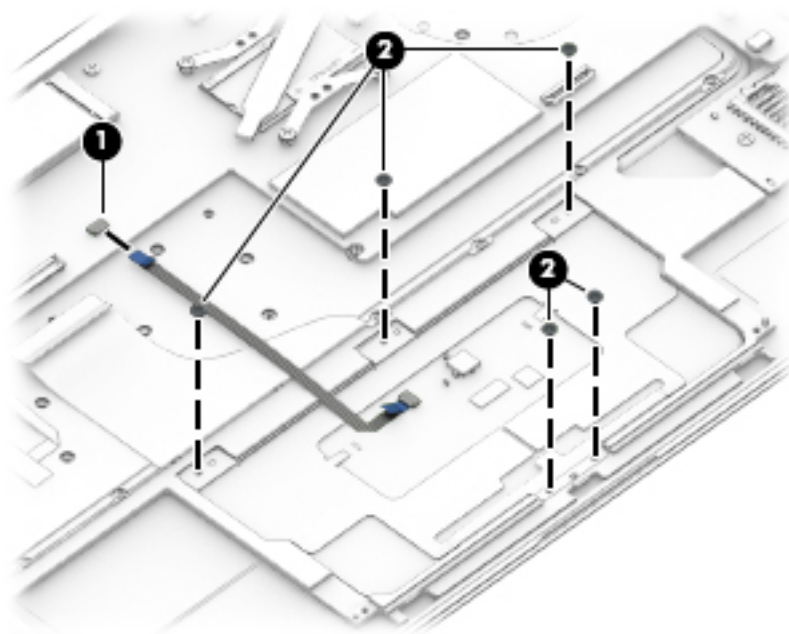

3. Remove the TouchPad and cable.

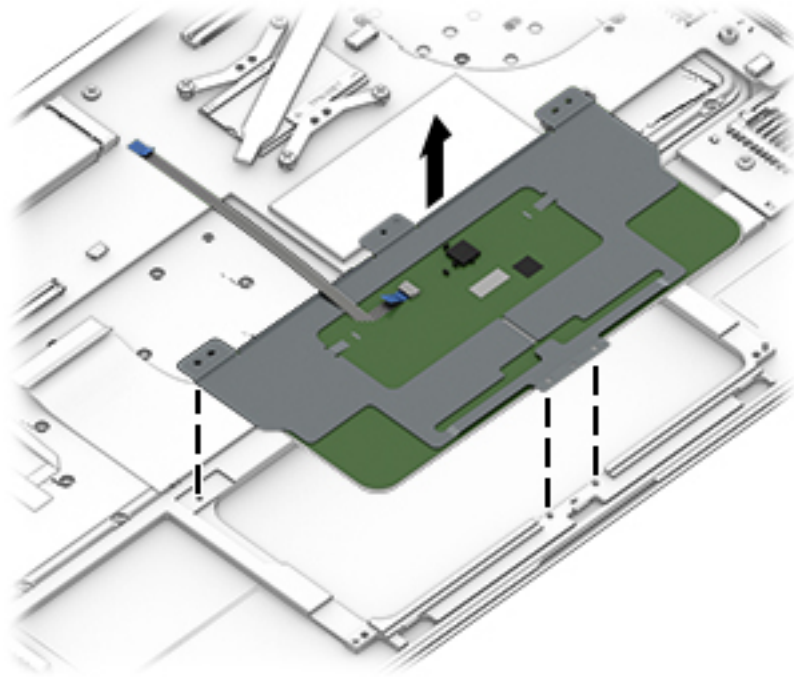

Reverse this procedure to install the TouchPad.

Card reader board

Description	Spare part number
Card reader board (includes cable)	828821-001

Before removing the card reader board, follow these steps:

1. Turn off the computer. If you are unsure whether the computer is off or in Hibernation, turn the computer on, and then shut it down through the operating system.
2. Disconnect the power from the computer by unplugging the power cord from the computer.
3. Disconnect all external devices from the computer.
4. Remove the bottom cover (see [Bottom cover on page 22](#)).
5. Remove the battery (see [Battery on page 23](#)).
6. Remove the speakers (see [Speakers on page 28](#)).

Remove the card reader board:

1. Release the ZIF connector **(1)** to which the card reader board cable is attached, and then disconnect the card reader board cable from the system board.
2. Remove the Phillips PM2.0×2.7 screw **(2)** that secures the card reader board to the top cover.

3. Remove the card reader board **(3)** and cable from the top cover.

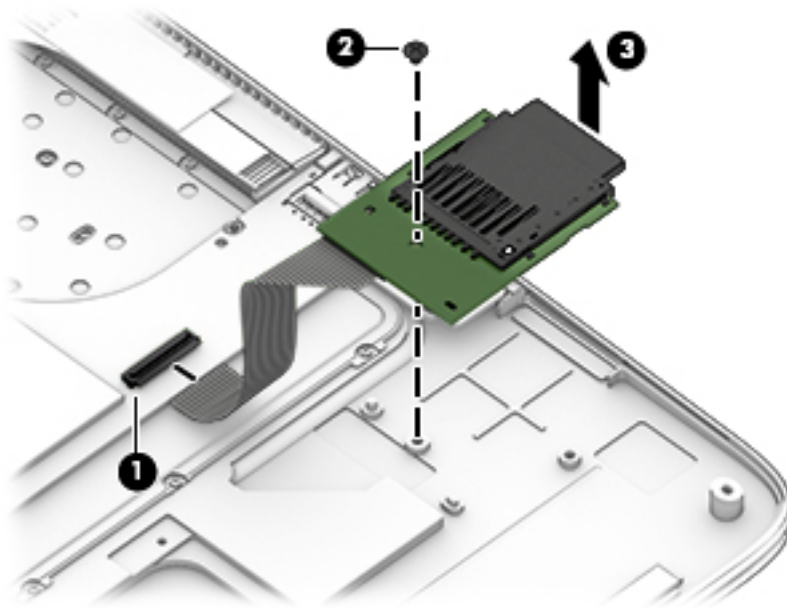

4. Remove the card reader board.

Reverse this procedure to install the card reader board.

System board

 **NOTE:** The system board spare part kit includes a graphics subsystem with UMA memory and replacement thermal material.

Description	Spare part number
Equipped with an Intel Core i7-6600U 2.60-GHz (SC turbo up to 3.4-GHz) processor (1600-MHz FSB, 4.00-MB L2 cache, dual core, 15 W), 8.0-GB of system memory, and the Windows 10 operating system	847450-601
Equipped with an Intel Core i5-6300U 2.40-GHz (SC turbo up to 3.00-GHz) processor (1866-MHz FSB, 3.00-MB L2 cache, dual core, 15 W), 8.0-GB of system memory, and the Windows 10 operating system	847448-601
Equipped with an Intel Core i5-6300U 2.40-GHz (SC turbo up to 3.00-GHz) processor (1866-MHz FSB, 3.00-MB L2 cache, dual core, 15 W), 4.0-GB of system memory, and the Windows 10 operating system	847447-601
Equipped with an Intel Core i5-6200U 2.30-GHz (SC turbo up to 2.80-GHz) processor (1866-MHz FSB, 3.00-MB L2 cache, dual core, 15 W), 8.0-GB of system memory, and the Windows 10 operating system	849426-601
Equipped with an Intel Core i5-6200U 2.30-GHz (SC turbo up to 2.80-GHz) processor (1866-MHz FSB, 3.00-MB L2 cache, dual core, 15 W), 4.0-GB of system memory, and the Windows 10 operating system	849427-601

Before removing the system board, follow these steps:

1. Shut down the computer. If you are unsure whether the computer is off or in Hibernation, turn the computer on, and then shut it down through the operating system.
2. Disconnect all external devices connected to the computer.
3. Disconnect the power from the computer by first unplugging the power cord from the AC outlet and then unplugging the AC adapter from the computer.

4. Remove the bottom cover (see [Bottom cover on page 22](#)).
5. Remove the battery (see [Battery on page 23](#)).
6. Remove the fan (see [Fan on page 27](#)).

When replacing the system board, be sure that the following components are removed from the defective system board and installed on the replacement system board:

- WLAN module (see [WLAN module on page 24](#))
- Solid-state drive (see [Solid-state drive on page 26](#))
- Heat sink (see [Heat sink on page 34](#))

Remove the system board:

1. Release the ZIF connector **(1)** to which the audio jack cable is attached, and then disconnect the audio jack cable from the system board.
2. Disconnect the WLAN antenna cables **(2)** from the terminals on the WLAN module.

 **NOTE:** The WLAN antenna cable labeled “1” connects to the WLAN module “Main” terminal labeled “1”. The WLAN antenna cable labeled “2” connects to the WLAN module “Aux” terminal labeled “2”.

3. Release the ZIF connector **(3)** to which the display panel cable is attached, and then disconnect the display panel cable from the system board.
4. Disconnect the power connector cable **(4)** from the system board.

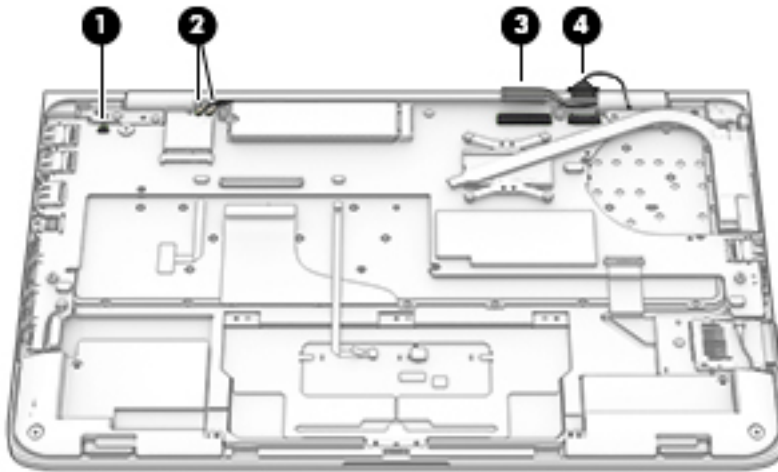

5. Disconnect the speaker cables **(1)** from the system board.
6. Release the ZIF connector **(2)** to which the keyboard backlight cable is attached, and then disconnect the keyboard backlight cable from the system board.
7. Release the ZIF connector **(3)** to which the keyboard cable is attached, and then disconnect the keyboard cable from the system board.
8. Release the ZIF connector **(4)** to which the TouchPad cable is attached, and then disconnect the TouchPad cable from the system board.

9. Release the ZIF connector (5) to which the card reader board cable is attached, and then disconnect the card reader board cable from the system board.

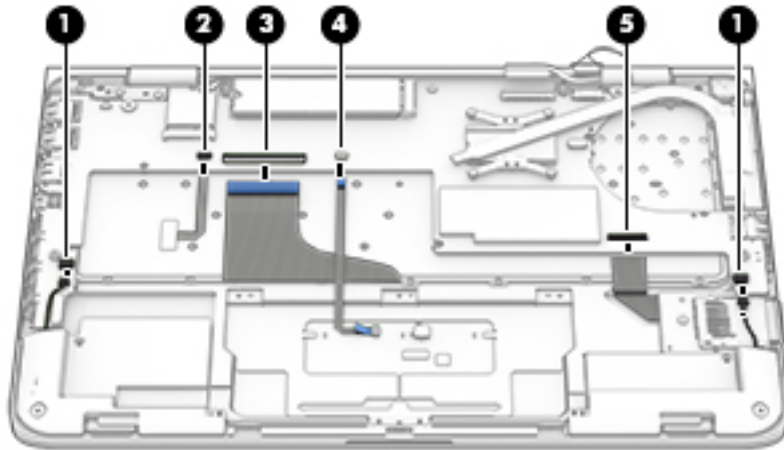

10. Remove the Phillips PM2.0×2.6 broad head screw (1) and the Phillips PM2.0×2.7 screw (2) that secure the system board to the top cover.
11. Lift the front edge system board (3) until it rests at an angle.
12. Remove the system board (4) by sliding it up and forward at an angle.

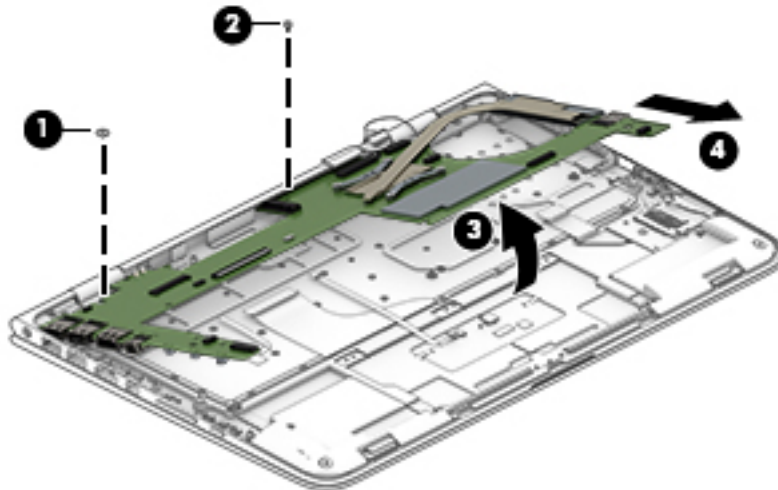

Reverse this procedure to install the system board.

Heat sink

Description	Spare part number
Heat sink (includes replacement thermal material)	828819-001

Before removing the heat sink, follow these steps:

1. Shut down the computer. If you are unsure whether the computer is off or in Hibernation, turn the computer on, and then shut it down through the operating system.
2. Disconnect all external devices connected to the computer.
3. Disconnect the power from the computer by first unplugging the power cord from the AC outlet and then unplugging the AC adapter from the computer.
4. Remove the bottom cover (see [Bottom cover on page 22](#)), and then remove the following components:
 - a. Remove the battery (see [Battery on page 23](#)).
 - b. Remove the fan (see [Fan on page 27](#)).
 - c. Remove the system board (see [System board on page 31](#)).

Remove the heat sink:

1. Loosen the four captive Phillips PM2.0×2.7 screws **(1)** that secure the heat sink to the system board.



NOTE: Due to the adhesive quality of the thermal material located between the heat sink and system board components, it may be necessary to move the heat sink from side to side to detach it.

2. Remove the heat sink **(2)**.

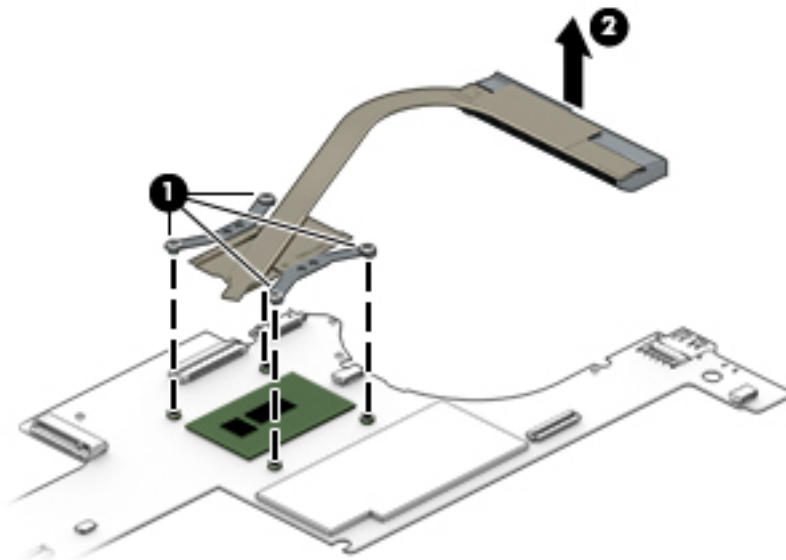

NOTE: The thermal material must be thoroughly cleaned from the surfaces of the heat sink and the system board each time the heat sink is removed. Thermal paste is used on the processor **(1)** and the heat sink section **(2)** that services it.

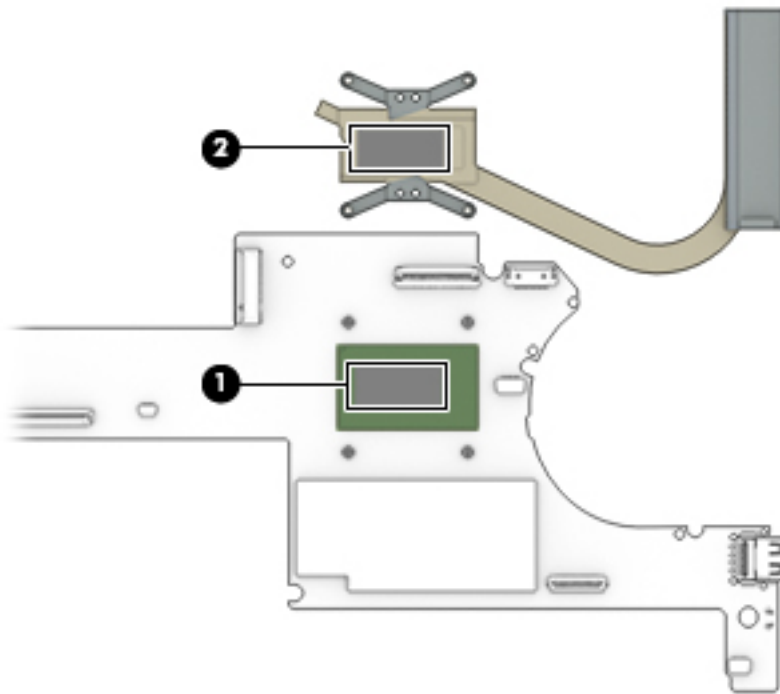

Reverse this procedure to install the heat sink.

Keyboard



NOTE: The keyboard spare part kit includes the keyboard cable and the keyboard backlight cable.

For use in country or region	Spare part number	For use in country or region	Spare part number
For use in Belgium	801508-A41	For use in Latin America	801508-161
For use in Canada	801508-DB1	For use in the Netherlands	801508-B31
For use in the Czech Republic and Slovakia	801508-FL1	For use in Portugal	801508-131
For use in Denmark, Finland, and Norway	801508-DH1	For use in Russia	801508-251
For use in France	801508-051	For use in Saudi Arabia	801508-171
For use in Germany	801508-041	For use in South Korea	801508-AD1
For use in Greece	801508-151	For use in Spain	801508-071
For use in India (does not include pointing stick)	801508-D61	For use in Turkey	801508-141
For use in Israel (does not include pointing stick)	801508-BB1	For use in the United Kingdom and Singapore	801508-031
For use in Italy	801508-061	For use in the United States	801508-001
For use in Japan (does not include pointing stick)	801508-291		

Before removing the keyboard, follow these steps:

1. Turn off the computer. If you are unsure whether the computer is off or in Hibernation, turn the computer on, and then shut it down through the operating system.
2. Disconnect the power from the computer by unplugging the power cord from the computer.
3. Disconnect all external devices from the computer.
4. Remove the bottom cover (see [Bottom cover on page 22](#)), and then remove the following components:
 - a. Remove the battery (see [Battery on page 23](#)).
 - b. Remove the fan (see [Fan on page 27](#)).
 - c. Remove the system board (see [System board on page 31](#)).

Remove the keyboard:

1. Remove the 55 Phillips PM1.1×1.5 screws that secure the keyboard to the top cover from the locations in the following illustration.

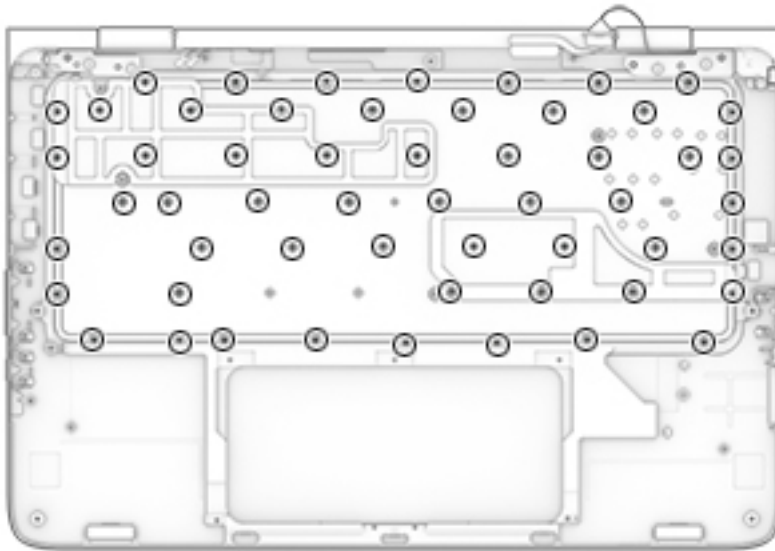

2. Remove the keyboard shields **(1)**.

3. Remove the keyboard (2).

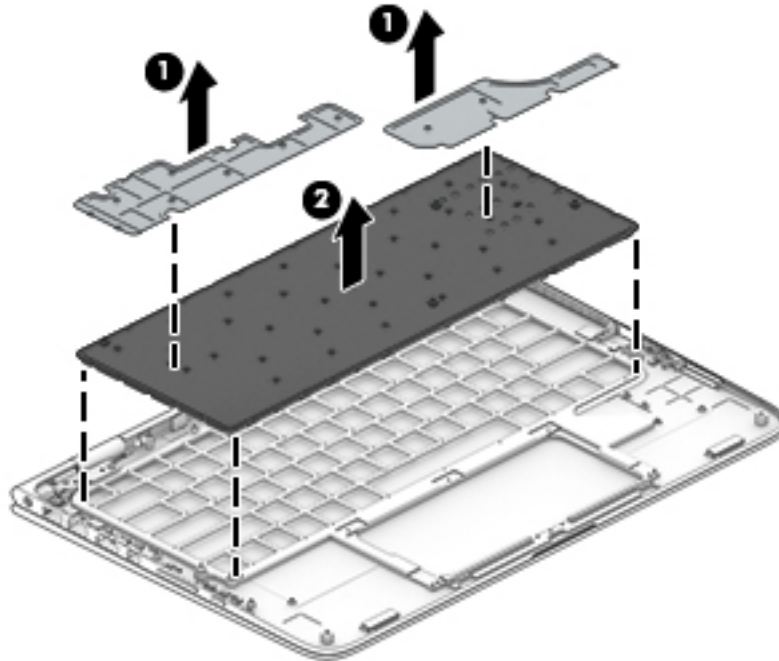

Reverse this procedure to install the keyboard.

Display assembly

Description	Spare part number
13.3-in, ultra wide aspect ratio, TouchScreen 13.3-in, QHD, WLED, BrightView (2560×1440), UWVA, 2.55-mm display assembly (includes display panel cable, microphones, hinges, webcam, and wireless antenna cables and transceivers)	828822-001
13.3-in, ultra wide aspect ratio, TouchScreen 13.3-in, FHD, WLED, BrightView (1920×1080), UWVA, 2.55-mm display assembly (includes display panel cable, microphones, hinges, webcam, and wireless antenna cables and transceivers)	828821-001

Before removing the display assembly, follow these steps:

1. Turn off the computer. If you are unsure whether the computer is off or in Hibernation, turn the computer on, and then shut it down through the operating system.
2. Disconnect the power from the computer by unplugging the power cord from the computer.
3. Disconnect all external devices from the computer.
4. Remove the bottom cover (see [Bottom cover on page 22](#)), and then remove the following components:
 - a. Remove the battery (see [Battery on page 23](#)).
 - b. Remove the fan (see [Fan on page 27](#)).
 - c. Remove the system board (see [System board on page 31](#)).

Remove the display assembly:

1. Open the computer to the interactive position, as shown in the following illustrations.
2. Release the WLAN antenna cables from the retention post **(1)** built into the top cover.
3. Release the display panel cable from the retention post **(2)** built into the top cover.

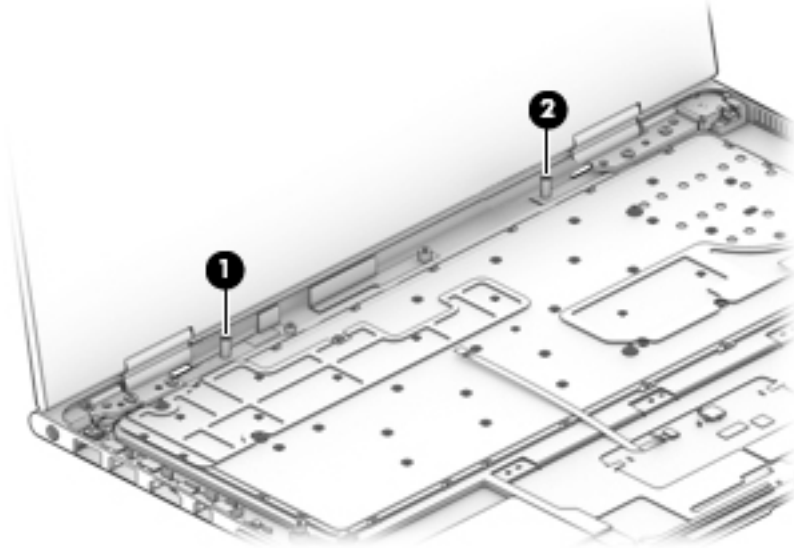

4. Remove the four Phillips PM2.5×4.1 screws **(1)** that secure the display assembly to the top cover.
5. Slide the display assembly **(2)** forward until the display hinges **(3)** clear the top cover.
6. Remove the display assembly **(4)**.

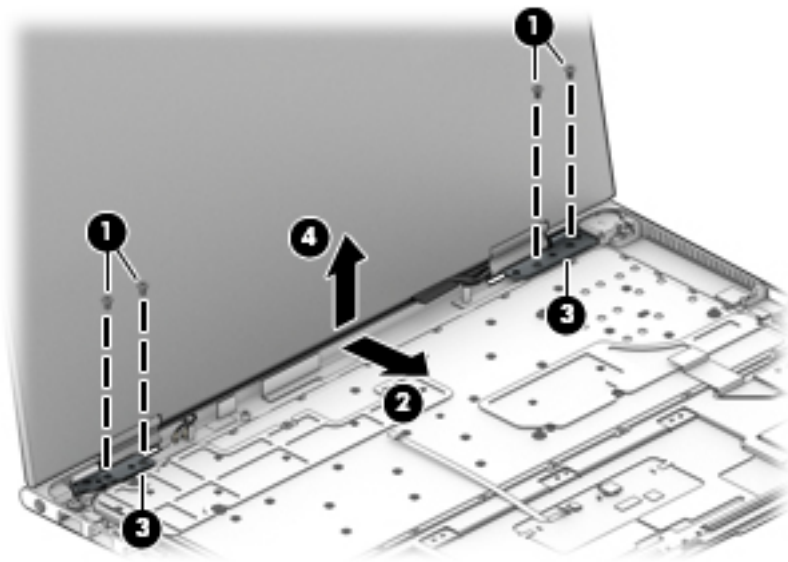

Reverse this procedure to install the display assembly.

Audio jack board

Description	Spare part number
Audio jack board (includes cable)	828820-001

Before removing the audio jack board, follow these steps:

1. Shut down the computer. If you are unsure whether the computer is off or in Hibernation, turn the computer on, and then shut it down through the operating system.
2. Disconnect all external devices connected to the computer.
3. Disconnect the power from the computer by first unplugging the power cord from the AC outlet and then unplugging the AC adapter from the computer.
4. Remove the bottom cover (see [Bottom cover on page 22](#)), and then remove the following components:
 - a. Remove the battery (see [Battery on page 23](#)).
 - b. Remove the fan (see [Fan on page 27](#)).
 - c. Remove the system board (see [System board on page 31](#)).
 - d. Remove the display assembly (see [Display assembly on page 37](#)).

Remove the audio jack board:

1. Remove the Phillips PM2.0×2.0 broad head screw **(1)** that secures the audio jack board to the top cover.
2. Remove the audio jack board **(2)**.

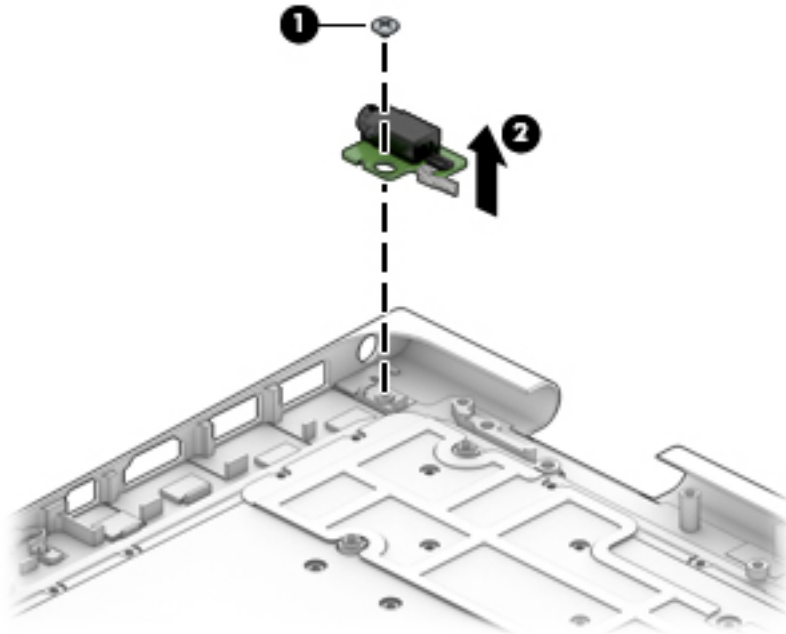

Reverse this procedure to install the audio jack board.

Power connector cable

Description	Spare part number
Power connector cable	801513-001

Before removing the power connector cable, follow these steps:

1. Shut down the computer. If you are unsure whether the computer is off or in Hibernation, turn the computer on, and then shut it down through the operating system.
2. Disconnect all external devices connected to the computer.
3. Disconnect the power from the computer by first unplugging the power cord from the AC outlet and then unplugging the AC adapter from the computer.
4. Remove the bottom cover (see [Bottom cover on page 22](#)), and then remove the following components:
 - a. Remove the battery (see [Battery on page 23](#)).
 - b. Remove the fan (see [Fan on page 27](#)).
 - c. Remove the system board (see [System board on page 31](#)).
 - d. Remove the display assembly (see [Display assembly on page 37](#)).

Remove the power connector cable:

1. Release the power connector cable **(1)** from the retention clips built into the bottom cover.
2. Remove the Phillips PM2.0×4.1 screw **(2)** that secures the power connector to the top cover.
3. Remove the power connector cable **(3)**.

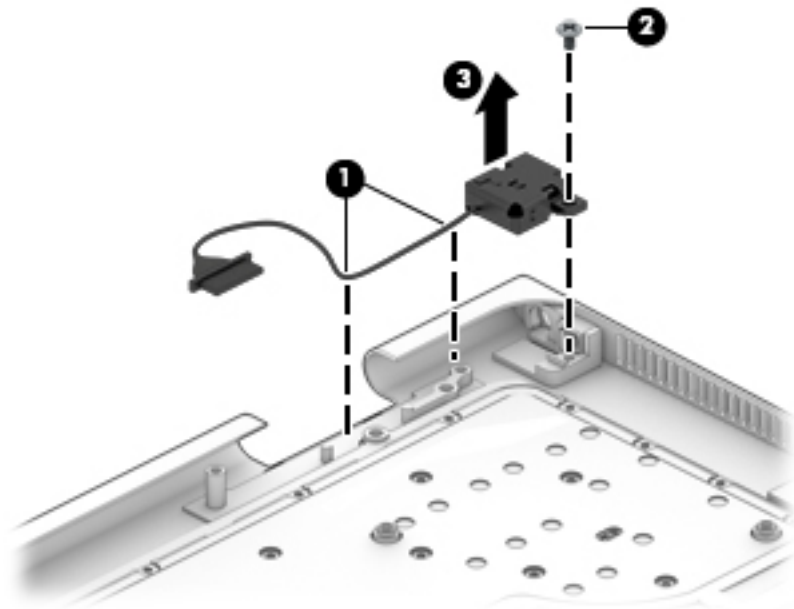

Reverse this procedure to install the power connector cable.

6 Using Setup Utility (BIOS)

Setup Utility, or Basic Input/Output System (BIOS), controls communication between all the input and output devices on the system (such as disk drives, display, keyboard, mouse, and printer). Setup Utility (BIOS) includes settings for the types of devices installed, the startup sequence of the computer, and the amount of system and extended memory.

 **NOTE:** To start Setup Utility on convertible computers, your computer must be in notebook mode and you must use the keyboard attached to your notebook. The on-screen keyboard, which displays in tablet mode, cannot access Setup Utility.

Starting Setup Utility (BIOS)

 **CAUTION:** Use extreme care when making changes in Setup Utility (BIOS). Errors can prevent the computer from operating properly.

 **NOTE:** To start Setup Utility on convertible computers, your computer must be in notebook mode and you must use the keyboard attached to your notebook. The on-screen keyboard, which displays in tablet mode, cannot access Setup Utility.

- Computers or tablets with keyboards:
 - ▲ Turn on or restart the computer, quickly press **esc**, and then press **f10**.
- Tablets without keyboards:
 1. Turn on or restart the tablet, and then quickly hold down the volume down button.
 - or –
 - Turn on or restart the tablet, and then quickly hold down the Windows button.
 2. Tap **f10**.

Updating Setup Utility (BIOS)

Updated versions of Setup Utility (BIOS) may be available on the HP website.

Updated versions of Setup Utility (BIOS) may be available on the HP website.

Some download packages contain a file named Readme.txt, which contains information regarding installing and troubleshooting the file.

Determining the BIOS version

To decide whether you need to update Setup Utility (BIOS), first determine the BIOS version on your computer.

To reveal the BIOS version information (also known as ROM date and System BIOS):

1. Type `support` in the taskbar search box, and then select the **HP Support Assistant** app.

– or –

Click the question mark icon in the taskbar.

2. Select **My PC**, and then select **Specifications**.

– or –

▲ Use Setup Utility (BIOS).

To use Setup Utility (BIOS):

1. Start Setup Utility (BIOS) (see [Starting Setup Utility \(BIOS\) on page 41](#)).
2. Select **Main**, select **System Information**, and then make note of the BIOS version.
3. Select **Exit**, select **No**, and then follow the on-screen instructions.

To check for later BIOS versions, see [Downloading a BIOS update on page 42](#).

Downloading a BIOS update

 **CAUTION:** To reduce the risk of damage to the computer or an unsuccessful installation, download and install a BIOS update only when the computer is connected to reliable external power using the AC adapter. Do not download or install a BIOS update while the computer is running on battery power, docked in an optional docking device, or connected to an optional power source. During the download and installation, follow these instructions:

- Do not disconnect power from the computer by unplugging the power cord from the AC outlet.
 - Do not shut down the computer or initiate Sleep.
 - Do not insert, remove, connect, or disconnect any device, cable, or cord.
-

 **NOTE:** If your computer is connected to a network, consult the network administrator before installing any software updates, especially system BIOS updates.

1. Type `support` in the taskbar search box, and then select the **HP Support Assistant** app.
– or –
Click the question mark icon in the taskbar.
2. Click **Updates**, and then click **Check for updates and messages**.
3. Follow the on-screen instructions.
4. At the download area, follow these steps:
 - a. Identify the most recent BIOS update and compare it to the BIOS version currently installed on your computer. If the update is more recent than your BIOS version, make a note of the date, name,

or other identifier. You may need this information to locate the update later, after it has been downloaded to your hard drive.

- b.** Follow the on-screen instructions to download your selection to the hard drive.

Make a note of the path to the location on your hard drive where the BIOS update is downloaded. You will need to access this path when you are ready to install the update.

BIOS installation procedures vary. Follow any instructions that appear on the screen after the download is complete. If no instructions appear, follow these steps:

- 1.** Type `file` in the taskbar search box, and then select **File Explorer**.
- 2.** Click your hard drive designation. The hard drive designation is typically Local Disk (C:).
- 3.** Using the hard drive path you recorded earlier, open the folder that contains the update.
- 4.** Double-click the file that has an `.exe` extension (for example, `filename.exe`).

The BIOS installation begins.

- 5.** Complete the installation by following the on-screen instructions.



NOTE: After a message on the screen reports a successful installation, you can delete the downloaded file from your hard drive.

Synchronizing a tablet and keyboard (select products only)

For a tablet with a detachable keyboard, when you attach the tablet to the keyboard and restart the computer, Setup Utility (BIOS) checks to see if the Embedded Controller firmware on the keyboard needs to be synchronized. If so, synchronization begins. If the synchronization is interrupted, a notification screen displays for 10 seconds before the tablet restarts and attempts to synchronize again.



NOTE: The Embedded Controller firmware will synchronize **ONLY** if the tablet or keyboard battery is more than 50% charged, or if your tablet is connected to AC power.

7 Using HP PC Hardware Diagnostics (UEFI)

HP PC Hardware Diagnostics is a Unified Extensible Firmware Interface (UEFI) that allows you to run diagnostic tests to determine whether the computer hardware is functioning properly. The tool runs outside the operating system so that it can isolate hardware failures from issues that are caused by the operating system or other software components.

 **NOTE:** To start BIOS on a convertible computer, your computer must be in notebook mode and you must use the keyboard attached to your tablet. The on-screen keyboard, which displays in tablet mode, cannot access BIOS.

To start HP PC Hardware Diagnostics UEFI:

1. Start BIOS:
 - Computers or tablets with keyboards:
 - ▲ Turn on or restart the computer, quickly press [esc](#).
 - Tablets without keyboards:
 - ▲ Turn on or restart the tablet, and then quickly hold down the volume down button.
 - or –
 - Turn on or restart the tablet, and then quickly hold down the Windows button.

2. Press or tap [f2](#).

The BIOS searches three places for the diagnostic tools, in the following order:

- a. Connected USB drive

 **NOTE:** To download the HP PC Hardware Diagnostics (UEFI) tool to a USB drive, see [Downloading HP PC Hardware Diagnostics \(UEFI\) to a USB device on page 45](#).

- b. Hard drive
- c. BIOS

3. When the diagnostic tool opens, select the type of diagnostic test you want to run, and then follow the on-screen instructions. On a tablet, press the volume down button to stop a diagnostic test.

 **NOTE:** If you need to stop a diagnostic test on computers or tablets with a keyboard, press [esc](#).

Downloading HP PC Hardware Diagnostics (UEFI) to a USB device

There are two options to download HP PC Hardware Diagnostics to a USB device:

Download the latest UEFI version:

1. Go to <http://www.hp.com/go/techcenter/pcdiags>. The HP PC Diagnostics home page is displayed.
2. In the HP PC Hardware Diagnostics section, click the **Download** link, and then select **Run**.

Download any version of UEFI for a specific product:

1. Go to <http://www.hp.com/support>, and then select your country. The HP Support page is displayed.
2. Click **Drivers & Downloads**.
3. In the text box, enter the product name, and then click **Go**.

– or –

Click **Find Now** to let HP automatically detect your product.

4. Select your computer, and then select your operating system.
5. In the **Diagnostic** section, follow the on-screen instructions to select and download the UEFI version you want.

8 Specifications

	Metric	U.S.
Dimensions		
Width	32.5 cm	12.80 in
Depth	21.8 cm	8.58 in
Height (front to rear)	1.54 to 1.59 cm	0.61 to 0.63 in
Weight (equipped with solid-state drive)	1.48 kg	3.26 lbs
Input power		
Operating voltage and current	19.5 V dc @ 2.31 A – 45 W	
	19.5 V dc @ 3.33 A – 65 W	
NOTE: This product is designed for IT power systems in Norway with phase-to-phase voltage not exceeding 240 V rms.		
NOTE: The computer operating voltage and current can be found on the system regulatory label.		
Temperature		
Operating	5°C to 35°C	41°F to 95°F
Nonoperating	-20°C to 60°C	-4°F to 140°F
Relative humidity (noncondensing)		
Operating	10% to 90%	
Nonoperating	5% to 95%	
Maximum altitude (unpressurized)		
Operating	-15 m to 3,048 m	-50 ft to 10,000 ft
Nonoperating	-15 m to 12,192 m	-50 ft to 40,000 ft
NOTE: Applicable product safety standards specify thermal limits for plastic surfaces. The device operates well within this range of temperatures.		

9 Backing up, restoring, and recovering

This chapter provides information about the following processes. The information in the chapter is standard procedure for most products.

- Creating recovery media and backups
- Restoring and recovering your system

For additional information, refer to the HP support assistant app.

- ▲ Type `support` in the taskbar search box, and then select the **HP Support Assistant** app.

– or –

Click the question mark icon in the taskbar.

 **IMPORTANT:** If you will be performing recovery procedures on a tablet, the tablet battery must be at least 70% charged before you start the recovery process.

IMPORTANT: For a tablet with a detachable keyboard, connect the keyboard to the keyboard dock before beginning any recovery process.

Creating recovery media and backups

The following methods of creating recovery media and backups are available on select products only. Choose the available method according to your computer model.

- Use HP Recovery Manager to create HP Recovery media after you successfully set up the computer. This step creates a backup of the HP Recovery partition on the computer. The backup can be used to reinstall the original operating system in cases where the hard drive is corrupted or has been replaced. For information on creating recovery media, see [Creating HP Recovery media \(select products only\) on page 48](#). For information on the recovery options that are available using the recovery media, see [Using Windows Tools on page 49](#).
- Use Windows tools to create system restore points and create backups of personal information.

For more information, see [Recovering using HP Recovery Manager on page 50](#).

 **NOTE:** If storage is 32 GB or less, Microsoft System Restore is disabled by default.

Creating HP Recovery media (select products only)

If possible, check for the presence of the Recovery partition and the Windows partition. From the **Start** menu, select **File Explorer**, and then select **This PC**.

- If your computer does not list the Windows partition and the Recovery partition, you can obtain recovery media for your system from support. See the *Worldwide Telephone Numbers* booklet included with the computer. You can also find contact information on the HP website. Go to <http://www.hp.com/support>, select your country or region, and follow the on-screen instructions.

You can use Windows tools to create system restore points and create backups of personal information, see *Using Windows tools on page 61*.

- If your computer does list the Recovery partition and the Windows partition, you can use HP Recovery Manager to create recovery media after you successfully set up the computer. HP Recovery media can be used to perform system recovery if the hard drive becomes corrupted. System recovery reinstalls the original operating system and software programs that were installed at the factory and then configures the settings for the programs. HP Recovery media can also be used to customize the system or restore the factory image if you replace the hard drive.
 - Only one set of recovery media can be created. Handle these recovery tools carefully, and keep them in a safe place.
 - HP Recovery Manager examines the computer and determines the required storage capacity for the media that will be required.
 - To create recovery discs, your computer must have an optical drive with DVD writer capability, and you must use only high-quality blank DVD-R, DVD+R, DVD-R DL, or DVD+R DL discs. Do not use rewritable discs such as CD±RW, DVD±RW, double-layer DVD±RW, or BD-RE (rewritable Blu-ray) discs; they are not compatible with HP Recovery Manager software. Or, instead, you can use a high-quality blank USB flash drive.
 - If your computer does not include an integrated optical drive with DVD writer capability, but you would like to create DVD recovery media, you can use an external optical drive (purchased separately) to create recovery discs. If you use an external optical drive, it must be connected directly to a USB port on the computer; the drive cannot be connected to a USB port on an external device, such as a USB hub. If you cannot create DVD media yourself, you can obtain recovery discs for your computer from HP. See the *Worldwide Telephone Numbers* booklet included with the computer. You can also find contact information on the HP website. Go to <http://www.hp.com/support>, select your country or region, and follow the on-screen instructions.
 - Be sure that the computer is connected to AC power before you begin creating the recovery media.
 - The creation process can take an hour or more. Do not interrupt the creation process.
 - If necessary, you can exit the program before you have finished creating all of the recovery DVDs. HP Recovery Manager will finish burning the current DVD. The next time you start HP Recovery Manager, you will be prompted to continue.

To create HP Recovery media:



IMPORTANT: For a tablet with a detachable keyboard, connect the keyboard to the keyboard dock before beginning these steps.

1. Type `recovery` in the taskbar search box, and then select **HP Recovery Manager**.
2. Select **Create recovery media**, and then follow the on-screen instructions.

If you ever need to recover the system, see [Recovering using HP Recovery Manager on page 50](#).

Using Windows Tools

You can create recovery media, system restore points, and backups of personal information using Windows tools.



NOTE: If storage is 32 GB or less, Microsoft System Restore is disabled by default.

For more information and steps, see the Get started app.

- ▲ Select the **Start** button, and then select the **Get started** app.

Restore and recovery

There are several options for recovering your system. Choose the method that best matches your situation and level of expertise:



IMPORTANT: Not all methods are available on all products.

- Windows offers several options for restoring from backup, refreshing the computer, and resetting the computer to its original state. For more information see the Get started app.
 - ▲ Select the **Start** button, and then select the **Get started** app.
- If you need to correct a problem with a preinstalled application or driver, use the Reinstall drivers and/or applications option (select products only) of HP Recovery Manager to reinstall the individual application or driver.
 - ▲ Type `recovery` in the taskbar search box, select **HP Recovery Manager**, select **Reinstall drivers and/or applications**, and then follow the on-screen instructions.
- If you want to recover the Windows partition to original factory content, you can choose the System Recovery option from the HP Recovery partition (select products only) or use the HP Recovery media. For more information, see [Recovering using HP Recovery Manager on page 50](#). If you have not already created recovery media, see [Creating HP Recovery media \(select products only\) on page 48](#).
- On select products, if you want to recover the computer's original factory partition and content, or if you have replaced the hard drive, you can use the Factory Reset option of HP Recovery media. For more information, see [Recovering using HP Recovery Manager on page 50](#).
- On select products, if you want to remove the recovery partition to reclaim hard drive space, HP Recovery Manager offers the Remove Recovery Partition option.

For more information, see Removing the [Removing the HP Recovery partition \(select products only\) on page 52](#).

Recovering using HP Recovery Manager

HP Recovery Manager software allows you to recover the computer to its original factory state by using the HP Recovery media that you either created or that you obtained from HP, or by using the HP Recovery partition (select products only). If you have not already created recovery media, see [Creating HP Recovery media \(select products only\) on page 48](#).

What you need to know before you get started

- HP Recovery Manager recovers only software that was installed at the factory. For software not provided with this computer, you must either download the software from the manufacturer's website or reinstall the software from the media provided by the manufacturer.

 **IMPORTANT:** Recovery through HP Recovery Manager should be used as a final attempt to correct computer issues.

- To use the Factory Reset option (select products only), you must use HP Recovery media. If you have not already created recovery media, see [Creating HP Recovery media \(select products only\) on page 48](#).
- If your computer does not allow the creation of HP Recovery media or if the HP Recovery media does not work, you can obtain recovery media for your system from support. See the *Worldwide Telephone Numbers* booklet included with the computer. You can also find contact information from the HP website. Go to <http://www.hp.com/support>, select your country or region, and follow the on-screen instructions.

 **IMPORTANT:** HP Recovery Manager does not automatically provide backups of your personal data. Before beginning recovery, back up any personal data you want to retain.

Using HP Recovery media, you can choose from one of the following recovery options:

 **NOTE:** Only the options available for your computer display when you start the recovery process.

- **System Recovery**—Reinstalls the original operating system, and then configures the settings for the programs that were installed at the factory.
- **Factory Reset**—Restores the computer to its original factory state by deleting all information from the hard drive and re-creating the partitions. Then it reinstalls the operating system and the software that was installed at the factory.

The HP Recovery partition (select products only) allows System Recovery only.

Using the HP Recovery partition (select products only)

The HP Recovery partition allows you to perform a system recovery without the need for recovery discs or a recovery USB flash drive. This type of recovery can be used only if the hard drive is still working.

To start HP Recovery Manager from the HP Recovery partition:



IMPORTANT: For a tablet with a detachable keyboard, connect the keyboard to the keyboard dock before beginning these steps (select products only).

1. Type `recovery` in the taskbar search box, select **Recovery Manager**, and then select **HP Recovery Environment**.

– or –

For computers or tablets with keyboards attached, press **f11** while the computer boots, or press and hold **f11** as you press the power button.

For tablets without keyboards:

Turn on or restart the tablet, and then quickly hold down the volume down button; then select **f11**.

– or –

Turn on or restart the tablet, and then quickly hold down the Windows button; then select **f11**.

2. Select **Troubleshoot** from the boot options menu.
3. Select **Recovery Manager**, and then follow the on-screen instructions.

Using HP Recovery media to recover

You can use HP Recovery media to recover the original system. This method can be used if your system does not have an HP Recovery partition or if the hard drive is not working properly.

1. If possible, back up all personal files.
2. Insert the HP Recovery media, and then restart the computer.



NOTE: If the computer does not automatically restart in HP Recovery Manager, change the computer boot order. See [Changing the computer boot order on page 52](#).

3. Follow the on-screen instructions.

Changing the computer boot order

If your computer does not restart in HP Recovery Manager, you can change the computer boot order, which is the order of devices listed in BIOS where the computer looks for startup information. You can change the selection to an optical drive or a USB flash drive.

To change the boot order:

 **IMPORTANT:** For a tablet with a detachable keyboard, connect the keyboard to the keyboard dock before beginning these steps.

1. Insert the HP Recovery media.

2. Access BIOS:

For computers or tablets with keyboards attached:

▲ Turn on or restart the computer or tablet, quickly press **esc**, and then press **f9** for boot options.

For tablets without keyboards:

▲ Turn on or restart the tablet, and then quickly hold down the volume down button; then select **f9**.

– or –

Turn on or restart the tablet, and then quickly hold down the Windows button; then select **f9**.

3. Select the optical drive or USB flash drive from which you want to boot.

4. Follow the on-screen instructions.

Removing the HP Recovery partition (select products only)

HP Recovery Manager software allows you to remove the HP Recovery partition to free up hard drive space.

 **IMPORTANT:** After you remove the HP Recovery partition, you will not be able to perform System Recovery or create HP recovery media from the HP Recovery partition. So before you remove the Recovery partition, create HP Recovery media; see [Creating HP Recovery media \(select products only\) on page 48](#).

 **NOTE:** The Remove Recovery Partition option is only available on products that support this function.

Follow these steps to remove the HP Recovery partition:

1. Type `recovery` in the taskbar search box, and then select **HP Recovery Manager**.

2. Select **Remove Recovery Partition**, and then follow the on-screen instructions.

10 Statement of Volatility

The purpose of this document is to provide general information regarding non-volatile memory in industry-standards based HP Business Notebook PC systems and provide general instructions for restoring nonvolatile memory that can contain personal data after the system has been powered off and the hard drive has been removed.

HP Business Notebook PC products that use Intel-based or AMD®-based system boards contain volatile DDR memory. The amount of nonvolatile memory present in the system depends upon the system configuration. Intel-based and AMD-based system boards contain nonvolatile memory subcomponents as originally shipped from HP assuming that no subsequent modifications have been made to the system and assuming that no applications, features, or functionality have been added to or installed on the system.

Following system shutdown and removal of all power sources from an HP Business Notebook PC system, personal data can remain on volatile system memory (DIMMs) for a finite period of time and will also remain in nonvolatile memory. The steps below will remove personal data from the notebook PC, including the nonvolatile memory found in Intel-based and AMD-based system boards. Some of these steps are disclosed in the Maintenance and Service Guides available for HP PC products available on the product support pages at www.hp.com.

1. Follow steps (a) through (l) below to restore the nonvolatile memory that can contain personal data. Restoring or re-programming nonvolatile memory that does not store personal data is neither necessary nor recommended.
 - a. Turn on or restart the computer, and then press **esc** while the “Press the ESC key for Startup Menu” message is displayed at the bottom of the screen.



NOTE: If the system has a BIOS administrator password, enter the password at the prompt.

- b. Select **Main**, select **Restore Defaults**, and then select **Yes** to load defaults.
- c. Select the **Security** menu, select **Restore Security Level Defaults**, and then select **Yes** to restore security level defaults.
- d. If an asset or ownership tag is set, select the **Security** menu and scroll down to the **Utilities** menu. Select **System IDs**, and then select **Asset Tracking Number**. Clear the tag, and then make the selection to return to the prior menu.
- e. If a DriveLock password is set, select the **Security** menu and scroll down to **Hard Drive Tools** under the **Utilities** menu. Select **Hard Drive Tools**, select **DriveLock**, then uncheck the checkbox for **DriveLock password on reset**. Select **OK** to proceed.
- f. If an Automatic DriveLock password is set, select the **Security menu**, scroll down to **Hard Drive Tools** under the **Utilities** menu. Select **Hard Drive Tools**, scroll down to **Automatic DriveLock**, then select the desired hard drive and disable protection. At the automatic drive lock warning screen, select **Yes** to continue. Repeat this procedure if more than one hard drive has an Automatic DriveLock password.
- g. Select the **Main** menu, and then **Reset BIOS Security to factory default**. Click **yes** at the warning message.
- h. Select the **Main** menu, **Save Changes and Exit**, select **Yes** to save changes and exit, and then select **Shutdown**.

- i. Reboot the system. If the system has a Trusted Platform Module (TPM) and/or fingerprint reader, one or two prompts will appear—one to clear the TPM and the other to Reset Fingerprint Sensor. Press or tap **F1** to accept or **F2** to reject.
 - j. Remove all power and system batteries for at least 24 hours.
2. Complete one of the following:
- Remove and retain the storage drive.
– or –
 - Clear the drive contents by using a third party utility designed to erase data from an SSD.
– or –
 - Clear the contents of the drive by using the following BIOS Setup Secure Erase command option steps:



IMPORTANT: If you clear data using Secure Erase, it cannot be recovered.

- a. Turn on or restart the computer, and then press **esc** while the "Press the ESC key for Startup Menu" message is displayed at the bottom of the screen.
- b. Select the **Security** menu and scroll down to the **Utilities** menu.
- c. Select **Hard Drive Tools**.
- d. Under **Utilities**, select **Secure Erase**, select the hard drive storing the data you want to clear, and then follow the on-screen instructions to continue.

– or –

- Clear the contents of the drive by using the following Disk Sanitizer command steps:



IMPORTANT: If you clear data using Disk Sanitizer, it cannot be recovered.



NOTE: The amount of time it takes for Disk Sanitizer to run can take several hours. Plug the computer into an AC outlet before starting.

- a. Turn on or restart the computer, and then press **esc** while the "Press the ESC key for Startup Menu" message is displayed at the bottom of the screen.
- b. Select the **Security** menu and scroll down to the **Utilities** menu.
- c. Select **Hard Drive Tools**.
- d. Under **Utilities**, select **Disk Sanitizer**, select the hard drive storing the data you want to clear, and then follow the on-screen instructions to continue.

Non-volatile memory usage

Non Volatile Memory Type	Amount (Size)	Does this memory store customer data?	Does this memory retain data when power is removed?	What is the purpose of this memory?	How is data input into this memory?	How is this memory write protected?
HP Sure Start flash (select models only)	2 MBytes	No	Yes	Provides protected backup of critical System BIOS code, EC firmware, and critical PC configuration data for select platforms that support HP Sure Start.	Data cannot be written to this device via the host processor. The content is managed solely by the HP Sure Start Embedded Controller.	This memory is protected by the HP Sure Start Embedded Controller.
Real Time Clock (RTC) battery backed-up CMOS configuration memory	256 Bytes	No	Yes	Stores system date and time and limited keyboard controller data.	Using the F10 Setup utility or changing the Microsoft Windows date and time.	This memory is not write-protected. HP recommends password protecting the F10 Setup utility.
Controller (NIC) EEPROM	64 KBytes (not customer accessible)	No	Yes	Store NIC configuration and NIC firmware.	Using a utility from the NIC vendor that can be run from DOS.	A utility is required to write data to this memory and is available from NIC vendor. Writing data to this ROM in an inappropriate manner will render the NIC nonfunctional.
DIMM Serial Presence Detect (SPD) configuration data	256 Bytes per memory module, 128 Bytes programmable (not customer accessible)	No	Yes	Stores memory module information.	Programmed by the memory vendor.	Data cannot be written to this memory when the module is installed in a PC. The specific write protection method varies by memory vendor.
System BIOS	4 to 5 MBytes	Yes	Yes	Stores system BIOS code and PC configuration data.	System BIOS code is programmed at the factory. Code is updated when the system BIOS is updated. Configuration data and settings are input using the	NOTE: Writing data to this ROM in an inappropriate manner can render the PC non-functional. A utility is required for writing data to this memory and is available

Non Volatile Memory Type	Amount (Size)	Does this memory store customer data?	Does this memory retain data when power is removed?	What is the purpose of this memory?	How is data input into this memory?	How is this memory write protected?
					Computer Setup (BIOS) or a custom utility.	on the HP website; go to http://hp.com/support , select Find your product , and then follow the on-screen instructions.
Intel Management Engine Firmware (present only in specific ZBook and EliteBook models. For more information, go to http://hp.com/support , select Find your product , and then follow the on-screen instructions.)	1.5 or 5 MBytes	Yes	Yes	Stores Management Engine Code, Settings, Provisioning Data and iAMT third party data store.	Management Engine Code is programmed at the factory. Code is updated via Intel secure firmware update utility. Unique Provisioning Data can be entered at the factory or by an administrator using the Management Engine (MEBx) setup utility. The third party data store contents can be populated by a remote management console or local applications registered by an administrator to have access to the space.	The Intel chipset is configured to enforce hardware protection to block all direct read/write access to this area. An Intel utility is required for updating the firmware. Only firmware updates digitally signed by Intel can be applied using this utility.
Bluetooth flash	2 MBits	No	Yes	Stores Bluetooth configuration and firmware.	Programmed at the factory. Tools for writing data to this memory are not publicly available but can be obtained from the silicon vendor.	A utility is required for writing data to this memory and is made available through newer versions of the driver if the flash requires an upgrade.
802.11 WLAN EEPROM	4 KBytes to 8 KBytes	No	Yes	Stores configuration and calibration data.	Programmed at the factory. Tools for writing data to this memory are not made public.	A utility is required for writing data to this memory and is typically not made

Non Volatile Memory Type	Amount (Size)	Does this memory store customer data?	Does this memory retain data when power is removed?	What is the purpose of this memory?	How is data input into this memory?	How is this memory write protected?
						available to the public unless a firmware upgrade is necessary to address a unique issue.
Webcamera	64 KBits	No	Yes	Store webcam configuration and firmware.	Using a utility from the device manufacturer that can be run from Windows.	A utility is required for writing data to this memory and is typically not made available to the public unless a firmware upgrade is necessary to address a unique issue.
Fingerprint reader	512 KBytes flash	Yes	Yes	Stores fingerprint templates.	By enrolling in HP ProtectTools Security Manager.	Only a digitally signed application can make the call to write to the flash.

Questions and answers

1. How can the BIOS settings be restored (returned to default settings)?



IMPORTANT: Restore defaults does not securely erase any data on your hard drive. See question and answer 6 for steps to securely erase data.

Restore defaults does not reset the Custom Secure Boot keys. See question and answer 7 for information about resetting the keys.

- a. Turn on or restart the computer, and then press **esc** while the "Press the ESC key for Startup Menu" message is displayed at the bottom of the screen.
- b. Select **Main**, and then select **Restore defaults**.
- c. Follow the on-screen instructions.
- d. Select **Main**, select **Save Changes and Exit**, and then follow the on-screen instructions.

2. What is a UEFI BIOS, and how is it different from a legacy BIOS?

The Unified Extensible Firmware Interface (UEFI) BIOS is an industry-standard software interface between the platform firmware and an operating system (OS). It is a replacement for the older BIOS architecture, but supports much of the legacy BIOS functionality.

Like the legacy BIOS, the UEFI BIOS provides an interface to display the system information and configuration settings and to change the configuration of your computer before an OS is loaded. BIOS provides a secure run-time environment that supports a Graphic User Interface (GUI). In this environment, you can use either a pointing device (Touchscreen, TouchPad, pointing stick, or USB mouse) or the keyboard to navigate and make menu and configuration selections. The UEFI BIOS also contains basic system diagnostics.

The UEFI BIOS provides functionality beyond that of the legacy BIOS. In addition, the UEFI BIOS works to initialize the computer's hardware before loading and executing the OS; the run-time environment allows the loading and execution of software programs from storage devices to provide more functionality, such as advanced hardware diagnostics (with the ability to display more detailed system information) and advanced firmware management and recovery software.

The UEFI BIOS provides functionality beyond that of the legacy BIOS. In addition, the UEFI BIOS works to initialize the computer's hardware before loading and executing the OS; the run-time environment allows the loading and execution of software programs from storage devices to provide more functionality, such as advanced hardware diagnostics (with the ability to display more detailed system information) and advanced firmware management and recovery software.

HP has provided options in Computer Setup (BIOS) to allow you to run in legacy BIOS, if required by the operating system. Examples of this requirement would be if you upgrade or downgrade the OS.

3. Where does the UEFI BIOS reside?

The UEFI BIOS resides on a flash memory chip. A utility is required to write to the chip.

4. What kind of configuration data is stored on the DIMM Serial Presence Detect (SPD) memory module? How would this data be written?

The DIMM SPD memory contains information about the memory module, such as size, serial number, data width, speed/timing, voltage, and thermal information. This information is written by the module manufacturer and stored on an EEPROM. This EEPROM cannot be written to when the memory module is installed in a PC. Third party tools do exist that can write to the EEPROM when the memory module is not installed in a PC. Various third party tools are available to read SPD memory.

5. What is meant by “Restore the nonvolatile memory found in Intel-based system boards?”

This message relates to clearing the Real Time Clock (RTC) CMOS memory that contains PC configuration data.

6. How can the BIOS security be reset to factory defaults and data erased?



IMPORTANT: Resetting will result in the loss of information.

These steps will not reset Custom Secure Boot Keys. See question and answer 7 for information about resetting the keys.

- a. Turn on or restart the computer, and then press **esc** while the "Press the ESC key for Startup Menu" message is displayed at the bottom of the screen.
- b. Select **Main**, and then select **Reset BIOS Security to Factory Default**.
- c. Follow the on-screen instructions.
- d. Select **Main**, select **Save Changes and Exit**, and then follow the on-screen instructions.

7. How can the Custom Secure Boot Keys be reset?

Secure Boot is a feature to ensure that only authenticated code can start on a platform. If you enabled Secure Boot and created Custom Secure Boot Keys, simply disabling Secure Boot will not clear the keys. You must also select to clear the Custom Secure Boot Keys. Use the same Secure Boot access procedure you used to create the Custom Secure Boot Keys, but make the selection to clear or delete all Secure Boot Keys.

- a. Turn on or restart the computer, and then press **esc** while the "Press the ESC key for Startup Menu" message is displayed at the bottom of the screen.
- b. Select the **Security** menu, select **Secure Boot Configuration**, and then follow the on-screen instructions.
- c. At the **Secure Boot Configuration** window, select **Secure Boot**, select **Clear Secure Boot Keys**, and then follow the on-screen instructions to continue.

Using HP Sure Start (select models only)

Select computer models are configured with HP Sure Start, a technology that continuously monitors your computer's BIOS for attacks or corruption. If the BIOS becomes corrupted or is attacked, HP Sure Start restores the BIOS to its previously safe state, without user intervention. Those select computer models ship with HP Sure Start configured and enabled. HP Sure Start is configured and already enabled so that most users can use the HP Sure Start default configuration. The default configuration can be customized by advanced users.

To access the latest documentation on HP Sure Start, go to <http://www.hp.com/support>, and select your country. Select **Find your product**, and then follow the on-screen instructions.

11 Power cord set requirements

The wide-range input feature of the computer permits it to operate from any line voltage from 100 to 120 volts AC, or from 220 to 240 volts AC.

The 3-conductor power cord set included with the computer meets the requirements for use in the country or region where the equipment is purchased.

Power cord sets for use in other countries and regions must meet the requirements of the country or region where the computer is used.

Requirements for all countries

The following requirements are applicable to all countries and regions:

- The length of the power cord set must be at least 1.0 m (3.3 ft) and no more than 2.0 m (6.5 ft).
- All power cord sets must be approved by an acceptable accredited agency responsible for evaluation in the country or region where the power cord set will be used.
- The power cord sets must have a minimum current capacity of 10 amps and a nominal voltage rating of 125 or 250 V AC, as required by the power system of each country or region.
- The appliance coupler must meet the mechanical configuration of an EN 60 320/IEC 320 Standard Sheet C13 connector for mating with the appliance inlet on the back of the computer. Requirements for all countries 113

Requirements for specific countries and regions

Country/region	Accredited agency	Applicable note number
Australia	EANSW	1
Austria	OVE	1
Belgium	CEBC	1
Canada	CSA	2
Denmark	DEMKO	1
Finland	FIMKO	1
France	UTE	1
Germany	VDE	1
Italy	IMQ	1
Japan	METI	3
The Netherlands	KEMA	1
Norway	NEMKO	1
The People's Republic of China	COC	5

Country/region	Accredited agency	Applicable note number
South Korea	EK	4
Sweden	CEMKO	1
Switzerland	SEV	1
Taiwan	BSMI	4
The United Kingdom	BSI	1
The United States	UL	2

1. The flexible cord must be Type H05VV-F, 3-conductor, 1.0-mm² conductor size. Power cord set fittings (appliance coupler and wall plug) must bear the certification mark of the agency responsible for evaluation in the country or region where it will be used.
2. The flexible cord must be Type SPT-3 or equivalent, No. 18 AWG, 3-conductor. The wall plug must be a two-pole grounding type with a NEMA 5-15P (15 A, 125 V) or NEMA 6-15P (15 A, 250 V) configuration.
3. The appliance coupler, flexible cord, and wall plug must bear a "T" mark and registration number in accordance with the Japanese Dentori Law. The flexible cord must be Type VCT or VCTF, 3-conductor, 1.00-mm² conductor size. The wall plug must be a two-pole grounding type with a Japanese Industrial Standard C8303 (7 A, 125 V) configuration.
4. The flexible cord must be Type RVV, 3-conductor, 0.75-mm² conductor size. Power cord set fittings (appliance coupler and wall plug) must bear the certification mark of the agency responsible for evaluation in the country or region where it will be used.
5. The flexible cord must be Type VCTF, 3-conductor, 0.75-mm² conductor size. Power cord set fittings (appliance coupler and wall plug) must bear the certification mark of the agency responsible for evaluation in the country or region where it will be used.

12 Recycling

When a non-rechargeable or rechargeable battery has reached the end of its useful life, do not dispose of the battery in general household waste. Follow the local laws and regulations in your area for battery disposal.

HP encourages customers to recycle used electronic hardware, HP original print cartridges, and rechargeable batteries. For more information about recycling programs, see the HP Web site at <http://www.hp.com/recycle>.

Index

A

AC adapter, spare part numbers 15
AC adapter/battery light 9
action keys 6
antenna, location 5
audio jack board
 removal 39
 spare part number 14, 39
audio, product description 1
audio-in jack 11
audio-out jack 11

B

battery
 removal 23
 spare part number 15, 23
bottom cover
 removal 22
 spare part number 15, 22
buttons
 power 9, 10
 TouchPad 8
 volume 11
 Windows 11

C

cables, service considerations 17
caps lock light 7
card reader board
 removal 30
 spare part number 14, 30
chipset, product description 1
components
 display 5
 keys 6
 left side 9
 lights 7
 right side 11
 speakers 7
 TouchPad 8
computer
 major components 13
 specifications 46

connectors
 power 9
 service considerations 17

D

display assembly
 removal 37
 spare part numbers 37
display components 5
display panel, product description 1
display switch 5
DisplayPort 11
DVD-RW Drive, spare part number 15

E

electrostatic discharge 18
equipment guidelines 20
esc key 6
external media cards, product description 2

F

fan
 removal 27
 spare part number 15, 27
fn key 6

G

graphics, product description 1
grounding guidelines 18
guidelines
 equipment 20
 grounding 18
 packaging 19
 transporting 19
 workstation 19

H

HDMI port 11
HDMI-to-VGA adapter, spare part number 15
headphone jack 11

heat sink
 removal 34
 spare part number 15, 34

J

jacks
 audio-in 11
 audio-out 11
 headphone 11
 microphone 11

K

key components 6
keyboard
 removal 35
 spare part numbers 14, 35
keys
 action 6
 esc 6
 fn 6
 Windows 6
 Windows applications 6

L

left-side components 9
light components 7
lights
 AC adapter/battery 9
 caps lock 7
 mute 7
 power 10
 webcam 5
locating information
 hardware 4
 software 4

M

memory card reader 10
memory, product description 1
microphone
 location 5
 product description 1
microphone jack 11
model name 1
mouse, spare part numbers 15

mute light 7

O

operating system, product description 2, 3

optical drive, spare part number 15

P

packaging guidelines 19

plastic parts, service considerations 17

ports

DisplayPort 11

HDMI 11

product description 2

USB 3.0 9, 11

power button 9, 10

power connector 9

power connector cable

removal 40

spare part number 14, 40

power cord

set requirements 60

spare part numbers 16

power light 10

power requirements, product description 2

primary storage, product description 1

processor, product description 1

product description

audio 1

chipset 1

display panel 1

external media cards 2

graphics 1

memory 1

microphone 1

operating system 2, 3

ports 2

power requirements 2

primary storage 1

processors 1

product name 1

security 2

serviceability 3

solid-state drive 1

video 1

wireless 1, 2

product name 1

R

removal/replacement procedures 21

right-side components 11

RJ45-to-USB adapter dongle, spare part number 15

S

Screw Kit, spare part number 16

security, product description 2

service considerations

cables 17

connectors 17

plastic parts 17

serviceability, product description 3

solid-state drive

product description 1

removal 26

spare part numbers 15, 26

speaker components 7

speakers

location 7

removal 28

spare part number 14, 28

system board

removal 31

spare part numbers 14, 31

T

tools required 17

top cover, spare part number 14

TouchPad

components 8

removal 29

spare part number 14, 29

TouchPad button 8

TouchPad zone 8

transporting guidelines 19

U

USB 3.0 port 9, 11

V

vents 9

video, product description 1

volume button 11

W

webcam light 5

webcam, location 5

Windows applications key 6

Windows button 11

Windows key 6

wireless antenna, location 5

wireless, product description 1, 2

WLAN antenna, location 5

WLAN module

removal 24

spare part number 15, 24

workstation guidelines 19