

Inspiron 24

5000 Series

Service Manual

Computer Model: Inspiron 24–5459
Regulatory Model: W12C
Regulatory Type: W12C004



Notes, cautions, and warnings



NOTE: A NOTE indicates important information that helps you make better use of your computer.



CAUTION: A CAUTION indicates either potential damage to hardware or loss of data and tells you how to avoid the problem.



WARNING: A WARNING indicates a potential for property damage, personal injury, or death.

Copyright © 2015 Dell Inc. All rights reserved. This product is protected by U.S. and international copyright and intellectual property laws. Dell™ and the Dell logo are trademarks of Dell Inc. in the United States and/or other jurisdictions. All other marks and names mentioned herein may be trademarks of their respective companies.

2015 - 08

Rev. A00

Contents

Before working inside your computer.....	9
Before you begin	9
Safety instructions.....	10
Recommended tools.....	11
After working inside your computer.....	12
Technical overview.....	13
Inside view of your computer.....	13
System Board Components.....	14
Removing the stand.....	16
Procedure.....	16
Replacing the stand.....	18
Procedure.....	18
Removing the back cover.....	19
Prerequisites.....	19
Procedure.....	19
Replacing the back cover.....	20
Procedure.....	20
Post-requisites.....	20
Removing the optical drive.....	21
Prerequisites.....	21
Procedure.....	21

Replacing the optical drive.....	24
Procedure.....	24
Post-requisites.....	24
Removing the hard drive.....	25
Prerequisites.....	25
Procedure.....	25
Replacing the hard drive.....	28
Procedure.....	28
Post-requisites.....	28
Removing the memory modules.....	29
Prerequisites.....	29
Procedure.....	29
Replacing the memory modules.....	31
Procedure.....	31
Post-requisites.....	32
Removing the wireless card.....	33
Prerequisites.....	33
Procedure.....	33
Replacing the wireless card.....	35
Procedure.....	35
Post-requisites.....	36
Removing the heat sink.....	37
Prerequisites.....	37
Procedure.....	37

Replacing the heat sink.....	39
Procedure.....	39
Post-requisites.....	39
Removing the fan.....	40
Prerequisites.....	40
Procedure.....	40
Replacing the fan.....	42
Procedure.....	42
Post-requisites.....	42
Removing the coin-cell battery.....	43
Prerequisites.....	43
Procedure.....	43
Replacing the coin-cell battery.....	45
Procedure.....	45
Post-requisites.....	45
Removing the processor.....	46
Prerequisites.....	46
Procedure.....	46
Replacing the processor.....	48
Procedure.....	48
Post-requisites.....	49
Removing the microphone.....	50
Prerequisites.....	50
Procedure.....	50

Replacing the microphone.....	52
Procedure.....	52
Post-requisites.....	52
Removing the camera.....	53
Prerequisites.....	53
Procedure.....	53
Replacing the camera.....	55
Procedure.....	55
Post-requisites.....	55
Removing the system board.....	56
Prerequisites.....	56
Procedure.....	57
Replacing the system board.....	60
Procedure.....	60
Post-requisites.....	60
Removing the VESA-mount bracket.....	62
Prerequisites.....	62
Procedure.....	62
Replacing the VESA-mount bracket.....	64
Procedure.....	64
Post-requisites.....	64
Removing the speaker cover.....	65
Prerequisites.....	65
Procedure.....	65

Replacing the speaker cover.....	67
Procedure.....	67
Post-requisites.....	67
Removing the speakers.....	68
Prerequisites.....	68
Procedure.....	68
Replacing the speakers.....	70
Procedure.....	70
Post-requisites.....	70
Removing the control-buttons board.....	71
Prerequisites.....	71
Procedure.....	71
Replacing the control-buttons board.....	73
Procedure.....	73
Post-requisites.....	73
Removing the middle cover.....	74
Prerequisites.....	74
Procedure.....	74
Replacing the middle cover.....	79
Procedure.....	79
Post-requisites.....	79
Removing the rubber feet.....	81
Prerequisites.....	81
Procedure.....	81





Replacing the rubber feet.....	83
Procedure.....	83
Post-requisites.....	83
Removing the display assembly.....	84
Prerequisites.....	84
Procedure.....	84
Replacing the display assembly.....	86
Procedure.....	86
Post-requisites.....	86
Clearing Forgotten Passwords.....	87
Procedure.....	87
Clearing CMOS Settings.....	89
Prerequisites.....	89
Procedure.....	89
Post-requisites.....	90
Flashing the BIOS.....	91
Getting help and contacting Dell.....	92
Self-help resources.....	92
Contacting Dell.....	93

Before working inside your computer

 **CAUTION:** To avoid damaging the components and cards, handle them by their edges and avoid touching pins and contacts.









 **NOTE:** The images in this document may differ from your computer depending on the configuration you ordered.

Before you begin

- 1 Save and close all open files and exit all open applications.
- 2 Shut down your computer.
 - Windows 10: Click or tap **Start** →  **Power** → **Shut down**.
 - Windows 8.1: On the **Start** screen, click or tap the power icon  → **Shut down**.
 - Windows 7: Click or tap **Start** → **Shut down**.
-  **NOTE:** If you are using a different operating system, see the documentation of your operating system for shut-down instructions.
- 3 Disconnect your computer and all attached devices from their electrical outlets.
- 4 Disconnect all cables such as telephone cables, network cables and so on, from your computer.
- 5 Disconnect all attached devices and peripherals, such as keyboard, mouse, monitor, and so on, from your computer.
- 6 Remove any media card and optical disc from your computer, if applicable.
- 7 After the computer is unplugged, press and hold the power button for 5 seconds to ground the system board.
 -  **CAUTION:** Place the computer on a flat, soft and clean surface to avoid scratching the display.
- 8 Place the computer face down.

Safety instructions

Use the following safety guidelines to protect your computer from potential damage and ensure your personal safety.

-  **WARNING:** Before working inside your computer, read the safety information that shipped with your computer. For more safety best practices, see the Regulatory Compliance home page at www.dell.com/regulatory_compliance.
-  **WARNING:** Disconnect all power sources before opening the computer cover or panels. After you finish working inside the computer, replace all covers, panels, and screws before connecting to the power source.
-  **CAUTION:** To avoid damaging the computer, ensure that the work surface is flat and clean.
-  **CAUTION:** To avoid damaging the components and cards, handle them by their edges and avoid touching pins and contacts.
-  **CAUTION:** You should only perform troubleshooting and repairs as authorized or directed by the Dell technical assistance team. Damage due to servicing that is not authorized by Dell is not covered by your warranty. See the safety instructions that shipped with the product or at www.dell.com/regulatory_compliance.
-  **CAUTION:** Before touching anything inside your computer, ground yourself by touching an unpainted metal surface, such as the metal at the back of the computer. While you work, periodically touch an unpainted metal surface to dissipate static electricity, which could harm internal components.
-  **CAUTION:** When you disconnect a cable, pull on its connector or on its pull tab, not on the cable itself. Some cables have connectors with locking tabs or thumb-screws that you must disengage before disconnecting the cable. When disconnecting cables, keep them evenly aligned to avoid bending any connector pins. When connecting cables, ensure that the ports and connectors are correctly oriented and aligned.
-  **CAUTION:** Press and eject any installed card from the media-card reader.

Recommended tools

The procedures in this document may require the following tools:

- Phillips screwdriver
- Plastic scribe

After working inside your computer



CAUTION: Leaving stray or loose screws inside your computer may severely damage your computer.

- 1 Replace all screws and ensure that no stray screws remain inside your computer.
- 2 Connect any external devices, peripherals, and cables you removed before working on your computer.
- 3 Replace any media cards, discs, and any other parts that you removed before working on your computer.
- 4 Connect your computer and all attached devices to their electrical outlets.
- 5 Turn on your computer.

Technical overview

⚠ WARNING: Before working inside your computer, read the safety information that shipped with your computer and follow the steps in [Before working inside your computer](#). After working inside your computer, follow the instructions in [After working inside your computer](#). For more safety best practices, see the Regulatory Compliance home page at www.dell.com/regulatory_compliance.

Inside view of your computer

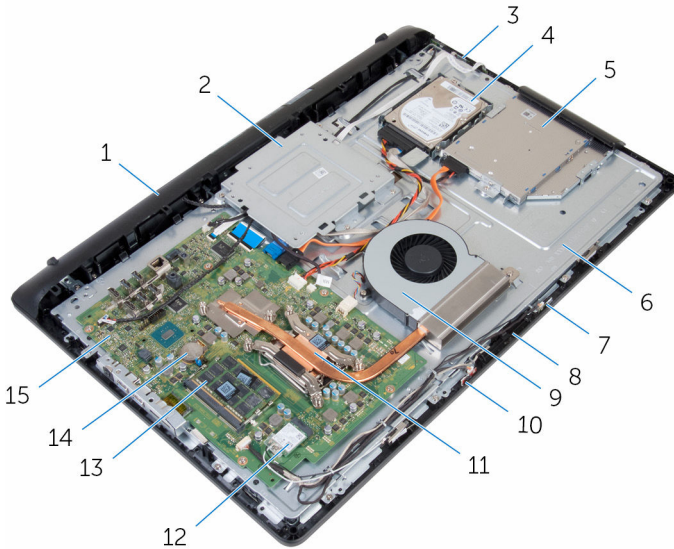

- | | | | |
|----|---|----|--|
| 1 | speaker cover | 2 | VESA-mount bracket |
| 3 | control-buttons board | 4 | hard-drive assembly |
| 5 | optical-drive assembly | 6 | middle cover |
| 7 | right microphone (touch-screen models only) | 8 | camera |
| 9 | fan | 10 | left microphone (touch-screen models only) |
| 11 | heat sink | 12 | wireless card |

- 13 memory modules
- 15 system board

- 14 coin-cell battery

System Board Components

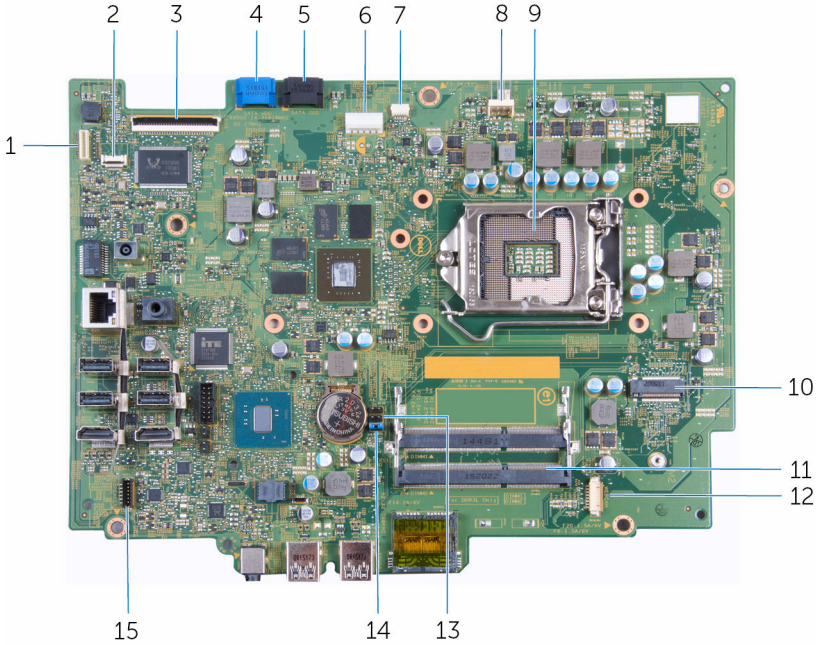

- | | | | |
|----|------------------------------------|----|--|
| 1 | display-backlight cable connector | 2 | control-buttons board cable connector |
| 3 | display-cable connector | 4 | hard-drive data cable connector |
| 5 | optical-drive data cable connector | 6 | hard-drive and optical-drive power cable connector |
| 7 | touch-screen board cable connector | 8 | fan cable connector |
| 9 | processor socket | 10 | wireless-card slot |
| 11 | memory-modules slots (2) | 12 | camera and microphone-cable connector |

13 CMOS jumper

14 password jumper

15 speaker cable connector

Removing the stand

⚠ WARNING: Before working inside your computer, read the safety information that shipped with your computer and follow the steps in [Before working inside your computer](#). After working inside your computer, follow the instructions in [After working inside your computer](#). For more safety best practices, see the Regulatory Compliance home page at www.dell.com/regulatory_compliance.

Procedure

- 1 Using a plastic scribe, pry the stand cover off the back cover.
- 2 Slide and remove the stand cover from the back cover.

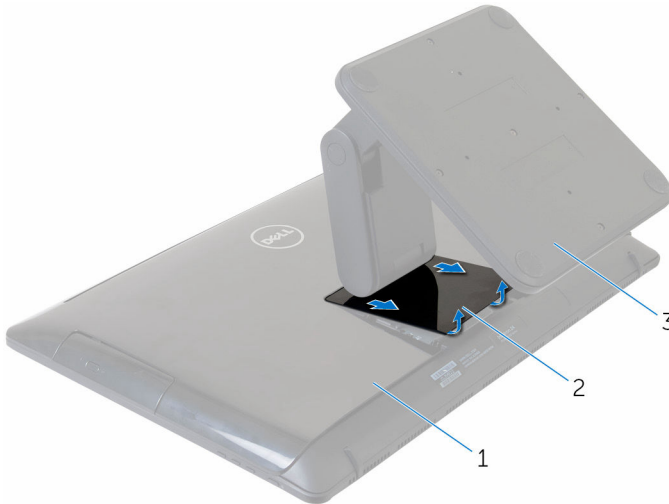

- | | | | |
|---|------------|---|-------------|
| 1 | back cover | 2 | stand cover |
| 3 | stand | | |

- 3 Remove the screws that secure the stand to the back cover.

4 Lift the stand off the back cover.

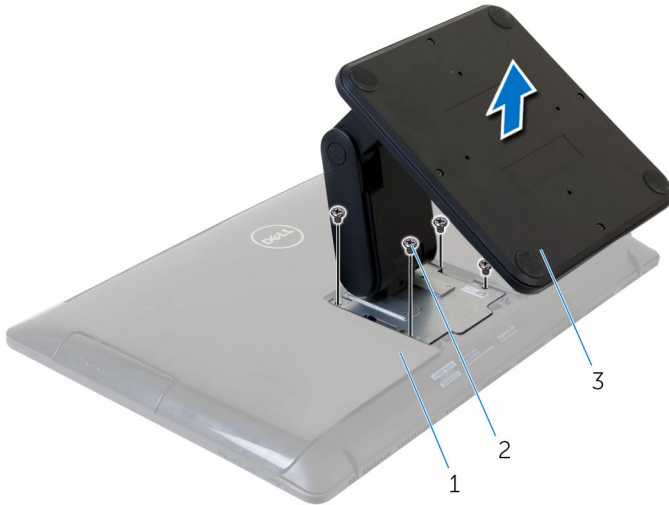

1 back cover

2 screws (4)

3 stand

Replacing the stand



WARNING: Before working inside your computer, read the safety information that shipped with your computer and follow the steps in [Before working inside your computer](#). After working inside your computer, follow the instructions in [After working inside your computer](#). For more safety best practices, see the Regulatory Compliance home page at www.dell.com/regulatory_compliance.

Procedure

- 1 Align the screw holes on the stand bracket to the screw holes on the back cover.
- 2 Replace the screws that secure the stand bracket to the back cover.
- 3 Slide and replace the stand cover on the stand bracket.

Removing the back cover

! **WARNING:** Before working inside your computer, read the safety information that shipped with your computer and follow the steps in [Before working inside your computer](#). After working inside your computer, follow the instructions in [After working inside your computer](#). For more safety best practices, see the Regulatory Compliance home page at www.dell.com/regulatory_compliance.

Prerequisites

Remove the [stand](#).

Procedure

! **CAUTION:** Do not remove the computer cover unless you need to install internal accessories for your computer.

- 1 Using a plastic scribe, pry the back cover from the display assembly.
- 2 Lift the back cover off the computer.

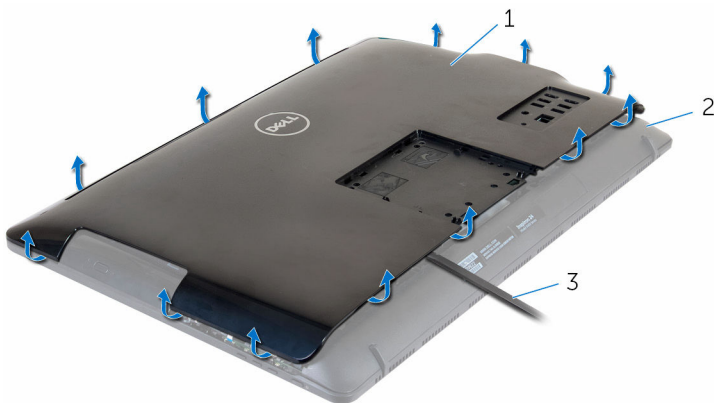

1 back cover

2 display assembly

3 plastic scribe

Replacing the back cover



WARNING: Before working inside your computer, read the safety information that shipped with your computer and follow the steps in [Before working inside your computer](#). After working inside your computer, follow the instructions in [After working inside your computer](#). For more safety best practices, see the Regulatory Compliance home page at www.dell.com/regulatory_compliance.

Procedure

Align the tabs on the back cover with the slots on the display assembly and snap the back cover into place.

Post-requisites

Replace the [stand](#).

Removing the optical drive



WARNING: Before working inside your computer, read the safety information that shipped with your computer and follow the steps in [Before working inside your computer](#). After working inside your computer, follow the instructions in [After working inside your computer](#). For more safety best practices, see the Regulatory Compliance home page at www.dell.com/regulatory_compliance.

Prerequisites

- 1 Remove the [stand](#).
- 2 Remove the [back cover](#).

Procedure

- 1 Disconnect the optical-drive cable from the optical drive.
- 2 Remove the screw that secures the optical-drive assembly to the middle cover.

- 3 Slide the optical-drive assembly out of the optical-drive bay.

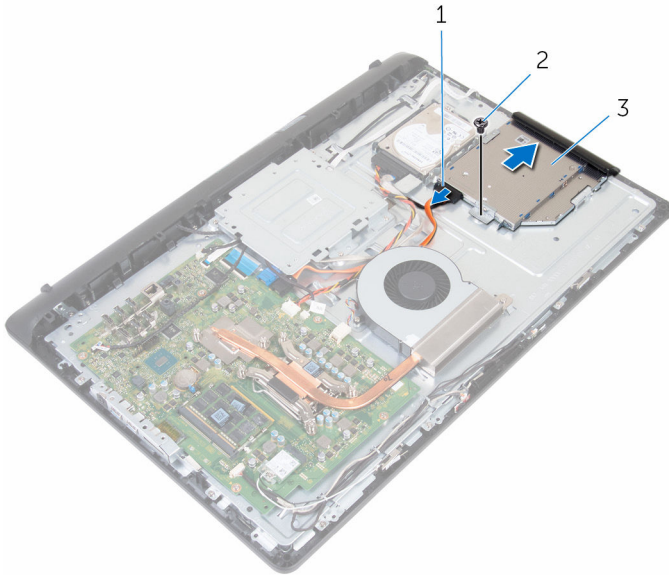

- | | | | |
|---|------------------------|---|-------|
| 1 | optical-drive cable | 2 | screw |
| 3 | optical-drive assembly | | |

- 4 Carefully pull the optical-drive bezel and remove it from the optical drive.
- 5 Remove the screw that secures the optical-drive bracket to the optical drive.

6 Remove the optical-drive bracket from the optical drive.

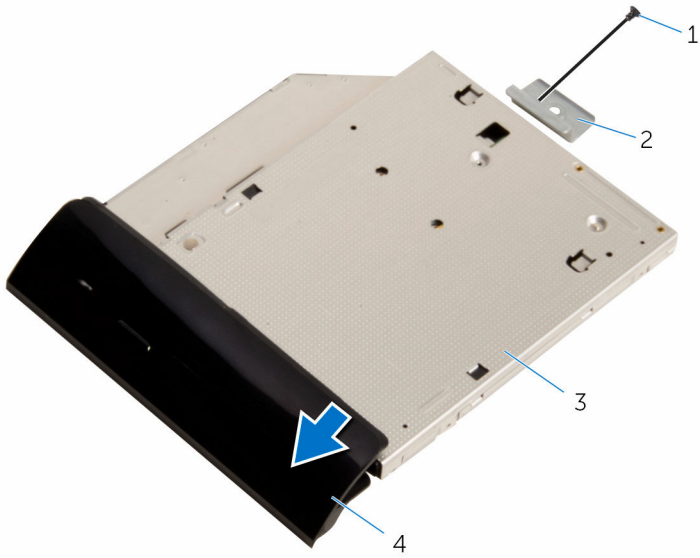

1 screw

3 optical drive

2 optical-drive bracket

4 optical-drive bezel

Replacing the optical drive



WARNING: Before working inside your computer, read the safety information that shipped with your computer and follow the steps in [Before working inside your computer](#). After working inside your computer, follow the instructions in [After working inside your computer](#). For more safety best practices, see the Regulatory Compliance home page at www.dell.com/regulatory_compliance.



Procedure

- 1 Align the screw hole on the optical-drive bracket with the screw hole on the optical drive.
- 2 Replace the screw that secures the optical-drive bracket to the optical drive.
- 3 Align the tabs on the optical-drive bezel with the slots on the optical-drive assembly and snap it into place.
- 4 Slide the optical-drive assembly into the optical-drive bay and align the screw hole on the optical-drive bracket with the screw hole on the middle cover.
- 5 Replace the screw that secures the optical-drive assembly to the middle cover.
- 6 Connect the optical-drive cable to the optical-drive assembly.

Post-requisites

- 1 Replace the [back cover](#).
- 2 Replace the [stand](#).

Removing the hard drive

-  **WARNING:** Before working inside your computer, read the safety information that shipped with your computer and follow the steps in [Before working inside your computer](#). After working inside your computer, follow the instructions in [After working inside your computer](#). For more safety best practices, see the Regulatory Compliance home page at www.dell.com/regulatory_compliance.
-  **CAUTION:** Hard drives are fragile. Exercise care when handling the hard drive.
-  **CAUTION:** To avoid data loss, do not remove the hard drive while the computer is in sleep or on state.

Prerequisites

- 1 Remove the [stand](#).
- 2 Remove the [back cover](#).

Procedure

- 1 Disconnect the hard-drive cable from the hard drive.
- 2 Remove the screw that secures the hard-drive assembly to the middle cover.

- 3 Slide and lift the hard-drive assembly off the middle cover.

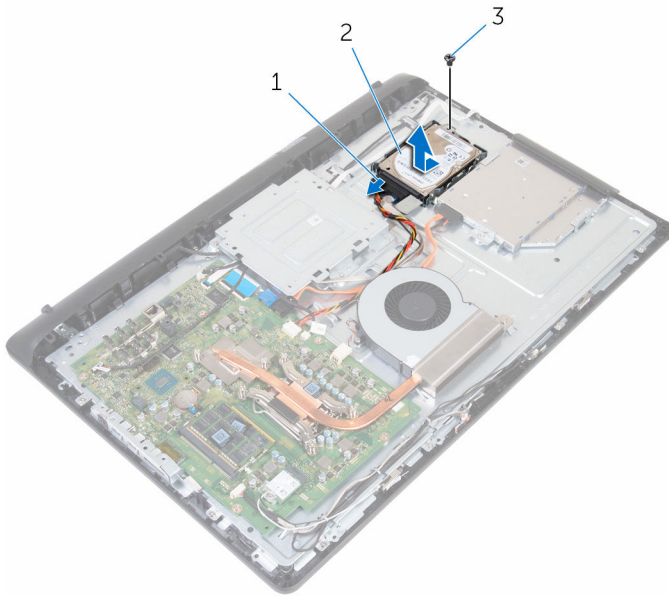

- | | | | |
|---|------------------|---|---------------------|
| 1 | hard-drive cable | 2 | hard-drive assembly |
| 3 | screw | | |

- 4 Remove the screws that secure the hard-drive bracket to the hard drive.

5 Remove the hard drive from the hard-drive bracket.

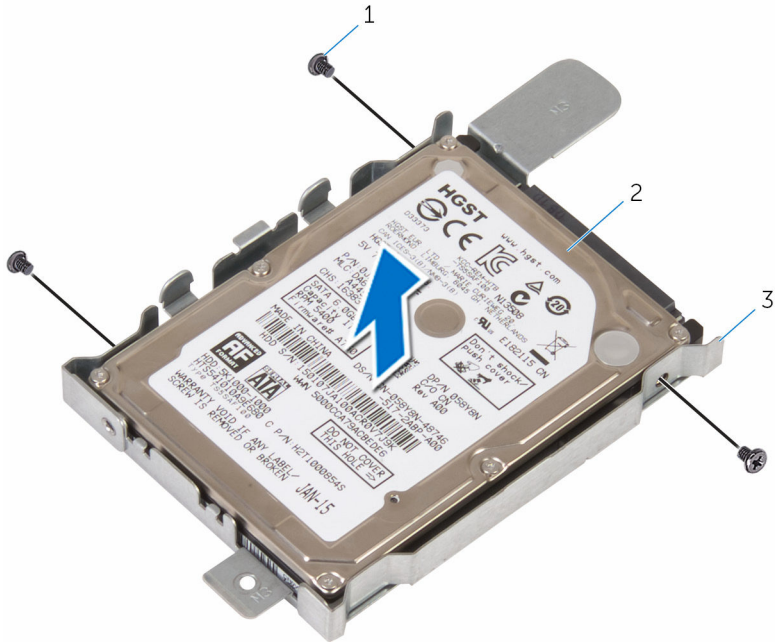



1 screws (3)

2 hard drive

3 hard-drive bracket

Replacing the hard drive

-  **WARNING:** Before working inside your computer, read the safety information that shipped with your computer and follow the steps in [Before working inside your computer](#). After working inside your computer, follow the instructions in [After working inside your computer](#). For more safety best practices, see the Regulatory Compliance home page at www.dell.com/regulatory_compliance.
-  **CAUTION:** Hard drives are fragile. Exercise care when handling the hard drive.

Procedure

- 1 Place the hard drive into the hard-drive bracket and align the screw holes on the hard drive with the screw holes on the hard-drive bracket.
- 2 Replace the screws that secure the hard-drive bracket to the hard drive.
- 3 Slide the hard-drive assembly into the hard-drive bay and align the screw hole on the hard-drive bracket with the screw hole on the middle cover.
- 4 Replace the screw that secures the hard-drive assembly to the middle cover.
- 5 Connect the hard-drive cable to the hard drive.

Post-requisites

- 1 Replace the [back cover](#).
- 2 Replace the [stand](#).

Removing the memory modules



WARNING: Before working inside your computer, read the safety information that shipped with your computer and follow the steps in [Before working inside your computer](#). After working inside your computer, follow the instructions in [After working inside your computer](#). For more safety best practices, see the Regulatory Compliance home page at www.dell.com/regulatory_compliance.

Prerequisites

- 1 Remove the [stand](#).
- 2 Remove the [back cover](#).

Procedure

- 1 Using your fingertips, carefully spread apart the securing clips at each end of the memory-module slot until the memory module pops up.

2 Slide and remove the memory module from the memory-module slot.

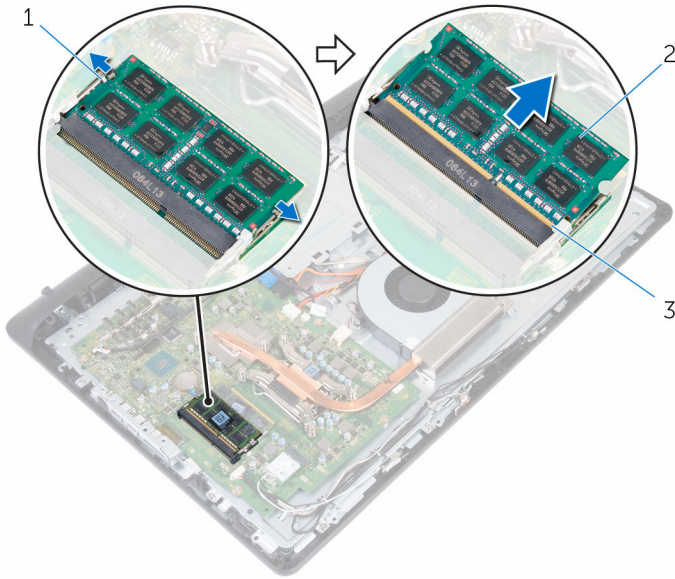

- 1 securing clips (2)
- 3 memory-module slot

- 2 memory module

Replacing the memory modules



WARNING: Before working inside your computer, read the safety information that shipped with your computer and follow the steps in [Before working inside your computer](#). After working inside your computer, follow the instructions in [After working inside your computer](#). For more safety best practices, see the Regulatory Compliance home page at www.dell.com/regulatory_compliance.

Procedure

- 1 Align the notch on the memory module with the tab on the memory-module slot.

- Slide the memory module firmly into the slot at an angle and press the memory module down until it clicks into place.

 **NOTE:** If you do not hear the click, remove the memory module and reinstall it.

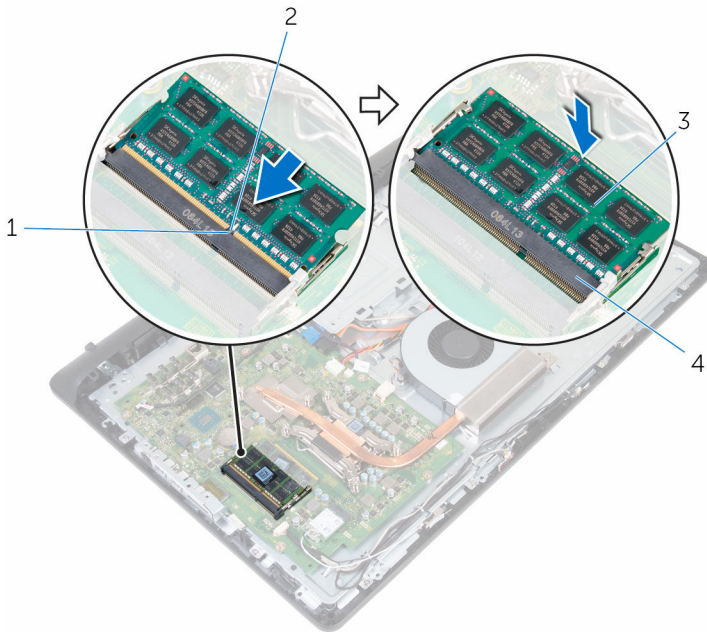

1 tab

3 memory module

2 notch

4 memory-module slot

Post-requisites

- Replace the [back cover](#).
- Replace the [stand](#).

Removing the wireless card



WARNING: Before working inside your computer, read the safety information that shipped with your computer and follow the steps in [Before working inside your computer](#). After working inside your computer, follow the instructions in [After working inside your computer](#). For more safety best practices, see the Regulatory Compliance home page at www.dell.com/regulatory_compliance.

Prerequisites

- 1 Remove the [stand](#).
- 2 Remove the [back cover](#).

Procedure

- 1 Remove the screw that secures the wireless-card bracket and the wireless card to the system board.
- 2 Slide the wireless-card bracket off the wireless card.
- 3 Disconnect the antenna cables from the wireless card.

4 Slide the wireless card out of the wireless-card slot.

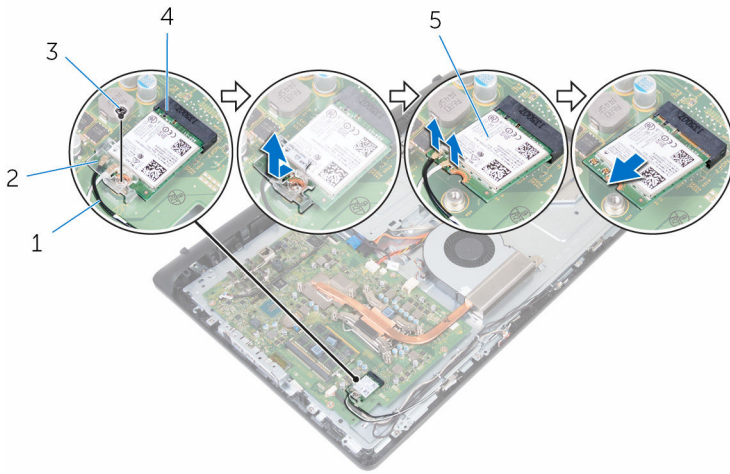

1 antenna cables (2)

2 wireless-card bracket

3 screw

4 wireless-card slot

5 wireless-card

Replacing the wireless card



WARNING: Before working inside your computer, read the safety information that shipped with your computer and follow the steps in [Before working inside your computer](#). After working inside your computer, follow the instructions in [After working inside your computer](#). For more safety best practices, see the Regulatory Compliance home page at www.dell.com/regulatory_compliance.

Procedure

- 1 Align the notch on the wireless card with the tab on the wireless-card slot and slide the wireless card into the wireless-card slot.
- 2 Connect the antenna cables to the wireless card.

The following table provides the antenna-cable color scheme for the wireless card supported by your computer:

Connectors on the wireless card	Antenna-cable color
Main (white triangle)	White
Auxiliary (black triangle)	Black

- 3 Slide the wireless-card bracket over the wireless card.
- 4 Align the screw hole on the wireless-card bracket with the screw hole on the wireless card.

- 5 Replace the screw that secures the wireless-card bracket and the wireless card to the system board.

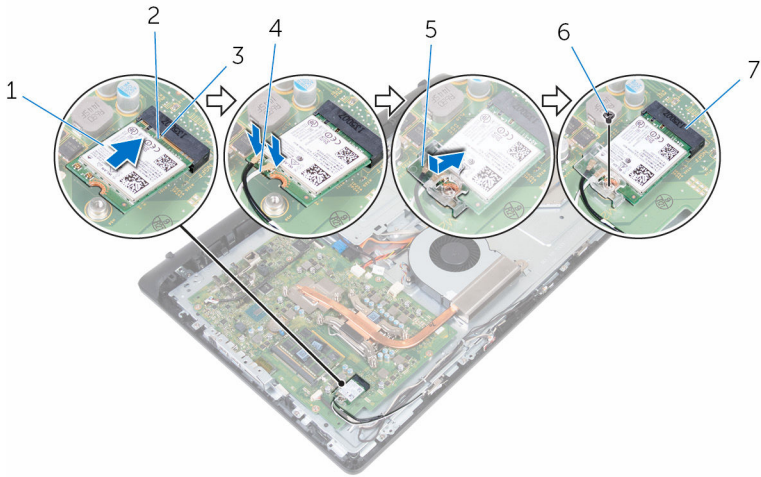



- | | | | |
|---|-----------------------|---|----------------|
| 1 | wireless card | 2 | notch |
| 3 | tab | 4 | antenna cables |
| 5 | wireless-card bracket | 6 | screw |
| 7 | wireless-card slot | | |

Post-requisites

- 1 Replace the [back cover](#).
- 2 Replace the [stand](#).

Removing the heat sink

-  **WARNING:** Before working inside your computer, read the safety information that shipped with your computer and follow the steps in [Before working inside your computer](#). After working inside your computer, follow the instructions in [After working inside your computer](#). For more safety best practices, see the Regulatory Compliance home page at www.dell.com/regulatory_compliance.
-  **WARNING:** The heat sink may become hot during normal operation. Allow sufficient time for the heat sink to cool before you touch it.
-  **CAUTION:** For maximum cooling of the processor, do not touch the heat transfer areas on the heat sink. The oils in your skin can reduce the heat transfer capability of the thermal grease.

Prerequisites

- 1 Remove the [stand](#).
- 2 Remove the [back cover](#).

Procedure

-  **NOTE:** Depending on the configuration you ordered, the number of screws and the appearance of the heat-sink assembly may differ.
- 1 In sequential order (as indicated on the heat sink), loosen the captive screws that secure the heat sink to the system board.
 - 2 Remove the screw that secures the heat sink to the middle cover.

3 Lift the heat sink off the system board.

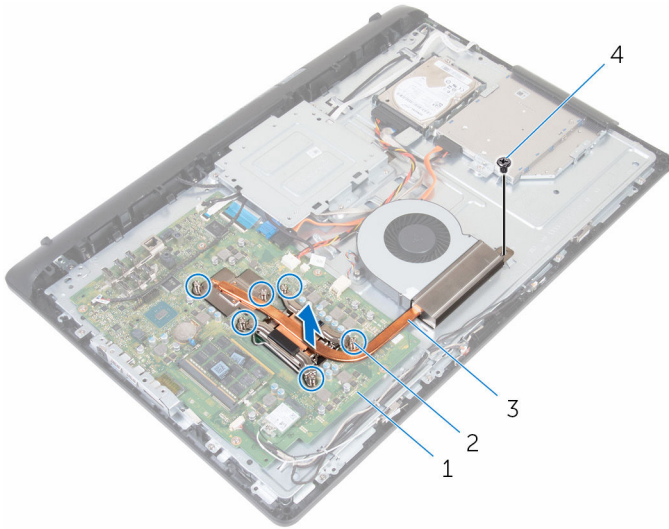

1 system board

3 heat sink

2 captive screws (6)

4 screw

Replacing the heat sink

 **WARNING:** Before working inside your computer, read the safety information that shipped with your computer and follow the steps in [Before working inside your computer](#). After working inside your computer, follow the instructions in [After working inside your computer](#). For more safety best practices, see the Regulatory Compliance home page at www.dell.com/regulatory_compliance.

 **CAUTION:** Incorrect alignment of the heat sink can damage the system board and processor.

 **NOTE:** The original thermal grease can be reused if the original processor and heat sink are reinstalled together. If either the processor or the heat sink is replaced, use the thermal pad provided in the kit to ensure that thermal conductivity is achieved.

Procedure

- 1 Align the captive screws on the heat sink with the screw holes on the system board.
- 2 In sequential order (as indicated on the heat sink), tighten the captive screws that secure the heat sink to the system board.
- 3 Replace the screw that secures the heat sink to the middle cover.

Post-requisites

- 1 Replace the [back cover](#).
- 2 Replace the [stand](#).

Removing the fan



WARNING: Before working inside your computer, read the safety information that shipped with your computer and follow the steps in [Before working inside your computer](#). After working inside your computer, follow the instructions in [After working inside your computer](#). For more safety best practices, see the Regulatory Compliance home page at www.dell.com/regulatory_compliance.

Prerequisites

- 1 Remove the [stand](#).
- 2 Remove the [back cover](#).

Procedure

- 1 Disconnect the fan cable from the system board.
- 2 Remove the screws that secure the fan to the middle cover.

3 Lift the fan off the middle cover.

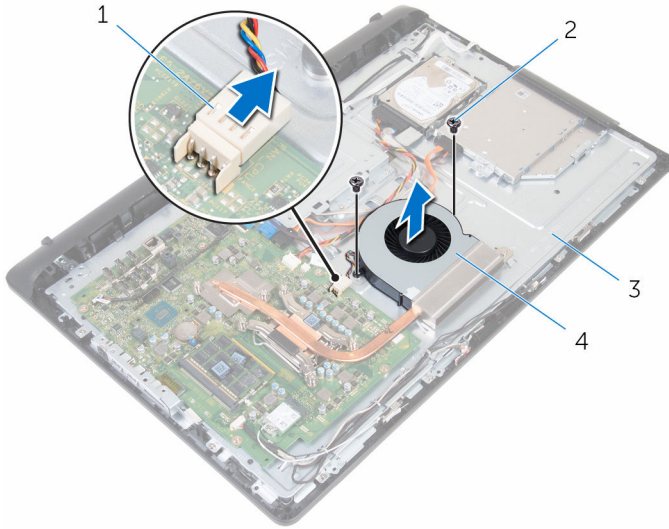

1 fan cable

2 screws (2)

3 middle cover

4 fan

Replacing the fan



WARNING: Before working inside your computer, read the safety information that shipped with your computer and follow the steps in [Before working inside your computer](#). After working inside your computer, follow the instructions in [After working inside your computer](#). For more safety best practices, see the Regulatory Compliance home page at www.dell.com/regulatory_compliance.



Procedure

- 1 Align the screw holes on the fan with the screw holes on the middle cover.
- 2 Replace the screws that secure the fan to the middle cover.
- 3 Connect the fan cable to the system board.

Post-requisites

- 1 Replace the [back cover](#).
- 2 Replace the [stand](#).

Removing the coin-cell battery

-  **WARNING:** Before working inside your computer, read the safety information that shipped with your computer and follow the steps in [Before working inside your computer](#). After working inside your computer, follow the instructions in [After working inside your computer](#). For more safety best practices, see the Regulatory Compliance home page at www.dell.com/regulatory_compliance.
-  **CAUTION:** Removing the coin-cell battery resets the BIOS setup program's settings to default. It is recommended that you note the BIOS setup program's settings before removing the coin-cell battery.

Prerequisites

- 1 Remove the [stand](#).
- 2 Remove the [back cover](#).

Procedure

Push the securing clip away from the battery till the battery pops up.

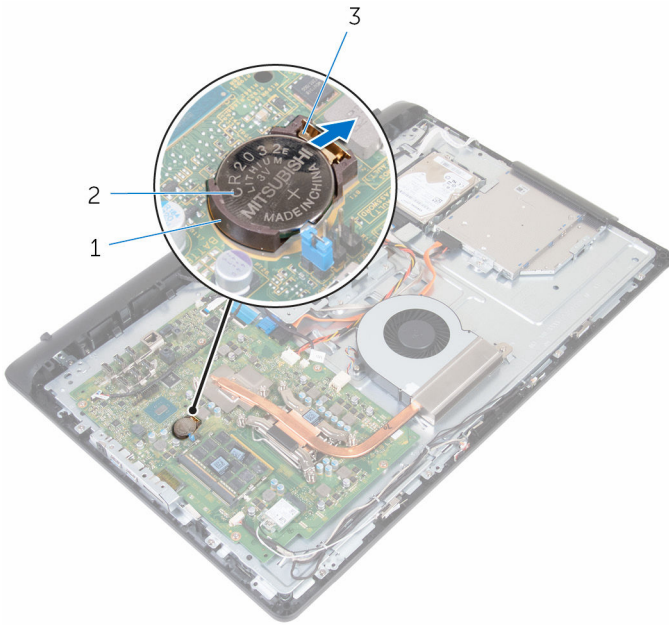

1 battery socket
3 securing clip

2 coin-cell battery

Replacing the coin-cell battery



WARNING: Before working inside your computer, read the safety information that shipped with your computer and follow the steps in [Before working inside your computer](#). After working inside your computer, follow the instructions in [After working inside your computer](#). For more safety best practices, see the Regulatory Compliance home page at www.dell.com/regulatory_compliance.

Procedure

With the positive-side facing up, slide the coin-cell battery into the battery socket and snap the battery in place.

Post-requisites

- 1 Replace the [back cover](#).
- 2 Replace the [stand](#).

Removing the processor



WARNING: Before working inside your computer, read the safety information that shipped with your computer and follow the steps in [Before working inside your computer](#). After working inside your computer, follow the instructions in [After working inside your computer](#). For more safety best practices, see the Regulatory Compliance home page at www.dell.com/regulatory_compliance.

Prerequisites

- 1 Remove the [stand](#).
- 2 Remove the [back cover](#).
- 3 Remove the [heat sink](#).

Procedure



NOTE: To avoid damaging the processor, handle the processor only by the edges.

- 1 Press the release lever down and then pull it outward to release it from the securing tab.
- 2 Extend the release lever completely to open the processor cover.

3 Gently lift the processor off the processor socket.

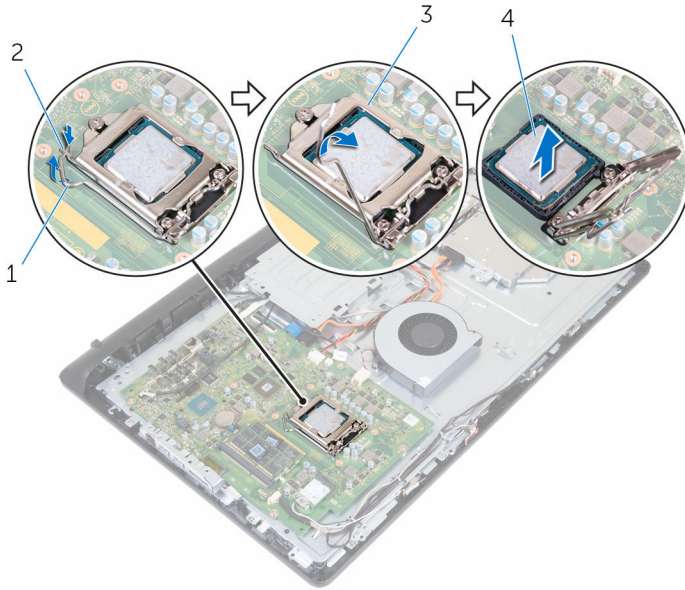



1 release lever

2 tab



3 processor cover

4 processor

Replacing the processor

-  **WARNING:** Before working inside your computer, read the safety information that shipped with your computer and follow the steps in [Before working inside your computer](#). After working inside your computer, follow the instructions in [After working inside your computer](#). For more safety best practices, see the Regulatory Compliance home page at www.dell.com/regulatory_compliance.
-  **CAUTION:** If either the processor or the heat sink is replaced, use the thermal grease provided in the kit to ensure that thermal conductivity is achieved.

Procedure

-  **NOTE:** The original thermal grease can be reused, if the original processor and heat sink are reinstalled together. If either the processor or the heat sink is replaced, use the thermal pad provided in the kit to ensure that thermal conductivity is achieved.
 -  **CAUTION:** You must position the processor correctly in the processor socket to avoid permanent damage to the processor.
- 1 Ensure that the processor cover is fully open.
 - 2 Align the pin-1 corner on the processor with the pin-1 corner on the processor socket and place the processor in the processor socket.
 - 3 Align the notches on the processor with the tabs on the processor socket.
 - 4 After the processor is fully seated in the socket, close the processor cover while keeping the release lever fully extended..
-  **CAUTION:** Ensure that the processor-cover notch is positioned underneath the alignment post.

- 5 Pivot the release lever down and place it under the tab on the processor cover.

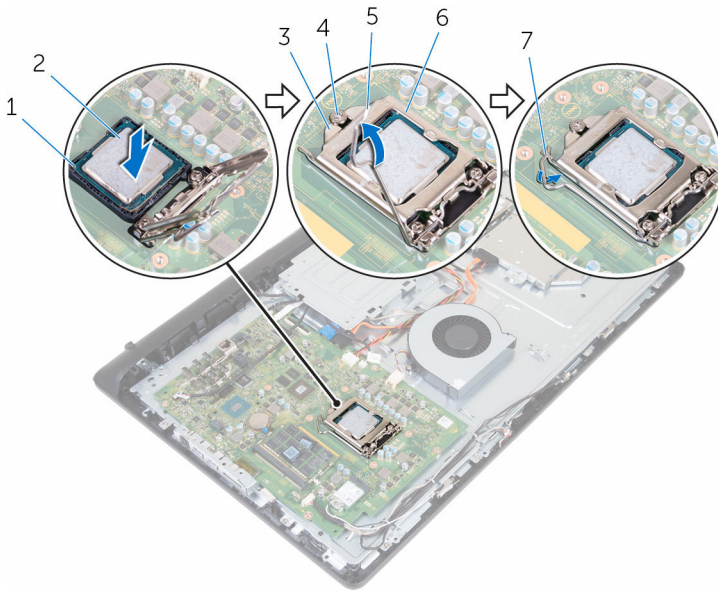

- | | | | |
|---|-----------------------|---|-----------------|
| 1 | pin-1 corner | 2 | processor |
| 3 | processor-cover notch | 4 | alignment post |
| 5 | release lever | 6 | processor cover |
| 7 | tab | | |

Post-requisites

- 1 Replace the [heat sink](#).
- 2 Replace the [back cover](#).
- 3 Replace the [stand](#).

Removing the microphone



WARNING: Before working inside your computer, read the safety information that shipped with your computer and follow the steps in [Before working inside your computer](#). After working inside your computer, follow the instructions in [After working inside your computer](#). For more safety best practices, see the Regulatory Compliance home page at www.dell.com/regulatory_compliance.

Prerequisites

- 1 Remove the [stand](#).
- 2 Remove the [back cover](#).

Procedure



NOTE: The left and right microphones cannot be swapped. Note the location so that you can replace them correctly.

- 1 Push the microphone inward and slide it out of the slot on the display bezel.

2 Disconnect the microphone cable from the microphone board.

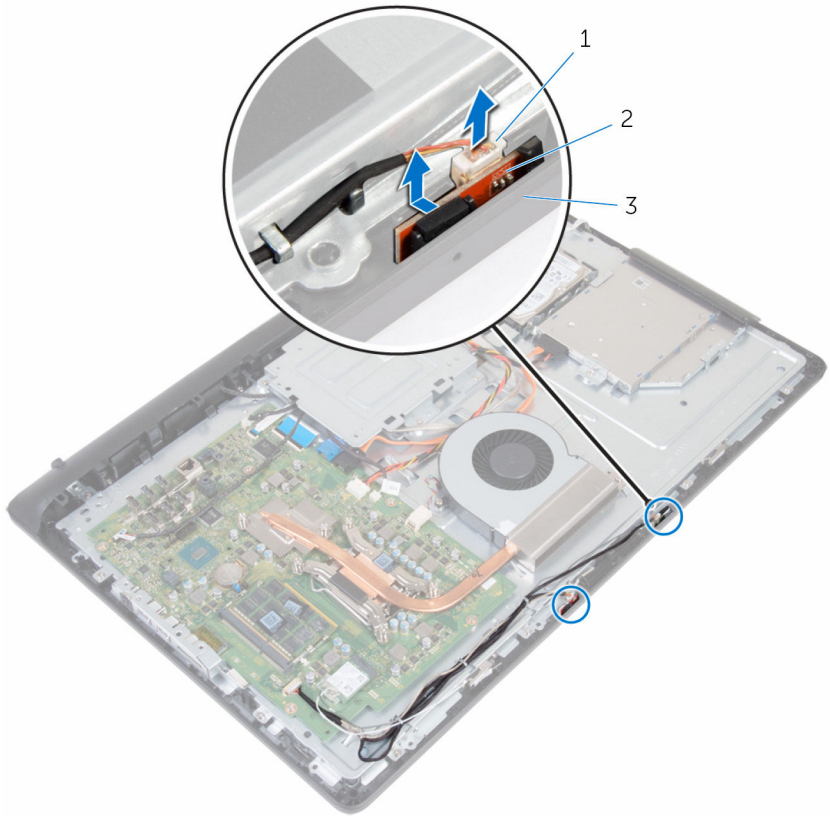

1 microphone cable
3 display bezel

2 microphones (2)

Replacing the microphone



WARNING: Before working inside your computer, read the safety information that shipped with your computer and follow the steps in [Before working inside your computer](#). After working inside your computer, follow the instructions in [After working inside your computer](#). For more safety best practices, see the Regulatory Compliance home page at www.dell.com/regulatory_compliance.

Procedure



NOTE: The left and right microphones cannot be swapped. Note the location so that you can replace them correctly.

- 1 Connect the microphone cable to the microphone board.
- 2 Slide the microphone board into the slot on the display bezel.
- 3 Route the microphone cable through the routing guides on the middle cover.

Post-requisites

- 1 Replace the [back cover](#).
- 2 Replace the [stand](#).

Removing the camera



WARNING: Before working inside your computer, read the safety information that shipped with your computer and follow the steps in [Before working inside your computer](#). After working inside your computer, follow the instructions in [After working inside your computer](#). For more safety best practices, see the Regulatory Compliance home page at www.dell.com/regulatory_compliance.

Prerequisites

- 1 Remove the [stand](#).
- 2 Remove the [back cover](#).

Procedure

- 1 Note the antenna, microphone, and camera-cable routing and remove the cables from the routing guides on the display bezel and middle cover.
- 2 Using your fingertips, press the securing clip and lift the camera assembly.
- 3 Disconnect the camera cable from the camera.
- 4 Disconnect the camera assembly from the tab on the display bezel.

5 Peel off the camera from the camera frame.

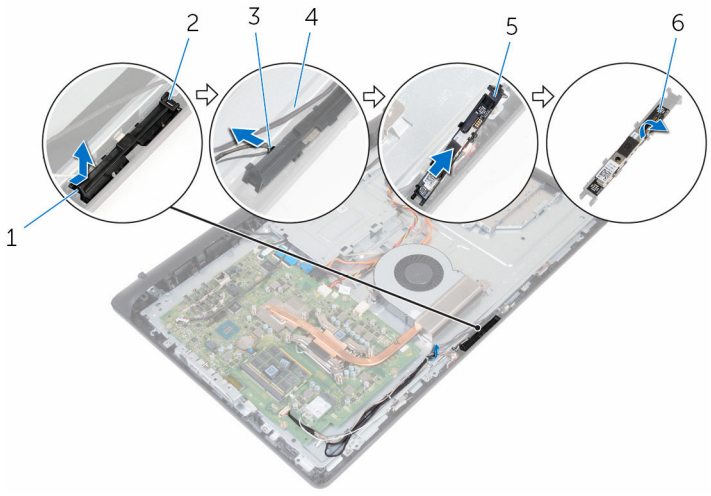

1 securing clip

3 camera cable

5 camera frame

2 tab

4 display bezel

6 camera

Replacing the camera



WARNING: Before working inside your computer, read the safety information that shipped with your computer and follow the steps in [Before working inside your computer](#). After working inside your computer, follow the instructions in [After working inside your computer](#). For more safety best practices, see the Regulatory Compliance home page at www.dell.com/regulatory_compliance.

Procedure

- 1 Adhere the camera to the camera frame.
- 2 Connect the camera cable to the camera.
- 3 Connect the camera assembly to the tabs on the display bezel
- 4 Press the camera assembly into the slot on the display bezel till the securing clip locks in place.
- 5 Route the antenna, microphone, and camera cables through the routing guides on the middle cover and display bezel.

Post-requisites

- 1 Replace the [back cover](#).
- 2 Replace the [stand](#).

Removing the system board



WARNING: Before working inside your computer, read the safety information that shipped with your computer and follow the steps in [Before working inside your computer](#). After working inside your computer, follow the instructions in [After working inside your computer](#). For more safety best practices, see the Regulatory Compliance home page at www.dell.com/regulatory_compliance.



NOTE: Your computer's Service Tag is stored in the system board. You must enter the Service Tag in the BIOS setup program after you replace the system board.



NOTE: Replacing the system board removes any changes you have made to the BIOS using the BIOS setup program. You must make the desired changes again after you replace the system board.



NOTE: Before disconnecting the cables from the system board, note the location of the connectors so that you can reconnect the cables correctly after you replace the system board.

Prerequisites

- 1 Remove the [stand](#).
- 2 Remove the [back cover](#).
- 3 Remove the [wireless card](#).
- 4 Remove the [memory modules](#).
- 5 Remove the [heat sink](#).
- 6 Remove the [processor](#).
- 7 Remove the [VESA-mount bracket](#).

Procedure

- 1 Disconnect the speaker, camera and microphone, and fan cables from the system board.

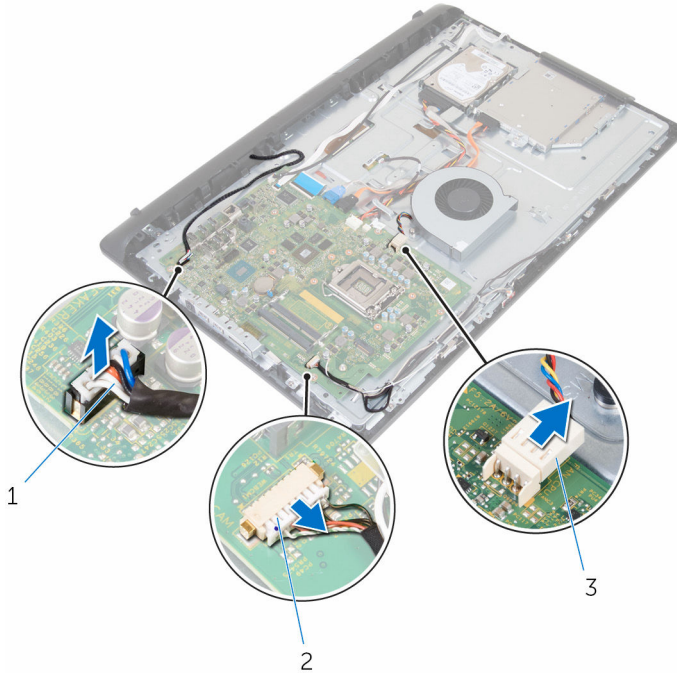

1 speaker cable

2 camera and microphones cable

3 fan cable

- 2 Disconnect the display-backlight, optical-drive data, hard-drive data, hard-drive and optical-drive power, and touch-screen board cables from the system board.

- 3** Open the latches and disconnect the control-buttons board cable and display cable from the system board.

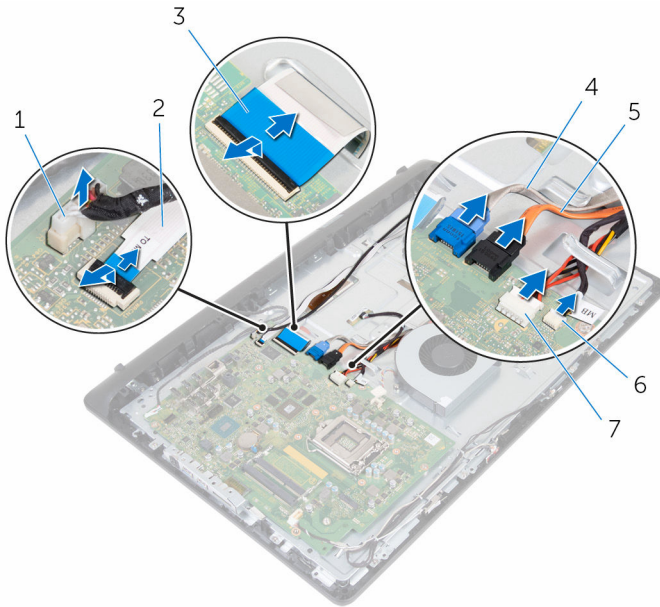

- | | | | |
|---|--------------------------|---|--|
| 1 | display-backlight cable | 2 | control-buttons board cable |
| 3 | display cable | 4 | hard-drive data cable |
| 5 | optical-drive data cable | 6 | hard-drive and optical-drive power cable |
| 7 | touch-screen board cable | | |

- 4** Remove the screws that secure the system board to the middle cover.
- 5** Starting from the inner edge, carefully lift the system board and release the ports from the slots on the middle cover.

6 Lift the system board off the middle cover.

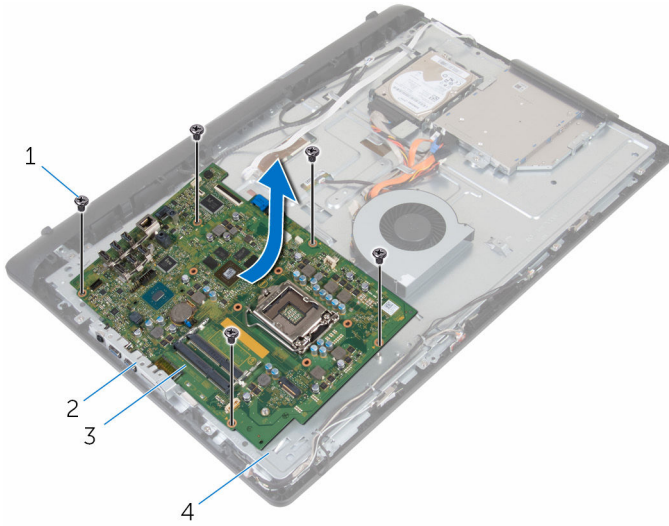

1 screws (5)

2 slots

3 system board

4 middle cover

Replacing the system board

 **WARNING:** Before working inside your computer, read the safety information that shipped with your computer and follow the steps in [Before working inside your computer](#). After working inside your computer, follow the instructions in [After working inside your computer](#). For more safety best practices, see the Regulatory Compliance home page at www.dell.com/regulatory_compliance.

 **NOTE:** Your computer's Service Tag is stored in the system board. You must enter the Service Tag in the BIOS setup program after you replace the system board.

 **NOTE:** Replacing the system board removes any changes you have made to the BIOS using the BIOS setup program. You must make the desired changes again after you replace the system board.

Procedure

 **CAUTION:** Make sure that no cables are placed under the system board.

- 1 Slide the ports on the system board into the slots on the middle cover and place the system board on the middle cover.
- 2 Align the screw holes on the system board with the screw holes on the middle cover.
- 3 Replace the screws that secure the system board to the middle cover.
- 4 Connect the display-backlight cable to on the system board.
- 5 Slide the control-buttons board and display cables into their connectors on the system board and close the latches to secure the cables.
- 6 Connect the speaker, touch-screen board, hard-drive, optical-drive, hard-drive and optical-drive power, fan, and microphone and camera cables to the system board.

Post-requisites

- 1 Replace the [memory modules](#).
- 2 Replace the [wireless card](#).
- 3 Replace the [heat sink](#).

- 4 Replace the [processor](#).
- 5 Replace the [VESA-mount bracket](#).
- 6 Replace the [back cover](#).
- 7 Replace the [stand](#).

Removing the VESA-mount bracket

 **WARNING:** Before working inside your computer, read the safety information that shipped with your computer and follow the steps in [Before working inside your computer](#). After working inside your computer, follow the instructions in [After working inside your computer](#). For more safety best practices, see the Regulatory Compliance home page at www.dell.com/regulatory_compliance.

Prerequisites

- 1 Remove the [stand](#).
- 2 Remove the [back cover](#).

Procedure

- 1 Note the speaker cable routing on the VESA-mount bracket and remove it from the routing guides.
- 2 Remove the screws that secure the VESA-mount bracket to the middle cover.

3 Lift the VESA-mount bracket off the middle cover.

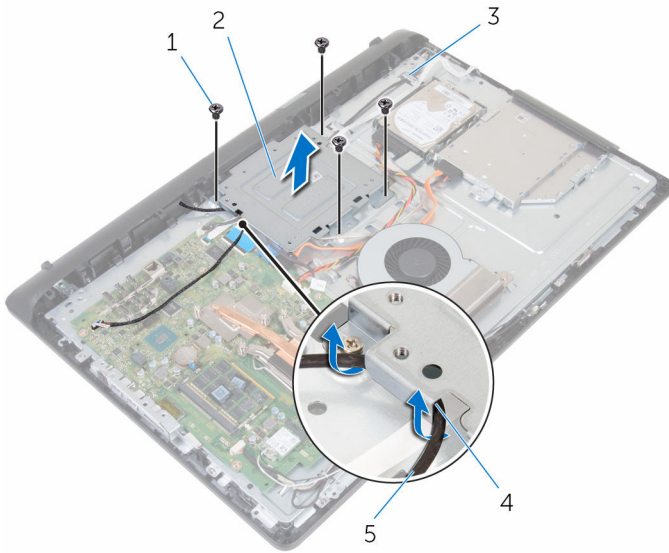

1 screws (4)

3 middle cover

5 speaker cable

2 VESA-mount bracket

4 routing guides

Replacing the VESA-mount bracket



WARNING: Before working inside your computer, read the safety information that shipped with your computer and follow the steps in [Before working inside your computer](#). After working inside your computer, follow the instructions in [After working inside your computer](#). For more safety best practices, see the Regulatory Compliance home page at www.dell.com/regulatory_compliance.

Procedure

- 1 Align the screw holes on the VESA-mount bracket with the screw holes on the middle frame.
- 2 Replace the screws that secure the VESA-mount bracket to the middle frame.
- 3 Route the speaker cable through the routing guides on the VESA-mount bracket.

Post-requisites

- 1 Replace the [back cover](#).
- 2 Replace the [stand](#).

Removing the speaker cover



WARNING: Before working inside your computer, read the safety information that shipped with your computer and follow the steps in [Before working inside your computer](#). After working inside your computer, follow the instructions in [After working inside your computer](#). For more safety best practices, see the Regulatory Compliance home page at www.dell.com/regulatory_compliance.

Prerequisites

- 1 Remove the [stand](#).
- 2 Remove the [back cover](#).

Procedure

- 1 Remove the screws that secure the speaker cover to the middle cover.
- 2 Using your fingertips, pry the speaker cover from the middle cover.

3 Lift the speaker cover off the display assembly.

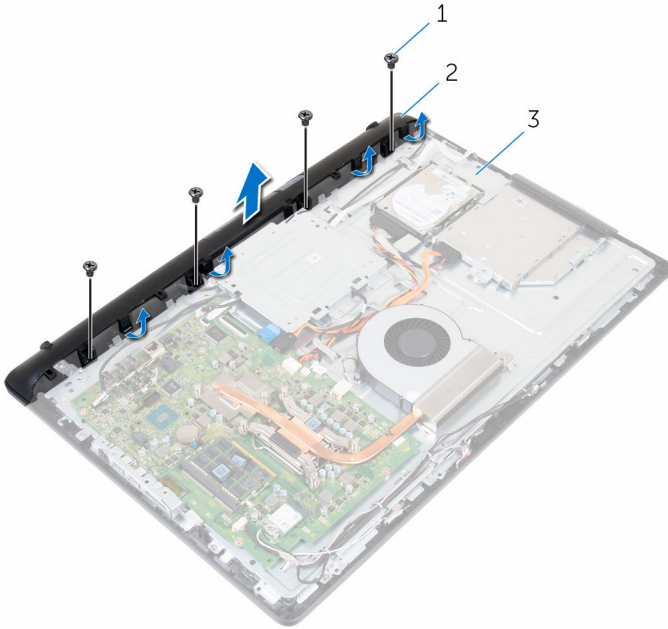

1 screws (4)

2 speaker cover

3 middle cover

Replacing the speaker cover



WARNING: Before working inside your computer, read the safety information that shipped with your computer and follow the steps in [Before working inside your computer](#). After working inside your computer, follow the instructions in [After working inside your computer](#). For more safety best practices, see the Regulatory Compliance home page at www.dell.com/regulatory_compliance.

Procedure

- 1 Align the screw holes on the speaker cover with the screw holes on the middle cover and snap the speaker cover into place.
- 2 Replace the screws that secure the speaker cover to the middle cover.

Post-requisites

- 1 Replace the [back cover](#).
- 2 Replace the [stand](#).

Removing the speakers



WARNING: Before working inside your computer, read the safety information that shipped with your computer and follow the steps in [Before working inside your computer](#). After working inside your computer, follow the instructions in [After working inside your computer](#). For more safety best practices, see the Regulatory Compliance home page at www.dell.com/regulatory_compliance.

Prerequisites

- 1 Remove the [stand](#).
- 2 Remove the [back cover](#).
- 3 Remove the [speaker cover](#).

Procedure

- 1 Disconnect the speaker cable from the system board.
- 2 Remove the speaker cable from the routing on the VESA-mount bracket.
- 3 Note the speaker-cable routing on the display bezel and remove the cable from the routing guides.

- 4 Lift the speakers, along with the speaker cable, off the display assembly.

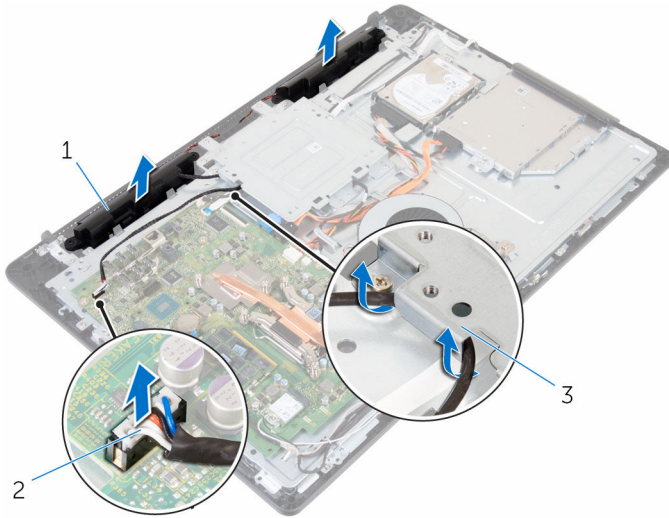

1 speakers (2)

2 speaker cable

3 VESA-mount bracket

Replacing the speakers



WARNING: Before working inside your computer, read the safety information that shipped with your computer and follow the steps in [Before working inside your computer](#). After working inside your computer, follow the instructions in [After working inside your computer](#). For more safety best practices, see the Regulatory Compliance home page at www.dell.com/regulatory_compliance.

Procedure

- 1 Using the alignment posts, place the speakers on the display assembly.
- 2 Route the speaker cable through the routing guide on the display bezel.
- 3 Route the speaker cable through the VESA-mount bracket.
- 4 Connect the speaker cable to the system board.

Post-requisites

- 1 Replace the [speaker cover](#).
- 2 Replace the [back cover](#).
- 3 Replace the [stand](#).

Removing the control-buttons board

 **WARNING:** Before working inside your computer, read the safety information that shipped with your computer and follow the steps in [Before working inside your computer](#). After working inside your computer, follow the instructions in [After working inside your computer](#). For more safety best practices, see the Regulatory Compliance home page at www.dell.com/regulatory_compliance.

Prerequisites

- 1 Remove the [stand](#).
- 2 Remove the [back cover](#).

Procedure

- 1 Move the securing clip away from the control-buttons board and lift the board out of the slot on the display bezel.

- 2 Open the latch and disconnect the control-buttons board cable from the control-buttons board.

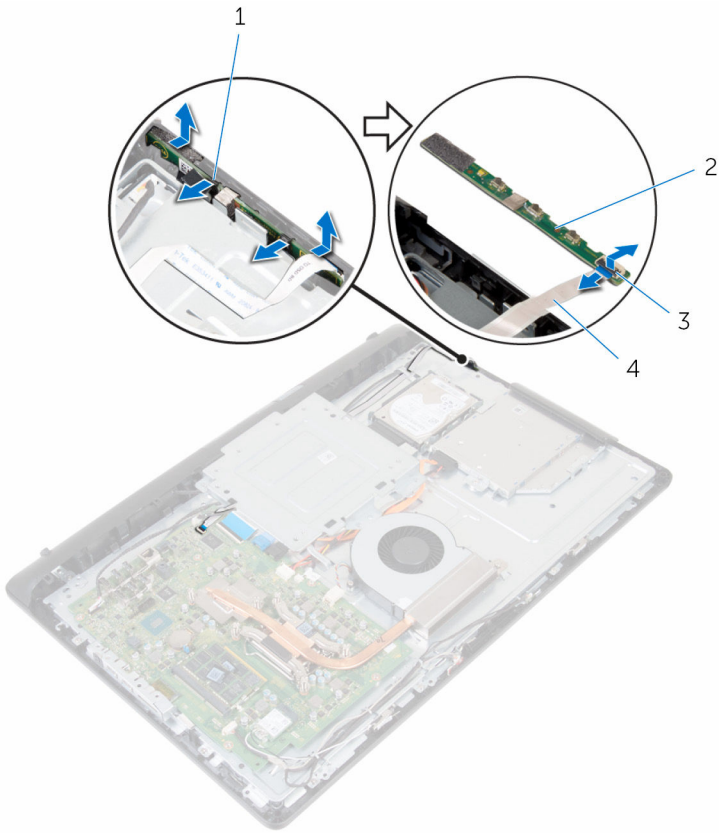

- 1 securing clips (2)
3 latch

- 2 control-buttons board
4 control-buttons board cable

Replacing the control-buttons board



WARNING: Before working inside your computer, read the safety information that shipped with your computer and follow the steps in [Before working inside your computer](#). After working inside your computer, follow the instructions in [After working inside your computer](#). For more safety best practices, see the Regulatory Compliance home page at www.dell.com/regulatory_compliance.

Procedure

- 1 Align the buttons on the control-buttons board with the buttons on the display bezel.
- 2 Slide the control-buttons board cable into the connector on the control-buttons board and close the latch to secure the cable.
- 3 Slide the control-buttons board into the slot on the display bezel till the securing clips lock in place.
- 4 Route the control-buttons board cable through the routing guides and adhere the control-buttons board cable to the middle cover.

Post-requisites

- 1 Replace the [back cover](#).
- 2 Replace the [stand](#).

Removing the middle cover



WARNING: Before working inside your computer, read the safety information that shipped with your computer and follow the steps in [Before working inside your computer](#). After working inside your computer, follow the instructions in [After working inside your computer](#). For more safety best practices, see the Regulatory Compliance home page at www.dell.com/regulatory_compliance.

Prerequisites

- 1 Remove the [stand](#).
- 2 Remove the [back cover](#).
- 3 Remove the [optical drive](#).
- 4 Remove the [hard drive](#).
- 5 Remove the [wireless card](#).
- 6 Remove the [heat sink](#).
- 7 Remove the [fan](#).
- 8 Remove the [system board](#).
- 9 Remove the [VESA-mount bracket](#).
- 10 Remove the [speaker cover](#).

Procedure

- 1 Note the routing of the antenna, camera and microphone, touch-screen board, optical drive and hard drive cables and remove the cables from the routing guides on the middle cover.
- 2 Disconnect the touch-screen board and display-backlight cables from the display panel.

3 Peel the control-buttons board cable from the middle cover.

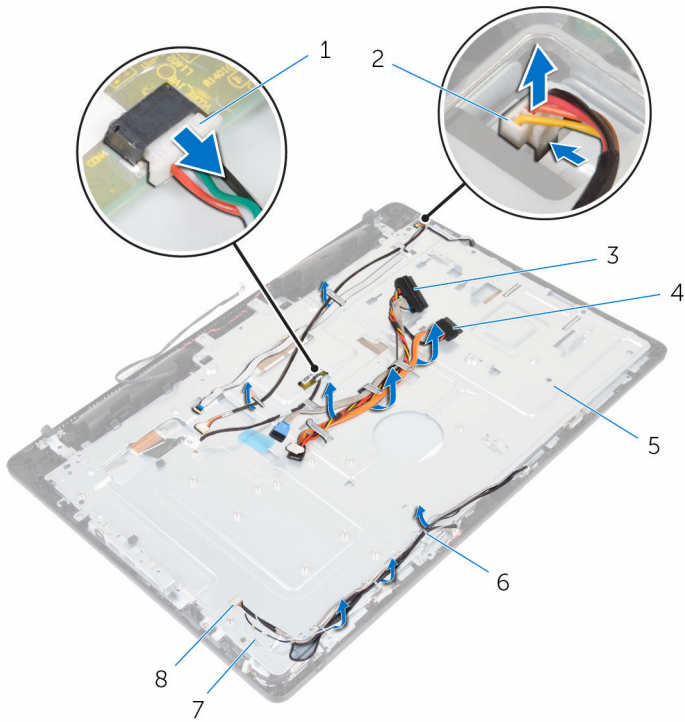

- | | | | |
|---|--------------------------|---|-----------------------------|
| 1 | touch-screen board cable | 2 | display-backlight cable |
| 3 | hard-drive cable | 4 | optical-drive cable |
| 5 | middle cover | 6 | routing guides |
| 7 | antenna cables (2) | 8 | camera and microphone cable |

4 Remove the screws that secure the middle cover to the display assembly.

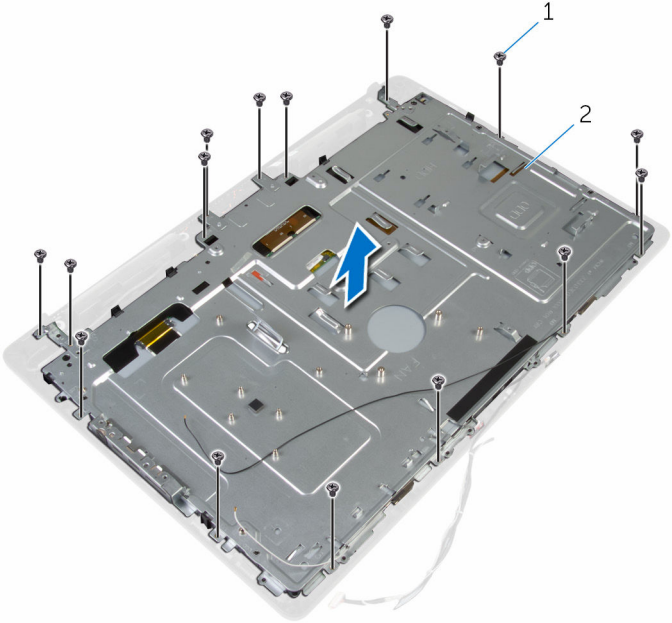

1 screws (16)

2 display assembly

- 5** Remove the screws that secure the middle cover to the display panel.

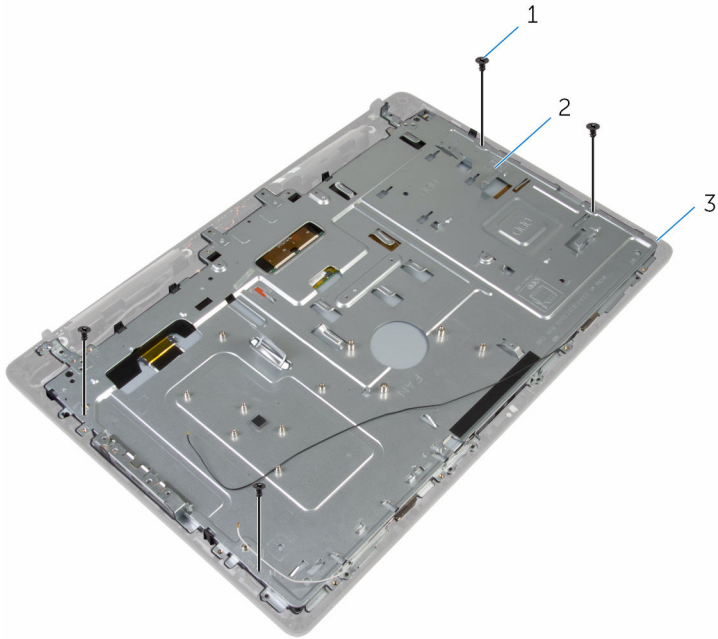

1 screws (4)

2 display assembly

- 6** Release the middle cover from the tabs on the display assembly.
7 Slide the display cable through the slot on the display assembly.

8 Lift the middle cover off the display assembly.

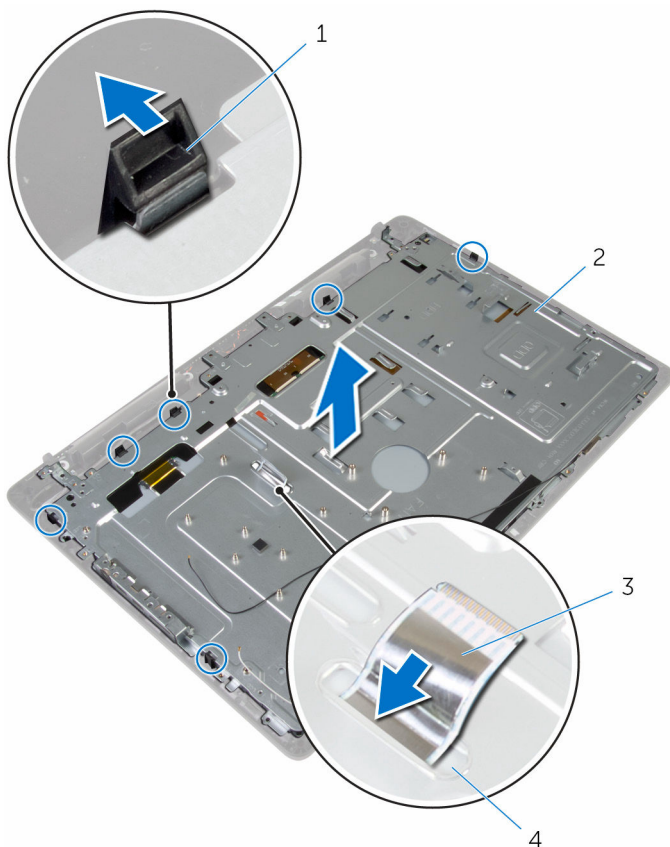

1 tabs (6)

3 display cable

2 middle cover

4 slot

Replacing the middle cover



WARNING: Before working inside your computer, read the safety information that shipped with your computer and follow the steps in [Before working inside your computer](#). After working inside your computer, follow the instructions in [After working inside your computer](#). For more safety best practices, see the Regulatory Compliance home page at www.dell.com/regulatory_compliance.

Procedure



CAUTION: Ensure that no cables are placed under the middle cover.

- 1 Align the slots on the middle cover with the tabs on the display assembly.
- 2 Slide the display cable through the slot on the middle cover.
- 3 Place the middle cover on the display assembly and press down till the tabs lock in place.
- 4 Replace the screws that secure the middle cover to the display assembly.
- 5 Route the antenna , camera and microphone, touch-screen board, optical drive and hard drive cables through the routing guides on the middle cover.
- 6 Adhere the control-buttons board cable to the middle cover.
- 7 Connect the touch-screen board and display-backlight cable to the display panel.

Post-requisites

- 1 Replace the [speaker cover](#).
- 2 Replace the [VESA-mount bracket](#).
- 3 Replace the [system board](#).
- 4 Replace the [fan](#).
- 5 Replace the [heat sink](#).
- 6 Replace the [wireless card](#).
- 7 Replace the [hard drive](#).
- 8 Replace the [optical drive](#).
- 9 Replace the [back cover](#).

10 Replace the [stand](#).

Removing the rubber feet



WARNING: Before working inside your computer, read the safety information that shipped with your computer and follow the steps in [Before working inside your computer](#). After working inside your computer, follow the instructions in [After working inside your computer](#). For more safety best practices, see the Regulatory Compliance home page at www.dell.com/regulatory_compliance.

Prerequisites

- 1 Remove the [stand](#).
- 2 Remove the [back cover](#).
- 3 Remove the [optical drive](#).
- 4 Remove the [hard drive](#).
- 5 Remove the [wireless card](#).
- 6 Remove the [heat sink](#).
- 7 Remove the [fan](#).
- 8 Remove the [system board](#).
- 9 Remove the [VESA-mount bracket](#).
- 10 Remove the [speaker cover](#).
- 11 Remove the [middle cover](#).

Procedure

- 1 Remove the screw that secures the rubber foot to the display assembly.

2 Lift the rubber foot off the display bezel.

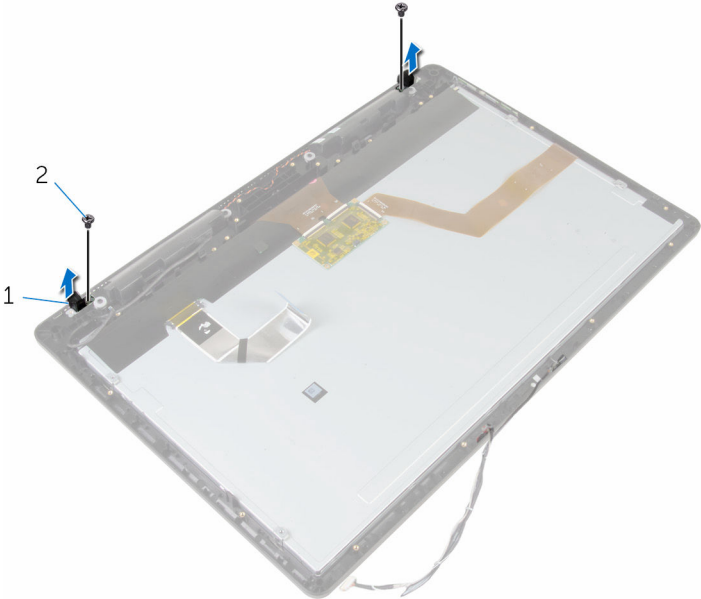

1 rubber feet (2)

2 screws (2)

3 display assembly

Replacing the rubber feet



WARNING: Before working inside your computer, read the safety information that shipped with your computer and follow the steps in [Before working inside your computer](#). After working inside your computer, follow the instructions in [After working inside your computer](#). For more safety best practices, see the Regulatory Compliance home page at www.dell.com/regulatory_compliance.

Procedure

- 1 Align the screw holes on the rubber foot with the screw holes on the display bezel.
- 2 Replace the screw that secures the rubber foot to the display assembly.

Post-requisites

- 1 Replace the [middle cover](#).
- 2 Replace the [speaker cover](#).
- 3 Replace the [VESA-mount bracket](#).
- 4 Replace the [system board](#).
- 5 Replace the [fan](#).
- 6 Replace the [heat sink](#).
- 7 Replace the [wireless card](#).
- 8 Replace the [hard drive](#).
- 9 Replace the [optical drive](#).
- 10 Replace the [back cover](#).
- 11 Replace the [stand](#).

Removing the display assembly



WARNING: Before working inside your computer, read the safety information that shipped with your computer and follow the steps in [Before working inside your computer](#). After working inside your computer, follow the instructions in [After working inside your computer](#). For more safety best practices, see the Regulatory Compliance home page at www.dell.com/regulatory_compliance.

Prerequisites

- 1 Remove the [stand](#).
- 2 Remove the [back cover](#).
- 3 Remove the [optical drive](#).
- 4 Remove the [hard drive](#).
- 5 Remove the [wireless card](#).
- 6 Remove the [heat sink](#).
- 7 Remove the [fan](#).
- 8 Remove the [microphone](#).
- 9 Follow the procedure from step 1 to step 4 in "[removing the camera](#)".
- 10 Remove the [system board](#).
- 11 Remove the [VESA-mount bracket](#).
- 12 Remove the [speaker cover](#).
- 13 Remove the [speakers](#).
- 14 Remove the [control-buttons board](#).
- 15 Remove the [middle cover](#).
- 16 Remove the [rubber feet](#).

Procedure

After performing the steps in the prerequisites, we are left with the display assembly.

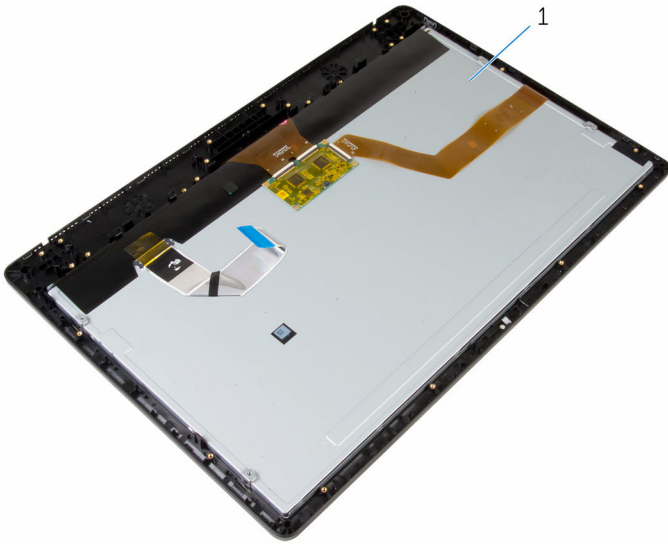

1 display assembly

Replacing the display assembly



WARNING: Before working inside your computer, read the safety information that shipped with your computer and follow the steps in [Before working inside your computer](#). After working inside your computer, follow the instructions in [After working inside your computer](#). For more safety best practices, see the Regulatory Compliance home page at www.dell.com/regulatory_compliance.

Procedure

Place the display assembly on a flat surface.

Post-requisites

- 1 Replace the [rubber feet](#).
- 2 Replace the [middle cover](#).
- 3 Replace the [control-buttons board](#).
- 4 Replace the [speakers](#).
- 5 Replace the [speaker cover](#).
- 6 Replace the [VESA-mount bracket](#).
- 7 Replace the [system board](#).
- 8 Follow the procedure from step 2 to step 5 in "[Replacing the camera](#)".
- 9 Replace the [microphone](#).
- 10 Replace the [fan](#).
- 11 Replace the [heat sink](#).
- 12 Replace the [wireless card](#).
- 13 Replace the [hard drive](#).
- 14 Replace the [optical drive](#).
- 15 Replace the [back cover](#).
- 16 Replace the [stand](#).

Clearing Forgotten Passwords

⚠ WARNING: Before working inside your computer, read the safety information that shipped with your computer and follow the steps in [Before working inside your computer](#). After working inside your computer, follow the instructions in [After working inside your computer](#). For more safety best practices, see the Regulatory Compliance home page at www.dell.com/regulatory_compliance.

Procedure

- 1 Remove the [stand](#).
- 2 Remove the [back cover](#).
- 3 Locate the password jumper on the system board.

✎ NOTE: For more information on the location of the jumpers, see "[System-board components](#)".

- 4 Remove the jumper plug from the password jumper.

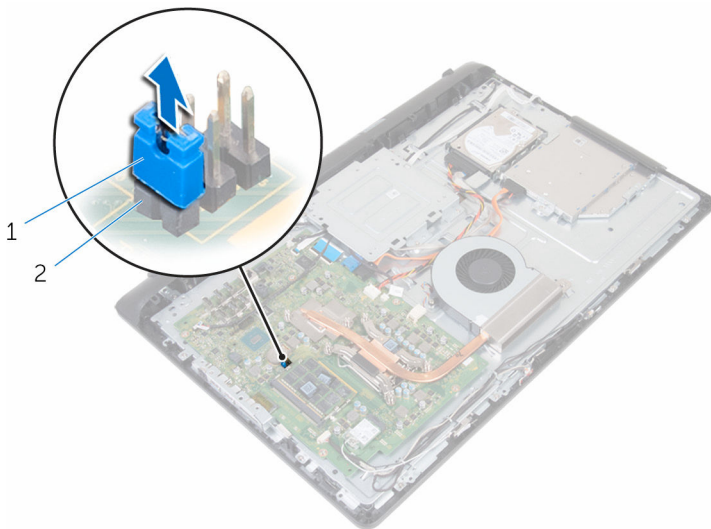

1 jumper plug

2 password jumper

- 5 Replace the [back cover](#).

- 6 Replace the [stand](#).
- 7 Turn on the computer and wait till the operating system is fully loaded.
- 8 Turn off the computer.
- 9 Remove the [stand](#).
- 10 Remove the [back cover](#).
- 11 Replace the jumper plug on the password jumper.

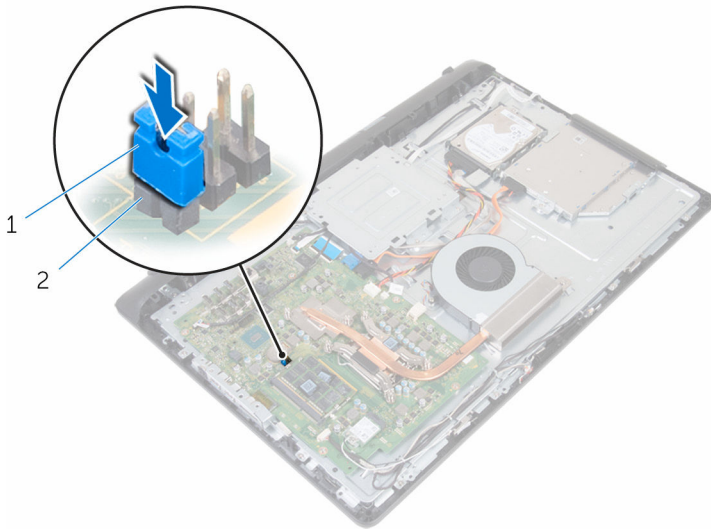

1 jumper plug

2 password jumper

- 12 Replace the [back cover](#).
- 13 Replace the [stand](#).

Clearing CMOS Settings

⚠ WARNING: Before working inside your computer, read the safety information that shipped with your computer and follow the steps in [Before working inside your computer](#). After working inside your computer, follow the instructions in [After working inside your computer](#). For more safety best practices, see the Regulatory Compliance home page at www.dell.com/regulatory_compliance.

Prerequisites

- 1 Remove the [stand](#).
- 2 Remove the [back cover](#).

Procedure

- 1 Locate the CMOS jumper on the system board.
 - 📝 NOTE:** For more information on the location of the jumpers, see [“System-board components”](#).
- 2 Remove the jumper plug from the password jumper and place it on the CMOS jumper.
- 3 Remove the jumper plug from the CMOS jumper and replace it on the password jumper.

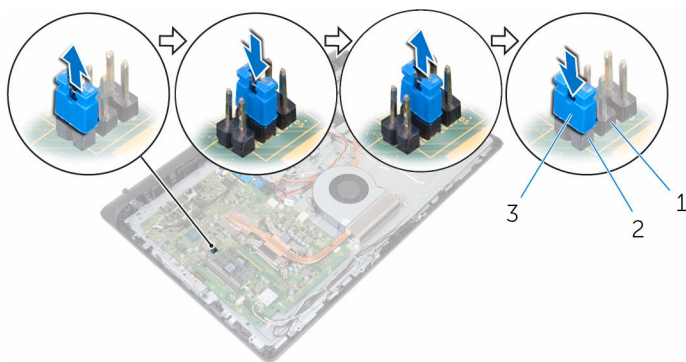

- 1 CMOS jumper
- 2 password jumper
- 3 jumper plug

Post-requisites

- 1 Replace the [back cover](#).
- 2 Replace the [stand](#).

Flashing the BIOS

You may need to flash (update) the BIOS when an update is available or when you replace the system board. To flash the BIOS:

- 1 Turn on the computer.
- 2 Go to **www.dell.com/support**.
- 3 Click **Product Support**, enter the Service Tag of your computer and click **Submit**.
 **NOTE:** If you do not have the Service Tag, use the auto-detect feature or manually browse for your computer model.
- 4 Click **Drivers & downloads**.
- 5 Select the operating system installed on your computer.
- 6 Scroll down the page and expand **BIOS**.
- 7 Click **Download File** to download the latest version of the BIOS for your computer.
- 8 Save the file and, once the download is complete, navigate to the folder where you saved the BIOS update file.
- 9 Double-click the BIOS update file icon and follow the instructions on the screen.

Getting help and contacting Dell

Self-help resources

You can get information and help on Dell products and services using these self-help resources:

Information about Dell products and services

www.dell.com

Windows 8.1 and Windows 10

Dell Help & Support app



Windows 10

Get started app



Windows 8.1

Help + Tips app



Accessing help in Windows 8, Windows 8.1, and Windows 10

In Windows search, type **Help and Support**, and press **Enter**.

Accessing help in Windows 7

Click **Start** → **Help and Support**.

Online help for operating system

www.dell.com/support/windows
www.dell.com/support/linux

Troubleshooting information, user manuals, setup instructions, product specifications, technical help blogs, drivers, software updates, and so on

www.dell.com/support

Learn about your operating system, setting up and using your computer, data backup, diagnostics, and so on.

See *Me and My Dell* at www.dell.com/support/manuals.

Contacting Dell

To contact Dell for sales, technical support, or customer service issues, see www.dell.com/contactdell.



NOTE: Availability varies by country and product, and some services may not be available in your country.



NOTE: If you do not have an active internet connection, you can find contact information on your purchase invoice, packing slip, bill, or Dell product catalog.