



OptiPlex 7040 - Small Form Factor Owner's Manual

Regulatory Model: D11S
Regulatory Type: D11S001



Notes, cautions, and warnings

-  **NOTE:** A NOTE indicates important information that helps you make better use of your computer.
-  **CAUTION:** A CAUTION indicates either potential damage to hardware or loss of data and tells you how to avoid the problem.
-  **WARNING:** A WARNING indicates a potential for property damage, personal injury, or death.

© 2016 Dell Inc. All rights reserved. This product is protected by U.S. and international copyright and intellectual property laws. Dell and the Dell logo are trademarks of Dell Inc. in the United States and/or other jurisdictions. All other marks and names mentioned herein may be trademarks of their respective companies.

2016 - 06

Rev. A01

Contents

1 Working on your computer.....	5
Before working inside your computer.....	5
Turning off your computer.....	5
After working inside your computer.....	5
2 Removing and installing components.....	6
Recommended tools.....	6
Removing the cover.....	6
Installing the cover.....	7
Removing the front bezel.....	7
Installing the front bezel.....	7
Removing the fan duct.....	7
Installing the fan duct.....	8
Removing the memory module.....	8
Installing the memory module.....	9
Removing the intrusion switch.....	9
Installing the intrusion switch.....	9
Removing the expansion card.....	10
Installing the expansion card.....	10
Removing the hard drive assembly.....	10
Removing the hard drive from the hard drive bracket.....	11
Installing the hard drive into the hard drive bracket.....	12
Installing the hard drive assembly.....	12
Removing the optical drive.....	12
Installing the optical drive.....	14
Removing the system fan.....	14
Installing the system fan.....	15
Removing the heat sink assembly.....	15
Installing the heat sink assembly.....	16
Removing the processor.....	16
Installing the processor.....	17
Removing the VGA daughter board.....	17
Installing the VGA daughter board.....	18
Removing the power supply unit (PSU).....	18
Installing the power supply unit (PSU).....	20
Removing the power switch.....	20
Installing the power switch.....	21
Removing the SD card reader.....	21

Installing the SD card reader.....	22
Installing the optional SSD card.....	22
Removing the optional SSD card.....	24
Removing the system board.....	24
Installing the system board.....	26
System board layout.....	27
3 Troubleshooting your computer.....	29
Diagnostic power LED codes.....	29
Diagnostic error messages.....	30
System error messages.....	34
4 System Setup.....	36
Boot Sequence.....	36
Navigation keys.....	36
System Setup overview.....	37
Accessing System Setup.....	37
System Setup options.....	37
Updating the BIOS	45
System and setup password.....	46
Assigning a system password and setup password.....	46
Deleting or changing an existing system and/or setup password.....	47
5 Specifications.....	48
6 Contacting Dell.....	53

Working on your computer

Before working inside your computer

To avoid damaging your computer, perform the following steps before you begin working inside the computer.

1. Ensure that your work surface is flat and clean to prevent the computer cover from being scratched.
2. Turn off your computer (see [Turning off your computer](#)).

 **CAUTION: To disconnect a network cable, first unplug the cable from your computer and then unplug the cable from the network device.**

3. Disconnect all network cables from the computer.
4. Disconnect your computer and all attached devices from their electrical outlets.
5. Press and hold the power button while the computer is unplugged to ground the system board.
6. Remove the cover.

 **CAUTION: Before touching anything inside your computer, ground yourself by touching an unpainted metal surface, such as the metal at the back of the computer. While you work, periodically touch an unpainted metal surface to dissipate static electricity, which could harm internal components.**

Turning off your computer

After working inside your computer

After you complete any replacement procedure, ensure that you connect any external devices, cards, and cables before turning on your computer.

1. Replace the cover.

 **CAUTION: To connect a network cable, first plug the cable into the network device and then plug it into the computer.**

2. Connect any telephone or network cables to your computer.
3. Connect your computer and all attached devices to their electrical outlets.
4. Turn on your computer.
5. If required, verify that the computer works correctly by running **Dell Diagnostics**.

Removing and installing components

This section provides detailed information on how to remove or install the components from your computer.

Recommended tools

The procedures in this document require the following tools:

- Small flat blade screwdriver
- Phillips screwdriver
- Small plastic scribe

Removing the cover

1. Follow the procedure in [Before Working Inside Your Computer](#).
2. To remove the cover:
 - a. Slide the blue retention tab to the right to unlock the cover [1].
 - b. Slide the cover toward the back of the computer [2].
 - c. Lift the cover from the computer [3].

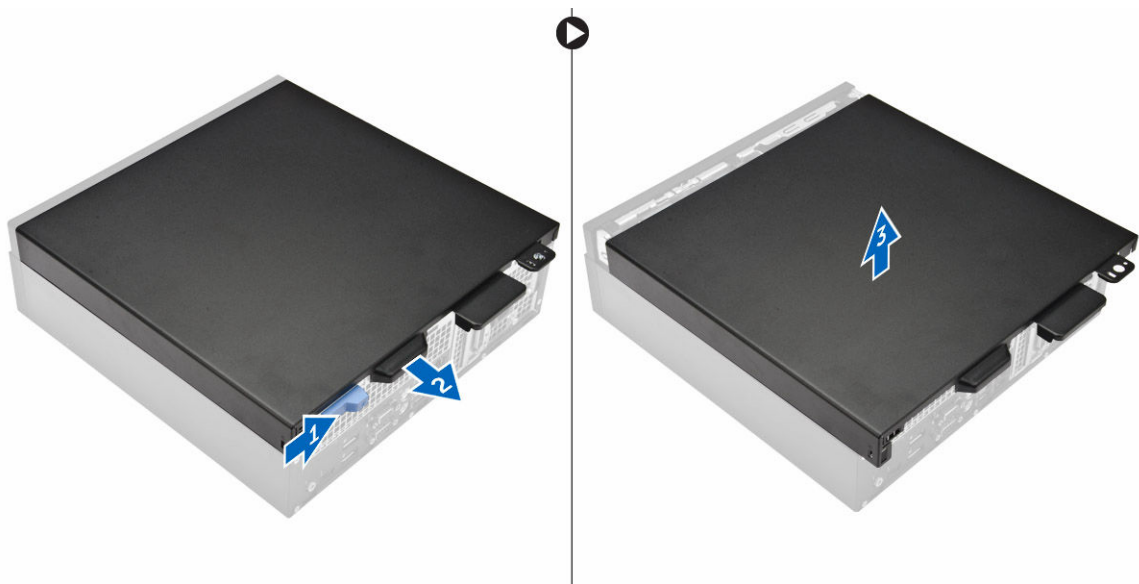

Installing the cover

1. Place the cover on the computer and slide the cover until it clicks into place.
2. Follow the procedure in [After Working Inside Your Computer](#)

Removing the front bezel

1. Follow the procedure in [Before Working Inside Your Computer](#).
2. Remove the [cover](#).
3. To remove the front bezel:
 - a. Lift the tabs to release the front bezel from the computer [1].
 - b. Remove the front bezel from the computer [2].

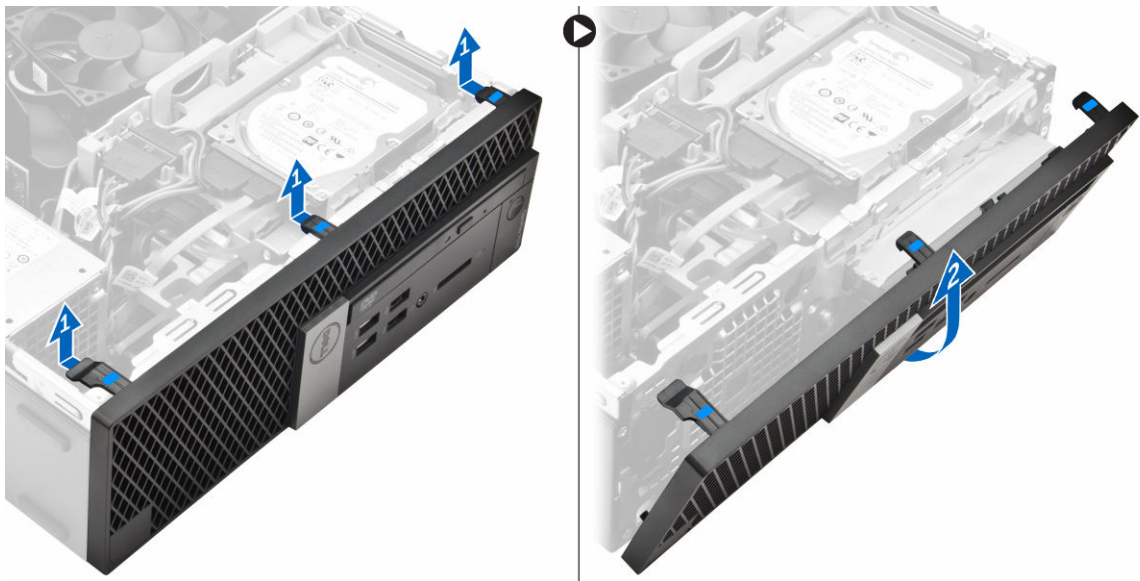

Installing the front bezel

1. Insert the tabs on the bezel into the slots on the computer.
2. Press the bezel until the tabs click into place.
3. Install the [cover](#).
4. Follow the procedure in [After Working Inside Your Computer](#)

Removing the fan duct

1. Follow the procedure in [Before Working Inside Your Computer](#).
2. Remove the [cover](#).
3. To remove the fan duct:
 - a. Holding the touch points, pull the fan duct bracket to release the fan duct [1].
 - b. Lift the fan duct away from the computer [2].

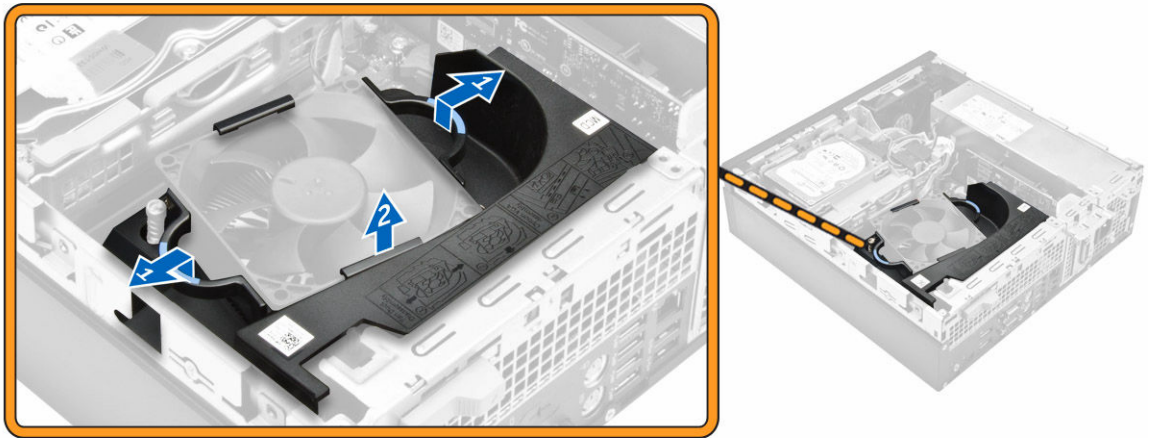

Installing the fan duct

1. Align the slots on the fan duct, with the screws on the heat sink.
2. Insert the fan duct until it clicks into place.
3. Install the [cover](#).
4. Follow the procedure in [After Working Inside Your Computer](#).

Removing the memory module

1. Follow the procedure in [Before Working Inside Your Computer](#).
2. Remove the:
 - a. [cover](#)
 - b. [fan duct](#)
 - c. [hard drive assembly](#)
 - d. [optical drive](#)
3. To remove the memory module:
 - a. Press the memory module retention tabs on both sides of the memory module.
 - b. Lift the memory module from the memory module connector on the system board.

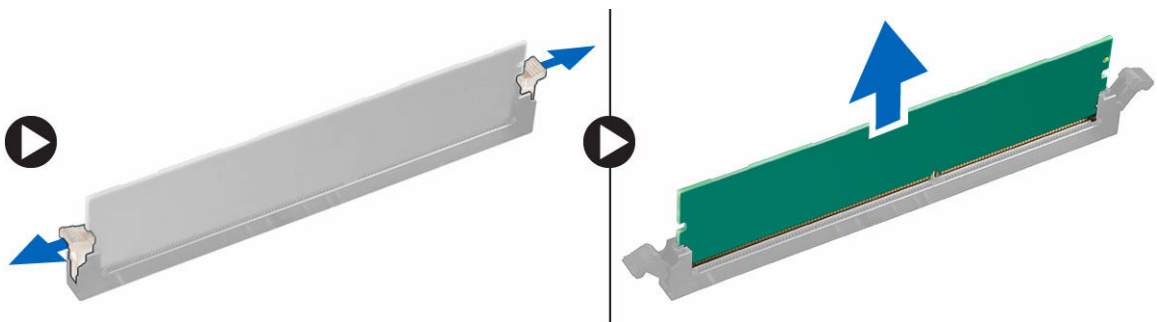

Installing the memory module

1. Align the notch on the memory module with the tab on the memory module connector.
2. Insert the memory module into the memory module socket.
3. Press the memory module until the memory module retention tabs click into place.
4. Install the:
 - a. [optical drive](#)
 - b. [hard drive assembly](#)
 - c. [fan duct](#)
 - d. [cover](#)
5. Follow the procedure in [After Working Inside Your Computer](#).

Removing the intrusion switch

1. Follow the procedure in [Before Working Inside Your Computer](#).
2. Remove the:
 - a. [cover](#)
 - b. [fan duct](#)
3. To remove the intrusion switch:
 - a. Disconnect the intrusion switch cable from the connector on the system board [1][2].
 - b. Slide the intrusion switch and lift it away from the computer [3].

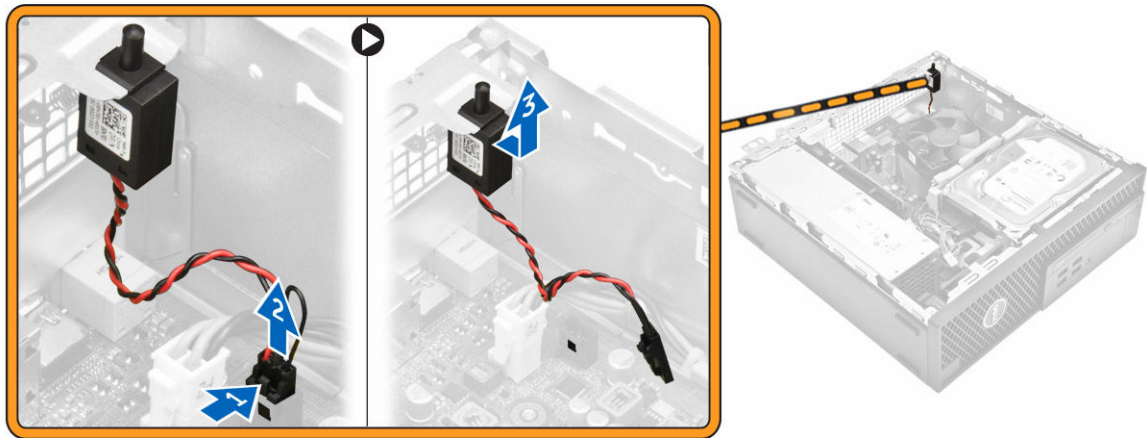

Installing the intrusion switch

1. Insert the intrusion switch into the slot on the chassis.
2. Connect the intrusion switch cable to the system board.
3. Install the:
 - a. [fan duct](#)
 - b. [cover](#)
4. Follow the procedure in [After Working Inside Your Computer](#).

Removing the expansion card

1. Follow the procedure in [Before Working Inside Your Computer](#).
2. Remove the:
 - a. [cover](#)
 - b. [fan duct](#)
3. To remove the expansion card:
 - a. Pull the metal tab to open the expansion card latch [1].
 - b. Pull the tab forward [2] and pull the expansion card from the connector on the computer [3].

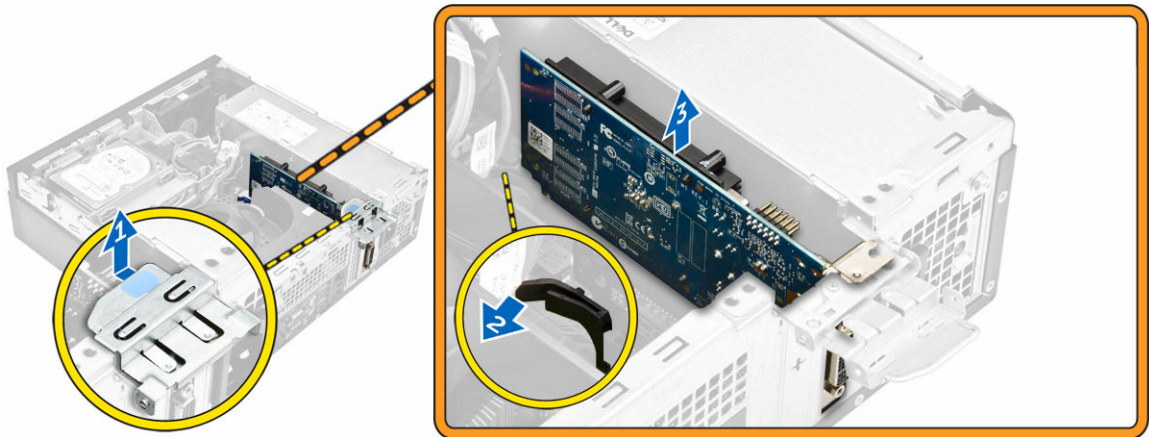

Installing the expansion card

1. Insert the expansion card into the connector on the system board.
2. Press the expansion card until it clicks into place.
3. Close the expansion card latch and press it until it clicks into place.
4. Install the:
 - a. [fan duct](#)
 - b. [cover](#)
5. Follow the procedure in [After Working Inside Your Computer](#).

Removing the hard drive assembly

1. Follow the procedure in [Before Working Inside Your Computer](#).
2. Remove the:
 - a. [cover](#)
 - b. [fan duct](#)
3. To release the hard drive assembly:
 - a. Push the retention tabs and remove the power connector [1,2].
 - b. Disconnect the data and power cables from the hard drives [3, 4].

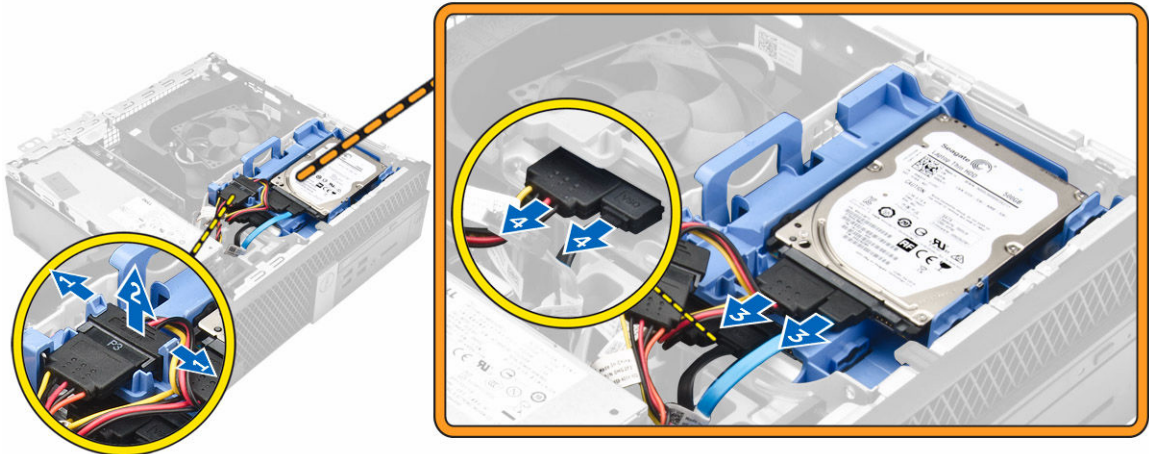

4. To remove the hard drive assembly:
 - a. Pull the hard drive release handle forward to release the hard drive bracket from the computer [1].
 - b. Lift the hard drive assembly away from the computer [2].

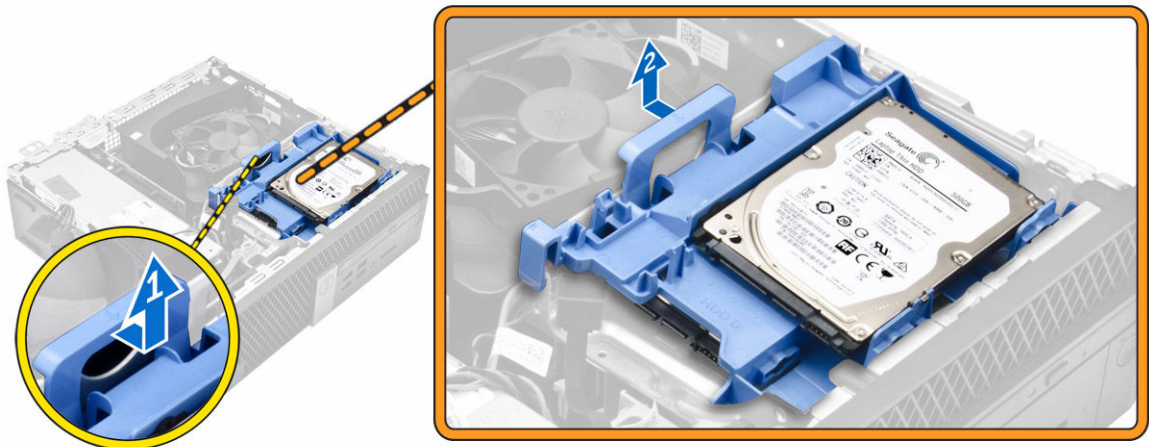

Removing the hard drive from the hard drive bracket

1. Follow the procedure in [Before Working Inside Your Computer](#).
2. Remove the:
 - a. [cover](#)
 - b. [bezel](#)
 - c. [hard drive assembly](#)
3. To remove the hard drive bracket:
 - a. Pull the hard drive bracket to release the hard drive [1].
 - b. Lift the hard drive out of the hard drive bracket [2].

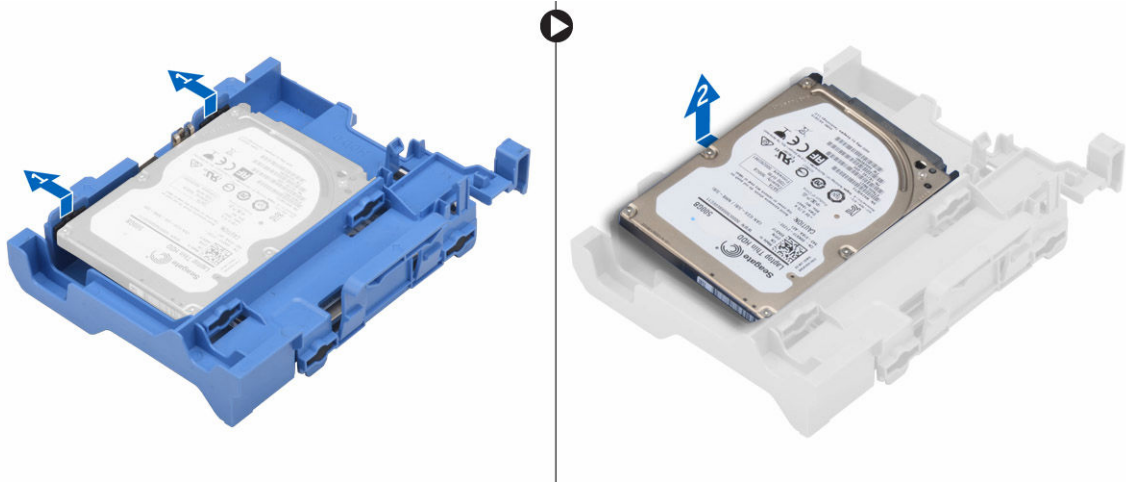

Installing the hard drive into the hard drive bracket

1. Insert the hard drive into the hard drive bracket until it clicks into place.
2. Install the:
 - a. [hard drive assembly](#)
 - b. [bezel](#)
 - c. [cover](#)
3. Follow the procedure in [After Working Inside Your Computer](#).

Installing the hard drive assembly

1. Insert the hard drive assembly into the slot on the computer.
2. Connect the power cable to the slot on the hard drive bracket.
3. Install the:
 - a. [fan duct](#)
 - b. [cover](#)
4. Follow the procedure in [After Working Inside Your Computer](#).

Removing the optical drive

1. Follow the procedure in [Before Working Inside Your Computer](#).
2. Remove the:
 - a. [cover](#)
 - b. [front bezel](#)
 - c. [hard drive assembly](#)
3. To release the optical drive:
 - a. Remove the hard drive connector cables from the optical drive latch [1].
 - b. Slide the blue latch to the unlock position [2].

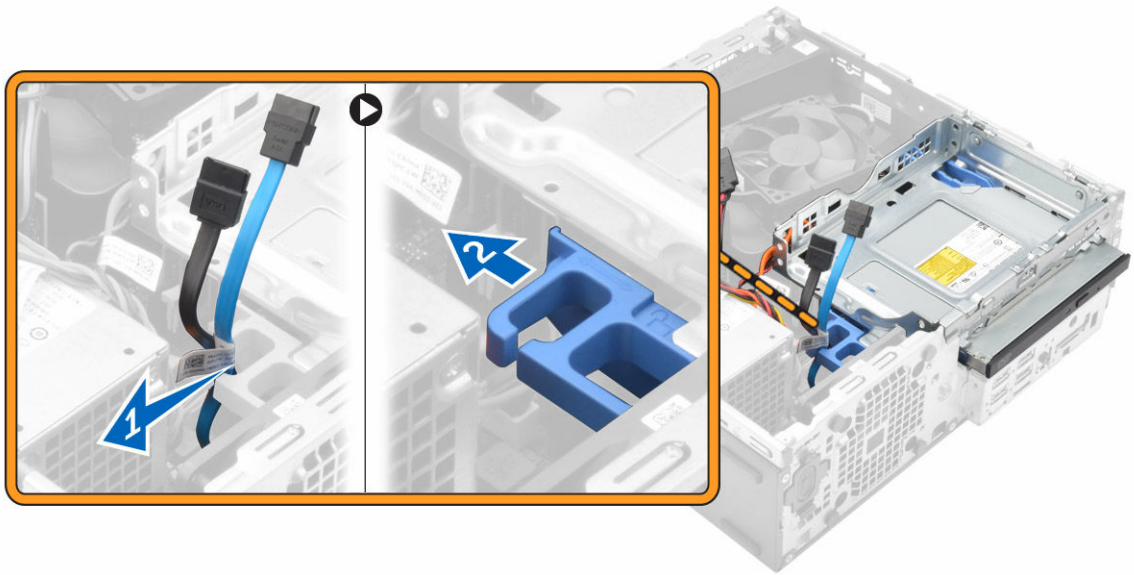

4. To remove the optical drive:
 - a. Holding the blue latch [1], lift the optical drive cage and disconnect the cables from the optical drive. [2]
 - b. Lift the optical drive cage away from the computer [3].

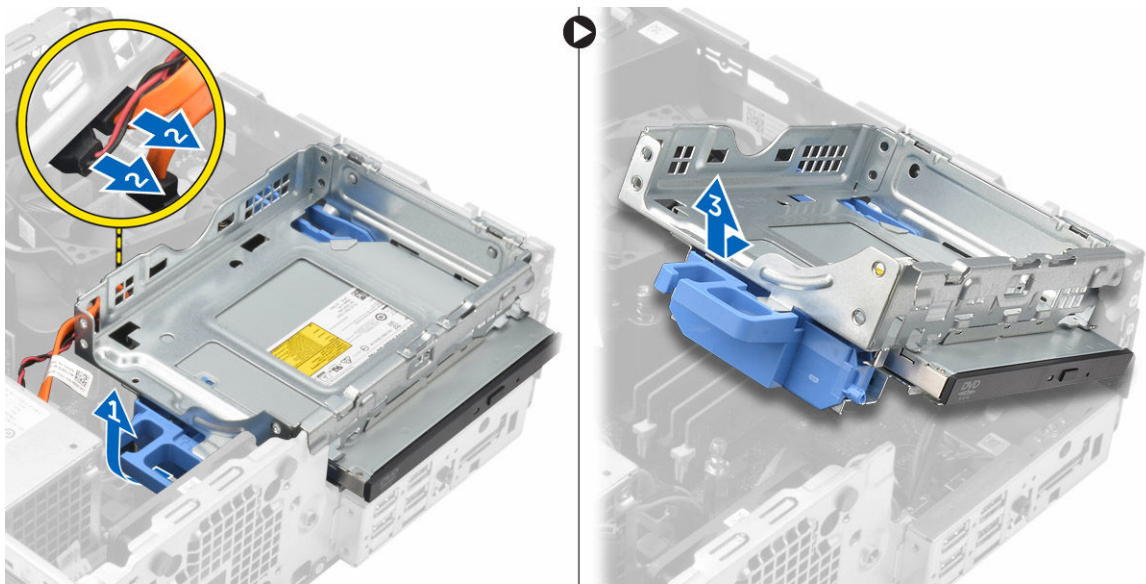

5. To remove the optical drive from the optical drive cage:
 - a. Press the optical drive release latch [1] and slide the optical drive forward. [2]
 - b. Remove the optical drive from the optical drive cage [3].



Installing the optical drive

1. Slide the optical drive into the optical drive cage.
2. Align the tabs on the optical cage with the slots on the computer.
3. Lower the optical drive cage into the computer and lock the latch.
4. Connect the data and power cables to the optical drive.
5. Install the:
 - a. [hard drive assembly](#)
 - b. [front bezel](#)
 - c. [cover](#)
6. Follow the procedure in [After Working Inside Your Computer](#).

Removing the system fan

1. Follow the procedure in [Before Working Inside Your Computer](#).
2. Remove the:
 - a. [cover](#)
 - b. [front bezel](#)
 - c. [hard drive assembly](#)
 - d. [optical drive](#)
3. To remove the system fan:
 - a. Disconnect the system fan cable from the system board [1].
 - b. Slide the fan grommets toward the slot on the back wall [2].
 - c. Lift the fan away from the computer. [3]

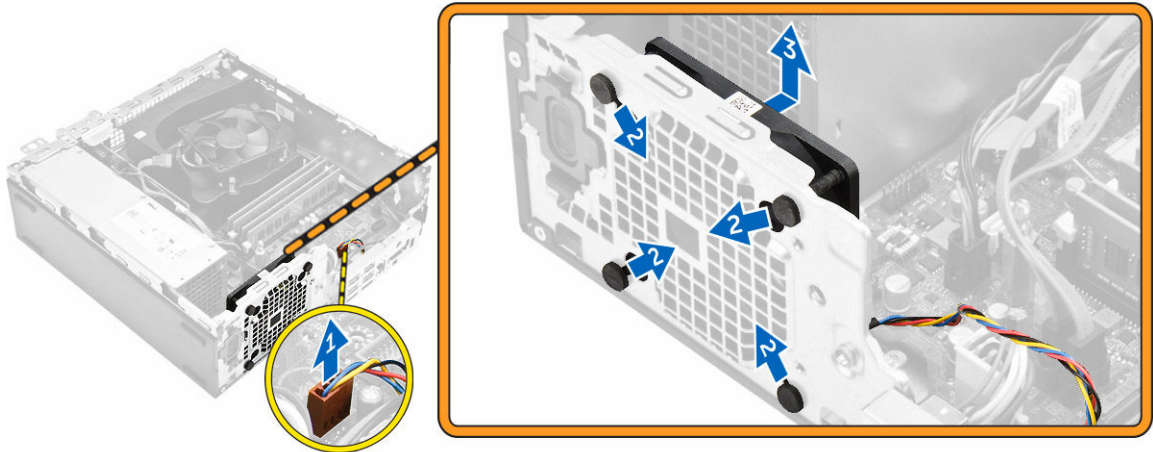

Installing the system fan

1. Place the system fan in the computer.
2. Pass the grommets through the chassis and slide outward along the groove to secure it in place.
3. Connect the system fan cable to the system board.
4. Install the:
 - a. [optical drive](#)
 - b. [hard drive assembly](#)
 - c. [front bezel](#)
 - d. [cover](#)
5. Follow the procedure in [After Working Inside Your Computer](#).

Removing the heat sink assembly

1. Follow the procedure in [Before Working Inside Your Computer](#).
2. Remove the:
 - a. [cover](#)
 - b. [front bezel](#)
 - c. [fan duct](#)
 - d. [hard drive assembly](#)
 - e. [optical drive](#)
3. To remove the heat sink assembly:
 - a. Disconnect the heat sink cable from the system board. [1]
 - b. Loosen the captive screws that secure the heat sink assembly and lift it away from the computer [2] [3].

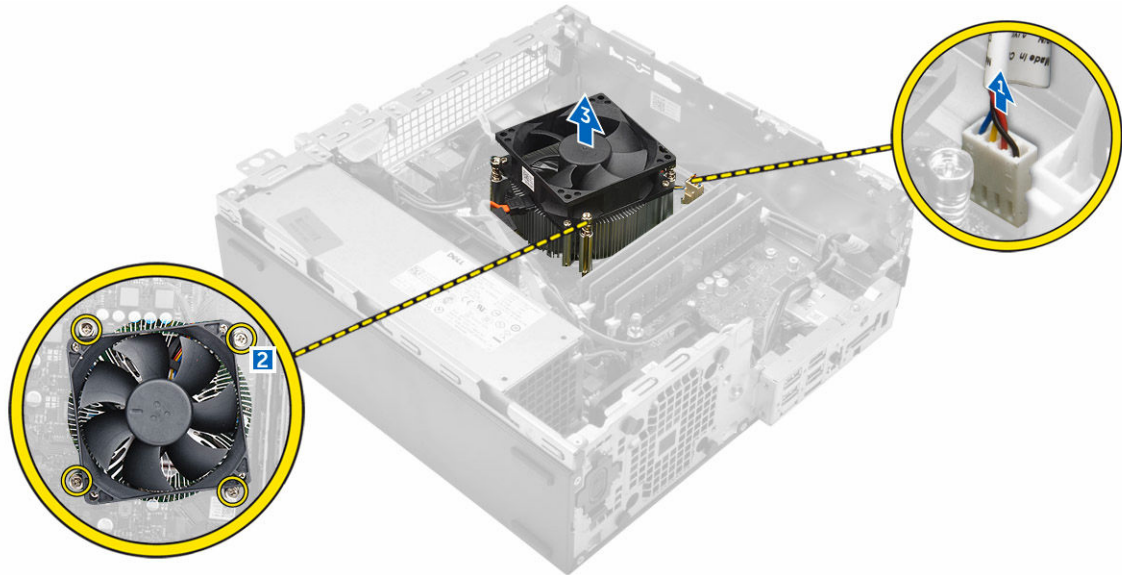

Installing the heat sink assembly

1. Place the heat sink assembly onto the processor.
2. Tighten the captive screws to secure the heat sink assembly to the system board.
3. Connect the heat sink cable to the system board.
4. Install the:
 - a. [fan duct](#)
 - b. [optical drive](#)
 - c. [hard drive assembly](#)
 - d. [front bezel](#)
 - e. [cover](#)
5. Follow the procedure in [After Working Inside Your Computer](#).

Removing the processor

1. Follow the procedure in [Before Working Inside Your Computer](#).
2. Remove the:
 - a. [cover](#)
 - b. [front bezel](#)
 - c. [hard drive assembly](#)
 - d. [optical drive](#)
 - e. [fan duct](#)
 - f. [heat sink](#)
3. To remove the processor:
 - a. Release the socket lever by pushing the lever down and out from under the tab on the processor shield [1].
 - b. Lift the lever upward and lift the processor shield [2].
 - c. Lift the processor out of the socket [3].



Installing the processor

1. Align the processor with the socket keys.
2. Align the pin-1 indicator of the processor with the triangle on the socket.
3. Place the processor on the socket such that the slots on the processor align with the socket keys.
4. Close the processor shield by sliding it under the retention screw.
5. Lower the socket lever and push it under the tab to lock it.
6. Install the:
 - a. [heat sink](#)
 - b. [fan duct](#)
 - c. [optical drive](#)
 - d. [hard drive assembly](#)
 - e. [front bezel](#)
 - f. [cover](#)
7. Follow the procedure in [After Working Inside Your Computer](#).

Removing the VGA daughter board

1. Follow the procedure in [Before Working Inside Your Computer](#).
2. Remove the:
 - a. [cover](#)
 - b. [fan duct](#)
3. To remove the VGA daughter board:
 - a. Remove the screws that secure the VGA connector to the computer [1].
 - b. Slide the VGA connector to release it from the computer [2].
 - c. Remove the screw that secures the VGA daughter board to the computer [3].
 - d. Lift the VGA daughter board using the handle to remove it from the computer [4].

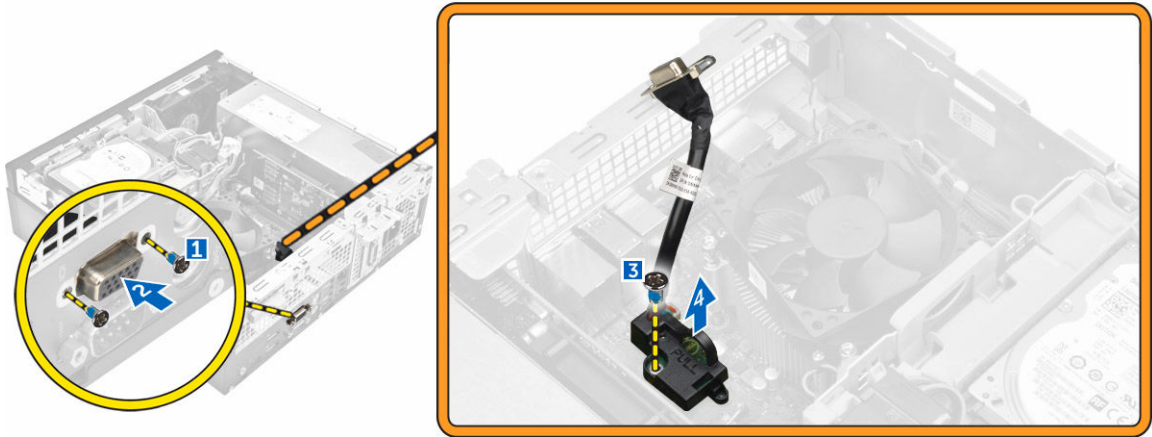

Installing the VGA daughter board

1. Align the VGA daughter board with the screw holder on the system board.
2. Tighten the screw to secure the VGA daughter board to the system board.
3. Insert the VGA connector into the slot at the back of the computer.
4. Tighten the screws to secure the VGA connector to the computer.
5. Install the:
 - a. [fan duct](#)
 - b. [cover](#)
6. Follow the procedure in [After Working Inside Your Computer](#).

Removing the power supply unit (PSU)

1. Follow the procedure in [Before Working Inside Your Computer](#).
2. Remove the:
 - a. [cover](#)
 - b. [front bezel](#)
 - c. [hard drive assembly](#)
 - d. [optical drive](#)
 - e. [fan duct](#)
3. To release the PSU:
 - a. Disconnect the power cable from the system board [1] [2].
 - b. Unroute the power cables from the retention clips on the chassis [3] [4].

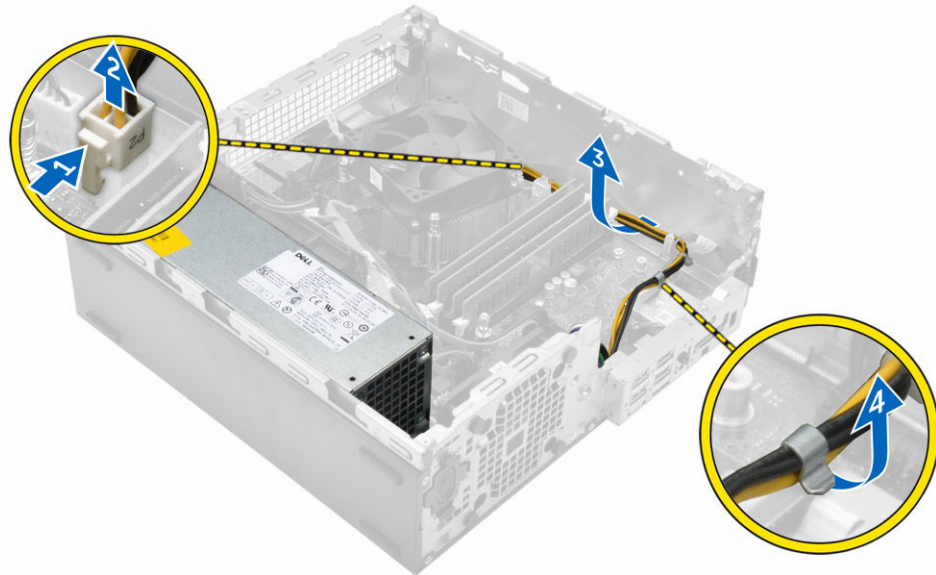

4. To remove the PSU:
 - a. Disconnect the power cable from the system board [1] [2].
 - b. Lift the cables away from the computer [3].
 - c. Remove the screws that secure the PSU to the computer [4].

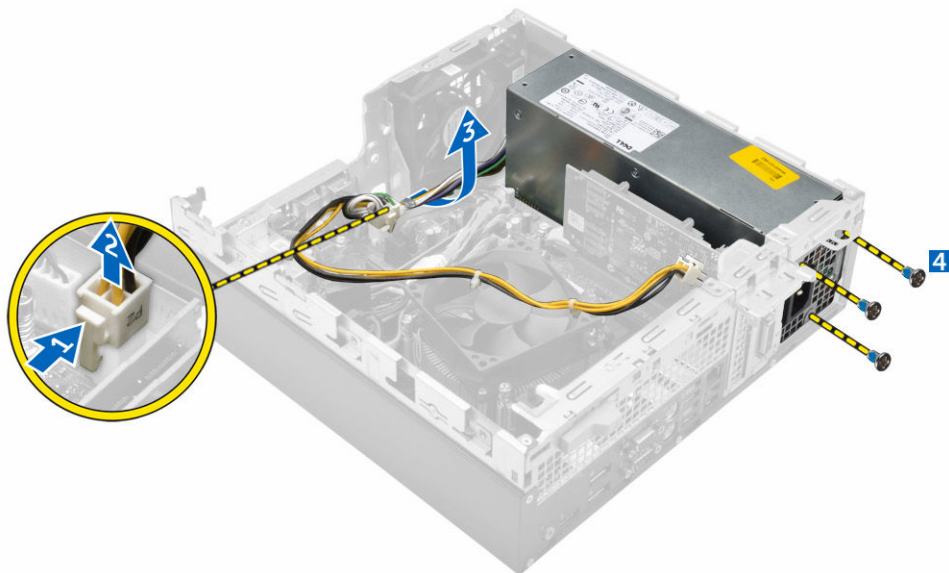

5. Press the blue release tab [1], slide the PSU and lift it away from the computer [2].

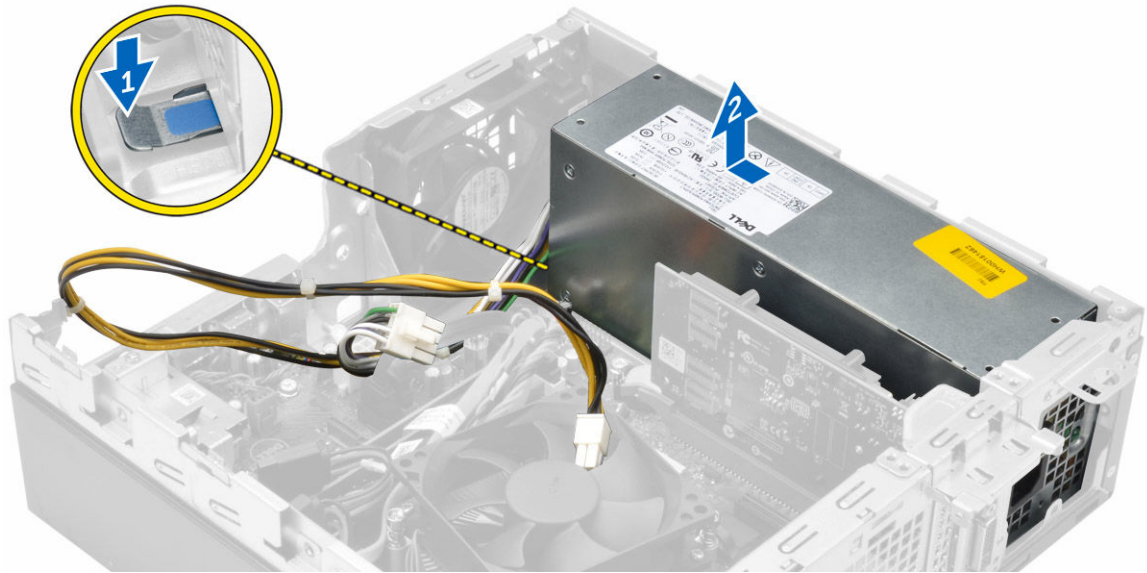

Installing the power supply unit (PSU)

1. Insert the PSU in the chassis and slide it toward the back of the computer to secure it.
2. Tighten the screws to secure the PSU to the back of the computer.
3. Route the PSU cables through the retention clips.
4. Connect the power cables to the system board.
5. Install the:
 - a. [fan duct](#)
 - b. [optical drive](#)
 - c. [hard drive assembly](#)
 - d. [front bezel](#)
 - e. [cover](#)
6. Follow the procedure in [After Working Inside Your Computer](#).

Removing the power switch

1. Follow the procedure in [Before Working Inside Your Computer](#).
2. Remove the:
 - a. [cover](#)
 - b. [front bezel](#)
 - c. [hard drive assembly](#)
 - d. [optical drive](#)
 - e. [power supply unit](#)
3. To remove the power switch:
 - a. Disconnect the power switch cable from the system board [1].
 - b. Press the power switch retention tabs and remove it from the chassis [2] [3].

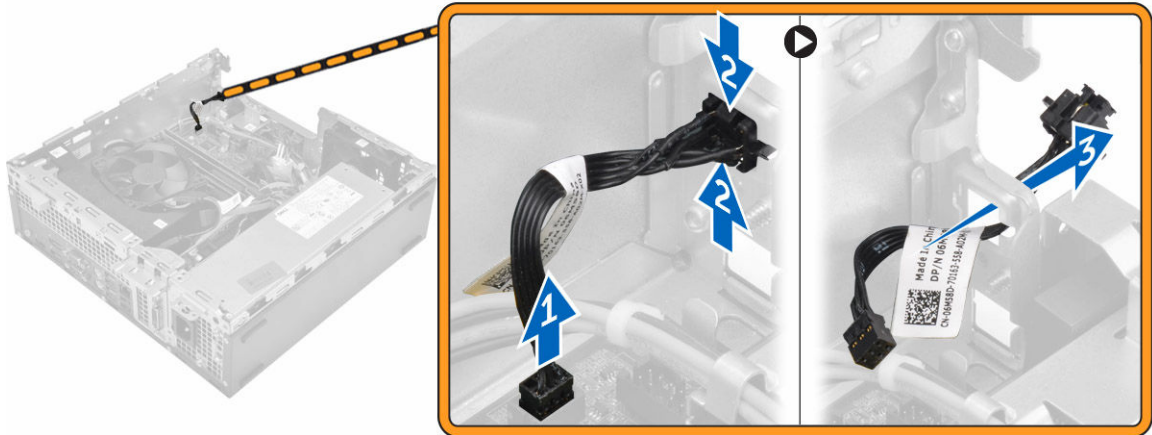

Installing the power switch

1. Slide the power switch module into the slot on the chassis until it clicks into place.
2. Connect the power switch cable to the connector on the system board.
3. Install the:
 - a. [power supply unit](#)
 - b. [optical drive](#)
 - c. [hard drive assembly](#)
 - d. [front bezel](#)
 - e. [cover](#)
4. Follow the procedure in [After Working Inside Your Computer](#).

Removing the SD card reader

1. Follow the procedure in [Before Working Inside Your Computer](#).
2. Remove the:
 - a. [cover](#)
 - b. [front bezel](#)
 - c. [hard drive assembly](#)
 - d. [optical drive](#)
 - e. [power supply unit](#)
3. To remove the SD card reader:
 - a. Remove the power supply unit cables from the retention clips on the SD card reader enclosure [1].
 - b. Remove the screws that secure the SD card reader and lift it away from the computer [2] [3].

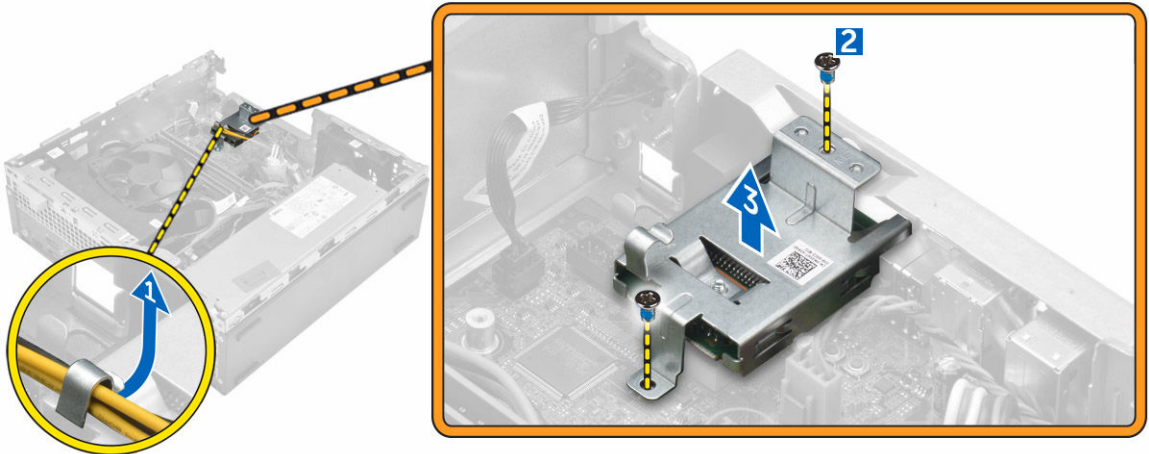

Installing the SD card reader

1. Place the SD card reader on the chassis.
2. Tighten the screws that secure the SD card reader to the computer.
3. Route the power supply unit cables into the retention clips.
4. Install the:
 - a. [power supply unit](#)
 - b. [optical drive](#)
 - c. [hard drive assembly](#)
 - d. [front bezel](#)
 - e. [cover](#)
5. Follow the procedure in [After Working Inside Your Computer](#).

Installing the optional SSD card

1. Remove the:
 - a. [cover](#)
 - b. [front bezel](#)
2. Peel the adhesive tape (blue) from the rubber.



3. Place the rubber on the computer [1] and peel the adhesive tape (pink) from the rubber [2].

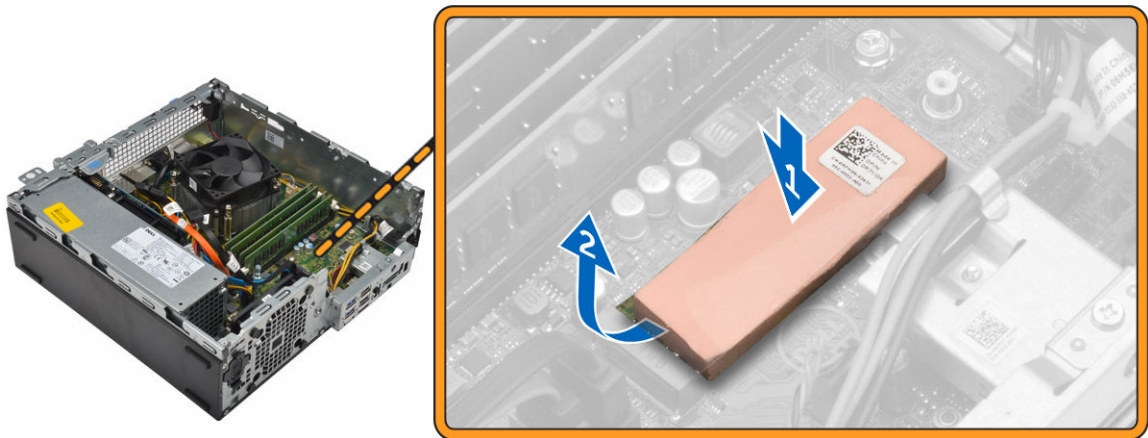

4. To install the SSD card:
 - a. Connect the SSD card to the connector on the system board [1].
 - b. Tighten the screw to secure the SSD card to the system board [2].

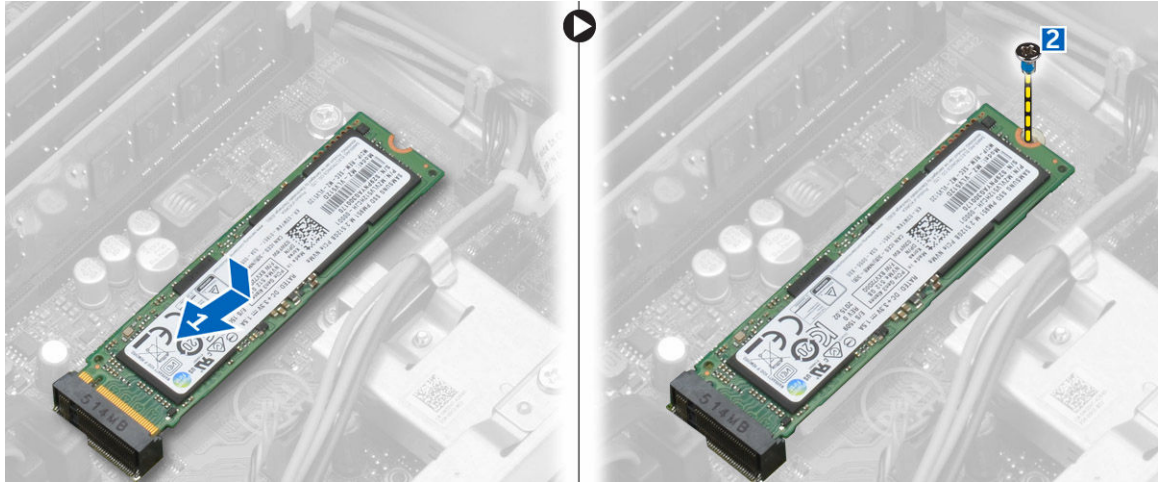

Removing the optional SSD card

1. Follow the procedure in [Before Working Inside Your Computer](#).
2. Remove the:
 - [cover](#)
 - [front bezel](#)
3. Remove the screw that secures the SSD card to the system board.
4. Disconnect the SSD card from the connector on the system board.
5. Remove the rubber from the system board.

Removing the system board

1. Follow the procedure in [Before Working Inside Your Computer](#).
2. Remove the:
 - a. [cover](#)
 - b. [fan duct](#)
 - c. [front bezel](#)
 - d. [memory module](#)
 - e. [hard drive assembly](#)
 - f. [optical drive](#)
 - g. [expansion card](#)
 - h. [optional SSD card](#)
 - i. [SD card reader](#)
 - j. [VGA daughter board](#)
 - k. [heat sink](#)
 - l. [processor](#)
3. To remove the I/O panel:
 - a. Remove the screw that secures the I/O panel to the chassis [1].
 - b. Remove the I/O panel from the computer [2].



4. Disconnect all the cables connected to the system board.

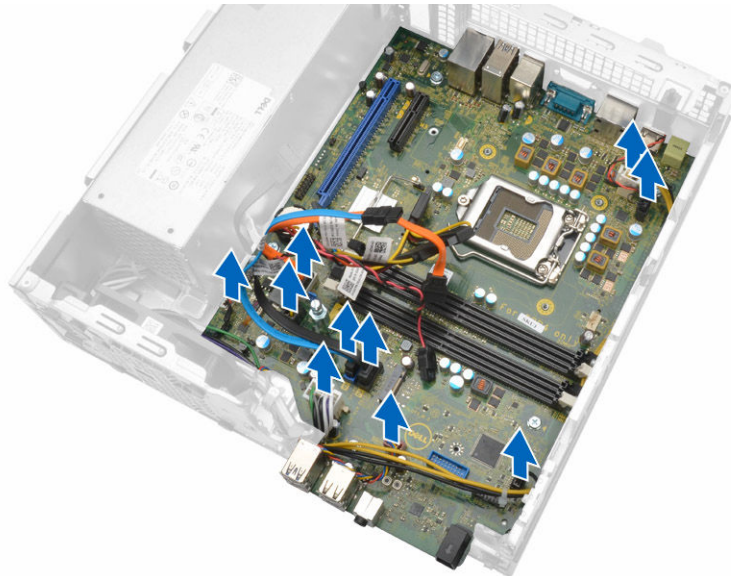

5. To remove the system board:
 - a. Remove the screws that secure the system board to the computer [1].
 - b. Slide the system board toward the front of the computer and lift it from the computer [2].

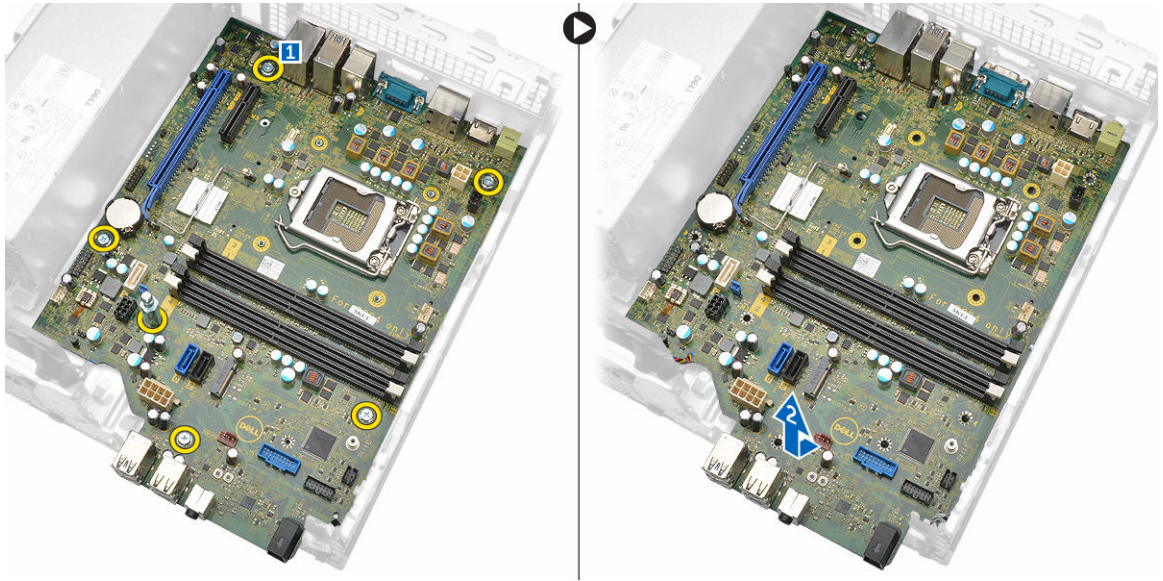

Installing the system board

1. Hold the system board by its edges and angle it toward the back of the computer.
2. Lower the system board into the computer until the connectors at the back of the system board align with the slots on the back wall of the computer, and the screw holes on the system board align with the standoffs on the computer.
3. Tighten the screws that secure the system board to the computer.
4. Connect the cables to the system board.
5. Install the:
 - a. [VGA daughter board](#)
 - b. [SD card reader](#)
 - c. [optional SSD card](#)
 - d. [expansion card](#)
 - e. [processor](#)
 - f. [heat sink](#)
 - g. [optical drive](#)
 - h. [hard drive assembly](#)
 - i. [memory module](#)
 - j. [front bezel](#)
 - k. [fan duct](#)
 - l. [cover](#)
6. Place the I/O panel on the chassis.
7. Tighten the screws to secure the I/O panel to the chassis.
8. Follow the procedure in [After Working Inside Your Computer](#).

System board layout

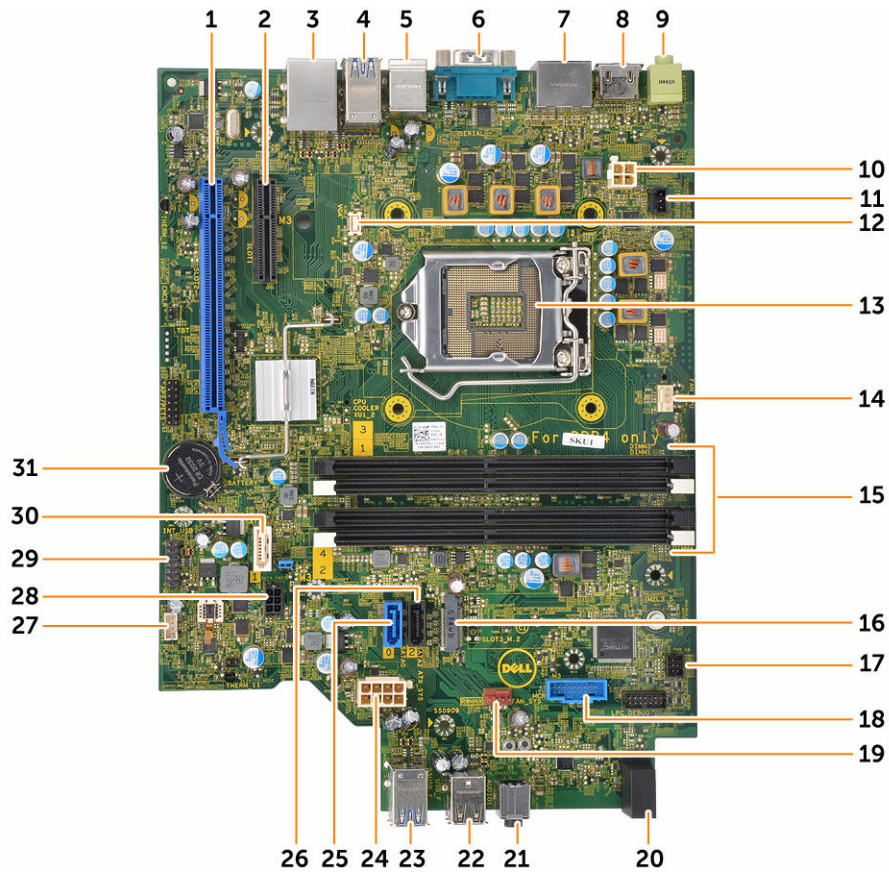

- | | |
|--------------------------------|--|
| 1. PCIe16 connector | 2. PCIe4 connector |
| 3. RJ-45/USB 2.0 connector | 4. USB 3.0 connector |
| 5. PS2 keyboard/MS connector | 6. Serial port connector |
| 7. DisplayPort connector | 8. HDMI connector |
| 9. Line-out connector | 10. CPU power connector |
| 11. Intrusion switch connector | 12. VGA daughter board connector |
| 13. Processor | 14. CPU fan connector |
| 15. Memory module connectors | 16. M.2 socket3 connector |
| 17. Power switch connector | 18. Media card reader connector |
| 19. System fan connector | 20. Hard drive activity LED |
| 21. Universal audio jack | 22. USB 2.0 connector |
| 23. USB 3.0 connector | 24. ATX power connector |
| 25. SATA0 connector | 26. SATA2 connector |
| 27. Internal speaker connector | 28. Hard drive and optical drive power cable connector |

- 29. Internal USB connector
- 31. Coin cell battery

- 30. SATA1 connector

Troubleshooting your computer

You can troubleshoot your computer using indicators like diagnostic lights, beep codes, and error messages during the operation of the computer.

Diagnostic power LED codes

Table 1. Diagnostic power LED codes

Power LED light status	Possible cause	Troubleshooting steps
Off	The computer is either turned off or is not receiving power or in Hibernation mode.	<ul style="list-style-type: none"> • Re-seat the power cable in the power connector on the back of the computer and the electrical outlet. • If the computer is plugged into a power strip, ensure that the power strip is plugged into an electrical outlet and is turned on. Also, bypass power protection devices, power strips, and power extension cables to verify that the computer turns on properly. • Ensure the electrical outlet is working by testing it with another device, such as a lamp.
Steady/blinking amber	Computer fails to complete POST or processor failure.	<ul style="list-style-type: none"> • Remove and reinstall any cards. • Remove and reinstall the graphics card, if applicable. • Ensure the power cable is connected to the system board and processor.
Slow Blinking white light	Computer is in sleep mode.	<ul style="list-style-type: none"> • Press the power button to bring the computer out of the sleep mode. • Ensure all power cables are securely

Power LED light status	Possible cause	Troubleshooting steps
		<p>connected to the system board.</p> <ul style="list-style-type: none"> Ensure the main power cable and front panel cable are connected to the system board.
Steady white	The computer is fully functional and in the On state.	<p>If the computer is not responding, do the following:</p> <ul style="list-style-type: none"> Ensure the display is connected and turned on. If the display is connected and turned on, listen for a beep code.

Diagnostic error messages

Table 2. Diagnostic error messages

Error messages	Description
AUXILIARY DEVICE FAILURE	The touchpad or external mouse may be faulty. For an external mouse, check the cable connection. Enable the Pointing Device option in the System Setup program.
BAD COMMAND OR FILE NAME	Ensure that you have spelled the command correctly, put spaces in the proper place, and used the correct path name.
CACHE DISABLED DUE TO FAILURE	The primary cache internal to the microprocessor has failed. Contact Dell .
CD DRIVE CONTROLLER FAILURE	The optical drive does not respond to commands from the computer.
DATA ERROR	The hard drive cannot read the data.
DECREASING AVAILABLE MEMORY	One or more memory modules may be faulty or improperly seated. Reinstall the memory modules or, if necessary, replace them.
DISK C: FAILED INITIALIZATION	The hard drive failed initialization. Run the hard drive tests in Dell Diagnostics .
DRIVE NOT READY	The operation requires a hard drive in the bay before it can continue. Install a hard drive in the hard drive bay.
ERROR READING PCMCIA CARD	The computer cannot identify the ExpressCard. Reinsert the card or try another card.

Error messages	Description
EXTENDED MEMORY SIZE HAS CHANGED	The amount of memory recorded in non-volatile memory (NVRAM) does not match the memory module installed in the computer. Restart the computer. If the error appears again, Contact Dell
THE FILE BEING COPIED IS TOO LARGE FOR THE DESTINATION DRIVE	The file that you are trying to copy is too large to fit on the disk, or the disk is full. Try copying the file to a different disk or use a larger capacity disk.
A FILENAME CANNOT CONTAIN ANY OF THE FOLLOWING CHARACTERS: \ / : * ? " < > -	Do not use these characters in filenames.
GATE A20 FAILURE	A memory module may be loose. Reinstall the memory module or, if necessary, replace it.
GENERAL FAILURE	The operating system is unable to carry out the command. The message is usually followed by specific information. For example, <i>Printer out of paper</i> . Take the appropriate action.
HARD-DISK DRIVE CONFIGURATION ERROR	The computer cannot identify the drive type. Shut down the computer, remove the hard drive, and boot the computer from an optical drive. Then, shut down the computer, reinstall the hard drive, and restart the computer. Run the Hard Disk Drive tests in Dell Diagnostics .
HARD-DISK DRIVE CONTROLLER FAILURE 0	The hard drive does not respond to commands from the computer. Shut down the computer, remove the hard drive, and boot the computer from an optical drive. Then, shut down the computer, reinstall the hard drive, and restart the computer. If the problem persists, try another drive. Run the Hard Disk Drive tests in Dell Diagnostics .
HARD-DISK DRIVE FAILURE	The hard drive does not respond to commands from the computer. Shut down the computer, remove the hard drive, and boot the computer from an optical drive. Then, shut down the computer, reinstall the hard drive, and restart the computer. If the problem persists, try another drive. Run the Hard Disk Drive tests in Dell Diagnostics .
HARD-DISK DRIVE READ FAILURE	The hard drive may be defective. Shut down the computer, remove the hard drive, and boot the computer from an optical. Then, shut down the computer, reinstall the hard drive, and restart the computer. If the problem persists, try another drive. Run the Hard Disk Drive tests in Dell Diagnostics .

Error messages	Description
INSERT BOOTABLE MEDIA	The operating system is trying to boot to non-bootable media, such as an optical drive. Insert bootable media.
INVALID CONFIGURATION INFORMATION- PLEASE RUN SYSTEM SETUP PROGRAM	The system configuration information does not match the hardware configuration. The message is most likely to occur after a memory module is installed. Correct the appropriate options in the system setup program.
KEYBOARD CLOCK LINE FAILURE	For external keyboards, check the cable connection. Run the Keyboard Controller test in Dell Diagnostics .
KEYBOARD CONTROLLER FAILURE	For external keyboards, check the cable connection. Restart the computer, and avoid touching the keyboard or the mouse during the boot routine. Run the Keyboard Controller test in Dell Diagnostics .
KEYBOARD DATA LINE FAILURE	For external keyboards, check the cable connection. Run the Keyboard Controller test in Dell Diagnostics .
KEYBOARD STUCK KEY FAILURE	For external keyboards or keypads, check the cable connection. Restart the computer, and avoid touching the keyboard or keys during the boot routine. Run the Stuck Key test in Dell Diagnostics .
LICENSED CONTENT IS NOT ACCESSIBLE IN MEDIADIRECT	Dell MediaDirect cannot verify the Digital Rights Management (DRM) restrictions on the file, so the file cannot be played.
MEMORY ADDRESS LINE FAILURE AT ADDRESS, READ VALUE EXPECTING VALUE	A memory module may be faulty or improperly seated. Reinstall the memory module or, if necessary, replace it.
MEMORY ALLOCATION ERROR	The software you are attempting to run is conflicting with the operating system, another program, or a utility. Shut down the computer, wait for 30 seconds, and then restart it. Run the program again. If the error message still appears, see the software documentation.
MEMORY DOUBLE WORD LOGIC FAILURE AT ADDRESS, READ VALUE EXPECTING VALUE	A memory module may be faulty or improperly seated. Reinstall the memory module or, if necessary, replace it.
MEMORY ODD/EVEN LOGIC FAILURE AT ADDRESS, READ VALUE EXPECTING VALUE	A memory module may be faulty or improperly seated. Reinstall the memory module or, if necessary, replace it.

Error messages	Description
MEMORY WRITE/READ FAILURE AT ADDRESS, READ VALUE EXPECTING VALUE	A memory module may be faulty or improperly seated. Reinstall the memory module or, if necessary, replace it.
NO BOOT DEVICE AVAILABLE	The computer cannot find the hard drive. If the hard drive is your boot device, ensure that the drive is installed, properly seated, and partitioned as a boot device.
NO BOOT SECTOR ON HARD DRIVE	The operating system may be corrupted, Contact Dell .
NO TIMER TICK INTERRUPT	A chip on the system board may be malfunctioning. Run the System Set tests in Dell Diagnostics .
NOT ENOUGH MEMORY OR RESOURCES. EXIT SOME PROGRAMS AND TRY AGAIN	You have too many programs open. Close all windows and open the program that you want to use.
OPERATING SYSTEM NOT FOUND	Reinstall the operating system. If the problem persists, Contact Dell .
OPTIONAL ROM BAD CHECKSUM SECTOR NOT FOUND	The optional ROM has failed. Contact Dell . The operating system cannot locate a sector on the hard drive. You may have a defective sector or corrupted File Allocation Table (FAT) on the hard drive. Run the Windows error-checking utility to check the file structure on the hard drive. See Windows Help and Support for instructions (click Start → Help and Support). If a large number of sectors are defective, back up the data (if possible), and then format the hard drive.
SEEK ERROR	The operating system cannot find a specific track on the hard drive.
SHUTDOWN FAILURE	A chip on the system board may be malfunctioning. Run the System Set tests in Dell Diagnostics . If the message reappears, Contact Dell .
TIME-OF-DAY CLOCK LOST POWER	System configuration settings are corrupted. Connect your computer to an electrical outlet to charge the battery. If the problem persists, try to restore the data by entering the System Setup program, then immediately exit the program. If the message reappears, Contact Dell .
TIME-OF-DAY CLOCK STOPPED	The reserve battery that supports the system configuration settings may require recharging. Connect your computer to an electrical outlet to

Error messages	Description
TIME-OF-DAY NOT SET-PLEASE RUN THE SYSTEM SETUP PROGRAM	charge the battery. If the problem persists, Contact Dell . The time or date stored in the system setup program does not match the system clock. Correct the settings for the Date and Time options.
TIMER CHIP COUNTER 2 FAILED	A chip on the system board may be malfunctioning. Run the System Set tests in Dell Diagnostics .
UNEXPECTED INTERRUPT IN PROTECTED MODE	The keyboard controller may be malfunctioning, or a memory module may be loose. Run the System Memory tests and the Keyboard Controller test in Dell Diagnostics or Contact Dell .
X:\ IS NOT ACCESSIBLE. THE DEVICE IS NOT READY	Insert a disk into the drive and try again.

System error messages

Table 3. System error messages

System message	Description
Alert! Previous attempts at booting this system have failed at checkpoint [nnnn]. For help in resolving this problem, please note this checkpoint and contact Dell Technical Support	The computer failed to complete the boot routine three consecutive times for the same error.
CMOS checksum error	RTC is reset, BIOS Setup default has been loaded.
CPU fan failure	CPU fan has failed.
System fan failure	System fan has failed.
Hard-disk drive failure	Possible hard disk drive failure during POST.
Keyboard failure	Keyboard failure or loose cable. If reseating the cable does not solve the problem, replace the keyboard.
No boot device available	No bootable partition on hard disk drive, the hard disk drive cable is loose, or no bootable device exists. <ul style="list-style-type: none"> If the hard drive is your boot device, ensure that the cables are connected and that the drive is installed properly and partitioned as a boot device. Enter system setup and ensure that the boot sequence information is correct.
No timer tick interrupt	A chip on the system board might be malfunctioning or motherboard failure.

System message	Description
NOTICE - Hard Drive SELF MONITORING SYSTEM has reported that a parameter has exceeded its normal operating range. Dell recommends that you back up your data regularly. A parameter out of range may or may not indicate a potential hard drive problem	S.M.A.R.T error, possible hard disk drive failure.

System Setup

System Setup enables you to manage your computer hardware and specify BIOS level options. From the System Setup, you can:

- Change the NVRAM settings after you add or remove hardware
- View the system hardware configuration
- Enable or disable integrated devices
- Set performance and power management thresholds
- Manage your computer security

Boot Sequence

Boot Sequence allows you to bypass the System Setup-defined boot device order and boot directly to a specific device (for example: optical drive or hard drive). During the Power-on Self Test (POST), when the Dell logo appears, you can:

- Access System Setup by pressing F2 key
- Bring up the one-time boot menu by pressing F12 key

The one-time boot menu displays the devices that you can boot from including the diagnostic option. The boot menu options are:

- Removable Drive (if available)
- STXXXX Drive

 **NOTE:** XXX denotes the SATA drive number.

- Optical Drive
- Diagnostics

 **NOTE:** Choosing **Diagnostics**, will display the **ePSA diagnostics** screen.

The boot sequence screen also displays the option to access the System Setup screen.

Navigation keys

The following table displays the system setup navigation keys.



 **NOTE:** For most of the System Setup options, changes that you make are recorded but do not take effect until you restart the system.

Table 4. Navigation keys

Keys	Navigation
Up arrow	Moves to the previous field.
Down arrow	Moves to the next field.
Enter	Allows you to select a value in the selected field (if applicable) or follow the link in the field.
Spacebar	Expands or collapses a drop-down list, if applicable.
Tab	Moves to the next focus area.
	 NOTE: For the standard graphics browser only.
Esc	Moves to the previous page till you view the main screen. Pressing Esc in the main screen displays a message that prompts you to save any unsaved changes and restarts the system.
F1	Displays the System Setup help file.

System Setup overview

System Setup allows you to:

- Change the system configuration information after you add, change, or remove any hardware in your computer.
- Set or change a user-selectable option such as the user password.
- Read the current amount of memory or set the type of hard drive installed.

Before you use System Setup, it is recommended that you write down the System Setup screen information for future reference.

 **CAUTION:** Unless you are an expert computer user, do not change the settings for this program. Certain changes can cause your computer to work incorrectly.

Accessing System Setup

1. Turn on (or restart) your computer.
2. After the white Dell logo appears, press F2 immediately.

The System Setup page is displayed.

 **NOTE:** If you wait too long and the operating system logo appears, wait until you see the desktop. Then, shut down or restart your computer and try again.

 **NOTE:** After the Dell logo appears, you can also press F12 and then select **BIOS setup**.

System Setup options



 **NOTE:** Depending on the computer and its installed devices, the items listed in this section may or may not appear.

Table 5. General

Option	Description
System Information	<p>Displays the following information:</p> <ul style="list-style-type: none"> • System Information: Displays BIOS Version, Service Tag, Asset Tag, Ownership Date, Manufacture Date, and the Express Service Code. • Memory Information: Displays Memory Installed, Memory Available, Memory Speed, Memory Channels Mode, Memory Technology, DIMM 1 Size,, DIMM 2 Size, DIMM 3 Size, and DIMM 4 Size. • PCI Information: Displays SLOT1, SLOT2, SLOT3, SLOT4, and SLOT5_M. 2 • Processor Information: Displays Processor Type, Core Count, Processor ID, Current Clock Speed, Minimum Clock Speed, Maximum Clock Speed, Processor L2 Cache, Processor L3 Cache, HT Capable, and 64-Bit Technology. • Device Information: Displays SATA-0, LOM MAC Address, Video Controller, Audio Controller, Wi-Fi Device, and Bluetooth Device.
Boot Sequence	<p>Allows you to specify the order in which the computer attempts to find an operating system from the devices specified in this list.</p> <ul style="list-style-type: none"> • Legacy • UEFI
Advanced Boot Options	<p>Allows you to select the Enable Legacy Option ROMs option, when in UEFI boot mode. By default, this option is enabled.</p>
Date/Time	<p>Allows you to set the date and time settings. Changes to the system date and time take effect immediately.</p>

Table 6. System configuration

Option	Description
Integrated NIC	<p>Allows you to control the on-board LAN controller. The options are:</p> <ul style="list-style-type: none"> • Disabled • Enabled (default) • Enabled w/PXE • Enabled w/Cloud Desktop <p> NOTE: Depending on the computer and its installed devices, the items listed in this section may or may not appear.</p>
WIDI	<p>Allows you to connect to display through WiFi. WIDI requires Intel WiFi card, Intel graphics, and WIDI receiver in display (or WIDI compliant display). To install the WIDI application, see the Dell.com/support site to download the WIDI application.</p> <p> NOTE: When installing the WIDI application, connect the display to Intel onboard graphic output.</p>
Serial Port	<p>Allows you to determine how the built-in serial port to operate. The options are:</p> <ul style="list-style-type: none"> • Disabled • COM 1 – Default setting • COM 2 • COM 3

Option	Description
	<ul style="list-style-type: none"> • COM 4
SATA Operation	<p>Allows you to configure the operating mode of the integrated hard drive controller.</p> <ul style="list-style-type: none"> • Disabled = The SATA controllers are hidden • ATA = SATA is configured for ATA mode • RAID ON = SATA is configured to support RAID mode
Drives	<p>Allows you to enable or disable the various drives on-board:</p> <ul style="list-style-type: none"> • SATA-0 • SATA-1 • SATA-2
Smart Reporting	<p>This field controls whether hard drive errors for integrated drives are reported during system startup. This option is disabled by default.</p>
USB Configuration	<p>Allows you to enable or disable the integrated USB controller for:</p> <ul style="list-style-type: none"> • Enable Boot Support • Enable Front USB Ports • Enable Rear USB Ports <p>All the options are enabled by default.</p>
Front USB Configuration	<p>Allows you to enable or disable the front USB ports. All the ports are enabled by default.</p>
Back USB Configuration	<p>Allows you to enable or disable the back USB ports. All the ports are enabled by default.</p>
USB PowerShare	<p>This option allows you to charge the external devices, such as mobile phones, music player. This option is disabled by default.</p>
Audio	<p>Allows you to enable or disable the integrated audio controller.</p> <ul style="list-style-type: none"> • Enable Microphone • Enable Internal Speaker <p>Both the options are enabled by default.</p>
Miscellaneous Devices	<p>Allows you to enable or disable the various on-board devices.</p> <ul style="list-style-type: none"> • Enable PCI Slot • Enable Media Card (default option) • Disable Media Card

Table 7. Video

Option	Description
Primary Display	<p>Allows you to select the primary display when multiple controllers are available in the system.</p> <ul style="list-style-type: none"> • Auto • Intel HD Graphics



Option	Description
	 NOTE: If you do not select Auto, the on-board graphics device will be present and enabled.

Table 8. Security

Option	Description
Admin Password	Allows you to set, change, and delete the admin password.
System Password	Allows you to set, change, and delete the system password.
Internal HDD-0 Password	Allows you to set, change, and delete the computer's internal HDD.
Internal HDD-0 Password	Allows you to set, change, and delete the computer's internal HDD.
Strong Password	This option lets you enable or disable strong passwords for the system.
Password Configuration	Allows you to control the minimum and maximum number of characters allowed for a administrative password and the system password.
Password Bypass	<p>This option lets you bypass the System (Boot) Password and the internal HDD password prompts during a system restart.</p> <ul style="list-style-type: none"> • Disabled — Always prompt for the system and internal HDD password when they are set. This option is disabled by default. • Reboot Bypass — Bypass the password prompts on Restarts (warm boots). <p> NOTE: The system will always prompt for the system and internal HDD passwords when powered on from the off state (a cold boot). Also, the system will always prompt for passwords on any module bay HDDs that may be present.</p>
Password Change	<p>This option lets you determine whether changes to the System and Hard Disk passwords are permitted when an administrator password is set.</p> <p>Allow Non-Admin Password Changes - This option is enabled by default.</p>
TPM 1.2 Security	<p>Allows you to control whether the Trusted Platform Module (TPM) is visible to the operating system.</p> <ul style="list-style-type: none"> • TPM On (default) • Clear • PPI Bypass for Enable Commands • PPI Bypass for Disable Commands • Disabled • Enabled (default)
Computrace	<p>This field lets you Activate or Disable the BIOS module interface of the optional Computrace Service from Absolute Software. Enables or disables the optional Computrace service designed for asset management.</p> <ul style="list-style-type: none"> • Deactivate - This option is disabled by default. • Disable • Activate
Chassis Intrusion	<p>Allows you to control the chassis intrusion feature. You can set this option to:</p> <ul style="list-style-type: none"> • Enable

Option	Description
	<ul style="list-style-type: none"> • Disable • On-Silent – Enabled by default if chassis intrusion is detected.
CPU XD Support	Allows you to enable or disable the Execute Disable mode of the processor. This option is enabled by default.
OROM Keyboard Access	<p>This option determines whether users are able to enter Option ROM Configuration screens via hotkeys during boot. Specifically, these settings are capable of preventing access to Intel RAID (CTRL+I) or Intel Management Engine BIOS Extension (CTRL+P/F12)</p> <ul style="list-style-type: none"> • Enable – User may enter OROM configuration screens via the hotkey. • One-Time Enable – User may enter OROM configuration screens via the hotkeys on next boot only. After next boot, the setting will revert to disabled. • Disable – User may not enter OROM configuration screens via the hotkey. <p>This option is set to Enable by default.</p>
Admin Setup Lockout	Allows you to enable or disable the option to enter Setup when an Administrative password is set. This option is not set by default.
HDD Protection Support	Allows you to enable or disable the HDD Protection feature. This option is an advanced feature, which is intended to keep the HDD data secure and unchangeable. By default, this option is disabled.

Table 9. Secure boot

Option	Description
Secure Boot Enable	<p>Allows you to enable or disable Secure Boot feature</p> <ul style="list-style-type: none"> • Disable • Enable
Expert key Management	<p>Allows you to manipulate the security key databases only if the system is in Custom Mode. The Enable Custom Mode option is disabled by default. The options are:</p> <ul style="list-style-type: none"> • PK • KEK • db • dbx <p>If you enable the Custom Mode, the relevant options for PK, KEK, db, and dbx appear. The options are:</p> <ul style="list-style-type: none"> • Save to File- Saves the key to a user-selected file • Replace from File- Replaces the current key with a key from a user-selected file • Append from File- Adds a key to the current database from a user-selected file • Delete- Deletes the selected key • Reset All Keys- Resets to default setting • Delete All Keys- Deletes all the keys

Option	Description
	 NOTE: If you disable the Custom Mode, all the changes made will be erased and the keys will restore to default settings.

Table 10. Intel software guard extensions

Option	Description
Intel SGX Enable	Allows you to enable or disable the Intel Software Guard Extensions to provide a secured environment for running code/storing sensitive information in the context of the main operating system. <ul style="list-style-type: none"> • Disabled (default) • Enabled
Enclave Memory Size	Allows you to set the Intel SGX Enclave Reserve Memory Size. <ul style="list-style-type: none"> • 32 MB • 64 MB • 128 MB

Table 11. Performance

Option	Description
Multi Core Support	This field specifies whether the process will have one or all cores enabled. This option is enabled by default.
Intel SpeedStep	Allows you to enable or disable the Intel SpeedStep mode of the processor. This option is disabled by default.
C States Control	Allows you to enable or disable additional processor sleep states. This option is disabled by default.
Limited CPUID Value	Allows you to limit the maximum value of the processor standard CPUID function. This options is disable by default.
Intel TurboBoost	Allows you to enable or disable the Intel TurboBoost mode of the processor. This option is enabled by default.
HyperThread control	Allows you to enable or disable HyperThreading in the processor.

Table 12. Power management

Option	Description
AC Recovery	Determines how the system responds when AC power is re-applied after a power loss. You can set the AC Recovery to: <ul style="list-style-type: none"> • Power Off • Power On • Last Power State This option is Power Off by default.
Auto On Time	Sets time to automatically turn on the computer. Time is kept in standard 12-hour format (hour:minutes:seconds). Change the startup time by typing the values in the time and AM/PM fields.

Option	Description
	 NOTE: This feature does not work if you turn off your computer using the switch on a power strip or surge protector or if Auto Power is set to disabled .
Deep Sleep Control	<p>Allows you to define the controls when Deep Sleep is enabled.</p> <ul style="list-style-type: none"> • Disabled • Enabled in S5 only • Enabled in S4 and S5 <p>This option is Disabled by default.</p>
Fan Control Override	<p>Allows you to determine the speed of the system fan. When this option is enabled, the system fan runs at the maximum speed. This option is disabled by default.</p>
USB Wake Support	<p>Allows you to enable the USB devices to wake the computer from standby mode.</p>
Wake on LAN/WWAN	<p>This option allows the computer to power up from the off state when triggered by a special LAN signal. This feature only works when the computer is connected to AC power supply.</p> <ul style="list-style-type: none"> • Disabled - Does not allow the system to power on by special LAN signals when it receives a wake-up signal from the LAN or wireless LAN. • LAN or WLAN - Allows the system to be powered on by special LAN or wireless LAN signals. • LAN Only - Allows the system to be powered on by special LAN signals. • LAN with PXE Boot - A wakeup packet sent to the system in either the S4 or S5 state, that will cause the system to wake-up and immediately boot to PXE. • WLAN Only - Allows the system to be powered on by special WLAN signals. <p>This option is Disabled by default.</p>
Block Sleep	<p>Allows you to block entering to sleep (S3 state) in OS environment. This option is disabled by default.</p>
Intel Ready Mode	<p>Allows you to enable the capability of Intel Ready Mode Technology. This option is disabled by default.</p>

Table 13. POST behavior

Option	Description
Numlock LED	<p>Allows you to enable or disable the Numlock feature when your computer starts. This option is enabled by default.</p>
MEBx Hotkey	<p>Allows you to specify whether the MEBx Hotkey function should be enabled when the system boots. This option is enabled by default.</p>
Keyboard Errors	<p>Allows you to enable or disable the keyboard error reporting when the computer starts. This option is enabled by default.</p>
Fast Boot	<p>This option can speed up the boot process by bypassing some compatibility steps:</p> <ul style="list-style-type: none"> • Minimal — The system boots quickly, unless the BIOS has been updated, memory changed, or the previous POST did not complete. • Thorough — The system does not skip any steps in the boot process.

Option	Description
	<ul style="list-style-type: none"> Auto – This allows the operating system to control this setting (this works only when the operating system supports Simple Boot Flag). <p>This option is set to Thorough by default.</p>

Table 14. Virtualization support

Option	Description
Virtualization	This option specifies whether a Virtual Machine Monitor (VMM) can utilize the additional hardware capabilities provided by Intel® Virtualization Technology. Enable Intel Virtualization Technology - This option is disabled by default.
VT for Direct I/O	Enables or disables the Virtual Machine Monitor (VMM) from utilizing the additional hardware capabilities provided by Intel® Virtualization technology for direct I/O. Enable Intel Virtualization Technology for Direct I/O - This option is disabled by default.
Trusted Execution	This option specifies whether a Measured Virtual Machine Monitor (MVMM) can utilize the additional hardware capabilities provided by the Intel Trusted Execution Technology. This option is disabled by default.

Table 15. Maintenance

Option	Description
Service Tag	Displays the Service Tag of your computer.
Asset Tag	Allows you to create a system asset tag if an asset tag is not already set. This option is not set by default.
SERR Messages	Controls the SERR message mechanism. This option is not set by default. Some graphics cards require that the SERR message mechanism be disabled.
Dell Development Configuration	Allows you to turn on/off certain features to control the BIOS. This option is disabled by default.
BIOS Downgrade	Allows you to control flashing of the system firmware to the previous versions. This option is enabled by default.
	 NOTE: If this option is not selected, the flashing of the system firmware to the previous versions is blocked.
Data Wipe	Allows you to securely erase the data from all the available internal storages, such as HDD, SSD, mSATA, and eMMC. This option is disabled by default.
BIOS recovery	Allows you to recover the corrupted BIOS conditions from the recovery files on the primary hard drive or an external USB key.

Table 16. Cloud desktop

Option	Description
Server Lookup Method	Allows you to specify how the cloud desktop software will lookup server addresses. <ul style="list-style-type: none"> Static

Option	Description
	<ul style="list-style-type: none"> DNS (Default)
Server Name	Allows you to specify the name of the server
Server IP Address	Specifies the primary static IP address of the cloud desktop server. The default IP address is 255.255.255.255
Server port	Specifies the primary port of the cloud desktop. The default setting is 06910.
Client Address Method	Specifies how the client will obtain the IP address. <ul style="list-style-type: none"> Static IP DHCP (Default)
Client IP address	Specifies the static IP address of the client. The default IP address is 255.255.255.255
Client Subnet Mask	Specifies the subnet mask address of the client. The default IP address is 255.255.255.255
Client Gateway	Specifies the gateway address of the client. The default IP address is 255.255.255.255
DNS IP Address	Specifies the DNS IP address of the client. The default IP address is 255.255.255.255
Domain Name	Specifies the domain name of the client.
Advanced	Allows you to turn on the Verbose mode for advanced debugging. This option is disabled by default.

Table 17. System logs

Option	Description
BIOS Events	Displays the system event log and allows you to: <ul style="list-style-type: none"> Clear Log Mark all Entries



Table 18. Advanced configurations

Option	Description
ASPM	Allows you to activate the state power management. <ul style="list-style-type: none"> Auto (Default) Disabled L1 Only

Updating the BIOS

It is recommended to update your BIOS (System Setup), on replacing the system board or if an update is available. For laptops, ensure that your computer battery is fully charged and connected to a power outlet

1. Restart the computer.
2. Go to [Dell.com/support](https://www.dell.com/support).

3. Enter the **Service Tag** or **Express Service Code** and click **Submit**.
 -  **NOTE:** To locate the Service Tag, click **Where is my Service Tag?**
 -  **NOTE:** If you cannot find your Service Tag, click **Detect My Product**. Proceed with the instructions on screen.
 4. If you are unable to locate or find the Service Tag, click the Product Category of your computer.
 5. Choose the **Product Type** from the list.
 6. Select your computer model and the **Product Support** page of your computer appears.
 7. Click **Get drivers** and click **View All Drivers**.
The Drivers and Downloads page opens.
 8. On the Drivers and Downloads screen, under the **Operating System** drop-down list, select **BIOS**.
 9. Identify the latest BIOS file and click **Download File**.
You can also analyze which drivers need an update. To do this for your product, click **Analyze System for Updates** and follow the instructions on the screen.
 10. Select your preferred download method in the **Please select your download method below** window, click **Download File**.
The **File Download** window appears.
 11. Click **Save** to save the file on your computer.
 12. Click **Run** to install the updated BIOS settings on your computer.
Follow the instructions on the screen.
-  **NOTE:** It is recommended not to update the BIOS version for more than 3 revisions. For example: If you want to update the BIOS from 1.0 to 7.0, then install version 4.0 first and then install version 7.0.

System and setup password

You can create a system password and a setup password to secure your computer.

Password type	Description
System password	Password that you must enter to log on to your system.
Setup password	Password that you must enter to access and make changes to the BIOS settings of your computer.

 **CAUTION:** The password features provide a basic level of security for the data on your computer.

 **CAUTION:** Anyone can access the data stored on your computer if it is not locked and left unattended.

 **NOTE:** Your computer is shipped with the system and setup password feature disabled.

Assigning a system password and setup password

You can assign a new **System Password** and/or **Setup Password** or change an existing **System Password** and/or **Setup Password** only when **Password Status** is **Unlocked**. If the Password Status is **Locked**, you cannot change the System Password.

 **NOTE:** If the password jumper is disabled, the existing System Password and Setup Password are deleted and you need not provide the system password to log on to the computer.

To enter the system setup, press F2 immediately after a power-on or re-boot.

1. In the **System BIOS** or **System Setup** screen, select **System Security** and press Enter.
The **System Security** screen appears.
2. In the **System Security** screen, verify that **Password Status** is **Unlocked**.
3. Select **System Password**, enter your system password, and press Enter or Tab.
Use the following guidelines to assign the system password:
 - A password can have up to 32 characters.
 - The password can contain the numbers 0 through 9.
 - Only lower case letters are valid, upper case letters are not allowed.
 - Only the following special characters are allowed: space, ("), (+), (.), (-), (.), (/), (:), ((), (\), ()), (').Re-enter the system password when prompted.
4. Type the system password that you entered earlier and click **OK**.
5. Select **Setup Password**, type your system password and press Enter or Tab.
A message prompts you to re-type the setup password.
6. Type the setup password that you entered earlier and click **OK**.
7. Press Esc and a message prompts you to save the changes.
8. Press Y to save the changes.
The computer reboots.

Deleting or changing an existing system and/or setup password

Ensure that the **Password Status** is Unlocked (in the System Setup) before attempting to delete or change the existing System and/or Setup password. You cannot delete or change an existing System or Setup password, if the **Password Status** is Locked.

To enter the System Setup, press F2 immediately after a power-on or reboot.

1. In the **System BIOS** or **System Setup** screen, select **System Security** and press Enter.
The **System Security** screen is displayed.
2. In the **System Security** screen, verify that **Password Status** is **Unlocked**.
3. Select **System Password**, alter or delete the existing system password and press Enter or Tab.
4. Select **Setup Password**, alter or delete the existing setup password and press Enter or Tab.
 **NOTE:** If you change the System and/or Setup password, re-enter the new password when prompted. If you delete the System and/or Setup password, confirm the deletion when prompted.
5. Press Esc and a message prompts you to save the changes.
6. Press Y to save the changes and exit from System Setup.
The computer reboots.

Specifications

 **NOTE:** Offerings may vary by region. For more information regarding the configuration of your computer in:



- Windows 10, click or tap **Start**  → **Settings** → **System** → **About**.
- Windows 8.1 and Windows 8, click or tap **Start**  → **PC Settings** → **PC and devices** → **PC Info**.
- Windows 7, click **Start** , right-click **My Computer**, and then select **Properties**.

Table 19. Processor

Feature	Specification
Processor type	6th Generation Intel Core i3/i5/i7 series
Total cache	Up to 8 MB cache depending on processor type

Table 20. Memory



Feature	Specification
Type	DDR4
Speed	2133 MHz
Connectors	Four UDIMM slots
Memory module capacity	4 GB and 8 GB
Minimum memory	4 GB
	 NOTE: The minimum memory may differ based on the operating system installed on the computer.
Maximum memory	32 GB
	 NOTE: Each UDIMM slot supports a minimum of 4 GB and a maximum of 8 GB.

Table 21. Video

Feature	Specification
Integrated	Intel HD Graphics 530 / 510
Discrete	PCI Express x16 graphics adapter

Table 22. Audio

Feature	Specification
Integrated	Two channel High Definition Audio

Table 23. Network

Feature	Specification
Integrated	Intel I219-LM Ethernet capable of 10/100/1000 Mb/s communication

Table 24. System information

Feature	Specification
System chipset	Intel 100 series, Q170
DMA channels	Two 8237 DMA controllers with seven independently programmable channels
Interrupt levels	Integrated I/O APIC capability with 24 interrupts
BIOS chip (NVRAM)	16 MB

Table 25. Expansion bus

Feature	Specification
Bus type	PCIe gen3 (x16), USB 2.0, and USB 3.0
Bus speed	PCI Express: <ul style="list-style-type: none"> • x4-slot each direction speed – up to 3.94 GB/s • x16-slot each direction speed – 16 GB/s SATA: 1.5 Gbps, 3.0 Gbps, and 6 Gbps

Table 26. Cards

Feature	Specification
PCI express x4	Half height card
PCI express x16	Half height card

Table 27. Drives

Feature	Specification
Externally accessible (5.25-inch drive bays)	Two
Optical drive	One

Table 28. External connectors

Feature	Specification
Audio	
Front panel	Universal Audio Jack
Back panel	Line out connector
Network adapter	RJ-45 connector
Serial	9-pin connector; 16550 C compatible
Parallel	25-pin connector (optional)
USB 2.0	<ul style="list-style-type: none"> • Front panel: two • Back panel: two
USB 3.0	<ul style="list-style-type: none"> • Front panel: two • Back panel: four
Video	<ul style="list-style-type: none"> • 19-pin HDMI connector • Two 20-pin DisplayPort connectors • 15-pin VGA connector (optional) <p> NOTE: Available video connectors may vary based on the graphics card selected.</p>
Keyboard and mouse	Back panel: <ul style="list-style-type: none"> • PS2 Keyboard 6-pin connector • PS2 Mouse 6-pin connector

Table 29. Internal connectors

Feature	Specification
PCI Express x16 (wired as x4) data width (maximum) — four PCI Express lanes	164-pin connector
PCI Express x16 data width (maximum) — 16 PCI Express lanes	164-pin connector
Serial ATA	Three 7-pin connectors
Memory	Four 288-pin connectors
Internal USB	10-pin connector
System fan	4-pin connector
SSD	M.2 22x80 socket3
Front panel control	5-pin connector
Processor	1151-pin connector
Processor fan	4-pin connector
Service mode jumper	2-pin connector

Feature	Specification
Password clear jumper	2-pin connector
RTC reset jumper	2-pin connector
Internal speaker	4-pin connector
Intruder connector	3-pin connector
Power connector	One 8-pin for PSU, one 4-pin for CPU, one 6-pin for SATA power

Table 30. Controls and lights

Feature	Specification
Front of the computer	
Power button light	White light — Solid white light indicates power-on state; slow blinking white light indicates sleep state of the computer.
Drive activity light	White light — Slow blinking white light indicates that the computer is reading data from or writing data to the hard drive.
Back of the computer	
Link integrity light on integrated network adapter	<ul style="list-style-type: none"> Green — a 10 Mbps connection exists between the network and the computer. Green — a 100 Mbps connection exists between the network and the computer. Orange — a 1000 Mbps connection exists between the network and the computer. Off (no light) — the computer is not detecting a physical connection to the network.
Network activity light on integrated network adapter	Yellow light — A blinking yellow light indicates that network activity is present.
Power supply diagnostic light	Green light — The power supply is turned on and is functional. The power cable must be connected to the power connector (at the back of the computer) and the electrical outlet.

Table 31. Power



NOTE: Heat dissipation is calculated by using the power supply wattage rating.

Power	Wattage	Maximum Heat Dissipation	Voltage
	180 W	614 BTU/hr	100 V AC to 240 V AC, 50 Hz to 60 Hz, 3A/1.5A
Coin cell battery		3 V CR2032 lithium coin cell	

Table 32. Physical dimension

Feature	Specifications
Height	290.00 mm (11.42 inches)
Width	93.00 mm (3.66 inches)
Depth	312.00 mm (8.38 inches)
Weight	6.00 kg (13.22 lb)

Table 33. Environmental

Feature	Specification
Temperature range	
Operating	5°C to 35°C (41°F to 95°F)
Storage	-40°C to 65°C (-40°F to 149°F)
Relative humidity (maximum)	
Operating	20 percent to 80 percent (non-condensing)
Storage	5 percent to 95 percent (non-condensing)
Maximum vibration	
Operating	0.26 Grms
Storage	2.20 Grms
Maximum shock	
Operating	40 G
Storage	105 G
Altitude	
Operating	-15.2 m to 3048 m (-50 to 10,000 ft)
Storage	-15.20 m to 10,668 m (-50 ft to 35,000 ft)
Airborne contaminant level	G1 or lower as defined by ANSI/ISA-S71.04-1985

Contacting Dell

 **NOTE:** If you do not have an active Internet connection, you can find contact information on your purchase invoice, packing slip, bill, or Dell product catalog.

Dell provides several online and telephone-based support and service options. Availability varies by country and product, and some services may not be available in your area. To contact Dell for sales, technical support, or customer service issues:

1. Go to **Dell.com/support**.
2. Select your support category.
3. Verify your country or region in the **Choose a Country/Region** drop-down list at the bottom of the page.
4. Select the appropriate service or support link based on your need.