



Latitude 12–7275

Owner's Manual

Regulatory Model: T02H
Regulatory Type: T02H001



Notes, cautions, and warnings

-  **NOTE:** A NOTE indicates important information that helps you make better use of your tablet.
-  **CAUTION:** A CAUTION indicates either potential damage to hardware or loss of data and tells you how to avoid the problem.
-  **WARNING:** A WARNING indicates a potential for property damage, personal injury, or death.

Copyright © 2016 Dell Inc. All rights reserved. This product is protected by U.S. and international copyright and intellectual property laws. Dell™ and the Dell logo are trademarks of Dell Inc. in the United States and/or other jurisdictions. All other marks and names mentioned herein may be trademarks of their respective companies.

2015–12

Rev. A00

Contents

1 Before working inside your tablet.....	8
Before you begin	8
Safety instructions.....	8
Recommended tools.....	9
2 After working inside your tablet.....	10
3 Removing the battery.....	11
Procedure.....	11
4 Replacing the battery.....	13
Procedure.....	13
5 Removing the solid-state drive.....	14
Prerequisites.....	14
Procedure.....	14
6 Replacing the solid-state drive.....	16
Procedure.....	16
Post-requisites.....	16
7 Removing the wireless card.....	17
Prerequisites.....	17
Procedure.....	17
8 Replacing the wireless card.....	19
Procedure.....	19
Post-requisites.....	19
9 Removing the front camera.....	20
Prerequisites.....	20
Procedure.....	20
10 Replacing the front camera.....	21
Procedure.....	21
Post-requisites.....	21
11 Removing the back camera.....	22
Prerequisites.....	22

Procedure.....	22
12 Replacing the back camera.....	23
Procedure.....	23
Post-requisites.....	23
13 Removing the coin-cell battery.....	24
Prerequisites.....	24
Procedure.....	24
14 Replacing the coin-cell battery.....	26
Procedure.....	26
Post-requisites.....	26
15 Removing the headset port.....	27
Prerequisites.....	27
Procedure.....	27
16 Replacing the headset port.....	28
Procedure.....	28
Post-requisites.....	28
17 Removing the microphone.....	29
Prerequisites.....	29
Procedure.....	29
18 Replacing the microphone.....	30
Procedure.....	30
Post-requisites.....	30
19 Removing the power-button board.....	31
Prerequisites.....	31
Procedure.....	31
20 Replacing the power-button board.....	32
Procedure.....	32
Post-requisites.....	32
21 Removing the volume-buttons board.....	33
Prerequisites.....	33
Procedure.....	33
22 Replacing the volume-buttons board.....	34

Procedure.....	34
Post-requisites.....	34
23 Removing the system board.....	35
Prerequisites.....	35
Procedure.....	35
24 Replacing the system board.....	38
Procedure.....	38
Post-requisites.....	38
25 Removing the back cover.....	39
Prerequisites.....	39
Procedure.....	39
26 Replacing the back cover.....	41
Procedure.....	41
Post-requisites.....	41
27 Removing the display assembly.....	42
Prerequisites.....	42
Procedure.....	42
28 Replacing the display assembly.....	43
Procedure.....	43
Post-requisites.....	43
29 Technology and Components.....	44
Power adapter.....	44
Processors.....	44
Identifying processors in Windows 10.....	44
Identifying processors in Windows 8.....	44
Verifying the processor usage in Task Manager.....	45
Verifying the processor usage in Resource Monitor.....	45
Chipsets.....	46
Downloading the chipset driver.....	46
Identifying the chipset in Device Manager on Windows 10.....	46
Identifying chipset in Device Manager on Windows 8.....	47
Graphic options.....	48
Downloading Driver.....	48
Identifying the display adapter.....	49
Changing the screen resolution.....	49
Rotating the display.....	49



Display options.....	50
Adjusting brightness in Windows 10.....	50
Adjusting brightness in Windows 8.....	50
Cleaning the display.....	50
Using touch screen in Windows 10.....	51
Using touch screen in Windows 8.....	51
Connecting to external display devices.....	51
Realtek ALC3266–CG Waves MaxxAudio Pro controller.....	51
Downloading the audio driver.....	51
Identifying the audio controller in Windows 10.....	52
Identifying the audio controller in Windows 8.....	52
Changing the audio settings.....	52
WLAN cards.....	52
Downloading the WLAN driver.....	53
Hard drive options.....	53
Identifying the hard drive in Windows 10.....	53
Identifying the hard drive in Windows 8.....	53
Entering BIOS setup.....	53
Camera features.....	54
Identifying the camera in Device Manager on Windows 10.....	54
Identifying the camera in Device Manager on Windows 8.....	54
Starting the camera.....	55
Starting the Camera App.....	55
Memory features.....	56
Verifying system memory in Windows 10.....	56
Verifying system memory in Windows 8.....	56
Verifying system memory in setup.....	56
Testing memory using ePSA.....	57
Intel chipset drivers.....	57
Intel HD Graphics drivers.....	57
Realtek HD audio drivers.....	58
Realtek RTS5242–GR Card Reader drivers.....	58
Realtek LAN network drivers.....	58
Intel Wireless 3165 WiFi and Bluetooth drivers.....	58
30 Entering BIOS setup program.....	60
With keyboard.....	60
Without keyboard.....	60
Flashing the BIOS.....	60
31 Specifications.....	61

32 Getting help and contacting Dell.....	64
Self-help resources.....	64
Contacting Dell.....	64

Before working inside your tablet

 **NOTE:** The images in this document may differ from your tablet depending on the configuration you ordered.





Before you begin

1. Save and close all open files and exit all open applications.
2. Shut down your tablet.
 - Windows 10: Click or tap **Start** →  **Power** → **Shut down**.
 - Windows 8: Click or tap  **Power Shut down**

 **NOTE:** If you are using a different operating system, see the documentation of your operating system for shut-down instructions.
3. Disconnect your tablet and all attached devices from their electrical outlets.
4. Disconnect all cables such as telephone cables, network cables and so on, from your tablet.
5. Disconnect all attached devices and peripherals, such as keyboard, mouse, monitor, and so on, from your tablet.
6. Remove any media card and SIM card from your tablet, if applicable.

Safety instructions

Use the following safety guidelines to protect your tablet from potential damage and ensure your personal safety.

-  **WARNING:** Before working inside your tablet, read the safety information that shipped with your tablet and follow the steps in [Before working inside your tablet](#). After working inside your tablet, follow the instructions in [After working inside your tablet](#). For more safety best practices, see the Regulatory Compliance home page at www.dell.com/regulatory_compliance.
-  **WARNING:** Disconnect all power sources before opening the tablet cover or panels. After you finish working inside the tablet, replace all covers, panels, and screws before connecting to the power source.
-  **CAUTION:** To avoid damaging the tablet, ensure that the work surface is flat and clean.
-  **CAUTION:** To avoid damaging the components and cards, handle them by their edges and avoid touching pins and contacts.
-  **CAUTION:** You should only perform troubleshooting and repairs as authorized or directed by the Dell technical assistance team. Damage due to servicing that is not authorized by Dell is not covered by your warranty. See the safety instructions that shipped with the product or at www.dell.com/regulatory_compliance.

 **CAUTION:** Before touching anything inside your tablet, ground yourself by touching an unpainted metal surface. While you work, periodically touch an unpainted metal surface to dissipate static electricity, which could harm internal components.

 **CAUTION:** When you disconnect a cable, pull on its connector or on its pull tab, not on the cable itself. Some cables have connectors with locking tabs or thumb-screws that you must disengage before disconnecting the cable. When disconnecting cables, keep them evenly aligned to avoid bending any connector pins. When connecting cables, ensure that the ports and connectors are correctly oriented and aligned.

 **CAUTION:** Press and eject any installed card from the media-card reader.

Recommended tools

The procedures in this document may require the following tools:

- Phillips screwdriver
- Plastic scribe

After working inside your tablet

 **CAUTION:** Leaving stray or loose screws inside your tablet may severely damage your tablet.

1. Replace all screws and ensure that no stray screws remain inside your tablet.
2. Connect any external devices, peripherals, and cables you removed before working on your tablet.
3. Replace any media card, SIM card, and any other parts that you removed before working on your tablet.
4. Connect your tablet and all attached devices to their electrical outlets.
5. Turn on your tablet.

Removing the battery

⚠ WARNING: Before working inside your tablet, read the safety information that shipped with your tablet and follow the steps in [Before working inside your tablet](#). After working inside your tablet, follow the instructions in [After working inside your tablet](#). For more safety best practices, see the Regulatory Compliance home page at www.dell.com/regulatory_compliance.

Procedure

⚠ CAUTION: Before opening your tablet, ensure that you place the tablet on a soft cloth or clean surface to avoid any scratches on the display.

1. Turn the tablet over.
2. Remove the screws that secure the back-cover assembly to the display assembly.
3. Using a plastic scribe, pry up along the edges of the back-cover assembly.

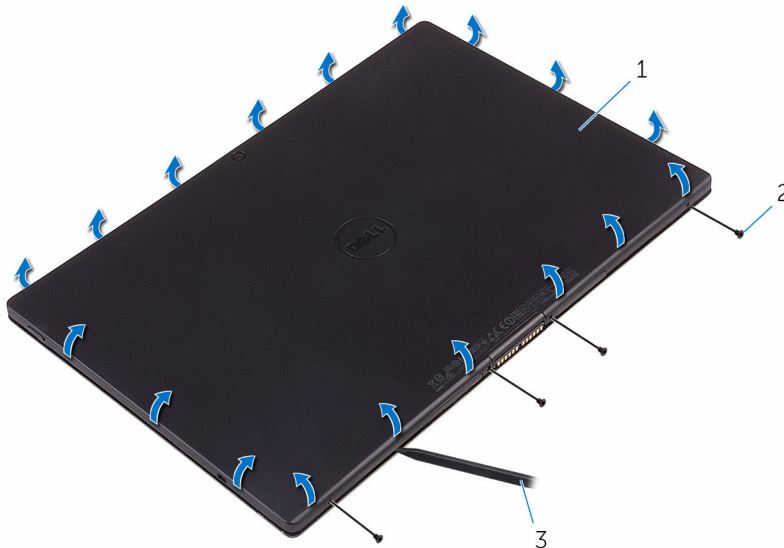

1. back-cover assembly
2. screws (4)
3. plastic scribe
4. Carefully, lift the back-cover assembly and turn it over.



1. back-cover assembly

5. Remove the screws that secure the battery to the back-cover assembly.
6. Disconnect the battery cable from the system board.
7. Lift the battery, along with its cable, off the back-cover assembly.

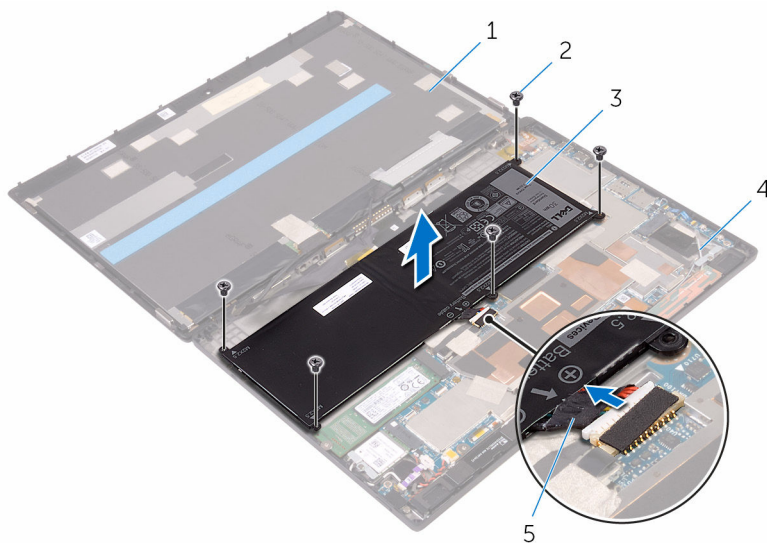

1. display assembly
3. battery
5. battery cable

2. screws (5)
4. back-cover assembly

Replacing the battery

 **WARNING:** Before working inside your tablet, read the safety information that shipped with your tablet and follow the steps in [Before working inside your tablet](#). After working inside your tablet, follow the instructions in [After working inside your tablet](#). For more safety best practices, see the Regulatory Compliance home page at www.dell.com/regulatory_compliance.

Procedure

1. Align the screw holes on the battery with the screw holes on the back-cover assembly.
2. Replace the screws that secure the battery to the back-cover assembly.
3. Connect the battery cable to the system board.
4. Align the back-cover assembly with the display assembly and snap it into place.
5. Replace the screws that secure the back-cover assembly to the display assembly.
6. Turn the tablet over.

Removing the solid-state drive

⚠ WARNING: Before working inside your tablet, read the safety information that shipped with your tablet and follow the steps in [Before working inside your tablet](#). After working inside your tablet, follow the instructions in [After working inside your tablet](#). For more safety best practices, see the Regulatory Compliance home page at www.dell.com/regulatory_compliance.

⚠ CAUTION: Solid-state drives are fragile. Exercise care when handling the hard drive.

⚠ CAUTION: To avoid data loss, do not remove the solid-state drive while the tablet is in sleep or on state.

Prerequisites

Remove the [battery](#).

Procedure

1. Remove the screw that secures the solid-state drive to the back-cover assembly.
2. Lift and slide the solid-state drive off the back-cover assembly.

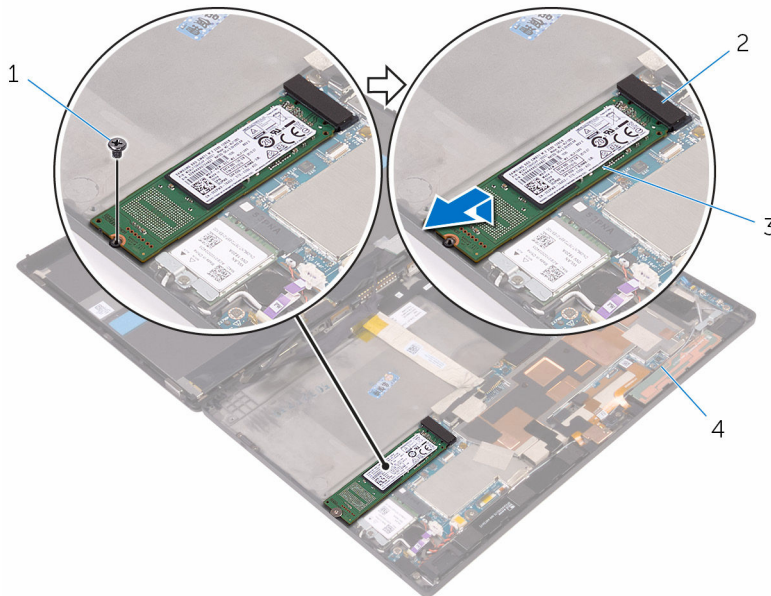

1. screw

2. solid-state drive slot

3. solid-state drive

4. back-cover assembly

Replacing the solid-state drive

 **WARNING:** Before working inside your tablet, read the safety information that shipped with your tablet and follow the steps in [Before working inside your tablet](#). After working inside your tablet, follow the instructions in [After working inside your tablet](#). For more safety best practices, see the Regulatory Compliance home page at www.dell.com/regulatory_compliance.

 **CAUTION:** Solid-state drives are fragile. Exercise care when handling the hard drive.

Procedure

1. Slide the solid-state drive into the slot on the system board.
2. Align the screw hole on the solid-state drive with the screw hole on the back-cover assembly.
3. Replace the screw that secures the solid-state drive to the back-cover assembly.

Post-requisites

Replace the [battery](#).

Removing the wireless card

⚠ WARNING: Before working inside your tablet, read the safety information that shipped with your tablet and follow the steps in [Before working inside your tablet](#). After working inside your tablet, follow the instructions in [After working inside your tablet](#). For more safety best practices, see the Regulatory Compliance home page at www.dell.com/regulatory_compliance.

Prerequisites

Remove the [battery](#).

Procedure

1. Remove the screw that secures the wireless-card bracket and the wireless card to the system board.
2. Lift the wireless-card bracket off the wireless card.
3. Disconnect the antenna cables from the wireless card.
4. Slide and remove the wireless card from the wireless-card slot.

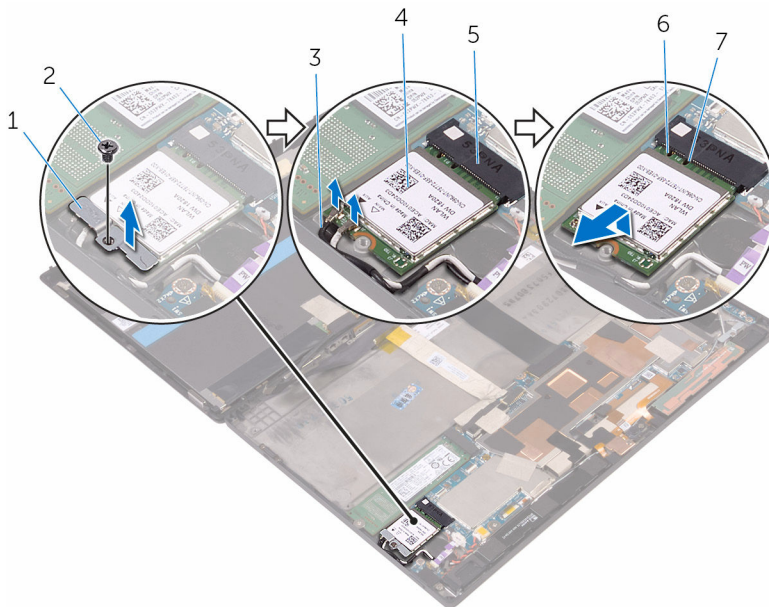

- | | |
|--------------------------|------------------|
| 1. wireless-card bracket | 2. screw |
| 3. antenna cables (2) | 4. wireless card |
| 5. wireless-card slot | 6. notch |

7. tab

Replacing the wireless card

 **WARNING:** Before working inside your tablet, read the safety information that shipped with your tablet and follow the steps in [Before working inside your tablet](#). After working inside your tablet, follow the instructions in [After working inside your tablet](#). For more safety best practices, see the Regulatory Compliance home page at www.dell.com/regulatory_compliance.

Procedure

 **CAUTION:** To avoid damage to the wireless mini-card, do not place any cables under it.

1. Align the notch on the wireless card with the tab on the wireless-card slot and slide the card into the wireless-card slot.
2. Align the screw hole on the wireless card with the screw hole on the system board.
3. Connect the antenna cables to the wireless card. The following table provides the antenna-cable color scheme for the wireless card supported by your tablet:

Connectors on the wireless card	Antenna-cable color
Main (white triangle)	White
Auxiliary (black triangle)	Black

4. Align the screw hole on the wireless-card bracket with the screw hole on the system board.
5. Replace the screw that secures wireless-card bracket and the wireless card to the system board.

Post-requisites

Replace the [battery](#).

Removing the front camera

⚠ WARNING: Before working inside your tablet, read the safety information that shipped with your tablet and follow the steps in [Before working inside your tablet](#). After working inside your tablet, follow the instructions in [After working inside your tablet](#). For more safety best practices, see the Regulatory Compliance home page at www.dell.com/regulatory_compliance.

Prerequisites

Remove the [battery](#).

Procedure

1. Remove the screw that secures the front camera to the back-cover assembly.
2. Disconnect the camera cable from the system board.
3. Lift the front camera, along with its cable, off the back-cover assembly.

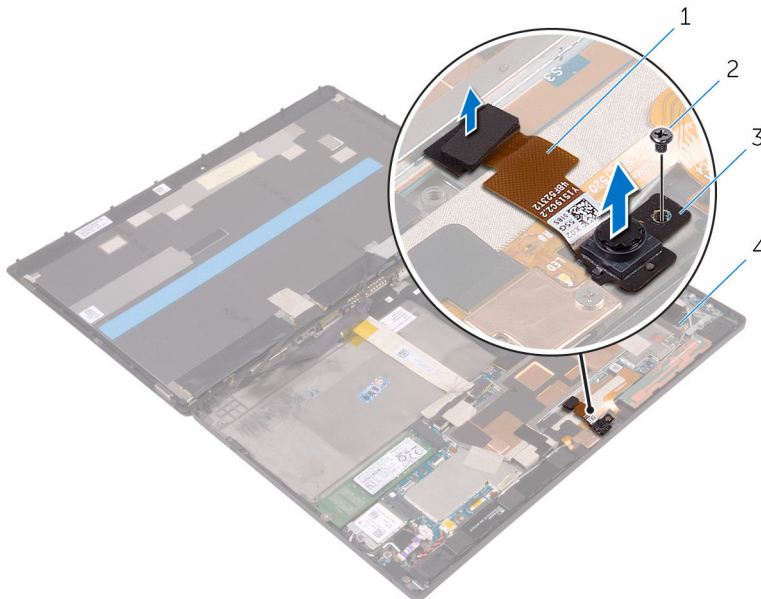

1. camera cable
3. front camera

2. screw
4. back-cover assembly

Replacing the front camera

 **WARNING:** Before working inside your tablet, read the safety information that shipped with your tablet and follow the steps in [Before working inside your tablet](#). After working inside your tablet, follow the instructions in [After working inside your tablet](#). For more safety best practices, see the Regulatory Compliance home page at www.dell.com/regulatory_compliance.

Procedure

1. Align the screw hole on the front camera with the screw hole on the back-cover assembly.
2. Replace the screw that secures the front camera to the back-cover assembly.
3. Connect the camera cable to the system board.

Post-requisites

Replace the [battery](#).

Removing the back camera

⚠ WARNING: Before working inside your tablet, read the safety information that shipped with your tablet and follow the steps in [Before working inside your tablet](#). After working inside your tablet, follow the instructions in [After working inside your tablet](#). For more safety best practices, see the Regulatory Compliance home page at www.dell.com/regulatory_compliance.

Prerequisites

Remove the [battery](#).

Procedure

1. Remove the screw that secures the back camera to the back-cover assembly.
2. Disconnect the camera cable from the system board.
3. Lift the back camera, along with its cable, off the back-cover assembly.

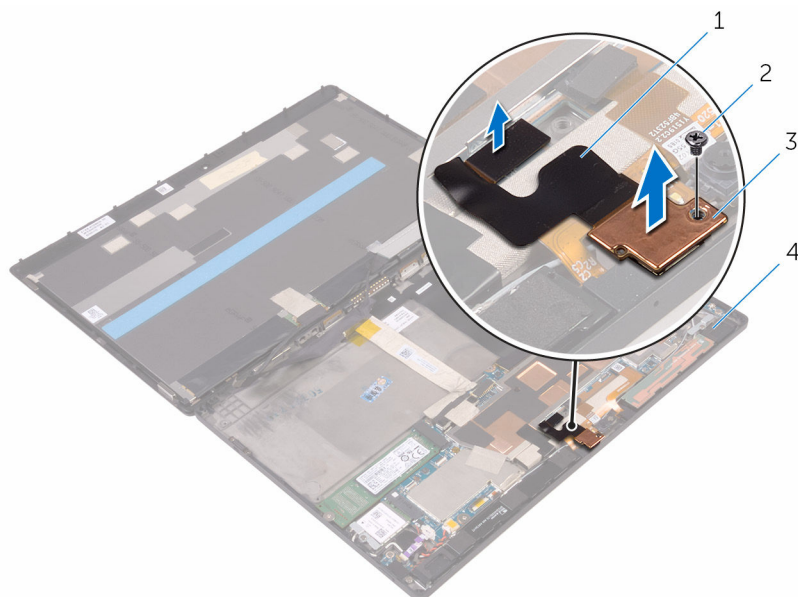

1. camera cable
3. back camera

2. screw
4. back-cover assembly

Replacing the back camera

 **WARNING:** Before working inside your tablet, read the safety information that shipped with your tablet and follow the steps in [Before working inside your tablet](#). After working inside your tablet, follow the instructions in [After working inside your tablet](#). For more safety best practices, see the Regulatory Compliance home page at www.dell.com/regulatory_compliance.

Procedure

1. Align the screw hole on the back camera with the screw hole on the back-cover assembly.
2. Replace the screw that secures the back camera to the back-cover assembly.
3. Connect the camera cable to the system board.

Post-requisites

Replace the [battery](#).

Removing the coin-cell battery

⚠ WARNING: Before working inside your tablet, read the safety information that shipped with your tablet and follow the steps in [Before working inside your tablet](#). After working inside your tablet, follow the instructions in [After working inside your tablet](#). For more safety best practices, see the Regulatory Compliance home page at www.dell.com/regulatory_compliance.

⚠ CAUTION: Removing the coin-cell battery resets the BIOS setup program's settings to default. It is recommended that you note the BIOS setup program's settings before removing the coin-cell battery.

Prerequisites

Remove the [battery](#).

Procedure

1. Lift the latch and disconnect the power-button board cable from the power-button board.
2. Disconnect the coin-cell battery cable from the system board.
3. Peel the coin-cell battery off the back-cover assembly.

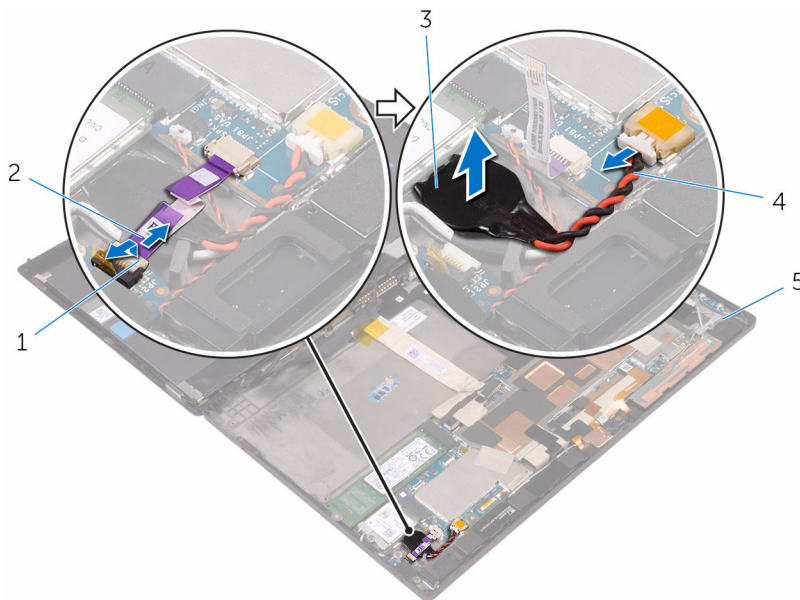

- | | |
|----------------------|-----------------------------|
| 1. latch | 2. power-button board cable |
| 3. coin-cell battery | 4. coin-cell battery cable |

5. back-cover assembly

Replacing the coin-cell battery

 **WARNING:** Before working inside your tablet, read the safety information that shipped with your tablet and follow the steps in [Before working inside your tablet](#). After working inside your tablet, follow the instructions in [After working inside your tablet](#). For more safety best practices, see the Regulatory Compliance home page at www.dell.com/regulatory_compliance.

Procedure

1. Adhere the coin-cell battery to the back-cover assembly.
2. Connect the coin-cell battery cable to the system board.
3. Slide the power-button board cable into its connector on the power-button board and press down the latch to secure the cable.

Post-requisites

Replace the [battery](#).

Removing the headset port

⚠ WARNING: Before working inside your tablet, read the safety information that shipped with your tablet and follow the steps in [Before working inside your tablet](#). After working inside your tablet, follow the instructions in [After working inside your tablet](#). For more safety best practices, see the Regulatory Compliance home page at www.dell.com/regulatory_compliance.

Prerequisites

Remove the [battery](#).

Procedure

1. Remove the screws that secure the headset-port bracket and the headset port to the back-cover assembly.
2. Lift the headset-port bracket off the headset port.
3. Lift the latch and disconnect the headset-port cable from the system board.
4. Lift the headset port, along with its cable, off the back-cover assembly.

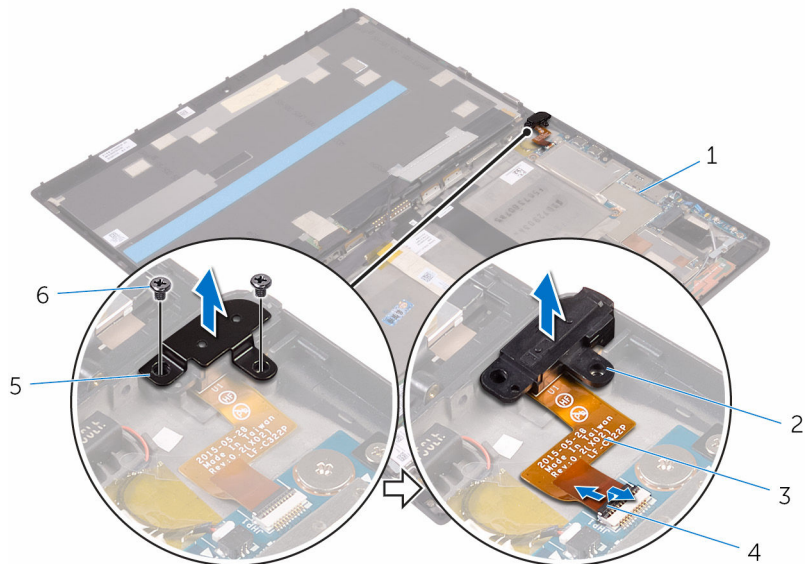

- | | |
|-------------------------|-----------------|
| 1. back-cover assembly | 2. headset port |
| 3. headset-port cable | 4. latch |
| 5. headset-port bracket | 6. screws (2) |

Replacing the headset port

 **WARNING:** Before working inside your tablet, read the safety information that shipped with your tablet and follow the steps in [Before working inside your tablet](#). After working inside your tablet, follow the instructions in [After working inside your tablet](#). For more safety best practices, see the Regulatory Compliance home page at www.dell.com/regulatory_compliance.

Procedure

1. Slide the headset-port cable into its connector on the system board and press down the latch to secure the cable.
2. Align the screw holes on the headset-port bracket and the headset port with the screw holes on the back-cover assembly.
3. Replace the screws that secure the headset-port bracket and the headset port to the back-cover assembly.

Post-requisites

Replace the [battery](#).

Removing the microphone

⚠ WARNING: Before working inside your tablet, read the safety information that shipped with your tablet and follow the steps in [Before working inside your tablet](#). After working inside your tablet, follow the instructions in [After working inside your tablet](#). For more safety best practices, see the Regulatory Compliance home page at www.dell.com/regulatory_compliance.

Prerequisites

1. Remove the [battery](#).
2. Remove the [front camera](#).
3. Remove the [back camera](#).

Procedure

1. Disconnect the microphone cable from the system board.
2. Lift the microphones, along with the cable, off the back-cover assembly.

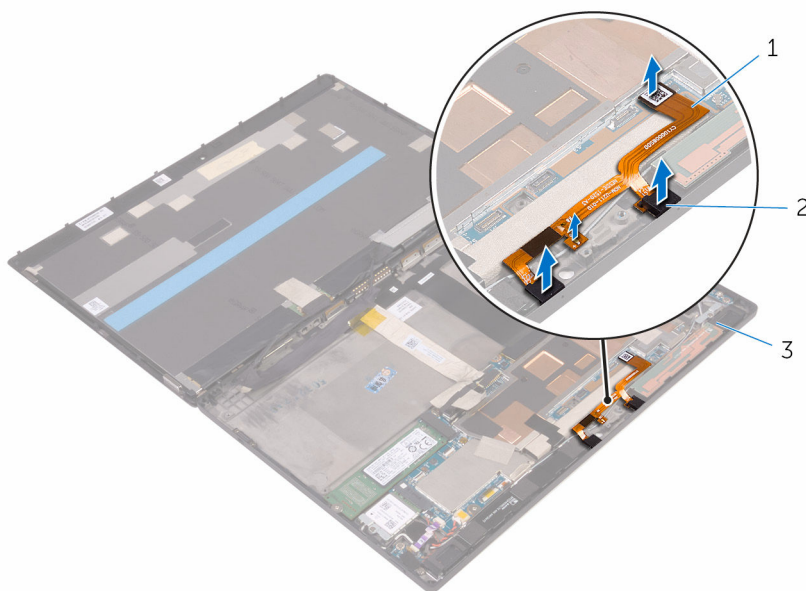

1. microphone cable
2. microphones (2)
3. back-cover assembly

Replacing the microphone

 **WARNING:** Before working inside your tablet, read the safety information that shipped with your tablet and follow the steps in [Before working inside your tablet](#). After working inside your tablet, follow the instructions in [After working inside your tablet](#). For more safety best practices, see the Regulatory Compliance home page at www.dell.com/regulatory_compliance.

Procedure

1. Align the microphones on the back-cover assembly and snap them into place.
2. Connect the microphone cable to the system board.

Post-requisites

1. Replace the [back camera](#).
2. Replace the [front camera](#).
3. Replace the [battery](#).

Removing the power-button board

⚠ WARNING: Before working inside your tablet, read the safety information that shipped with your tablet and follow the steps in [Before working inside your tablet](#). After working inside your tablet, follow the instructions in [After working inside your tablet](#). For more safety best practices, see the Regulatory Compliance home page at www.dell.com/regulatory_compliance.

Prerequisites

Remove the [battery](#).

Procedure

1. Remove the screws that secure the power-button board to the back-cover assembly.
2. Lift the latch and disconnect the power-button board cable from the power-button board.
3. Lift the power-button board off the back-cover assembly.

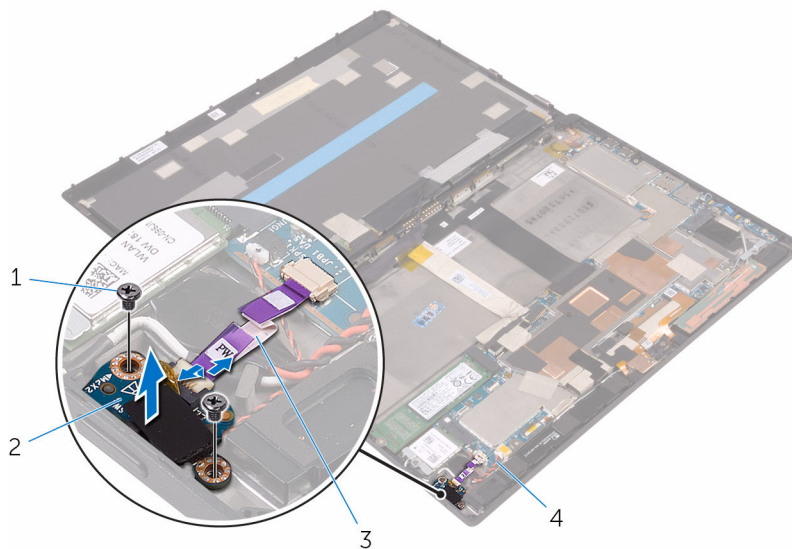

- | | |
|-----------------------------|------------------------|
| 1. screws (2) | 2. power-button board |
| 3. power-button board cable | 4. back-cover assembly |

Replacing the power-button board

 **WARNING:** Before working inside your tablet, read the safety information that shipped with your tablet and follow the steps in [Before working inside your tablet](#). After working inside your tablet, follow the instructions in [After working inside your tablet](#). For more safety best practices, see the Regulatory Compliance home page at www.dell.com/regulatory_compliance.

Procedure

1. Align the screw holes on the power-button board with the screw holes on the back-cover assembly.
2. Replace the screws that secure the power-button board to the back-cover assembly.
3. Slide the power-button board cable into the connector on the power-button board and press down the latch to secure the cable.

Post-requisites

Replace the [battery](#).

Removing the volume-buttons board

⚠ WARNING: Before working inside your tablet, read the safety information that shipped with your tablet and follow the steps in [Before working inside your tablet](#). After working inside your tablet, follow the instructions in [After working inside your tablet](#). For more safety best practices, see the Regulatory Compliance home page at www.dell.com/regulatory_compliance.

Prerequisites

Remove the [battery](#).

Procedure

1. Remove the screws that secure the volume-buttons board to the back-cover assembly.
2. Lift the latch and disconnect the volume-buttons board cable from the volume-buttons board.
3. Lift the volume-buttons board off the back-cover assembly.

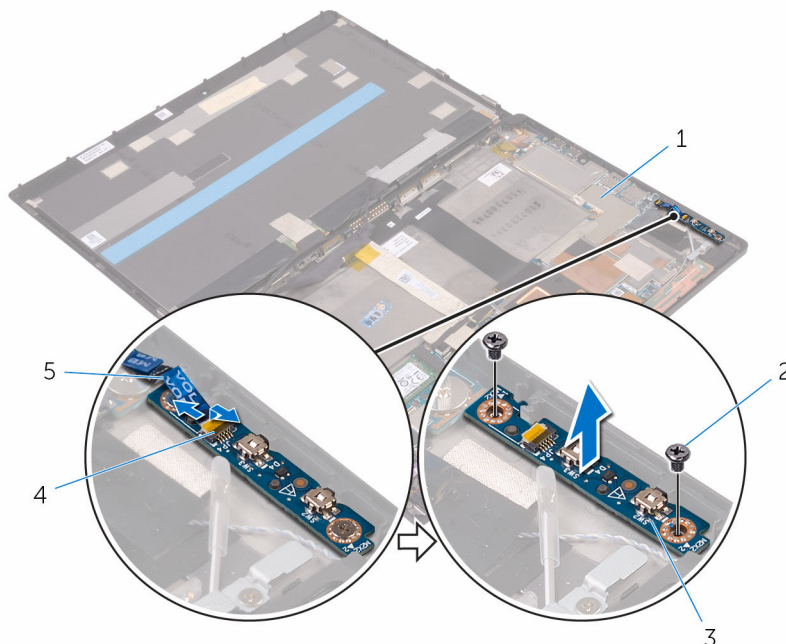

- | | |
|-------------------------------|---------------|
| 1. back-cover assembly | 2. screws (2) |
| 3. volume-buttons board | 4. latch |
| 5. volume-buttons board cable | |

Replacing the volume-buttons board



WARNING: Before working inside your tablet, read the safety information that shipped with your tablet and follow the steps in [Before working inside your tablet](#). After working inside your tablet, follow the instructions in [After working inside your tablet](#). For more safety best practices, see the Regulatory Compliance home page at www.dell.com/regulatory_compliance.





Procedure

1. Align the screw holes on the volume-buttons board with the screw holes on the back-cover assembly.
2. Replace the screws that secure the volume-buttons board to the back-cover assembly.
3. Slide the volume-buttons board cable into the connector on the volume-buttons board and press down the latch to secure the cable.

Post-requisites

Replace the [battery](#).

Removing the system board

-  **WARNING:** Before working inside your tablet, read the safety information that shipped with your tablet and follow the steps in [Before working inside your tablet](#). After working inside your tablet, follow the instructions in [After working inside your tablet](#). For more safety best practices, see the Regulatory Compliance home page at www.dell.com/regulatory_compliance.
-  **NOTE:** Your tablet's Service Tag is stored in the system board. You must enter the Service Tag in the BIOS setup program after you replace the system board.
-  **NOTE:** Replacing the system board removes any changes you have made to the BIOS using the BIOS setup program. You must make the desired changes again after you replace the system board.
-  **NOTE:** Before disconnecting the cables from the system board, note the location of the connectors so that you can reconnect the cables correctly after you replace the system board.

Prerequisites

1. Remove the [battery](#).
2. Remove the [solid-state drive](#).
3. Remove the [wireless card](#).

Procedure

1. Disconnect the speaker cables, camera cables, microphone cable, and coin-cell battery cable from the system board.
2. Lift the latches and disconnect the headset-port cable, power-button board cable and display cable from the system board.

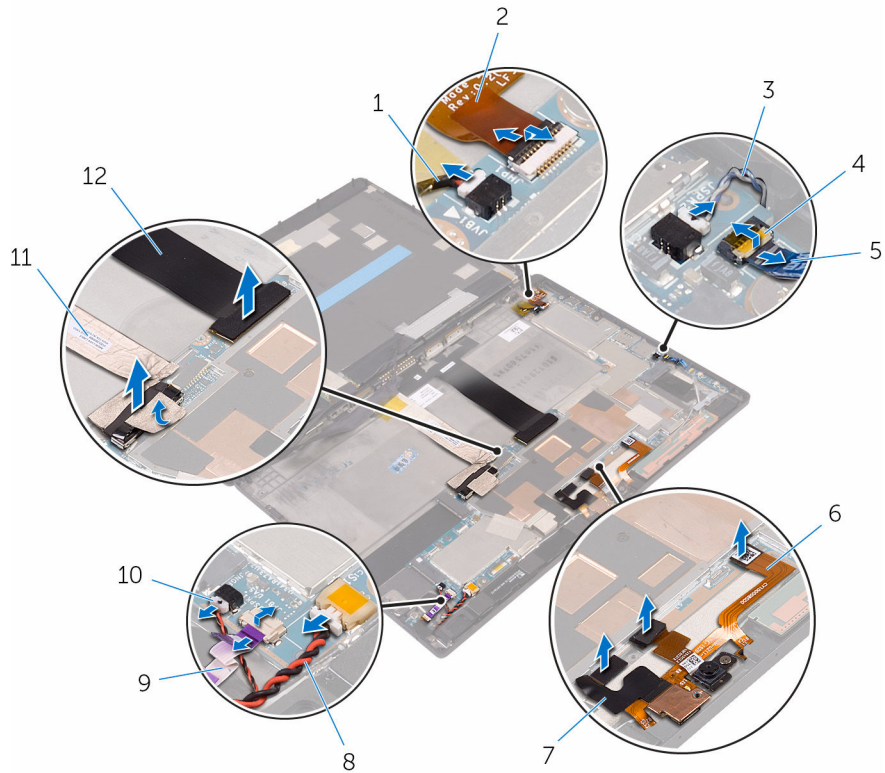

- | | |
|-------------------------------|----------------------------|
| 1. vibration-motor cable | 2. headset-port cable |
| 3. speaker cable | 4. latch |
| 5. volume-buttons board cable | 6. microphone cable |
| 7. camera cables (2) | 8. coin-cell battery cable |
| 9. power-button board cable | 10. speaker cable |
| 11. display cable | 12. dock-connector cable |

3. Lift the antenna cable off the system board.
4. Remove the screws that secure the I/O bracket to the system board.
5. Lift the I/O bracket off the system board.

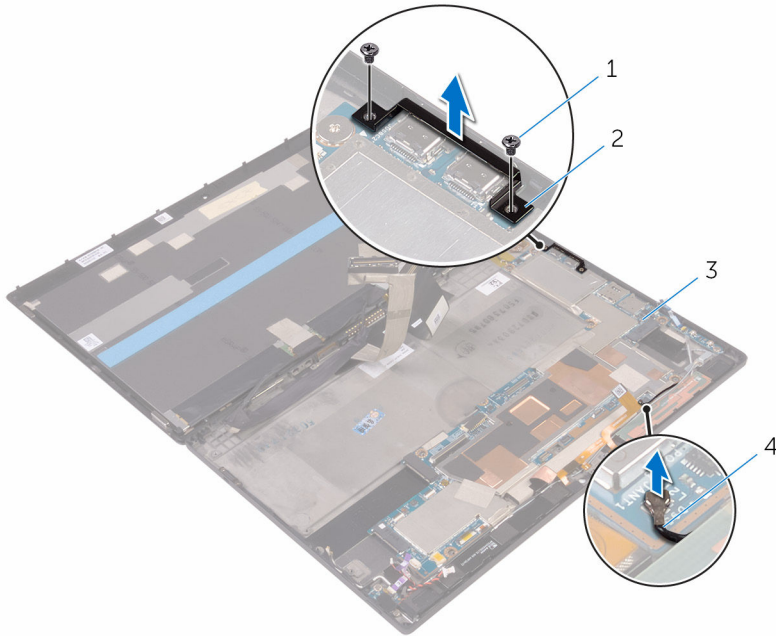

- 1. screws (2)
- 2. I/O bracket
- 3. back-cover assembly
- 4. antenna cable

- 6. Remove the screws that secure the system board to the back-cover assembly.
- 7. Lift the system board off the back-cover assembly.

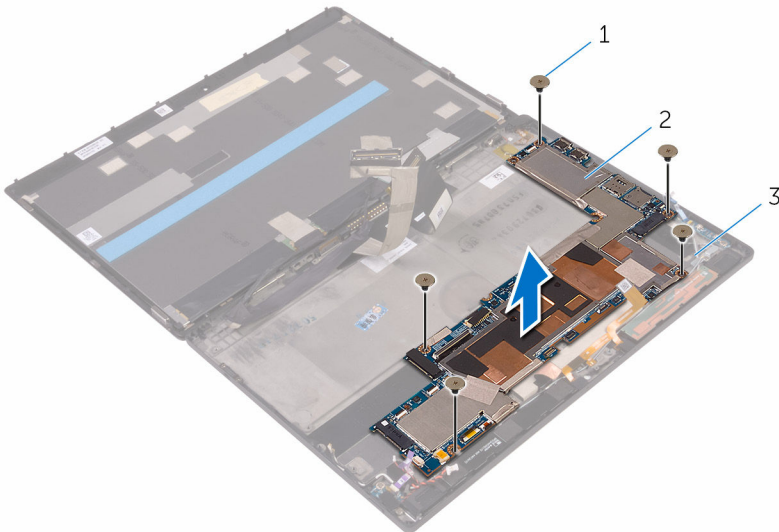

- 1. screws (5)
- 2. system board
- 3. back-cover assembly

Replacing the system board

 **WARNING:** Before working inside your tablet, read the safety information that shipped with your tablet and follow the steps in [Before working inside your tablet](#). After working inside your tablet, follow the instructions in [After working inside your tablet](#). For more safety best practices, see the Regulatory Compliance home page at www.dell.com/regulatory_compliance.

 **NOTE:** Your tablet's Service Tag is stored in the system board. You must enter the Service Tag in the BIOS setup program after you replace the system board.

 **NOTE:** Replacing the system board removes any changes you have made to the BIOS using the BIOS setup program. You must make the desired changes again after you replace the system board.

Procedure

1. Align the screw holes on the system board with the screw holes on the back-cover assembly.
2. Replace the screws that secure the system board to the back-cover assembly.
3. Align the screw holes on the I/O bracket with the screw holes on the system board.
4. Replace the screws that secure the I/O bracket to the system board.
5. Slide in the headset-port cable, power-button board cable and display assembly cable into the respective connectors on the system board and press down the latches to secure the cables.
6. Connect the speaker cables, camera cables, microphone cable, and coin-cell battery cable to the respective connectors on the system board.

Post-requisites

1. Replace the [wireless card](#).
2. Replace the [solid-state drive](#).
3. Replace the [battery](#).

Removing the back cover

 **WARNING:** Before working inside your tablet, read the safety information that shipped with your tablet and follow the steps in [Before working inside your tablet](#). After working inside your tablet, follow the instructions in [After working inside your tablet](#). For more safety best practices, see the Regulatory Compliance home page at www.dell.com/regulatory_compliance.

Prerequisites

1. Remove the [battery](#).
2. Remove the [solid-state drive](#).
3. Remove the [wireless card](#).
4. Remove the [front camera](#).
5. Remove the [back camera](#).
6. Remove the [coin-cell battery](#).
7. Remove the [headset port](#).
8. Remove the [microphones](#).
9. Remove the [power-button board](#).
10. Remove the [volume-buttons board](#).
11. Remove the [system board](#).
12. Remove the [display assembly](#).

Procedure

After performing the prerequisites, we are left with the back cover.

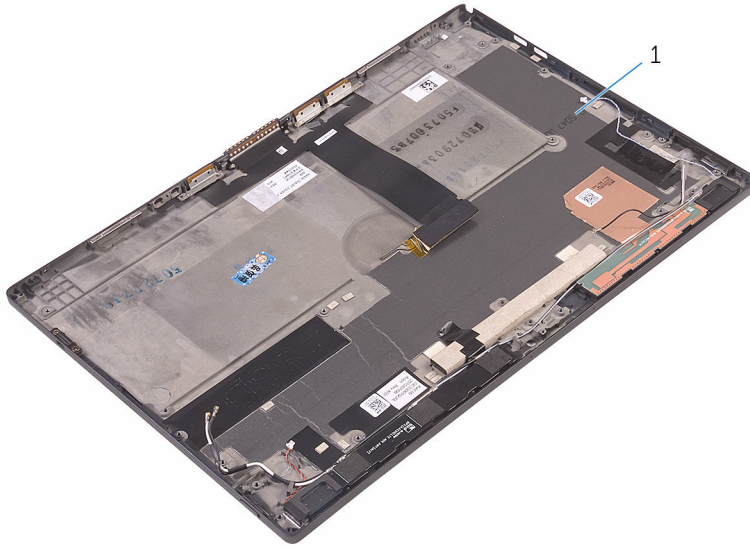

1. back cover

Replacing the back cover

 **WARNING:** Before working inside your tablet, read the safety information that shipped with your tablet and follow the steps in [Before working inside your tablet](#). After working inside your tablet, follow the instructions in [After working inside your tablet](#). For more safety best practices, see the Regulatory Compliance home page at www.dell.com/regulatory_compliance.

Procedure

Place the back cover on a flat surface.

Post-requisites

1. Replace the [display assembly](#)
2. Replace the [system board](#).
3. Replace the [volume-buttons board](#).
4. Replace the [power-button board](#).
5. Replace the [microphones](#).
6. Replace the [headset port](#).
7. Replace the [coin-cell battery](#).
8. Replace the [back camera](#).
9. Replace the [front camera](#).
10. Replace the [wireless card](#).
11. Replace the [solid-state drive](#).
12. Replace the [battery](#).

Removing the display assembly

⚠ WARNING: Before working inside your tablet, read the safety information that shipped with your tablet and follow the steps in [Before working inside your tablet](#). After working inside your tablet, follow the instructions in [After working inside your tablet](#). For more safety best practices, see the Regulatory Compliance home page at www.dell.com/regulatory_compliance.

Prerequisites

Remove the [battery](#).

Procedure

1. Peel off the display cable from the system board.
2. Using the pull tab, disconnect the display cable from the system board.
3. Peel off the display cable from the back-cover assembly.
4. Lift the display assembly, along with its cable, off the back-cover assembly.

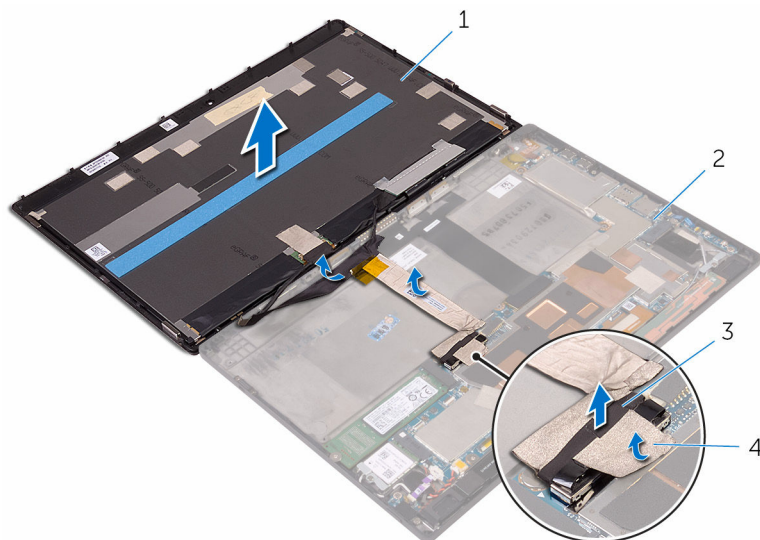

1. display assembly
3. pull tab

2. back-cover assembly
4. display cable

Replacing the display assembly

 **WARNING:** Before working inside your tablet, read the safety information that shipped with your tablet and follow the steps in [Before working inside your tablet](#). After working inside your tablet, follow the instructions in [After working inside your tablet](#). For more safety best practices, see the Regulatory Compliance home page at www.dell.com/regulatory_compliance.

Procedure

1. Adhere the display cable to the back-cover assembly.
2. Connect the display cable to the system board.
3. Adhere the display cable to the connector on the system board.

Post-requisites

Replace the [battery](#).

Technology and Components

Power adapter

This tablet is offered with the 30 W power adapter.

 **WARNING:** When you disconnect the power adapter cable from the tablet, grasp the connector, not the cable itself, and then pull firmly but gently to avoid damaging the cable.

 **WARNING:** The power adapter works with electrical outlets worldwide. However, power connectors and power strips vary among countries. Using an incompatible cable or improperly connecting the cable to the power strip or electrical outlet may cause fire or equipment damage.

Processors

This tablet is shipped with the following processors:

- Intel Core M3-6Y30
- Intel Core M5-6Y57

 **NOTE:** The clock speed and performance varies depending on the workload and other variables.

Identifying processors in Windows 10

1. Tap **Search the Web and Windows**.
2. Type `Device Manager`.
3. Tap **Processor**.

The basic information of the processor is displayed.



Identifying processors in Windows 8

1. Tap **Search the Web and Windows**.
2. Type `Device Manager`.
3. Tap **Processor**.

The basic information of the processor is displayed.

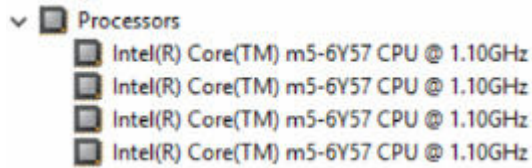

Verifying the processor usage in Task Manager

1. Press and hold the taskbar.
2. Select **Start Task Manager**.
The **Windows Task Manager** window is displayed.
3. Tap the **Performance** tab in the **Windows Task Manager** window.
The processor performance details are displayed.

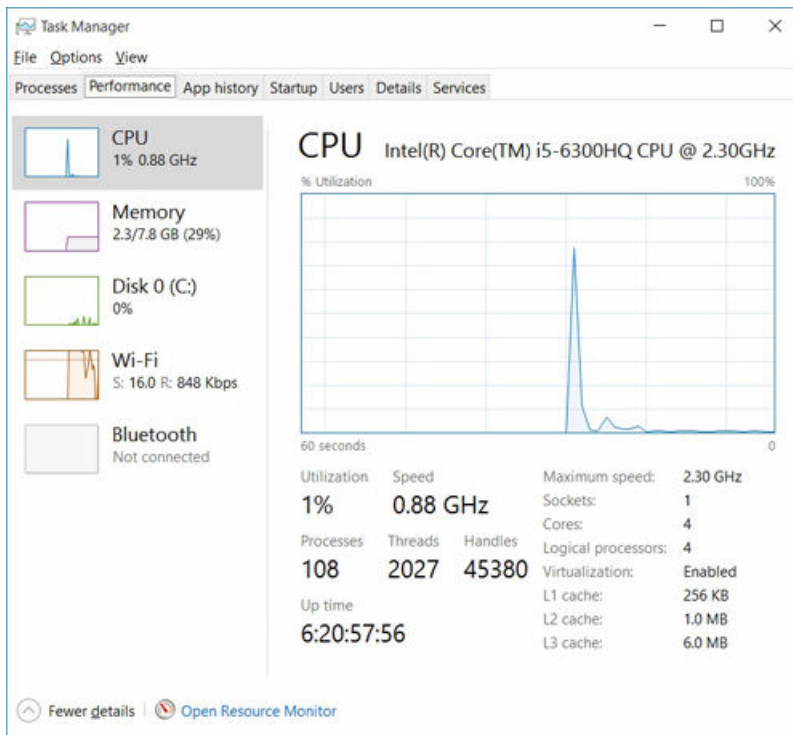

Verifying the processor usage in Resource Monitor

1. Press and hold the taskbar.
2. Select **Start Task Manager**.
The **Windows Task Manager** window is displayed.
3. Tap the **Performance** tab in the **Windows Task Manager** window.
The processor performance details are displayed.
4. Tap **Open Resource Monitor**.

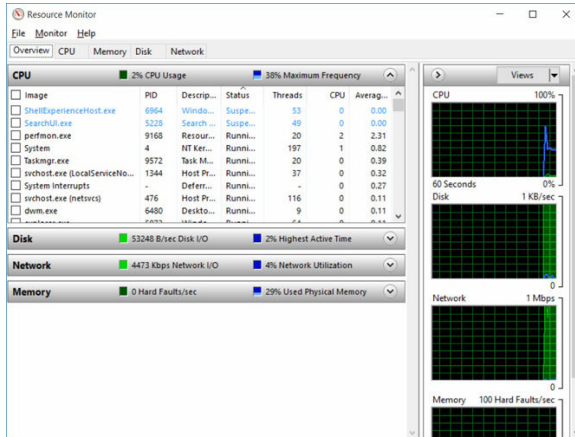

Chipsets

All tablets communicate with the CPU through the chipset. This tablet is shipped with Intel 100 Series chipset.

Downloading the chipset driver

1. Turn on the tablet.
2. Go to www.dell.com/support.
3. Tap **Product Support**, enter the Service Tag of your tablet, and then tap **Submit**.
 -  **NOTE:** If you do not have the Service Tag, use the autodetect feature or manually browse for your tablet model.
4. Tap **Drivers and Downloads**.
5. Select the operating system installed on your tablet.
6. Scroll down the page, expand **Chipset**, and select your chipset driver.
7. Tap **Download File** to download the latest version of the chipset driver for your tablet.
8. After the download is complete, navigate to the folder where you saved the driver file.
9. Double-tap the chipset driver file icon and follow the instructions on the screen.

Identifying the chipset in Device Manager on Windows 10

1. Tap **All Settings**  on the Windows 10 Charms Bar.
2. From the **Control Panel**, select **Device Manager**.
3. Expand **System Devices** and search for the chipset.

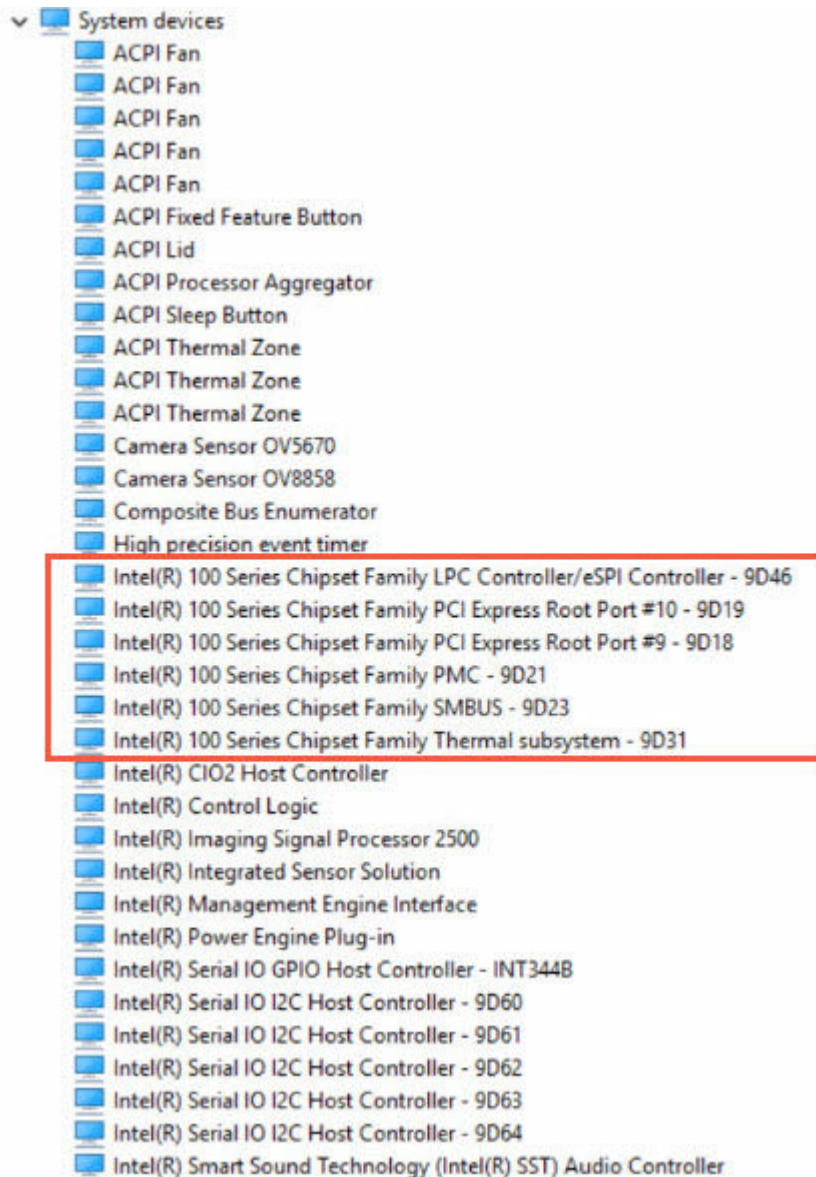

Identifying chipset in Device Manager on Windows 8

1. Tap **Settings**  on the Windows 8.1 Charms Bar.
2. From the **Control Panel**, select **Device Manager**.
3. Expand **System Devices** and search for the chipset.

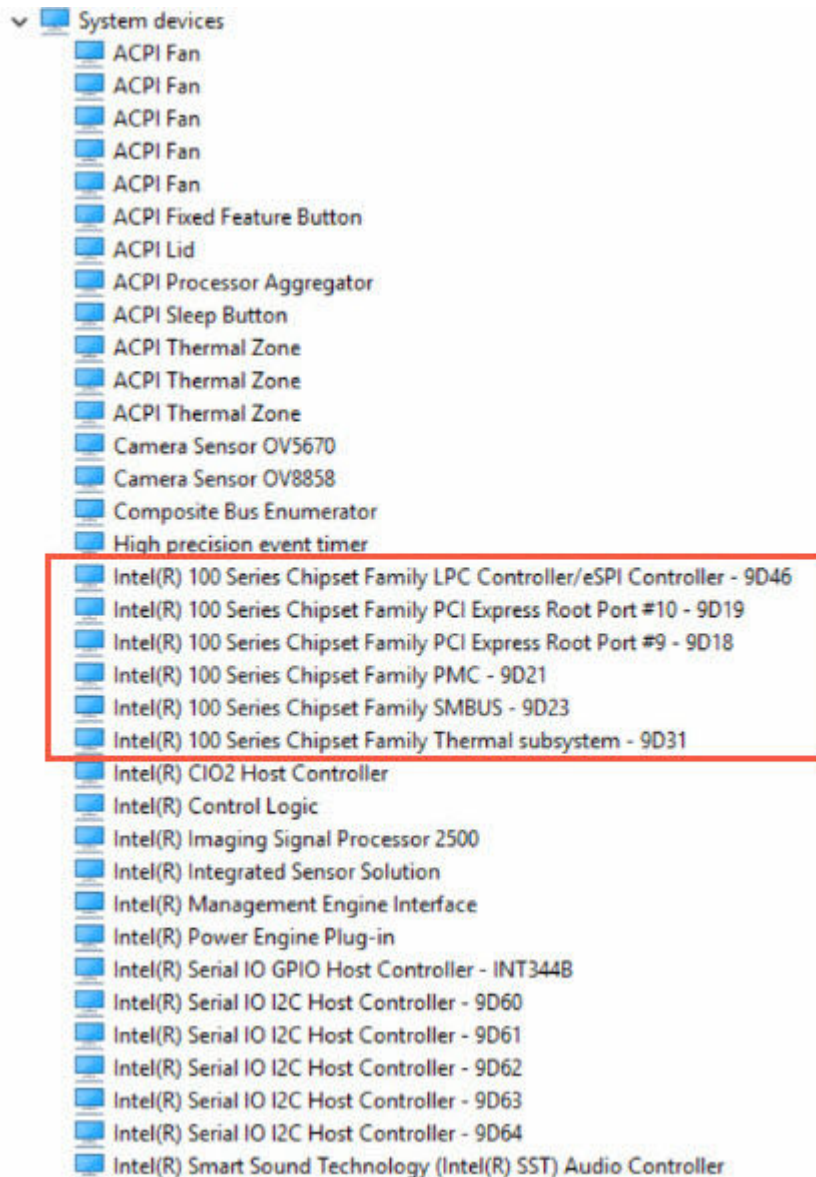

Graphic options

This tablet consists of the Intel HD Graphics 515 graphics chipset.

Downloading Driver

1. Turn on the tablet.
2. Go to www.dell.com/support.
3. Tap **Product Support**, enter the Service Tag of your tablet, and then tap **Submit**.

 **NOTE:** If you do not have the Service Tag, use the auto detect feature or manually browse for your tablet model.

4. Tap **Drivers and Downloads**.
5. Select the operating system installed on your tablet.
6. Scroll down the page and select the graphic driver to install.
7. Tap **Download File** to download the graphic driver for your tablet.
8. After the download is complete, navigate to the folder where you saved the graphic driver file.
9. Double-tap the graphic driver file icon and follow the instructions on the screen.

Identifying the display adapter

1. Start the **Search Charm** and select **Settings**.
2. Type `Device Manager` in the search box and tap **Device Manager** from the left pane.
3. Expand **Display adapters**.
The display adapters are displayed.

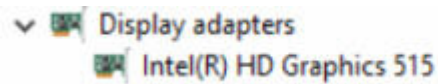

Changing the screen resolution

1. Press and hold the desktop screen and select **Display Settings**.
2. Tap **Advanced display settings**.
3. Select the required resolution from the drop-down list and tap **Apply**.

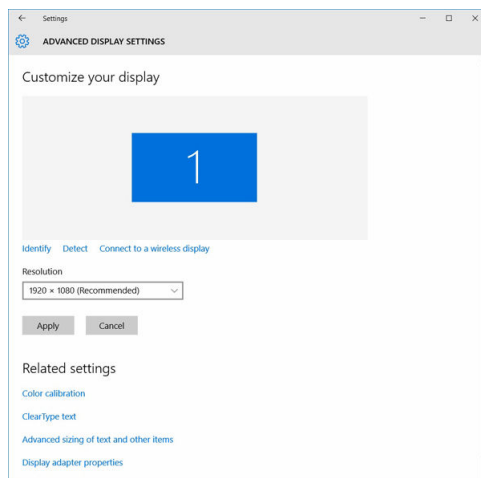

Rotating the display

1. Press and hold on the desktop screen.
A sub menu is displayed.
2. Select **Graphic Options** → **Rotation** and choose one of the following:
 - Rotate to Normal
 - Rotate to 90 Degrees
 - Rotate to 180 Degrees
 - Rotate to 270 Degrees

 **NOTE:** The Display can also be rotated using the following key combinations:

- Ctrl + Alt + Up arrow key (Rotate to normal)
- Right arrow key (Rotate 90 degrees)
- Down arrow key (Rotate 180 degrees)
- Left arrow key (Rotate 270 degrees)

Display options

This tablet has 10.8-inch FHD with 1920 x 1080 resolution (maximum).

Adjusting brightness in Windows 10

To enable or disable automatic screen brightness adjustment:

1. Swipe-in from the right edge of the display to access the Action Center.
2. Tap **All Settings**  → **System** → **Display**.
3. Use the **Adjust my screen brightness automatically** slider to enable or disable automatic-brightness adjustment.

 **NOTE:** You can also use the **Brightness level** slider to adjust the brightness manually.

Adjusting brightness in Windows 8

To enable or disable automatic screen brightness adjustment:

1. Swipe-in from the right edge of the display to access the Charms menu.
2. Tap **Settings**  → **Change PC Settings** → **PC and devices** → **Power and sleep**.
3. Use the **Adjust my screen brightness automatically** slider to enable or disable automatic-brightness adjustment.

Cleaning the display

1. Check for any smudges or areas that has to be cleaned.
2. Use a microfiber cloth to remove any obvious dust and gently brush off any dirt particles.
3. Proper cleaning kits should be used to clean and keep your display in a crisp clear pristine condition.

 **NOTE:** Never spray any cleaning solutions directly on the screen; spray it to the cleaning cloth.

4. Gently wipe the screen in a circular motion. Do not press hard on the cloth.

 **NOTE:** Do not press hard or touch the screen with your fingers or you may leave oily prints and smears.

 **NOTE:** Do not leave any liquid on the screen.

5. Remove all excess moisture as it may damage your screen.
6. Let the display dry thoroughly before you turn it on.
7. For stains that are hard to remove, repeat this procedure till the display is clean.

Using touch screen in Windows 10

Follow these steps to enable or disable the touch screen:

1. Go to the Charms Bar and tap **All Settings** .
2. Tap **Control Panel**.
3. Tap **Pen and Input Devices** in the **Control Panel**.
4. Tap the **Touch** tab.
5. Select **Use your finger as an input device** to enable the touch screen. Clear the box to disable the touch screen.

Using touch screen in Windows 8

Follow these steps to enable or disable the touch screen:

1. Go to the Charms Bar and tap **Settings** .
2. Tap **Control Panel**.
3. Tap **Pen and Input Devices** in the **Control Panel**.
4. Tap the **Touch** tab.
5. Select **Use your finger as an input device** to enable the touch screen. Clear the box to disable the touch screen.

Connecting to external display devices

Follow these steps to connect your tablet to an external display device:

1. Ensure that the projector is turned on and plug the projector cable into a video port on your tablet.
2. Press the Windows logo+P key.
3. Select one of the following modes:
 - PC screen only
 - Duplicate
 - Extend
 - Second Screen only

 **NOTE:** For more information, see the document that shipped with your display device.

Realtek ALC3266–CG Waves MaxxAudio Pro controller

This tablet ships with integrated Realtek ALC3266–CG Waves MaxxAudio Pro controller. It is a High Definition audio codec designed for Windows desktop and mobile tablets.

Downloading the audio driver

1. Turn on the tablet.
2. Go to www.dell.com/support.
3. Tap **Product Support**, enter the Service Tag of your tablet and tap **Submit**.



 **NOTE:** If you do not have the Service Tag, use the autodetect feature or manually browse for your tablet model.

4. Tap **Drivers and Downloads**.
5. Select the operating system installed on your tablet.
6. Scroll down the page and expand **Audio**.
7. Select the audio driver.
8. Tap **Download File** to download the latest version of the audio driver for your tablet.
9. After the download is complete, navigate to the folder where you saved the audio driver file.
10. Double-tap the audio driver file icon and follow the instructions on the screen.

Identifying the audio controller in Windows 10

1. Start the **Search Charm** and select **All Settings** .
2. Type `Device Manager` in the search box and select **Device Manager** from the left pane.
3. Expand **Sound, video and game controllers**.

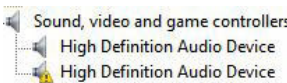

The audio controller is displayed.

Before installation	After installation
	

Identifying the audio controller in Windows 8

1. Start the **Search Charm** and select **Settings** .
2. Type `Device Manager` in the search box and select **Device Manager** from the left pane.
3. Expand **Sound, video and game controllers**.

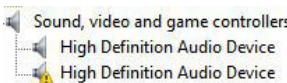
The audio controller is displayed.

Before installation	After installation
	

Changing the audio settings

1. Start the **Search Charm** and type `Dell Audio` in the search box.
2. Start the Dell Audio utility from the left pane.

WLAN cards

This tablet supports the Intel Dual Band Wireless AC 8260 WLAN card.

Downloading the WLAN driver

1. Turn on the tablet.
2. Go to www.dell.com/support.
3. Tap **Product Support**, enter the Service Tag of your tablet, and then tap **Submit**.

 **NOTE:** If you do not have the Service Tag, use the autodetect feature or manually browse for your tablet model.

4. Tap **Drivers and Downloads**.
5. Select the operating system installed on your tablet.
6. Scroll down the page, expand **Network**, and select the **WLAN** driver.

 **NOTE:** The WLAN driver varies depending on the WLAN card in the tablet.

7. After the download is complete, navigate to the folder where you saved the driver file.
8. Double-tap the **WLAN driver file** icon and follow the instructions on the screen.

Hard drive options

This tablet has the following mSATA solid-state drive options:

- 128 GB solid-state drive
- 256 GB solid-state drive
- 512 GB solid-state drive
- 256 GB self-encrypting drive

Identifying the hard drive in Windows 10

1. Tap **All Settings**  on the Windows 10 Charms Bar.
2. Tap **Control Panel**, select **Device Manager**, and expand **Disk drives**.

The hard drive is listed under **Disk drives**.



Identifying the hard drive in Windows 8

1. Tap **Settings**  on the Windows 8 Charms Bar.
2. Tap **Control Panel**, select **Device Manager**, and expand **Disk drives**.

The hard drive is listed under Disk drives.



Entering BIOS setup

1. Turn on or restart your tablet.
2. When the Dell logo appears, perform one of the following actions to enter the BIOS setup program:

- With keyboard — Tap F2 until the Entering BIOS setup message appears. To enter the Boot selection menu, tap F12.
- Without keyboard — When the **F12 boot selection** menu is displayed, press the Volume Down button to enter BIOS setup. To enter the Boot selection menu, press the Volume Up button.

Hard drive is listed under the **System Information** under the **General** group.

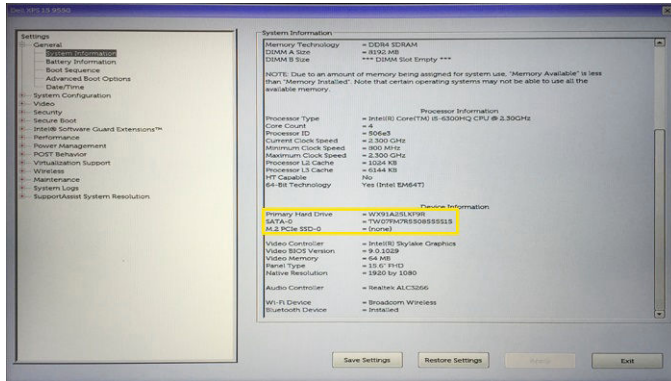

Camera features

This tablet comes with 5 MP fixed focus front-facing camera and 8 MP auto focus rear-facing camera with the image resolution of 1920 x 1080 (maximum).

 **NOTE:** On Windows 8.1 and Windows 10 tablets, Dell Webcam Central Software will not be available. Use the built-in Camera App.

Identifying the camera in Device Manager on Windows 10

1. In the **Search** box, type **device manager**, and tap to start it.
2. Under **Device Manager**, expand **Imaging devices**.



Identifying the camera in Device Manager on Windows 8

1. Start the Charms Bar from the desktop interface.
2. Select **Control Panel**.
3. Select **Device Manager** and expand **Imaging devices**.

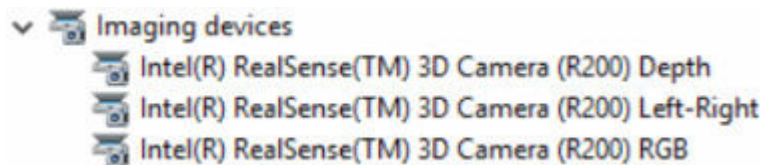

Starting the camera

To start the camera, open an application that uses the camera. For instance, if you tap the Dell webcam central software or the Skype software that is shipped with the tablet, the camera turns on. Similarly, if you are chatting on the internet and the application requests to access the webcam, the webcam turns on.

Starting the Camera App

1. Tap the **Windows** button and select **All apps**.

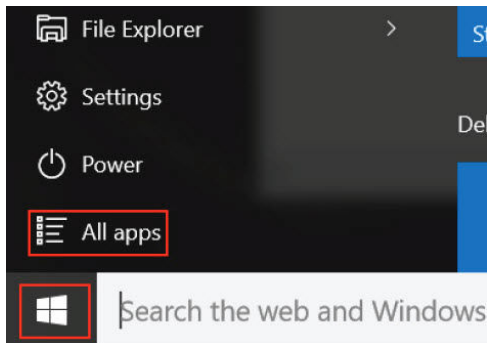

2. Select **Camera** from the apps list.

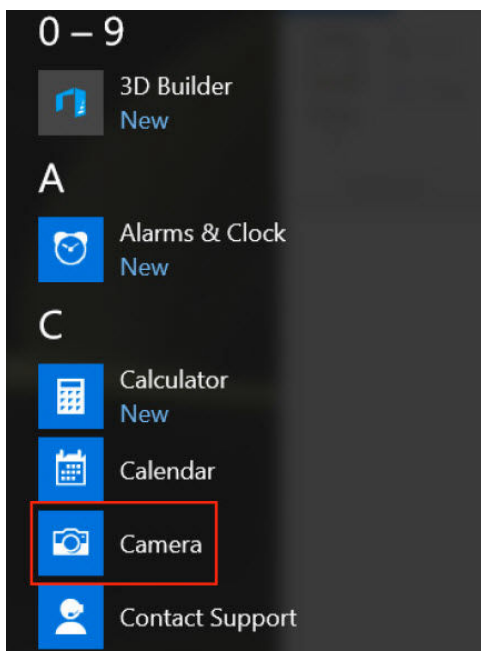

3. If the **Camera** App is not available in the apps list, search for it.

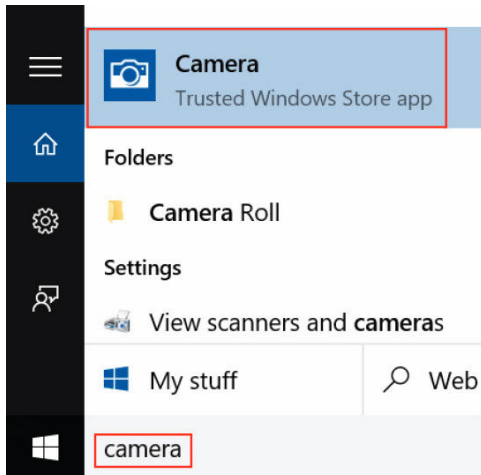

Memory features

In this tablet, the memory (RAM) is a part of the system board. This tablet supports 4 GB and 8 GB LPDDR3 memory, up to 1600 MHz.

 **NOTE:** Since memory is part of the system board, it cannot be upgraded as a separate module. If the technical support determines that the memory is the cause of an issue, replace the system board.

Verifying system memory in Windows 10

1. Tap the **Windows** button and select **All Settings**  → **System** .
2. Under **System**, tap **About**.

Verifying system memory in Windows 8

1. From your desktop, start the **Charms Bar**.
2. Select **Control Panel** and then select **System**.

Verifying system memory in setup

1. Turn on or restart your tablet.
2. Perform one of the following actions after the Dell logo is displayed:
 - With keyboard — Tap F2 until the Entering BIOS setup message appears. To enter the Boot selection menu, tap F12.
 - Without keyboard — When the **F12 boot selection** menu is displayed, press the Volume Down button to enter BIOS setup. To enter the Boot selection menu, press the Volume Up button.
3. On the left pane, select **Settings** → **General** → **System Information**,
The memory information is displayed on the right pane.

Testing memory using ePSA

1. Turn on or restart your tablet.
2. Perform one of the following actions after the Dell logo is displayed:
 - With keyboard — Press F2.
 - Without keyboard — Press and hold the **Volume Up** button when the Dell logo is displayed on the screen. When the F12 boot selection menu is displayed, select **Diagnostics** from the boot menu, and press Enter.

The PreBoot System Assessment (PSA) starts on your tablet.

 **NOTE:** If you wait too long and the operating system logo appears, continue to wait until you see the desktop. Turn off the tablet and try again.

Intel chipset drivers

Verify if the Intel chipset drivers are already installed in the tablet.

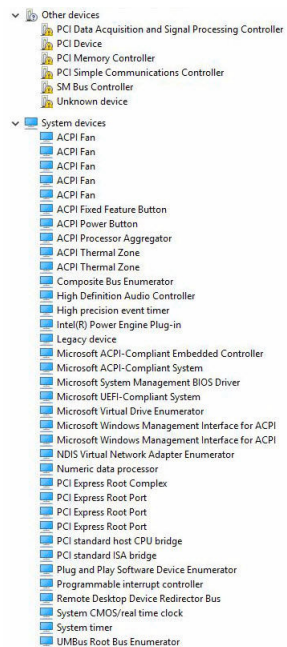
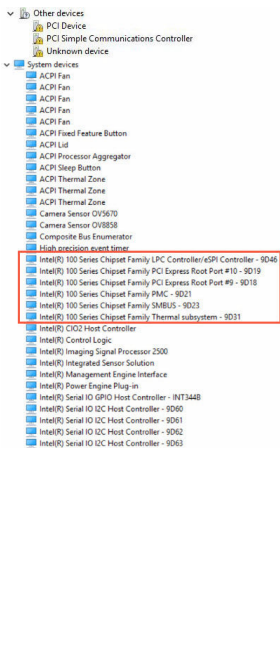
Before installation	After installation
	

Intel HD Graphics drivers

Verify if the Intel HD Graphics drivers are already installed in the tablet.

Before installation	After installation
<ul style="list-style-type: none"> Display adapters <ul style="list-style-type: none"> Microsoft Basic Display Adapter Sound, video and game controllers <ul style="list-style-type: none"> High Definition Audio Device High Definition Audio Device 	<ul style="list-style-type: none"> Display adapters <ul style="list-style-type: none"> Intel(R) HD Graphics 515 Sound, video and game controllers <ul style="list-style-type: none"> Intel(R) AVStream Camera 2500 Intel(R) Display Audio Realtek High Definition Audio(SST)

Realtek HD audio drivers

Verify if the Realtek audio drivers are already installed in the tablet.

Before installation	After installation
<ul style="list-style-type: none"> Audio inputs and outputs <ul style="list-style-type: none"> Microphone (High Definition Audio Device) Speakers (High Definition Audio Device) Sound, video and game controllers <ul style="list-style-type: none"> High Definition Audio Device Intel(R) Display Audio 	<ul style="list-style-type: none"> Audio inputs and outputs <ul style="list-style-type: none"> Microphone Array (Realtek High Definition Audio(SST)) Speakers / Headphones (Realtek High Definition Audio(SST)) Sound, video and game controllers <ul style="list-style-type: none"> Intel(R) AVStream Camera 2500 Intel(R) Display Audio Realtek High Definition Audio(SST)

Realtek RTS5242-GR Card Reader drivers

Verify if the Realtek RTS5242-GR Card Reader drivers are already installed in the tablet.

Before installation	After installation
<ul style="list-style-type: none"> Other devices <ul style="list-style-type: none"> PCI Device Unknown device 	<ul style="list-style-type: none"> Other devices <ul style="list-style-type: none"> Unknown device Memory technology devices <ul style="list-style-type: none"> Realtek PCIE CardReader

Realtek LAN network drivers

Verify if the Realtek LAN network drivers are already installed in the tablet.

Before installation	After installation
<ul style="list-style-type: none"> Network adapters <ul style="list-style-type: none"> Intel(R) Dual Band Wireless-AC 3165 	<ul style="list-style-type: none"> Network adapters <ul style="list-style-type: none"> Bluetooth Device (Personal Area Network) Bluetooth Device (RFCOMM Protocol TDI) EM7455 Intel(R) Dual Band Wireless-AC 8260

Intel Wireless 3165 WiFi and Bluetooth drivers

Verify if the Intel Wireless 3165 WiFi and Bluetooth drivers are already installed in the tablet.

Before installation

- Network adapters
 - Intel(R) Dual Band Wireless-AC 3165

After installation

- Bluetooth
 - Intel(R) Wireless Bluetooth(R)
 - Microsoft Bluetooth Enumerator
 - Microsoft Bluetooth LE Enumerator
- Network adapters
 - Bluetooth Device (Personal Area Network)
 - Bluetooth Device (RFCOMM Protocol TDI)
 - EM7455
 - Intel(R) Dual Band Wireless-AC 8260

Entering BIOS setup program

With keyboard

1. Connect your tablet to the keyboard dock or connect a USB-enabled keyboard to your tablet.
2. Press the power button to turn on your tablet.
3. When the Dell logo is displayed, press F2.

Without keyboard

1. Press the power button to turn on your tablet.
2. Press and hold the Volume Up button when the Dell logo appears on the screen.
3. When the F12 boot selection menu appears, select **BIOS Setup** using the Volume Up button.
4. Press the Volume Down button to enter BIOS setup program.

Flashing the BIOS

You may need to flash (update) the BIOS when an update is available or when you replace the system board. To flash the BIOS:

1. Turn on the tablet.
2. Go to www.dell.com/support.
3. Tap **Product Support**, enter the Service Tag of your tablet and tap **Submit**.
 **NOTE:** If you do not have the Service Tag, use the auto-detect feature or manually browse for your tablet model.
4. Tap **Drivers and downloads**.
5. Select the operating system installed on your tablet.
6. Scroll down the page and expand **BIOS**.
7. Tap **Download File** to download the latest version of the BIOS for your tablet.
8. Save the file and, once the download is complete, navigate to the folder where you saved the BIOS update file.
9. Double-tap the BIOS update file icon and follow the instructions on the screen.

Specifications

Dimensions and weight	
Thickness	8.1 mm (0.32 in.)
Width	290.9 mm (11.45 in.)
Height	192.9 mm (7.59 in.)
Weight (starting at)	0.73 kg (1.61 lb)
System information	
Processor	6th Generation Intel Core m Processor
Operating system	Windows 10 or Windows 8.1
RAM	LPDDR3
Storage	<ul style="list-style-type: none"> • 128 GB solid-state drive • 180 GB solid-state drive • 256 GB solid-state drive • 360 GB solid-state drive • 512 GB solid-state drive • 256 GB SED solid-state drive • 256 GB PCIe solid-state drive • 512 GB PCIe solid-state drive
Memory	
Type	LPDDR3
Speed	1600 MHz
Configurations supported	4 GB and 8 GB
Ports and connectors	
Audio	One headset port (headphone and microphone combo)
microSD card	One microSD-card slot
micro-SIM card	One micro SIM-card slot (optional)
Thunderbolt 3 ports (USB-C)/charging ports	Two Thunderbolt 3 ports (USB-C)/charging ports

Communications		
Wi-Fi	Dual-band 802.11ac	
Bluetooth	Bluetooth 4.1 LE	
Video controller		
Type	Intel HD graphics 515	
Display		
Type	12.5-inch full HD 12.5-inch ultra HD	
Resolution:		
FHD	1920 x 1080	
UHD	3840 x 2160	
Aspect ratio	16:9	
Brightness	360 nits	
Viewing angle	85	
Contrast ratio	1500:01	
Color depth	16.7 M	
Camera		
	Front-facing camera	Rear-facing camera
Type	5 MP - Fixed focus	8 MP - Auto focus
Resolution:		
Still image	2592 x 1944	3296 x 2520
Video	1920 x 1080 at 30 fps (maximum)	3296 x 2520 at 30 fps (maximum)
Power adapter		
Input voltage	120 VAC–240 VAC	
Input frequency	50 Hz–60 Hz	
Input current	1.30 A	
Output current	1.5 A	
Rated output voltage	20 VDC	
Temperature range:		
Operating	0°C to 40°C (32°F to 104°F)	
Storage	–40°C to 70 °C (–40°F to 158°F)	

Environmental requirements

Temperature range:

Operating	0°C to 35 °C (32°F to 95 °F)
Non-operating	-40°C to 65 °C (-40°F to 149 °F)

Relative humidity (maximum):

Operating	10% to 90% (non-condensing)
Non-operating	5% to 95% (non-condensing)

Altitude (maximum, unpressurized):

Operating	-15.20 m to 3048 m (-50 ft to 10,000 ft)
Storage	-15.20 m to 10,668 m (-50 ft to 35,000 ft)



Keyboard

Width	269.90 mm (10.63 in.)
Height	104.95 mm (4.13 in.)
Thickness	3.85 mm (0.15 in.)
Weight	0.55 kg (1.22 lb)
Type	Full-size, backlit chiclet keys with 1.9 mm key travel

Getting help and contacting Dell

Self-help resources

You can get information and help on Dell products and services using these self-help resources:

Information about Dell products and services	www.dell.com
Windows 8.1 and Windows 10	Dell Help & Support app 
Windows 10	Get started app 
Windows 8.1	Help + Tips app 
Accessing help in Windows 8, Windows 8.1, and Windows 10	In Windows search, type Help and Support , and press Enter .
Accessing help in Windows 7	Click Start → Help and Support .
Online help for operating system	www.dell.com/support/windows www.dell.com/support/linux
Troubleshooting information, user manuals, setup instructions, product specifications, technical help blogs, drivers, software updates, and so on	www.dell.com/support
Learn about your operating system, setting up and using your tablet, data backup, diagnostics, and so on.	See <i>Me and My Dell</i> at www.dell.com/support/manuals .

Contacting Dell

To contact Dell for sales, technical support, or customer service issues, see **www.dell.com/contactdell**.

 **NOTE:** Availability varies by country and product, and some services may not be available in your country.



NOTE: If you do not have an active internet connection, you can find contact information on your purchase invoice, packing slip, bill, or Dell product catalog.