

Inspiron 20

3000 Series

Service Manual

Computer Model: Inspiron 20-3059
Regulatory Model: W15B
Regulatory Type: W15B003



Notes, cautions, and warnings



NOTE: A NOTE indicates important information that helps you make better use of your computer.



CAUTION: A CAUTION indicates either potential damage to hardware or loss of data and tells you how to avoid the problem.



WARNING: A WARNING indicates a potential for property damage, personal injury, or death.

Copyright © 2015 Dell Inc. All rights reserved. This product is protected by U.S. and international copyright and intellectual property laws. Dell™ and the Dell logo are trademarks of Dell Inc. in the United States and/or other jurisdictions. All other marks and names mentioned herein may be trademarks of their respective companies.

2015 - 07

Rev. A00

Contents

Before working inside your computer.....	9
Before you begin	9
Safety instructions.....	10
Recommended tools.....	11
After working inside your computer.....	12
Technical overview.....	13
Inside view of your computer.....	13
System-board components.....	14
Removing the stand.....	16
Procedure.....	16
Replacing the stand.....	18
Procedure.....	18
Removing the optical drive.....	19
Prerequisites.....	19
Procedure.....	19
Replacing the optical drive.....	22
Procedure.....	22
Post-requisites.....	22
Removing the back cover.....	23
Prerequisites.....	23
Procedure.....	23

Replacing the back cover.....	25
Procedure.....	25
Post-requisites.....	25
Removing the hard drive.....	26
Prerequisites.....	26
Procedure.....	26
Replacing the hard drive.....	29
Procedure.....	29
Post-requisites.....	29
Removing the memory module.....	30
Prerequisites.....	30
Procedure.....	30
Replacing the memory module.....	32
Procedure.....	32
Post-requisites.....	33
Removing the wireless card.....	35
Prerequisites.....	35
Procedure.....	35
Replacing the wireless card.....	37
Procedure.....	37
Post-requisites.....	39
Removing the control-buttons board.....	40
Prerequisites.....	40
Procedure.....	40

Replacing the control-buttons board.....	42
Procedure.....	42
Post-requisites.....	42
Removing the microphone.....	43
Prerequisites.....	43
Procedure.....	43
Replacing the microphone.....	45
Procedure.....	45
Post-requisites.....	45
Removing the system-board shield.....	46
Prerequisites.....	46
Procedure.....	46
Replacing the system-board shield.....	48
Procedure.....	48
Post-requisites.....	48
Removing the camera.....	49
Prerequisites.....	49
Procedure.....	49
Replacing the camera.....	52
Procedure.....	52
Post-requisites.....	52
Removing the coin-cell battery.....	53
Prerequisites.....	53
Procedure.....	53

Replacing the coin-cell battery.....	55
Procedure.....	55
Post-requisites.....	55
Removing the fan.....	56
Prerequisites.....	56
Procedure.....	56
Replacing the fan.....	58
Procedure.....	58
Post-requisites.....	58
Removing the heat sink.....	59
Prerequisites.....	59
Procedure.....	59
Replacing the heat sink.....	61
Procedure.....	61
Post-requisites.....	61
Removing the speakers.....	62
Prerequisites.....	62
Procedure.....	62
Replacing the speakers.....	64
Procedure.....	64
Post-requisites.....	64
Removing the system board.....	65
Prerequisites.....	65
Procedure.....	65

Replacing the system board.....	68
Procedure.....	68
Post-requisites.....	68
Removing the display cable.....	69
Prerequisites.....	69
Procedure.....	69
Replacing the display cable.....	71
Procedure.....	71
Post-requisites.....	71
Removing the display assembly.....	72
Prerequisites.....	72
Procedure.....	72
Replacing the display assembly.....	76
Procedure.....	76
Post-requisites.....	76
Removing the rubber feet.....	78
Prerequisites.....	78
Procedure.....	78
Replacing the rubber feet.....	80
Procedure.....	80
Post-requisites.....	80
BIOS setup program.....	81
Overview.....	81
Entering BIOS setup program.....	81
Clearing Forgotten Passwords.....	81
Procedure.....	82
Clearing CMOS Settings.....	82

Procedure.....82





Flashing the BIOS..... 84

Before working inside your computer

 **CAUTION:** To avoid damaging the components and cards, handle them by their edges and avoid touching pins and contacts.









 **NOTE:** The images in this document may differ from your computer depending on the configuration you ordered.

Before you begin

- 1 Save and close all open files and exit all open applications.
- 2 Shut down your computer.
 - Windows 10: Click or tap **Start** →  **Power** → **Shut down**.
 - Windows 8.1: On the **Start** screen, click or tap the power icon  → **Shut down**.
 - Windows 7: Click or tap **Start** → **Shut down**.
-  **NOTE:** If you are using a different operating system, see the documentation of your operating system for shut-down instructions.
- 3 Disconnect your computer and all attached devices from their electrical outlets.
- 4 Disconnect all cables such as telephone cables, network cables and so on, from your computer.
- 5 Disconnect all attached devices and peripherals, such as keyboard, mouse, monitor, and so on, from your computer.
- 6 Remove any media card and optical disc from your computer, if applicable.
- 7 After the computer is unplugged, press and hold the power button for 5 seconds to ground the system board.
 -  **CAUTION:** Place the computer on a flat, soft and clean surface to avoid scratching the display.
- 8 Place the computer face down.

Safety instructions

Use the following safety guidelines to protect your computer from potential damage and ensure your personal safety.

-  **WARNING:** Before working inside your computer, read the safety information that shipped with your computer. For more safety best practices, see the Regulatory Compliance home page at www.dell.com/regulatory_compliance.
-  **WARNING:** Disconnect all power sources before opening the computer cover or panels. After you finish working inside the computer, replace all covers, panels, and screws before connecting to the power source.
-  **CAUTION:** To avoid damaging the computer, ensure that the work surface is flat and clean.
-  **CAUTION:** To avoid damaging the components and cards, handle them by their edges and avoid touching pins and contacts.
-  **CAUTION:** You should only perform troubleshooting and repairs as authorized or directed by the Dell technical assistance team. Damage due to servicing that is not authorized by Dell is not covered by your warranty. See the safety instructions that shipped with the product or at www.dell.com/regulatory_compliance.
-  **CAUTION:** Before touching anything inside your computer, ground yourself by touching an unpainted metal surface, such as the metal at the back of the computer. While you work, periodically touch an unpainted metal surface to dissipate static electricity, which could harm internal components.
-  **CAUTION:** When you disconnect a cable, pull on its connector or on its pull tab, not on the cable itself. Some cables have connectors with locking tabs or thumb-screws that you must disengage before disconnecting the cable. When disconnecting cables, keep them evenly aligned to avoid bending any connector pins. When connecting cables, ensure that the ports and connectors are correctly oriented and aligned.
-  **CAUTION:** Press and eject any installed card from the media-card reader.

Recommended tools

The procedures in this document may require the following tools:

- Phillips screwdriver
- Plastic scribe

After working inside your computer



CAUTION: Leaving stray or loose screws inside your computer may severely damage your computer.

- 1 Replace all screws and ensure that no stray screws remain inside your computer.
- 2 Connect any external devices, peripherals, and cables you removed before working on your computer.
- 3 Replace any media cards, discs, and any other parts that you removed before working on your computer.
- 4 Connect your computer and all attached devices to their electrical outlets.
- 5 Turn on your computer.

Technical overview

⚠ WARNING: Before working inside your computer, read the safety information that shipped with your computer and follow the steps in [Before working inside your computer](#). After working inside your computer, follow the instructions in [After working inside your computer](#). For more safety best practices, see the Regulatory Compliance home page at www.dell.com/regulatory_compliance.

Inside view of your computer

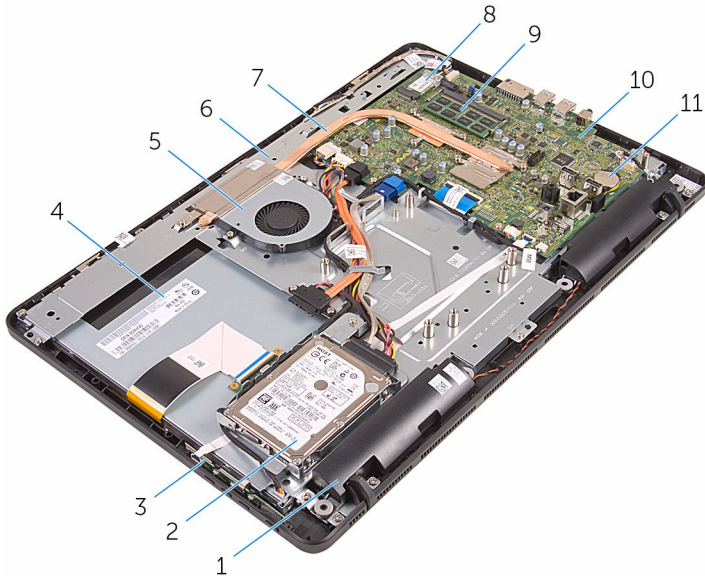

- | | | | |
|----|-----------------------|----|-----------------------|
| 1 | speakers (2) | 2 | hard-drive assembly |
| 3 | control-buttons board | 4 | display assembly |
| 5 | fan | 6 | display-assembly base |
| 7 | heat sink | 8 | wireless card |
| 9 | memory module | 10 | system board |
| 11 | coin-cell battery | | |

System-board components

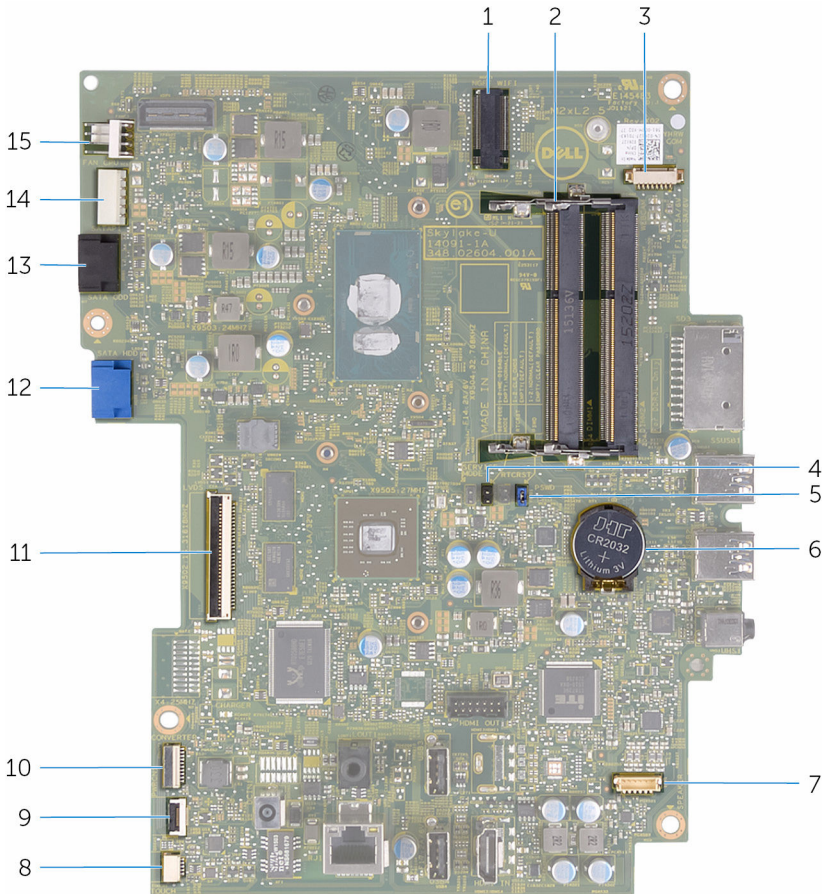

- | | | | |
|---|---------------------------------------|----|---|
| 1 | wireless-card slot (NGFF_WIFI) | 2 | memory-module slots (2) |
| 3 | camera-cable connector (WEBCAM) | 4 | CMOS jumper (CMCL R2) |
| 5 | password jumper (PSWD) | 6 | coin-cell battery |
| 7 | speaker-cable connector (SPEAKER) | 8 | touch-screen board cable connector (TOUCH) |
| 9 | control-buttons board cable connector | 10 | display-panel power cable connector (PWRCN) |

- | | | | |
|----|---|----|---|
| 11 | display-cable connector | 12 | hard-drive data cable connector (SATA_HDD) |
| 13 | optical-drive data cable connector (SATA_HDD) | 14 | hard-drive and optical-drive power cable connector (SATAP1) |
| 15 | fan-cable connector (FAN_CPU) | | |

Removing the stand

⚠ WARNING: Before working inside your computer, read the safety information that shipped with your computer and follow the steps in [Before working inside your computer](#). After working inside your computer, follow the instructions in [After working inside your computer](#). For more safety best practices, see the Regulatory Compliance home page at www.dell.com/regulatory_compliance.

Procedure

✎ NOTE: These procedures are applicable only for computers with an easel stand. If you ordered a computer with a pedestal stand, see the Quick Start Guide that shipped with your computer or on the Dell Support website.

- 1 Using a plastic scribe, pry the stand cover off the back cover.
- 2 Slide and remove the stand cover from the back cover.



1 stand cover

2 back cover

- 3 Close the stand and remove the screws that secure the stand to the back cover.

4 Slide and remove the stand from the back cover.



1 screws (2)

2 stand

Replacing the stand



WARNING: Before working inside your computer, read the safety information that shipped with your computer and follow the steps in [Before working inside your computer](#). After working inside your computer, follow the instructions in [After working inside your computer](#). For more safety best practices, see the Regulatory Compliance home page at www.dell.com/regulatory_compliance.

Procedure



NOTE: This chapter is applicable only for systems with an easel stand. For systems with a pedestal stand, refer to the Quick Start Guide that came with your computer.

- 1 Insert the tabs on the stand bracket into the slots on the back cover.
- 2 Align the screw holes on the stand with the screw holes on the back cover.
- 3 Replace the screws that secure the stand to the back cover.
- 4 Replace the stand cover.

Removing the optical drive



WARNING: Before working inside your computer, read the safety information that shipped with your computer and follow the steps in [Before working inside your computer](#). After working inside your computer, follow the instructions in [After working inside your computer](#). For more safety best practices, see the Regulatory Compliance home page at www.dell.com/regulatory_compliance.

Prerequisites

Remove the [stand](#).

Procedure

- 1 Using a plastic scribe, push the optical-drive bracket down and then push it outward.

- 2 Pull the optical-drive assembly out of the optical-drive bay.



1 optical-drive assembly

2 optical-drive bracket

3 plastic scribe

- 3 Carefully pull the optical-drive bezel and remove it from the optical drive.
- 4 Remove the screws that secure the optical-drive bracket to the optical drive.

- 5 Remove the optical-drive bracket from the optical drive.

 **NOTE:** Note the orientation of the optical-drive bracket so that you can replace it correctly.

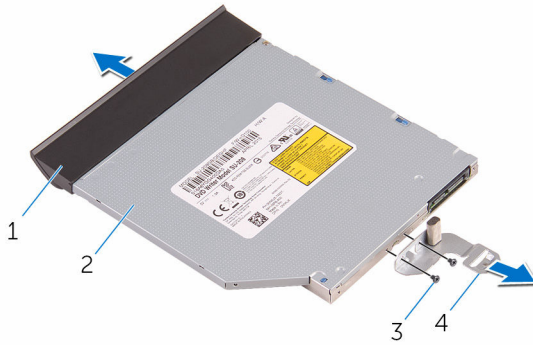

- 1 optical-drive bezel
3 screws (2)

- 2 optical drive
4 optical-drive bracket

Replacing the optical drive

 **WARNING:** Before working inside your computer, read the safety information that shipped with your computer and follow the steps in [Before working inside your computer](#). After working inside your computer, follow the instructions in [After working inside your computer](#). For more safety best practices, see the Regulatory Compliance home page at www.dell.com/regulatory_compliance.

Procedure

- 1 Align the screw holes on the optical-drive bracket with the screw holes on the optical drive.



NOTE: You must correctly align the optical-drive bracket to ensure that the optical drive can be properly secured to the computer. For correct orientation, see step 5 in "[Removing the optical drive](#)".

- 2 Replace the screws that secure the optical-drive bracket to the optical drive.
- 3 Align the tabs on the optical-drive bezel with the slots on the optical-drive assembly and snap it into place.
- 4 Slide the optical-drive assembly into the optical-drive bay and snap it into place.

Post-requisites

Replace the [stand](#).

Removing the back cover

 **WARNING:** Before working inside your computer, read the safety information that shipped with your computer and follow the steps in [Before working inside your computer](#). After working inside your computer, follow the instructions in [After working inside your computer](#). For more safety best practices, see the Regulatory Compliance home page at www.dell.com/regulatory_compliance.

Prerequisites

- 1 Remove the [stand](#).
- 2 Follow the procedure from step 1 to step 2 in "[Removing the optical drive](#)".

Procedure

 **CAUTION:** Do not remove the computer cover unless you need to install or replace internal components on your computer.

- 1 Starting from the optical-drive bay, pry off the back cover.

2 Lift the back cover off the computer.



1 back cover

Replacing the back cover



WARNING: Before working inside your computer, read the safety information that shipped with your computer and follow the steps in [Before working inside your computer](#). After working inside your computer, follow the instructions in [After working inside your computer](#). For more safety best practices, see the Regulatory Compliance home page at www.dell.com/regulatory_compliance.

Procedure

Align the tabs on the back cover with the slots on the display bezel and snap the back cover into place.





NOTE: Make sure that no cables are caught between the back cover and the display bezel.

Post-requisites

- 1 Follow the procedure in step 4 in "[Replacing the optical drive](#)".
- 2 Replace the [stand](#).

Removing the hard drive

-  **WARNING:** Before working inside your computer, read the safety information that shipped with your computer and follow the steps in [Before working inside your computer](#). After working inside your computer, follow the instructions in [After working inside your computer](#). For more safety best practices, see the Regulatory Compliance home page at www.dell.com/regulatory_compliance.
-  **CAUTION:** Hard drives are fragile. Exercise care when handling the hard drive.
-  **CAUTION:** To avoid data loss, do not remove the hard drive while the computer is in sleep or on state.

Prerequisites

- 1 Remove the [stand](#).
- 2 Follow the procedure from step 1 to step 2 in "[Removing the optical drive](#)".
- 3 Remove the [back cover](#).

Procedure

- 1 Note the routing of the touch-screen board cable and remove it from the routing guides on the hard-drive bracket.
- 2 Disconnect the hard-drive cable from the hard drive.
- 3 Remove the screw that secures the hard-drive assembly to the display-assembly base.

- 4 Slide and lift the hard-drive assembly off the display-assembly base.

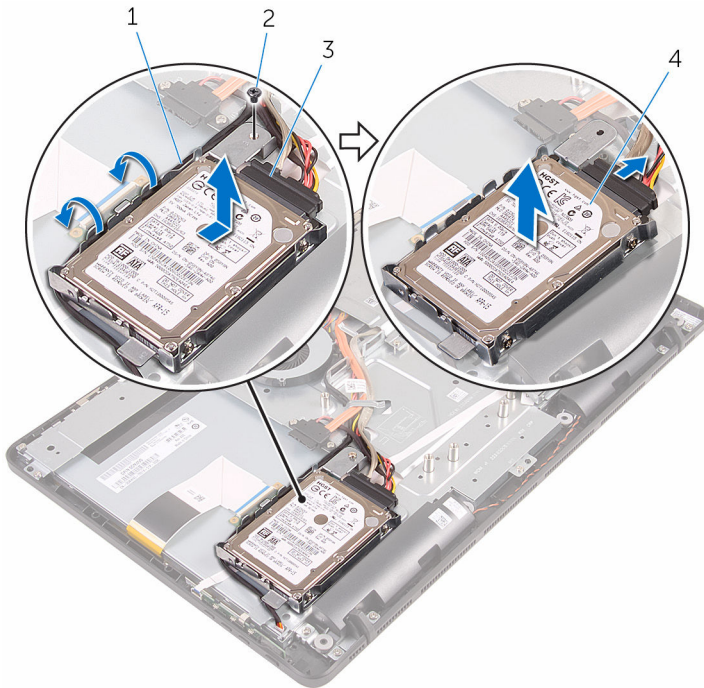

- | | | | |
|---|--------------------------|---|---------------------|
| 1 | touch-screen board cable | 2 | screw |
| 3 | hard-drive cable | 4 | hard-drive assembly |

- 5 Remove the screws that secure the hard-drive bracket to the hard drive.

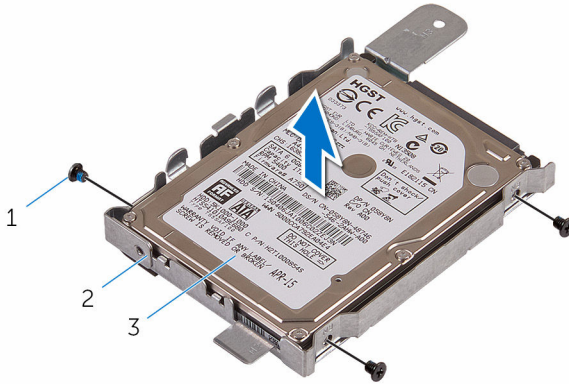

6 Remove the hard drive from the hard-drive bracket.



- 1 screws (3)
- 3 hard drive

- 2 hard-drive bracket

Replacing the hard drive

-  **WARNING:** Before working inside your computer, read the safety information that shipped with your computer and follow the steps in [Before working inside your computer](#). After working inside your computer, follow the instructions in [After working inside your computer](#). For more safety best practices, see the Regulatory Compliance home page at www.dell.com/regulatory_compliance.
-  **CAUTION:** Hard drives are fragile. Exercise care when handling the hard drive.

Procedure

- 1 Align the screw holes on the hard drive with the screw holes on the hard-drive bracket .
- 2 Replace the screws that secure the hard-drive bracket to the hard drive.
- 3 Align the tabs on the hard-drive assembly with the slots on the display-assembly base.
- 4 Slide the hard-drive assembly toward the edge of the computer to secure it to the display-assembly base.
- 5 Replace the screw that secures the hard-drive assembly to the display-assembly base.
- 6 Connect the power and data cable to the hard drive.
- 7 Route the touch-board cable through the routing guides on the hard-drive bracket.

Post-requisites

- 1 Replace the [back cover](#).
- 2 Follow the procedure in step 4 in "[Replacing the optical drive](#)".
- 3 Replace the [stand](#).

Removing the memory module



WARNING: Before working inside your computer, read the safety information that shipped with your computer and follow the steps in [Before working inside your computer](#). After working inside your computer, follow the instructions in [After working inside your computer](#). For more safety best practices, see the Regulatory Compliance home page at www.dell.com/regulatory_compliance.

Prerequisites

- 1 Remove the [stand](#).
- 2 Follow the procedure from step 1 to step 2 in "[Removing the optical drive](#)".
- 3 Remove the [back cover](#).
- 4 Remove the [system-board shield](#).

Procedure

- 1 Using your fingertips, spread apart the securing clips at each end of the memory-module slot until the memory module pops up.

2 Slide and remove the memory module from the memory-module slot.

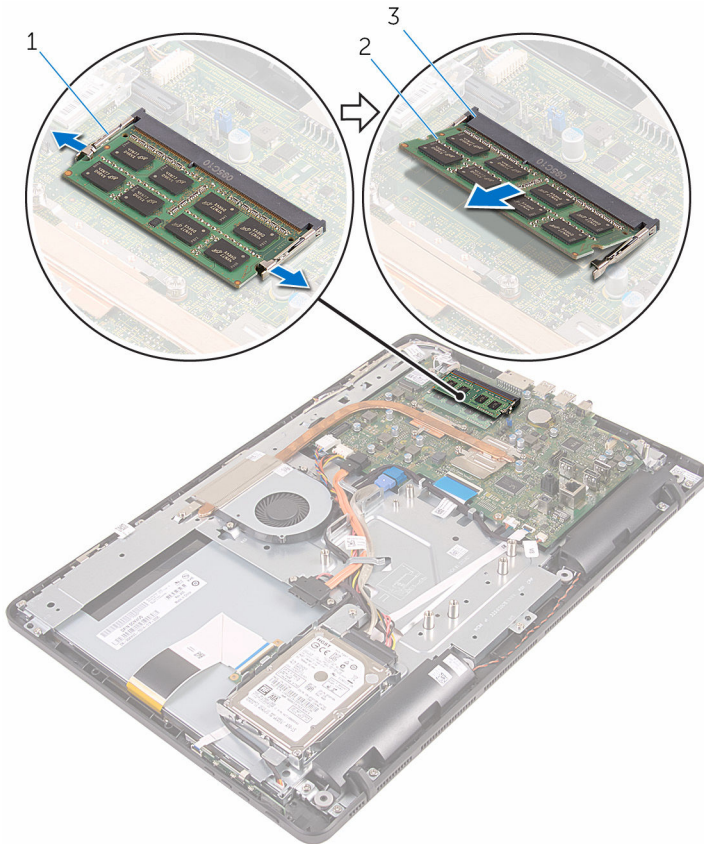

1 securing clips (2)

2 memory module

3 memory-module slot

Replacing the memory module



WARNING: Before working inside your computer, read the safety information that shipped with your computer and follow the steps in [Before working inside your computer](#). After working inside your computer, follow the instructions in [After working inside your computer](#). For more safety best practices, see the Regulatory Compliance home page at www.dell.com/regulatory_compliance.

Procedure

- 1 Align the notch on the memory module with the tab on the memory-module slot.

- Slide the memory module firmly into the slot at an angle and press the memory module down until it clicks into place.

 **NOTE:** If you do not hear the click, remove the memory module and reinstall it.

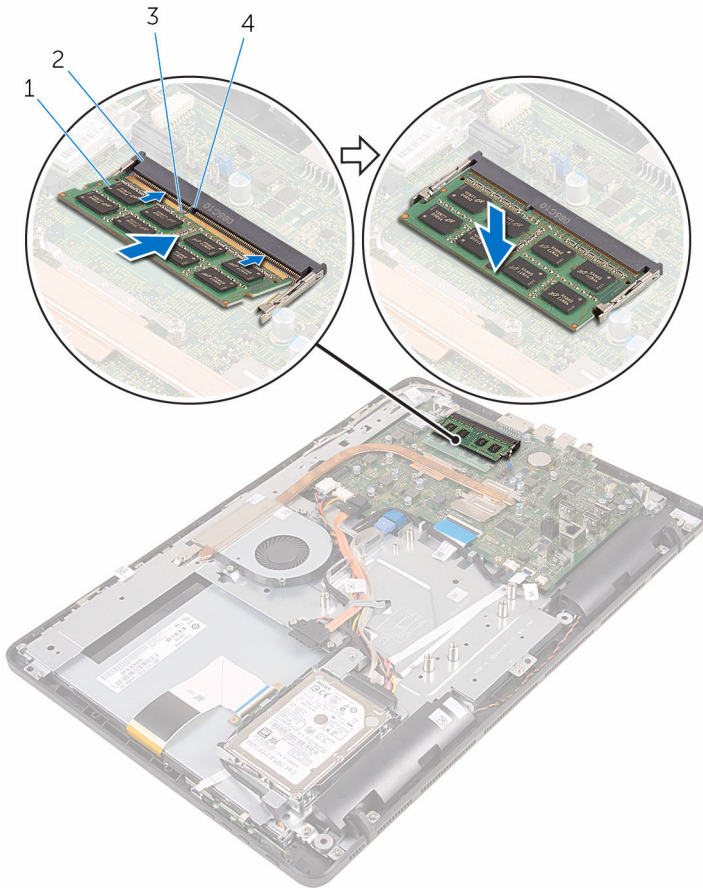

- memory module
- memory-module slot
- notch

- memory-module slot
- tab

Post-requisites

- Replace the [system-board shield](#).
- Replace the [back cover](#).

- 3 Follow the procedure in step 4 in "[Replacing the optical drive](#)".
- 4 Replace the [stand](#).

Removing the wireless card



WARNING: Before working inside your computer, read the safety information that shipped with your computer and follow the steps in [Before working inside your computer](#). After working inside your computer, follow the instructions in [After working inside your computer](#). For more safety best practices, see the Regulatory Compliance home page at www.dell.com/regulatory_compliance.

Prerequisites

- 1 Remove the [stand](#).
- 2 Follow the procedure from step 1 to step 2 in "[Removing the optical drive](#)".
- 3 Remove the [back cover](#).
- 4 Remove the [system-board shield](#).

Procedure

- 1 Remove the screw that secures the wireless card to the system board.
- 2 Disconnect the antenna cables from the wireless card.

3 Slide the wireless card out of the wireless-card slot.

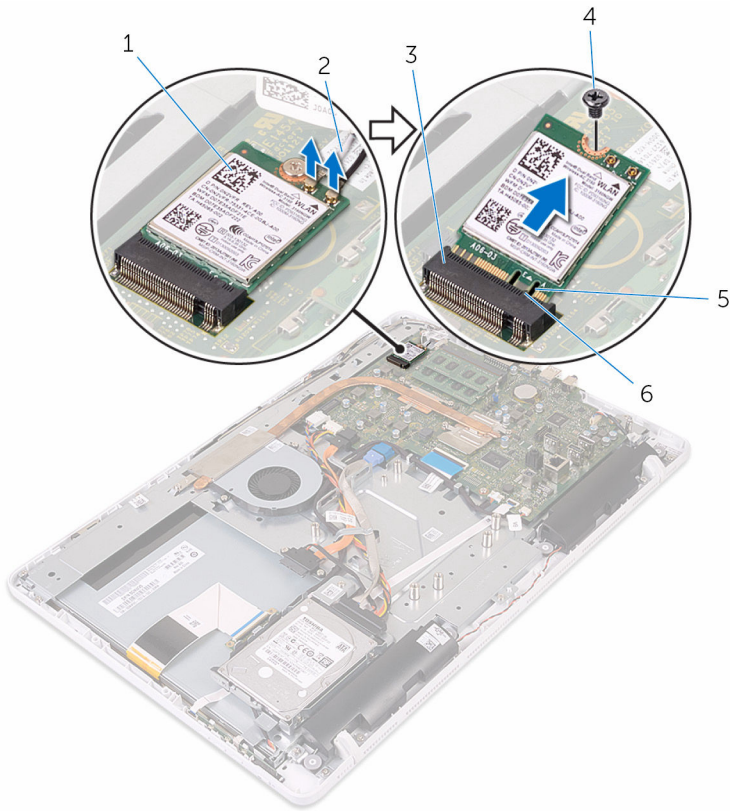

- | | | | |
|---|--------------------|---|----------------|
| 1 | wireless card | 2 | antenna cables |
| 3 | wireless-card slot | 4 | screw |

Replacing the wireless card



WARNING: Before working inside your computer, read the safety information that shipped with your computer and follow the steps in [Before working inside your computer](#). After working inside your computer, follow the instructions in [After working inside your computer](#). For more safety best practices, see the Regulatory Compliance home page at www.dell.com/regulatory_compliance.

Procedure

- 1 Align the notch on the wireless card with the tab on the wireless-card slot.
- 2 Insert the wireless card into the wireless-card slot.
- 3 Press down the other end of the wireless card and align the screw hole on the wireless card with the screw hole on the system board.
- 4 Replace the screw that secures the wireless card to the system board.

5 Connect the antenna cables to the wireless card.

The following table provides the antenna-cable color scheme for the wireless card supported by your computer:

Connectors on the wireless card	Antenna-cable color
Main (white triangle)	White
Auxiliary (black triangle)	Black

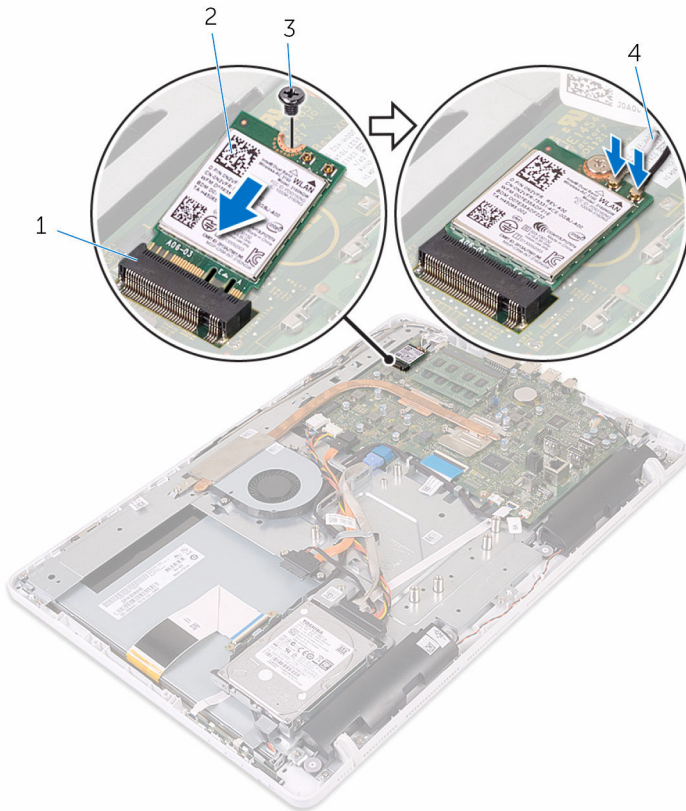

- 1 wireless-card slot
- 3 screw

- 2 wireless card
- 4 antenna cables

Post-requisites

- 1 Replace the [system-board shield](#).
- 2 Replace the [back cover](#).
- 3 Follow the procedure in step 4 in "[Replacing the optical drive](#)".
- 4 Replace the [stand](#).

Removing the control-buttons board



WARNING: Before working inside your computer, read the safety information that shipped with your computer and follow the steps in [Before working inside your computer](#). After working inside your computer, follow the instructions in [After working inside your computer](#). For more safety best practices, see the Regulatory Compliance home page at www.dell.com/regulatory_compliance.

Prerequisites

- 1 Remove the [stand](#).
- 2 Follow the procedure from step 1 to step 2 in "[Removing the optical drive](#)".
- 3 Remove the [back cover](#).

Procedure

- 1 Using your fingertips, push the securing clips on the control-buttons board slot and lift the control-buttons board off the display bezel.

- 2 Open the latch and disconnect the control-buttons board cable from the control-buttons board.

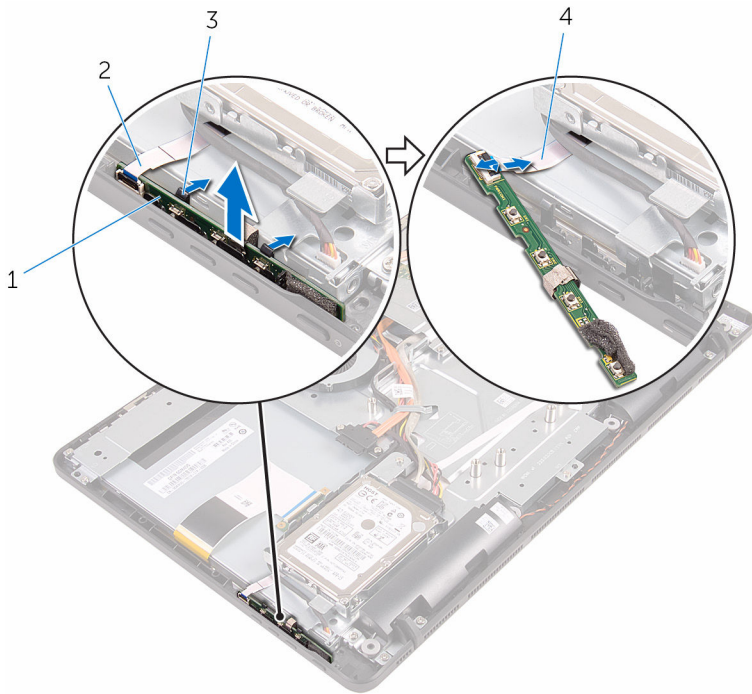

- 1 control-buttons board
3 securing clips (2)

- 2 display bezel
4 control-buttons board cable

Replacing the control-buttons board

 **WARNING:** Before working inside your computer, read the safety information that shipped with your computer and follow the steps in [Before working inside your computer](#). After working inside your computer, follow the instructions in [After working inside your computer](#). For more safety best practices, see the Regulatory Compliance home page at www.dell.com/regulatory_compliance.

Procedure

- 1 Slide the control-buttons board cable into the connector on the control-buttons board and close the latch to secure the cable.
- 2 Slide the control-buttons board into the slot on the display bezel till the securing clips lock in place.

Post-requisites

- 1 Replace the [back cover](#).
- 2 Follow the procedure in step 4 in "[Replacing the optical drive](#)".
- 3 Replace the [stand](#).

Removing the microphone



WARNING: Before working inside your computer, read the safety information that shipped with your computer and follow the steps in [Before working inside your computer](#). After working inside your computer, follow the instructions in [After working inside your computer](#). For more safety best practices, see the Regulatory Compliance home page at www.dell.com/regulatory_compliance.

Prerequisites



NOTE: These steps are applicable for touch-screen models only. For non-touch screen models, the microphone is integrated on the camera assembly.

- 1 Remove the [stand](#).
- 2 Follow the procedure from step 1 to step 2 in "[Removing the optical drive](#)".
- 3 Remove the [back cover](#).

Procedure

- 1 Lift the microphone module off the display-assembly base.

2 Disconnect the microphone cable from the microphone module.

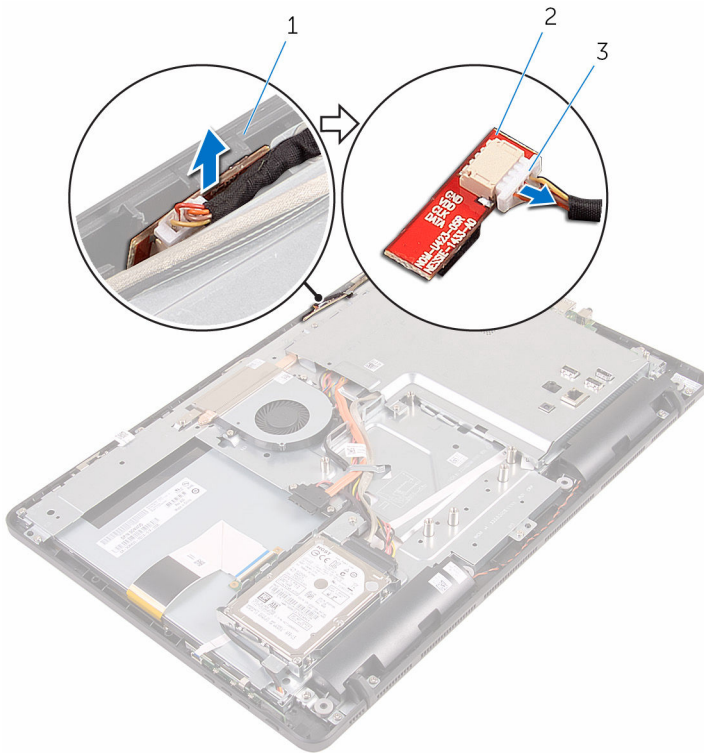

- 1 display-assembly base
- 3 microphone cable

- 2 microphone module

Replacing the microphone



WARNING: Before working inside your computer, read the safety information that shipped with your computer and follow the steps in [Before working inside your computer](#). After working inside your computer, follow the instructions in [After working inside your computer](#). For more safety best practices, see the Regulatory Compliance home page at www.dell.com/regulatory_compliance.

Procedure

- 1 Connect the microphone cable to the microphone module.
- 2 Slide the microphone module into the slot on the display-assembly base.

Post-requisites

- 1 Replace the [back cover](#).
- 2 Follow the procedure in step 4 in "[Replacing the optical drive](#)".
- 3 Replace the [stand](#).

Removing the system-board shield

 **WARNING:** Before working inside your computer, read the safety information that shipped with your computer and follow the steps in [Before working inside your computer](#). After working inside your computer, follow the instructions in [After working inside your computer](#). For more safety best practices, see the Regulatory Compliance home page at www.dell.com/regulatory_compliance.

Prerequisites

- 1 Remove the [stand](#).
- 2 Follow the procedure from step 1 to step 2 in "[Removing the optical drive](#)".
- 3 Remove the [back cover](#).

Procedure

- 1 Remove the screws that secure the system-board shield to the display-assembly base.

2 Lift the system-board shield off the display-assembly base.

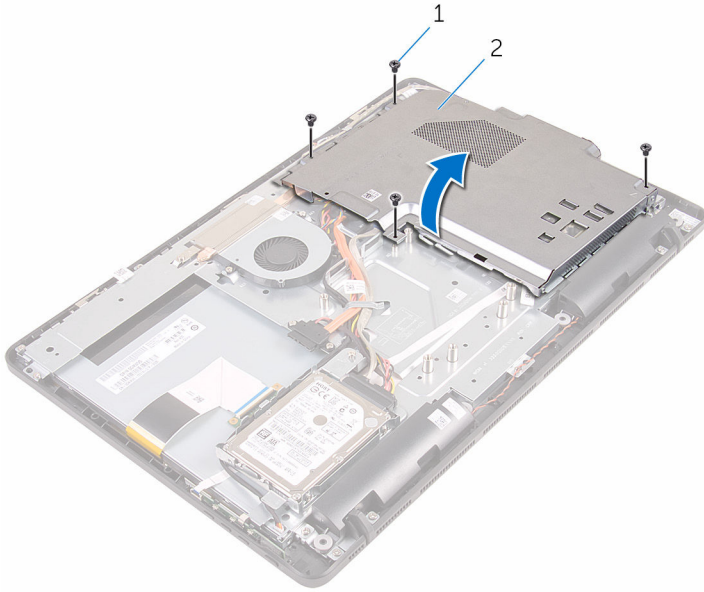

1 screws (4)

2 system-board shield

Replacing the system-board shield

 **WARNING:** Before working inside your computer, read the safety information that shipped with your computer and follow the steps in [Before working inside your computer](#). After working inside your computer, follow the instructions in [After working inside your computer](#). For more safety best practices, see the Regulatory Compliance home page at www.dell.com/regulatory_compliance.

Procedure

- 1 Align the slots on the system-board shield with the ports on the system board and place the system-board shield on the display-assembly base.
- 2 Align the screw holes on the system-board shield with the screw holes on the display-assembly base.
- 3 Replace the screws that secure the system-board shield to the display-assembly base.

Post-requisites

- 1 Replace the [back cover](#).
- 2 Follow the procedure in step 4 in "[Replacing the optical drive](#)".
- 3 Replace the [stand](#).

Removing the camera



WARNING: Before working inside your computer, read the safety information that shipped with your computer and follow the steps in [Before working inside your computer](#). After working inside your computer, follow the instructions in [After working inside your computer](#). For more safety best practices, see the Regulatory Compliance home page at www.dell.com/regulatory_compliance.

Prerequisites



NOTE: This chapter is applicable only for systems with a touch screen display. For systems with a non-touch screen display, the microphones will be integrated on the camera assembly.

- 1 Remove the [stand](#).
- 2 Follow the procedure from step 1 to step 2 in "[Removing the optical drive](#)".
- 3 Remove the [back cover](#).
- 4 Remove the [system-board shield](#).

Procedure

- 1 Disconnect the microphone and camera cable from the system board.
- 2 Note the routing of the camera cable and remove it from the routing guides and tab on the display-assembly base.
- 3 Note the routing of the antenna cable and remove it from the tab on the display-assembly base.

- 4 Remove the camera cable from the tab on the back of the camera frame.

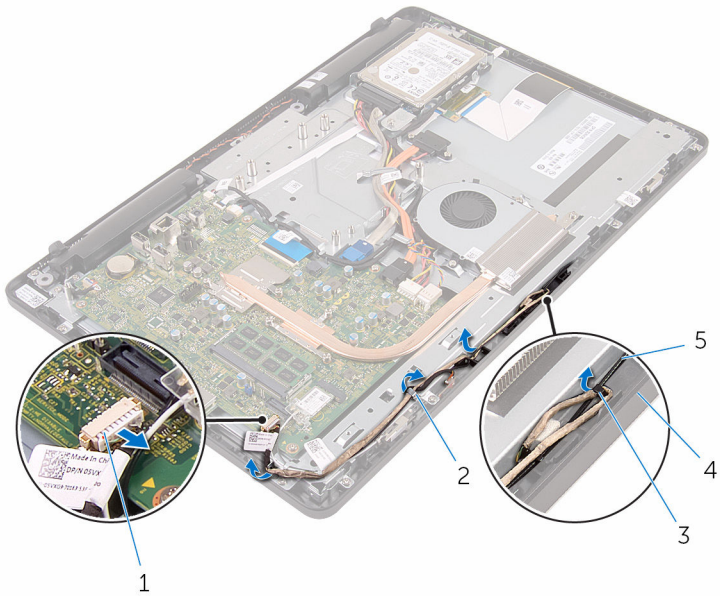

- | | | | |
|---|-----------------------------|---|-----------------------|
| 1 | microphone and camera cable | 2 | routing guides |
| 3 | tab | 4 | display-assembly base |
| 5 | antenna cable | | |

- 5 Using your fingertips, push the securing clip and turn the camera over.
6 Disconnect the camera cable from the camera.

- 7** Release the camera frame from the tab on the display-assembly base and lift it off.

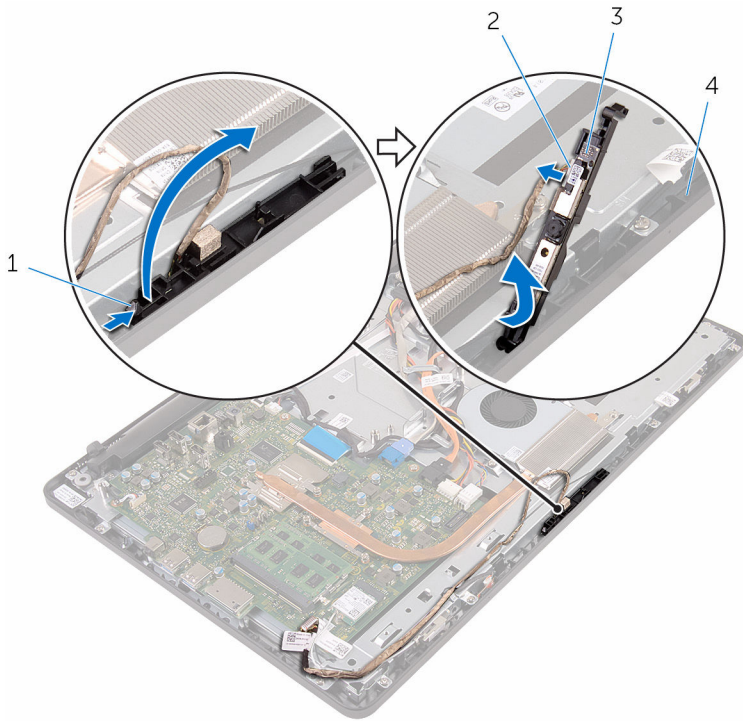

1 securing clip

2 camera cable

3 camera frame

4 display-assembly base

- 8** Peel off the camera from the camera frame.

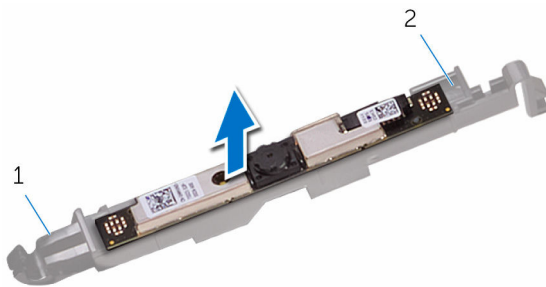

1 tab

2 camera frame

Replacing the camera



WARNING: Before working inside your computer, read the safety information that shipped with your computer and follow the steps in [Before working inside your computer](#). After working inside your computer, follow the instructions in [After working inside your computer](#). For more safety best practices, see the Regulatory Compliance home page at www.dell.com/regulatory_compliance.



Procedure

- 1 Adhere the camera to the camera frame.
- 2 Connect the camera cable to the camera module.
- 3 Press the camera frame down into the slot on the display bezel until it snaps into place.
- 4 Route the camera cable and antenna cable through the routing guides on the display-assembly base.
- 5 Connect the microphone and camera cable to the system board.

Post-requisites

- 1 Replace the [system-board shield](#).
- 2 Replace the [back cover](#).
- 3 Follow the procedure in step 4 in "[Replacing the optical drive](#)".
- 4 Replace the [stand](#).

Removing the coin-cell battery

-  **WARNING:** Before working inside your computer, read the safety information that shipped with your computer and follow the steps in [Before working inside your computer](#). After working inside your computer, follow the instructions in [After working inside your computer](#). For more safety best practices, see the Regulatory Compliance home page at www.dell.com/regulatory_compliance.
-  **CAUTION:** Removing the coin-cell battery resets the BIOS setup program's settings to default. It is recommended that you note the BIOS setup program's settings before removing the coin-cell battery.

Prerequisites

- 1 Remove the [stand](#).
- 2 Follow the procedure from step 1 to step 2 in "[Removing the optical drive](#)".
- 3 Remove the [back cover](#).
- 4 Remove the [system-board shield](#).

Procedure

Using a plastic scribe, gently pry out the coin-cell battery out of the battery socket on the system board.

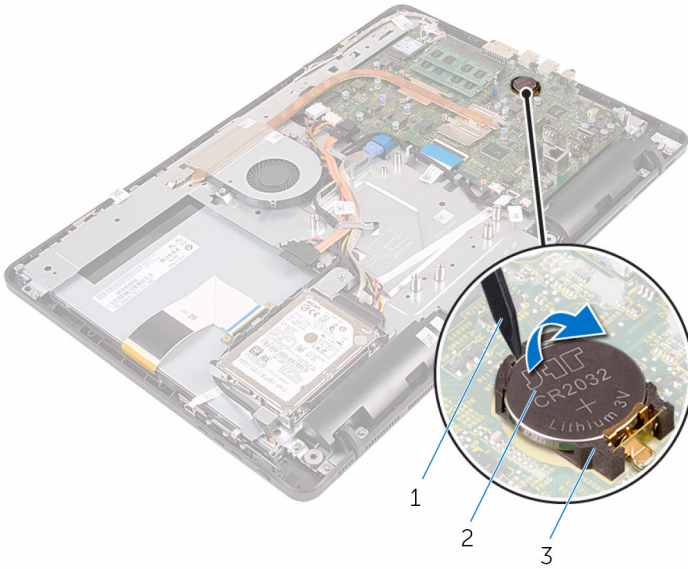

- 1 plastic scribe
- 3 battery socket

- 2 coin-cell battery

Replacing the coin-cell battery



WARNING: Before working inside your computer, read the safety information that shipped with your computer and follow the steps in [Before working inside your computer](#). After working inside your computer, follow the instructions in [After working inside your computer](#). For more safety best practices, see the Regulatory Compliance home page at www.dell.com/regulatory_compliance.

Procedure

With the positive-side facing up, insert the coin-cell battery into the battery socket and press down the battery into place.

Post-requisites

- 1 Replace the [system-board shield](#).
- 2 Replace the [back cover](#).
- 3 Follow the procedure in step 4 in "[Replacing the optical drive](#)".
- 4 Replace the [stand](#).

Removing the fan



WARNING: Before working inside your computer, read the safety information that shipped with your computer and follow the steps in [Before working inside your computer](#). After working inside your computer, follow the instructions in [After working inside your computer](#). For more safety best practices, see the Regulatory Compliance home page at www.dell.com/regulatory_compliance.

Prerequisites

- 1 Remove the [stand](#).
- 2 Follow the procedure from step 1 to step 2 in "[Removing the optical drive](#)".
- 3 Remove the [back cover](#).
- 4 Remove the [system-board shield](#).

Procedure

- 1 Disconnect the fan cable from the system board.
- 2 Remove the screws that secure the fan to the display-assembly base.

3 Lift and slide the fan from under the heat sink.

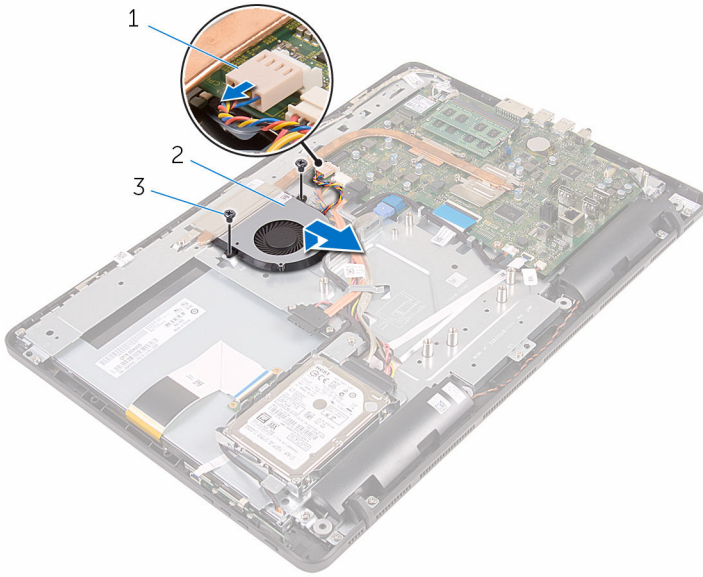

1 fan cable
3 screws (2)

2 fan

Replacing the fan



WARNING: Before working inside your computer, read the safety information that shipped with your computer and follow the steps in [Before working inside your computer](#). After working inside your computer, follow the instructions in [After working inside your computer](#). For more safety best practices, see the Regulatory Compliance home page at www.dell.com/regulatory_compliance.



Procedure

- 1 Slide the fan under the heat sink and place it on the display-assembly base.
- 2 Align the screw holes on the fan with the screw holes on the display-assembly base.
- 3 Replace the screws that secure the fan to the display-assembly base.
- 4 Connect the fan cable to the system board.

Post-requisites

- 1 Replace the [system-board shield](#).
- 2 Replace the [back cover](#).
- 3 Follow the procedure in step 4 in "[Replacing the optical drive](#)".
- 4 Replace the [stand](#).

Removing the heat sink

-  **WARNING:** Before working inside your computer, read the safety information that shipped with your computer and follow the steps in [Before working inside your computer](#). After working inside your computer, follow the instructions in [After working inside your computer](#). For more safety best practices, see the Regulatory Compliance home page at www.dell.com/regulatory_compliance.
-  **WARNING:** The heat sink may become hot during normal operation. Allow sufficient time for the heat sink to cool before you touch it.
-  **CAUTION:** For maximum cooling of the processor, do not touch the heat transfer areas on the heat sink. The oils in your skin can reduce the heat transfer capability of the thermal grease.

Prerequisites

- 1 Remove the [stand](#).
- 2 Follow the procedure from step 1 to step 2 in "[Removing the optical drive](#)".
- 3 Remove the [back cover](#).
- 4 Remove the [system-board shield](#).

Procedure

- 1 Remove the screw that secures the heat sink to the display-assembly base.
- 2 In sequential order (as indicated on the heat sink), loosen the captive screws that secure the heat sink to the system board.

3 Lift the heat sink off the system board.

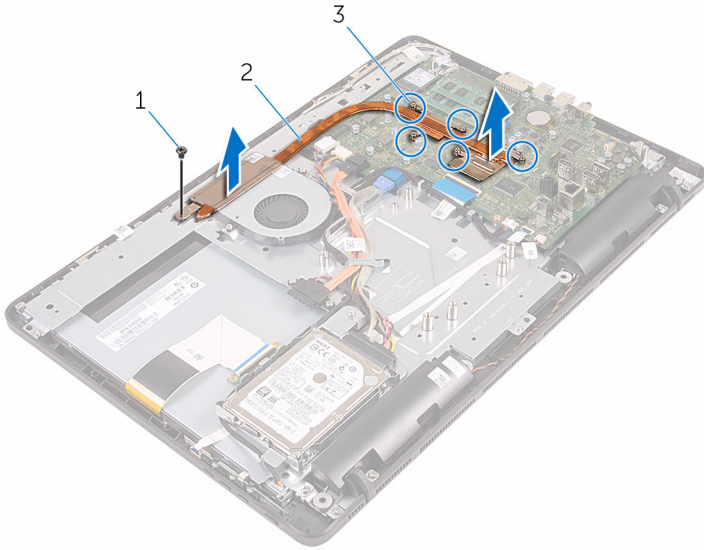

1 screw

2 heat sink

3 captive screws (5)

Replacing the heat sink

 **WARNING:** Before working inside your computer, read the safety information that shipped with your computer and follow the steps in [Before working inside your computer](#). After working inside your computer, follow the instructions in [After working inside your computer](#). For more safety best practices, see the Regulatory Compliance home page at www.dell.com/regulatory_compliance.

 **CAUTION:** Incorrect alignment of the heat sink can damage the system board and processor.

 **NOTE:** The original thermal grease can be reused if the original system board and heat sink are reinstalled together. If either the system board or the heat sink is replaced, use the thermal pad provided in the kit to ensure that thermal conductivity is achieved.

Procedure

- 1 Align the captive screws on the heat sink with the screw holes on the system board.
- 2 In sequential order (as indicated on the heat sink), tighten the captive screws that secure the heat sink to the system board.
- 3 Replace the screw that secures the heat sink to the display-assembly base.

Post-requisites

- 1 Replace the [system-board shield](#).
- 2 Replace the [back cover](#).
- 3 Follow the procedure in step 4 in "[Replacing the optical drive](#)".
- 4 Replace the [stand](#).

Removing the speakers



WARNING: Before working inside your computer, read the safety information that shipped with your computer and follow the steps in [Before working inside your computer](#). After working inside your computer, follow the instructions in [After working inside your computer](#). For more safety best practices, see the Regulatory Compliance home page at www.dell.com/regulatory_compliance.

Prerequisites

- 1 Remove the [stand](#).
- 2 Follow the procedure from step 1 to step 2 in "[Removing the optical drive](#)".
- 3 Remove the [back cover](#).
- 4 Remove the [system-board shield](#).

Procedure

- 1 Disconnect the speaker cable from the system board.
- 2 Note the routing of the speaker cable and the position of the rubber grommets on the computer bezel.

3 Lift the speakers, along with the speaker cable, off the display bezel.

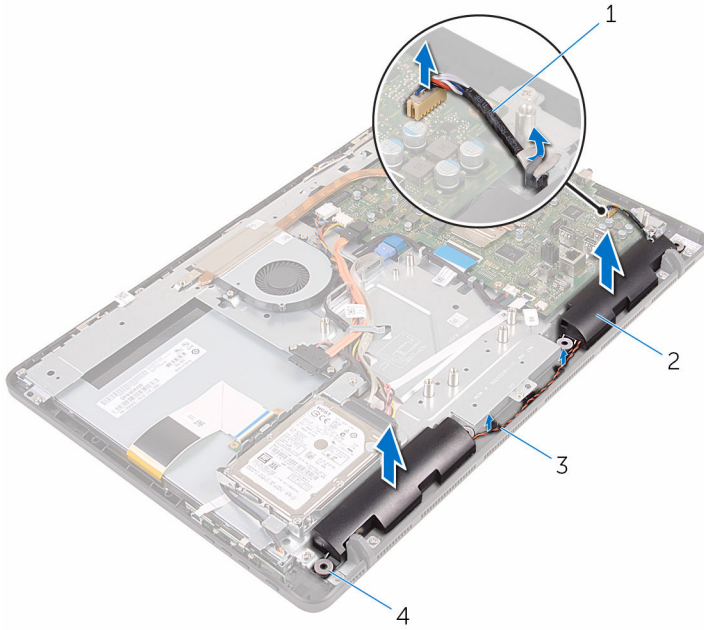

- 1 speaker cable
- 3 routing guides

- 2 speakers (2)
- 4 rubber grommets (4)

Replacing the speakers



WARNING: Before working inside your computer, read the safety information that shipped with your computer and follow the steps in [Before working inside your computer](#). After working inside your computer, follow the instructions in [After working inside your computer](#). For more safety best practices, see the Regulatory Compliance home page at www.dell.com/regulatory_compliance.

Procedure

- 1 Using the alignment posts and rubber grommets on the display bezel, place the speakers on the display bezel.
- 2 Route the speaker cable through the routing guides on the display bezel and the display-panel base.
- 3 Connect the speaker cable to the system board.

Post-requisites

- 1 Replace the [system-board shield](#).
- 2 Replace the [back cover](#).
- 3 Follow the procedure in step 4 in "[Replacing the optical drive](#)".
- 4 Replace the [stand](#).

Removing the system board



WARNING: Before working inside your computer, read the safety information that shipped with your computer and follow the steps in [Before working inside your computer](#). After working inside your computer, follow the instructions in [After working inside your computer](#). For more safety best practices, see the Regulatory Compliance home page at www.dell.com/regulatory_compliance.



NOTE: Your computer's Service Tag is stored in the system board. You must enter the Service Tag in the BIOS setup program after you replace the system board.



NOTE: Replacing the system board removes any changes you have made to the BIOS using the BIOS setup program. You must make the desired changes again after you replace the system board.



NOTE: Before disconnecting the cables from the system board, note the location of the connectors so that you can reconnect the cables correctly after you replace the system board.

Prerequisites

- 1 Remove the [stand](#).
- 2 Follow the procedure from step 1 to step 2 in "[Removing the optical drive](#)".
- 3 Remove the [back cover](#).
- 4 Remove the [system-board shield](#).
- 5 Remove the [heat sink](#).
- 6 Remove the [memory module](#).
- 7 Remove the [wireless card](#).

Procedure

- 1 Disconnect the fan cable, hard-drive and optical-drive power cable, optical-drive data cable, hard-drive data cable, microphone and camera cable, speaker cable, display-panel power cable, and touch-board cable from the system board.

- 2 Open the latches and disconnect the control-buttons board cable and display cable from the system board.

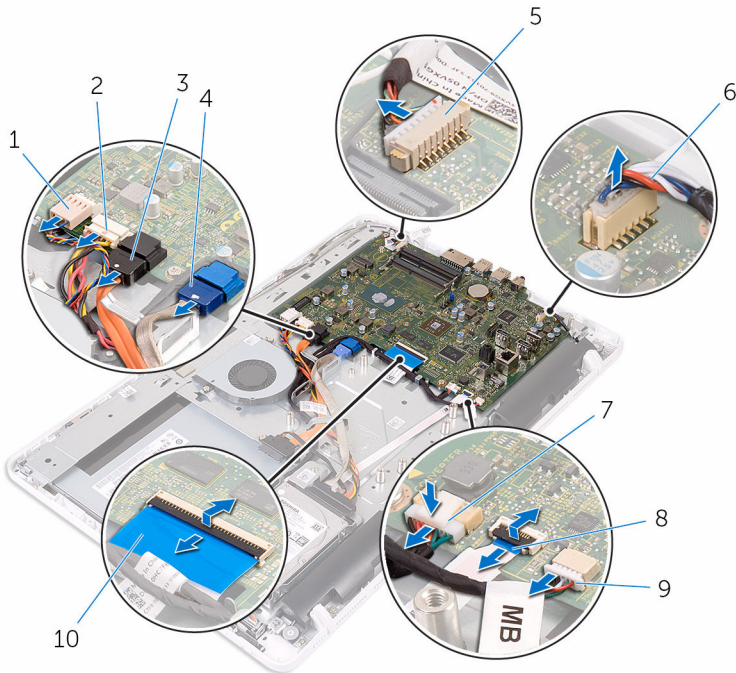

- | | | | |
|---|-----------------------------|----|--|
| 1 | fan cable | 2 | hard-drive and optical-drive power cable |
| 3 | optical-drive data cable | 4 | hard-drive data cable |
| 5 | microphone and camera cable | 6 | speaker cable |
| 7 | display-panel power cable | 8 | control-buttons board cable |
| 9 | touch-board cable | 10 | display cable |

 **NOTE:** The touch-board cable is not available on the non-touch systems.

- 3 Remove the screws that secure the system board to the display-assembly base.

4 Lift the system board off the display-assembly base.

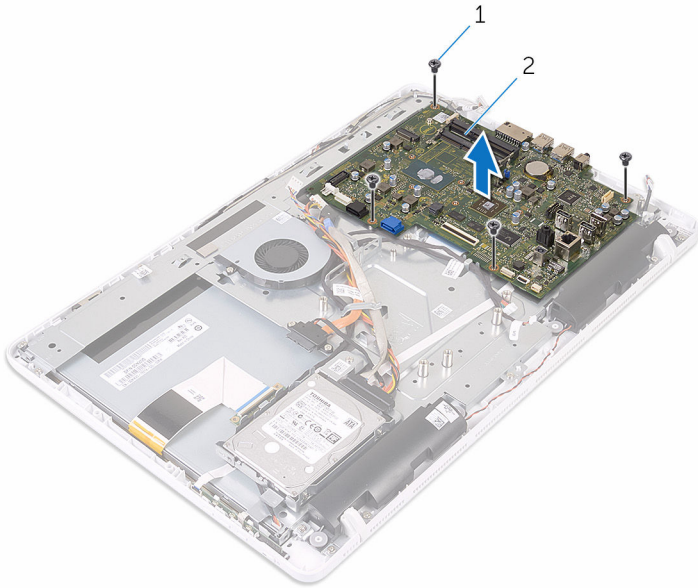

1 screws (4)

2 system board

Replacing the system board



WARNING: Before working inside your computer, read the safety information that shipped with your computer and follow the steps in [Before working inside your computer](#). After working inside your computer, follow the instructions in [After working inside your computer](#). For more safety best practices, see the Regulatory Compliance home page at www.dell.com/regulatory_compliance.



NOTE: Your computer's Service Tag is stored in the system board. You must enter the Service Tag in the BIOS setup program after you replace the system board.



NOTE: Replacing the system board removes any changes you have made to the BIOS using the BIOS setup program. You must make the desired changes again after you replace the system board.

Procedure

- 1 Align the screw holes on the system board with the screw holes on the display-assembly base.
- 2 Replace the screws that secure the system board to the display-assembly base.
- 3 Slide the control-buttons board and display cables into its connectors on the system board and close the latches to secure the cables.
- 4 Connect the touch-board cable, display-panel power cable, speaker cable, microphone and camera cable, hard-drive data cable, optical-drive data cable, hard-drive and optical-drive power cable, and fan cable to the system board.

Post-requisites

- 1 Replace the [wireless card](#).
- 2 Replace the [memory module](#).
- 3 Replace the [heat sink](#).
- 4 Replace the [system-board shield](#).
- 5 Replace the [back cover](#).
- 6 Follow the procedure in step 4 in "[Replacing the optical drive](#)".
- 7 Replace the [stand](#).

Removing the display cable



WARNING: Before working inside your computer, read the safety information that shipped with your computer and follow the steps in [Before working inside your computer](#). After working inside your computer, follow the instructions in [After working inside your computer](#). For more safety best practices, see the Regulatory Compliance home page at www.dell.com/regulatory_compliance.

Prerequisites

- 1 Remove the [stand](#).
- 2 Follow the procedure from step 1 to step 2 in "[Removing the optical drive](#)".
- 3 Remove the [back cover](#).
- 4 Remove the [memory module](#).
- 5 Remove the [wireless card](#).
- 6 Remove the [control-buttons board](#).
- 7 Remove the [microphone](#).
- 8 Remove the [system-board shield](#).
- 9 Remove the [heat sink](#).
- 10 Remove the [system board](#).

Procedure

- 1 Peel off the tape that secures the display cable to the display assembly.
- 2 Press the clips and disconnect the display cable from the display assembly.

3 Lift the display cable off the display assembly.

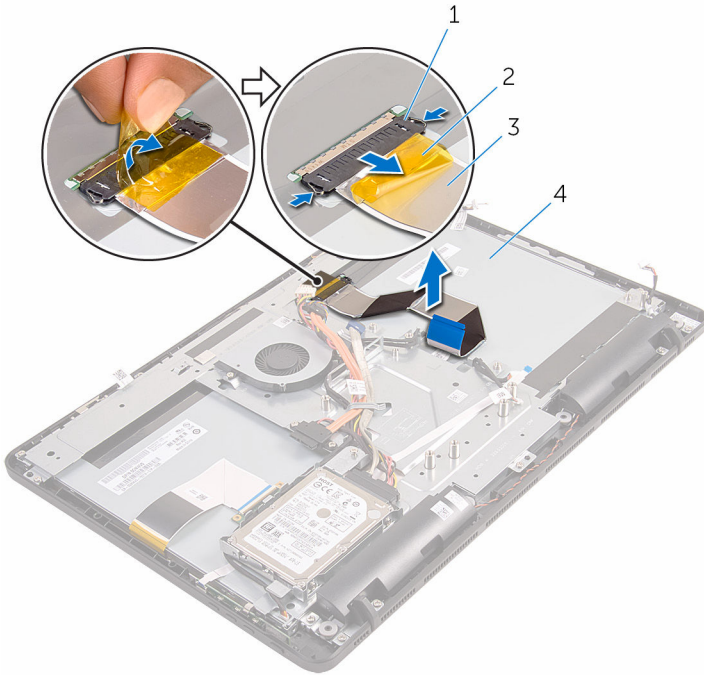

1 clips (2)

2 tape

3 display cable

4 display assembly

Replacing the display cable



WARNING: Before working inside your computer, read the safety information that shipped with your computer and follow the steps in [Before working inside your computer](#). After working inside your computer, follow the instructions in [After working inside your computer](#). For more safety best practices, see the Regulatory Compliance home page at www.dell.com/regulatory_compliance.

Procedure

- 1 Connect the display cable to the display assembly and close the latch to secure the cable.
- 2 Adhere the tape that secures the display cable to the display assembly.

Post-requisites

- 1 Replace the [system board](#).
- 2 Replace the [heat sink](#).
- 3 Replace the [system-board shield](#).
- 4 Replace the [microphone](#).
- 5 Replace the [control-buttons board](#).
- 6 Replace the [wireless card](#).
- 7 Replace the [memory module](#).
- 8 Replace the [back cover](#).
- 9 Follow the procedure in step 4 in "[Replacing the optical drive](#)".
- 10 Replace the [stand](#).

Removing the display assembly

 **WARNING:** Before working inside your computer, read the safety information that shipped with your computer and follow the steps in [Before working inside your computer](#). After working inside your computer, follow the instructions in [After working inside your computer](#). For more safety best practices, see the Regulatory Compliance home page at www.dell.com/regulatory_compliance.

Prerequisites

- 1 Remove the [stand](#).
- 2 Follow the procedure from step 1 to step 2 in "[Removing the optical drive](#)".
- 3 Remove the [back cover](#).
- 4 Follow the procedure from step 1 to step 4 in "[Removing the hard-drive](#)".
- 5 Remove the [control-buttons board](#).
- 6 Remove the [microphone](#).
- 7 Remove the [system-board shield](#).
- 8 Remove the [camera](#).
- 9 Remove the [fan](#).
- 10 Remove the [heat sink](#).
- 11 Remove the [memory module](#).
- 12 Remove the [speakers](#).
- 13 Remove the [wireless card](#).
- 14 Remove the [system board](#).
- 15 Remove the [display cable](#).

Procedure

- 1 Remove the screws that secure the optical-drive data cable to the display-assembly base.
- 2 Disconnect the touch-screen board cable and display-panel power cable from their connectors on the display-assembly base.

- 3** Note the routing of the optical-drive data, touch-board, display backlight, hard drive, and control-buttons board cables and remove the cables from the routing guides on the display-assembly base.

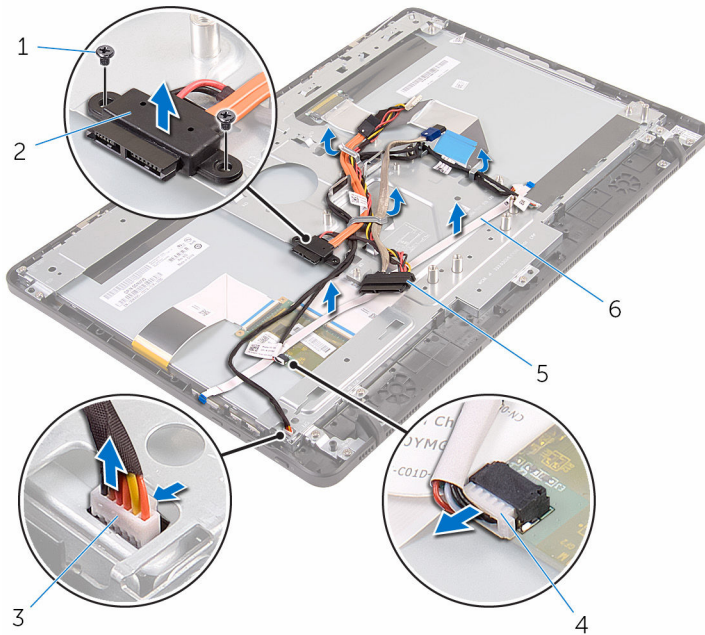

- | | | | |
|---|--------------------------|---|-----------------------------|
| 1 | screws (2) | 2 | optical-drive data cable |
| 3 | touch-screen board cable | 4 | display-panel power cable |
| 5 | hard-drive cable | 6 | control-buttons board cable |

- 4** Remove the screws that secure the display-assembly base to the display assembly.

- 5 Release the display-assembly base from the tabs on the display assembly.

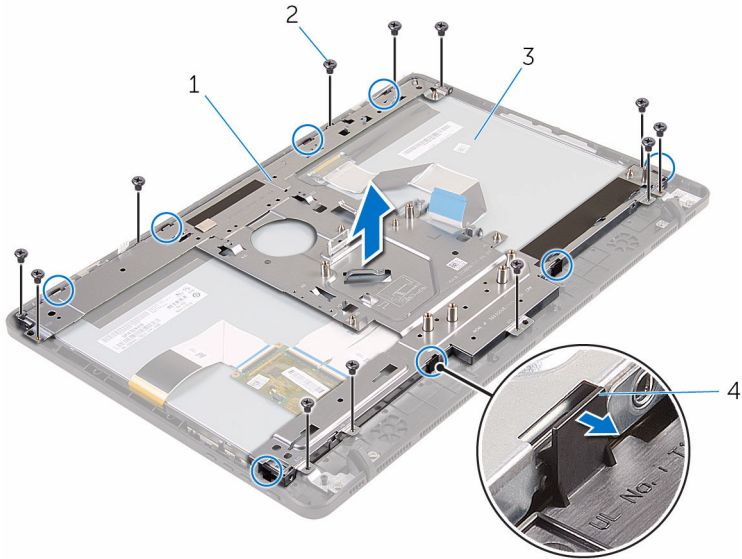

- | | | | |
|---|-----------------------|---|-------------|
| 1 | display-assembly base | 2 | screws (12) |
| 3 | display assembly | 4 | tabs (8) |

- 6 Lift the display-assembly base off the display assembly.
7 Remove the [rubber feet](#).



1 display assembly

Replacing the display assembly

 **WARNING:** Before working inside your computer, read the safety information that shipped with your computer and follow the steps in [Before working inside your computer](#). After working inside your computer, follow the instructions in [After working inside your computer](#). For more safety best practices, see the Regulatory Compliance home page at www.dell.com/regulatory_compliance.

Procedure

- 1 Replace the [rubber feet](#).
- 2 Slide the tabs on the display assembly into the slots on the display-assembly base.
- 3 Replace the display-assembly base on the display assembly.
- 4 Replace the screws that secure the display-assembly base to the display assembly.
- 5 Route the optical-drive data cable, touch-board cable, display backlight cable, hard drive cables and control-buttons board cable through the routing guides on the display-assembly base.
- 6 Replace the screws that secure the optical-drive data cable to the display-assembly base.

Post-requisites

- 1 Replace the [display cable](#).
- 2 Replace the [system board](#).
- 3 Replace the [wireless card](#).
- 4 Replace the [speakers](#).
- 5 Replace the [memory module](#).
- 6 Replace the [heat sink](#).
- 7 Replace the [fan](#).
- 8 Replace the [camera](#).
- 9 Replace the [system-board shield](#).
- 10 Replace the [microphone](#).
- 11 Replace the [control-buttons board](#).

- 12** Follow the procedure in step 3 to step 7 in "[Replacing the hard-drive](#)".
- 13** Replace the [back cover](#).
- 14** Follow the procedure in step 4 in "[Replacing the optical drive](#)".
- 15** Replace the [stand](#).

Removing the rubber feet



WARNING: Before working inside your computer, read the safety information that shipped with your computer and follow the steps in [Before working inside your computer](#). After working inside your computer, follow the instructions in [After working inside your computer](#). For more safety best practices, see the Regulatory Compliance home page at www.dell.com/regulatory_compliance.

Prerequisites

- 1 Remove the [stand](#).
- 2 Follow the procedure from step 1 to step 2 in "[Removing the optical drive](#)".
- 3 Remove the [back cover](#).
- 4 Follow the procedure from step 1 to step 4 in "[Removing the hard-drive](#)".
- 5 Remove the [system-board shield](#).
- 6 Remove the [fan](#).
- 7 Remove the [heat sink](#).
- 8 Remove the [memory module](#).
- 9 Remove the [speakers](#).
- 10 Remove the [wireless card](#).
- 11 Remove the [system board](#).
- 12 Follow the procedure from step 1 to step 6 in "[Removing the display assembly](#)".

Procedure

- 1 Remove the screws that secure the rubber feet to the display bezel.

2 Lift the rubber feet off the display bezel.

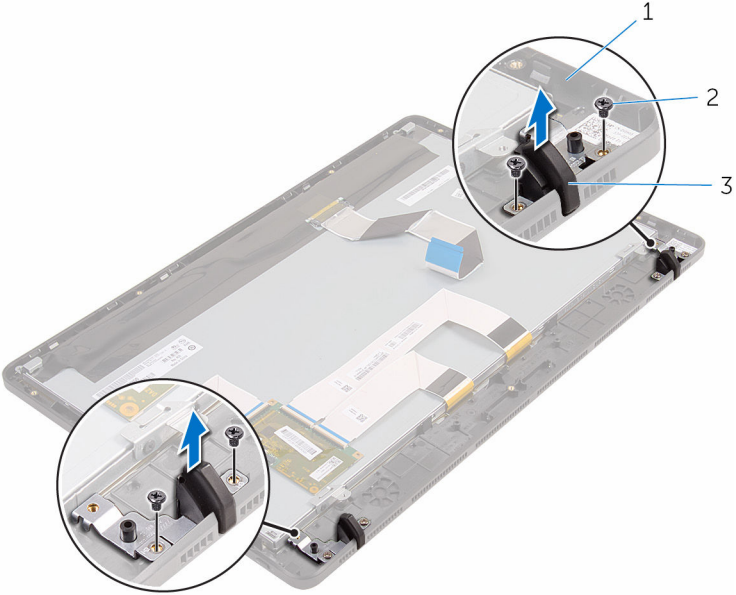

- 1 display bezel
- 3 rubber feet (2)

- 2 screws (4)

Replacing the rubber feet

 **WARNING:** Before working inside your computer, read the safety information that shipped with your computer and follow the steps in [Before working inside your computer](#). After working inside your computer, follow the instructions in [After working inside your computer](#). For more safety best practices, see the Regulatory Compliance home page at www.dell.com/regulatory_compliance.

Procedure

- 1 Align the screw holes on the rubber feet with the screw holes on the display bezel.
- 2 Replace the screws that secure the rubber feet to the display bezel.

Post-requisites

- 1 Follow the procedure in step 2 to step 6 in "[Replacing the display assembly](#)".
- 2 Replace the [system board](#).
- 3 Replace the [wireless card](#).
- 4 Replace the [speakers](#).
- 5 Replace the [memory module](#).
- 6 Replace the [heat sink](#).
- 7 Replace the [fan](#).
- 8 Replace the [system-board shield](#).
- 9 Follow the procedure in step 3 to step 7 in "[Replacing the hard-drive](#)".
- 10 Replace the [back cover](#).
- 11 Follow the procedure in step 4 in "[Replacing the optical drive](#)".
- 12 Replace the [stand](#).

BIOS setup program

Overview

 **CAUTION:** Unless you are an expert computer user, do not change the settings in the BIOS setup program. Certain changes can make your computer work incorrectly.

 **NOTE:** Before you change BIOS setup program, it is recommended that you write down the BIOS setup program screen information for future reference.

Use BIOS setup program to:

- Get information about the hardware installed in your computer, such as the amount of RAM, the size of the hard drive, and so on.
- Change the system configuration information.
- Set or change a user-selectable option, such as the user password, type of hard drive installed, enabling or disabling base devices, and so on.

Entering BIOS setup program

- 1 Turn on (or restart) your computer.
- 2 During POST, when the DELL logo is displayed, watch for the F2 prompt to appear and then press F2 immediately.

 **NOTE:** The F2 prompt indicates that the keyboard has initialized. This prompt can appear very quickly, so you must watch for it, and then press F2. If you press F2 before the F2 prompt, this keystroke is lost. If you wait too long and the operating system logo appears, continue to wait until you see the operating system's desktop. Then, turn off your computer and try again.

Clearing Forgotten Passwords

 **WARNING:** Before working inside your computer, read the safety information that shipped with your computer and follow the steps in [Before working inside your computer](#). After working inside your computer, follow the instructions in [After working inside your computer](#). For more safety best practices, see the Regulatory Compliance home page at www.dell.com/regulatory_compliance.

Procedure

- 1 Locate the password jumper (PSWD) on the system board.
 -  **NOTE:** For more information on the location of the jumper, see [“System-board components”](#).
- 2 Remove the jumper plug from the password jumper-pins.
- 3 Wait for 5 seconds and then replace the jumper plug in its original location.

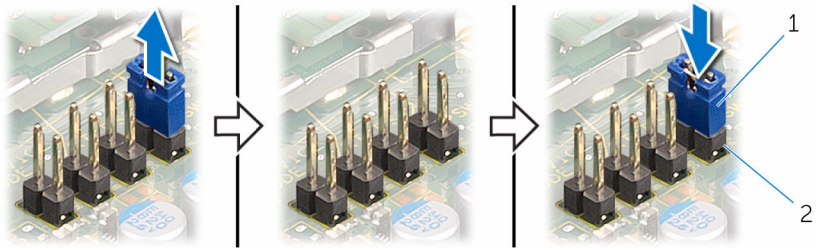

1 jumper plug

2 password jumper-pins

Clearing CMOS Settings

-  **WARNING:** Before working inside your computer, read the safety information that shipped with your computer and follow the steps in [Before working inside your computer](#). After working inside your computer, follow the instructions in [After working inside your computer](#). For more safety best practices, see the Regulatory Compliance home page at www.dell.com/regulatory_compliance.

Procedure

- 1 Locate the CMOS jumper (CMCL R2) on the system board.
 -  **NOTE:** For more information on the location of the jumper, see [“System-board components”](#).
- 2 Remove the jumper plug from the password jumper-pins and connect it to the CMOS jumper-pins.

- 3 Wait for 5 seconds and then replace the jumper plug to its original location.

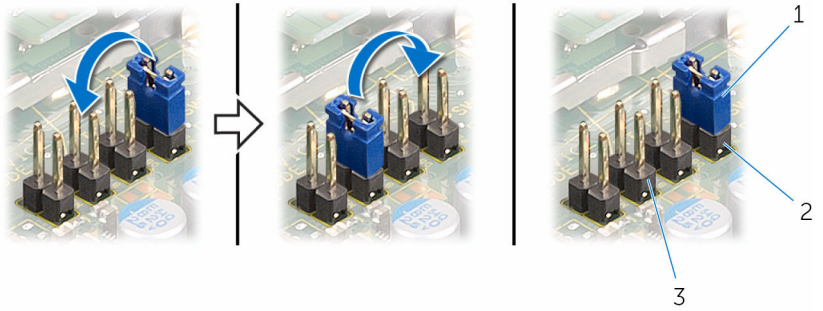

- 1 jumper plug
2 Password jumper-pins
3 CMOS jumper-pins

Flashing the BIOS

You may need to flash (update) the BIOS when an update is available or when you replace the system board. To flash the BIOS:

- 1 Turn on the computer.
- 2 Go to **www.dell.com/support**.
- 3 Click **Product Support**, enter the Service Tag of your computer and click **Submit**.
 **NOTE:** If you do not have the Service Tag, use the auto-detect feature or manually browse for your computer model.
- 4 Click **Drivers & downloads**.
- 5 Select the operating system installed on your computer.
- 6 Scroll down the page and expand **BIOS**.
- 7 Click **Download File** to download the latest version of the BIOS for your computer.
- 8 Save the file and, once the download is complete, navigate to the folder where you saved the BIOS update file.
- 9 Double-click the BIOS update file icon and follow the instructions on the screen.