

Enterprise-Class ES1642dc

ZFS, Intel® Xeon® E5, Dual Active Controller



**NVRAM Write Cache
Protected by Battery**



**Active Active
HA**
For Nearly Zero
Downtime
Dual Controller



QES
QNAP Enterprise
System
Operating System



ZFS
Zettabyte File
System
File System

JBOD Enclosure

Dedicated to Dual Controller
EJ1602 JBOD
EJ1600 JBOD

Business Continuity

SnapSync Disaster Recovery

Real-time High Availability and Total Recovery Solution



OpenStack

Cloud Computing
Best Storage Solution for Datacenter

Supports OpenStack iSCSI Cinder driver and perfectly couples with HPE Helion for a combination of both high reliability and flexibility of future expansion. It is the best realization of reliable enterprise storage.



Born to excel in supporting critical business applications

QNAP proudly introduces QES (QNAP Enterprise System). Derived and fine-tuned from the popular QNAP QTS operating system, the QES operating system of the QNAP Enterprise-class NAS series is re-engineered to support more high-availability features and hybrid cloud applications. Using the same operating system architecture enables consolidated management of various storage systems across different product lines and a reduced learning curve.

QNAP ES1642dc and ES1640dc Enterprise-class NAS enable you to keep pace with changing business and customer demands, comply with tougher regulations, and mitigate new risks. QNAP hyper-converged infrastructure with web-scale technologies are ideal purpose-built infrastructure for hosting the modern virtualized datacenter and hybrid clouds. QNAP brings web-scale to hybrid cloud environments, while reducing risk and enhancing agility.

Businesses face the increased need for new and innovative solutions to maintain peak productivity, while dealing with unprecedented data growth, ever-present cyber security risks, and increasing regulatory requirements. The move toward on-premises, managed, and hybrid cloud solutions creates a great opportunity for all enterprises by offering the security and control of on-premises IT infrastructure – mixed with the scalability and advantageous economics of cloud deployments.

QNAP pay-as-you-go scalability enables you to start small and scale appropriately with linear performance and capacity. Reduce the amount of infrastructure needed through better utilization of existing resources using QNAP's efficient software-based approach. QNAP NAS enable quick addition (or removal) of server and storage capacity one node at a time to precisely meet business demands. With modular and simple scalability, QNAP minimizes upfront capital expenditures by eliminating the need to over-provision simply to ensure necessary capacity and performance for the future.

QNAP delivers the excellent data center density, enabling you to run all of your virtualized IT workloads in very little space. QNAP hyper-converged NAS enables you to consolidate different workloads, including the first-tier databases and enterprise applications, virtualized desktops and applications, and big data workloads, on to a single platform to reduce CapEx and maintain high performance. The QNAP hyper-converged platform further enables you to cut power, space, and cooling costs making it ideal for space-constrained datacenters and remote/branch offices.

QNAP Enterprise-class NAS series combines world-class technical expertise with practical experience in designing and automating IT processes to deliver end-to-end solutions that maximize your investment in QNAP infrastructure. Deploy your Enterprise-class NAS with best-of-breed cloud-ready solutions, supporting Cinder driver and offering persistent storage for hybrid cloud solutions including OpenStack platforms such as HP Helion.

With the introduction of the ES1642dc and ES1640dc, QNAP further demonstrates its ability to offer a complete product portfolio that encompasses SMB, SME, and Enterprise scale solutions.



Contents

- 01 Enterprise-class, ZFS NAS powered by Intel® Xeon® E5 with dual active controllers
- 03 ZFS (Zettabyte File System)
- 07 Snapshot (local snapshot) and SnapSync (remote snapshot replication)
- 11 Virtualization applications with VMware® / Hyper-V®
- 13 Multiple data protection mechanisms
- 15 The all-new, all-inclusive operating system - QES 1.1.2
- 19 Mobile apps
- 20 Computer utilities
- 21 Enterprise case studies
- 25 Hardware specifications & JBOD expansion units
- 25 Accessories & 10/40GbE NIC compatibility list
- 26 Software specifications



ES1642dc / ES1640dc Enterprise ZFS NAS

Hardware Architecture

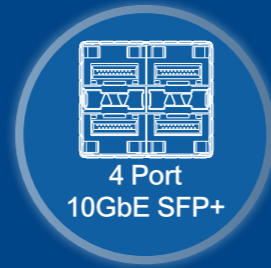

02 4 x 10GbE SFP+ Network Interface
Built-in 4-port 10GbE SFP+, to meet various iSCSI/NFS/CIFS network data transmission requirements.

01 Dual Active-Active Controller
In the event of a controller failure, the other controller will immediately take over to ensure high availability with near-zero downtime.

03 40GbE NIC
The PCIe slot supports a dual-port QSFP+ 40GbE NIC to provide massive data transmission potential and to simplify network cabling.

**04 SAS 12Gb/s (ES1642dc)
SAS 6Gb/s (ES1640dc)
SATA hard drive SSD
dual-controller architecture**

Provides versatile hard drive choice for enterprises.
* Also supports SATA HDDs (with the optional SAS-to-SATA interposer board)

**06 Dual Path Mini-SAS
12Gb/s (EJ1602)
6Gb/s (EJ1600)
JBOD architecture**

Increases the storage capacity to over 1PB with expansion enclosures.



**07 Intel® Xeon® E5
Series Processors**

Provides sufficient performance required by software-defined storage and commercial mission-critical applications.

NVRAM w/Copy-to-Flash

Industry-leading random access performance from flash read acceleration and battery-protected DRAM write cache.

5-1

Battery Backup Unit (BBU) - ensures sufficient power to maintain the NVRAM cache in the event of a power outage.

5-2

(1.) NVRAM dedicated DDR3 memory modules - supports 16/32GB, power required by C2F is supplied by BBU.



(2.) Dual-channel DDR3 system main memory - each channel supports 16/32GB, providing up to 32/64GB capacity.

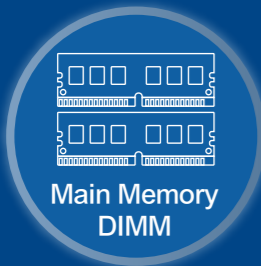

5-3

mSATA / M.2 SSD - stores cached data written by DRAM if the system encounters a sudden power failure to ensure information is not lost.

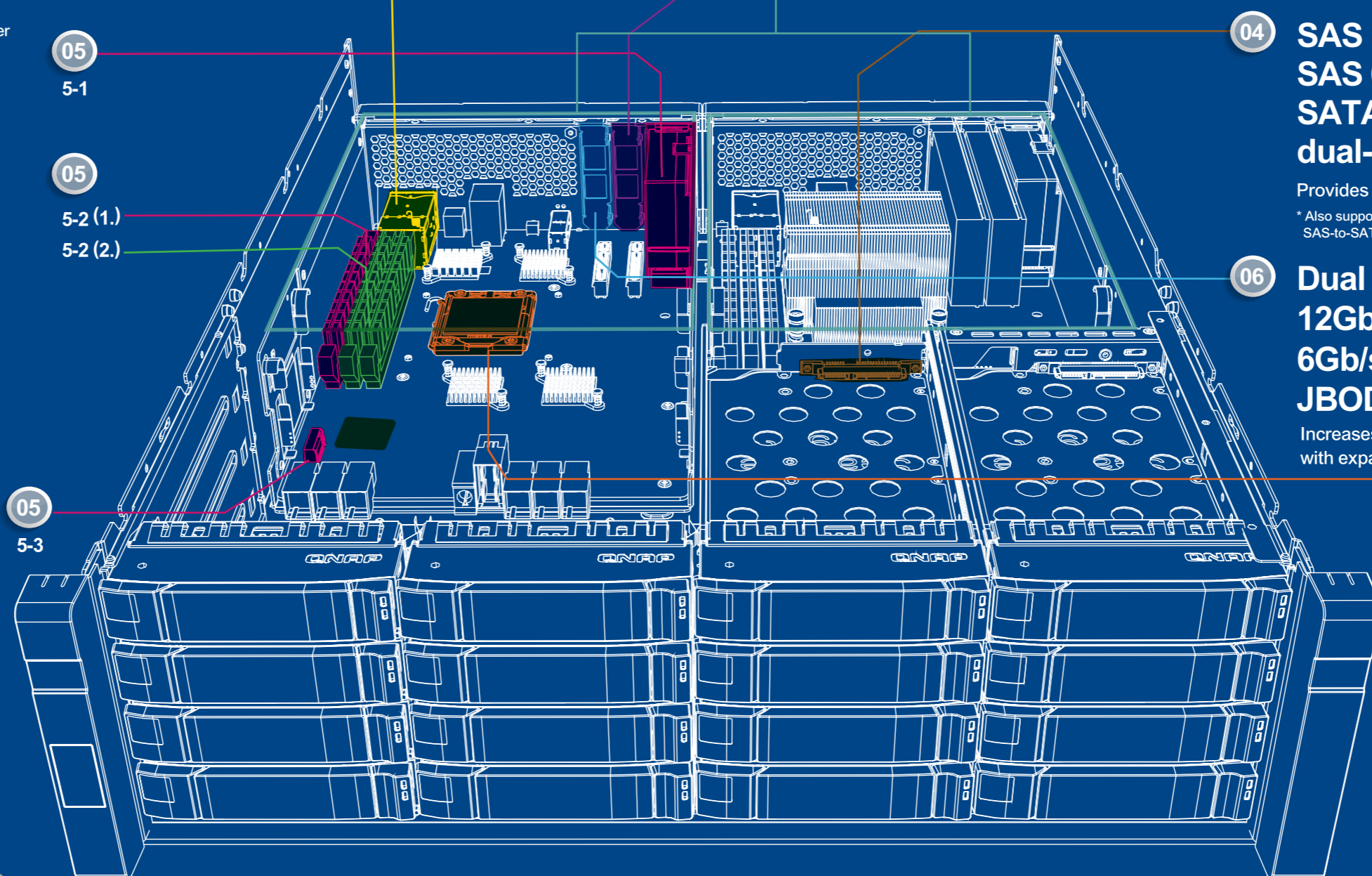

Breakdown of dual active controllers

Dual active controller, dual Mini-SAS channel backup, remote data synchronization to ensure uninterrupted mission-critical enterprise tasks and productivity.

QES combines FreeBSD Kernel with ZFS

The next-generation QES (QNAP Enterprise System) operating system is based on the FreeBSD kernel and uses ZFS to provide the resilient stability and functionality of traditional UNIX operating systems and native file systems. QES further introduces uncompromising high availability features in addition to full support for OpenStack private cloud.

ES1642dc / ES1640dc Enterprise ZFS NAS

Software Architecture

Visualized file management

Manage files with the built-in QES operating system.

Remote data synchronization

Block-level SnapSync can provide remote backup and disaster recovery at any time, thus providing enterprise business consistency.

Better efficiency with high-capacity storage

Block-level deduplication, real-time data compression, and thin-provisioned volumes with space reclamation help realized the most cost-effective remote virtual desktop platform and mission-critical data warehousing.

Integrated OpenStack cloud solution

Supports OpenStack iSCSI Cinder driver and perfectly couples with HPE Helion for a combination of both high reliability and flexibility of future expansion.

Minimal backup configuration

Build a QNAP Snap Agent and VSS Hardware Provider environment on a single server. All applications, including VSS Service, Requestor, Provider and QNAP Snap Agent, can be deployed with VSS-aware applications on a single QNAP ES NAS.

Excellent random write performance

Battery-protected DRAM write featuring cache data protection coupled with Flash read acceleration provides industry-leading performance.

Comprehensive network capability

A single system supports 10/40Gb Ethernet and iSCSI, providing excellent storage deployment flexibility.

High reliability, availability and serviceability

Supports dual-active controllers with dual Mini-SAS channels to prevent single-node failure and ensure uninterrupted business operations.

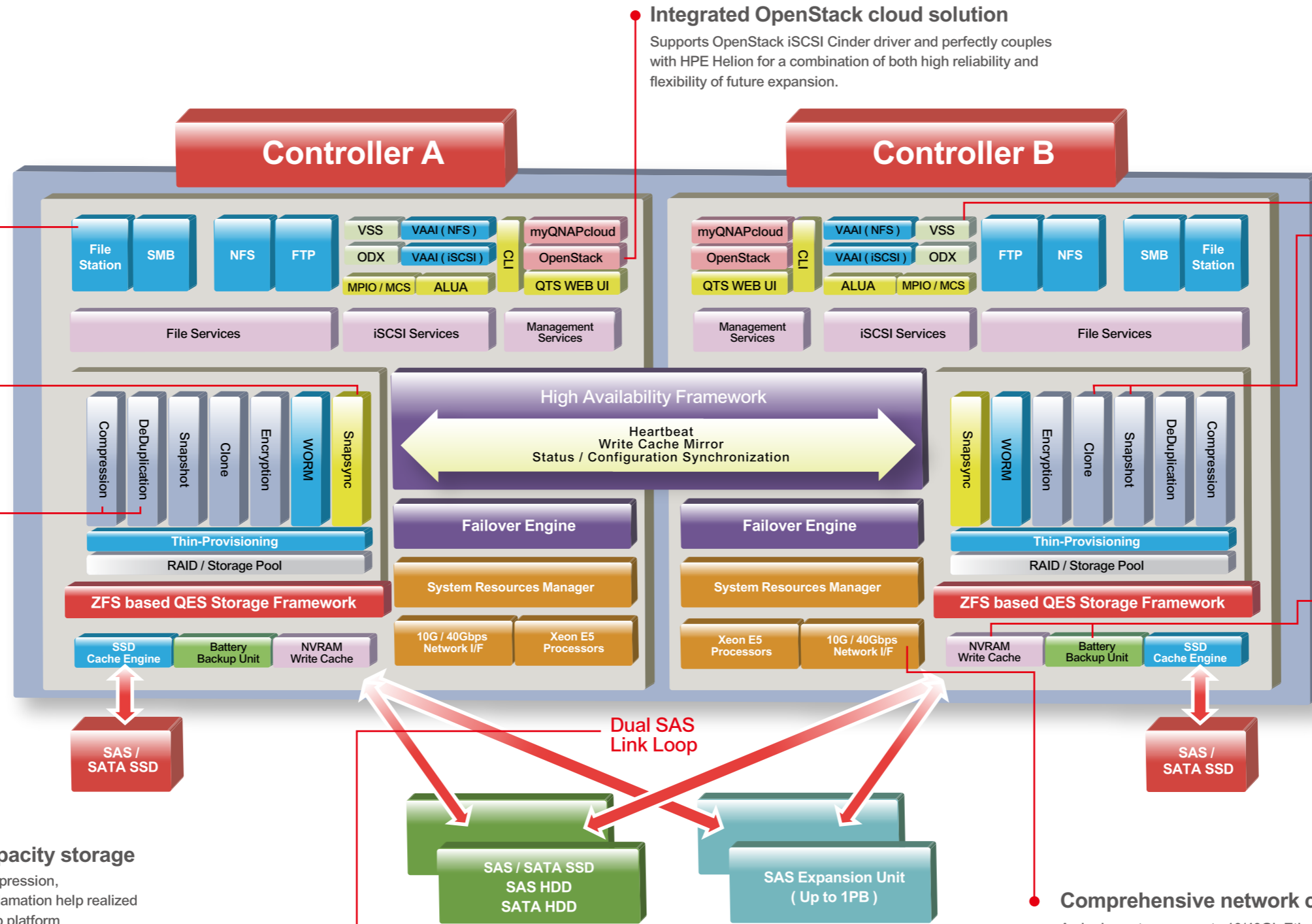

Enterprise-class, ZFS NAS powered by Intel® Xeon® E5 with dual active controllers

QNAP is launching a new series of Enterprise Storage (ES) NAS to address the needs of the most demanding clients. Simultaneously, QNAP is unleashing the full potential of the QES (QNAP Enterprise System) operating system, with our promise to provide and support QES with the highest level of excellence.

Near-zero downtime availability

The Enterprise ZFS NAS architecture has a powerful back-end storage base powered by high-performance dual Intel® Xeon® E5-2420 v2 processors, providing uninterrupted service and near-zero downtime with its dual active controllers geared for datacenter storage. With the built-in failover mechanism, if one controller fails, the other will seamlessly take control of disk volumes and storage resources without service interruption. The failed controller can then be replaced even when the system is still operating, achieving high availability.



Field Replaceable Unit (FRU) design

QNAP enterprise-class ZFS NAS adopts a Field Replaceable Unit (FRU) design in many of its hardware components, allowing you to replace damaged parts including storage controllers, fan modules, power supply units, battery backup units (BBU) to attain a high level of system serviceability and reliability.

The controller can be easily accessed and replaced without needing to open the chassis.



Power supply units and Battery Backup Units (BBU) for battery-protected NVRAM can be easily replaced without needing tools and opening the chassis.



Fan modules can also be easily replaced.

Flexible storage capacity expansion

The Enterprise ZFS NAS product line and its corresponding JBOD expansion enclosures all provide paths to storage controllers to prevent system downtime from component or connection failure. If an external JBOD cable is disconnected, it can still run normally. The connection of multiple storage expansion units via mini-SAS ports helps to daisy-chain multiple expansion units while the system is running for online capacity expansion with higher density, efficiency and capacity expandability.

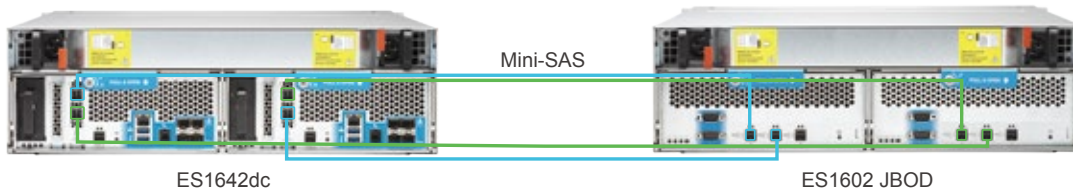

Redundant cross loop configuration

The QNAP Enterprise JBOD (EJ) expansion series includes the EJ1602 (SAS 12Gb/s) and EJ1600 (SAS 6Gb/s) for greater scalability in storage capacity, enabling you to maximize the return on your IT investment in virtualized storage infrastructure. The raw capacity of the ES1642dc/ES1640dc can be expanded up to 1 petabyte (PB) with the EJ expansion series enclosures.

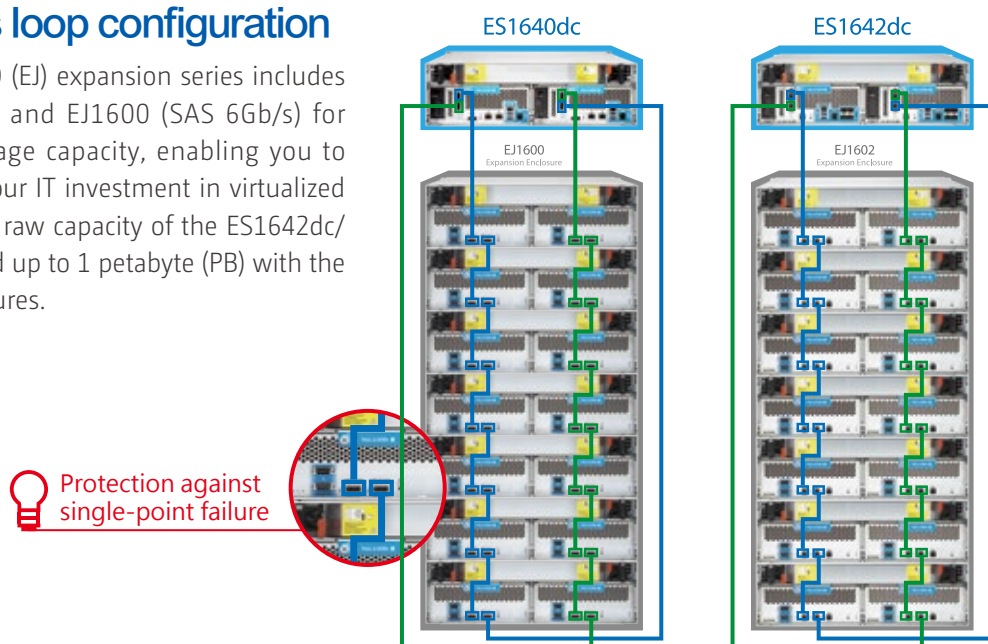

Enterprise-grade caching

QNAP ZFS NAS utilizes NVRAM for write cache. The cache is also protected by a battery backup unit (BBU) to safeguard against power outages, and ensures that data will be written from the NVRAM to the mSATA SSD module.

Write cache with mirroring doubles the degree of data safety

Software errors in semiconductor memory presents an increasing danger for potential data loss. These unique conditions introduce a risk of potential data loss. The write cache mirroring provides integrity for cached data if a Storage Controller fails in a dual-controller configuration.

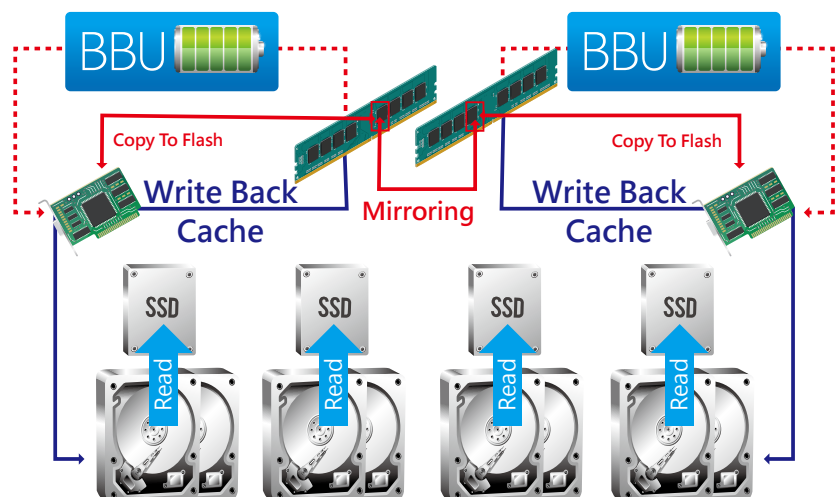

QES and ZFS (Zettabyte File System)

The QNAP Enterprise-class NAS series leverages the extensive native functionality of ZFS to ensure persistent, reliable logical volume management, protection against data corruption, seamless capacity expansion, flexible storage pool management, several data integrity mechanisms, unlimited snapshots, and unlimited clones. QES also features advanced technologies for efficient space utilization including deduplication, inline compression, and thin provisioning to maximize ROI on storage usage.

Intelligent Storage Manager

The QES Storage Manager neatly presents tools and options for managing system storage with an intuitive graphical interface. From reviewing the system storage allocation in the Dashboard, to managing volumes, storage pools, disks and iSCSI storage, or even the Snapshot function, the Storage Manager provides a centralized place to simplify hard drive management and to maximize storage usage.

Dashboard

The Storage Manager dashboard provides an overview for administrators to monitor and manage storage allocations easily. QES provides a secure and flexible way to store and manage data stored on your ES NAS. This next generation, enterprise-grade volume management toolset offers powerful features such as storage pooling with multiple RAID groups, thin-provisioned volumes with space reclamation, and online capacity expansion.

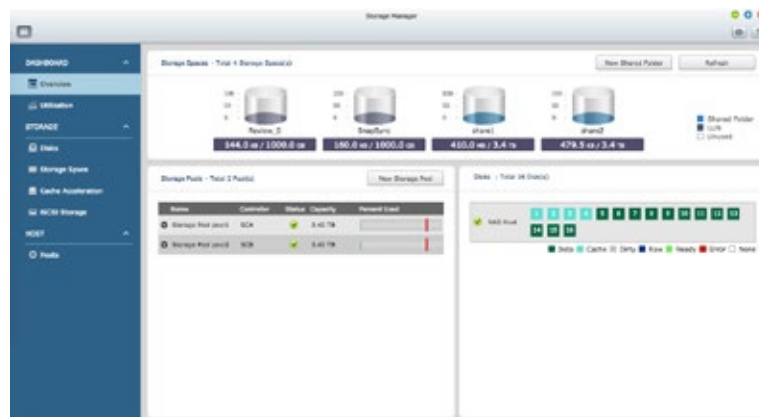

Storage management

IT administrators can monitor HDD allocation status for RAID groups in addition to individual HDD information. This ensures that there are no idle HDDs, maximizing utilization of the storage resources. They can also aggregate multiple RAID groups into a single storage pool to flexibly utilize the storage capacity. This provides further degree of redundancy, allowing for better protection against multiple disk failures in large-capacity environments.

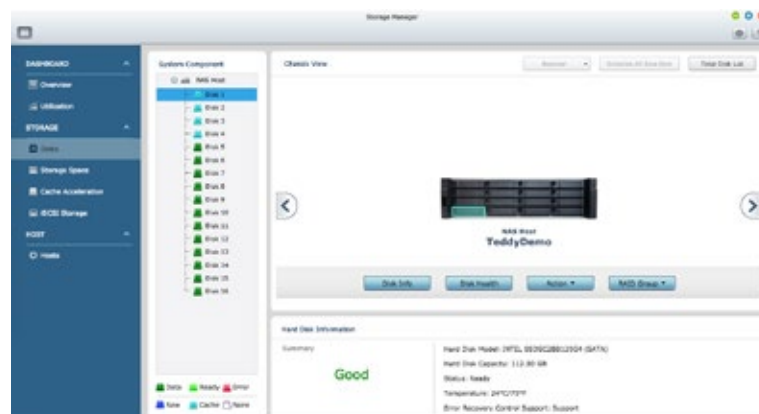

Space allocation

QES supports the creation of multiple LUNs/share folders within a storage pool. View all available storage pools with different RAID groups, share folders, and iSCSI LUNs from a single interface. This enables the expansion or removal of current pools, setting of threshold values for capacity consumption alerts, and RAID group management. Businesses can utilize this flexible storage capability to facilitate various business applications based on different work groups. Storage pools and LUNs can also be extended without interrupting services.

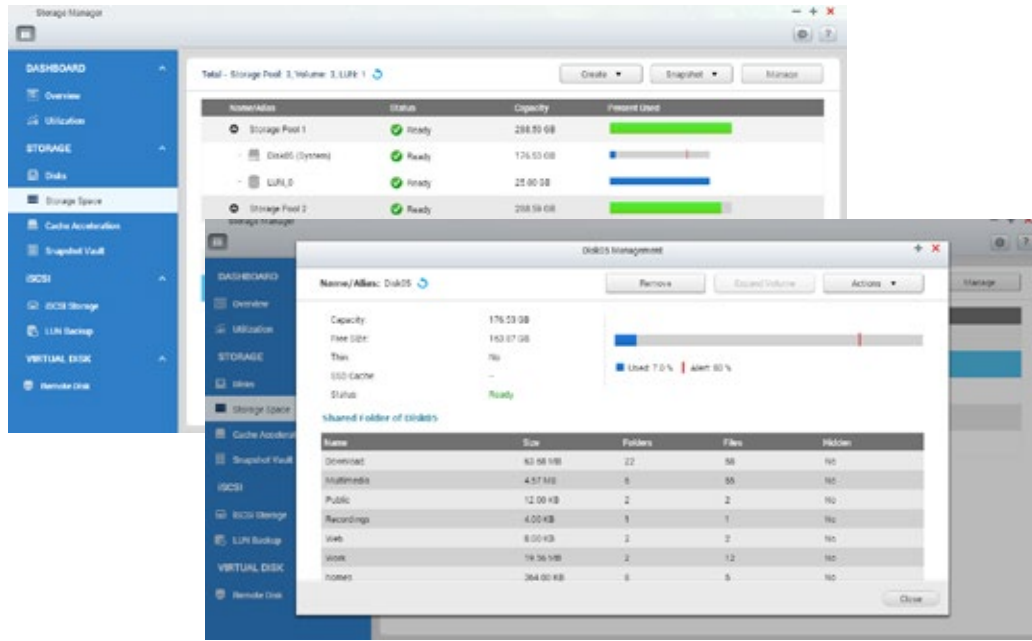

Thin provisioning

Over-allocation enables a server to view more storage capacity than is actually available in a storage pool. This accommodates flexible usage patterns of multiple users. Further, the physical storage capacity is used only when files are written by the application, improving utilization rates.

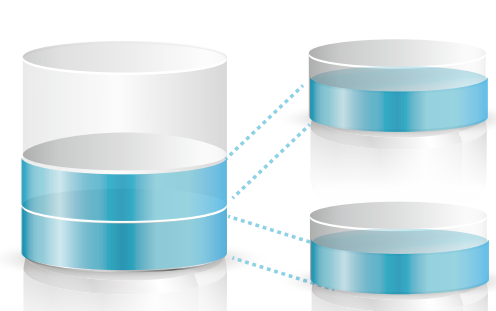

Dynamically and efficiently, use storage spaces with incremental allocation.

Thick provisioning

Physical storage capacity is dedicated during the initial allocation of the storage space.



Specifically define all storage space that cannot be used by other LUNs.

iSCSI LUN

QES supports block-level iSCSI LUN. It supports different types of configuration for server connections: 1) single LUN or multiple LUNs per iSCSI target and 2) multiple iSCSI targets for a single LUN. Deploy block-level iSCSI LUN in a storage pool to reduce overhead and improve overall read/write performance.

Data Self-healing

Robust data integrity is one of the major characteristics that distinguish ZFS from other file systems. ZFS is designed to protect the user's data on disk against silent data corruption caused by incidents including metadata errors and bugs in disk firmware. Data integrity is achieved by using a checksum. When a block is accessed, its checksum is calculated and compared with the stored checksum value. If the checksums do not match, then ZFS can heal the data using the data storage's redundancy features.

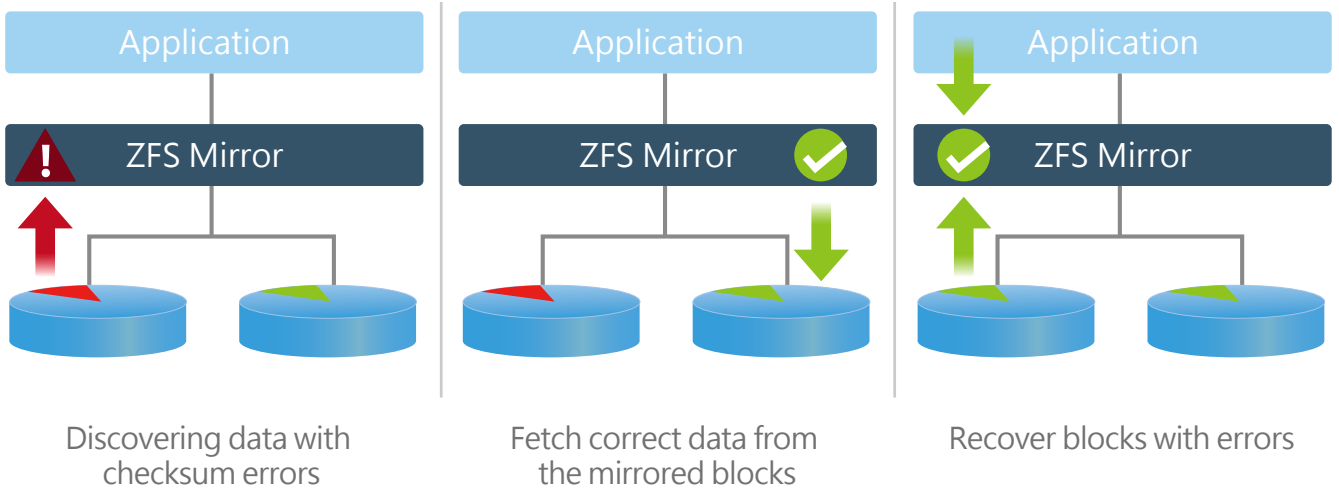

Robust RAID-Z data protection on ZFS

RAID-Z outperforms traditional RAID technology with better efficiency in handling petabyte-size data collections. And when combined with the copy-on-write transactional semantics of ZFS, write hole errors can be eliminated.

ZFS RAID-Z

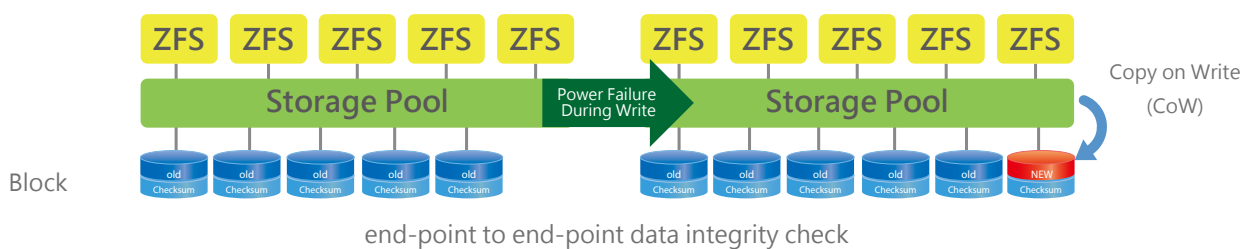

Traditional RAID

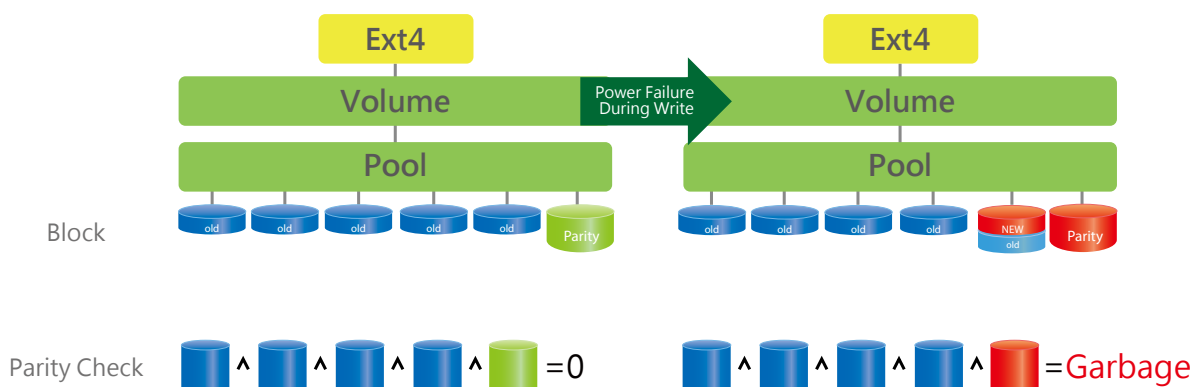

Deduplication

Server virtualization and virtual desktop applications result in a great deal of redundant data of operating systems and application data stored on disk. In some instances data redundancy can approach 95%. With the integrated deduplication of ZFS, disk space can be efficiently preserved. Deduplication tables can also be cached in solid-state drives to accelerate deduplication performance.

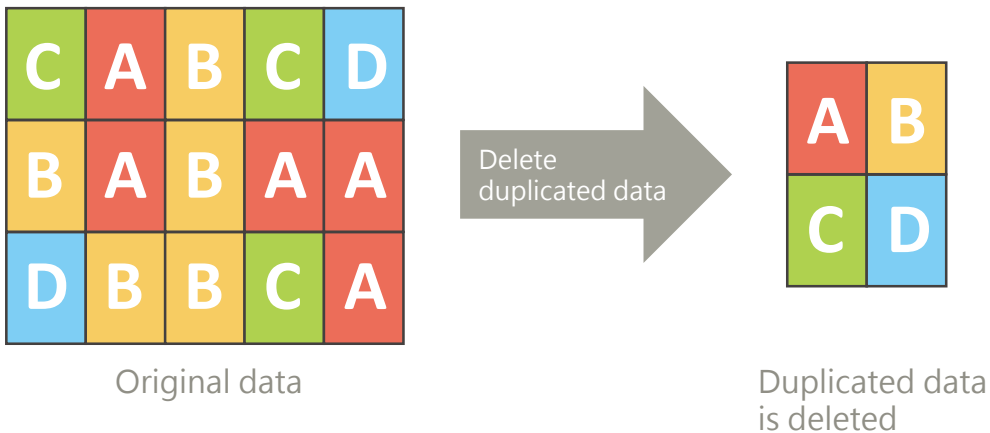

Inline Compression

QES based on ZFS enables efficient and real-time data compression. In comparison to similar storage devices of the same capacity, the ES1642dc/ES1640dc achieves higher data compression and deduplication, ensuring the most optimized disk utilization and further increasing the overall return on investment.

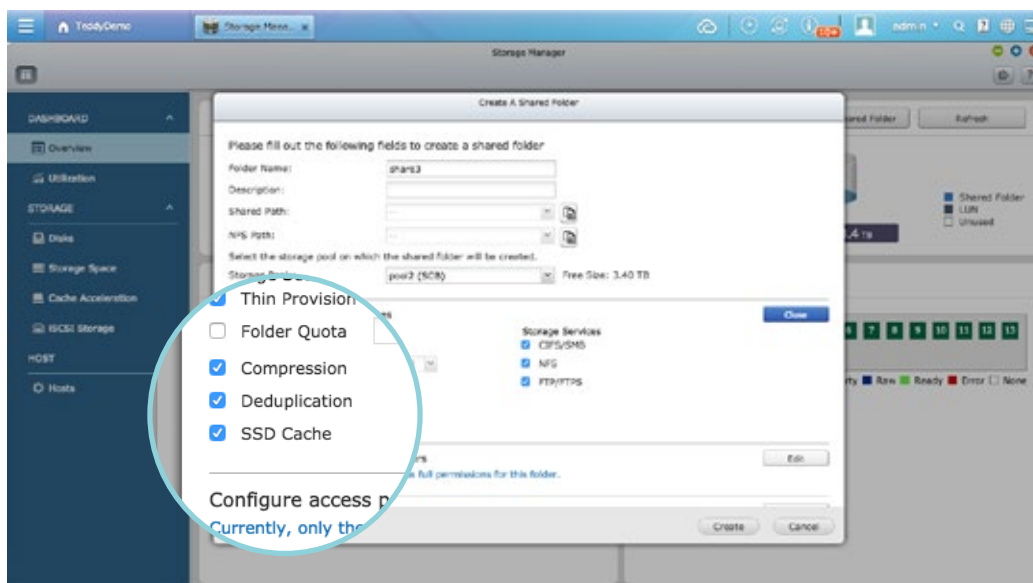
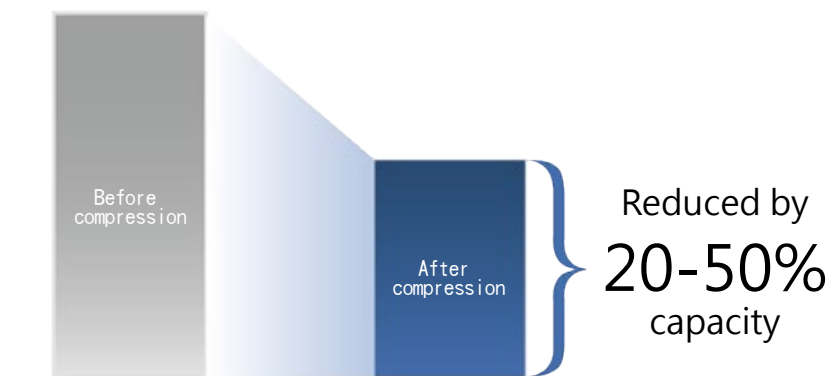

Enable deduplication or compression when creating shared folders or iSCSI LUNs. These two functions can be enabled at any time by modifying the properties of the shared folders or iSCSI LUN.

Snapshot (local snapshot) and SnapSync (remote snapshot replication)

QNAP Snapshot technology uses copy-on-write to record a file's status. If there is a problem with a file, blocks containing the old data can be recovered quickly, allowing a complete snapshot version of the file system to be restored. This greatly enhances a business's Recovery Point Objective (RPO) and Recovery Time Objective (RTO).

QNAP Snapshot technology performance improvements

The block-based QNAP Snapshot Technology fully supports over 65 thousand snapshots on LUNs and shared folders. Block-based snapshot technology only backs up modified data both increasing efficiency, and saving space. Schedule snapshots to minutes, hourly, daily, weekly, monthly, or yearly intervals for fine grained control to suit enterprise requirements of improving Recovery Point Objectives (RPO) and Recovery Time Objectives (RTO) while retaining the desired number of versions with the allocated space.

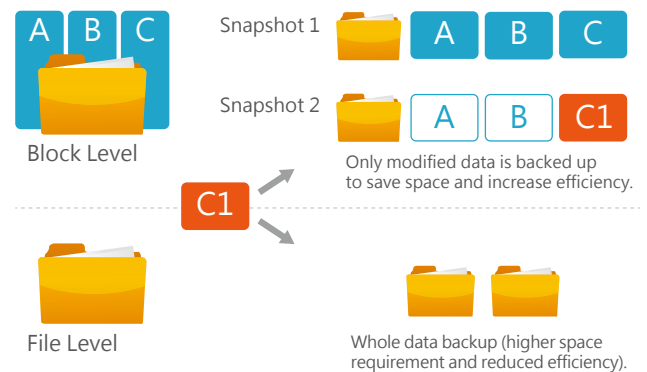

Local Snapshot provides continuous data protection

Low-impact, small-sized, and user recoverable snapshots offer more benefits of storage administration compared to traditional file copies, which are often stored as a single large data file. For example, choose to recover a file in a folder or, recover the entire folder instantly from the easy-to-use GUI.

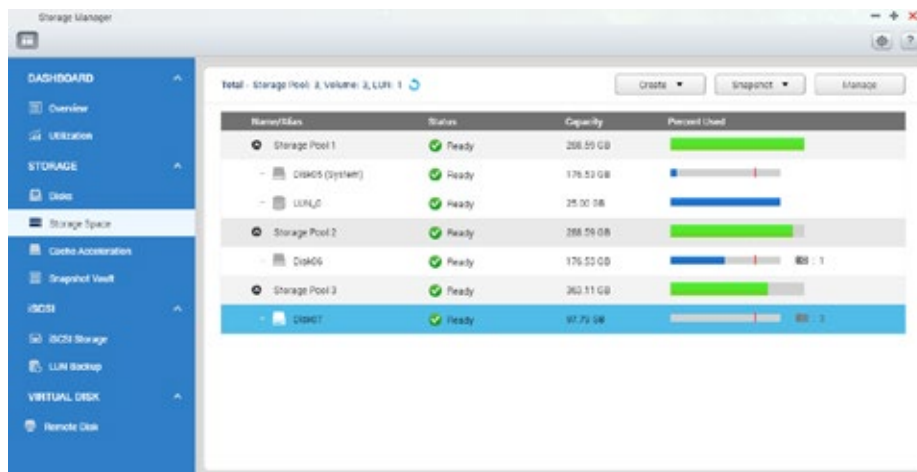

Intuitive interface with granular data visibility

The QNAP Snapshot provides tools in Storage Manager to help you find specific files to recover. These tools enable you to easily view files and folders within a snapshot, browse through chronologically ordered snapshots and quickly find specific files to recover.

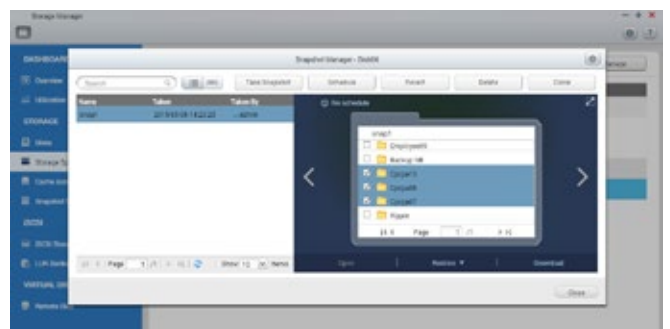

Snapshot clones as writeable snapshots

Clone a snapshot as a share folder or LUN for quick file access, eliminating long restore times and reserving sizeable space for storing backups. The files in a snapshot clone can be freely edited by users.

Rsync/NAS-to-NAS integration

The Rsync (Real Time Sync) function in Backup Station automatically detect whether the system supports Snapshots. The Rsync function takes snapshots of the volume before starting replication and then backs up snapshots to a remote server. This greatly enhances data integrity.

VMware/Microsoft VSS integration with QNAP Snapshot Agent

QNAP Snapshot fully supports virtual machine snapshot capture on VMware and Microsoft Volume Shadow Copy Service (VSS) deployments. Before taking snapshots, the Snapshot Agent notifies VMware or Microsoft VSS to stop accessing iSCSI LUNs both ensuring data integrity and reducing system overhead.

SnapSync for remote snapshot replication

SnapSync enables you to replicate share folders/LUNs between different remote servers using snapshot technology as part of a comprehensive strategy for data backup. Additionally, this approach helps to reduce storage and bandwidth usage.

Enterprise-class disaster recovery

QES SnapSync captures snapshots and backs up local shared folders and iSCSI LUN snapshots to a specified destination over IP. After creating a first-time full backup, SnapSync targets only changed blocks. This significantly reduces time needed for capture snapshots.

QNAP Site Recovery Agent plug-ins for VMware Site Recovery Manager fully support remote array backup, to ensure a comprehensive, enterprise-grade remote backup solution. If a user encounters a local computer equipment problem or interruption in the Internet service, they can restart essential services in a short time at the remote location. And the services can be resumed back by the primary server after successful system recovery.

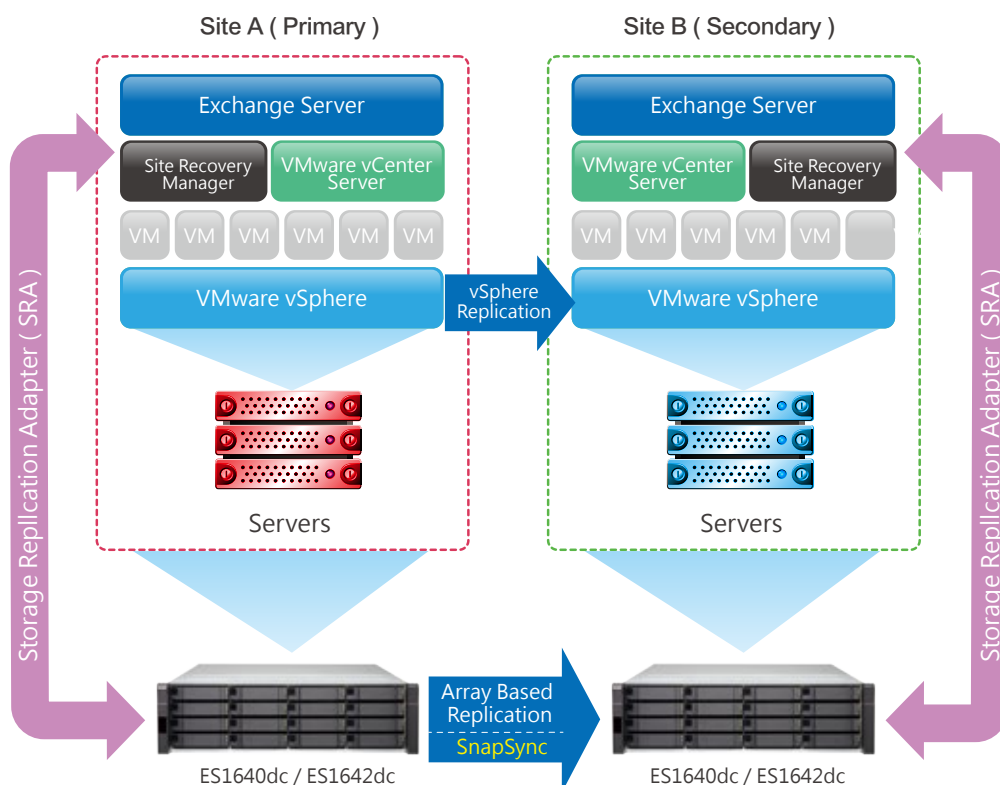

Manage snapshots remotely from another NAS

Use the Clone function to clone (or mount) a snapshot from the Snapshot Vault as an iSCSI LUN on a QNAP NAS. Directly access these files through File Station or Backup Station. Use an iSCSI initiator to connect to a cloned iSCSI LUN from another computer.

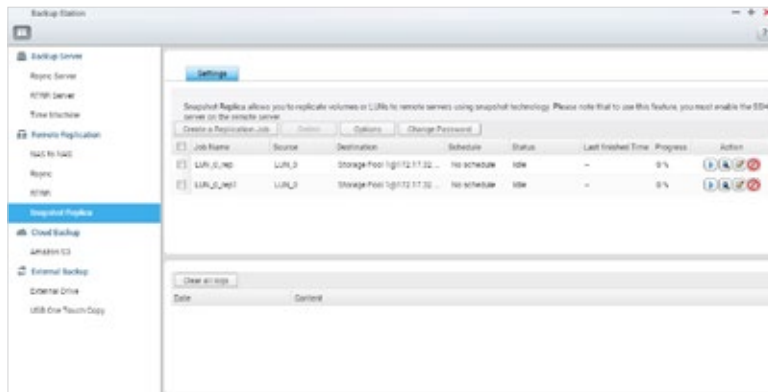

Replication settings

To minimize the risks of a data breach, the Snapshot Replica provides optional file encryption, and compression. Additionally, bandwidth control enables lower bandwidth usage.

	SnapSync	RTRR	Rsync	NAS to NAS
Featured QNAP OS	QES	QTS	QES / QTS	
Data Replication level	Shared folders/LUN	Shared folders	Shared folders	
Transmission mode	Block-based	File-Level File-based	File-Level block-based	
Data modification method	Only modified blocks are transferred	The entire file is transferred as a new file	New files and only modified blocks for old files are transferred	
Execution method	Scheduled	Real-time/Scheduled	Scheduled	
Transmission Compression	Supported	Not supported	Not supported	
Data compression	Supported	Not supported	Not supported	
Data de-duplication	Supported	Not supported	Not supported	
NVRAM write cache	Supported (ZFS ZIL)	Not supported	Not supported	
Featured QNAP OS that supports remote replication	QES	QTS	QES / QTS	
Remote replication	Supported	Not supported	Supported	
VMware Storage	Supported	Not supported	Not supported	
Application scenario	<ul style="list-style-type: none"> Data backup that requires high performance, no matter within LAN or over the Internet <ol style="list-style-type: none"> Office applications that modify lots of small files Virtualization applications that modify only parts of a large image file Data backup with incremental mechanism to only back up changed parts Remote replication with SRA to fully support VMware SRM enterprise solution 	<ul style="list-style-type: none"> Requires real-time file replication Requires file synchronization Requires a LAN environment Fast transmission 	<ul style="list-style-type: none"> Requires transmission of only modified portions of a big file Long-distance file transmission that requires Internet connections 	

The advantages of using QNAP Snapshot

Comprehensive and flexible

QNAP Snapshot can be used with iSCSI LUNs on ES1642dc / ES1640dc and EJ series expansion units to achieve full data protection as a comprehensive on-site disaster recovery plan. Further, use SnapSync to achieve a consistent remote/off-site backup.

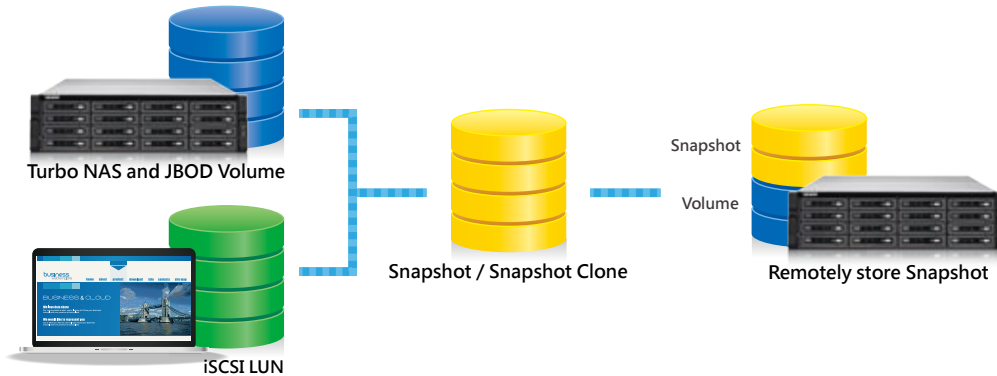

Application-consistent Snapshots with Snapshot Agent

Snapshot Agent for iSCSI LUN enables connecting an Enterprise-class NAS with remote servers (VMware vCenter or Windows Server) to ensure consistent snapshots. On those remote servers, running applications (VMware virtual machines, Hyper-V virtual machines, SQL Server, Windows file server, etc.) will write/flush data from memory to the iSCSI LUN prior the snapshot capture. This ensures application consistency and includes all necessary data for an application-consistent restore point. QNAP also provide Snapshot Agent for VSS Hardware Provider for Windows so that the Windows backup software can initiate a snapshot request to an ES1642dc / ES1640dc to offload the Snapshot process to the NAS reducing the load on the Windows server.

VSS Hardware Provider Work Flow

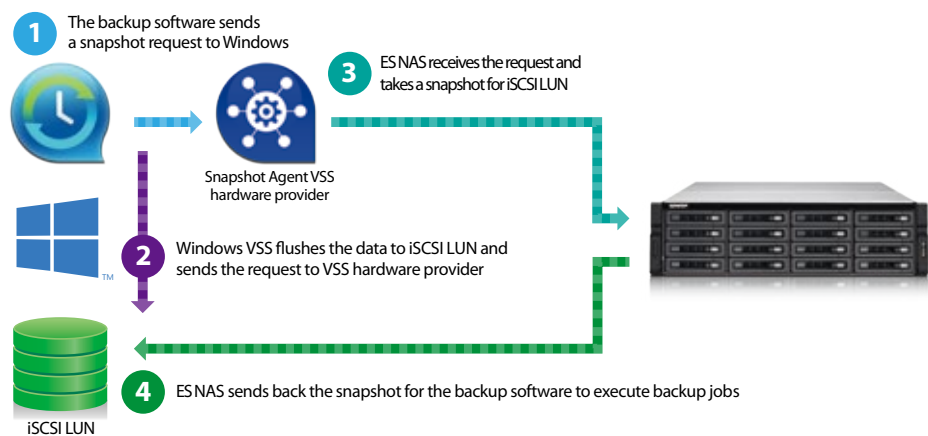

Snapshot Agent Work Flow

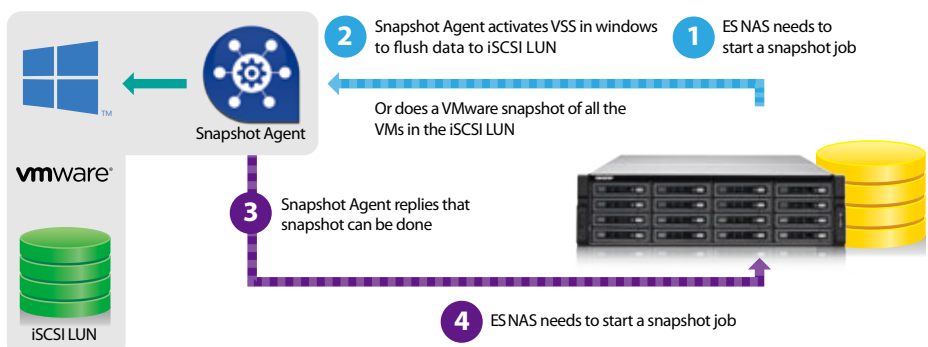

Virtualization applications with VMware® / Hyper-V™

The ES1642dc / ES1640dc supports iSCSI and NFS protocols, and is virtualization ready - VMware® Ready™ and Microsoft® Hyper-V™ compatible, to provide businesses with powerful and flexible storage solutions for virtualization applications.

Virtualization ready

The QNAP ES1642dc/ES1640dc supports VMware Ready™ vSphere 6, VAAI; Citrix® Ready XenServer™ 6.0, and is compatible for Microsoft® Hyper-V, supporting ODX and Windows Server 2012.

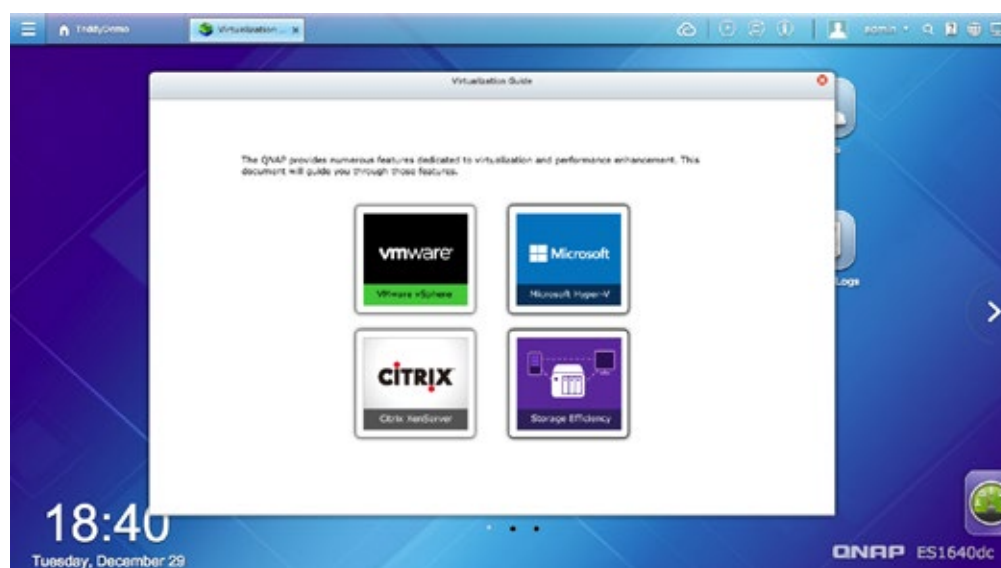

VAAI for iSCSI, VAAI for NAS

vStorage API for Array Integration (VAAI) is an application program interface (API) framework from VMware. It allows for offloading of certain VM and storage functions that typically take place on the ESX host to the storage array. The QNAP ES1642dc / ES1640dc, VAAI iSCSI and VAAI NAS are VMware certified, providing businesses with the best virtualized environment. VAAI for iSCSI supports Full Copy (hardware-assisted copy), Block Zeroing (hardware-assisted zeroing), Hardware-assisted Locking, and Thin Provisioning with space reclaim. VAAI for NAS supports Full File Clone, Extended Statistics, and Reserve Space.

With the centralized management of vSphere Plug-In and vSphere Web Plug-In, users can directly manage QNAP ES1642dc / ES1640dc on the vSphere Client control panel.

Microsoft® Hyper-V™

With full Offloaded Data Transfer (ODX) support, the QNAP ES1642dc/ES1640dc become a high performance iSCSI storage solution under Windows Server 2012. QNAP storage enables full copies of virtual machines within the ES1642dc/ES1640dc without requiring the Windows hosts to read and write the data. This significantly reduces the loading of Windows hosts and improves the performance of copy and move operations for Windows Server 2012 hosts using iSCSI storage.

Use System Center Virtual Machine Manager with QNAP SMI-S Provider to directly manage storage resources on ES1642dc/ES1640dc.

Secure and flexible storage utilization

The Enterprise-class NAS series offers flexible management through creating and allocating iSCSI LUNs, mapping and unmapping LUNs to and from iSCSI targets, and thin provisioning functionality. The support of CHAP authentication and LUN masking reinforces secured deployment in virtualization applications.

VM Backup solution with QNAP and Veeam

Veeam Backup & Replication software combined with QNAP NAS provides a cost-effective disk-based backup solution for VMware® and Hyper-V™ that maximize data reduction and scales to meet the needs of demanding enterprise environments. This affordable and complete backup solution enables setting up one or multiple QNAP NAS units as the backup storage, replicating VMs and backing them up to a remote site for an efficient disaster recovery solution.

Solution for VMware

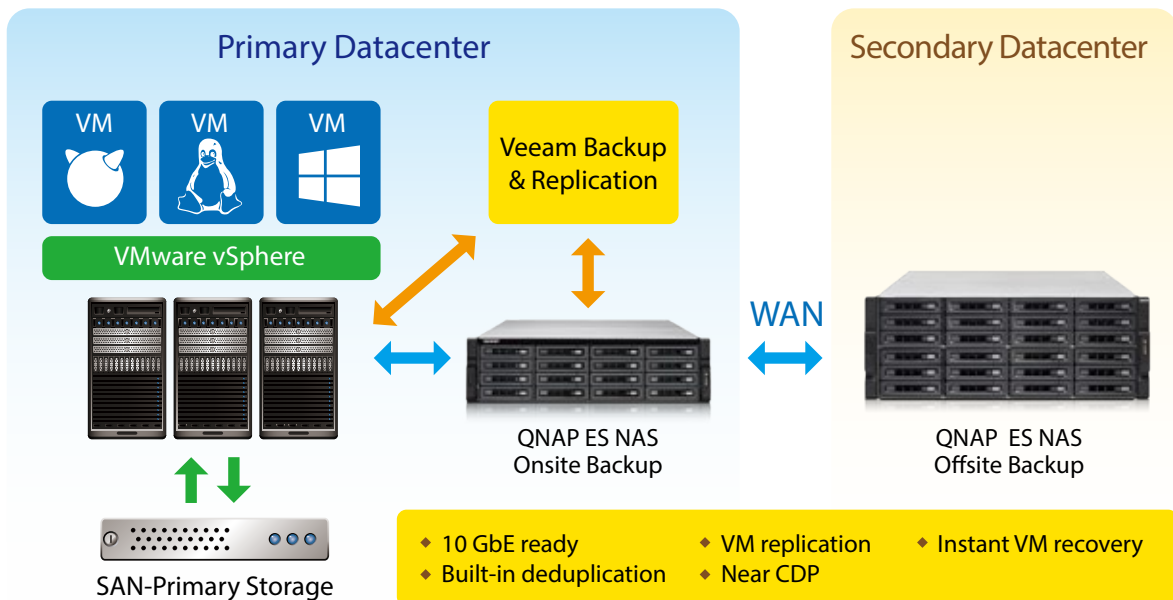

Solution for Hyper-V

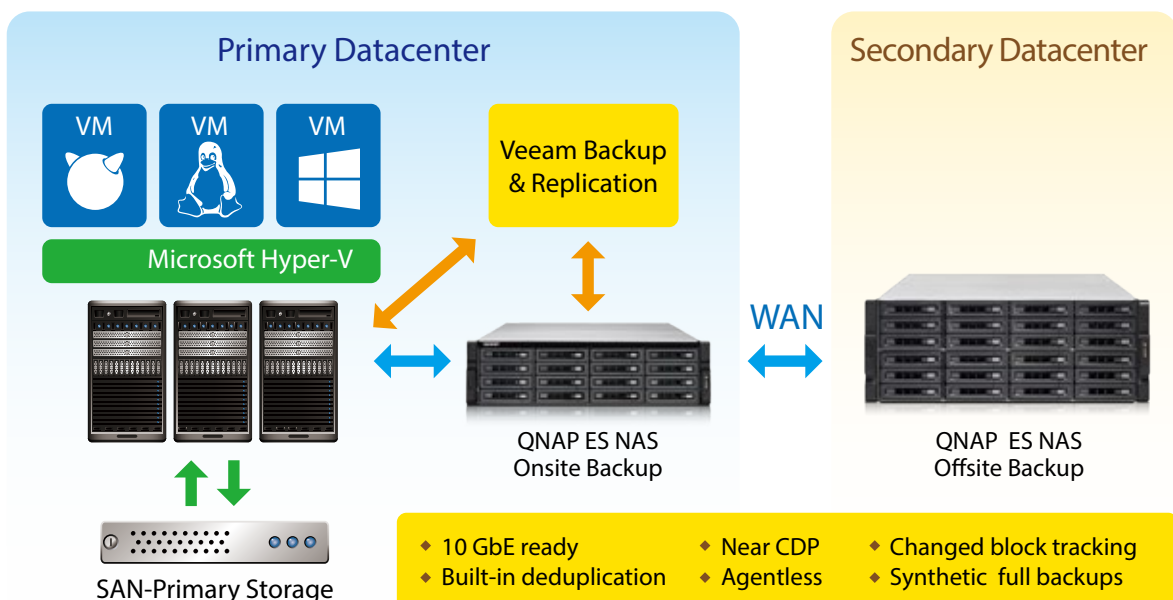

Multiple data protection mechanisms

The persistent and evolving threat landscape has created a need for smarter security solutions. Developing a comprehensive enterprise security strategy can facilitate greater control over your threat management activities and help improve protection of your critical data assets. QNAP helps you to minimize the risk of data breaches with our six data protection mechanisms, allowing you to focus more on using your data rather than worrying about it.

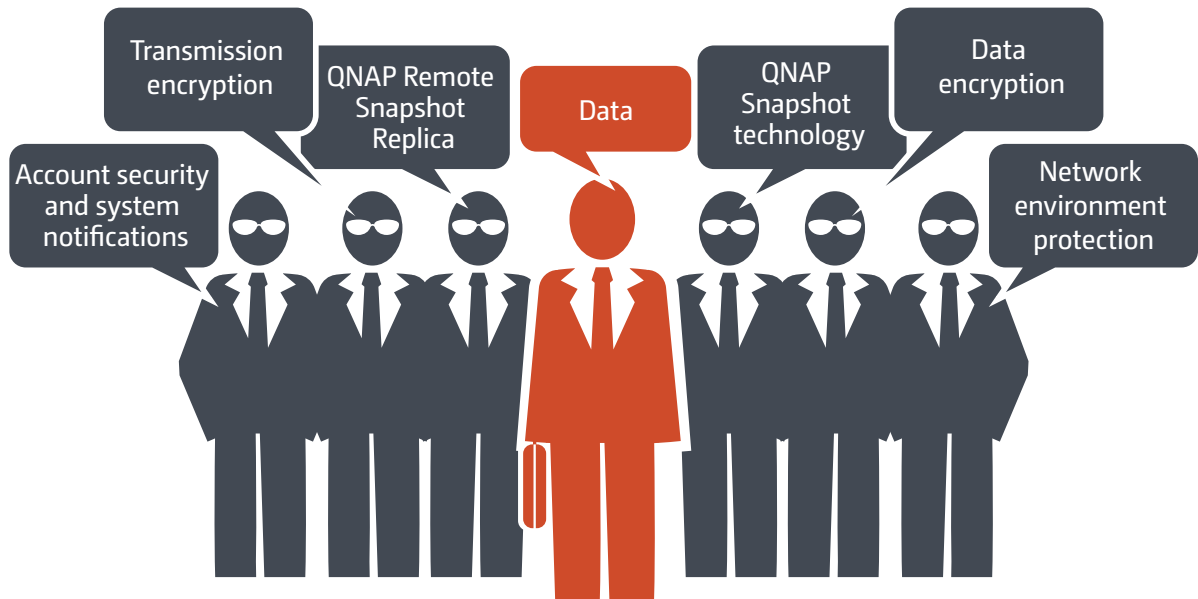

1. Network environment protection

Connection management (black/white list)

Allow or deny specific IP addresses or subnets to connect to the NAS. This increases connection safety by creating lists of allowed and blocked IP addresses. For example, block an IP address from accessing the ES1642dc/ES1640dc for one hour, one day, or permanently based on the criteria that it has over five failed login attempts in the last minute. Servers of the blocked IP will be unable to connect to the ES1642dc/ES1640dc. Block a user who has stayed online for too long or logged in from suspicious IPs to enhance system security further.



Service binding

The ES1642dc/ES1640dc are equipped with multiple Ethernet ports, and can permit data access through every port. Service binding allows users to bind network interfaces with certain services (e.g. critical company data can be accessed only by specific personnel through specific protocol or allowed internal IPs) to enhance system security. In addition to security protection, service binding with LAN ports can ensure critical services get dedicated bandwidth.

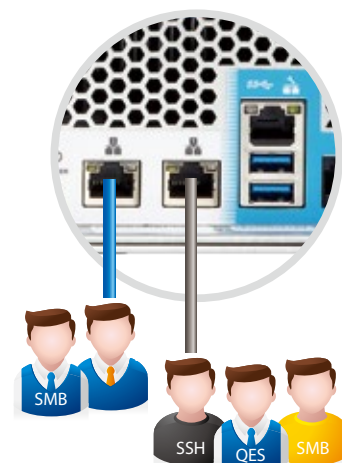

2.Account security and system notifications

Push service

In addition to email and SMS, you can get messages sent to your mobile devices in the event of a system failure or other warnings. This keeps you updated with the latest system status so that you can take immediate action to rectify the situation and reduce the risk of data loss.

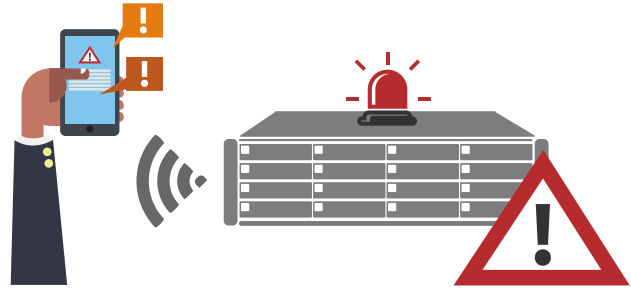

3.Protection by transmission encryption

Network transmission encryption

Advanced AES encryption ensures the security of shared folders. Without the key, no one can access the data in encrypted folders or files. Data transmitted over the Internet can also be encrypted to protect data security when using services such as FTP, WebDAV or in File Station. QNAP NAS provides SSL connectivity, and SSH encryption to secure data transmission and authentication. System administrators can restrict access to HTTPS (SSL over HTTP) encrypted connections. SFTP is also supported for transmission security and file access. The SSH encrypted connection provides another layer of protection for data transmission over public networks.

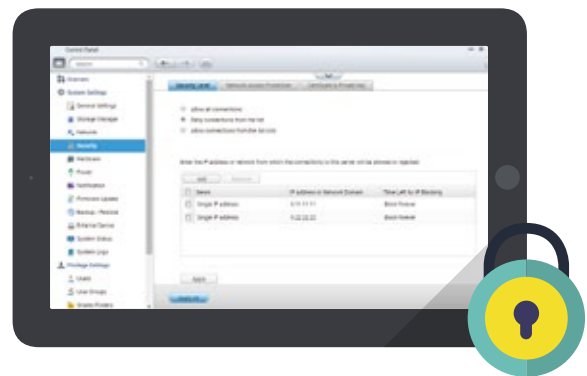

4.Data encryption

Shared folder and LUN encryption

QES offers LUN/shared folder encryption to protect the data stored on the ES1642dc/ES1640dc. The system will ask for the encryption key when mounting the encrypted LUN and the data is inaccessible without it. This function effectively protects data from being accessed if the entire device or individual drives are stolen.



5.QNAP Snapshot

QNAP's whole volume/ LUN Snapshot employs Copy-on-Write technology to record file state. If system failures occur, you can immediately revert the system to a specific state earlier in time.

6.SnapSync

By using the SnapSync function in Backup Station, you can also back up snapshots to a remote site.

With so many layers of protection, you will never worry about data loss again.

 For more information on Snapshot, refer to the chapter about Snapshot and SnapSync.

The all-new, all-inclusive operating system - QES 1.1.2

Engineered from the popular system architecture of the QNAP QTS OS with its simple and intuitive interface, QES enables consolidated management of various storage systems across different product lines and a reduced learning curve. From virtual desktop to the cloud, the QES OS on the ES1642dc / ES1640dc not only provides a solid foundation for rapid server virtualization and applications for remote virtual desktop but also paves the way for rapid hybrid cloud infrastructure provisioning.

Simple and intuitive QES desktop

The QES intelligent desktop allows you to easily operate the ES1642dc/ES1640dc without prior knowledge. It provides convenience access to all management tasks, including launching the applications, creating desktop shortcuts and monitoring system status.



Multitasking vs. customized desktop

The new QES system dramatically improves your efficiency by allowing you to open multiple windows and run multiple tasks without waiting for the previous one to end. You can minimize running apps onto the tool bar and switch between them. With QES's multi-desktop design, you can drag and drop a desktop icon from the Main Menu to any one of the 3 desktops or on top of another icon to group them together to create a personalized desktop for greater efficiency.



Smart dashboard

The system status displays immediately with a single click on the lower-right corner of the desktop. Open the smart dashboard to obtain a quick view of important information including system health, disk information and health, resource monitoring, storage space, scheduled tasks, device information, and firmware information. Drag and drop dashboard functions to the desktop to monitor them at any time. Moreover, in the event of a critical failure (hard disk corruption, etc.) the smart dashboard will flash and prompt a system administrator to take immediate action to recover data and to prevent the loss of data.



File Station manages all files from a single management window

Just like a file explorer on your PC, File Station lets you easily carry out common tasks operations such as rename, copy, move, delete and compress/uncompress. Move files from a local PC/Mac to File Station by drag-and-drop to upload the files to the NAS easily. Moreover, enable mutual sharing on a shared folder by allowing file upload to the folder.

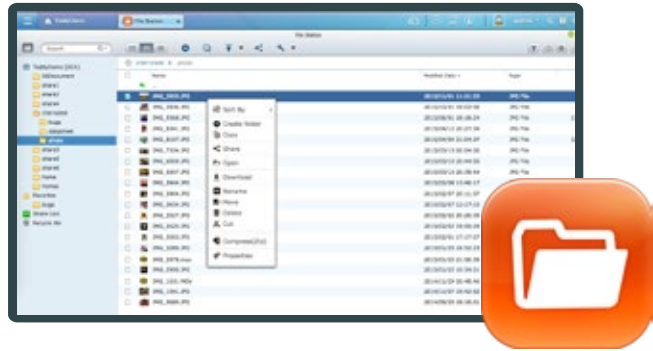

Newly added sharing functions

Users can share links from their own email account with the pre-configured SMTP server. Or they can create share links only and copy & paste it into forums, websites, and instant messengers for others to access them. In addition, enable Mutual file sharing to easily share several files in a shared folder with friends via a Share Link. By enabling the “Allow file upload to this folder” option, your friends will be able to upload files to your File Station without a user account. Set an expiration time for shared files.

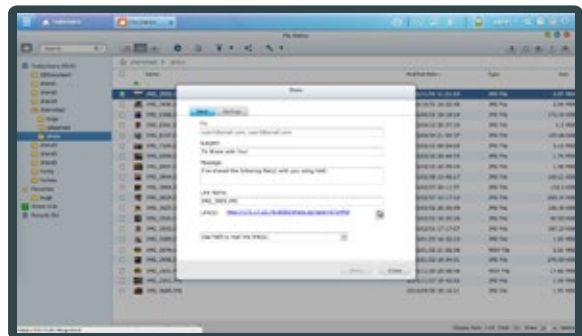

myQNAPcloud cloud access service for easy remote access

Following the setup wizard you can effortlessly create your personal or private cloud. With myQNAPcloud, you can always enjoy the services of your ES1642dc/ES1640dc safely and conveniently.

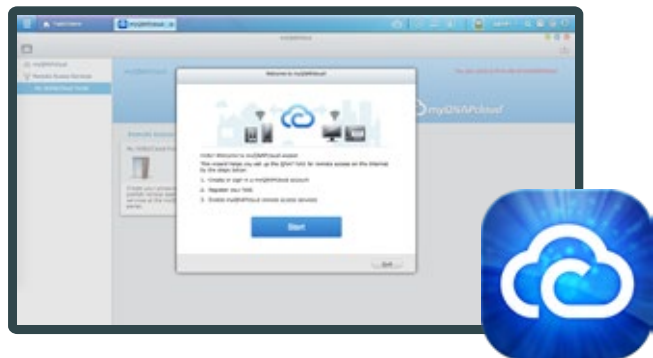

myQNAPcloud ID

Access your ES1642dc/ES1640dc by signing into your myQNAPcloud portal (www.myqnapcloud.com) with “QID” , a unique ID for you to access your NAS and securely share your private data and files. The myQNAPcloud web portal (www.myqnapcloud.com) is a easy-to-use interface that allows you to enjoy the convenience of accessing multiple QNAP NAS devices from a central Internet portal.

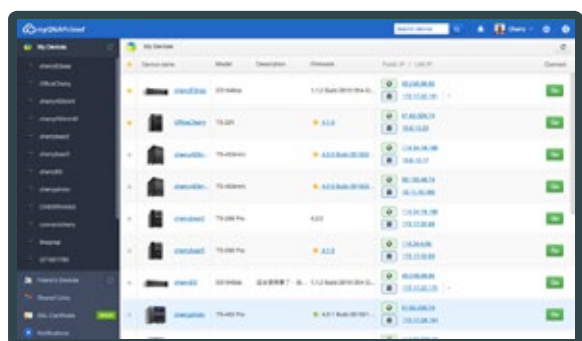

Uninterruptible power supply (UPS)

Activate UPS support to ensure the ES1642dc/ES1640dc performs an orderly shutdown in the event of an electricity supply failure. In the event of a power failure, the ES1642dc/ES1640dc will shut down automatically or enter the auto-protection mode by probing the power status of the connected UPS unit. Set up the function by clicking QES "Control Panel" > "System Settings" > "External Device" > "UPS".

UPS with SNMP management

When the ES1642dc/ES1640dc and the SNMP-based UPS server connect to the same network, you can enter the IP address of SNMP UPS server to set up the power failure notification.

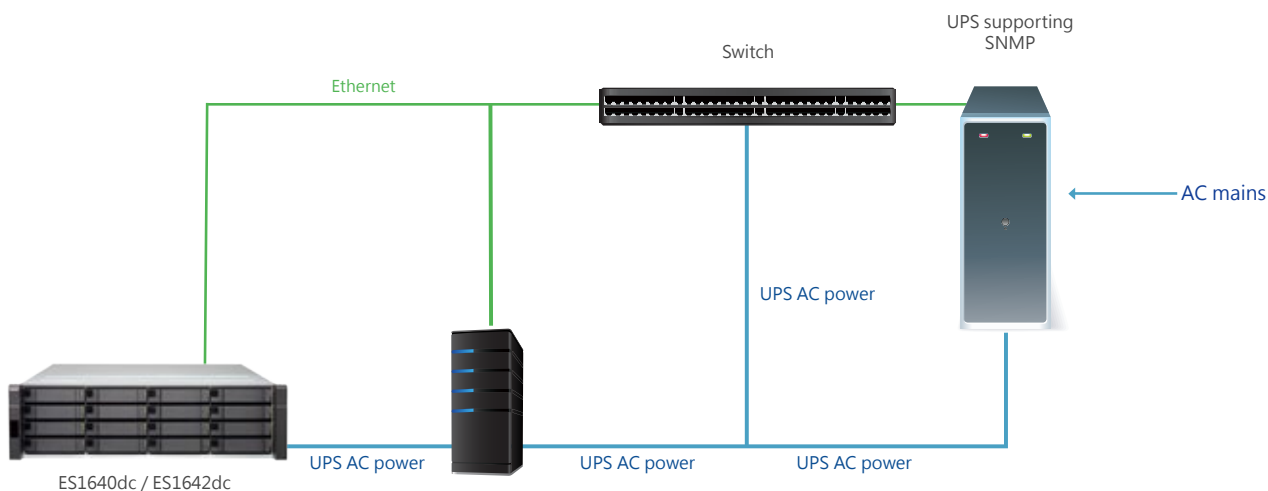

Backup Station

Seeing the need for managing enormous amounts of data stored on different storage infrastructures and devices, we offer a comprehensive backup and recovery solution to back up not only files for all devices on the LAN, but also for remote-site NAS units and servers. This comprehensive solution consists of applications and utilities that allow data to be backed up to a QNAP NAS, on which data can also be backed up to external devices or remote servers.

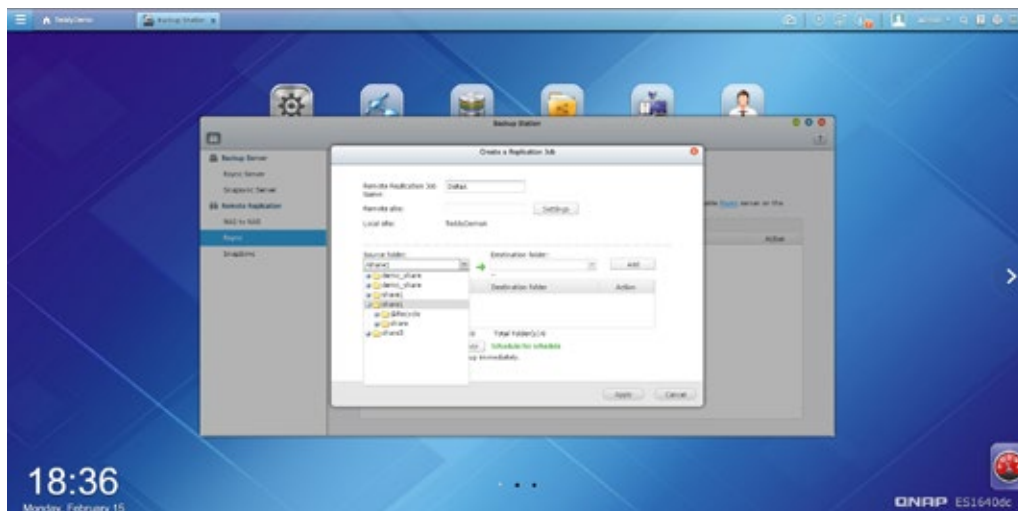

Remote-site backup and synchronization

Backing up data to your ES1642dc/ES1640dc from other Rsync servers or vice versa is a simple and easy process. Your computer or your NAS can be the source, destination, or relay server during the backup process. You can choose to use the NAS-to-NAS function instead of Rsync in the Backup Station if the other site is a QNAP NAS.

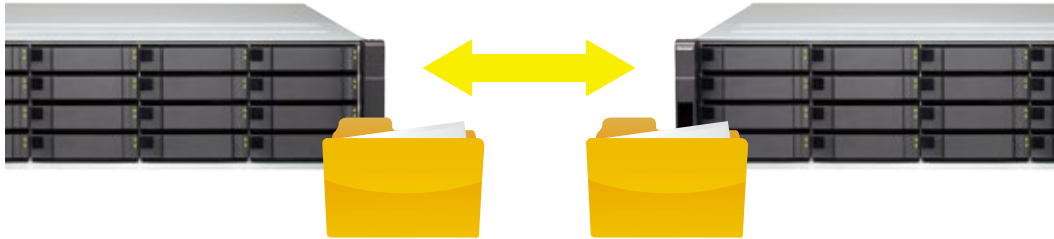

Backup from computers to NAS

With the Rsync service on the QNAP NAS, backing up data to your ES1642dc/ES1640dc from the other Rsync servers or vice versa is a simple and easy process. Your computer or your NAS can be the source, destination, or relay server during the backup process. You can choose to use the NAS-to-NAS function instead of Rsync in the Backup Station if the other site is a QNAP NAS.

1. NetBak Replicator

Windows users can install the free QNAP NetBak Replicator utility to back up files from Windows PC - entire disk drives, documents, pictures, music, videos, fonts, emails, and more – to one or multiple QNAP NAS units. With simple clicks, you can set up real-time backup, scheduled backup and auto-backup. You can set power off after the backup is finished to save energy, file filtering to to exclude files not to back up, and email notification when backup is completed.

2. 3rd party backup software

QNAP ES1642dc / ES1640dc is compatible with various renowned backup software such as Acronis® True Image and Symantec® Backup Exec. Users that have adopted such backup software can immediately back up data from other sources to the QNAP ES1642dc/ES1640dc.

3. Virtualization backup server

QNAP ES1642dc / ES1640dc is compatible with VMware® ESX server, Citrix® XenServer, and Microsoft® Hyper-V, enabling your QNAP NAS to be seamlessly integrated to a virtualized environment as extended storage for data backup.

JBOD pool roaming

The JBOD Express enables quick backup or migration of large amounts of data to local or remote sites without using any network bandwidth. Connect expansion enclosures (EJ1602/EJ1600) that are specially designed to pair with the ES1642dc / ES1640dc and the data can be migrated offline easily to another NAS through the JBOD enclosure. Data migration via JBOD enclosures can also be used for replication seeding.

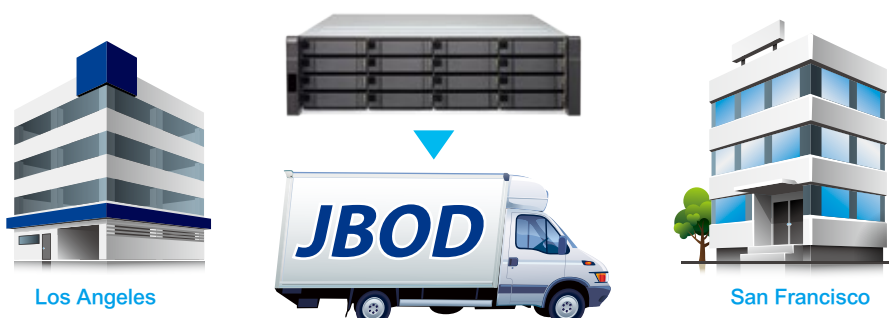

Mobile apps

Nowadays people depend on their mobile device instead of computer for internet access every day. With all these apps offered by QNAP, you'll get more done across your day and your devices while keeping your data secured.

Versatile and real-time file management

Remotely upload/download, and browse files with a variety of formats from your QNAP NAS. The thumbnail display aids in finding the document that you search for. You can also download the file to read it offline on your device.



Easy and real-time cloud management

Manage users and shared folder privileges on your mobile device. Check user settings, user group settings, and shared folder status. Check backup task information and initiate saved backup tasks with the sleek and easy-to-use interface. Moreover, monitor your system information, connection records, system events, and manage services (e.g. restart/shutdown and Wake-on-LAN).



Computer utilities

QNAP offers many computer utilities for you to connect to your NAS effortlessly. With all these utilities, you'll be able to easily install a ES1642dc/ES1640dc and quickly set up backup jobs.

Qfinder Pro to quickly search, connect and set up your QNAP NAS

Qfinder Pro is a utility to quickly find, access and set up the ES1642dc / ES1640dc over a LAN. Install Qfinder Pro on your computer, open it, and double click your QNAP NAS name, and the login page is ready for you.

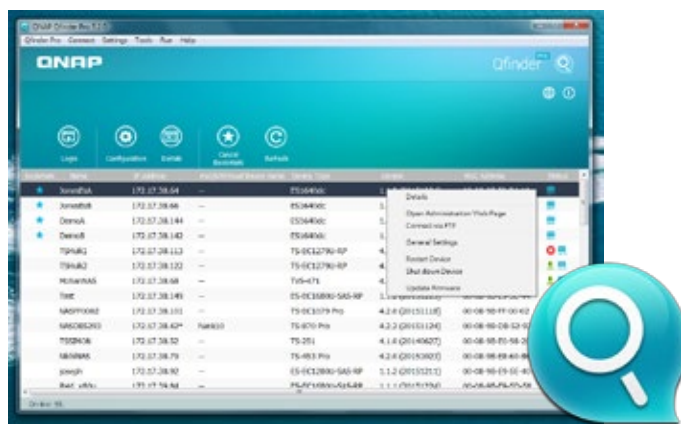

NetBak Replicator for a hassle-free way to back up data on PC

The QNAP NetBak Replicator is a free utility that helps you easily back up files from Windows® PC - entire disk drives, documents, pictures, music, videos, fonts, emails, and more - to the ES1642dc/ES1640dc. The operation is very simple. You can set up the backup task in just a few clicks using NetBak Replicator by the setting real-time synchronization, scheduled backup and auto-backup from multiple PCs to the ES1642dc/ES1640dc. NetBak Replicator also supports backing up to a remote server via FTP and WebDAV through the Internet.

vSphere Client plug-in to manage VMware datastores within vSphere Client

QNAP NAS supports VMware vSphere® Client Plug-in that allows managing VMware® datastores on the ES1642dc / ES1640dc directly from the VMware vSphere® client console. In a large-scale server virtualization environment, management is centralized and straightforward. Administrators can easily control the status of the QNAP NAS and datastores and create additional datastores to multiple VMware ESXi™ hosts in just a few clicks.

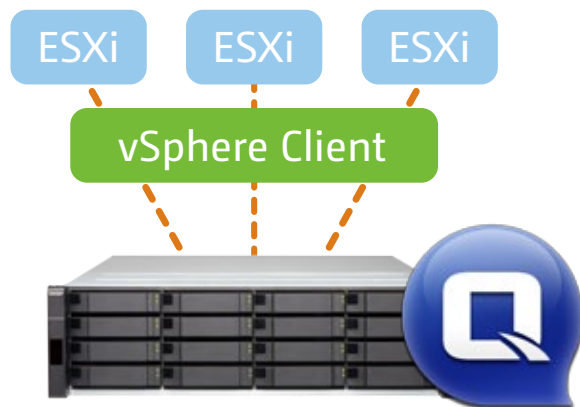

Enterprise case studies

Case 1: Deploying a remote virtual desktop infrastructure (VDI)

The QNAP ES NAS series can be deployed as robust desktop virtualization solutions that enable IT organizations to reap the benefits of traditional server-based computing without the challenges that often accompany server-based solutions. By leveraging the benefits and advantages of VDI, IT organizations can transition away from the era of distributed PC computing towards cloud computing and the delivery of user desktops as a service. Segregation of operating environments from applications provides an inherent layer of security. Administrators can consolidate and maintain a small number of core desktop images or pools that everyone can use. Implementing a standardized solution drives down the total cost of ownership (TCO) and helps minimize the complexity and unpredictability of a customized solution.

VDI centralizes the access control and confines corporate data to the data center and provides advanced security measures. VDI enables organizations to extend the value of their infrastructure and desktop virtualization environments to encompass not only desktops in the data center, but also applications and the delivery of these environments securely to remote clients. However, the VDI administrator faces critical challenges that need to be addressed before a desktop can be made ready for the end user. One such challenge is what is termed VDI 'Boot storm'. A boot storm occurs when numerous users of a VDI all attempt to boot simultaneously from a shared storage device, like at the start of a workday, causing a substantial spike in IO traffic and putting a temporary strain on the system hosting the virtual machines, including storage, network connectivity, and processor resources.

Implementing a read cache across an array of SSDs is the most common remedy to resolve the increased workload during workload ramp-up, and unexpected resource spikes. The QNAP ES1642dc and ES1640dc with QES fully support an SSD read cache to maintain the required IOPS. Additionally, where VDI creates a great deal of data redundancy (hundreds of operating systems connect to a single clone) QES supports block-level de-duplication and compression to further improve disk utilization and reduce power requirements, significantly reducing overall TCO.

Virtual desktop application scenario

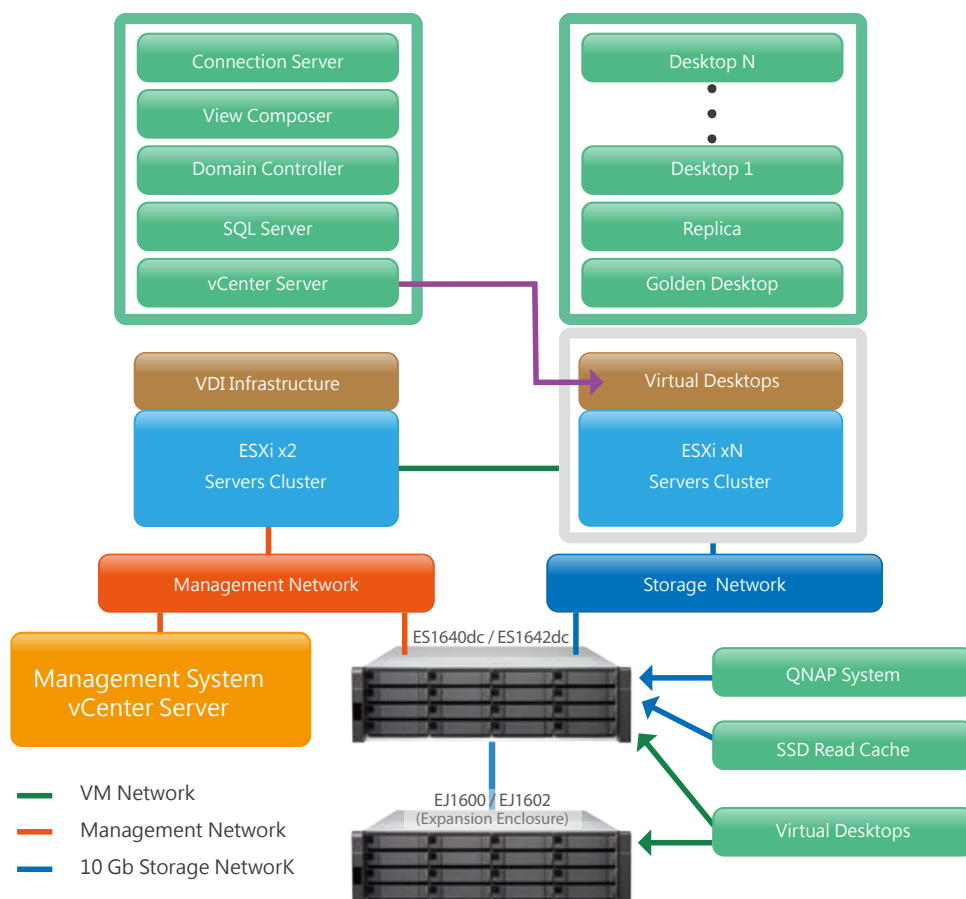

Case 2: Easily build a professional surveillance system with over 500TB storage capacity

Robust IP camera surveillance systems have become increasingly popular across the entire spectrum of business. The QNAP ES NAS series (with high-availability, fault-tolerant, dual-active controllers) deliver uninterrupted services, providing the ideal foundation for building a robust surveillance system.

To safeguard business assets and property requires flexible and expandable storage with a near-zero downtime file system. The robust, scalable, and easy to administer ZFS file system of the QES operating system can instantly build over 500TB storage capacity and is capable of automatic Silent Data Corruption healing for persistent high levels of availability. Built-in 256-bit checksums end-to-end validate data stored further ensuring data integrity, while, the Copy-On-Write (CoW) mechanism employed by snapshots facilitate enterprise-class backup and recovery.

Quickly deploy a digital surveillance system

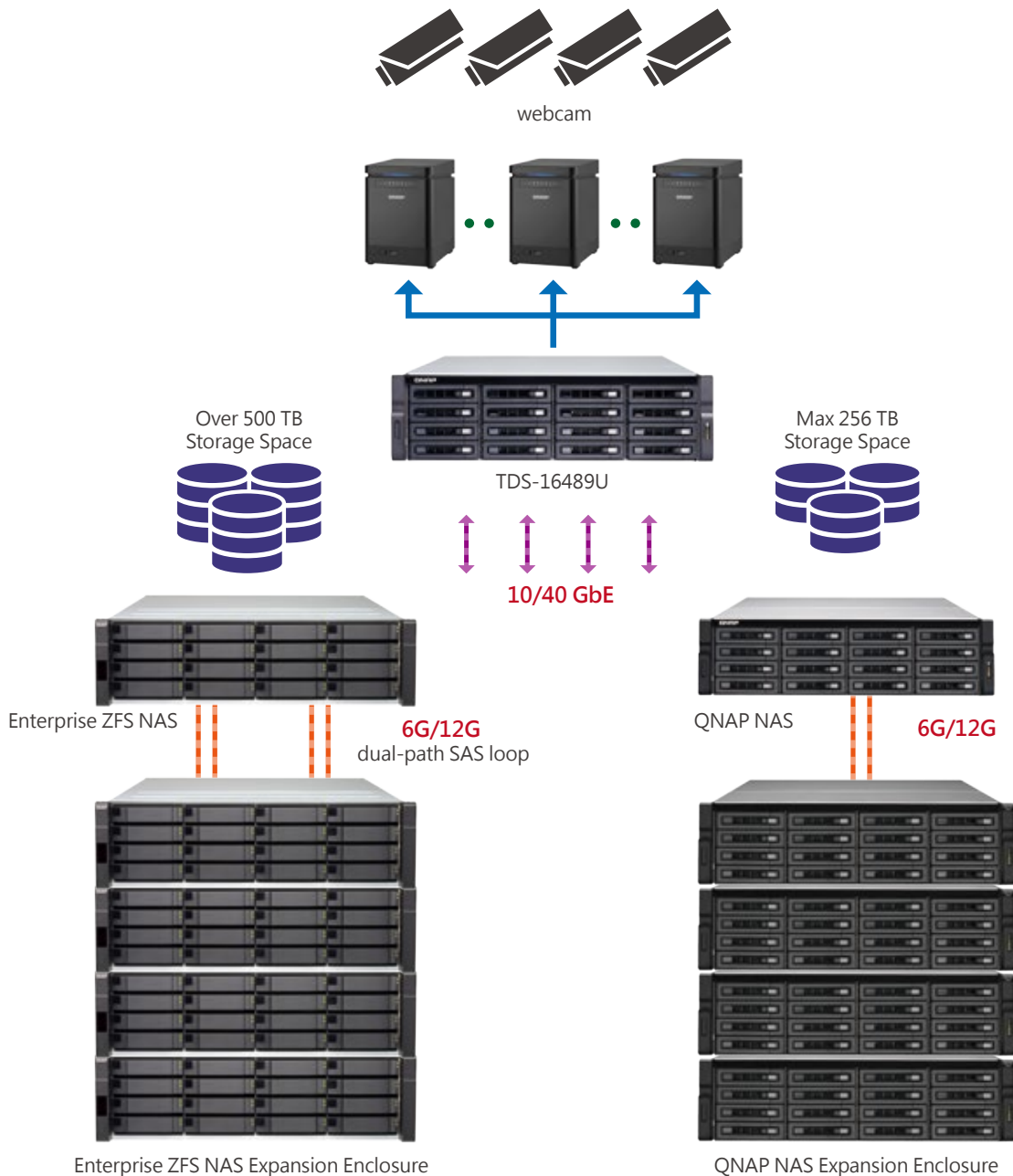

Enterprise case studies

Case 3: Building a high-performance digital workflow solution

As media and entertainment production workflows move to all-digital content from beginning to end, they face a common dilemma: the massive amounts of data created in 4K filmmaking overwhelm all but the most advanced environments. To handle the demands of post-production data management in an all-digital world, the industry is increasingly turning to Enterprise-Class NAS for business-critical storage solutions. In addition to powerful and reliable workstations in each production node but a shared storage device with huge capacity and high availability is of paramount importance for a smooth production process. The QNAP ES1642dc and ES1640dc are equipped with fault tolerant, dual-active controllers to ensure, up to 500TB storage expansion, and near zero-downtime to meet these requirements.

... To upgrade network transmission rate, The QNAP ES1642dc and ES1640dc fully support ODX (Offloaded Data Transfer) technology. When a Windows workstation running a newer version of the Windows™ OS connects to an ES1642dc/ES1640dc, the network bandwidth can be lowered to 0.1%. This offers a seamless migration to/ integration with higher-end models reducing the problem of network congestion.

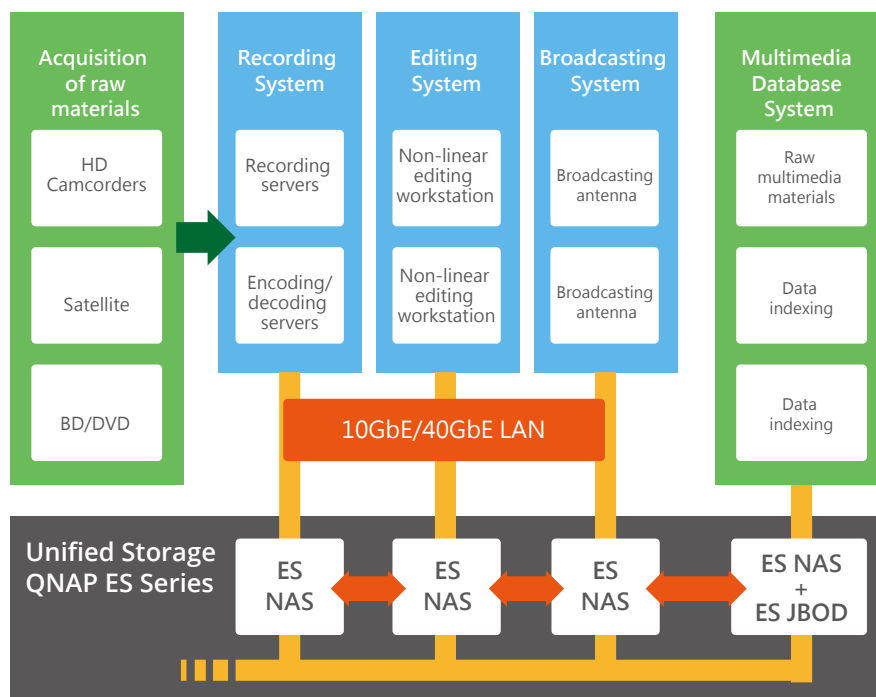
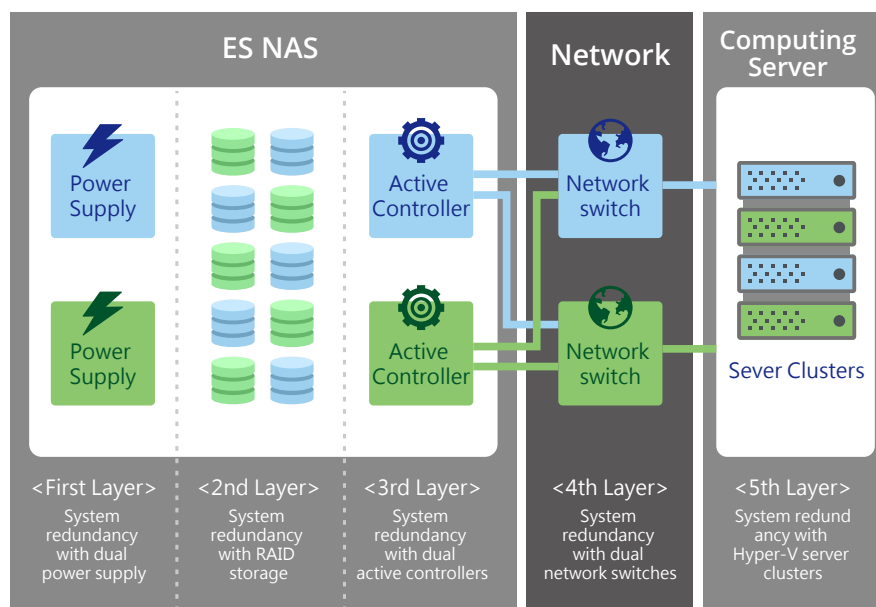

Case 4: Lower TCO Enterprise cloud storage solutions

Cloud has moved beyond the hype phase and is now a reality for most organizations. OpenStack® leads the way in open source cloud computing software for private clouds with Swift® and Ceph® serving as two popular distributed and cloud storage systems that provide object-based access to data. Most uses of the OpenStack® platform are at the Internet Service Provider (ISP) and Internet Content Provider (ICP) level. OpenStack® is popular at this level because of its native ability to (multipart) access large objects. However, accessing and managing a single object remains an acute problem. The QNAP ES1642dc and ES1640dc fully support Cinder® resolving this issue and enable the ES1642dc and ES1640dc to be used seamlessly as a block storage resource for Cinder. The QNAP QES OS fully supports HPE Helion® to provide enterprises simpler, and more reliable private hybrid-cloud solutions, to ensure that enterprises can fully leverage fault tolerant, high availability services in dense virtualized environments. QES fully supports using HPE Helion® OpenStack® to build an OpenVDI® on-demand agile cloud service. The ES1642dc and ES1640dc with QES enable you to get started quickly with a wide range of validated reference designs for cloud platforms, including VMware®, Microsoft Azure™ and KVM-based private cloud deployments, and enterprise applications such as Microsoft Exchange®, Active Directory®, and Microsoft SQL Server®. All QNAP solutions are backed by world-class services, education, and proactive support to reduce time-to-production and enable you to operate at peak efficiency.

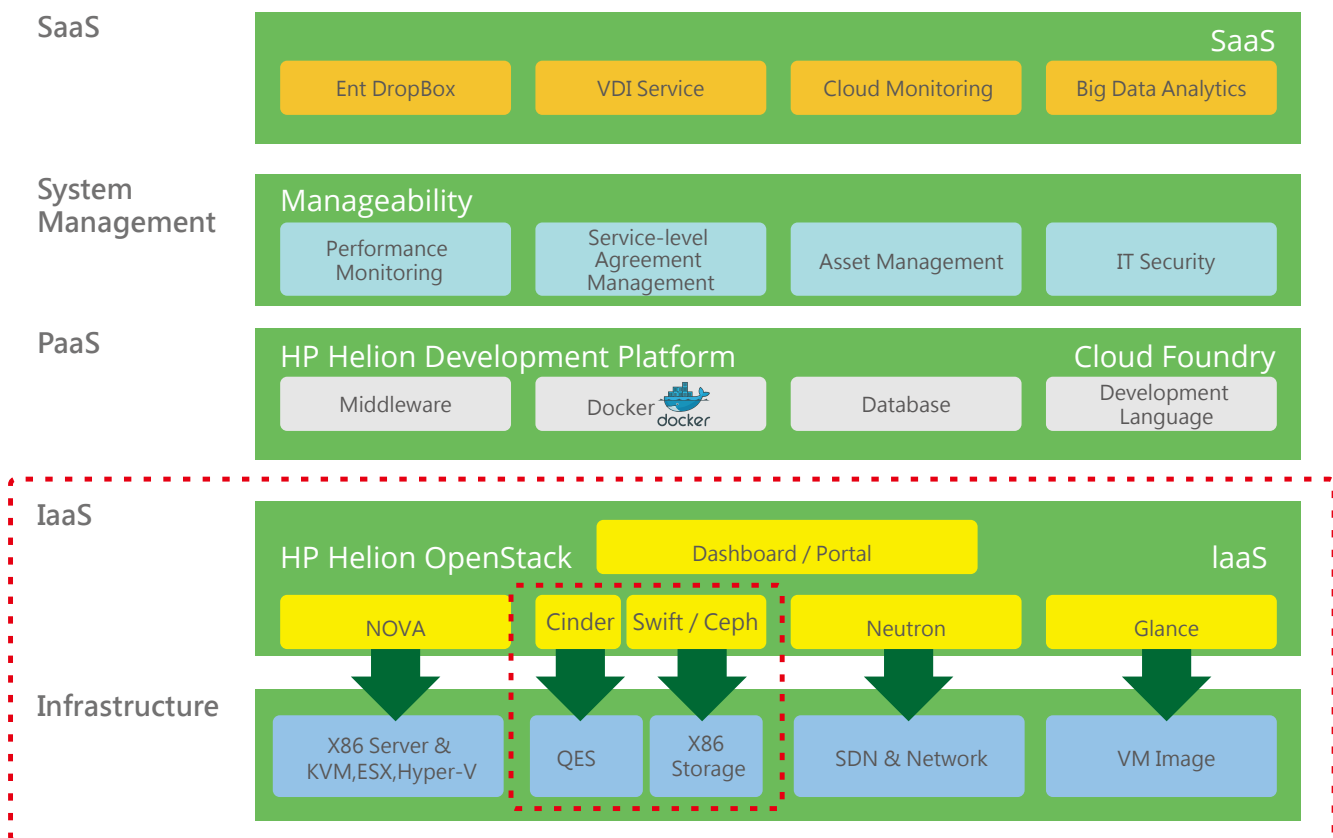

Tell us your goals, in return we will provide you with the best cloud solution for your business.

QNAP will help you ensure business continuity and access to your critical applications, to mitigate risk and meet regulatory compliance requirements. Your applications will be available and secure with compliant data-at-rest encryption, integrated disaster recovery, including VM-centric remote and cloud backups, and metro-level synchronous replication. We have built a world-class pre-sales team and strive to quickly deliver IT services and respond to fast changing market conditions. To help our customers in quick provisioning and deployment and eventually drive compelling ROI, we also publish other related materials such as installation guides and technical white papers.

Hardware specifications



Model	ES1642dc	ES1640dc
Form Factor	3U, Rackmount	
Processor	Intel Xeon E5-2420 v2 (2.2GHz, 6 core, 15MB L3, 80W TDP)	
Storage Controller (x2 for every system)	DDR3 ECC RDIMM 16GB x2 (total of 32GB) 16GB x 1 (NVRAM)	
Number of Disk Drives	16 x 2.5" /3.5" HDD and SSD	16 x 2.5" /3.5" HDD and SSD
HDD Interface	SAS 12Gb/s; backward-compatible to SAS 6Gb/s and SATA (SATA drives need SAS-to-SATA interposer boards)	SAS 6Gb/s backward-compatible to SATA (SATA drives need SAS-to-SATA interposer boards)
JBOD Expansion connectors (x2 for every system)	Two Mini-SAS 12Gb/s ports (SFF-8644)	Two Mini-SAS 6Gb/s ports (SFF-8088)
Battery-Backed Write Cache (x2 for every system)	M.2 2280 for NVRAM (SATA signal)	mSATA for NVRAM
10G LAN Port (x2 for every system)	Four, SFP+(Intel XL710-AM1)	Two, RJ45 (Intel X540-BT2)
PCIe expansion slots (x2 for every system)	PCIe Slot x8 (Gen3 x8) for 40GbE network cards PCIe Slot x4 (Gen2 x4): Pre-installed with a dual-port Mini-SAS adapter	
Fan module (x2 for every system)	Field-replaceable fan module (60*60*38mm, 16000 RPM/12v/2.8A x 3)	
Power Supply	770W 1+1100-240V@50/60Hz (hot-swappable, redundant)	
Copy-To-Flash (BBU)	12V, 2200 mAh	
Temperature	0° C to 40 °C	
Relative Humidity	5 % to 95 %	
Dimensions (mm)	618 (Depth) x 446.2 (Width) x 132 (Height), excluding the handles	
Weight (Net)	Net weight (NAS only): 26.75 kg/ 58.85 lb Gross weight (with packing and accessories): 32.87 kg/ 72.31 lb	

JBOD Hardware specifications



Expansion Model	EJ1602	EJ1600
Form Factor	3U, Rackmount	
Number of Disk Drives	16 x 2.5" /3.5"	
HDD Interface	SAS 12Gb/s backward-compatible to SAS 6Gb/s and SATA (SATA drives need SAS-to-SATA interposer cards)	SAS 6Gb/s backward-compatible to SATA (SATA drives need SAS-to-SATA interposer cards)
JBOD expansion connector (x2 for every system)	Two Mini-SAS 12Gb/s ports (SFF-8644)	Two Mini-SAS 6Gb/s ports (SFF-8088)
Fan module (x2 for every system)	Hot-swappable fan module (60*60*38mm, 16000 RPM/12v/2.8A x 3)	
Power Supply	450W 100-240V@50/60Hz (hot-swappable, redundant)	
Temperature	0° C to 40 °C	
Relative Humidity	5 % to 95 %	
Dimensions (mm)	618 (Depth) x 446.2 (Width) x 132 (Height), excluding the handles	
Weight (Net)	Net weight (NAS only): 24.11 kg/ 53.04 lb Gross weight (with packing and accessories): 32.48 kg/ 71.46 lb	

Accessories

Category	Order P/N	Description
SSD Card	SAS-12G2E	Dual-wide-port storage expansion card, SAS 12Gbps
Rail kit	RAIL-E02	E02 series (Chassis) rail kit, max.load 57kg
RAM	RAM-16GDR3-RD-1600	16GB DDR3 RDIMM, 1600MHz
Cable	CAB-SAS10M-8644	MiniSAS external (SFF-8644 to SFF-8644), 1.0m
	CAB-SAS05M-8644	MiniSAS external (SFF-8644 to SFF-8644), 0.5m
	CAB-SAS10M-8088	MiniSAS external (SFF-8088 to SFF-8088), 1.0m
	CAB-SAS05M-8088	MiniSAS external (SFF-8088 to SFF-8088), 0.5m
	CAB-SAS10M-8644-8088	MiniSAS external (SFF-8644 to SFF-8088), 1.0m
BBU	BBU-A01-2200MAH	Battery Backup Unit For NVRAM Module
SATA Board	LSISS9252	SATA-to-SAS Interposer Board (Please purchase from Avago)

10/40GbE NIC compatibility list

10GBASE-T Interface		
Category	Order P/N	Description
QNAP	LAN-10G2T-U	Dual-port 10 GbE network expansion card for rack mount model, low-profile bracket, cat6A cable
Intel	X520-T2 (E10G42BT)	Dual-port 10GbE network expansion card for tower models, desktop bracket, cat6A cable

SFP+ OPTIC Interface		
Category	Order P/N	Description
QNAP	LAN-10G2SF-MLX-U	Dual-port 10 Gigabit network adapter
Intel	X520-SR2 (10G42BFSR)	Dual-port 10 Gigabit network adapter, short range optical cable

SFP+ DAC (Direct Attach Copper) Interface		
Category	Order P/N	Description
Intel	X520-DA2 (E10G42BTDA)	Dual port 10 Gigabit network adapter, SFP+ direct attach copper cable

QSFP Interface		
Category	Order P/N	Description
QNAP	LAN-40G2SF-MLX-U	Dual port QSFP 40 Gigabit network adapter

Software specifications

Operating System

- QES 1.1 (based on FreeBSD)

Supported Clients

- Windows 7 (32/64-bit), Windows 8 (32/64-bit), Windows 10 (32/64-bit), Windows Server 2008 R2/2012/2012R2
- Apple Mac OS X
- Linux & UNIX

Supported Browsers

- Microsoft Internet Explorer 10+
- Mozilla Firefox 8+
- Apple Safari 4+
- Google Chrome

Multilingual Support

- Chinese (Traditional & Simplified), Czech, Danish, Dutch, English, Finnish, French, German, Greek, Hungarian, Italian, Japanese, Korean, Norwegian, Polish, Portuguese (Brazil), Romanian, Russian, Spanish, Swedish, Thai, Turkish

File System

- ZFS

Networking

- TCP/IP (IPv4 & IPv6)
- 10 /40 Gigabit NICs with jumbo frame (LACP, Load Balance, Failover, Round Robin)
- Service binding based on network interfaces
- Proxy client
- DHCP client
- Protocols: SMB2/SMB3, NFS v3/NFS v4, FTP, FTPS, TFTP, HTTP, HTTPS, SSH, iSCSI, SNMP, SMTP, and SMSC
- Bonjour Discovery

Security

- Network access protection with auto-blocking: SSH, HTTP(S), FTP, SMB
- SMB host access control for shared folders
- FIPS 140-2 validated AES 256-bit shared folder and LUN data encryption
- Importable SSL certificates

Storage Management

- Storage space utilization monitoring
- Storage pool with RAID 0, 1, 5, 6, 10, 50, 60, RAID TP, Triple Mirror
- Global hot spare
- SSD read cache
- NVRAM write cache (BBU-protected)
- Scheduled Backup Battery Unit (BBU) learning
- Supports share folder/LUN with thin provisioning
- Supports LUN with instant provisioning
- Supports share folder quota

- Supports space reclaim
- Supports snapshots
 - Supports Shared Folder/LUN snapshot
 - Snapshot manager
 - Snapshot clone
 - Snapshot agent for Windows VSS and VMware
- Support inline deduplication for Shared Folder/LUN
- Support inline compression for Shared Folder/LUN
- Support inline encryption for Shared Folder/LUN
- Support WORM (Write Once Read Many) for Shared Folder
- Online LUN expansion
- Online Share Folder quota expansion
- Online storage pool expansion
- Hard drive S.M.A.R.T.
- S.M.A.R.T predict data migration
- Time-Limited Error Recovery (TLER)
- Storage expansion via QNAP EJ-1600 series expansion units
- JBOD ID Reinitialized
- JBOD enclosure roaming
- RAID recovery
- Checksum for end-to-end data integrity
- Silence error detection and self-healing
- Pool scrub for data verification

High Availability

- Active-Active/Active-Standby dual controller for NAS
- Active-Active dual controller for JBOD expander
- Automatic hardware error detection and failover
- Automatic failback when hardware recovered
- Data port network failover
- Management port network failover
- Near zero downtime high availability
- Dual SAS link loop
- MPIO and ALUA for iSCSI high availability
- Link aggregation for network high availability
- Support SMB3 Continuous Availability (CA)

Power Management

- Wake on LAN
- Internal hard drive standby mode
- Automatic power on after power recovery
- Network UPS support with SNMP management

Access Right Management

- Batch users creation
- Import/Export users
- User quota management
- Local user access control for SMB and FTP
- Subfolder permissions support for SMB, FTP, and File Station

Domain Authentication Integration

- Microsoft Active Directory support
- LDAP client
- Domain users login via SMB, FTP, and File Station

Administration

- Multi-window, multi-tasking based system management
- Movable icons and personalized desktop
- Smart toolbar and dashboard for neat system status display
- Smart fan control
- SNMP (v2 & v3)
- Resource monitor
- Network recycle bin for file deletion via SMB and File Station
- Automatic Cleanup
- File Type Filter
- Comprehensive logs (events & connection)
- Syslog client
- System settings backup and restore
- Restore to factory default
- Command Line Interface (CLI)

File Server

- Shared folder for SMB, NFS and FTP
- File sharing across Windows, Mac, and Linux/UNIX
- Windows ACL
- Advanced folder permissions for SMB, FTP

FTP Server

- FTP over SSL/TLS (Explicit)
- FXP support
- Passive ftp port range control

File Station

- Supports sharing download links and upload links
- Supports sharing to other NAS users
- Drag-n-drop Files via Chrome and Firefox Browsers
- File Compression (ZIP or 7z)
- Creation of and sending download links for sharing public files with expiration date and password protection
- Mobile App: Qfile for file browsing and management

Backup Station

- Remote replication server over Rsync
- Remote replication server over SnapSync
- Scheduled backup
- Snapshot support for Rsync
- Compression, Dedup, and transfer rate limitation over SnapSync
- Desktop backup with QNAP NetBak Replicator for Windows
- Third party backup software support: Veeam backup & replication, Acronis True Image, Arcserve backup, EMC retrospect, Symantec Backup Exec, etc.

Virtualization

- Server Virtualization & Clustering
- VMWare vSphere (ESXi 5.5, 6.0)
- VMWare Block VAAI
 - Thin Provisioning with Space Reclamation

- HW Assisted Locking
- Full Copy
- Block Zero
- VMWare NAS VAAI
 - Space Reserve
 - Native Snapshot for Linked Clones
 - File Cloning
 - Extended Stats
- VMWare vSphere Client Plugin
- VMWare vSphere Web Client Plugin
- Citrix XenServer (6.2)
- Windows Server 2012 R2 Hyper-V
- Support Microsoft ODX
- QNAP SMI-S provider for Microsoft SCVMM
- QNAP VSS Hardware Provider
- QNAP Snapshot Agent for VMWare
- QNAP Snapshot Agent for Windows

Cloud

- OpenStack Cinder driver

iSCSI (IP SAN)

- iSCSI target with multi-LUNs per target (Up to 255 targets/LUNs combined)
- Support LUN mapping
- Support host ACL access
- Online LUN capacity expansion
- Support for SPC-3 persistent reservation
- Support ALUA
- Supports MPIO & MC/S
- iSCSI LUN snapshot and replication

Design and specifications are subject to change without notice.

The final key component of QNAP Enterprise Solutions !

ES1642dc / ES1640dc

Integrated with HP Helion platform for the last mile of private cloud infrastructure



- ◆ Snapshot Agent provides continuous and application-consistent snapshots during read and write process.
- ◆ SnapSync replicates local shared folders and iSCSI LUNs to a remote destination using snapshot technology, targeting only changed blocks.
- ◆ Dual controllers with dual-loop architecture tolerates single-node failure.
- ◆ QES with HPE Helion provides simpler, more reliable, private enterprise hybrid-cloud solutions.

QNAP Systems, Inc.

TEL : +886-2-2641-2000 FAX : +886-2-2641-0555 Email: qnapsales@qnap.com
Address : 3F, No.22, Zhongxing Rd., Xizhi Dist., New Taipei City, 221, Taiwan

QNAP may make changes to specification and product descriptions at any time, without notice.
Copyright © 2016 QNAP Systems, Inc. All rights reserved.

QNAP® and other names of QNAP Products are proprietary marks or registered trademarks of QNAP Systems, Inc.
All trademarks, service marks, trade names, trade dress, product names and logos appearing herein are the property of their respective owners including Microsoft, Intel, Advanced Micro Devices, Inc, HPE, OpenStack, VMware, Docker, Veeam, UNIX, and Linux.

Netherlands (Warehouse Services)

Email : nlsales@qnap.com
TEL : +31(0)107600830

India

Email : indiasales@qnap.com

Germany

Email : desales@qnap.com
TEL : +49-89-381562991

US

Email : usasales@qnap.com
TEL : +1-909-595-2782

China

Email : cnsales@qnap.com.cn
TEL : +86-400-628-0079

Thailand

Email : thsales@qnap.com
TEL : +66-2-5415988

