



# Dell Latitude 3379

## Owner's Manual

Regulatory Model: P69G  
Regulatory Type: P69G001



# Notes, cautions, and warnings

-  **NOTE:** A NOTE indicates important information that helps you make better use of your computer.
-  **CAUTION:** A CAUTION indicates either potential damage to hardware or loss of data and tells you how to avoid the problem.
-  **WARNING:** A WARNING indicates a potential for property damage, personal injury, or death.

© 2016 Dell Inc. All rights reserved. This product is protected by U.S. and international copyright and intellectual property laws. Dell and the Dell logo are trademarks of Dell Inc. in the United States and/or other jurisdictions. All other marks and names mentioned herein may be trademarks of their respective companies.

2016 - 08

Rev. A00

# Contents

<b>1 Working on your computer.....</b>	<b>8</b>
Safety instructions.....	8
Before working inside your computer.....	9
Turning off your computer.....	9
After working inside your computer.....	9
<b>2 System overview.....</b>	<b>10</b>
System top view.....	10
System front view.....	11
System back view.....	12
System side view – Left.....	12
System side view – Right.....	13
<b>3 Removing and installing components.....</b>	<b>14</b>
Recommended tools.....	14
Base cover.....	14
Removing the base cover.....	14
Installing the base cover.....	16
Battery.....	16
Removing the battery.....	16
Installing the battery.....	17
Power and volume control board.....	17
Removing the power and volume control board.....	17
Installing the power and volume control board.....	18
Solid State Drive (SSD).....	19
Removing the solid state drive (SSD) card.....	19
Installing the solid state drive (SSD) card.....	20
Coin cell battery.....	20
Removing the coin cell battery.....	20
Installing the coin cell battery.....	21
WLAN card.....	21
Removing the WLAN card.....	21
Installing the WLAN.....	22
Memory module.....	22
Removing the memory module.....	22
Installing the memory module.....	24
Speaker.....	24
Removing the speakers.....	24

Installing the speakers.....	25
System fan.....	26
Removing the system fan.....	26
Installing the system fan.....	26
Heat sink.....	27
Removing the heatsink.....	27
Installing the heatsink.....	28
LED board.....	28
Removing the LED board.....	28
Installing the LED board.....	29
Input/Output(I/O) board.....	30
Removing the Input/Output (I/O) board.....	30
Installing the Input/Output (I/O) board.....	31
Power connector.....	31
Removing the power connector port.....	31
Installing the power connector port.....	32
Keyboard daughter board.....	33
Removing the keyboard daughter board.....	33
Installing the keyboard daughter board.....	34
Touchpad.....	34
Removing the touchpad .....	34
Installing the touchpad.....	37
Display assembly.....	37
Removing the display assembly.....	37
Installing the display assembly.....	39
Display cover.....	39
Removing the display cover.....	39
Installing the display cover.....	40
Display cable.....	41
Removing the display cable.....	41
Installing the display cable.....	42
Sensor board.....	42
Removing the sensor board.....	42
Installing the sensor board.....	43
Display hinges.....	44
Removing the display hinges.....	44
Installing the display hinges.....	44
Camera.....	45
Removing the camera.....	45
Installing the camera.....	46
System board.....	46
Removing the system board.....	46

Installing the system board.....	49
Keyboard.....	50
Removing the keyboard.....	50
Installing the keyboard.....	52
Palmrest.....	53
Removing the palmrest.....	53
Installing the palmrest.....	54
<b>4 Technology and components.....</b>	<b>56</b>
Power adapter.....	56
Processors.....	56
Identifying processors in Windows 10.....	56
Verifying the processor usage in Task Manager.....	56
Verifying the processor usage in Resource Monitor.....	57
Chipsets.....	58
Downloading the chipset driver.....	58
Identifying the chipset in Device Manager on Windows 10.....	58
Graphic options.....	59
Downloading drivers.....	59
Identifying the display adapter.....	59
Changing the screen resolution.....	59
Rotating the display.....	60
Display options.....	60
Adjusting brightness in Windows 10.....	60
Cleaning the display.....	61
Using touch screen in Windows 10.....	61
Connecting to external display devices.....	61
Realtek ALC3253 Waves MaxxAudio Pro controller.....	61
Downloading the audio driver.....	62
Identifying the audio controller in Windows 10.....	62
Changing the audio settings.....	62
WLAN cards.....	62
Secure Boot screen options.....	62
Hard drive options.....	63
Identifying the hard drive in Windows 10.....	63
Entering BIOS setup.....	63
Camera features.....	64
Identifying the camera in Device Manager on Windows 10.....	64
Starting the camera.....	64
Starting the camera app.....	64
Memory features.....	65
Verifying system memory in Windows 10.....	65

Verifying system memory in setup.....	66
Testing memory using ePSA.....	66
Intel chipset drivers.....	66
Intel HD Graphics drivers.....	67
Realtek HD audio drivers.....	67
<b>5 System Setup.....</b>	<b>68</b>
Boot Sequence.....	68
Navigation keys.....	68
System setup options.....	69
General screen options.....	69
System Configuration screen options.....	70
Video screen options.....	71
Security screen options.....	71
Secure Boot screen options.....	73
Intel Software Guard Extensions screen options.....	73
Performance screen options.....	74
Power Management screen options.....	74
POST Behavior screen options.....	75
Virtualization support screen options.....	76
Wireless screen options.....	76
Maintenance screen options.....	77
System Log screen options.....	77
Updating the BIOS .....	77
System and setup password.....	78
Assigning a system password and setup password.....	78
Deleting or changing an existing system and/or setup password.....	79
<b>6 Diagnostics.....</b>	<b>80</b>
Enhanced Pre-Boot System Assessment (ePSA) diagnostics.....	80
System diagnostic lights.....	80
<b>7 Technical specifications.....</b>	<b>82</b>
System specifications.....	82
Processor specifications.....	82
Memory specifications.....	82
Audio specifications.....	83
Video specifications.....	83
Camera specifications.....	83
Communication specifications.....	84
Port and connector specifications.....	84
Display specifications.....	84

Keyboard specifications.....	85
Touchpad specifications.....	85
Battery specifications.....	85
AC Adapter specifications.....	86
Physical specifications.....	86
Environmental specifications.....	86
<b>8 Contacting Dell.....</b>	<b>88</b>

# Working on your computer

## Safety instructions

Use the following safety guidelines to help protect your computer from potential damage and to help to ensure your personal safety. Unless otherwise noted, each procedure included in this document assumes that the following conditions exist:

- You have read the safety information that shipped with your computer.
- A component can be replaced or--if purchased separately--installed by performing the removal procedure in reverse order.

 **WARNING: Disconnect all power sources before opening the computer cover or panels. After you finish working inside the computer, replace all covers, panels, and screws before connecting to the power source.**

 **WARNING: Before working inside your computer, read the safety information that shipped with your computer. For additional safety best practices information, see the Regulatory Compliance Homepage at [www.dell.com/regulatory\\_compliance](http://www.dell.com/regulatory_compliance)**

 **CAUTION: Many repairs may only be done by a certified service technician. You should only perform troubleshooting and simple repairs as authorized in your product documentation, or as directed by the online or telephone service and support team. Damage due to servicing that is not authorized by Dell is not covered by your warranty. Read and follow the safety instructions that came with the product.**

 **CAUTION: To avoid electrostatic discharge, ground yourself by using a wrist grounding strap or by periodically touching an unpainted metal surface, such as a connector on the back of the computer.**

 **CAUTION: Handle components and cards with care. Do not touch the components or contacts on a card. Hold a card by its edges or by its metal mounting bracket. Hold a component such as a processor by its edges, not by its pins.**

 **CAUTION: When you disconnect a cable, pull on its connector or on its pull-tab, not on the cable itself. Some cables have connectors with locking tabs; if you are disconnecting this type of cable, press in on the locking tabs before you disconnect the cable. As you pull connectors apart, keep them evenly aligned to avoid bending any connector pins. Also, before you connect a cable, ensure that both connectors are correctly oriented and aligned.**

 **NOTE: The color of your computer and certain components may appear differently than shown in this document.**



## Before working inside your computer

To avoid damaging your computer, perform the following steps before you begin working inside the computer.

1. Ensure that you follow the [Safety instructions](#).
2. Ensure that your work surface is flat and clean to prevent the computer cover from being scratched.
3. Turn off your computer, see [Turning off your computer](#).

 **CAUTION: To disconnect a network cable, first unplug the cable from your computer and then unplug the cable from the network device.**

4. Disconnect all the network cables from the computer.
5. Disconnect your computer and all attached devices from the electrical outlets.
6. Press and hold the power button while the computer is unplugged to ground the system board.
7. Remove the cover.

 **CAUTION: Before touching anything inside your computer, ground yourself by touching an unpainted metal surface, such as the metal at the back of the computer. While you work, periodically touch an unpainted metal surface to dissipate static electricity, which could harm internal components.**

## Turning off your computer

## After working inside your computer

After you complete any replacement procedure, ensure you connect any external devices, cards, and cables before turning on your computer.

 **CAUTION: To avoid damage to the computer, use only the battery designed for this particular Dell computer. Do not use batteries designed for other Dell computers.**

1. Connect any external devices, such as a port replicator or media base, and replace any cards, such as an ExpressCard.
2. Connect any telephone or network cables to your computer.

 **CAUTION: To connect a network cable, first plug the cable into the network device and then plug it into the computer.**

3. Replace the battery.
4. Replace the base cover.
5. Connect your computer and all attached devices to their electrical outlets.
6. Turn on your computer.

# System overview

## System top view

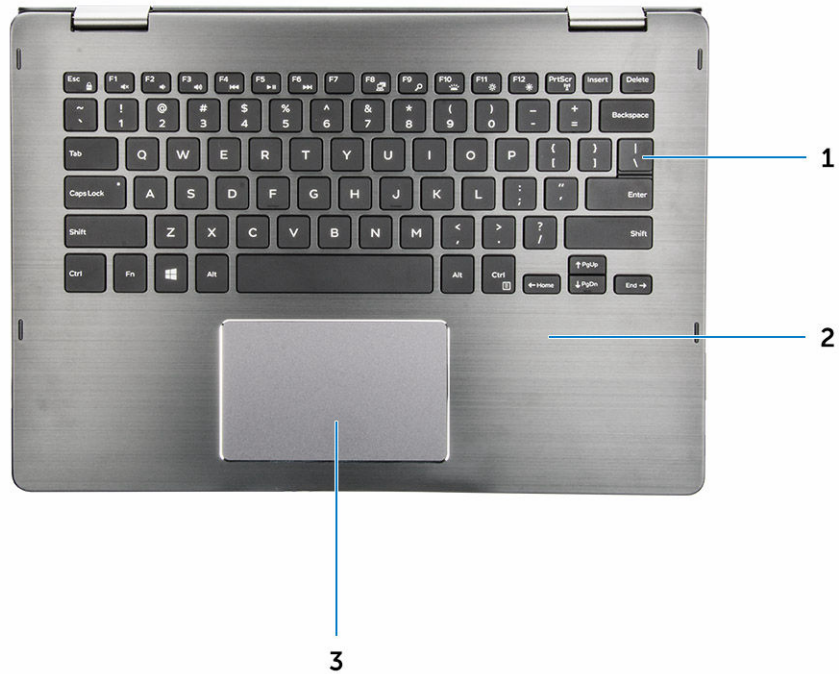

1. keyboard
3. touchpad

2. palmrest

## System front view

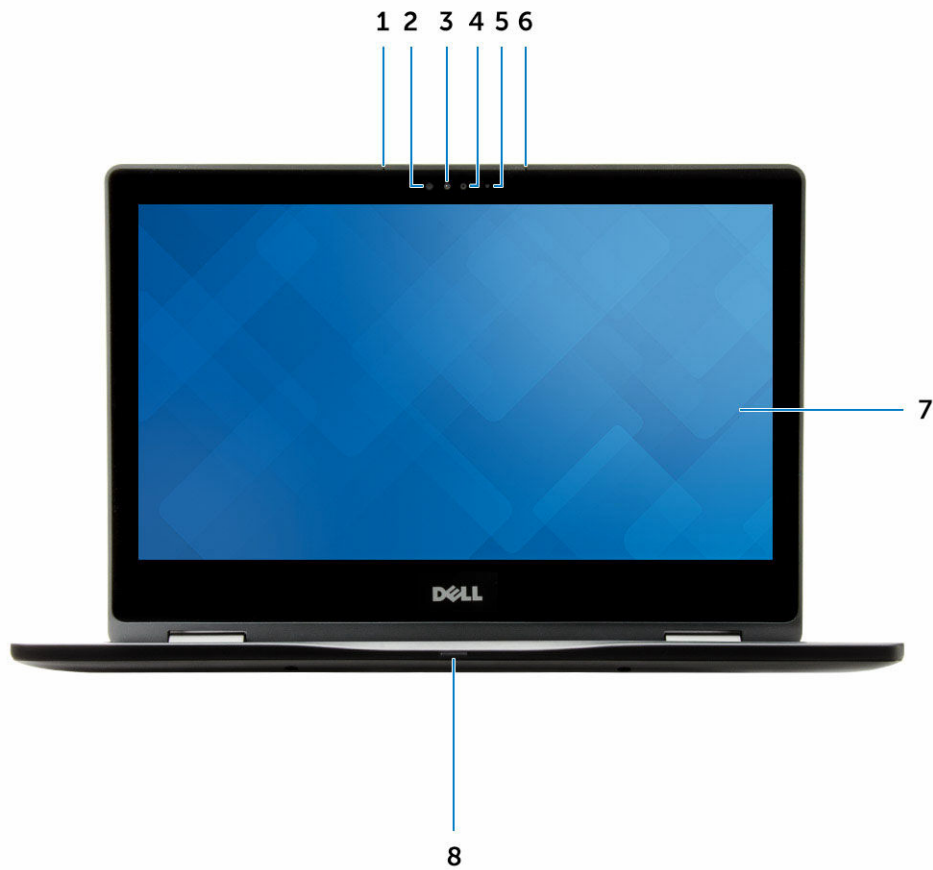

- |                        |   |
|------------------------|---|
| 1. microphone          | 2. infrared emitter   |
| 3. infrared camera     | 4. camera   |
| 5. camera status light | 6. microphone   |
| 7. display             | 8. power and battery status light/hard drive activity light |

## System back view

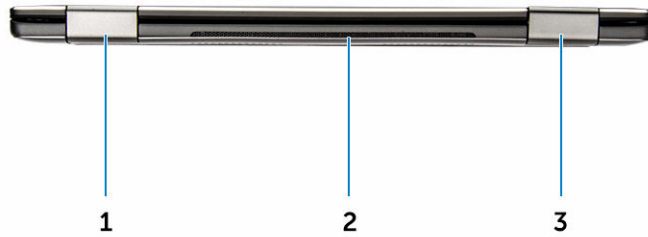

- 1. display hinge
- 2. thermal vent
- 3. display hinge

## System side view — Left

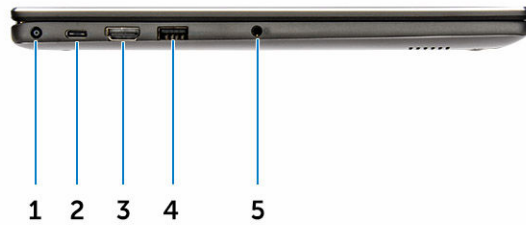

- 1. power connector port
- 2. USB 3.1 Type-C port
- 3. HDMI port
- 4. USB 3.0 with PowerShare
- 5. headset port

## System side view — Right



- |                        |                           |
|------------------------|---------------------------|
| 1. power button        | 2. volume control buttons |
| 3. media card reader   | 4. USB 2.0 port           |
| 5. security cable slot |                           |

# Removing and installing components

This section provides detailed information on how to remove or install the components from your computer.

## Recommended tools

The procedures in this document require the following tools:

- Small flat blade screwdriver
- Phillips screwdriver
- Small plastic scribe

## Base cover

### Removing the base cover

1. Follow the procedure in [Before working inside your computer](#).
2. Remove the screws that secure the back cover to the computer.

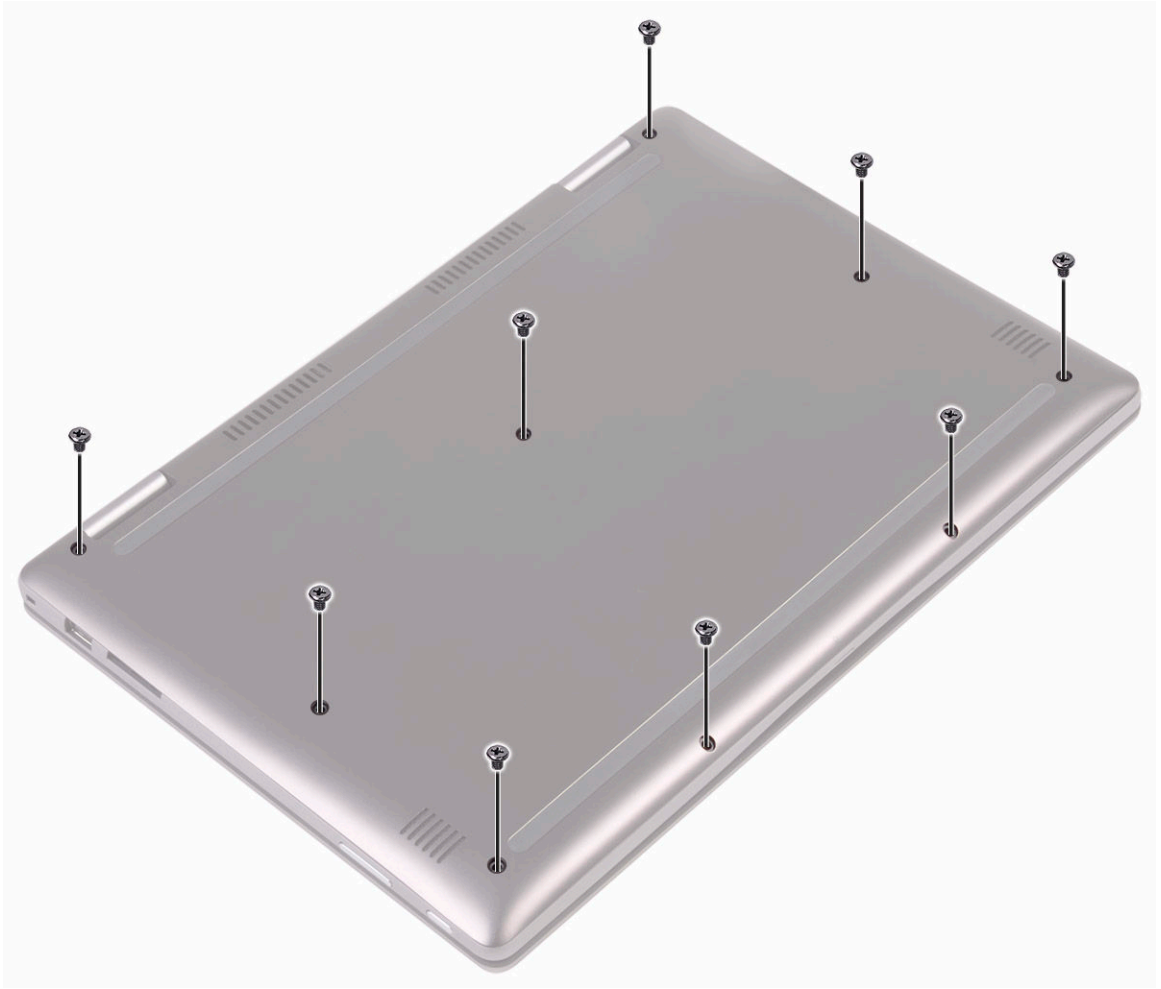

3. Using a plastic scribe, pry the back cover from the edges and remove it from the computer.



## Installing the base cover

1. Align the edges of the back cover with the computer and press until it clicks into place.
2. Tighten the screws to secure the back cover to the computer.
3. Follow the procedure in [After working inside your computer](#).

## Battery

### Removing the battery

1. Follow the procedure in [Before working inside your computer](#).
2. Remove the [base cover](#).
3. To remove the battery:
  - a. Disconnect the battery cable from the connector on the system board [1].
  - b. Remove the screws that secure the battery to the computer [2].
  - c. Lift the battery away from the computer [3].



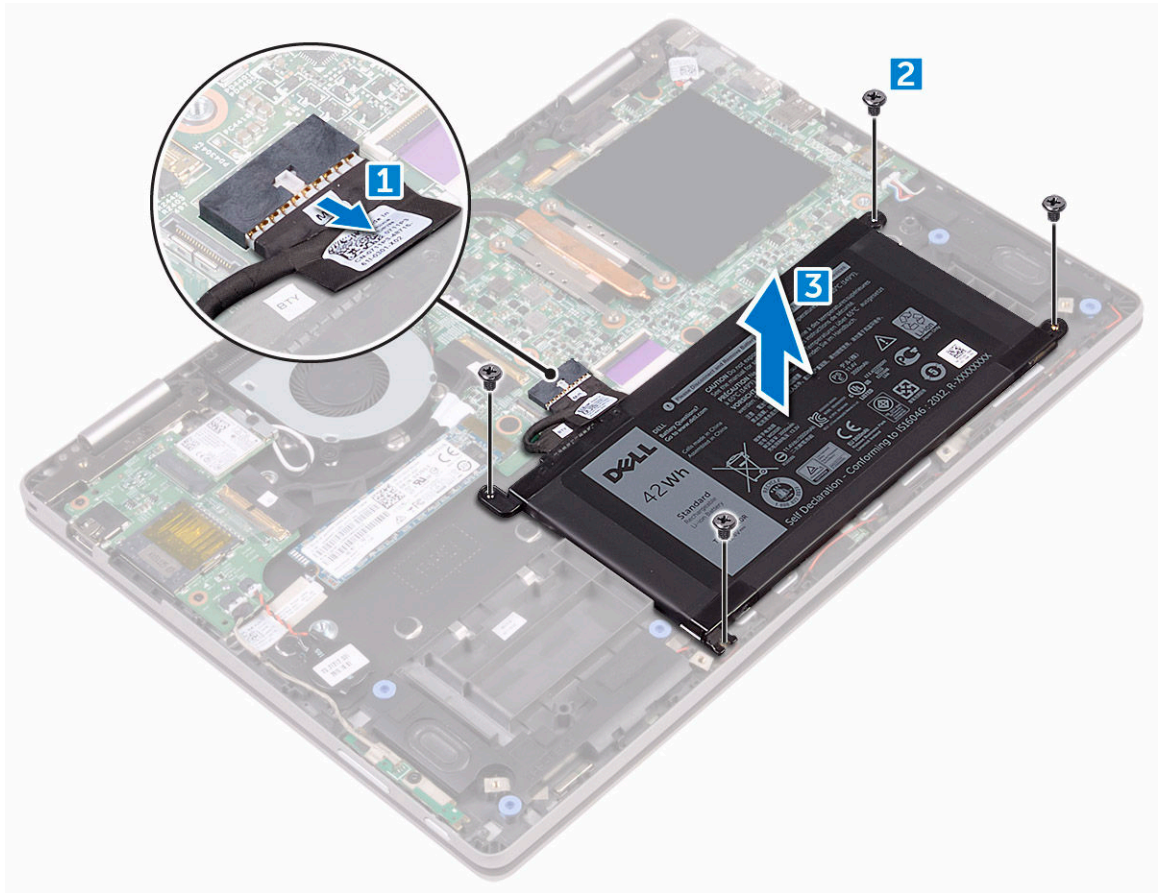

## Installing the battery

1. Insert the battery into the slot on the computer.
2. Tighten the screws to secure the battery to the computer.
3. Connect the battery cable to the connector on the system board
4. Install the [base cover](#).
5. Follow the procedure in [After working inside your computer](#).

## Power and volume control board

### Removing the power and volume control board

1. Follow the procedure in [Before working inside your computer](#).
2. Remove the:
  - a. [base cover](#)
  - b. [battery](#)
3. To remove the power and volume control board:
  - a. Peel the adhesive tape [1].
  - b. Disconnect the power and volume control board cable from the connector on the system board [2].

- c. Release the cables from the placeholders [3].
- d. Remove the screw that secures the power and volume control board to the computer [4].
- e. Lift the power and volume control board away from the computer [5].

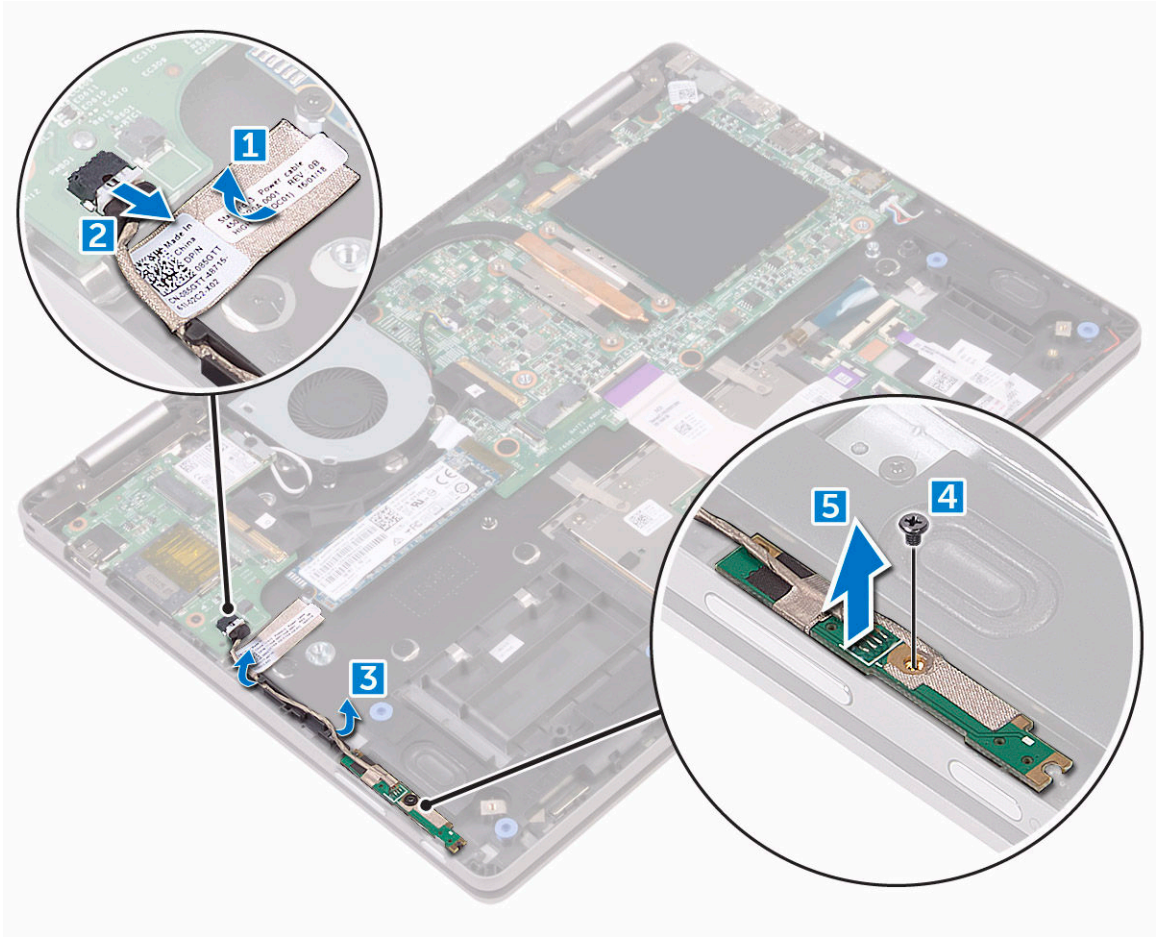

## Installing the power and volume control board

1. Place the power and volume control board into the slot on the computer.
2. Tighten the screw to secure the power and volume control board to the computer.
3. Align the cables through the placeholders.
4. Connect the power and volume control board to the connector on the system board.
5. Affix the adhesive tape to secure it.
6. Install the:
  - a. [battery](#)
  - b. [base cover](#)
7. Follow the procedure in [After working inside your computer](#).

# Solid State Drive (SSD)

## Removing the solid state drive (SSD) card

1. Follow the procedure in [Before working inside your computer](#).
2. Remove the:
  - a. [base cover](#)
  - b. [battery](#)
3. To remove the SSD card:
  - a. Remove the screw that secures the SSD card to the computer [1].
  - b. Disconnect the SSD card from the connector on the system board [2].

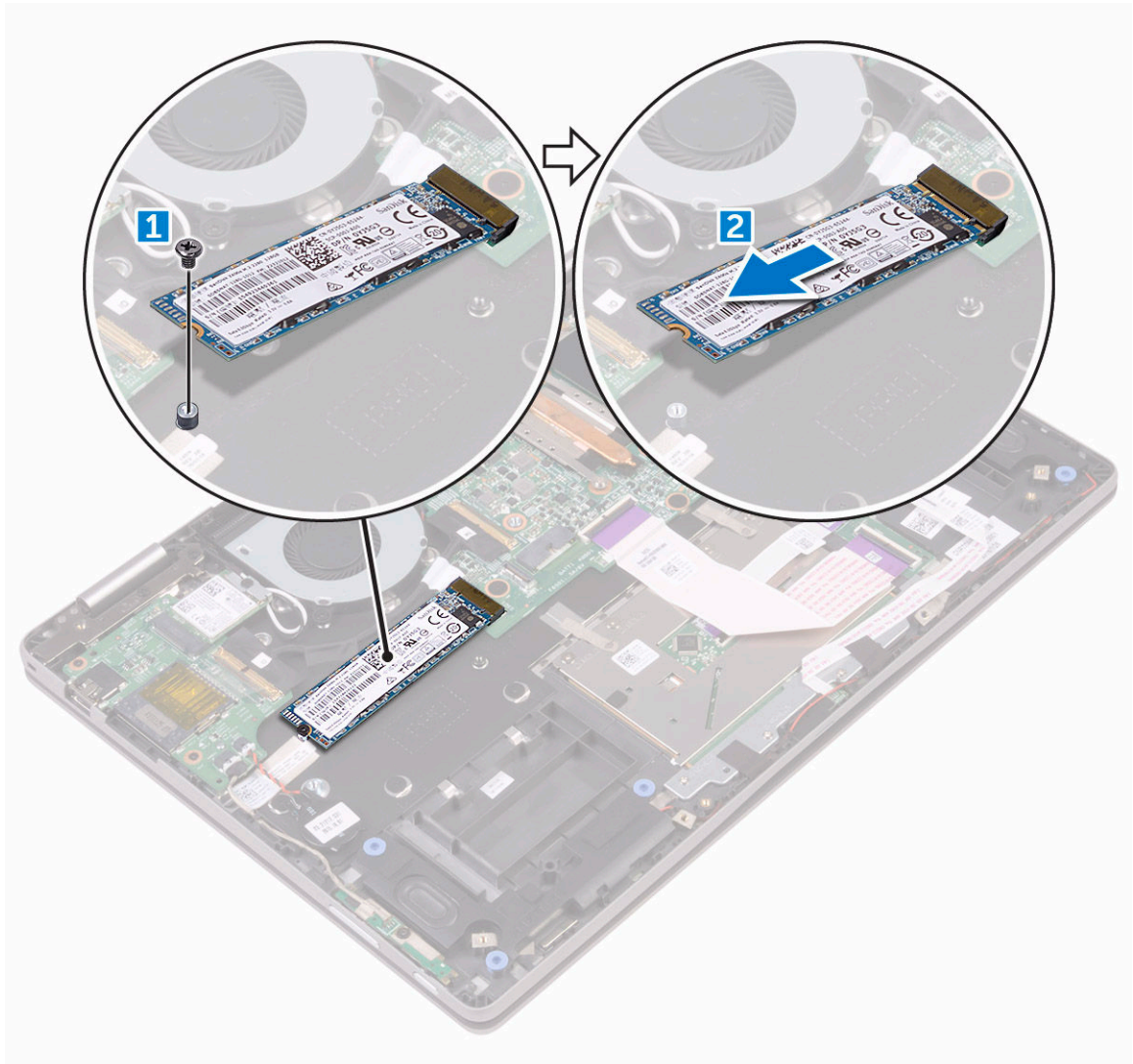



## Installing the solid state drive (SSD) card

1. Connect the SSD card to the connector on the system board.
2. Tighten the screw to secure the SSD card to the computer.
3. Install the:
  - a. [battery](#)
  - b. [base cover](#)
4. Follow the procedure in [After working inside your computer](#).

## Coin cell battery

### Removing the coin cell battery

1. Follow the procedure in [Before working inside your computer](#).
2. Remove the:
  - a. [base cover](#)
  - b. [battery](#)
3. To remove the coin cell battery:
  - a. Disconnect the coin cell battery from the connector on the system board [1].
  - b. Pry the coin cell battery to remove it from the computer [2].

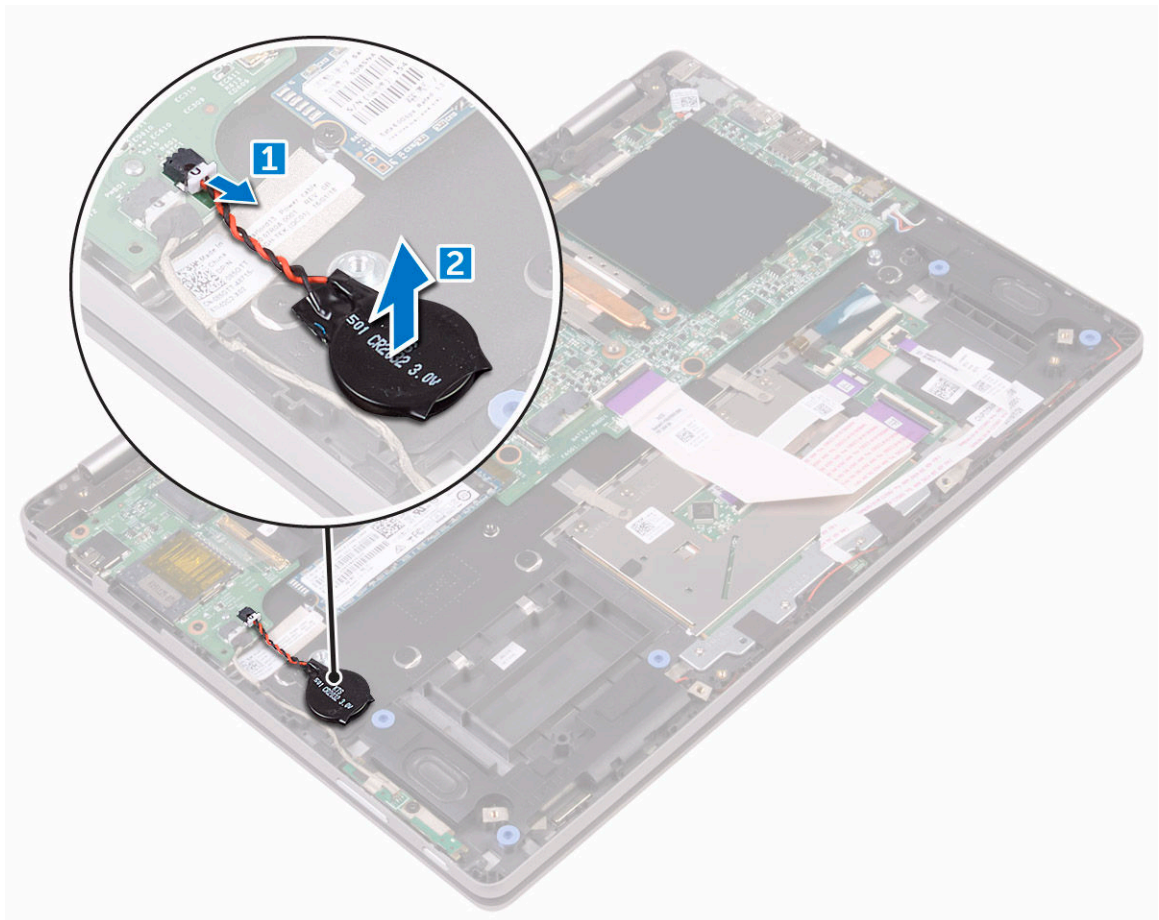

## Installing the coin cell battery

1. Place the coin cell battery on the computer.
2. Connect the coin cell battery cable to the connector on the system board.
3. Install the:
  - a. [battery](#)
  - b. [base cover](#)
4. Follow the procedure in [After working inside your computer](#).

## WLAN card

### Removing the WLAN card

1. Follow the procedure in [Before working inside your computer](#).
2. Remove the:
  - a. [base cover](#)
  - b. [battery](#)
3. To remove the WLAN card:
  - a. Remove the screw that secures the WLAN card to the computer [1].
  - b. Lift the metal tab away to access the WLAN cables [2].
  - c. Disconnect the WLAN cables from the connectors on the WLAN card [3].
  - d. Disconnect the WLAN card from the connector on the system board [4].

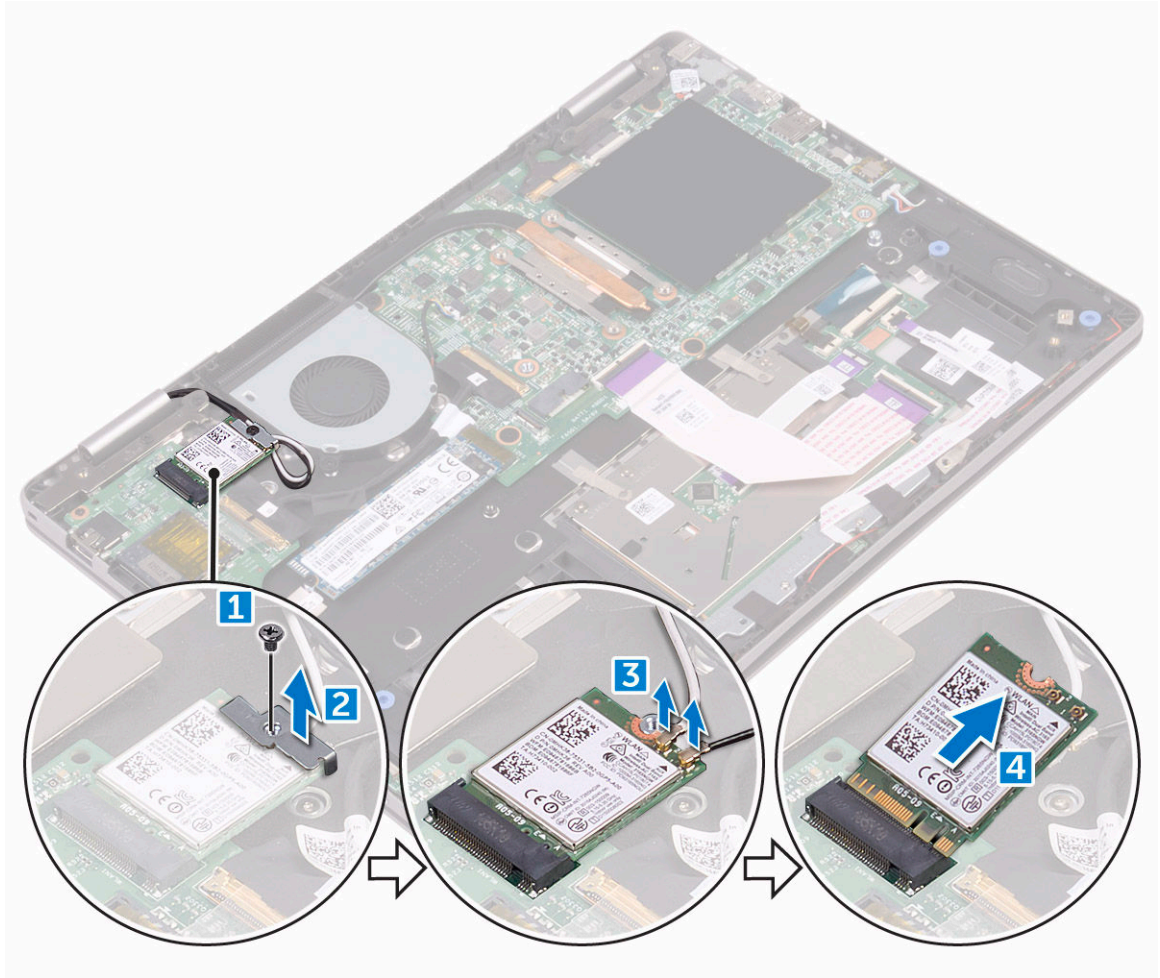

## Installing the WLAN

1. Connect the WLAN card to the connector on the system board.
2. Connect the WLAN cables to the connectors on the WLAN card.
3. Place the metal tab to secure the WLAN cables.
4. Tighten the screw to secure the WLAN card to the computer.
5. Install the:
  - a. [battery](#)
  - b. [back cover](#)
6. Follow the procedure in [After working inside your computer](#).

## Memory module

### Removing the memory module

1. Follow the procedure in [Before working inside your computer](#).
2. Remove the:

- a. [base cover](#)
  - b. [battery](#)
3. Peel the adhesive tape that secures the memory module to the computer.



4. To remove the memory module:
- a. Pull the retention clips away from the memory module until it pops up [1].
  - b. Disconnect the memory module from the connector on the system board [2].



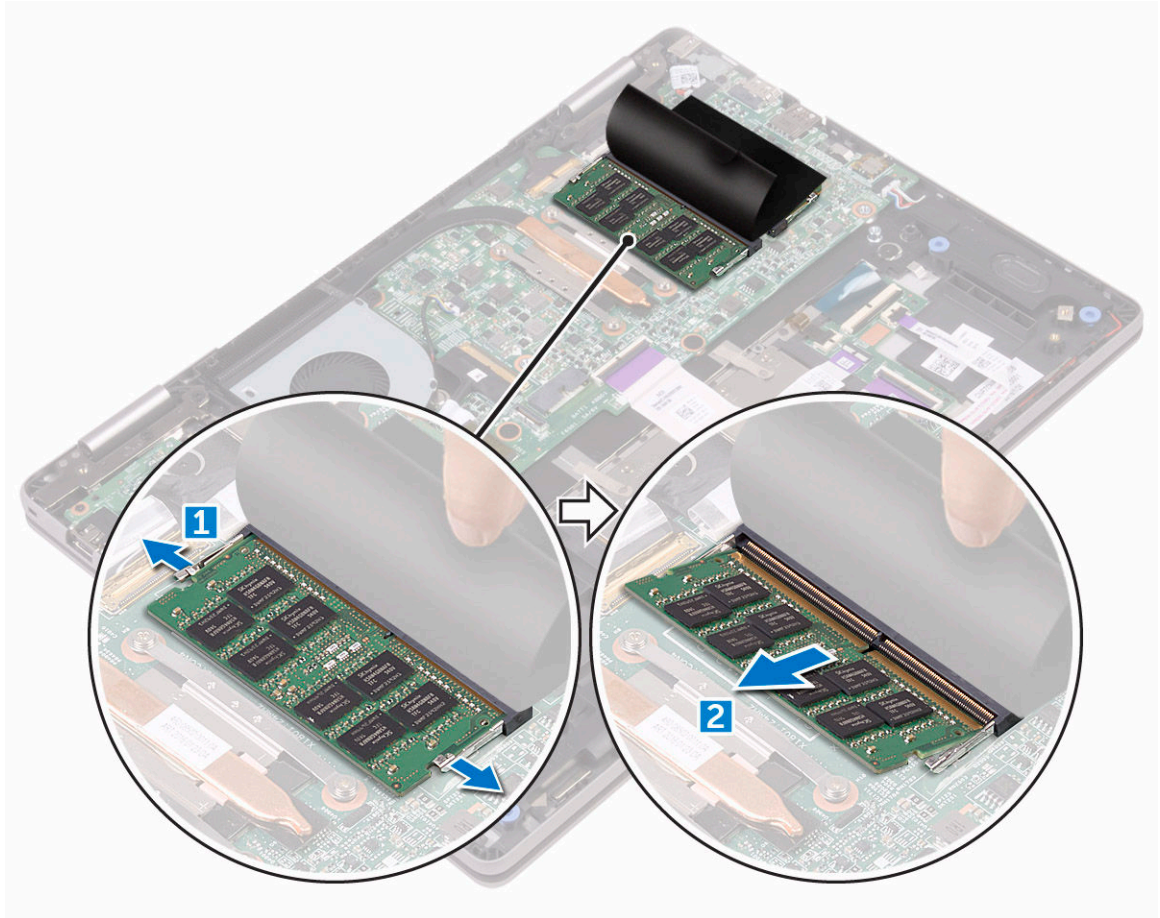

## Installing the memory module

1. Insert the memory module on the memory socket until the retention clips secure the memory.
2. Affix the adhesive tape to secure the memory module.
3. Install the:
  - a. [battery](#)
  - b. [base cover](#)
4. Follow the procedure in [After working inside your computer](#).

## Speaker

### Removing the speakers

1. Follow the procedure in [Before working inside your computer](#).
2. Remove the:
  - a. [base cover](#)
  - b. [battery](#)
3. To remove the speakers:
  - a. Disconnect the speaker cable from the connector on the system board [1].



- b. Release the speaker cables from the placeholders [2].
- c. Lift the speakers away from the computer [3].

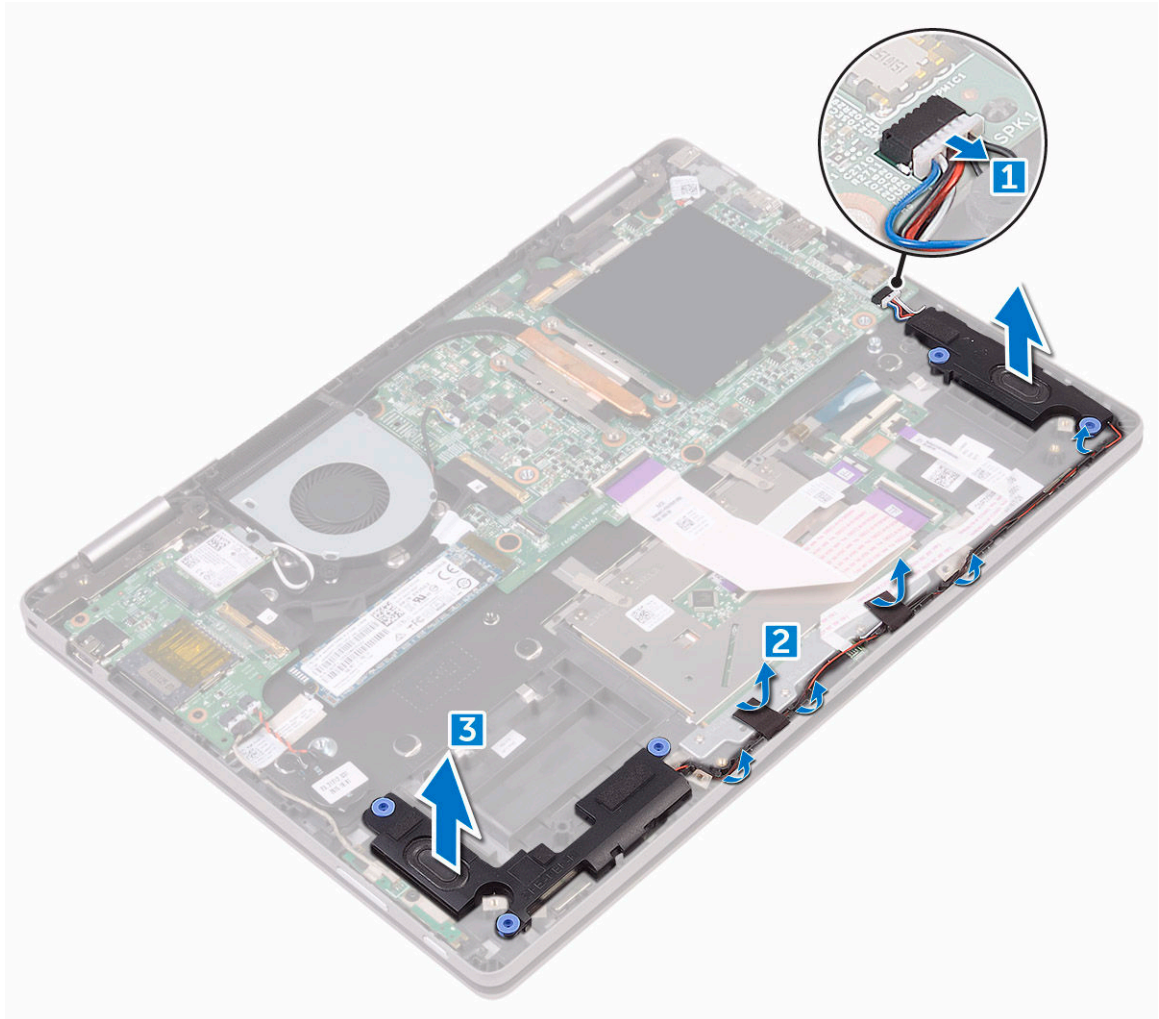

## Installing the speakers

1. Place the speakers into the slot on the computer.
2. Route the speaker cable through the placeholders.
3. Connect the speaker cable to the connector on the system board.
4. Install the:
  - a. [battery](#)
  - b. [base cover](#)
5. Follow the procedure in [After working inside your computer](#).

# System fan

## Removing the system fan

1. Follow the procedure in [Before working inside your computer](#).
2. Remove the:
  - a. [base cover](#)
  - b. [battery](#)
3. To remove the system fan:
  - a. Disconnect the system fan cable from the connector on the system board [1].
  - b. Remove the screws that secure the system fan to the computer [2].
  - c. Lift the system fan away from the computer [3].

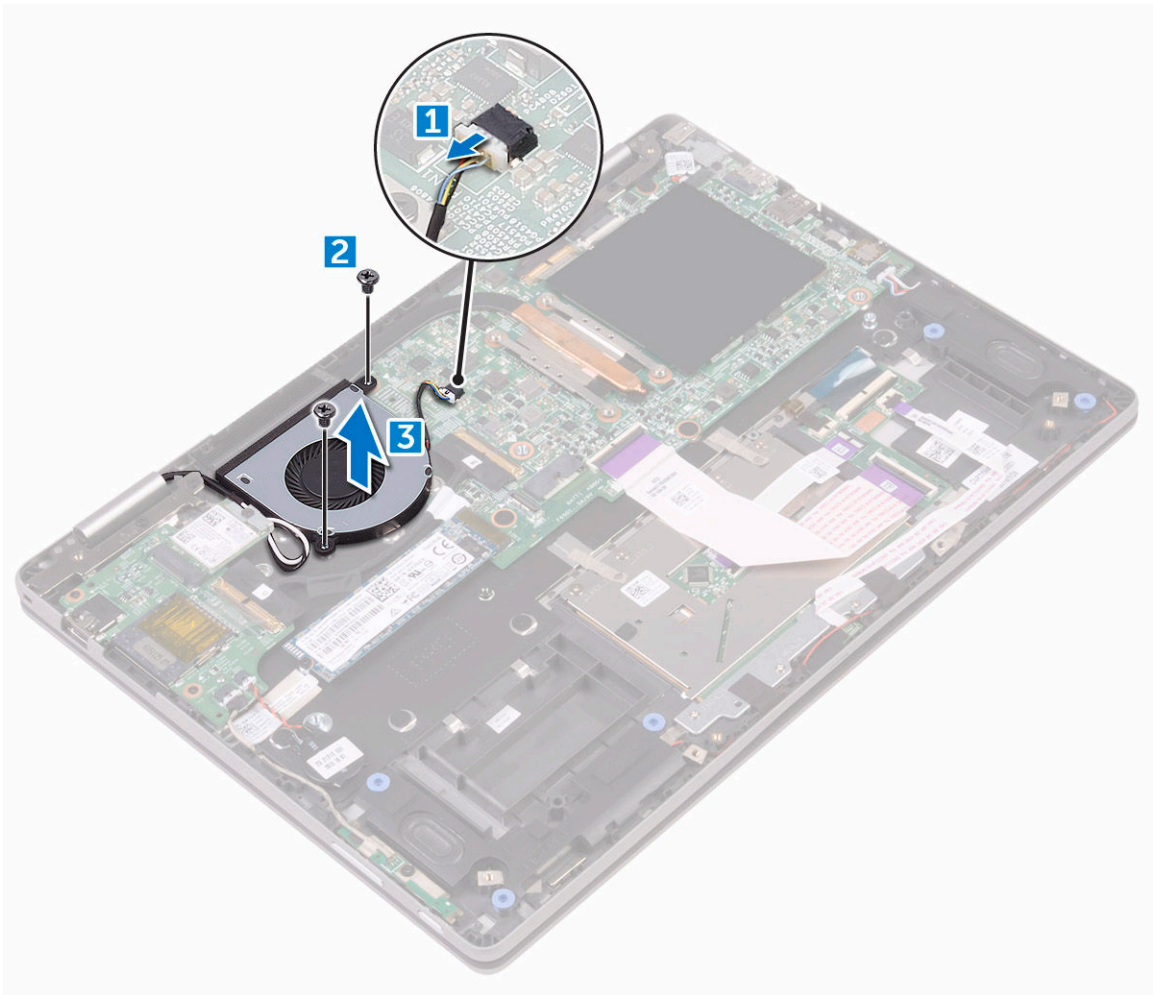

## Installing the system fan

1. Place the system fan on the computer.
2. Tighten the screws to secure the system fan to the computer.

3. Connect the system fan cable to the connector on the system board.
4. Install the:
  - a. [battery](#)
  - b. [base cover](#)
5. Follow the procedure in [After working inside your computer](#).

## Heat sink

### Removing the heatsink

1. Follow the procedure in [Before working inside your computer](#).
2. Remove the:
  - a. [base cover](#)
  - b. [battery](#)
3. To remove the heatsink:
  - a. Remove the captive screws that secure the heatsink to the computer [1] [2] [3] [4].
  - b. Lift the heatsink away from the computer [5].

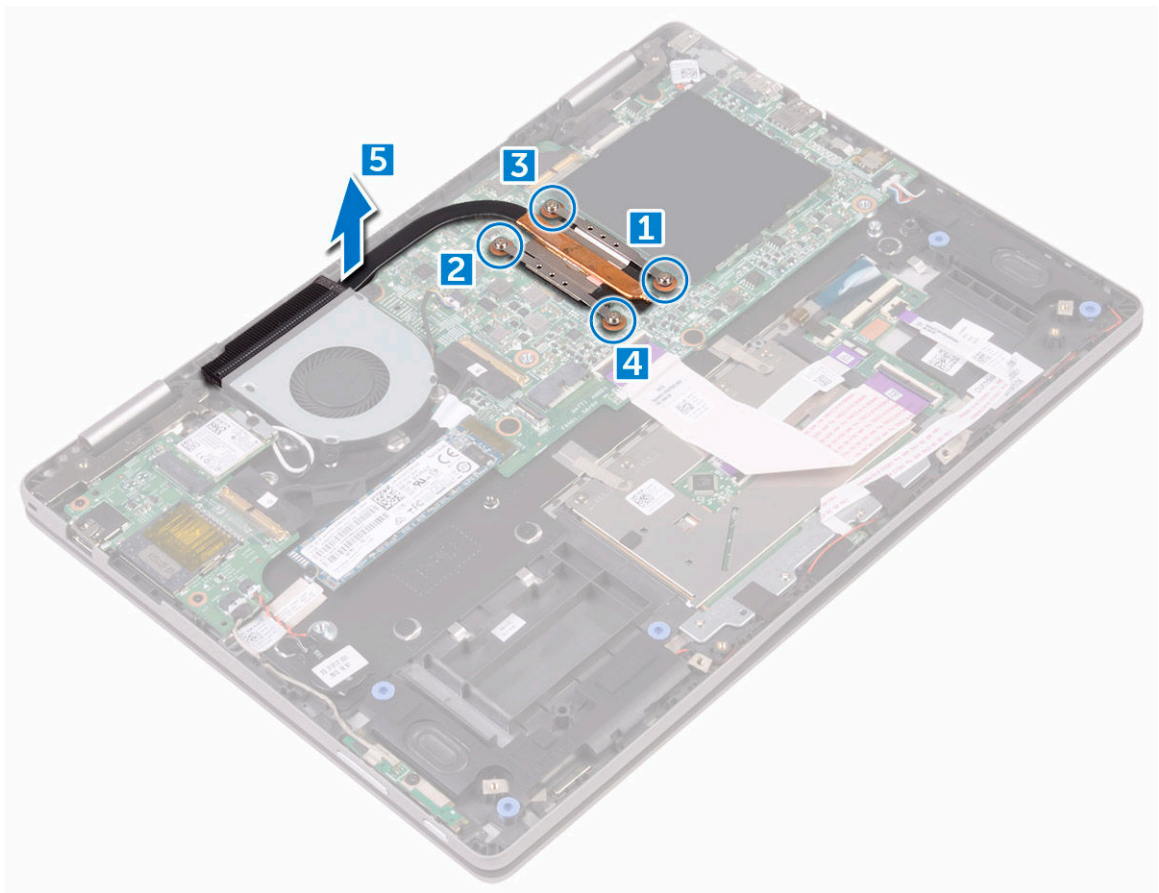

## Installing the heatsink

1. Place the heatsink on the system board.
2. Tighten the screws to secure the heatsink to the computer.
3. Install the:
  - a. [battery](#)
  - b. [base cover](#)
4. Follow the procedure in [After working inside your computer](#).

## LED board

### Removing the LED board

1. Follow the procedure in [Before working inside your computer](#).
2. Remove the:
  - a. [base cover](#)
  - b. [battery](#)
3. To release the LED board:
  - a. Peel the adhesive tapes to access the speaker cable [1].
  - b. Release the speaker cable from the computer [2].

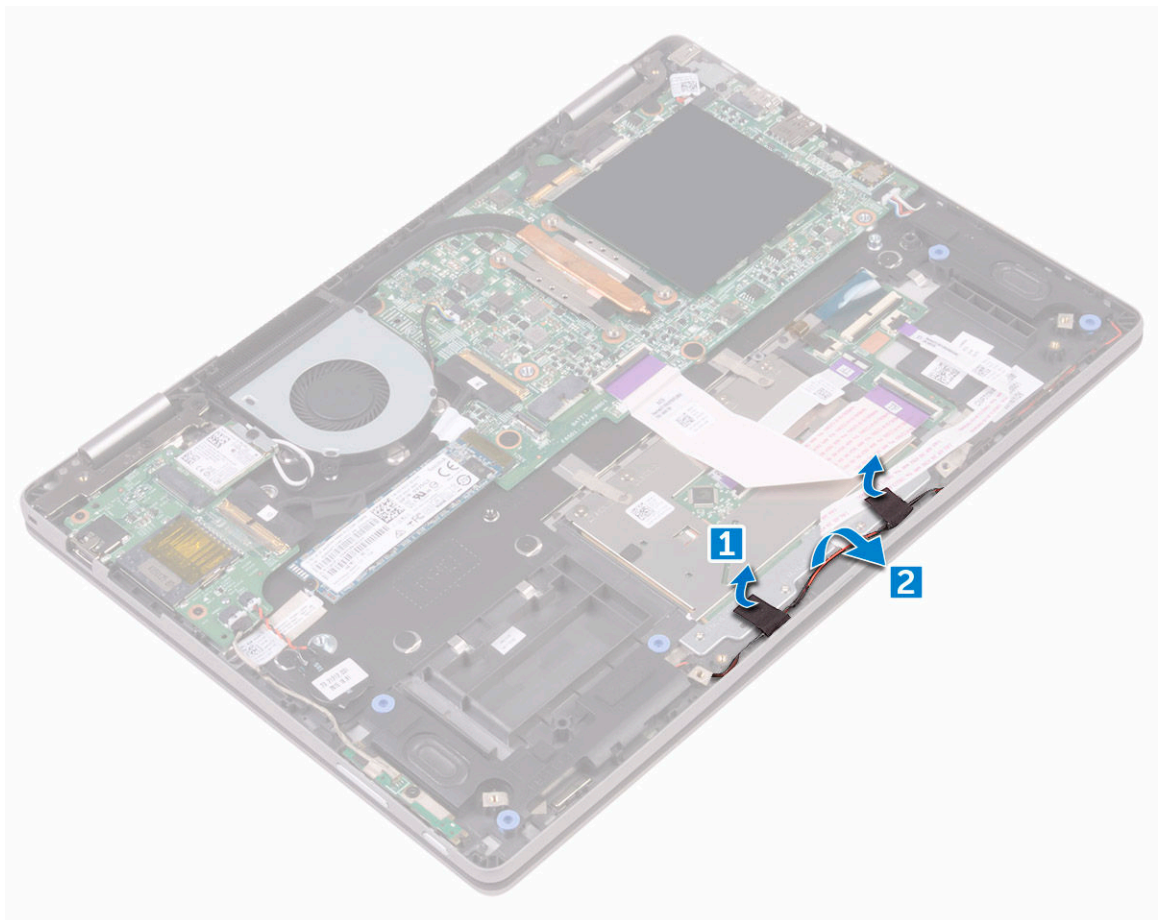



4. To remove the LED board:
  - a. Lift the latch and disconnect the LED board cable [1].
  - b. Release the LED board cable from the computer [2].
  - c. Peel the adhesive tape to access the LED board [3].
  - d. Lift the LED board away from the computer [4].

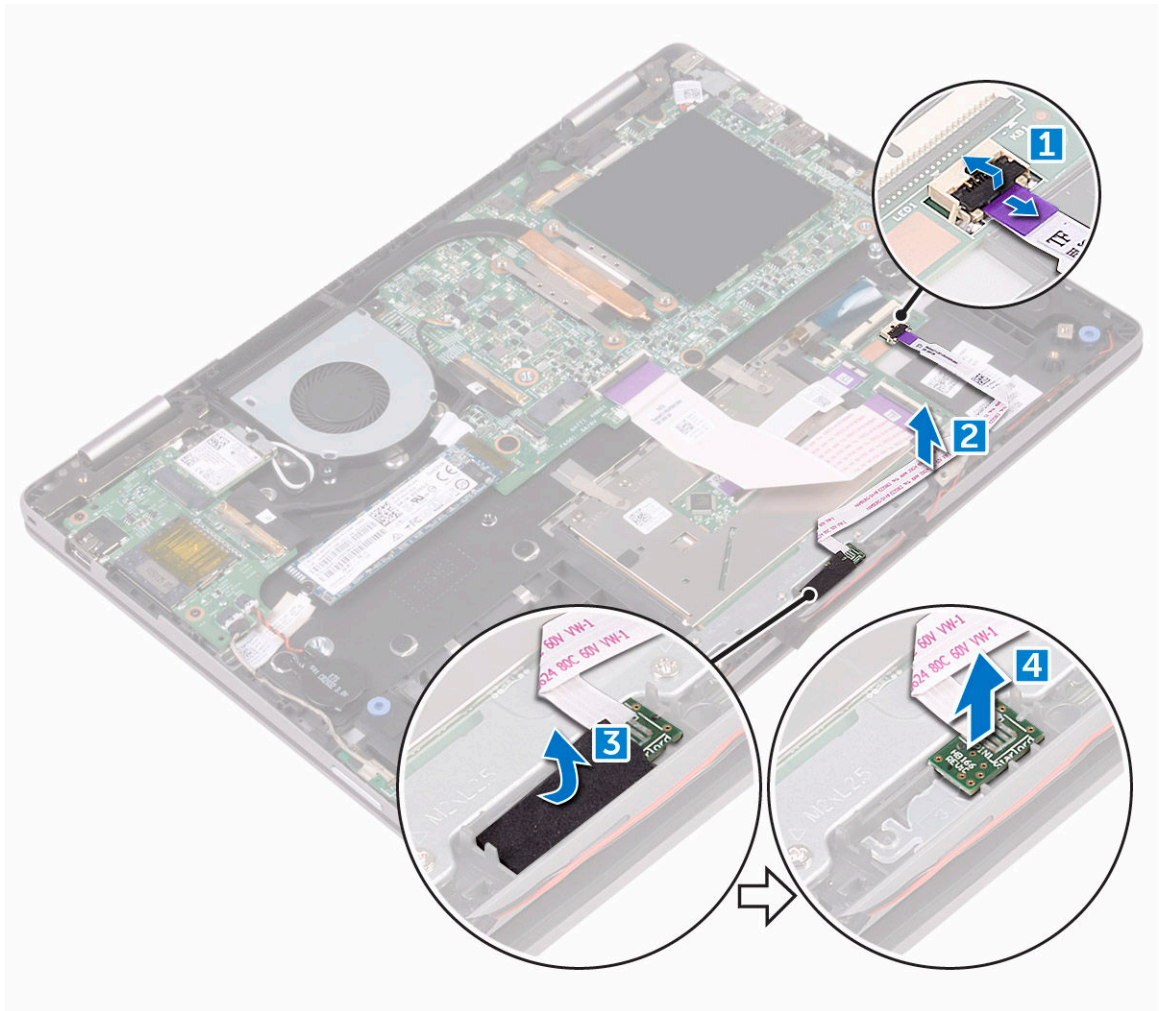

## Installing the LED board

1. Place the LED board into the slot on the computer.
2. Affix the adhesive tape to secure the LED board to the computer.
3. Affix the LED board cable and connect the LED board cable to the connector.
4. Install the:
  - a. [battery](#)
  - b. [base cover](#)
5. Follow the procedure in [After working inside your computer](#).

# Input/Output(I/O) board

## Removing the Input/Output (I/O) board

1. Follow the procedure in [Before working inside your computer](#).
2. Remove the:
  - a. [base cover](#)
  - b. [battery](#)
3. To remove the I/O board:
  - a. Peel the adhesive tape to access the I/O board cable [1].
  - b. Lift the latch and disconnect the I/O board cable from the I/O board [2].
  - c. Disconnect the coin cell battery and power and volume button board cables from the I/O board [3].
  - d. Remove the screw that secures the I/O board to the computer [4].
  - e. Lift the I/O board away from the computer [5].

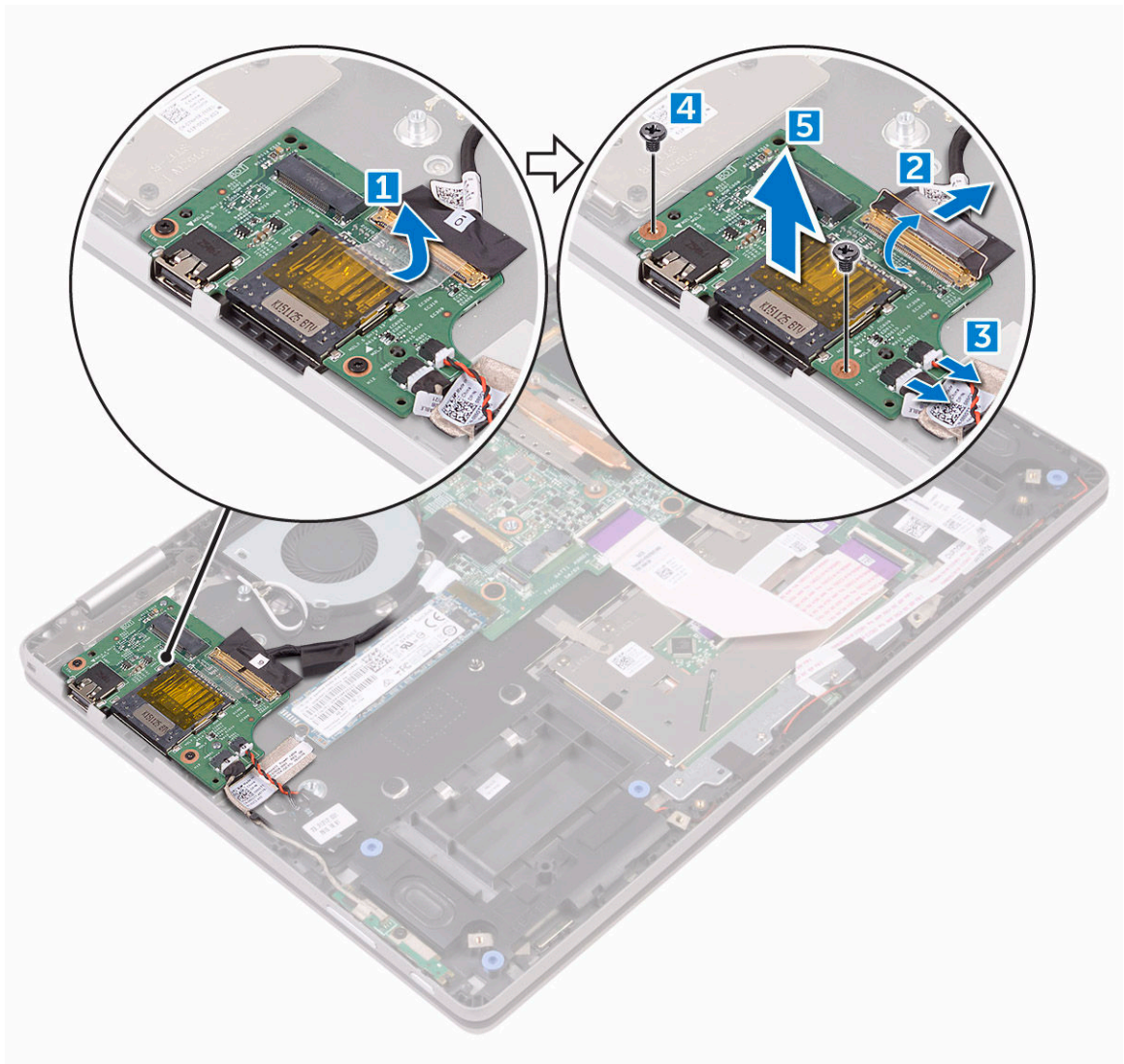

## Installing the Input/Output (I/O) board

1. Place the I/O board into the slot on the computer.
2. Tighten the screws to secure the I/O board to the computer.
3. Connect the coin cell battery and power and volume button board cables to the connector on the I/O board.
4. Connect the I/O board cable to the connector on the I/O board.
5. Affix the adhesive tape to secure the I/O board cable
6. Install the:
  - a. [battery](#)
  - b. [base cover](#)
7. Follow the procedure in [After working inside your computer](#).

## Power connector

### Removing the power connector port

1. Follow the procedure in [Before working inside your computer](#).
2. Remove the:
  - a. [base cover](#)
  - b. [battery](#)
3. To remove the power connector port:
  - a. Disconnect the power connector port cable from the connector on the system board [1].
  - b. Remove the screw that secures the power connector port to the computer [2].
  - c. Lift the power connector port away from the computer [3].

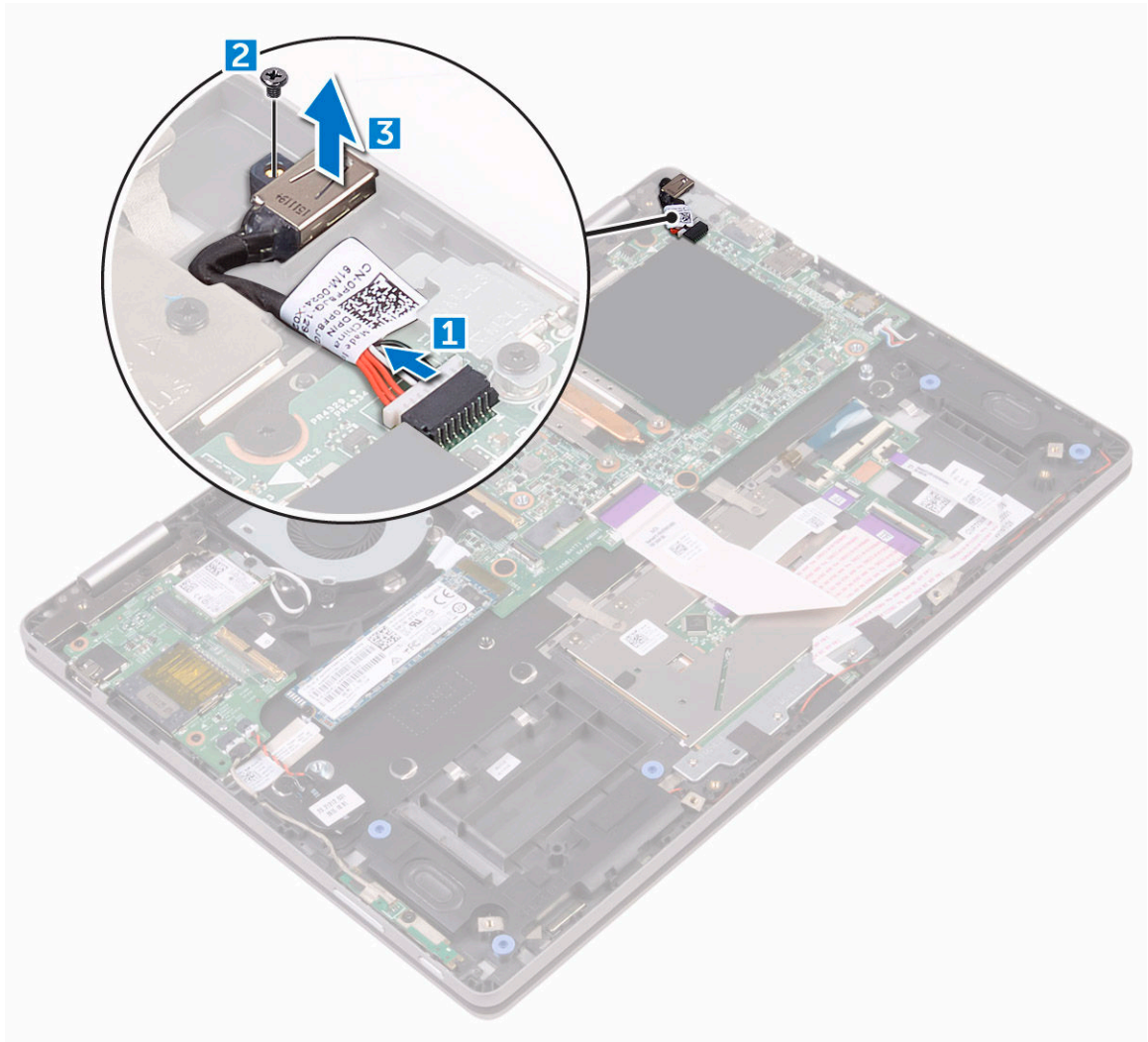

## Installing the power connector port

1. Place the power connector port into the slot on the computer.
2. Tighten the screw to secure the power connector port to the computer.
3. Connect the power connector port cable to the connector on the system board.
4. Install the:
  - a. [battery](#)
  - b. [base cover](#)
5. Follow the procedure in [After working inside your computer](#).



# Keyboard daughter board

## Removing the keyboard daughter board

1. Follow the procedure in [Before working inside your computer](#).
2. Remove the:
  - a. [base cover](#)
  - b. [battery](#)
3. Open the latches and disconnect the following cables from the keyboard daughter board:
  - a. keyboard [1]
  - b. keyboard backlight [2]
  - c. touchpad [3]
  - d. keyboard daughter board [4]
  - e. LED board [5]

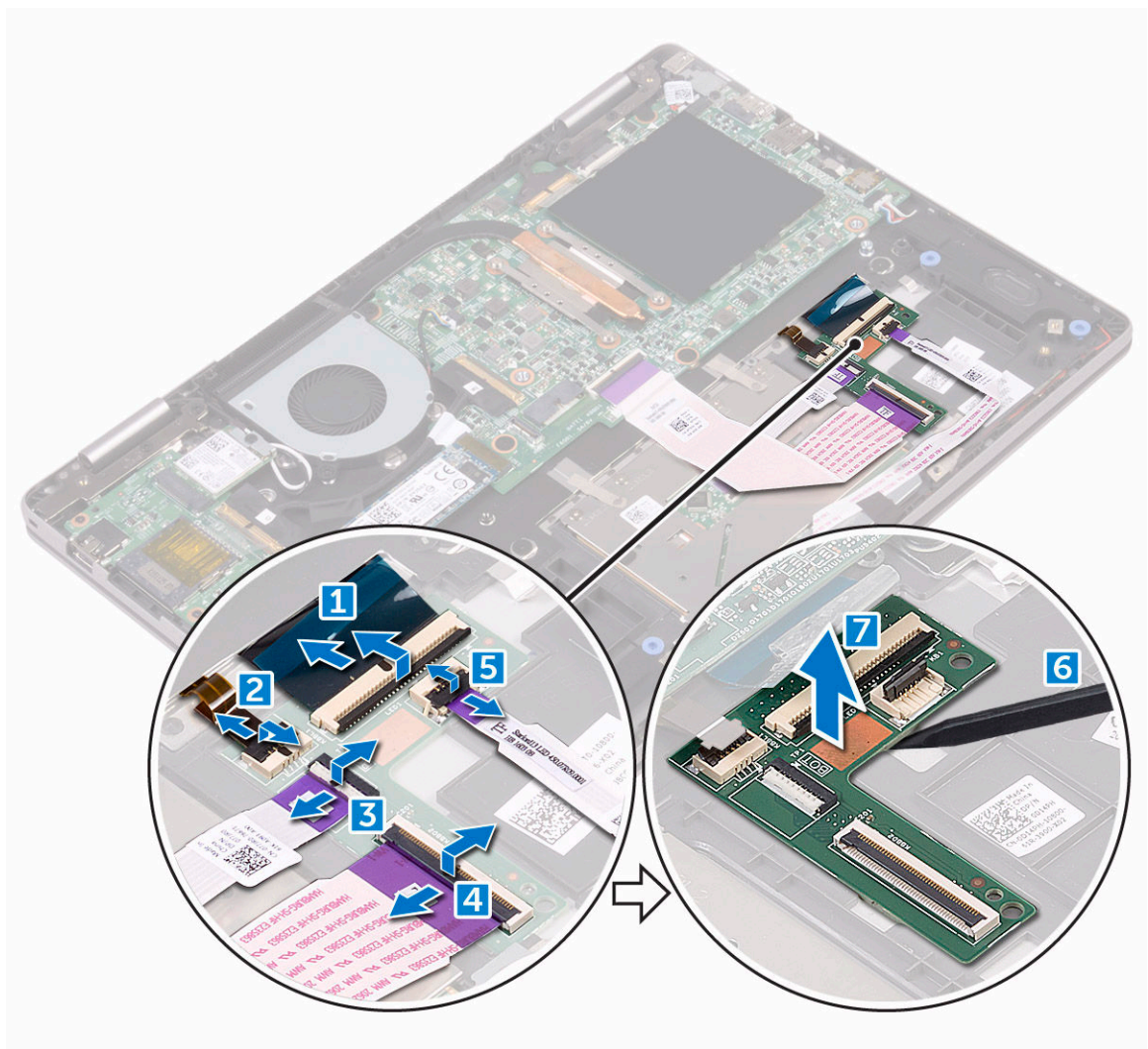

4. Using a plastic scribe, lift the keyboard daughter board away from the computer [6] [7].

## Installing the keyboard daughter board

1. Place the keyboard daughter board into the slot on the computer.
2. Connect the following cables to the connectors on the keyboard daughter board:
  - a. LED board
  - b. keyboard daughter board
  - c. touchpad
  - d. keyboard backlight
  - e. keyboard
3. Install the:
  - a. [battery](#)
  - b. [base cover](#)
4. Follow the procedure in [After working inside your computer](#).

## Touchpad

### Removing the touchpad

1. Follow the procedure in [Before working inside your computer](#).
2. Remove the:
  - a. [base cover](#)
  - b. [battery](#)
3. Open the latches and disconnect the following cables from the system board:
  - a. keyboard daughter board [1] [2]
  - b. Remove the keyboard daughter board cable from the computer [3]
  - c. touchpad [4] [5]
  - d. Remove the touchpad cable from the computer [6]

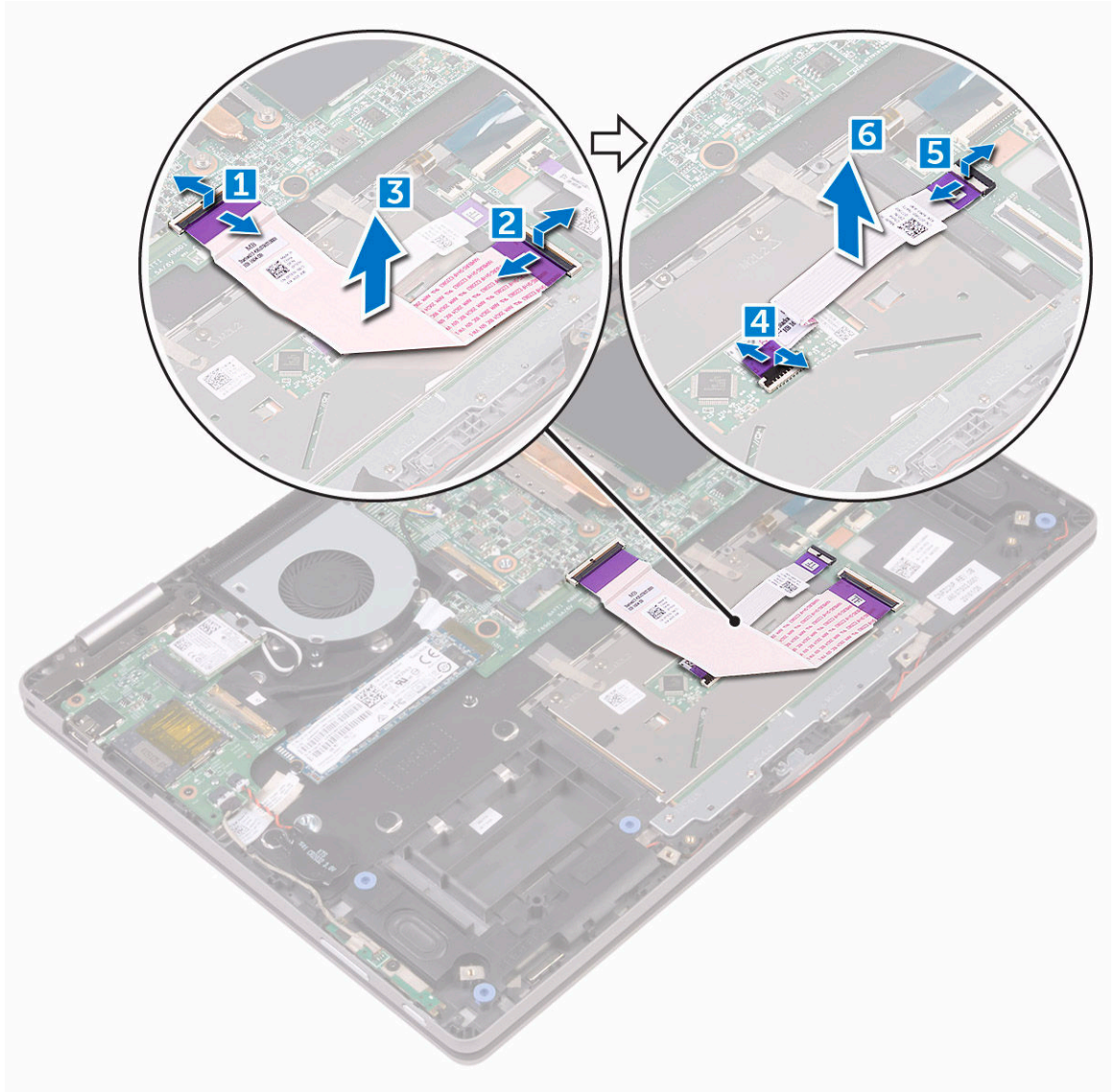

4. To release the touchpad:
  - a. Pull the metal clips away from the touchpad [1].
  - b. Remove the screws to release the metal tab that secure the touchpad [2].
  - c. Lift the metal tab to access the touchpad [3].

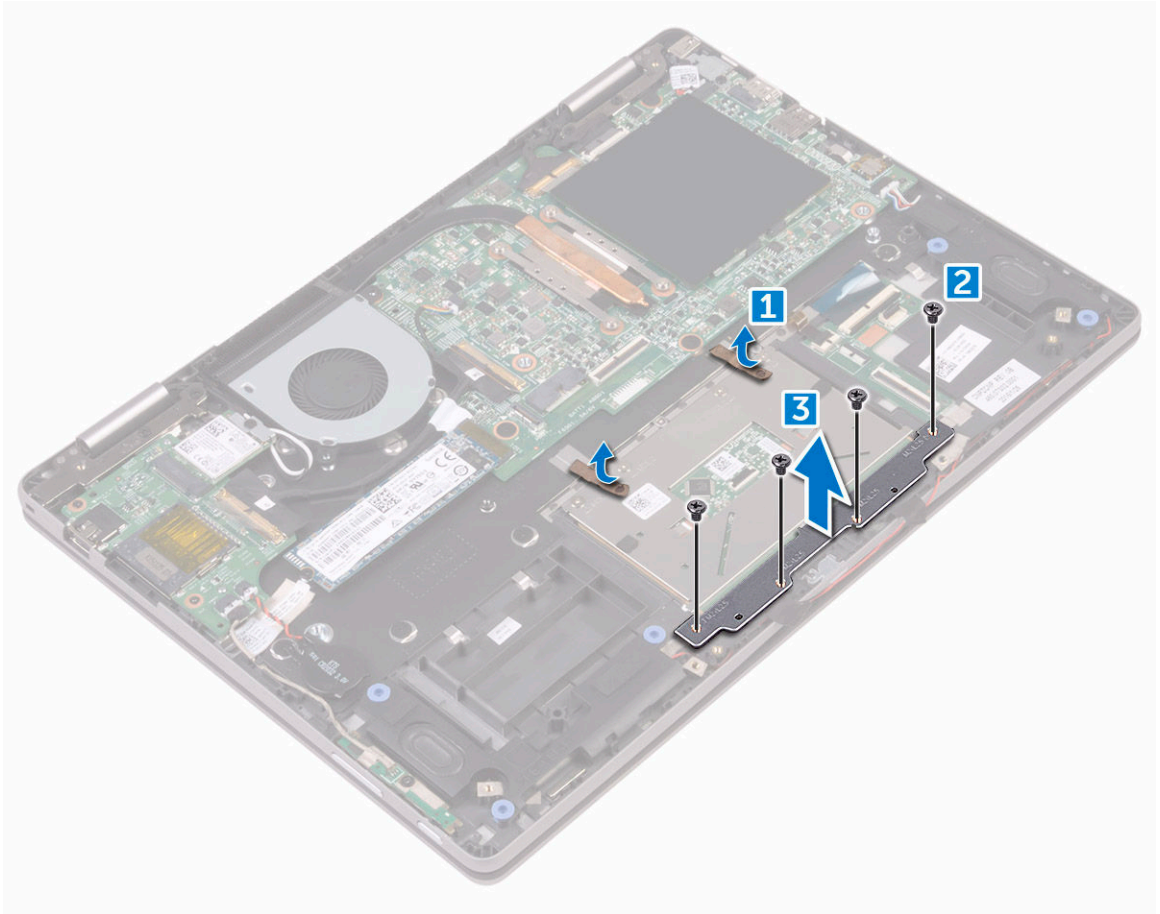

5. To remove the touchpad:
  - a. Remove the screws that secure the touchpad to the computer [1].
  - b. Lift the touchpad away from the computer [2].



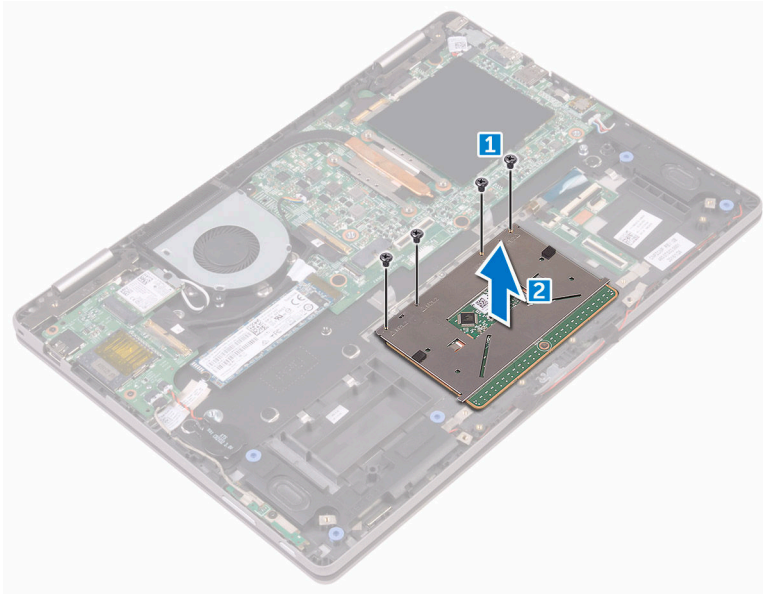

## Installing the touchpad

1. Place the touchpad on the computer.
2. Tighten the screws to secure the touchpad to the computer.
3. Place the metal tab over the touchpad.
4. Tighten the screws to secure the metal tab.
5. Connect the touchpad cable and keyboard daughter board cable to the connectors on the system board.
6. Install the:
  - a. [battery](#)
  - b. [base cover](#)
7. Follow the procedure in [After working inside your computer](#).

## Display assembly

### Removing the display assembly

1. Follow the procedure in [Before working inside your computer](#).
2. Remove the:
  - a. [base cover](#)
  - b. [battery](#)
  - c. [WLAN card](#)
3. To release the display assembly:
  - a. Peel the adhesive tapes that secure the display cable and touch screen board cables [1] [2].
  - b. Open the latches and disconnect the display and touch screen board cables from the system board [3] [4].

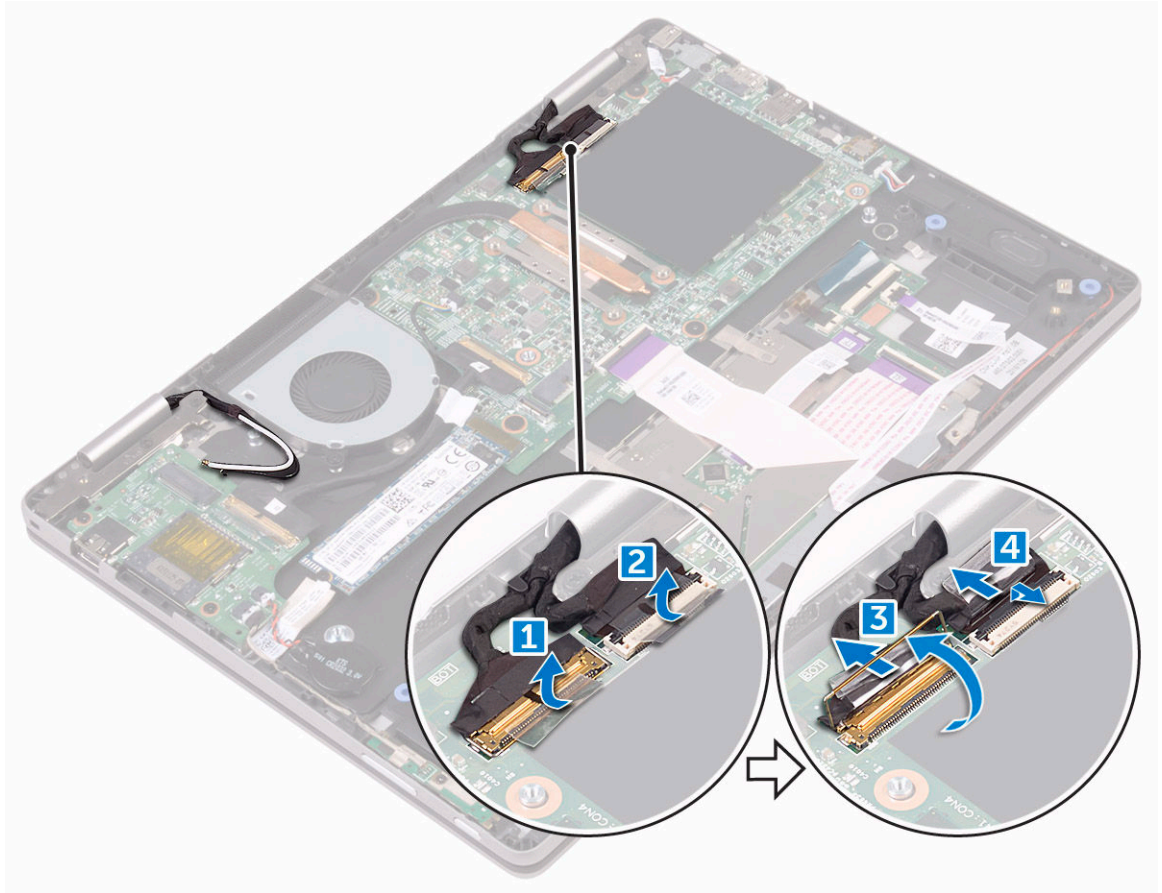

4. Flip the computer and open the display.
5. To remove the display assembly:
  - a. Remove the screws that secure the display assembly to the computer chassis [1].
  - b. Lift the display assembly away from the computer chassis [2].

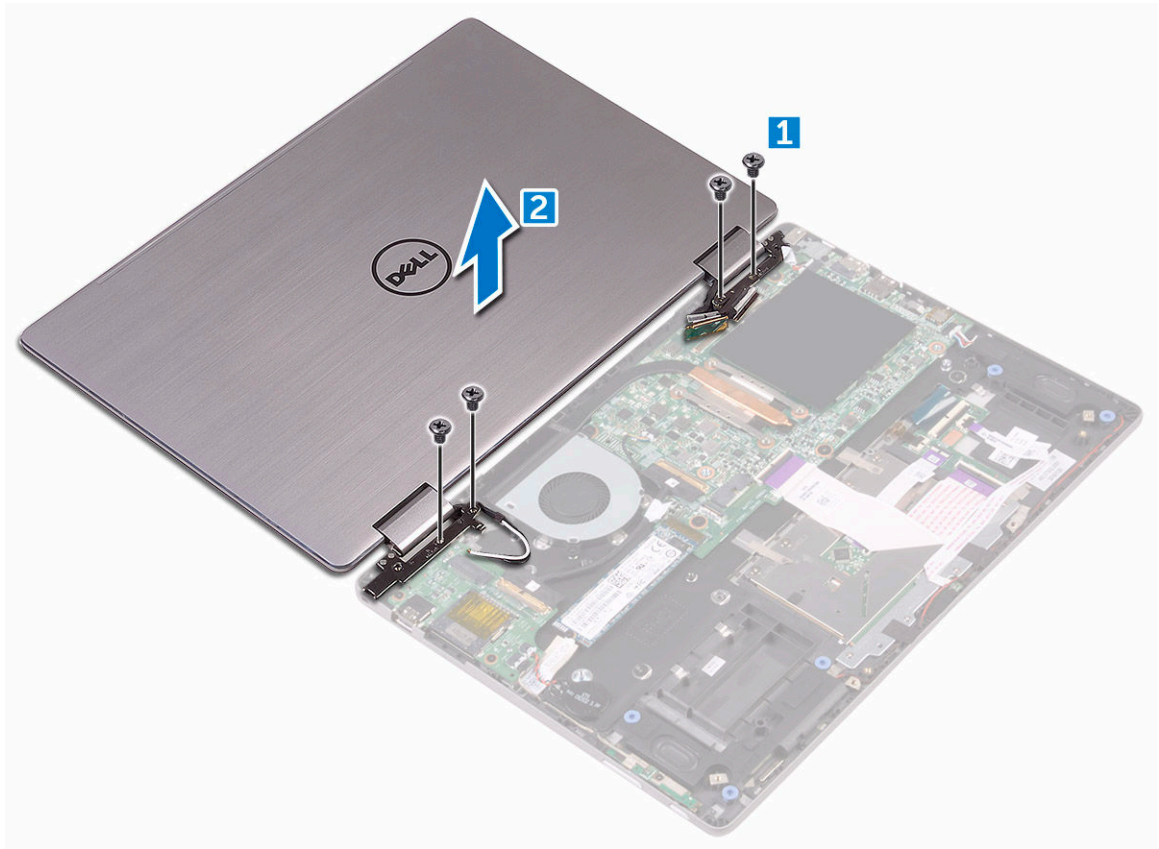

## Installing the display assembly

1. Place the display assembly to align it with the screw holders on the computer chassis.
2. Tighten the screw to secure the display assembly to the computer chassis.
3. Close the display and turn the computer over.
4. Connect the display and touch screen board cables to the connectors on the system board.
5. Affix the adhesive tapes to secure the display and touch screen board cables.
6. Install the:
  - a. [WLAN card](#)
  - b. [battery](#)
  - c. [base cover](#)
7. Follow the procedure in [After working inside your computer](#).

## Display cover

### Removing the display cover

1. Follow the procedure in [Before working inside your computer](#).
2. Remove the:
  - a. [base cover](#)
  - b. [battery](#)

- c. [display assembly](#)
3. To remove the display cover:
  - a. Using a plastic scribe, pry the display cover from the edges to release it from the display assembly [1].
  - b. Lift the display cover away from the display assembly [2].
  - c. Release the display cable and touch screen board cable from under the display hinge [3].



### Installing the display cover

1. Route the display cable and touch screen board cable to the display hinge.
2. Place the display cover on the display assembly and press along the edges to secure it.
3. Install the:
  - a. [display assembly](#)
  - b. [battery](#)
  - c. [base cover](#)
4. Follow the procedure in [After working inside your computer](#).



# Display cable

## Removing the display cable

1. Follow the procedure in [Before working inside your computer](#).
2. Remove the:
  - a. [base cover](#)
  - b. [battery](#)
  - c. [display assembly](#)
  - d. [display cover](#)
3. To remove the display cable:
  - a. Peel the adhesive tapes [1] [2].
  - b. Disconnect the sensor board cable from the display panel [3].
  - c. Open the latch and disconnect the display cable from the display panel [4].
  - d. Lift the display cable away from the display panel [5].
  - e. Release the display cable from the routing channels [6].

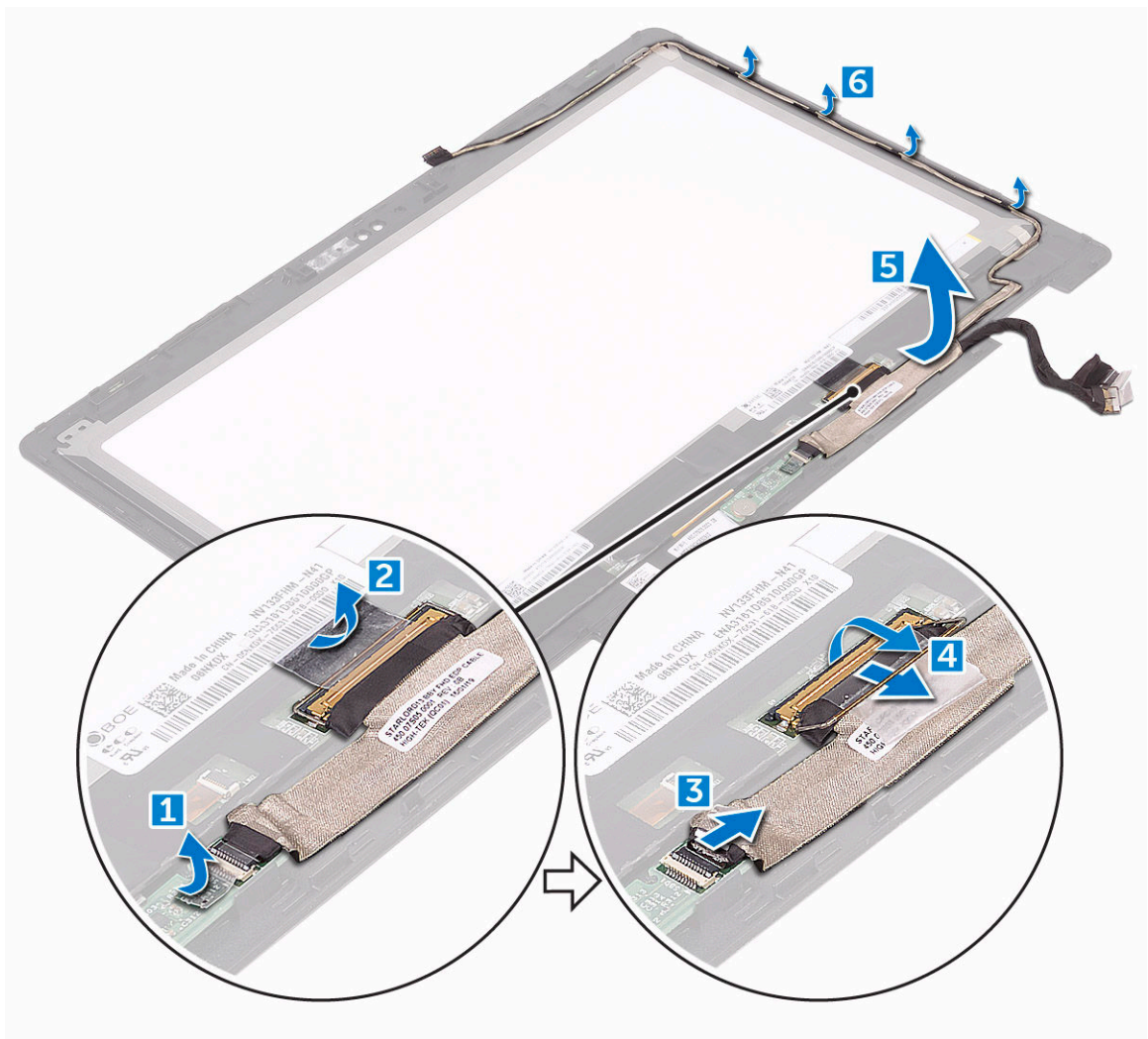

## Installing the display cable

1. Route the display cable through the placeholders on the display panel.
2. Align the display cable along the routing channels on the display panel.
3. Connect the display cable and sensor board cable to the connectors on the display panel.
4. Affix the adhesive tapes to secure the display cable and sensor board cable.
5. Install the:
  - a. [display cover](#)
  - b. [display assembly](#)
  - c. [battery](#)
  - d. [base cover](#)
6. Follow the procedure in [After working inside your computer](#).

## Sensor board

### Removing the sensor board

1. Follow the procedure in [Before working inside your computer](#).
2. Remove the:
  - a. [base cover](#)
  - b. [battery](#)
  - c. [display assembly](#)
  - d. [display cover](#)
3. To remove the sensor board:
  - a. Remove the screw that secures the sensor board to the display panel [1].
  - b. Peel the adhesive tape that secures the sensor board cable [2].
  - c. Open the latch and disconnect the sensor board from the display panel [3].
  - d. Lift the sensor board away from the display panel [5].

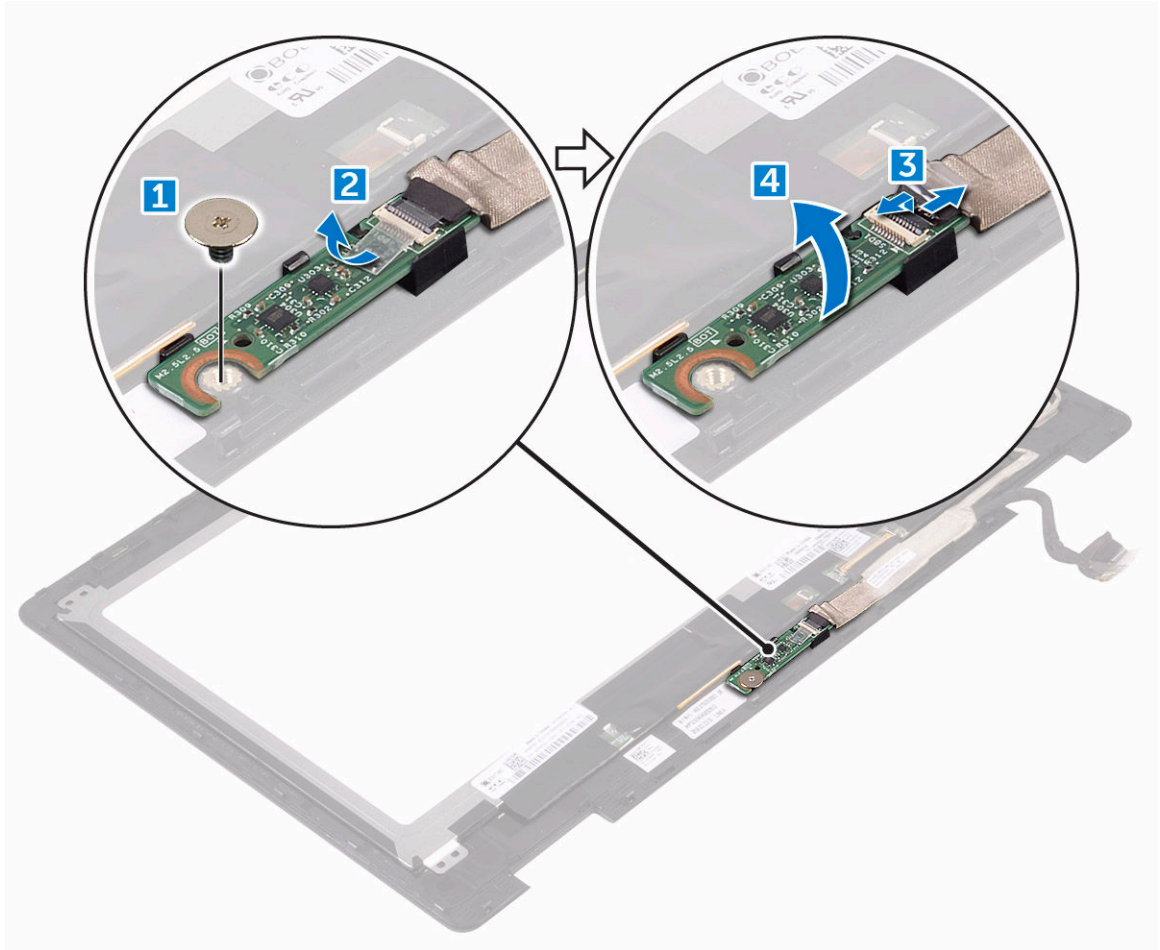

## Installing the sensor board

1. Place the sensor board into the slot on the display panel.
2. Connect the sensor board cable to the connector on the sensor board.
3. Affix the adhesive tape to secure the sensor board cable.
4. Tighten the screw to secure the sensor board to the display panel.
5. Install the:
  - a. [display cover](#)
  - b. [display assembly](#)
  - c. [battery](#)
  - d. [base cover](#)
6. Follow the procedure in [After working inside your computer](#).

# Display hinges

## Removing the display hinges

1. Follow the procedure in [Before working inside your computer](#).
2. Remove the:
  - a. [base cover](#)
  - b. [battery](#)
  - c. [display assembly](#)
  - d. [display cover](#)
  - e. [sensor board](#)
3. To remove the display hinges:
  - a. Remove the screws that secure the display hinges to the display panel [1].
  - b. Lift the display hinges away from the display panel [2].
  - c. Release the display cable that routes under the display hinge [3].

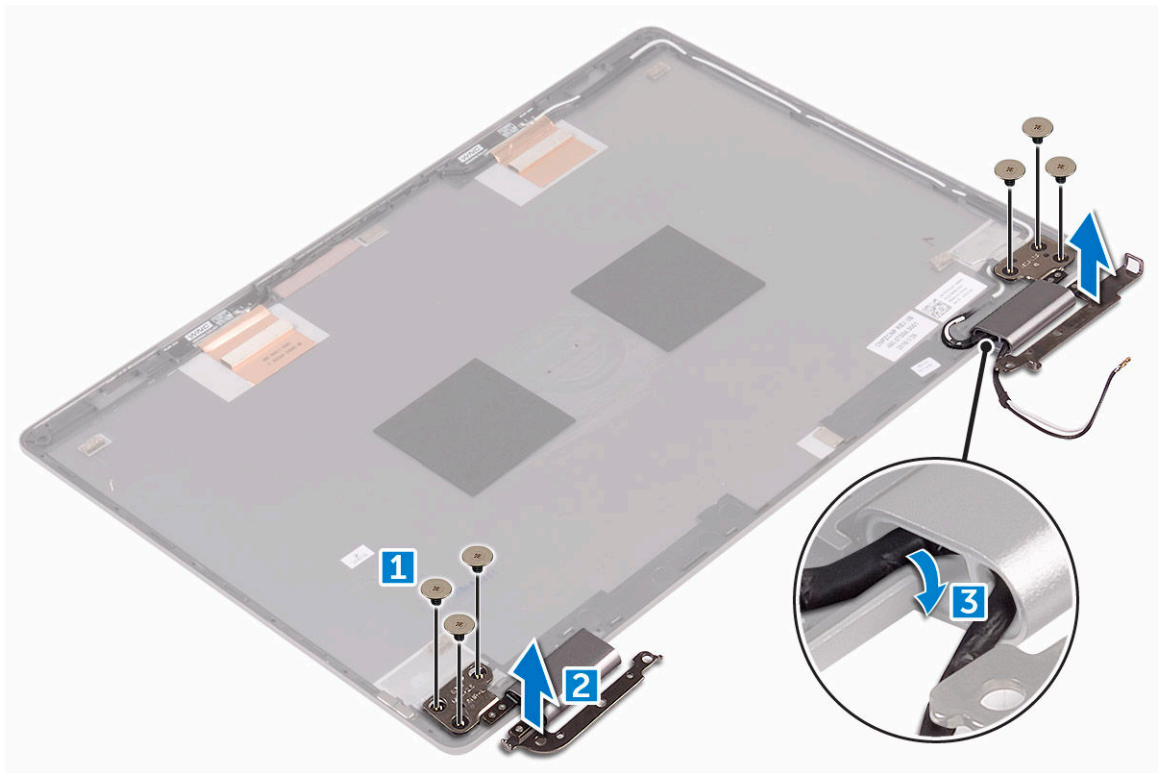

## Installing the display hinges

1. Route the display cable to the display hinge.
2. Place the display hinges on both sides of the display panel.
3. Tighten the screws to secure the display hinges to the display panel.
4. Install the:
  - a. [sensor board](#)

- b. [display cover](#)
  - c. [display assembly](#)
  - d. [battery](#)
  - e. [base cover](#)
5. Follow the procedure in [After working inside your computer](#).

## Camera

### Removing the camera

1. Follow the procedure in [Before working inside your computer](#).
2. Remove the:
  - a. [base cover](#)
  - b. [battery](#)
  - c. [display assembly](#)
  - d. [display cover](#)
3. To remove the camera:
  - a. Using a plastic scribe, release the camera module from the display panel [1] [2].
  - b. Disconnect the camera cable from the camera module [3].

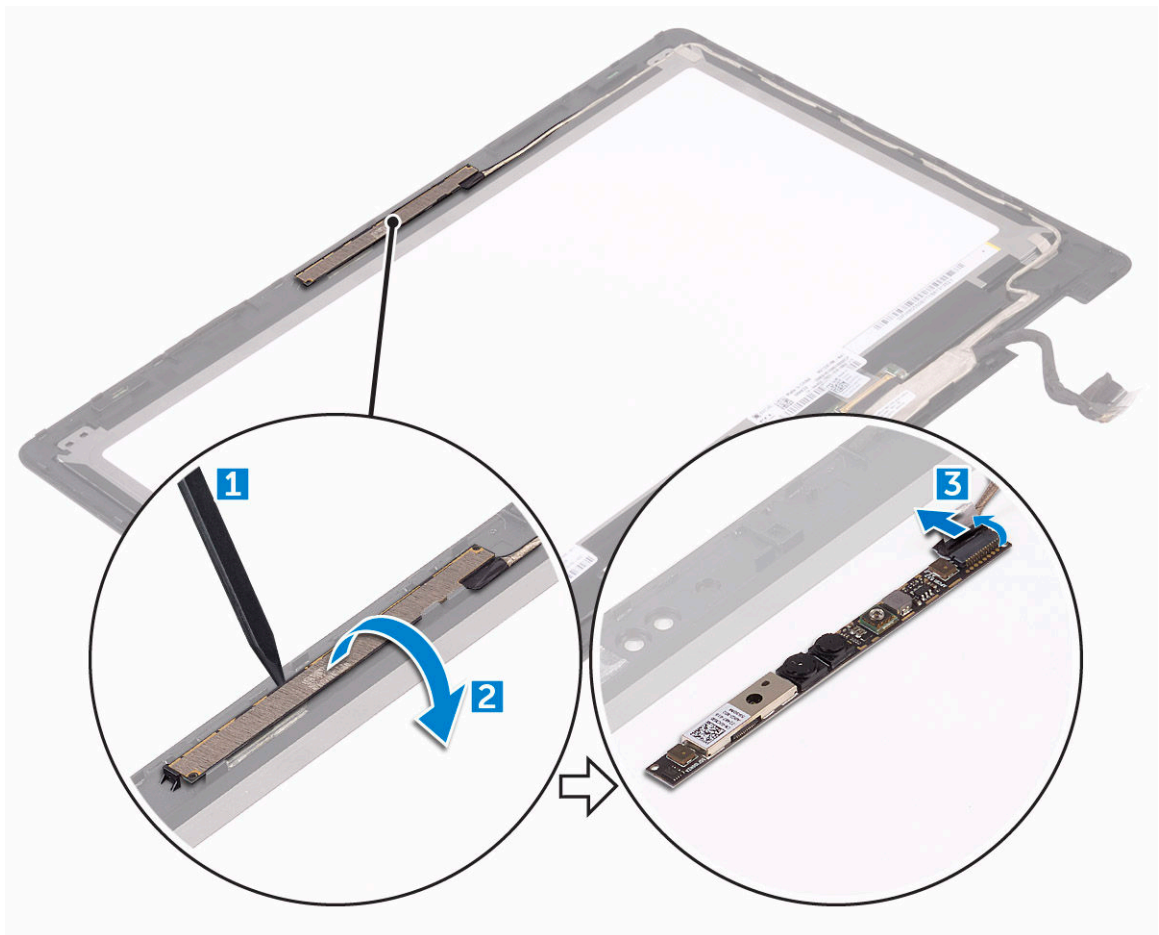

## Installing the camera

1. Connect the camera cable to the connector on the camera module.
2. Place the camera module into the slot on the display panel.
3. Install the:
  - a. [display cover](#)
  - b. [display assembly](#)
  - c. [battery](#)
  - d. [base cover](#)
4. Follow the procedure in [After working inside your computer](#).

## System board

### Removing the system board

1. Follow the procedure in [Before working inside your computer](#).
2. Remove the:
  - a. [base cover](#)
  - b. [battery](#)
  - c. [SSD card](#)
  - d. [coin cell battery](#)
  - e. [WLAN card](#)
  - f. [system fan](#)
3. Peel the adhesive tapes that secure the following cables:
  - a. I/O board [1]
  - b. display [2]
  - c. touch screen



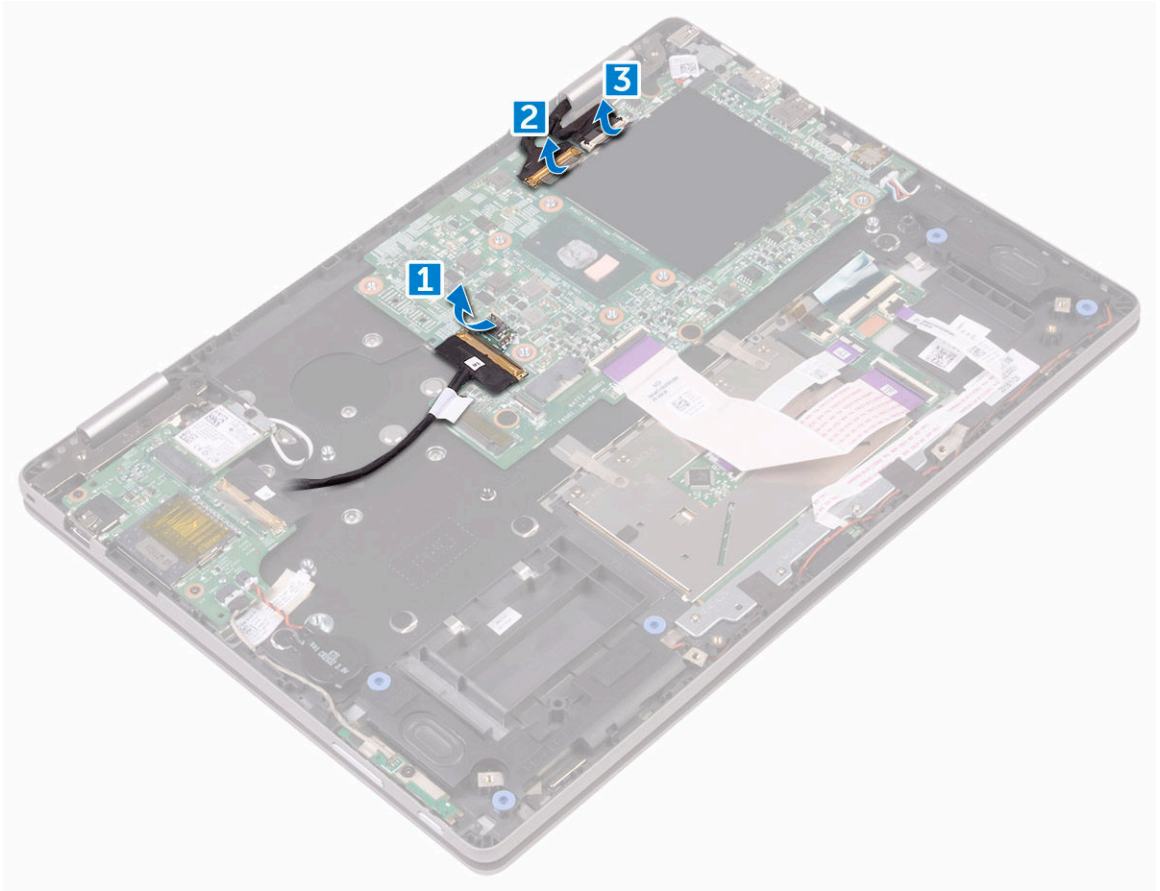

4. Disconnect the following cables from the system board:
  - a. I/O board [1]
  - b. keyboard daughter board [2]
  - c. speaker [3]
  - d. power connector port [4]
  - e. touch screen [5]
  - f. display [6]

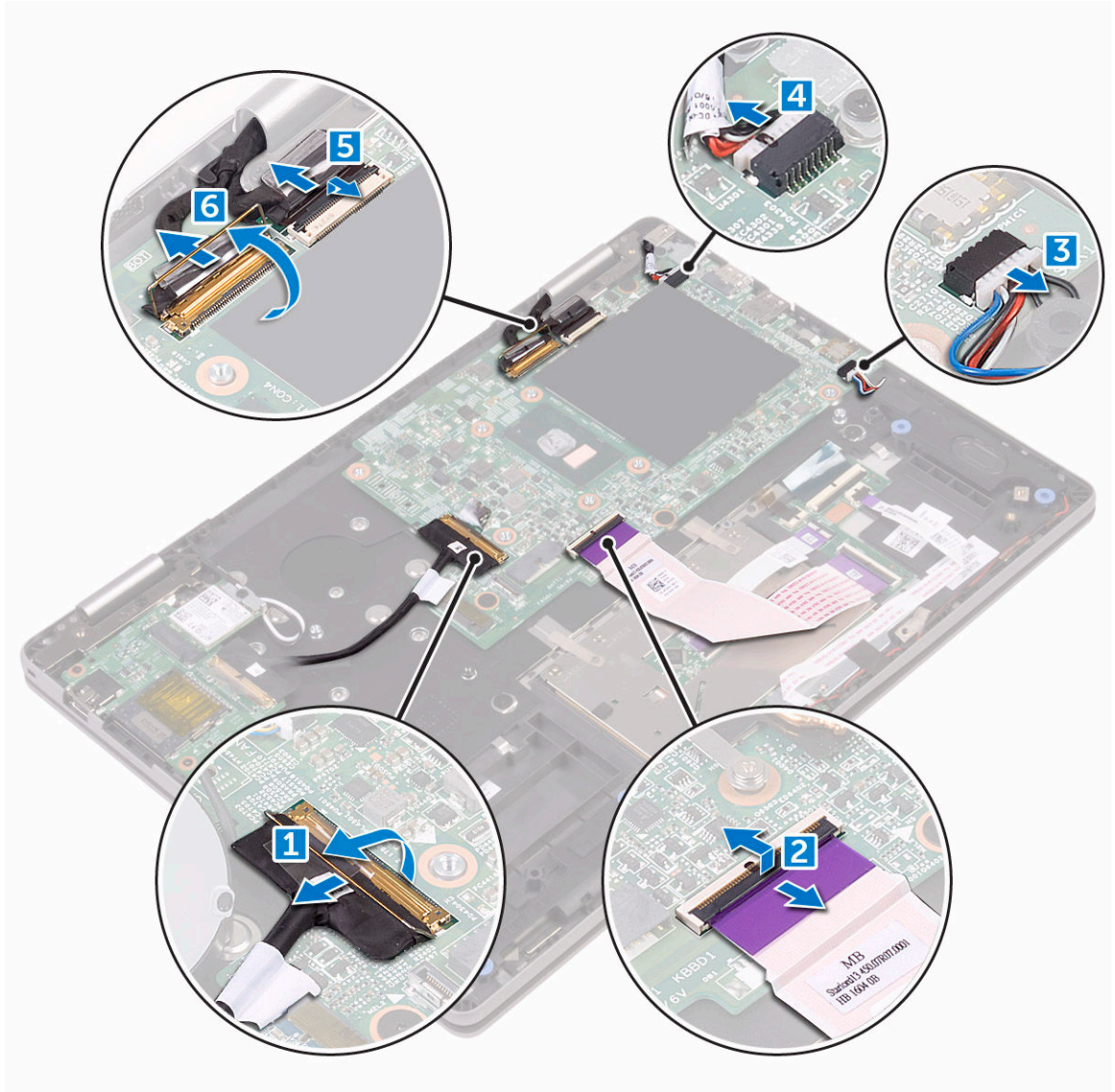

5. To remove the system board:
  - a. Remove the screws that secure the system board to the computer [1].
  - b. Lift the system board away from the computer [2].



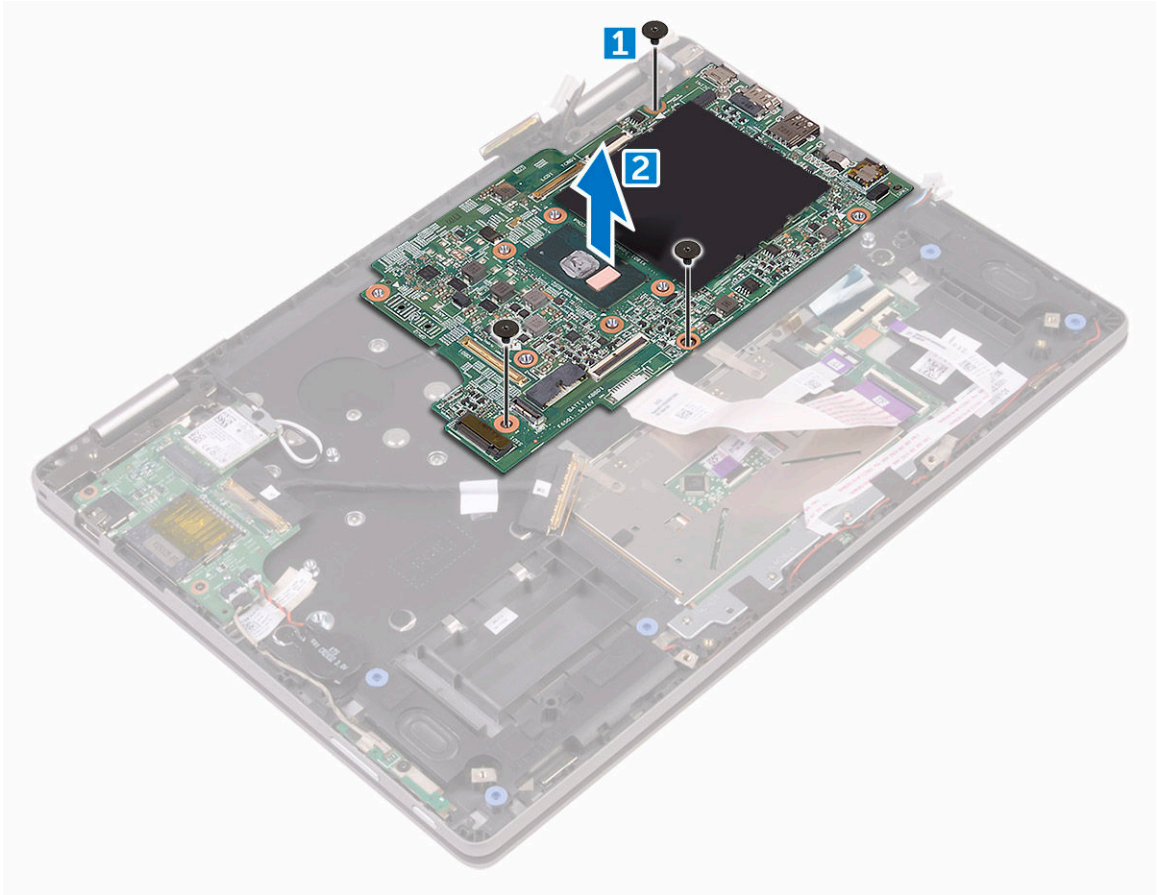

## Installing the system board

1. Place the system board on the computer.
2. Tighten the screws to secure the system board to the computer.
3. Connect the following cables to the connectors on the system board:
  - a. display
  - b. touch screen
  - c. power connector port
  - d. speaker
  - e. keyboard daughter board
  - f. I/O board
4. Affix the adhesive tapes to secure the I/O board, display, and touch screen cables.
5. Install the:
  - a. [battery](#)
  - b. [base cover](#)
6. Follow the procedure in [After working inside your computer](#).

# Keyboard

## Removing the keyboard

1. Follow the procedure in [Before working inside your computer](#).
2. Remove the:
  - a. [base cover](#)
  - b. [battery](#)
  - c. [SSD card](#)
  - d. [coin cell battery](#)
  - e. [WLAN card](#)
  - f. [system fan](#)
  - g. [heatsink](#)
  - h. [I/O board](#)
  - i. [power connector port](#)
  - j. [display assembly](#)
  - k. [system board](#)
3. Disconnect the speaker cable and lift the speaker away from the computer.

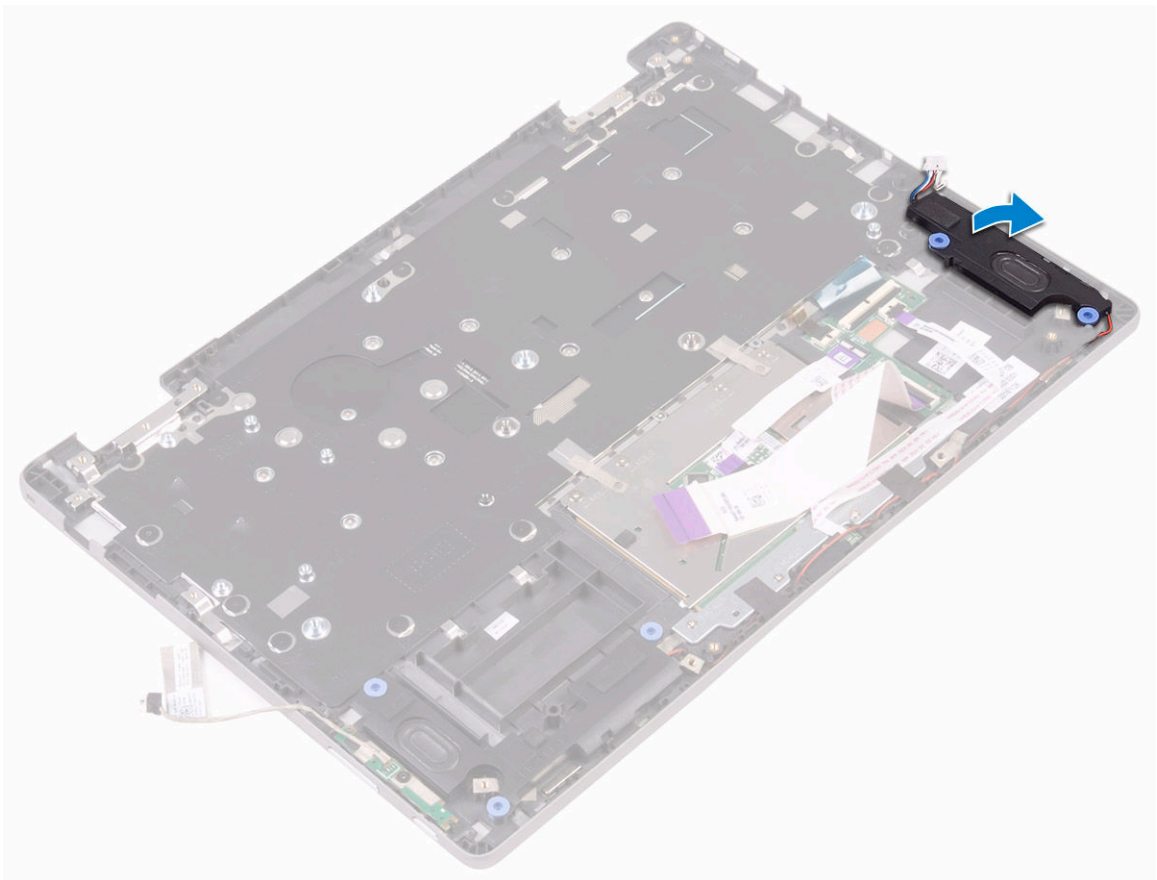

4. To release the keyboard:
  - a. Remove the screws that secure the keyboard shield to the keyboard.

b. Lift the keyboard shield away from the keyboard.

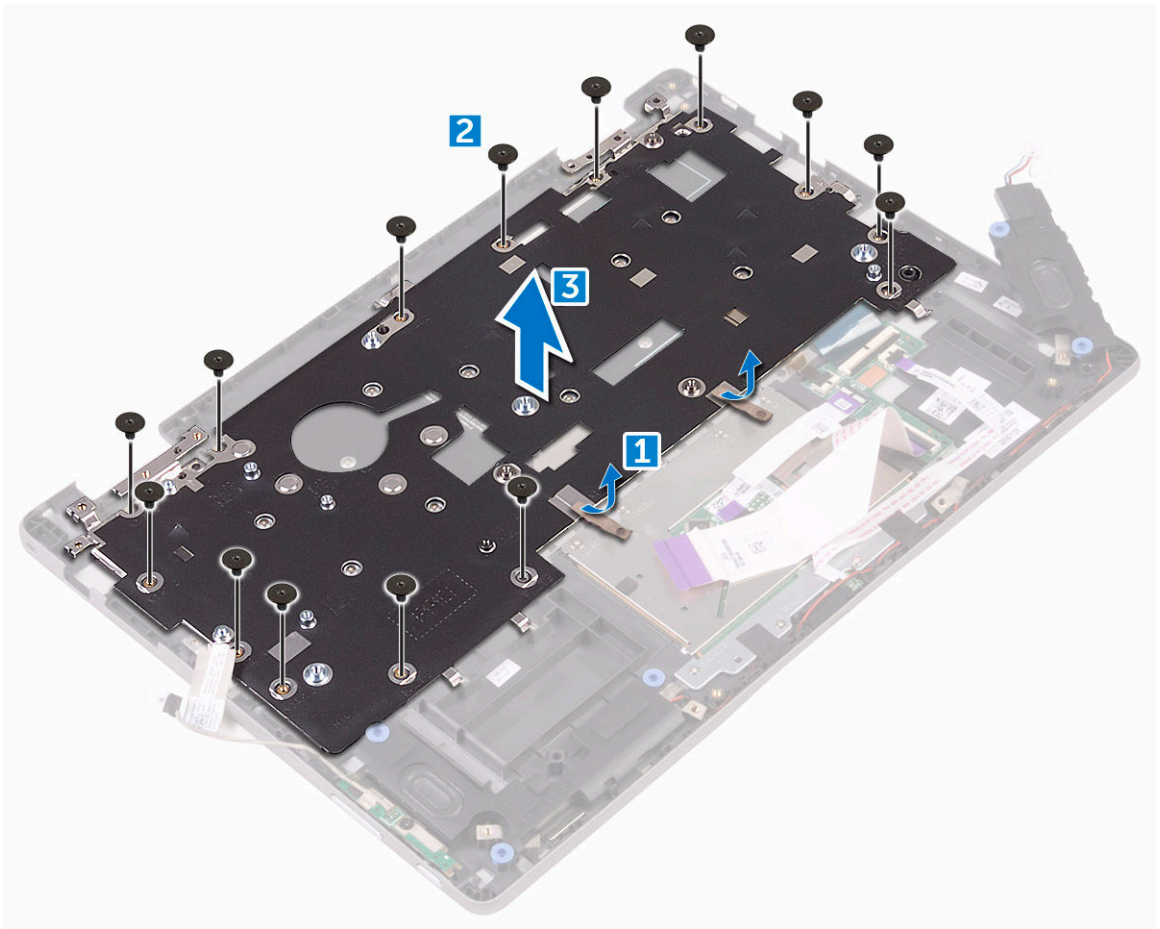

5. To remove the keyboard:
  - a. Open the latches and disconnect the keyboard backlight cable [1] and keyboard cable [2] from the system board.
  - b. Remove the screws that secure the keyboard to the computer [3].
  - c. Lift the keyboard away from the computer [4].

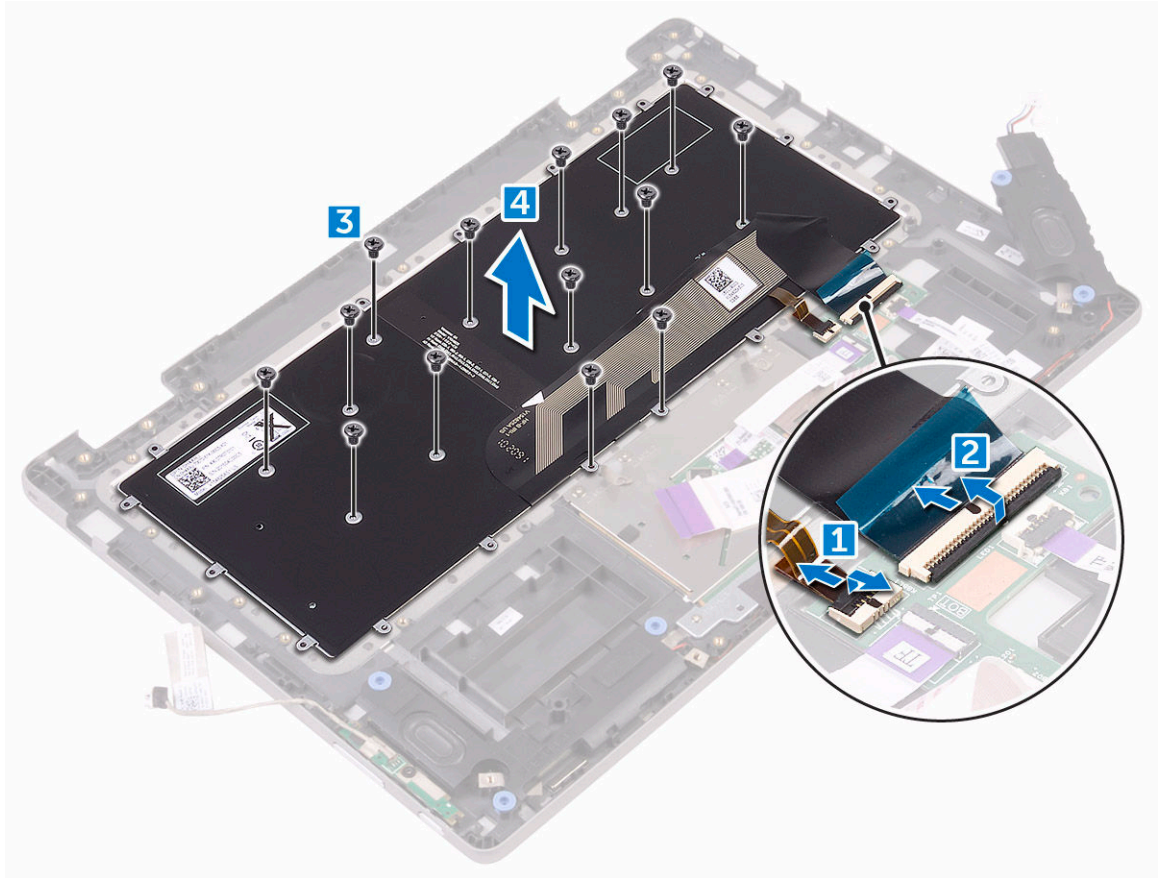

## Installing the keyboard

1. Place the keyboard into the slot on the computer.
2. Tighten the screws to secure the keyboard to the computer.
3. Connect the keyboard backlight cable and keyboard cable to the connectors on the system board.
4. Place the keyboard shield over to secure the keyboard.
5. Tighten the screws to secure the keyboard shield to the keyboard.
6. Connect the speaker cable and replace the speaker to the computer.
7. Install the:
  - a. [system board](#)
  - b. [display assembly](#)
  - c. [power connector port](#)
  - d. [I/O board](#)
  - e. [heatsink](#)
  - f. [system fan](#)
  - g. [WLAN card](#)
  - h. [coin cell battery](#)
  - i. [SSD card](#)
  - j. [battery](#)
  - k. [base cover](#)

8. Follow the procedure in [After working inside your computer](#).

## Palmrest

### Removing the palmrest

1. Follow the procedure in [Before working inside your computer](#).
2. Remove the:
  - a. [base cover](#)
  - b. [battery](#)
  - c. [WLAN card](#)
  - d. [power and volume control board](#)
  - e. [memory module](#)
  - f. [SSD card](#)
  - g. [coin cell battery](#)
  - h. [system fan](#)
  - i. [touchpad](#)
  - j. [heatsink](#)
  - k. [I/O board](#)
  - l. [LED board](#)
  - m. [keyboard daughter board](#)
  - n. [power connector port](#)
  - o. [display assembly](#)
  - p. [speakers](#)
  - q. [system board](#)
  - r. [keyboard](#)



The palmrest is the remaining component, after removing all the components.

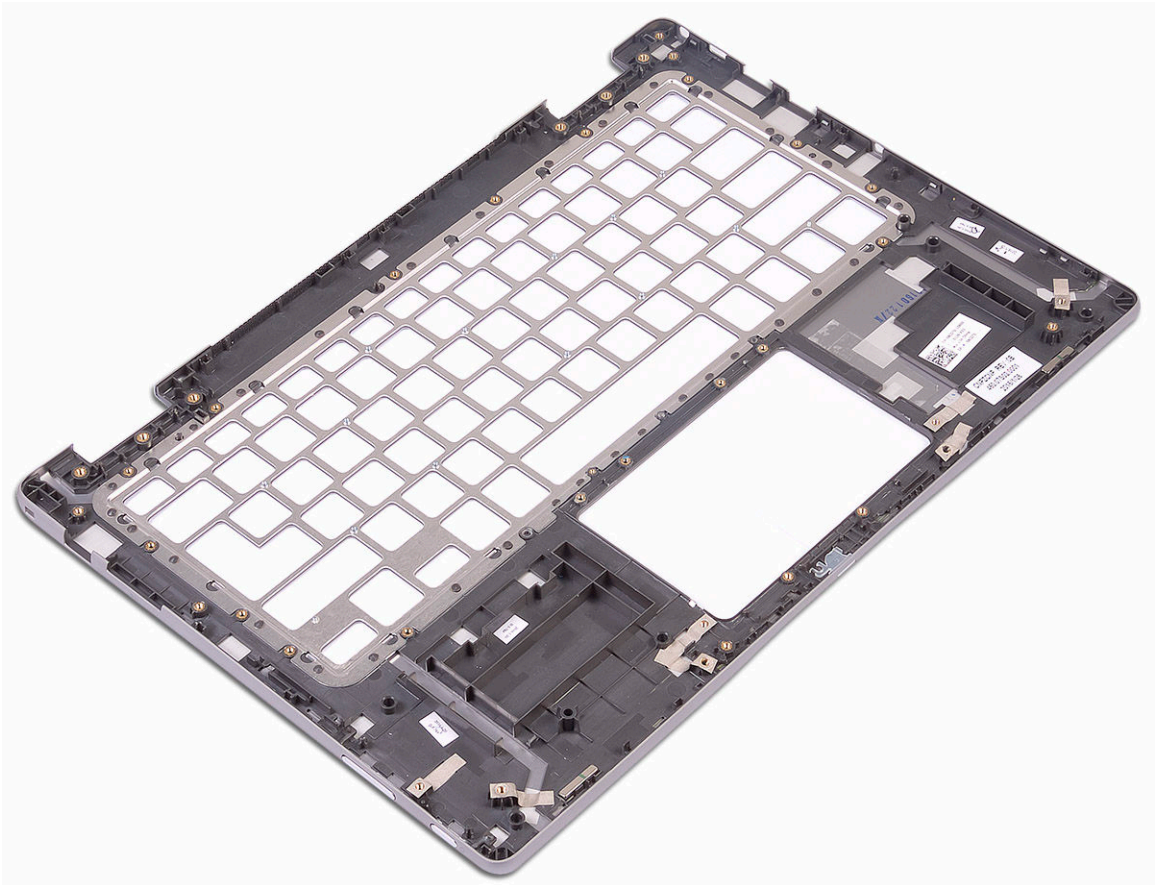

## Installing the palmrest

1. Place the palmrest on a flat surface.
2. Install the:
  - a. [system board](#)
  - b. [keyboard](#)
  - c. [speakers](#)
  - d. [display assembly](#)
  - e. [power connector port](#)
  - f. [keyboard daughter board](#)
  - g. [I/O board](#)
  - h. [LED board](#)
  - i. [heatsink](#)
  - j. [touchpad](#)
  - k. [system fan](#)
  - l. [coin cell battery](#)
  - m. [SSD card](#)
  - n. [WLAN card](#)
  - o. [memory module](#)
  - p. [power and volume control board](#)



- q. [battery](#)
  - r. [base cover](#)
3. Follow the procedure in [After working inside your computer.](#)

# Technology and components

## Power adapter

This laptop is offered with the 45 W power adapter. This adapter uses an E4 connector.

 **WARNING:** When you disconnect the power adapter cable from the laptop, grasp the connector, not the cable itself, and then pull firmly but gently to avoid damaging the cable.

 **WARNING:** The power adapter works with electrical outlets worldwide. However, power connectors and power strips vary among countries. Using an incompatible cable or improperly connecting the cable to the power strip or electrical outlet may cause fire or equipment damage.

## Processors

This laptop is shipped with the following processors:

- Intel Pentium-4405U
- Intel Core i3-6100U
- Intel Core i5-6200U
- Intel Core i5-6300U

 **NOTE:** The clock speed and performance varies depending on the workload and other variables.

## Identifying processors in Windows 10

1. Tap **Search the Web and Windows**.
2. Type **Device Manager**.
3. Tap **Processor**.



The basic information of the processor is displayed.

## Verifying the processor usage in Task Manager

1. Press and hold the taskbar.
2. Select **Start Task Manager**.  
The **Windows Task Manager** window is displayed.
3. Click the **Performance** tab in the **Windows Task Manager** window.

The processor performance details are displayed.

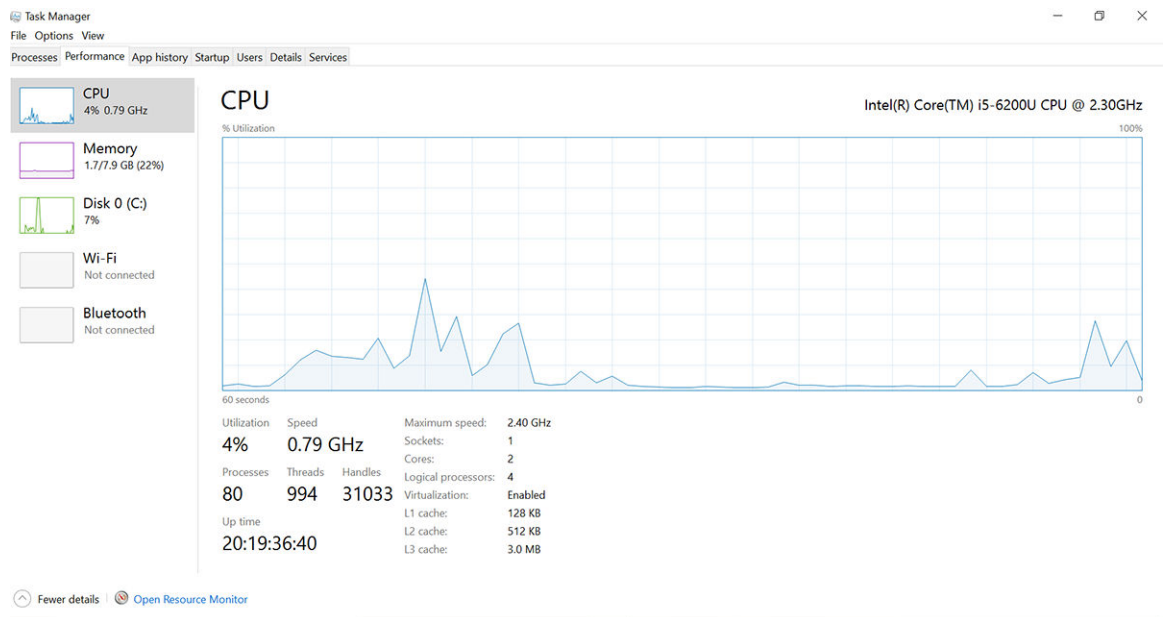

## Verifying the processor usage in Resource Monitor

1. Press and hold the taskbar.
2. Select **Start Task Manager**.  
The **Windows Task Manager** window is displayed.
3. Click the **Performance** tab in the **Windows Task Manager** window.  
The processor performance details are displayed.
4. Click **Open Resource Monitor**.

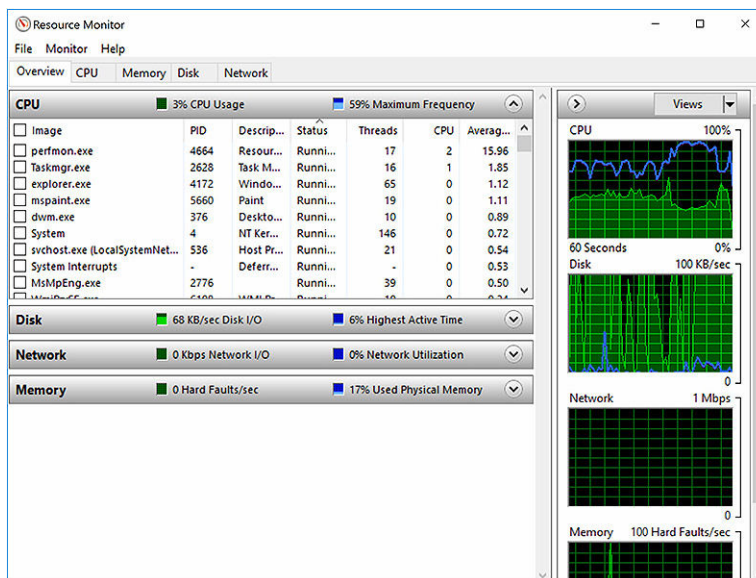

# Chipsets

All laptop communicate with the CPU through the chipset. This laptop is shipped with the Intel 100 Series chipset.

## Downloading the chipset driver

1. Turn on the laptop.
2. Go to **Dell.com/support**.
3. Click **Product Support**, enter the Service Tag of your laptop, and then click **Submit**.

 **NOTE:** If you do not have the Service Tag, use the autodetect feature or manually browse for your laptop model.

4. Click **Drivers and Downloads**.
5. Select the operating system installed on your laptop.
6. Scroll down the page, expand **Chipset**, and select your chipset driver.
7. Click **Download File** to download the latest version of the chipset driver for your laptop.
8. After the download is complete, navigate to the folder where you saved the driver file.
9. Double-click the chipset driver file icon and follow the instructions on the screen.

## Identifying the chipset in Device Manager on Windows 10

1. Click **Settings**  on the Windows 10 Charms Bar.
2. From the **Control Panel**, select **Device Manager**.
3. Expand **System Devices** and search for the chipset.

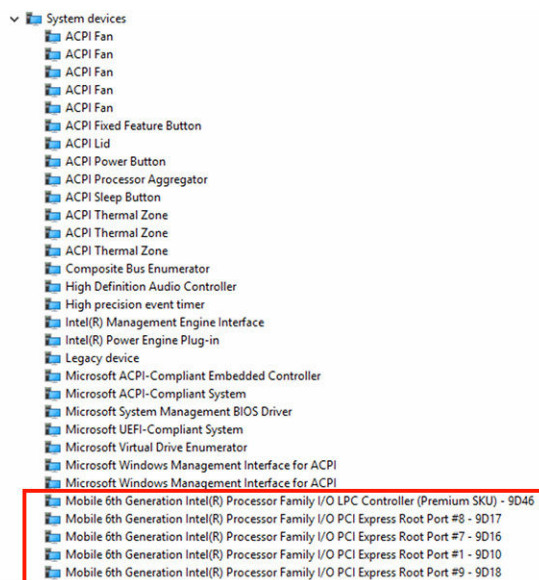

## Graphic options

This laptop is shipped with the following graphics chipset options:

- Intel HD Graphics 510 – Intel Pentium
- Intel HD Graphics 520 – Intel Core i3/i5

## Downloading drivers

1. Turn on the laptop.
2. Go to **Dell.com/support**.
3. Click **Product Support**, enter the Service Tag of your laptop, and then click **Submit**.



**NOTE:** If you do not have the Service Tag, use the auto detect feature or manually browse for your laptop model.

4. Click **Drivers and Downloads**.
5. Select the operating system installed on your laptop.
6. Scroll down the page and select the graphic driver to install.
7. Click **Download File** to download the graphic driver for your laptop.
8. After the download is complete, navigate to the folder where you saved the graphic driver file.
9. Double-click the graphic driver file icon and follow the instructions on the screen.

## Identifying the display adapter

1. Start the **Search Charm** and select **Settings**.
2. Type *Device Manager* in the search box and tap **Device Manager** from the left pane.
3. Expand **Display adapters**.

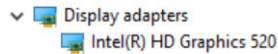

The display adapters are displayed.

## Changing the screen resolution

1. Press and hold the desktop screen and select **Display Settings**.
2. Tap or click **Display settings**.  
The Setting window is displayed.
3. Scroll down and select **Advanced Display Settings**.  
The Advanced Display Setting is displayed.
4. Select the required resolution from the drop-down list and tap **Apply**.

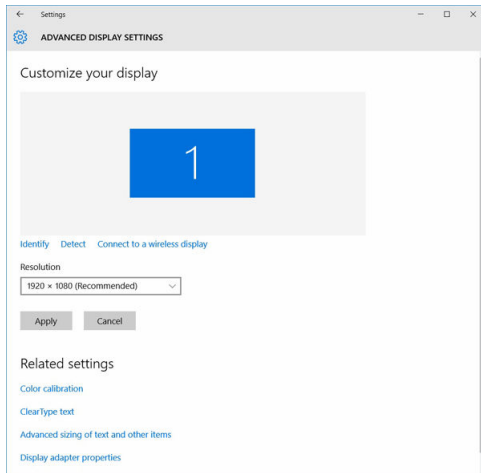

## Rotating the display

1. Press and hold on the desktop screen.  
A sub menu is displayed.
2. Select **Graphic Options** → **Rotation** and choose on of the following:
  - Rotate to Normal
  - Rotate to 90 Degrees
  - Rotate to 180 Degrees
  - Rotate to 270 Degrees

 **NOTE:** The Display can also be rotated using the following key combinations:

- Ctrl + Alt + Up arrow key (Rotate to normal)
- Right arrow key (Rotate 90 degrees)
- Down arrow key (Rotate 180 degrees)
- Left arrow key (Rotate 270 degrees)

## Display options

This laptop has 13.30– inch FHD with 1920 x 1080 resolution (maximum).

## Adjusting brightness in Windows 10



To enable or disable automatic screen brightness adjustment:

1. Swipe-in from the right edge of the display to access the Action Center.
2. Tap or click **All Settings**  → **System** → **Display**.
3. Use the **Adjust my screen brightness automatically** slider to enable or disable automatic-brightness adjustment.

 **NOTE:** You can also use the **Brightness level** slider to adjust the brightness manually.



## Cleaning the display

1. Check for any smudges or areas that has to be cleaned.
2. Use a microfiber cloth to remove any obvious dust and gently brush off any dirt particles.
3. Proper cleaning kits should be used to clean and keep your display in a crisp clear pristine condition.
  -  **NOTE:** Never spray any cleaning solutions directly on the screen; spray it to the cleaning cloth.
4. Gently wipe the screen in a circular motion. Do not press hard on the cloth.
  -  **NOTE:** Do not press hard or touch the screen with your fingers or you may leave oily prints and smears.
  -  **NOTE:** Do not leave any liquid on the screen.
5. Remove all excess moisture as it may damage your screen.
6. Let the display dry thoroughly before you turn it on.
7. For stains that are hard to remove, repeat this procedure till the display is clean.

## Using touch screen in Windows 10

Follow these steps to enable or disable the touch screen:

1. Go to the Charms Bar and tap **All Settings** .
2. Tap **Control Panel**.
3. Tap **Pen and Input Devices** in the **Control Panel**.
4. Tap the **Touch** tab.
5. Select **Use your finger as an input device** to enable the touch screen. Clear the box to disable the touch screen.

## Connecting to external display devices

Follow these steps to connect your laptop to an external display device:

1. Ensure that the projector is turned on and plug the projector cable into a video port on your laptop.
2. Press the Windows logo+P key.
3. Select one of the following modes:
  - PC screen only
  - Duplicate
  - Extend
  - Second Screen only

 **NOTE:** For more information, see the document that shipped with your display device.

## Realtek ALC3253 Waves MaxxAudio Pro controller

This laptop ships with integrated Realtek ALC3253–CG Waves MaxxAudio Pro controller. It is a High Definition audio codec designed for Windows desktop and laptops.

## Downloading the audio driver

1. Turn on the laptop.
2. Go to [www.dell.com/support](http://www.dell.com/support).
3. Click **Product Support**, enter the Service Tag of your laptop and click **Submit**.



**NOTE:** If you do not have the Service Tag, use the autodetect feature or manually browse for your laptop model.

4. Click **Drivers and Downloads**.
5. Select the operating system installed on your laptop.
6. Scroll down the page and expand **Audio**.
7. Select the audio driver.
8. Click **Download File** to download the latest version of the audio driver for your laptop.
9. After the download is complete, navigate to the folder where you saved the audio driver file.
10. Double-click the audio driver file icon and follow the instructions on the screen.

## Identifying the audio controller in Windows 10

1. Start the **Search Charm** and select **All Settings** .
2. Type `Device Manager` in the search box and select **Device Manager** from the left pane.
3. Expand **Sound, video and game controllers**.

The audio controller is displayed.

**Table 1. Identifying the audio controller in Windows 10**

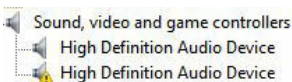
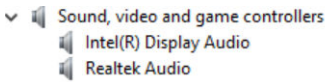
Before installation	After installation
	

## Changing the audio settings

1. Tap or touch the **Search the web and Windows** and type `Dell Audio`.
2. Start the Dell Audio utility from the left pane.

## WLAN cards

This laptop supports the Intel Dual Band Wireless AC 7265 WLAN card.

## Secure Boot screen options

Option	Description
<b>Secure Boot Enable</b>	This option enables or disables the <b>Secure Boot</b> feature. <ul style="list-style-type: none"><li>• Disabled</li><li>• Enabled</li></ul>

Option	Description
	Default setting: Enabled.
<b>Expert Key Management</b>	<p>Allows you to manipulate the security key databases only if the system is in Custom Mode. The <b>Enable Custom Mode</b> option is disabled by default. The options are:</p> <ul style="list-style-type: none"> <li>• PK</li> <li>• KEK</li> <li>• db</li> <li>• dbx</li> </ul> <p>If you enable the <b>Custom Mode</b>, the relevant options for <b>PK, KEK, db, and dbx</b> appear. The options are:</p> <ul style="list-style-type: none"> <li>• <b>Save to File</b>—Saves the key to a user-selected file</li> <li>• <b>Replace from File</b>—Replaces the current key with a key from a user-selected file</li> <li>• <b>Append from File</b>—Adds a key to the current database from a user-selected file</li> <li>• <b>Delete</b>—Deletes the selected key</li> <li>• <b>Reset All Keys</b>—Resets to default setting</li> <li>• <b>Delete All Keys</b>—Deletes all the keys</li> </ul> <p> <b>NOTE:</b> If you disable the <b>Custom Mode</b>, all the changes made will be erased and the keys will restore to default settings.</p>

## Hard drive options

This laptop supports SATA drives and SSDs.

### Identifying the hard drive in Windows 10

1. Tap or click **All Settings**  on the Windows 10 Charms Bar.
2. Tap or click **Control Panel**, select **Device Manager**, and expand **Disk drives**.



The hard drive is listed under **Disk drives**.

### Entering BIOS setup

1. Turn on or restart your laptop.
2. When the Dell logo appears, perform one of the following actions to enter the BIOS setup program:
  - With keyboard — Tap F2 until the Entering BIOS setup message appears. To enter the Boot selection menu, tap F12.
  - Without keyboard — When the **F12 boot selection** menu is displayed, press the Volume Down button to enter BIOS setup. To enter the Boot selection menu, press the Volume Up button.

Hard drive is listed under the **System Information** under the **General** group.

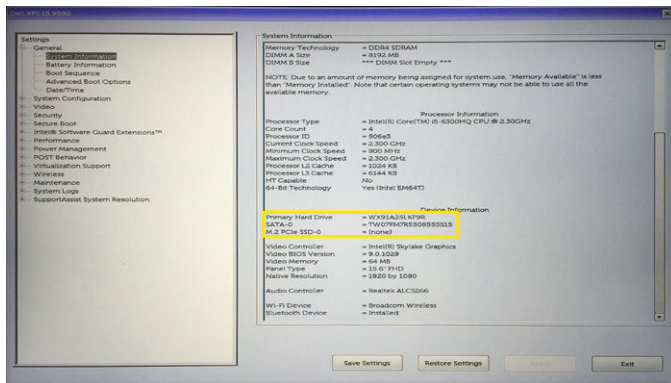

## Camera features

This laptop comes with front-facing camera with the image resolution of 1280 x 720 (maximum).

 **NOTE:** The camera is at the top center of the LCD.

## Identifying the camera in Device Manager on Windows 10

1. In the **Search** box, type `device manager`, and tap to start it.
2. Under **Device Manager**, expand **Imaging devices**.

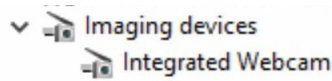

## Starting the camera

To start the camera, open an application that uses the camera. For instance, if you tap the Dell webcam central software or the Skype software that is shipped with the laptop, the camera turns on. Similarly, if you are chatting on the internet and the application requests to access the webcam, the webcam turns on.

## Starting the camera app

1. Tap or click the **Windows** button and select **All apps**.

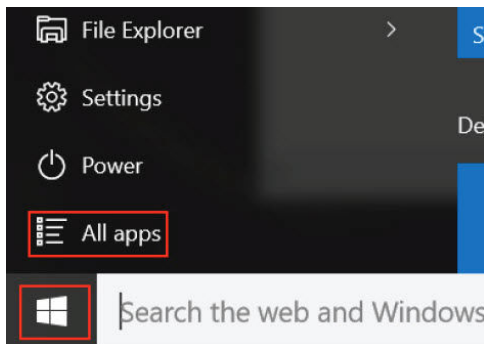

2. Select **Camera** from the apps list.

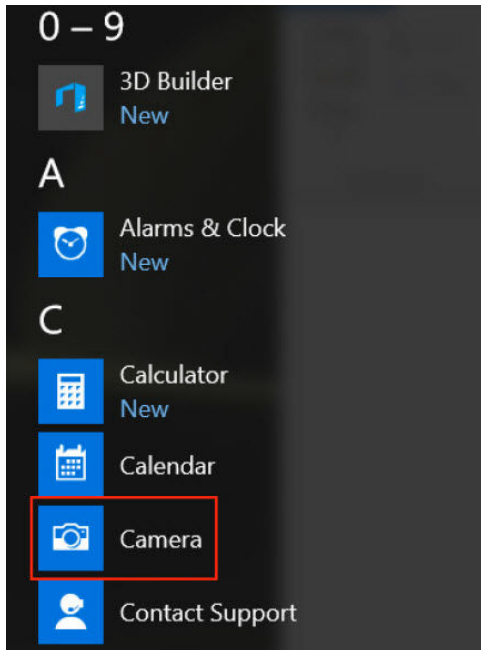

3. If the **Camera** App is not available in the apps list, search for it.

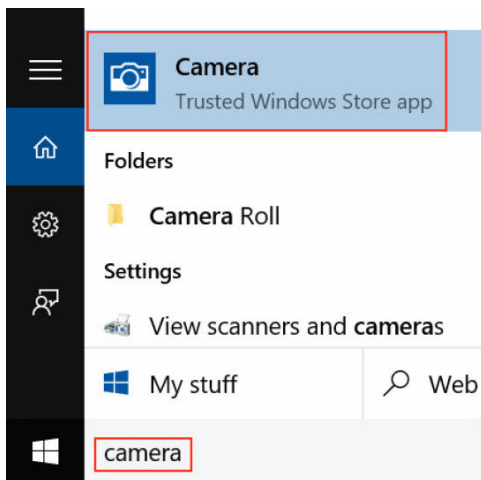

## Memory features

This laptop supports 4–16 GB DDR4 SODIMM memory, up to 2133 MHz.

### Verifying system memory in Windows 10

1. Tap the **Windows** button and select **All Settings**  → **System** .
2. Under **System**, tap **About**.

## Verifying system memory in setup

1. Turn on or restart your laptop.
2. Perform one of the following actions after the Dell logo is displayed:
  - With keyboard — Tap F2 until the Entering BIOS setup message appears. To enter the Boot selection menu, tap F12.
  - Without keyboard — When the **F12 boot selection** menu is displayed, press the Volume Down button to enter BIOS setup. To enter the Boot selection menu, press the Volume Up button.
3. On the left pane, select **Settings** → **General** → **System Information**.  
The memory information is displayed on the right pane.

## Testing memory using ePSA

1. Turn on or restart your laptop.
2. Perform one of the following actions after the Dell logo is displayed:
  - With keyboard — Press F2.
  - Without keyboard — Press and hold the **Volume Up** button when the Dell logo is displayed on the screen. When the F12 boot selection menu is displayed, select **Diagnostics** from the boot menu, and press Enter.

The PreBoot System Assessment (PSA) starts on your laptop.



**NOTE:** If you wait too long and the operating system logo appears, continue to wait until you see the desktop. Turn off the laptop and try again.

## Intel chipset drivers

Verify if the Intel chipset drivers are already installed in the laptop.



**Table 2. Intel chipset drivers**

Before installation	After installation
<ul style="list-style-type: none"> <li>Other devices           <ul style="list-style-type: none"> <li>PCI Data Acquisition and Signal Processing Controller</li> <li>PCI Device</li> <li>PCI Memory Controller</li> <li>PCI Simple Communications Controller</li> <li>SM Bus Controller</li> <li>Unknown device</li> </ul> </li> <li>System devices           <ul style="list-style-type: none"> <li>ACPI Fan</li> <li>ACPI Fan</li> <li>ACPI Fan</li> <li>ACPI Fan</li> <li>ACPI Fan</li> <li>ACPI Fixed Feature Button</li> <li>ACPI Power Button</li> <li>ACPI Processor Aggregator</li> <li>ACPI Thermal Zone</li> <li>ACPI Thermal Zone</li> <li>Composite Bus Enumerator</li> <li>High Definition Audio Controller</li> <li>High precision event timer</li> <li>Intel(R) Power Engine Plug-in</li> <li>Legacy device</li> <li>Microsoft ACPI-Compliant Embedded Controller</li> <li>Microsoft ACPI-Compliant System</li> <li>Microsoft System Management BIOS Driver</li> <li>Microsoft UEFI-Compliant System</li> <li>Microsoft Virtual Drive Enumerator</li> <li>Microsoft Windows Management Interface for ACPI</li> <li>Microsoft Windows Management Interface for ACPI</li> <li>NDIS Virtual Network Adapter Enumerator</li> <li>Numeric data processor</li> <li>PCI Express Root Complex</li> <li>PCI Express Root Port</li> <li>PCI Express Root Port</li> <li>PCI Express Root Port</li> <li>PCI standard host CPU bridge</li> <li>PCI standard ISA bridge</li> <li>Plug and Play Software Device Enumerator</li> <li>Programmable interrupt controller</li> <li>Remote Desktop Device Redirector Bus</li> <li>System CMOS/real time clock</li> <li>System timer</li> <li>UMBus Root Bus Enumerator</li> </ul> </li> </ul>	<ul style="list-style-type: none"> <li>Other devices           <ul style="list-style-type: none"> <li>PCI Device</li> <li>PCI Simple Communications Controller</li> <li>Unknown device</li> </ul> </li> <li>System devices           <ul style="list-style-type: none"> <li>ACPI Fan</li> <li>ACPI Fan</li> <li>ACPI Fan</li> <li>ACPI Fan</li> <li>ACPI Fan</li> <li>ACPI Fixed Feature Button</li> <li>ACPI Lid</li> <li>ACPI Processor Aggregator</li> <li>ACPI Sleep Button</li> <li>ACPI Thermal Zone</li> <li>ACPI Thermal Zone</li> <li>ACPI Thermal Zone</li> <li>Camera Sensor OV2070</li> <li>Camera Sensor OV8858</li> <li>Composite Bus Enumerator</li> <li>High precision event timer</li> <li>Intel(R) 100 Series Chipset Family LPC Controller/eSPI Controller - 9D46</li> <li>Intel(R) 100 Series Chipset Family PCI Express Root Port #10 - 9D19</li> <li>Intel(R) 100 Series Chipset Family PCI Express Root Port #9 - 9D18</li> <li>Intel(R) 100 Series Chipset Family PMIC - 9D21</li> <li>Intel(R) 100 Series Chipset Family SMBUS - 9D23</li> <li>Intel(R) 100 Series Chipset Family Thermal subsystem - 9D31</li> <li>Intel(R) CCX Host Controller</li> <li>Intel(R) Control Logic</li> <li>Intel(R) Imaging Signal Processor 2500</li> <li>Intel(R) Integrated Sensor Solution</li> <li>Intel(R) Management Engine Interface</li> <li>Intel(R) Management Engine Interface</li> <li>Intel(R) Power Engine Plug-in</li> <li>Intel(R) Serial IO GPIO Host Controller - INT344B</li> <li>Intel(R) Serial IO I2C Host Controller - 9D60</li> <li>Intel(R) Serial IO I2C Host Controller - 9D61</li> <li>Intel(R) Serial IO I2C Host Controller - 9D62</li> <li>Intel(R) Serial IO I2C Host Controller - 9D63</li> </ul> </li> </ul>

## Intel HD Graphics drivers

Verify if the Intel HD Graphics drivers are already installed in the laptop.

**Table 3. Intel HD Graphics drivers**

Before installation	After installation
<ul style="list-style-type: none"> <li>Display adapters           <ul style="list-style-type: none"> <li>Microsoft Basic Display Adapter</li> </ul> </li> <li>Sound, video and game controllers           <ul style="list-style-type: none"> <li>High Definition Audio Device</li> <li>High Definition Audio Device</li> </ul> </li> </ul>	<ul style="list-style-type: none"> <li>Display adapters           <ul style="list-style-type: none"> <li>Intel(R) HD Graphics 515</li> </ul> </li> <li>Sound, video and game controllers           <ul style="list-style-type: none"> <li>Intel(R) AVStream Camera 2500</li> <li>Intel(R) Display Audio</li> <li>Realtek High Definition Audio(SST)</li> </ul> </li> </ul>

## Realtek HD audio drivers

Verify if the Realtek audio drivers are already installed in the laptop.

**Table 4. Realtek HD audio drivers**

Before installation	After installation
<ul style="list-style-type: none"> <li>Audio inputs and outputs           <ul style="list-style-type: none"> <li>Microphone (High Definition Audio Device)</li> <li>Speakers (High Definition Audio Device)</li> </ul> </li> <li>Sound, video and game controllers           <ul style="list-style-type: none"> <li>High Definition Audio Device</li> <li>Intel(R) Display Audio</li> </ul> </li> </ul>	<ul style="list-style-type: none"> <li>Audio inputs and outputs           <ul style="list-style-type: none"> <li>Microphone Array (Realtek High Definition Audio(SST))</li> <li>Speakers / Headphones (Realtek High Definition Audio(SST))</li> </ul> </li> <li>Sound, video and game controllers           <ul style="list-style-type: none"> <li>Intel(R) AVStream Camera 2500</li> <li>Intel(R) Display Audio</li> <li>Realtek High Definition Audio(SST)</li> </ul> </li> </ul>

# System Setup

## Boot Sequence

Boot Sequence allows you to bypass the System Setup-defined boot device order and boot directly to a specific device (for example: optical drive or hard drive). During the Power-on Self Test (POST), when the Dell logo appears, you can:

- Access System Setup by pressing F2 key
- Bring up the one-time boot menu by pressing F12 key

The one-time boot menu displays the devices that you can boot from including the diagnostic option. The boot menu options are:

- Removable Drive (if available)
- STXXXX Drive

 **NOTE:** XXX denotes the SATA drive number.

- Optical Drive
- Diagnostics

 **NOTE:** Choosing **Diagnostics**, will display the **ePSA diagnostics** screen.

The boot sequence screen also displays the option to access the System Setup screen.

## Navigation keys

 **NOTE:** For most of the System Setup options, changes that you make are recorded but do not take effect until you restart the system.

Keys	Navigation
Up arrow	Moves to the previous field.
Down arrow	Moves to the next field.
Enter	Selects a value in the selected field (if applicable) or follow the link in the field.
Spacebar	Expands or collapses a drop-down list, if applicable.
Tab	Moves to the next focus area.

 **NOTE:** For the standard graphics browser only.

Keys	Navigation
Esc	Moves to the previous page until you view the main screen. Pressing Esc in the main screen displays a message that prompts you to save any unsaved changes and restarts the system.
F1	Displays the System Setup help file.

## System setup options

 **NOTE:** Depending on the computer and its installed devices, the items listed in this section may or may not appear.

## General screen options

This section lists the primary hardware features of your computer.

Option	Description
<b>System Information</b>	<ul style="list-style-type: none"> <li>• System Information: Displays BIOS Version, Service Tag, Asset Tag, Ownership Tag, Ownership Date, Manufacture Date, and the Express Service Code.</li> <li>• Memory Information: Displays Memory Installed, Memory Available, Memory Speed, Memory Channels Mode, Memory Technology, DIMM A Size, DIMM B Size.</li> <li>• Processor Information: Displays Processor Type, Core Count, Processor ID, Current Clock Speed, Minimum Clock Speed, Maximum Clock Speed, Processor L2 Cache, Processor L3 Cache, HT Capable, and 64-Bit technology.</li> <li>• Device Information: SATA-0, SATA-1, Video Controller, Video BIOS Version, Video Memory, Panel Type, Native Resolution, Audio Controller, WiFi Device, Bluetooth Device.</li> </ul>
<b>Battery Information</b>	Displays the battery status and the type of AC adapter connected to the computer.
<b>Boot Sequence</b>	<p><b>Boot Sequence</b> Allows you to change the order in which the computer attempts to find an operating system. The options are:</p> <ul style="list-style-type: none"> <li>• Windows Boot Manager</li> </ul> <p><b>Boot List Options</b> Allows you to change the boot list option:</p> <ul style="list-style-type: none"> <li>• Legacy</li> <li>• UEFI (enabled by default)</li> </ul>
<b>Advanced Boot Options</b>	This option allows you the legacy option ROMs to load. By default, the <b>Enable Legacy Option ROMs</b> is disabled.
<b>Date/Time</b>	Allows you to change the date and time.

## System Configuration screen options

Option	Description
<b>SATA Operation</b>	<p>Allows you to configure the internal SATA hard-drive controller. The options are:</p> <ul style="list-style-type: none"><li>• Disabled</li><li>• AHCI: This option is enabled by default.</li></ul>
<b>Drives</b>	<p>Allows you to configure the SATA drives on board. All drives are enabled by default. The options are:</p> <ul style="list-style-type: none"><li>• SATA-0</li><li>• SATA-1</li></ul>
<b>SMART Reporting</b>	<p>This field controls whether hard drive errors for integrated drives are reported during system startup. This technology is part of the SMART (Self Monitoring Analysis and Reporting Technology) specification. This option is disabled by default.</p> <ul style="list-style-type: none"><li>• Enable SMART Reporting</li></ul>
<b>USB Configuration</b>	<p>This field configures the integrated USB controller. If Boot Support is enabled, the system is allowed to boot any type of USB Mass Storage Devices (HDD, memory key, floppy).</p> <p>If USB port is enabled, device attached to this port is enabled and available for OS.</p> <p>If USB port is disabled, the OS cannot see any device attached to this port.</p> <p>The options are:</p> <ul style="list-style-type: none"><li>• Enable USB Boot Support (by default enable)</li><li>• Enable External USB Port (by default enable)</li></ul>
<b>USB PowerShare</b>	<p>This field configures the USB PowerShare feature behavior. This option allows you to charge external devices using the stored system battery power through the USB PowerShare port.</p>
<b>Audio</b>	<p>This field enables or disables the integrated audio controller. By default, the <b>Enable Audio</b> option is selected. The options are:</p> <ul style="list-style-type: none"><li>• Enable Microphone (by default enable)</li><li>• Enable Internal Speaker (by default enable)</li></ul>
<b>Miscellaneous Devices</b>	<p>Allows you to enable or disable the following devices:</p> <ul style="list-style-type: none"><li>• Enable Camera (enabled by default)</li><li>• Enable Secure Digital (SD) card (enabled by default)</li></ul>





Option	Description
	 <b>NOTE:</b> All devices are enabled by default.



## Video screen options

Option	Description
<b>LCD Brightness</b>	Allows you to set the display brightness depending up on the power source (On Battery and On AC).
<b>Switchable Graphics</b>	Allows you to enable or disable the switchable graphics technologies, such as NVIDIA, Optimus, and AMD PowerExpress\X99.

 **NOTE:** The video setting will be visible only when a video card is installed into the system.

## Security screen options

Option	Description
<b>Admin Password</b>	Allows you to set, change, or delete the administrator (admin) password.   <b>NOTE:</b> You must set the admin password before you set the system or hard drive password. Deleting the admin password automatically deletes the system password and the hard drive password.   <b>NOTE:</b> Successful password changes take effect immediately.  Default setting: Not set
<b>System Password</b>	Allows you to set, change or delete the system password.   <b>NOTE:</b> Successful password changes take effect immediately.  Default setting: Not set
<b>Internal HDD-1 Password</b>	Allows you to set, change or delete the system's internal hard drive's password. Default setting: Not set
<b>Strong Password</b>	Allows you to enforce the option to always set strong passwords. Default Setting: Enable Strong Password is not selected.   <b>NOTE:</b> If Strong Password is enabled, Admin and System passwords must contain at least one uppercase character, one lowercase character and be at least 8 characters long.
<b>Password Configuration</b>	Allows you to determine the minimum and maximum length of Administrator and System passwords.
<b>Password Bypass</b>	Allows you to enable or disable the permission to bypass the System and the Internal HDD password, when they are set. The options are:

Option	Description
	<ul style="list-style-type: none"> <li>• Disabled</li> <li>• Reboot bypass</li> </ul>
	Default setting: Disabled
<b>Password Change</b>	<p>Allows you to enable the disable permission to the System and Hard Drive passwords when the admin password is set.</p> <p>Default setting: <b>Allow Non-Admin Password Changes</b> is selected.</p>
<b>UEFI Capsule Firmware Updates</b>	<p>Allows you to control whether the system allows BIOS updates through UEFI capsule update packages.</p> <p>Default setting: <b>Enable UEFI Capsule Firmware Updates</b> is selected.</p>
<b>PTT Security</b>	<p>Allows you to control whether the Platform Trust Technology (PTT) feature is visible to the operating system. The options are:</p> <ul style="list-style-type: none"> <li>• PTT On</li> <li>• Clear</li> </ul> <p>Default setting: <b>PTT On</b> is selected.</p>
	<p> <b>NOTE:</b> Disabling this option does not change any settings made to the PTT, delete, or change any information or keys stored in the PTT. Changes made to this setting take effect immediately.</p>
<b>Computrace</b>	<p>Allows you to activate or disable the optional Computrace software. The options are:</p> <ul style="list-style-type: none"> <li>• Deactivate</li> <li>• Disable</li> <li>• Activate</li> </ul> <p> <b>NOTE:</b> The Activate and Disable options will permanently activate or disable the feature and no further changes will be allowed</p> <p>Default setting: Deactivate</p>
<b>CPU XD Support</b>	<p>Allows you to enable the Execute Disable mode of the processor.</p> <p>Enable CPU XD Support (default)</p>
<b>Admin Setup Lockout</b>	<p>Allows you to prevent users from entering the setup when an Administrator password is set.</p> <p>Default Setting: <b>Enable Admin Setup Lockout</b> is not selected.</p>



## Secure Boot screen options

Option	Description
<b>Secure Boot Enable</b>	<p>This option enables or disables the <b>Secure Boot</b> feature.</p> <ul style="list-style-type: none"><li>• Disabled</li><li>• Enabled</li></ul> <p>Default setting: Enabled.</p>
<b>Expert Key Management</b>	<p>Allows you to manipulate the security key databases only if the system is in Custom Mode. The <b>Enable Custom Mode</b> option is disabled by default. The options are:</p> <ul style="list-style-type: none"><li>• PK</li><li>• KEK</li><li>• db</li><li>• dbx</li></ul> <p>If you enable the <b>Custom Mode</b>, the relevant options for <b>PK, KEK, db, and dbx</b> appear. The options are:</p> <ul style="list-style-type: none"><li>• <b>Save to File</b>—Saves the key to a user-selected file</li><li>• <b>Replace from File</b>—Replaces the current key with a key from a user-selected file</li><li>• <b>Append from File</b>—Adds a key to the current database from a user-selected file</li><li>• <b>Delete</b>—Deletes the selected key</li><li>• <b>Reset All Keys</b>—Resets to default setting</li><li>• <b>Delete All Keys</b>—Deletes all the keys</li></ul> <p> <b>NOTE:</b> If you disable the <b>Custom Mode</b>, all the changes made will be erased and the keys will restore to default settings.</p>

## Intel Software Guard Extensions screen options

Option	Description
<b>Intel SGX Enable</b>	<p>This field specifies you to provide a secured environment for running code/storing sensitive information in the context of the main OS. The options are:</p> <ul style="list-style-type: none"><li>• Disabled</li><li>• Enabled</li></ul> <p>Default setting: Disabled</p>
<b>Enclave Memory Size</b>	<p>This option sets <b>SGX Enclave Reserve Memory Size</b>. The options are:</p> <ul style="list-style-type: none"><li>• 32 MB</li><li>• 64 MB</li></ul>



Option	Description
	<ul style="list-style-type: none"> <li>• 128 MB</li> </ul>

## Performance screen options

Option	Description
<b>Multi Core Support</b>	<p>This field specifies whether the process has one or all cores enabled. The performance of some applications improves with the additional cores. This option is enabled by default. Allows you to enable or disable multi-core support for the processor. The installed processor supports twofour cores. If you enable Multi Core Support, twofour cores are enabled. If you disable Multi Core Support, one core is enabled.</p> <ul style="list-style-type: none"> <li>• Enable Multi Core Support</li> </ul> <p>Default setting: The option is enabled.</p>
<b>Intel SpeedStep</b>	<p>Allows you to enable or disable the Intel SpeedStep feature.</p> <ul style="list-style-type: none"> <li>• Enable Intel SpeedStep</li> </ul> <p>Default setting: The option is enabled.</p>
<b>C-States Control</b>	<p>Allows you to enable or disable the additional processor sleep states.</p> <ul style="list-style-type: none"> <li>• C states</li> </ul> <p>Default setting: The option is enabled.</p>
<b>Intel TurboBoost</b>	<p>Allows you to enable or disable the Intel TurboBoost mode of the processor.</p> <ul style="list-style-type: none"> <li>• Enable Intel TurboBoost</li> </ul> <p>Default setting: The option is enabled.</p>
<b>Hyper-Thread Control</b>	<p>Allows you to enable or disable the Hyper-Threading in the processor.</p> <ul style="list-style-type: none"> <li>• Disabled</li> <li>• Enabled</li> </ul> <p>Default setting: Enabled.</p>

## Power Management screen options

Option	Description
<b>Auto On Time</b>	<p>Allows you to set the time at which the computer must turn on automatically. The options are:</p>

Option	Description
	<ul style="list-style-type: none"> <li>• Disabled</li> <li>• Every Day</li> <li>• Weekdays</li> <li>• Select Days</li> </ul> <p>Default setting: Disabled</p>
<b>USB Wake Support</b>	<p>Allows you to enable USB devices to wake the system from Standby.</p> <p> <b>NOTE:</b> This feature is only functional when the AC power adapter is connected. If the AC power adapter is removed during Standby, the system setup removes power from all the USB ports to conserve battery power.</p> <ul style="list-style-type: none"> <li>• Enable USB Wake Support</li> </ul> <p>Default setting: The option is disabled.</p>
<b>Primary Battery Charge Configuration</b>	<p>Allows you to select the charging mode for the battery. The options are:</p> <ul style="list-style-type: none"> <li>• Adaptive</li> <li>• Standard — Fully charges your battery at a standard rate.</li> <li>• ExpressCharge — The battery charges over a shorter period of time using Dell's fast charging technology. This option is enabled by default.</li> <li>• Primarily AC use</li> <li>• Custom</li> </ul> <p>If Custom Charge is selected, you can also configure Custom Charge Start and Custom Charge Stop.</p> <p> <b>NOTE:</b> All charging mode may not be available for all the batteries. To enable this option, disable the <b>Advanced Battery Charge Configuration</b> option.</p>

## POST Behavior screen options

Option	Description
<b>Adapter Warnings</b>	<p>Allows you to enable or disable the system setup (BIOS) warning messages when you use certain power adapters.</p> <p>Default setting: Enable Adapter Warnings</p>
<b>Mouse/Touchpad</b>	<p>Allows you to define how the system handles mouse and touch pad input. The options are:</p> <ul style="list-style-type: none"> <li>• Serial Mouse</li> <li>• PS2 Mouse</li> <li>• Touchpad/PS-2 Mouse: This option is enabled by default.</li> </ul>

Option	Description
<b>Fn Lock Options</b>	<p>Allows you to let hot key combinations Fn + Esc toggle the primary behavior of F1–F12, between their standard and secondary functions. If you disable this option, you cannot toggle dynamically the primary behavior of these keys. The available options are:</p> <ul style="list-style-type: none"> <li>• Fn Lock. This option is selected by default.</li> <li>• Lock Mode Disable/Standard</li> <li>• Lock Mode Enable/Secondary</li> </ul>
<b>Fastboot</b>	<p>Allows you to speed up the boot process by bypassing some of the compatibility steps. The options are:</p> <ul style="list-style-type: none"> <li>• Minimal</li> <li>• Thorough (default)</li> <li>• Auto</li> </ul>

## Virtualization support screen options

Option	Description
<b>Virtualization</b>	<p>Allows you to enable or disable the Intel Virtualization Technology. Enable Intel Virtualization Technology (default).</p>
<b>VT for Direct I/O</b>	<p>Enables or disables the Virtual Machine Monitor (VMM) from utilizing the additional hardware capabilities provided by Intel® Virtualization technology for direct I/O. Enable VT for Direct I/O - enabled by default.</p>
<b>Trusted Execution</b>	<p>This option specifies whether a Measured Virtual Machine Monitor (MVMM) can utilize the additional hardware capabilities provided by Intel Trusted Execution Technology, the TPM Virtualization Technology, and Virtualization technology for direct I/O must be enabled to use this feature. Trusted Execution - disabled by default.</p>

## Wireless screen options

Option	Description
<b>Wireless Switch</b>	<p>Allows to set the wireless devices that can be controlled by the wireless switch. The options are:</p> <ul style="list-style-type: none"> <li>• WLAN</li> <li>• Bluetooth</li> </ul> <p>All the options are enabled by default.</p>

Option	Description
<b>Wireless Device Enable</b>	<p>Allows you to enable or disable the internal wireless devices.</p> <ul style="list-style-type: none"> <li>• WLAN</li> <li>• Bluetooth</li> </ul> <p>All the options are enabled by default.</p>

## Maintenance screen options

Option	Description
<b>Service Tag</b>	Displays the Service Tag of your computer.
<b>Asset Tag</b>	Allows you to create a system asset tag if an asset tag is not already set. This option is not set by default.
<b>BIOS Downgrade</b>	This controls flashing of the system firmware to previous revisions.
<b>Data Wipe</b>	<p>This field allows users to erase the data securely from all internal storage devices. The following is list of devices affected:</p> <ul style="list-style-type: none"> <li>• Internal HDD</li> <li>• Internal SDD</li> <li>• Internal mSATA</li> <li>• Internal eMMC</li> </ul>
<b>BIOS Recovery</b>	<p>This field allows you to recover from certain corrupted BIOS conditions from a recover file on the user primary hard drive or an external USB key.</p> <ul style="list-style-type: none"> <li>• BIOS Recovery from Hard Drive (enabled by default)</li> </ul>



## System Log screen options

Option	Description
<b>BIOS Events</b>	Allows you to view and clear the System Setup (BIOS) POST events.
<b>Thermal Events</b>	Allows you to view and clear the System Setup (Thermal) events.
<b>Power Events</b>	Allows you to view and clear the System Setup (Power) events.

## Updating the BIOS

It is recommended to update your BIOS (System Setup), on replacing the system board or if an update is available. For laptops, ensure that your computer battery is fully charged and connected to a power outlet

1. Restart the computer.
2. Go to [Dell.com/support](https://Dell.com/support).

3. Enter the **Service Tag** or **Express Service Code** and click **Submit**.
    -  **NOTE:** To locate the Service Tag, click **Where is my Service Tag?**
    -  **NOTE:** If you cannot find your Service Tag, click **Detect My Product**. Proceed with the instructions on screen.
  4. If you are unable to locate or find the Service Tag, click the Product Category of your computer.
  5. Choose the **Product Type** from the list.
  6. Select your computer model and the **Product Support** page of your computer appears.
  7. Click **Get drivers** and click **View All Drivers**.  
The Drivers and Downloads page opens.
  8. On the Drivers and Downloads screen, under the **Operating System** drop-down list, select **BIOS**.
  9. Identify the latest BIOS file and click **Download File**.  
You can also analyze which drivers need an update. To do this for your product, click **Analyze System for Updates** and follow the instructions on the screen.
  10. Select your preferred download method in the **Please select your download method below** window, click **Download File**.  
The **File Download** window appears.
  11. Click **Save** to save the file on your computer.
  12. Click **Run** to install the updated BIOS settings on your computer.  
Follow the instructions on the screen.
-  **NOTE:** It is recommended not to update the BIOS version for more than 3 revisions. For example: If you want to update the BIOS from 1.0 to 7.0, then install version 4.0 first and then install version 7.0.

## System and setup password

You can create a system password and a setup password to secure your computer.

Password type	Description
System password	Password that you must enter to log on to your system.
Setup password	Password that you must enter to access and make changes to the BIOS settings of your computer.

 **CAUTION:** The password features provide a basic level of security for the data on your computer.

 **CAUTION:** Anyone can access the data stored on your computer if it is not locked and left unattended.

 **NOTE:** Your computer is shipped with the system and setup password feature disabled.

### Assigning a system password and setup password

You can assign a new **System Password** and/or **Setup Password** or change an existing **System Password** and/or **Setup Password** only when **Password Status** is **Unlocked**. If the Password Status is **Locked**, you cannot change the System Password.

 **NOTE:** If the password jumper is disabled, the existing System Password and Setup Password are deleted and you need not provide the system password to log on to the computer.

To enter the system setup, press F2 immediately after a power-on or re-boot.

1. In the **System BIOS** or **System Setup** screen, select **System Security** and press Enter.  
The **System Security** screen appears.
2. In the **System Security** screen, verify that **Password Status** is **Unlocked**.
3. Select **System Password**, enter your system password, and press Enter or Tab.  
Use the following guidelines to assign the system password:
  - A password can have up to 32 characters.
  - The password can contain the numbers 0 through 9.
  - Only lower case letters are valid, upper case letters are not allowed.
  - Only the following special characters are allowed: space, ("), (+), (.), (-), (.), (/), (:), ((), (\), ()), (').Re-enter the system password when prompted.
4. Type the system password that you entered earlier and click **OK**.
5. Select **Setup Password**, type your system password and press Enter or Tab.  
A message prompts you to re-type the setup password.
6. Type the setup password that you entered earlier and click **OK**.
7. Press Esc and a message prompts you to save the changes.
8. Press Y to save the changes.  
The computer reboots.

## Deleting or changing an existing system and/or setup password

Ensure that the **Password Status** is Unlocked (in the System Setup) before attempting to delete or change the existing System and/or Setup password. You cannot delete or change an existing System or Setup password, if the **Password Status** is Locked.

To enter the System Setup, press F2 immediately after a power-on or reboot.

1. In the **System BIOS** or **System Setup** screen, select **System Security** and press Enter.  
The **System Security** screen is displayed.
2. In the **System Security** screen, verify that **Password Status** is **Unlocked**.
3. Select **System Password**, alter or delete the existing system password and press Enter or Tab.
4. Select **Setup Password**, alter or delete the existing setup password and press Enter or Tab.  
 **NOTE:** If you change the System and/or Setup password, re-enter the new password when prompted. If you delete the System and/or Setup password, confirm the deletion when prompted.
5. Press Esc and a message prompts you to save the changes.
6. Press Y to save the changes and exit from System Setup.  
The computer reboots.



# Diagnostics

If you experience a problem with your computer, run the ePSA diagnostics before contacting Dell for technical assistance. The purpose of running diagnostics is to test your computer's hardware without requiring additional equipment or risking data loss. If you are unable to fix the problem yourself, service and support personnel can use the diagnostics results to help you solve the problem.

## Enhanced Pre-Boot System Assessment (ePSA) diagnostics

The ePSA diagnostics (also known as system diagnostics) performs a complete check of your hardware. The ePSA is embedded with the BIOS and is launched by the BIOS internally. The embedded system diagnostics provides a set of options for particular devices or device groups allowing you to:

- Run tests automatically or in an interactive mode
- Repeat tests
- Display or save test results
- Run thorough tests to introduce additional test options to provide extra information about the failed device(s)
- View status messages that inform you if tests are completed successfully
- View error messages that inform you of problems encountered during testing

 **CAUTION:** Use the system diagnostics to test only your computer. Using this program with other computers may cause invalid results or error messages.

 **NOTE:** Some tests for specific devices require user interaction. Always ensure that you are present at the computer terminal when the diagnostic tests are performed.

## System diagnostic lights

**Power and battery-status light/ hard-drive activity light:** Indicates the battery-charge status or the hard-drive activity.

 **NOTE:** Press Fn+H to toggle this light between power and battery-status light and hard-drive activity light.

### Hard-drive activity light

Turns on when the computer reads from or writes to the hard drive.

### Power and battery-status light

Indicates the power and battery-charge status.

**Solid white** – Power adapter is connected and the battery has more than 5 percent charge.

**Amber** – Computer is running on battery and the battery has less than 5 percent charge.

**Off**

- Power adapter is connected and the battery is fully charged.
- Computer is running on battery and the battery has more than 5 percent charge.
- Computer is in sleep state, hibernation, or turned off.

The power and battery-status light blinks amber along with beep codes indicating failures.

For example, the power and battery-status light blinks amber two times followed by a pause, and then blinks white three times followed by a pause. This 2,3 pattern continues until the computer is turned off indicating no memory or RAM is detected.

The following table shows different light patterns, what they indicate, and the suggested solutions.

**Table 5. System light problems and possible solutions**

Light Pattern	Problem description	Suggested solution
2,1	CPU failure	Replace the system board.
2,2	System board: BIOS and ROM failure	Flash latest BIOS version. If problem persists, replace the system board.
2,3	No memory or RAM detected	Confirm that the memory module is installed properly. If problem persists, replace the memory module.
2,4	Memory or RAM failure	Replace the memory module.
2,5	Invalid memory installed	Replace the memory module.
2,6	System board or chipset error	Replace the system board.
2,7	LCD failure	Replace the LCD.
3,1	CMOS battery failure	Replace the CMOS battery.
3,2	PCI or video card or chip failure	Replace the CMOS battery.
3,3	Recovery image not found	Reimage the system.
3,4	Recovery image found but invalid	Reimage the system.

The computer may emit a series of beeps during start-up if the errors or problems cannot be displayed. The repetitive beep codes help the user troubleshoot problems with the computer.

**Camera status light:** Indicates whether the camera is in use.

- Solid white – Camera is in use.
- Off – Camera is not in use.

**Caps Lock status light:** Indicates whether Caps Lock is enabled or disabled.

- Solid white – Caps Lock enabled.
- Off – Caps Lock disabled.

## Technical specifications

 **NOTE:** Offerings may vary by region. For more information regarding the configuration of your computer in:

- Windows 10, click or tap **Start**  → **Settings** → **System** → **About**.

### System specifications

Feature	Specification
Chipset	Intel 6th Generation processors
DRAM bus width	64-bit
Flash EPROM	SPI 128 Mbits
PCIe bus	100 MHz
External Bus Frequency	PCIe Gen3 (8 GT/s)

### Processor specifications

Feature	Specification
Types	<ul style="list-style-type: none"> <li>• 6th Generation Intel Core i3/i5</li> <li>• Intel Celeron Dual Core</li> <li>• Intel Pentium Dual Core</li> </ul>
Chipset	Integrated on the system board

### Memory specifications

Feature	Specification
Memory connector	Two SODIMM slots
Memory capacity	4 GB and 8 GB
Memory type	DDR4

Feature	Specification
Speed	2133 MHz
Minimum memory	4 GB
Maximum memory	16 GB (2 * 8 GB)

## Audio specifications

Feature	Specification
Types	High-definition audio
Controller	Realtek ALC3253 with Waves MaxxAudio pro
Stereo conversion	Digital audio-out through HDMI – up to 7.1 compressed and uncompressed audio
Internal interface	High-definition audio codec
External interface	Stereo headset/mic combo
Speakers	Two
Internal speaker amplifier	2 W (RMS) per channel
Volume controls	Media control shortcut keys and volume control buttons

## Video specifications

Feature	Specification
Type	Integrated on system board, hardware accelerated
Controller	<ul style="list-style-type: none"> <li>Intel HD Graphics 510 – Intel Pentium</li> <li>Intel HD Graphics 520 – Intel Core i3/i5</li> </ul>
Data bus	Integrated video
External display support	<ul style="list-style-type: none"> <li>19-pin HDMI connector</li> <li>DisplayPort with USB Type-C</li> </ul>

## Camera specifications

Feature	Specification
Resolution (maximum)	<ul style="list-style-type: none"> <li>Image: 0.92 megapixel</li> <li>Video: 1280 X 720 (HD) at 30 fps</li> </ul>

Feature	Specification
Diagonal viewing angle	74°

## Communication specifications

Features	Specification
Wireless	<ul style="list-style-type: none"> <li>• Wi-Fi 802.11 ac</li> <li>• Bluetooth 4.0</li> <li>• Bluetooth 4.1 (optional)</li> <li>• Miracast</li> <li>• Wi-Fi display support (Wi-Fi Alliance)</li> </ul>

## Port and connector specifications

Feature	Specification
Audio	Stereo headset/mic combo
Video	<ul style="list-style-type: none"> <li>• 19-pin HDMI connector</li> <li>• DisplayPort with USB Type-C</li> </ul>
USB	<ul style="list-style-type: none"> <li>• One USB Type-C port</li> <li>• One USB 2.0 port</li> <li>• One USB 3.0 with PowerShare</li> </ul>
M.2 card	One M.2 slot for SSD card

## Display specifications

Feature	Specification
Type	FHD WLED touch
Height	165.38 mm (6.51 inches)
Width	293.77 mm (11.56 inches)
Diagonal	337.82 mm (13.30 inches)
Maximum resolution	1920 X 1080
Maximum brightness	220 nits

Feature	Specification
Refresh rate	60 Hz
Maximum viewing angles (horizontal)	80/80
Maximum viewing angles (vertical)	80/80
Pixel pitch	0.158 mm (0.006 inches)

## Keyboard specifications

Feature	Specification
Number of keys	<ul style="list-style-type: none"> <li>• United States: 80 keys</li> <li>• United Kingdom: 81 keys</li> <li>• Japan: 84 keys</li> </ul>

## Touchpad specifications

Feature	Specification
Resolution	<ul style="list-style-type: none"> <li>• Horizontal – 1228</li> <li>• Vertical – 748</li> </ul>

## Battery specifications

Feature	Specification
Type	3-cell "smart" lithium-ion (43 WHr)
Depth	184.15 mm (7.25 inches)
Height	5.90 mm (0.23 inch)
Width	97.15 mm (3.82 inches)
Weight	0.2 kg (0.44 lb)
Voltage	11.40 VDC
Life span	300 discharge per charge cycles
Temperature range	
Operating	0°C to 35°C (32°F to 95°F)
Non-operating	- 40°C to 65°C (- 40°F to 149°F)
Coin cell battery	CR-2032

## AC Adapter specifications

Feature	Specification
Type	45 W
Input voltage	100 V AC to 240 V AC
Input current (maximum)	1.5 A
Input frequency	50 Hz to 60 Hz
Output current	2.31 A
Rated output voltage	19.5 +/- 1.0 V DC
Temperature range (Operating)	0°C to 40°C (32°F to 104°F)
Temperature range (Non-Operating)	-40°C to 70°C (-40°F to 158°F)

## Physical specifications

Feature	Specification
Height	18.70 mm (0.70 inch)
Width	322.40 mm (12.69 inches)
Depth	224.00 mm (8.82 inches)
Weight	3.85 lb (1.75 kg)

## Environmental specifications

Temperature	Specifications
Operating	0 °C to 60 °C (32 °F to 140 °F)
Storage	-51 °C to 71 °C (-59 °F to 159 °F)
Relative humidity (maximum)	Specifications
Operating	10 % to 90 % (non condensing)
Storage	5 % to 95 % (non condensing)



<b>Altitude (maximum)</b>	<b>Specifications</b>
<b>Operating</b>	-15.2 m to 3048 m (-50 to 10,000 ft) 0° to 35°C
<b>Non-operating</b>	-15.24 m to 10,668 m (-50 ft to 35,000 ft)
<b>Airborne contaminant level</b>	G2 or lower as defined by ISA S71.04-1985

# Contacting Dell

 **NOTE:** If you do not have an active Internet connection, you can find contact information on your purchase invoice, packing slip, bill, or Dell product catalog.

Dell provides several online and telephone-based support and service options. Availability varies by country and product, and some services may not be available in your area. To contact Dell for sales, technical support, or customer service issues:

1. Go to **Dell.com/support**.
2. Select your support category.
3. Verify your country or region in the **Choose a Country/Region** drop-down list at the bottom of the page.
4. Select the appropriate service or support link based on your need.