

SALORA

**GEBRUIKSAANWIJZING
BEDIENUNGSANLEITUNG
OPERATING INSTRUCTIONS
MODE D'EMPLOI**



49UHS3500

**KLEURENTELEVISIE MET AFSTANDBEDIENING
FARBFERNSEHGERÄT MIT FERNBEDIENUNG
COLOUR TELEVISION WITH REMOTE CONTROL
TELEVISEUR COULEUR A TELECOMMANDE**

Contents

Safety Information	67
Markings on the Product.....	67
Environmental Information.....	68
Features	69
Accessories Included.....	69
Standby Notifications.....	69
TV Control & Operation	70
Inserting the Batteries into the Remote	70
Connect Power	70
Antenna Connection.....	70
Notification.....	71
Specification	71
Remote Control	72
Connections.....	73
Switching On/Off.....	74
First Time Installation.....	74
Media Playback via USB Input	74
Media Browser Menu.....	75
FollowMe TV (if available)	75
CEC and CEC RC Passthrough.....	75
E-Manual (if available).....	75
TV Menu Contents.....	76
General TV Operation	80
Using the Channel List	80
Configuring Parental Settings.....	80
Electronic Programme Guide (EPG)	80
Teletext Services	81
Software Upgrade.....	81
Troubleshooting & Tips.....	81
PC Input Typical Display Modes.....	82
AV and HDMI Signal Compatibility	82
Supported Video File Formats for USB Mode	83
Supported Picture File Formats for USB Mode	83
Supported Audio File Formats for USB Mode	84
Supported DVI Resolutions	85
Connectivity	86
Wired Connectivity.....	86
Wireless Connectivity	86
Connectivity Troubleshooting	88
Using Audio Video Sharing Network Service.....	88
Audio Video Sharing.....	88
Nero MediaHome Installation	89
Internet Portal.....	89
Internet Browser	90
HBBTV System.....	91
Smart Center	92

Safety Information

	CAUTION RISK OF ELECTRIC SHOCK DO NOT OPEN	
CAUTION: TO REDUCE THE RISK OF ELECTRIC SHOCK DO NOT REMOVE COVER (OR BACK). NO USER-SERVICEABLE PARTS INSIDE. REFER SERVICING TO QUALIFIED SERVICE PERSONNEL.		

In extreme weather (storms, lightning) and long inactivity periods (going on holiday) disconnect the TV set from the mains.

The mains plug is used to disconnect TV set from the mains and therefore it must remain readily operable. If the TV set is not disconnected electrically from the mains, the device will still draw power for all situations even if the TV is in standby mode or switched off.

Note: Follow the on screen instructions for operating the related features.



IMPORTANT - Please read these instructions fully before installing or operating

⚠ WARNING: Never let people (including children) with reduced physical, sensory or mental capabilities or lack of experience and / or knowledge use electrical devices unsupervised.

- Use this TV set at an altitude of less than 2000 meters above the sea level, in dry locations and in regions with moderate or tropical climates.
- The TV set is intended for household and similar general use but may also be used in public places.
- For ventilation purposes, leave at least 5cm of free space around the TV.
- The ventilation should not be impeded by covering or blocking the ventilation openings with items, such as newspapers, table-cloths, curtains, etc.
- The power cord plug should be easily accessible. **Do not** place the TV, furniture, etc. on the power cord. A damaged power cord/plug can cause fire or give you an electric shock. Handle the power cord by the plug, **do not** unplug the TV by pulling the power cord. Never touch the power cord/plug with wet hands as this could cause a short circuit or electric shock. Never make a knot in the power cord or tie it with other cords. When damaged it must be replaced, this should only be done by qualified personnel.
- Do not expose the TV to dripping or splashing of liquids and do not place objects filled with liquids, such as vases, cups, etc. on or over the TV (e.g., on shelves above the unit).
- Do not expose the TV to direct sunlight or do not place open flames such as lit candles on the top of or near the TV.

- Do not place any heat sources such as electric heaters, radiators, etc. near the TV set.
- Do not place the TV on the floor and inclined surfaces.
- To avoid danger of suffocation, keep plastic bags out of the reach of the babies, children and domestic animals.
- Carefully attach the stand to the TV. If the stand is provided with screws, tighten the screws firmly to prevent the TV from tilting. Do not over-tighten the screws and mount the stand rubbers properly.
- Do not dispose of the batteries in fire or with hazardous or flammable materials.

Warning: Batteries must not be exposed to excessive heat such as sunshine, fire or the like.

 Caution	Serious injury or death risk
 Risk of electric shock	Dangerous voltage risk
 Maintenance	Important maintenance component

Markings on the Product

The following symbols are used **on the product** as a marker for restrictions and precautions and safety instructions. Each explanation shall be considered where the product bears related marking only. Note such information for security reasons.

 **Class II Equipment:** This appliance is designed in such a way that it does not require a safety connection to electrical earth.

 **Class II Equipment With Functional Earthing:** This appliance is designed in such a way that it does not require a safety connection to electrical earth, the earth connection is used for functional purposes.

 **Protective Earth Connection:** The marked terminal is intended for connection of the protective earthing conductor associated with the supply wiring.

 **Hazardous Live Terminal:** The marked terminal(s) is/are hazardous live under normal operating conditions.

 **Caution, See Operating Instructions:** The marked area(s) contain(s) user replaceable coin or button cell batteries.



Class 1 Laser Product: This product contains Class 1 laser source that is safe under reasonably foreseeable conditions of operation.

WARNING

Do not ingest the battery, Chemical Burn Hazard

This product or the accessories supplied with the product may contain a coin/button cell battery. If the coin/button cell battery is swallowed, it can cause severe internal burns in just 2 hours and can lead to death.

Keep new and used batteries away from children.

If the battery compartment does not close securely, stop using the product and keep it away from children.

If you think batteries might have been swallowed or placed inside any part of the body, seek immediate medical attention.

WARNING

Never place a television set in unstable or inclined locations. A television set may fall, causing serious personal injury or death. Many injuries, particularly to children, can be avoided by taking simple precautions such as;

- Using cabinets or stands recommended by the manufacturer of the television set.
- Only using furniture that can safely support the television set.
- Ensuring the television set is not overhanging the edge of the supporting furniture.
- Not placing the television set on tall furniture (for example, cupboards or bookcases) without anchoring both the furniture and the television set to a suitable support.
- Not standing the television set on cloth or other materials placed between the television and supporting furniture.
- Educating children about the dangers of climbing on furniture to reach the television set or its controls. If your existing television set is being retained and relocated, the same considerations as above should be applied.

WALL MOUNTING WARNINGS

- Read the instructions before mounting your TV on the wall.
- The wall mount kit is optional. You can obtain from your local dealer, if not supplied with your TV.
- Do not install the TV on a ceiling or on an inclined wall.
- Use the specified wall mounting screws and other accessories.
- Tighten the wall mounting screws firmly to prevent the TV from fall. Do not over-tighten the screws.

WARNING

Apparatus connected to the protective earthing of the building installation through the MAINS connection or through other apparatus with a connection to protective earthing – and to a television distribution system using coaxial cable, may in some circumstances create a fire hazard. Connection to a television distribution system has therefore to be provided through a device providing electrical isolation below a certain frequency range (galvanic isolator, see EN 60728-11)

Environmental Information

This television is designed to be environment friendly. To reduce energy consumption, you can follow these steps:

If you set the **Energy Saving** to **Minimum**, **Medium**, **Maximum** or **Auto** the TV will reduce the energy consumption accordingly. If you like to set the **Backlight** to a fixed value set as **Custom** and adjust the **Backlight** (located under the **Energy Saving** setting) manually using Left or Right buttons on the remote. Set as **Off** to turn this setting off.

*Note: Available **Energy Saving** options may differ depending on the selected **Mode** in the **System>Picture** menu.*

The **Energy Saving** settings can be found in the **System>Picture** menu. Note that some picture settings will be unavailable to be changed.

If pressed Right button while **Auto** option is selected or Left button while **Custom** option is selected, “**Screen will be off in 15 seconds.**” message will be displayed on the screen. Select **Proceed** and press **OK** to turn the screen off immediately. If you don't press any button, the screen will be off in 15 seconds. Press any button on the remote or on the TV to turn the screen on again.

Note: **Screen Off** option is not available if the Mode is set to **Game**.

When the TV is not in use, please switch off or disconnect the TV from the mains plug. This will also reduce energy consumption.

Features

- TV supports Ultra HD (Ultra High Definition - also known as 4K) which provides resolution of 3840 x 2160 (4K:2K). It equals 4 times the resolution of Full HD TV by doubling the pixel count of the Full HD TV both horizontally and vertically. Ultra HD contents are supported from HDMI, USB inputs and over DVB-T2 and DVB-S2 broadcasts.
- Remote controlled colour TV
- Fully integrated digital terrestrial/cable TV (DVB-T2/C)
- HDMI inputs to connect other devices with HDMI sockets
- USB input
- OSD menu system
- Scart socket for external devices (such as DVD Players, PVR, video games, etc.)
- Stereo sound system
- Teletext
- Headphone connection
- Automatic programming system
- Manual tuning
- Automatic power down after up to eight hours.
- Sleep timer
- Child lock
- Automatic sound mute when no transmission.
- NTSC playback
- AVL (Automatic Volume Limiting)
- PLL (Frequency Search)
- PC input
- Game Mode (Optional)
- Picture off function
- Ethernet (LAN) for Internet connectivity and service
- 802.11 a/b/g/n WIFI Support via USB dongle (not supplied)



- Audio Video Sharing
- HbbTV

Accessories Included

- Remote Control
- Batteries: 2 x AAA
- Instruction Book

Standby Notifications

If the TV does not receive any input signal (e.g. from an aerial or HDMI source) for 5 minutes, it will go into standby. When you next switch-on, the following message will be displayed: **“TV switched to stand-by mode automatically because there was no signal for a long time.”** Press **OK** to continue.

If the TV is on and it isn't being operated for a while it will go into standby. When you next switch-on, the following message will be displayed. **“TV switched to stand-by mode automatically because no operation was made for a long time.”** Press **OK** to continue.

TV Control & Operation

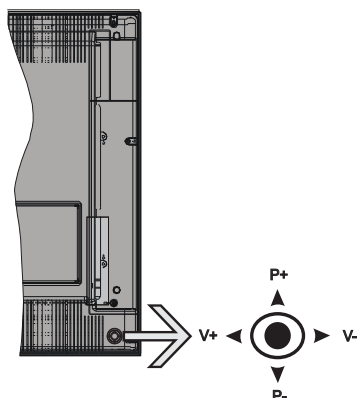

The joystick allows you to control the Volume / Programme / Source and Standby-On functions of the TV.

Note: The position of the joystick may differ depending on the model.

To change volume: Increase the volume by pushing the joystick right. Decrease the volume by pushing the joystick left.

To change channel: Scroll through the stored channels by pushing the joystick up or down.

To change source: Press the centre of the joystick in, the sources list will appear on the screen. Scroll through the available sources by pushing the joystick up or down.

To turn the TV off: Press the centre of the joystick in and hold it down for a few seconds, the TV will turn into standby mode.

To turn on the TV: Press the centre of the joystick in, the TV will turn on.

Note: Main menu OSD cannot be displayed via control button.

Operation with the Remote Control

Press the **Menu** button on your remote control to display main menu screen. Use the directional buttons to select a menu tab and press **OK** to enter. Use the directional buttons again to select or set an item. Press **Return/Back** or **Menu** button to quit a menu screen.

Input Selection

Once you have connected external systems to your TV, you can switch to different input sources. Press the **Source** button on your remote control consecutively to select the different sources.

Changing Channels and Volume

You can change the channel and adjust the volume by using the **Volume +/-** and **Programme +/-** buttons on the remote.

Inserting the Batteries into the Remote

Remove the back cover to reveal the battery compartment. Insert two size **AAA** batteries. Make sure the (+) and (-) signs match (observe correct polarity). Do not mix old and new batteries. Replace only with same or equivalent type. Place the cover back on.



Connect Power

IMPORTANT: The TV set is designed to operate on **220-240V AC, 50 Hz** socket. After unpacking, allow the TV set to reach the ambient room temperature before you connect the set to the mains. Plug the power cable to the mains socket outlet.

Antenna Connection

Connect the aerial or cable TV plug to the **AERIAL INPUT (ANT-TV)** socket located on the rear bottom side of the TV.

Rear bottom side of the TV

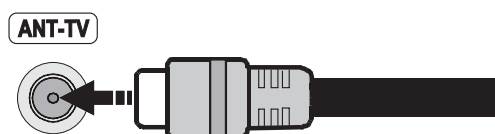

Notification

TRADEMARK ACKNOWLEDGMENT

The terms HDMI and High-Definition Multimedia Interface, and the HDMI Logo are trademarks or registered trademarks of HDMI Licensing LLC in the United States and other countries.



Manufactured under license from Dolby Laboratories. Dolby and the double-D symbol are trademarks of Dolby Laboratories.



YouTube and the YouTube logo are trademarks of Google Inc.

Information for Users on Disposal of Old Equipment and Batteries

[European Union only]

Equipment bearing these symbols should not be disposed as general household waste.

You should look for appropriate recycling facilities and systems for the disposal of these products.

Notice: The sign Pb below the symbol for batteries indicates that this battery contains lead.

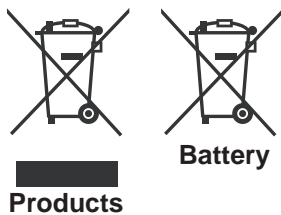

Specification

TV Broadcasting	PAL BG/I/DK/LL' SECAM BG/DK
Receiving Channels	VHF (BAND I/III) - UHF (BAND U) - HYPERBAND
Digital Reception	Fully integrated digital terrestrial-cable TV (DVB-T-C) (DVB-T2 compliant)
Number of Preset Channels	1.000
Channel Indicator	On Screen Display
RF Aerial Input	75 Ohm (unbalanced)
Operating Voltage	220-240V AC, 50Hz.
Audio	German+Nicam Stereo
Audio Output Power (WRMS.) (10% THD)	2 x 10W
Power Consumption (W)	135W
TV Dimensions DxLxH (with foot) (mm)	257 x 1112 x 709
TV Dimensions DxLxH (without foot) (mm)	59/91 x 1112 x 653
Display	49"
Operation temperature and operation humidity	0°C up to 40°C, 85% humidity max

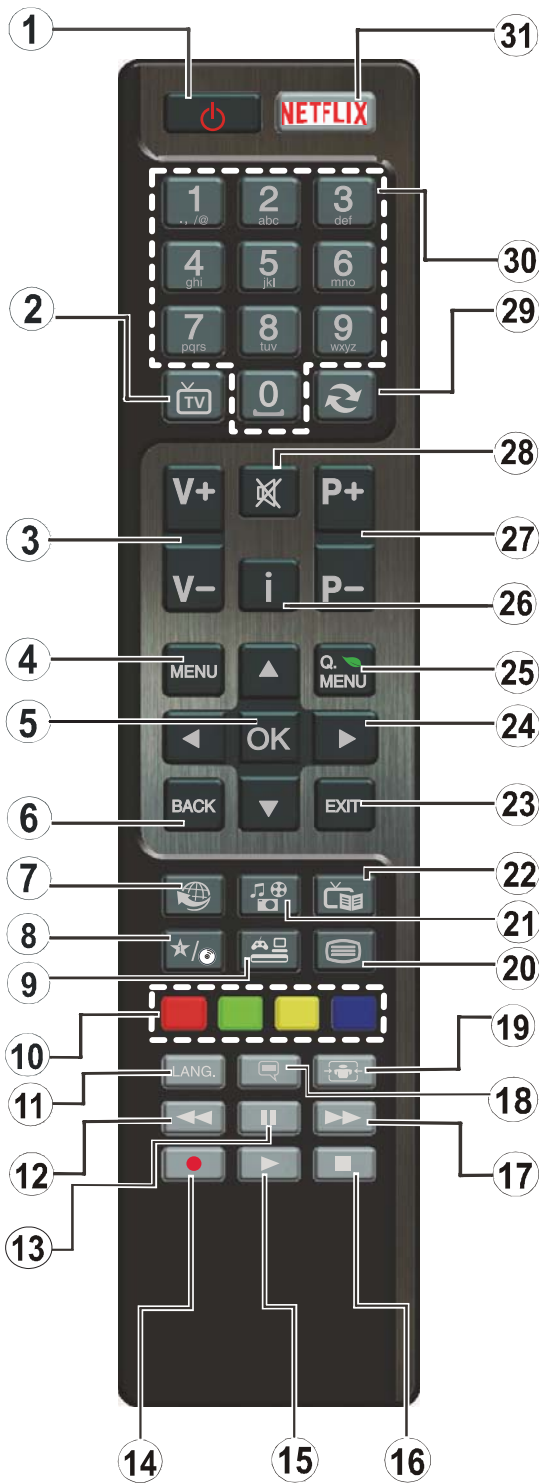

















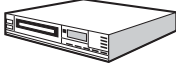



















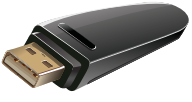
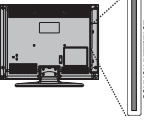

1. **Standby:** Switches On / Off the TV
2. **TV:** Displays channel list / Switches to TV Source
3. **Volume +/-**
4. **Menu:** Displays TV menu
5. **OK:** Confirms user selections, holds the page (in TXT mode), views channel list (DTV mode)
6. **Back/Return:** Returns to previous screen, opens index page (in TXT mode)
7. **Internet:** Opens the portal page, where you can reach many web based applications
8. **My button 1 (*)**
9. **Source:** Shows all available broadcast and content sources
10. **Coloured Buttons:** Follow the on-screen instructions for coloured button functions
11. **Language:** Switches among sound modes (analogue TV), displays and changes audio/subtitle language (digital TV, where available)
12. **Rapid reverse:** Moves frames backwards in media such as movies
13. **Pause:** Pauses the media being played
14. No function
15. **Play:** Starts to play selected media
16. **Stop:** Stops the media being played
17. **Rapid advance:** Moves frames forward in media such as movies
18. **Subtitles:** Turns subtitles on and off (where available)
19. **Screen:** Changes the aspect ratio of the screen
20. **Text:** Displays teletext (where available), press again to superimpose the teletext over a normal broadcast picture (mix)
21. **Media browser:** Opens the media browsing screen
22. **EPG (Electronic programme guide):** Displays the electronic programme guide
23. **Exit:** Closes and exits from displayed menus or returns to previous screen
24. **Directional buttons:** Helps navigate menus, content etc. and displays the subpages in TXT mode when pressed Right or Left
25. **Quick Menu:** Displays a list of menus for quick access
26. **Info:** Displays information about on-screen content, shows hidden information (reveal - in TXT mode)
27. **Programme +/-**
28. **Mute:** Completely turns off the volume of the TV
29. **Swap:** Quickly cycles between previous and current channels or sources
30. **Numeric buttons:** Switches the channel, enters a number or a letter in the text box on the screen.
31. **Netflix:** Launches the Netflix application, if this feature is supported by your TV

(*) MY BUTTON:

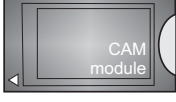
This button may have a default function depending on the model. However you can set a special function to this button by pressing on it for five seconds when on a desired source or channel. A confirmation message will be displayed on the screen. Now the MY BUTTON is associated with the selected function.

Note that if you perform **First Time Installation**, MY BUTTON will return to its default function.

Connections

Connector	Type	Cables	Device
	Scart Connection (back)		
YPBPR  Pr  Pb  Y / Video	YPbPr Video Connection (back)	 YPbPr Connection Cable	
	HDMI Connection (bottom&side)		
	VGA Connection (bottom)		
AUDIO IN  	PC/YPbPr/ Back AV Audio Connection (back)	 YPbPr/PC Audio Cable	
	SPDIF (Optical Out) Connection (bottom)		
BACK AV  Pr  R  Pb  L  Y / Video	Back AV (Audio/Video) Connection (back)	 Audio Video Cable	
HEADPHONE 	Headphone Connection (side)		
	USB Connection (back&side)		
	CI Connection (side)		
LAN 	Ethernet Connection (bottom)	 LAN / Ethernet Cable	
	Subwoofer Connection (back)		

NOTE: When connecting a device via the YPbPr or Back AV input, you must use the connection cables to enable connection. See the illustrations on the left side. | To enable PC/YPbPr audio, you will need to use the Back Audio inputs with a YPbPr/PC audio cable for audio connection. | If an external device is connected via the SCART socket, the TV will automatically switch to AV mode. | When receiving DTV channels (Mpeg4 H.264) or while in Media Browser mode, output will not be available via the scart socket. | When using the wall mounting kit (available from third party in the market, if not supplied), we recommend that you plug all your cables into the back of the TV before mounting on the wall. | Insert or remove the CI module only when the TV is SWITCHED OFF. You should refer to the module instruction manual for details of the settings. | The USB 2.0 inputs on the back side and on the left side of the TV support devices up to 500mA. Connecting devices that have current value above 500mA may damage your TV. If available, for the optional USB 3.0 input on the left side of the TV, which will be positioned above the other USB input, this limit value is 1A. | By connecting an HDMI cable to your TV, you have to use only a shielded (high grade) HDMI cable with ferrites to guarantee a sufficient immunity and emission against parasitic frequency radiation. And make sure to use a High-Speed HDMI cable that can transmit high definition signals, such as 4K contents, for trouble-free transmission.

 If you want to connect a device to the TV, make sure that both the TV and the device are turned off before making any connection. After the connection is done, you can turn on the units and use them.

Switching On/Off

To Switch the TV On

Connect the power cord to a power source such as a wall socket (220-240V AC, 50 Hz).

To switch on the TV from standby mode either:

- Press the **Standby** button, **Programme +/-** or a numeric button on the remote control.
- Press the centre of the joystick on the TV in or push it up/down until the TV comes on from standby.

To Switch the TV Off

Press the **Standby** button on the remote control or press the centre of the joystick on the TV in and hold it down for a few seconds, the TV will switch into standby mode.

To power down the TV completely, unplug the power cord from the mains socket.

Note: When the TV is switched into standby mode, the standby LED can blink to indicate that features such as Standby Search, Over Air Download or Timer is active. The LED can also blink when you switch on the TV from standby mode.

First Time Installation

When turned on for the first time, the language selection screen is displayed. Select the desired language and press **OK**.

On the next screen, set your preferences using the directional buttons.

*Note: Depending on the **Country** selection you may be asked to set and confirm a PIN at this point. The selected PIN cannot be 0000. You have to enter it if you are asked to enter a PIN for any menu operation later.*

About Selecting Broadcast Type

Digital Aerial: If **Digital Aerial** broadcast search option is turned on, the TV will search for digital terrestrial broadcasts after other initial settings are completed.

Digital Cable: If **Digital Cable** broadcast search option is turned on, the TV will search for digital cable broadcasts after other initial settings are completed. According to your other preferences a confirmation message may be displayed before starting to search. Select **YES** and press **OK** to proceed. To cancel operation, select **NO** and press **OK**. You can select **Network** or set values such as **Frequency**, **Network ID** and **Search Step**. When finished, press **OK** button.

*Note: Searching duration will change depending on the selected **Search Step**.*

Analogue: If **Analogue** broadcast search option is turned on, the TV will search for analogue broadcasts after other initial settings are completed.

Additionally you can set a broadcast type as your favourite one. Priority will be given to the selected broadcast type during the search process and the

channels of it will be listed on the top of the **Channel List**. When finished, press **OK** to continue.

You can activate **Store Mode** option at this point. This option will configure your TV's settings for store environment and depending on the TV model being used, the supported features of it may be displayed on the top of the screen as an info banner. This option is intended only for store use. It is recommended to select **Home Mode** for home use. This option will be available in **System>Settings>More** menu and can be turned off/on later.

Press **OK** button on the remote control to continue and the **Network/Internet Settings** menu will be displayed, if you confirm the previously displayed message asking whether you want to do the network settings. Please refer to **Connectivity** section to configure a wired or a wireless connection. After the settings are completed press **OK** button to continue. To skip to the next step without doing anything select **No** and press the **OK** button when the message is displayed asking whether you want to do the network settings.

After the initial settings are completed TV will start to search for available broadcasts of the selected broadcast types.

After all the available stations are stored, scan results will be displayed. Press **OK** to continue. The **Edit Channel List** menu will be displayed next. You can edit the channel list according to your preferences or press the **Menu** button to quit and watch TV.

While the search continues a message may appear, asking whether you want to sort channels according to the LCN(*). Select **Yes** and press **OK** to confirm.

(*LCN is the Logical Channel Number system that organizes available broadcasts in accordance with a recognizable channel number sequence (if available).

Note: Do not turn off the TV while initializing first time installation. Note that, some options may not be available depending on the country selection.

Media Playback via USB Input

You can connect 2.5" and 3.5" inch (hdd with external power supply) external hard disk drives or USB memory stick to your TV by using the USB inputs of the TV.

IMPORTANT! Back up the files on your storage devices before connecting them to the TV. Manufacturer will not be responsible for any file damage or data loss. Certain types of USB devices (e.g. MP3 Players) or USB hard disk drives/memory sticks may not be compatible with this TV. The TV supports FAT32 and NTFS disk formatting.

Wait a little while before each plugging and unplugging as the player may still be reading files. Failure to do so may cause physical damage to the USB player and the USB device itself. Do not pull out your drive while playing a file.





You can use USB hubs with your TV's USB inputs. External power supplied USB hubs are recommended in such a case.

It is recommended to use the TV's USB input(s) directly, if you are going to connect a USB hard disk.

Note: When viewing image files the **Media Browser** menu can only display 1000 image files stored on the connected USB device.

Media Browser Menu

You can play photo, music and movie files stored on a USB disk by connecting it to your TV. Connect a USB disk to one of the USB inputs located on the side of the TV. Pressing the **Menu** button while in the **Media Browser** mode will access the **Picture**, **Sound** and **Settings** menu options. Pressing the **Menu** button again will exit from this screen. You can set your **Media Browser** preferences by using the **Settings** menu.

Loop/Shuffle Mode Operation	
Start playback with the Play button and activate 	All files in the list will be continuously played in original order
Start playback with the OK button and activate 	The same file will be played continuously (repeat)
Start playback with the Play button and activate 	All files in the list will be played once in random order
Start playback with the Play button and activate  	All files in the list will be continuously played in the same random order.

FollowMe TV (if available)

With your mobile device you can stream the current broadcast from your smart TV using the **FollowMe TV** feature. Install the appropriate Smart Center application to your mobile device. Start the application. For further information on using this feature refer to the instructions of the application you use.

Note: This application may not be compatible with all mobile devices. Both of the devices must be connected to the same network.

CEC and CEC RC Passthrough

This function allows to control the CEC-enabled devices, that are connected through HDMI ports by using the remote control of the TV.

The **CEC** option in the **System>Settings>More** menu should be set as **Enabled** at first. Press the **Source** button and select the HDMI input of the connected CEC device from the **Sources List** menu. When new CEC source device is connected, it will be listed in source menu with its own name instead of the connected HDMI ports name (such as DVD Player, Recorder 1 etc.).

The TV remote is automatically able to perform the main functions after the connected HDMI source has been selected.

To terminate this operation and control the TV via the remote again, press **Quick Menu** button on the remote, highlight the **CEC RC Passthrough** and set as **Off** by pressing Left or Right button. This feature can also be enabled or disabled under the **System>Settings>More** menu.

The TV supports also ARC (Audio Return Channel) feature. This feature is an audio link meant to replace other cables between the TV and the audio system (A/V receiver or speaker system).

When ARC is active, TV does not mute its other audio outputs automatically. So you need to decrease TV volume to zero manually, if you want to hear audio from connected audio device only (same as other optical or co-axial digital audio outputs). If you want to change connected device's volume level, you should select that device from the source list. In that case volume control keys are directed to connected audio device.

Note: ARC is supported only via the HDMI3 input.

System Audio Control

Allows an Audio Amplifier/Receiver to be used with the TV. The volume can be controlled using the remote control of the TV. To activate this feature set the **Speakers** option in the **System>Settings>More** menu as **Amplifier**. The TV speakers will be muted and the sound of the watched source will be provided from the connected sound system.

Note: The audio device should support System Audio Control feature and **CEC** option should be set as **Enabled**.

E-Manual (if available)

You can find instructions for your TV's features in the E-Manual.

To use E-Manual, press to the **Info** button while main menu is displayed on the screen or press **Quick Menu** button, select **Information Booklet** and press **OK**.

By using the directional buttons select a desired category. Every category includes different topics. Select a topic and press **OK** to read instructions.

To close the E-Manual screen press the **Exit** or **Menu** button.

Note: The contents of the E-Manual may vary according to the model.

TV Menu Contents

System - Picture Menu Contents

Mode	You can change the picture mode to suit your preference or requirements. Picture mode can be set to one of these options: Cinema , Game (optional), Sports , Dynamic and Natural .
Contrast	Adjusts the light and dark values on the screen.
Brightness	Adjusts the brightness values on the screen.
Sharpness	Sets the sharpness value for the objects displayed on the screen.
Colour	Sets the colour value, adjusting the colours.
Energy Saving	For setting the Energy Saving to Custom , Minimum , Medium , Maximum , Auto , Screen Off or Off . <i>Note: Available options may differ depending on the selected Mode.</i>
Backlight	This setting controls the backlight level. The backlight function will be inactive if the Energy Saving is set to an option other than Custom .
Advanced Settings	
Dynamic Contrast	You can change the dynamic contrast ratio to desired value.
Noise Reduction	If the signal is weak and the picture is noisy, use the Noise Reduction setting to reduce the amount of noise.
Colour Temp	Sets the desired colour temperature value. Cool , Normal , Warm and Custom options are available.
White Point	If the Colour Temp option is set as Custom , this setting will be available. Increase the 'warmth' or 'coolness' of the picture by pressing Left or Right buttons.
Picture Zoom	Sets the desired image size format.
Film Mode	Films are recorded at a different number of frames per second to normal television programmes. Turn this feature on when you are watching films to see the fast motion scenes clearly.
Skin Tone	Skin tone can be changed between -5 and 5.
Colour Shift	Adjust the desired colour tone.
HDMI Full Range	While watching from a HDMI source, this feature will be visible. You can use this feature to enhance blackness in the picture.
PC Position	
Autoposition	Automatically optimizes the display. Press OK to optimize.
H Position	This item shifts the image horizontally to the right hand side or left hand side of the screen.
V Position	This item shifts the image vertically towards the top or bottom of the screen.
Dot Clock	Dot Clock adjustments correct the interference that appear as vertical banding in dot intensive presentations like spreadsheets or paragraphs or text in smaller fonts.
Phase	Depending on the input source(computer etc.) you may see a hazy or noisy picture on the screen. You can use phase to get a clearer picture by trial and error.
Reset	Resets the picture settings to factory default settings (except Game mode).
<i>While in VGA (PC) mode, some items in Picture menu will be unavailable. Instead, VGA mode settings will be added to the Picture Settings while in PC mode.</i>	

System - Sound Menu Contents	
Volume	Adjusts the volume level.
Equalizer	Selects the equalizer mode. Custom settings can be made only when in User mode.
Balance	Adjusts whether the sound comes from the left or right speaker.
Headphone	Sets headphone volume. Please ensure before using headphones that the headphone volume is set to a low level, to prevent damage to your hearing.
Sound Mode	You can select a sound mode (If the viewed channel supports).
AVL (Automatic Volume Limiting)	Sets the sound to obtain fixed output level between programmes.
Headphone/Lineout	When you connect an external amplifier to your TV using the headphone jack, you can select this option as Lineout . If you have connected headphones to the TV, set this option as Headphone . Please ensure before using headphones that this menu item is set to Headphone . If it is set to Lineout , the output from the headphone socket will be set to maximum which could damage your hearing.
Dynamic Bass	Enables or disables the Dynamic Bass.
Surround sound	Surround sound mode can be changed as On or Off .
Digital Out	Sets digital out audio type.

System - Settings Menu Contents	
Conditional Access	Controls conditional access modules when available.
Language	You may set a different language depending on the broadcaster and the country.
Parental	Enter correct password to change parental settings. You can easily adjust Menu Lock, Maturity Lock, Child Lock or Guidance in this menu. You can also set a new PIN or change the Default CICAM PIN using the related options. <i>Note: Some menu options may not be available depending on the country selection in the First Time Installation. Default PIN can be set to 0000 or 1234. If you have defined the PIN(is requested depending on the country selection) during the First Time Installation use the PIN that you have defined.</i>
Timers	Sets sleep timer to turn off the TV after a certain time. Sets timers for selected programmes.
Date/Time	Sets date and time.
Sources	Enables or disables selected source options. There are Regular, Enhanced and Disabled options available for HDMI sources. Regular and Enhanced options are affecting the colour settings of the selected HDMI source. To be able to watch 4K images from an HDMI source related source setting should be set as Enhanced if the connected device is HDMI 2.0 compatible. Set as Regular if the connected device is HDMI 1.4 compatible. Set accordingly or disable the related HDMI source by setting as Disabled .
Network/Internet Settings	Displays network/internet settings.
Accessibility	Displays accessibility options of the TV.
Hard of Hearing	Enables any special feature sent from the broadcaster.
Audio Description	A narration track will be played for the blind or visually impaired audience. Press OK to see all available Audio Description menu options. This feature is available only if the broadcaster supports it.
Netflix	If this feature is supported by your TV, you can view your ESN(*) number and deactivate Netflix. <i>(*) ESN number is an unique ID number for Netflix, created especially to identify your TV.</i>
More	Displays other setting options of the TV.
Menu Timeout	Changes timeout duration for menu screens.
HBBTV	You can enable or disable this feature by setting it as On or Off .
Software Upgrade	Ensures that your TV has the latest firmware. Press OK to see the menu options.
Application Version	Displays current software version.
Subtitle Mode	This option is used to select which subtitle mode will be on the screen (DVB subtitle / Teletext subtitle) if both is available. Default value is DVB subtitle. This feature is available only for the country option of Norway.
Auto TV OFF	Sets the desired time for the TV to automatically go into standby mode when not being operated.
Store Mode	Select this mode for store display purposes. Whilst Store Mode is enabled, some items in the TV menu may not be available.
Audio Video Sharing	Audio Video Sharing feature allows you to share files stored on your smartphone or tablet pc. If you have a compatible smartphone or tablet pc and the appropriate software is installed, you can share/play photos on your TV. See instructions of your sharing software for more information. Audio Video Sharing mode will not be available with internet portal feature.

Power Up Mode	This setting configures the power up mode preference. Last State and Standby options are available.
Virtual Remote	Enable or disable the virtual remote feature.
CEC	With this setting you can enable and disable CEC functionality completely. Press Left or Right button to enable or disable the feature.
CEC Auto Power On	This function allows the connected HDMI-CEC compatible device to turn on the TV and switch to its input source automatically. Press Left or Right button to enable or disable the feature.
Speakers	To hear the TV audio from the connected compatible audio device set as Amplifier . You can use the remote control of the TV to control the volume of the audio device.

Installation Menu Contents	
Automatic channel scan (Retune)	Displays automatic tuning options. Digital Aerial: Searches and stores aerial DVB stations. Digital Cable: Searches and stores cable DVB stations. Analogue: Searches and stores analogue stations.
Manual channel scan	This feature can be used for direct broadcast entry.
Network channel scan	Searches for the linked channels in the broadcast system. Digital Aerial: Searches for aerial network channels. Digital Cable: Searches for cable network channels.
Analogue fine tune	You can use this setting for fine tuning analogue channels. This feature is not available if no analogue channels are stored.
Installation Settings	Displays installation settings menu. Standby Search (Optional): Your TV will search for new or missing channels while in standby. Any new found broadcasts will be shown.
Clear Service List	Use this setting to clear channels stored. This setting is visible only when the Country option is set to Denmark, Sweden, Norway or Finland.
Select Active Network	This setting allows you to select only the broadcasts within the selected network to be listed in the channel list. This feature is available only for the country option of Norway.
First time installation	Deletes all stored channels and settings, resets TV to factory settings.

General TV Operation

Using the Channel List

The TV sorts all stored stations in the **Channel List**. You can edit this channel list, set favourites or set active stations to be listed by using the **Channel List** options. Press the **OK/TV** button to open the **Channel List**. You can filter the listed channels by pressing the **Blue** button or open the **Edit Channel List** menu by pressing the **Green** button in order to make advanced changes in the current list.

Managing the Favourite Lists

You can create four different lists of your favourite channels. Enter the **Channel List** in the main menu or press the **Green** button while the **Channel List** is displayed on the screen in order to open the **Edit Channel List** menu. Select the desired channel on the list. You can make multiple choices by pressing the **Yellow** button. Then press the **OK** button to open the **Channel Edit Options** menu and select **Add/Remove Favourites** option. Press the **OK** button again. Set the desired list option to **On**. The selected channel/s will be added to the list. In order to remove a channel or channels from a favourite list follow the same steps and set the desired list option to **Off**.

You can use the **Filter** function in the **Edit Channel List** menu to filter the channels in the **Channel list** permanently according to your preferences. Using this **Filter** option, you can set one of your four favourite lists to be displayed everytime the **Channel list** is opened. The filtering function in the **Channel list** menu will only filter the currently displayed **Channel list** in order to find a channel and tune in to it. This changes will not remain the next time the **Channel list** is opened.

Configuring Parental Settings

The **Parental Settings** menu options can be used to prohibit users from viewing of certain programmes, channels and using of menus. These settings are located in the **System>Settings>Parental** menu.

To display parental lock menu options, a PIN number should be entered. After coding the correct PIN number, **Parental Settings** menu will be displayed.

Menu Lock: This setting enables or disables access to all menus or installation menus of the TV.

Maturity Lock: If this option is set, TV gets the maturity information from the broadcast and if this maturity level is disabled, disables access to the broadcast.

*Note: If the country option in the **First Time Installation** is set as France, Italy or Austria, **Maturity Lock**'s value will be set to 18 as default.*

Child Lock: If this option is set to **ON**, the TV can only be controlled by the remote control. In this case the control buttons on the TV will not work.

Internet Lock: If this option is set to **ON**, the open browser application in the portal will be disabled. Set to **OFF** to release the application again.

Set PIN: Defines a new PIN number.

Default CICAM PIN: This option will appear as greyed out if no CI module is inserted into the CI slot of the TV. You can change the default PIN of the CI CAM using this option.

*Note: Default PIN can be set to 0000 or 1234. If you have defined the PIN(is requested depending on the country selection) during the **First Time Installation** use the PIN that you have defined.*

*Some options may not be available depending on the country selection in the **First Time Installation**.*

Electronic Programme Guide (EPG)

Some channels send information about their broadcast schedules. Press the **Epg** button to view the **Programme Guide** menu.

There are 3 different types of schedule layouts available, **Timeline Schedule**, **List Schedule** and **Now/Next Schedule**. To switch between them follow the instructions on the bottom of the screen.

Timeline Schedule

Zoom (Yellow button): Press the **Yellow** button to see events in a wider time interval.

Filter (Blue button): Views filtering options.

Select Genre (Subtitles button): Displays **Select Genre** menu. Using this feature, you can search the programme guide database in accordance with the genre. Info available in the programme guide will be searched and results matching your criteria will be highlighted.

Options (OK button): Displays event options.

Event Details (Info button): Displays detailed information about selected programmes.

Next/Prev Day (Programme +/- buttons): Displays the programmes of previous or next day.

Search (Text button): Displays **Guide Search** menu.

Now (Swap button): Displays current event of the highlighted channel.

List Schedule(*)

() In this layout option, only the events of the highlighted channel will be listed.*

Prev. Time Slice (Red button): Displays the programmes of previous time slice.

Next/Prev Day (Programme +/- buttons): Displays the programmes of previous or next day.

Event Details (Info button): Displays detailed information about selected programmes.

Filter (Text button): Views filtering options.

Next Time Slice (Green button): Displays the programmes of next time slice.

Options (OK button): Displays event options.

Now/Next Schedule

Navigate (Directional buttons): Press the **Directional buttons** to navigate through the channels and programmes.

Options (OK button): Displays event options.

Event Details (Info button): Displays detailed information about selected programmes.

Filter (Blue button): Views filtering options.

Programme Options

Use the directional buttons to highlight a programme and press **OK** button to display **Event Options** menu. The following options are available.

Select Channel: Using this option, you can switch to the selected channel.

Set Timer on Event / Delete Timer on Event: After you have selected a programme in the EPG menu, press the **OK** button. Select **Set Timer on Event** option and press the **OK** button. You can set a timer for future programmes. To cancel an already set timer, highlight that programme and press the **OK** button. Then select **Delete Timer on Event** option. The timer will be cancelled.

Notes: You cannot switch to any other channel while there is an active timer on the current channel.

It is not possible to set timer for two or more individual events at the same time interval.

Teletext Services

Press the **Text** button to enter. Press again to activate mix mode, which allows you to see the teletext page and the TV broadcast at the same time. Press once more to exit. If available, sections in the teletext pages will become colour-coded and can be selected by pressing the coloured buttons. Follow the instructions displayed on the screen.

Software Upgrade

Your TV is capable of finding and updating the firmware automatically via the broadcast signal or via Internet.

Software upgrade search via user interface

On the main menu select **System>Settings** and then **More**. Navigate to **Software upgrade** and press the **OK** button. In **Upgrade options** menu select **Scan for upgrade** and press **OK** button to check for a new software upgrade.

If a new upgrade is found, it starts to download the upgrade. After the download is completed confirm the question asking about rebooting the TV by pressing the **OK** to continue with the reboot operation.

3 AM search and upgrade mode

Your TV will search for new upgrades at 3:00 o'clock if **Automatic scanning** option in the **Upgrade options** menu is set to **Enabled** and if the TV is connected to an aerial signal or to Internet. If a new software is found and downloaded successfully, it will be installed at the next power on.

Note: Do not unplug the power cord while led is blinking during the reboot process. If the TV fails to come on after the upgrade, unplug, wait for two minutes then plug it back in.

Troubleshooting & Tips

Tv will not turn on

Make sure the power cord is plugged in securely to wall outlet. Check if batteries are exhausted. Press the Power button on the TV.

Poor picture

- Check if you have selected the correct TV system.
- Low signal level can cause picture distortion. Please check antenna access.
- Check if you have entered the correct channel frequency if you have done manual tuning.
- The picture quality may degrade when two devices are connected to the TV at the same time. In such a case, disconnect one of the devices.

No picture

- This means your TV is not receiving any transmission. Make sure the correct source has been selected.
- Is the antenna connected properly?
- Is the antenna cable damaged?
- Are suitable plugs used to connect the antenna?
- If you are in doubt, consult your dealer.

No sound

- Check if the TV is muted. Press the **Mute** button or increase the volume to check.
- Sound may be coming from only one speaker. Check the balance settings from **Sound** menu.

Remote control - no operation

- The batteries may be exhausted. Replace the batteries.

Input sources - can not be selected

- If you cannot select an input source, it is possible that no device is connected. If not;
- Check the AV cables and connections if you are trying to switch to the input source dedicated to the connected device.

PC Input Typical Display Modes

The following table is an illustration of some of the typical video display modes. Your TV may not support all resolutions.

Index	Resolution	Frequency
1	640x350	85Hz
2	640x480	60Hz
3	640x480	72Hz
4	640x480	75Hz
5	800x600	56Hz
6	800x600	60Hz
7	800x600	72Hz
8	800x600	75Hz
9	1024x768	60Hz
10	1024x768	70Hz
11	1024x768	75Hz
12	1024x768	85Hz
13	1152x864	75Hz
14	1280x768	60Hz
15	1280x768	75Hz
16	1280x960	60Hz
17	1280x960	75Hz
18	1280x1024	60Hz
19	1280x1024	75Hz
20	1360x768	60Hz
21	1366x768	60Hz
22	1400x1050	59Hz
23	1400x1050	60Hz
24	1400x1050	75Hz
25	1440x900	60Hz
26	1440x900	75Hz
27	1600x1200	60Hz
28	1680x1050	59Hz
29	1680x1050	60Hz
30	1920x1080	60Hz

AV and HDMI Signal Compatibility

Source	Supported Signals	Available	
EXT (SCART)	PAL	O	
	SECAM	O	
	NTSC4.43	O	
	NTSC3.58		
	RGB 50/60	O	
Back AV	PAL	O	
	SECAM	O	
	NTSC4.43	O	
	NTSC3.58	O	
YPbPr	480i, 480p	60Hz	O
	576i, 576p	50Hz	O
	720p	50Hz,60Hz	O
	1080i	50Hz,60Hz	O
HDMI	480i	60Hz	O
	480p	60Hz	O
	576i, 576p	50Hz	O
	720p	50Hz,60Hz	O
	1080i	50Hz,60Hz	O
	1080p	24Hz, 25Hz, 30Hz, 50Hz, 60Hz	O
	3840x2160p	24Hz, 25Hz, 30Hz, 50Hz, 60Hz	O
	4096x2160p	24Hz, 25Hz, 30Hz, 50Hz, 60Hz	O

(X: Not Available, O: Available)

In some cases a signal on the TV may not be displayed properly. The problem may be an inconsistency with standards from the source equipment (DVD, Set-top box, etc.). If you do experience such a problem please contact your dealer and also the manufacturer of the source equipment.

Supported Video File Formats for USB Mode

Video Codec	Resolution	Bit Rate	Container
MPEG1/2	1080Px2@30fps, 1080P@60fps	40Mbps	MPEG program stream (.DAT, .VOB, .MPG, .MPEG), MPEG transport stream (.ts, .trp, .tp), MP4 (.mp4, .mov), 3GPP (.3gpp, .3gp), AVI (.avi), MKV (.mkv), ASF (.asf)
MPEG4			MPEG program stream (.MPG, .MPEG), MP4 (.mp4, .mov), 3GPP (.3gpp, .3gp), AVI (.avi), MKV (.mkv), ASF (.asf)
XviD			MP4 (.mp4, .mov), AVI (.avi), MKV (.mkv), ASF (.asf)
Sorenson H.263			FLV (.flv), AVI (.avi), SWF(.swf)
H.263			MP4 (.mp4, .mov), 3GPP (.3gpp, .3gp), AVI (.avi), MKV (.mkv)
H.264	3840x2160@30fps, 1080P@60fps	135Mbps	FLV (.flv), MP4 (.mp4, .mov), 3GPP (.3gpp, .3gp), MPEG transport stream (.ts, .trp, .tp), ASF (.asf), AVI (.avi), MKV (.mkv)
Motion JPEG	720P@30fps	10Mbps	AVI (.avi), 3GPP (.3gpp, .3gp), MP4 (.mp4, .mov), MKV (.mkv), ASF (.asf)
VP8	1080P@30fps	20Mbps	MKV (.mkv), WebM (.webm)
HEVC	4K2K@60fps	160Mbps	MP4 (.mp4, .mov), MKV (.mkv), MPEG transport stream (.ts, .trp, .tp)
VP9	4K2K@30fps	100Mbps	MKV (.mkv), WebM (.webm)

Supported Picture File Formats for USB Mode

Image	Photo	Resolution (width x height)	Remark
JPEG	Base-line	15360x8640	The limit for max resolution depends on DRAM size
	Progressive	1024x768	
PNG	non-interlace	9600x6400	
	interlace	1200x800	
BMP		9600x6400	

Supported Audio File Formats for USB Mode

Audio Codec	Sample rate	Bit Rate	Container
MPEG1/2 Layer1	16KHz ~ 48KHz	32Kbps ~ 448Kbps	MP3 (.mp3), AVI (.avi), ASF (.asf), Matroska (.mkv, .mka), MPEG transport stream (.ts, .trp, .tp), MPEG program stream (.DAT, .VOB, .MPG, .MPEG), WAV (.wav)
MPEG1/2 Layer2	16KHz ~ 48KHz	8Kbps ~ 384Kbps	MP3 (.mp3), AVI (.avi), ASF (.asf), Matroska (.mkv, .mka), MPEG transport stream (.ts, .trp, .tp), MPEG program stream (.DAT, .VOB, .MPG, .MPEG), WAV (.wav)
MPEG1/2 Layer3	16KHz ~ 48KHz	8Kbps ~ 320Kbps	MP3 (.mp3), AVI (.avi), ASF (.asf), Matroska (.mkv, .mka), 3GPP (.3gpp, .3gp), MP4 (.mp4, .mov, m4a), MPEG transport stream (.ts, .trp, .tp), MPEG program stream (.DAT, .VOB, .MPG, .MPEG), FLV (.flv), WAV (.wav), SWF (.swf)
AC3	32KHz, 44.1KHz, 48KHz	32Kbps ~ 640Kbps	AC3 (.ac3), AVI (.avi), Matroska (.mkv, .mka), 3GPP (.3gpp, .3gp), MP4 (.mp4, .mov, m4a), MPEG transport stream (.ts, .trp, .tp), MPEG program stream (.DAT, .VOB, .MPG, .MPEG)
EAC3	32KHz, 44.1KHz, 48KHz	32Kbps ~ 6 Mbps	EAC3 (.ec3), 3GPP (.3gpp, .3gp), MP4 (.mp4, .mov, m4a), MPEG transport stream (.ts, .trp, .tp), MPEG program stream (.DAT, .VOB, .MPG, .MPEG)
AAC, HEAAC	8KHz ~ 48KHz		AAC (.aac), AVI (.avi), Matroska (.mkv, .mka), 3GPP (.3gpp, .3gp), MP4 (.mp4, .mov, m4a), MPEG transport stream (.ts, .trp, .tp), MPEG program stream (.DAT, .VOB, .MPG, .MPEG), FLV (.flv), RM (.ra)
WMA	8KHz ~ 48KHz	128bps ~ 320Kbps	ASF (.wma, .asf), AVI (.avi), Matroska (.mkv, .mka)
WMA 10 Pro M0	48KHz	< 192kbps	
WMA 10 Pro M1	48KHz	< 384kbps	
WMA 10 Pro M2	96KHz	< 768kbps	
G711 A/mu-law	8KHz	64Kbps ~ 128Kbps	WAV (.wav), AVI (.avi), Matroska (.mkv, .mka), 3GPP (.3gpp, .3gp), MP4 (.mp4, .mov, m4a)
LBR (cook)	8KHz, 11.025KHz, 22.05KHz, 44.1KHz	6Kbps ~ 128Kbps	RM (.ra)
FLAC	8KHz~96KHz	< 1.6Mbps	Matroska (.mkv, .mka)

Supported DVI Resolutions

When connecting devices to your TV's connectors by using DVI converter cable(DVI to HDMI cable - not supplied), you can refer to the following resolution information.

	56Hz	60Hz	66Hz	70Hz	72Hz	75Hz
640x480		<input checked="" type="checkbox"/>				<input checked="" type="checkbox"/>
800x600	<input checked="" type="checkbox"/>	<input checked="" type="checkbox"/>				<input checked="" type="checkbox"/>
1024x768		<input checked="" type="checkbox"/>		<input checked="" type="checkbox"/>		<input checked="" type="checkbox"/>
1280x768		<input checked="" type="checkbox"/>				<input checked="" type="checkbox"/>
1280x960		<input checked="" type="checkbox"/>				
1360x768		<input checked="" type="checkbox"/>				
1366x768		<input checked="" type="checkbox"/>				
1280x1024		<input checked="" type="checkbox"/>		<input checked="" type="checkbox"/>		<input checked="" type="checkbox"/>
1400x1050		<input checked="" type="checkbox"/>				
1600x900		<input checked="" type="checkbox"/>				

Connectivity

Wired Connectivity

To Connect to a Wired Network

- You must have a modem/router connected to an active broadband connection.
- Ensure that Nero Media Home software is installed to your PC (for Audio Video Sharing function). See “**Nero Media Home Installation**” section.
- Connect your PC to your modem/router. This can be a wired or wireless connection.
- Connect your TV to your modem/router via an ethernet cable. There is a LAN port at the rear (back) of your TV.

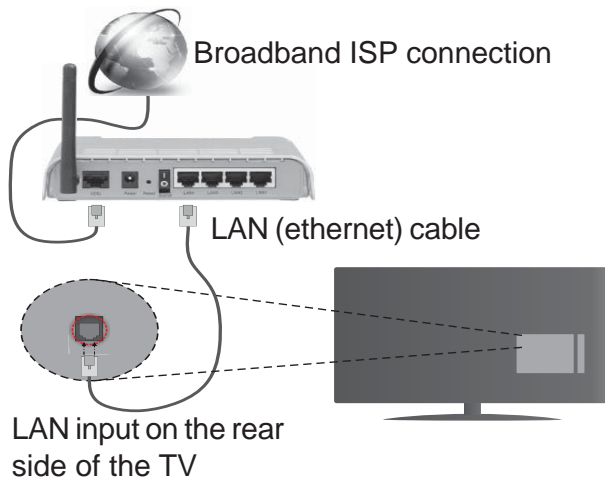

- To access and play shared files, you must select the **Media Browser**. Press the **Menu** button and select **Media Browser**. Press **OK** to continue. Select the desired file type and press **OK**. You must always use the **Media Browser** screen to access and play shared network files.
- PC/HDD/Media Player or any other devices that are compatible should be used with a wired connection for higher playback quality.

To configure wired settings please refer to the Network/Internet Settings section in the System>Settings Menu.

- You might be able to connect your TV to your LAN depending on your network's configuration. In such a case, use an ethernet cable to connect your TV directly to the network wall outlet.

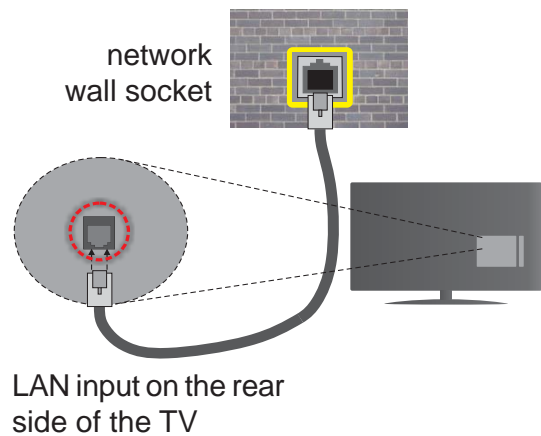

Configuring Wired Device Settings

Network Type

The **Network Type** can be selected as **Wired Device**, **Wireless Device** or **Disabled**, in accordance with the active connection to the TV set. Select this as **Wired Device** if you are connecting via an ethernet.

Internet Speed Test

Highlight **Internet Speed Test** and press the **OK** button. TV will check the internet connection bandwidth and display the result when complete.

Advanced Settings

Highlight **Advanced Settings** and press the **OK** button. On the next screen you can change the IP and DNS settings of the TV. Highlight the desired one and press Left or Right button to change the setting from **Automatic** to **Manual**. Now you can enter the **Manual IP** and / or **Manual DNS** values. Select the related item in the drop down menu and enter the new values using the numeric buttons of the remote. Press the **OK** button to save settings when complete.

Wireless Connectivity

To Connect to a Wireless Network

IMPORTANT: “Veezy 200” USB dongle is required to use wireless network features.

The TV cannot connect to the networks with a hidden SSID. To make your modem's SSID visible, you should change your SSID settings via the modem's software.

To Connect to a wireless LAN, you should perform the following steps:

1. Ensure that Nero Media Home software is installed to your PC (for Audio Video Sharing function).
2. Then connect the wireless adaptor to one of the USB inputs of the TV.
3. To configure your wireless settings please refer to the **Network/Internet Settings** section in the **System>Settings Menu**.

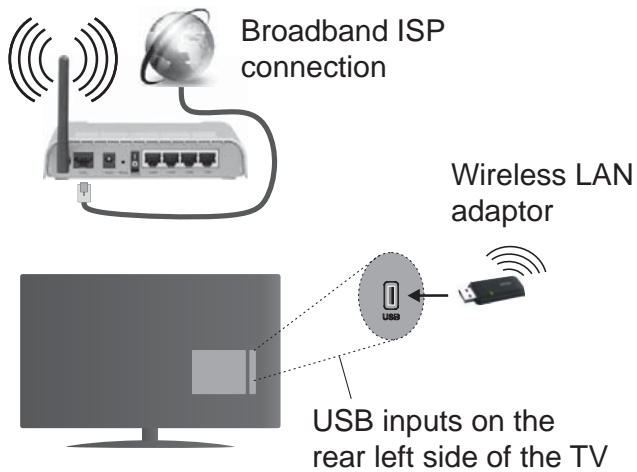

A Wireless-N router (IEEE 802.11a/b/g/n) with simultaneous 2.4 and 5 GHz bands is designed to increase bandwidth. These are optimized for smoother and faster HD video streaming, file transfers and wireless gaming.

- Use a LAN connection for quicker file sharing between other devices like computers.
- The frequency and channel differ depending on the area.
- The transmission speed differs depending on the distance and number of obstructions between the transmission products, the configuration of these products, the radio wave conditions, the line traffic and the products that you use. The transmission may also be cut off or may get disconnected depending on the radio wave conditions, DECT phones or any other WiFi 11b appliances. The standard values of the transmission speed are the theoretical maximum values for the wireless standards. They are not the actual speeds of data transmission.
- The location where the transmission is most effective differs depending on the usage environment.
- The Wireless LAN adaptor should be connected directly to the TV's USB port. USB hubs are not supported. You can plug your wifi dongle into a extension dock in cases where network quality is poor and the wifi dongle needs to be placed to a location with better signal quality.
- The Wireless LAN adaptor supports 802.11 a,b,g & n type modems. It is highly recommended that you should use the IEEE 802.11n communication protocol in order to avoid any possible problems while watching videos.
- Use the other USB input, if you experience problems with audio/video performance.
- You must change your modem's SSID when there are any other modems around with the same SSID. You can encounter connection problems otherwise. Use a wired connection if you experience problems with a wireless connection.

Configuring Wireless Device Settings

To enable Wi-Fi features, plug in the Wi-Fi dongle to one of the USB ports. Open the **Network/Internet Settings** menu and select **Network Type** as **Wireless Device** to start connection process.

The TV will scan the wireless networks automatically. A list of available networks will be displayed. Please select your desired network from the list.

Note: If the modem supports N mode, you should set N mode settings.

If the selected network is protected with a password, please enter the correct key by using the virtual keyboard. You can use this keyboard via the directional buttons and the **OK** button on the remote control.

Wait until the IP address is shown on the screen.

This means that the connection is now established. To disconnect from a wireless network, highlight **Network Type** and press Left or Right buttons to set as **Disabled**.

Highlight **Internet Speed Test** and press the **OK** button to check your internet connection speed. Highlight **Advanced Settings** and press the **OK** button to open the advanced setting menu. Use directional and numeric buttons to set. Press the **OK** button to save settings when complete.

Other Information

The status of the connection will be displayed as **Connected** or **Not Connected** and the current IP address, if a connection is established.

Connecting to your mobile device via WiFi

- If your mobile device has WiFi feature, you can connect it to your TV via a router, in order to access the content in your device. For this, your mobile device must have an appropriate sharing software.
- Connect to your router following the steps stated above in the **Wireless Connectivity** section.
- Afterwards, engage your mobile device with the router and then activate the sharing software on your mobile device. Then, select files that you want to share with your TV.
- If the connection is established correctly, you will be able to access the shared files from your mobile device via the **Media Browser** of your TV.
- Enter the **Media Browser** menu and the playback device selection OSD will be displayed. Select your mobile device and press the **OK** button to continue.
- If available, you can download a virtual remote controller application from the server of your mobile device application provider.

 **Note:** This feature may not be supported on all mobile devices.

Connectivity Troubleshooting

Wireless Network Not Available

- Ensure that any firewalls of your network allow the TV wireless connection.
- Ensure the “Veezy 200” USB WiFi dongle is plugged in fully.
- Try searching for wireless networks again, using the **Network/Internet Settings** menu screen.

If the wireless network does not function properly, try using the wired network in your home. Refer to the **Wired Connectivity** section for more information on the process.

If the TV does not function using the wired connection, check the modem (router). If the router does not have a problem, check the internet connection of your modem.

Connection is Slow

See the instruction book of your wireless modem to get information on the internal service area, connection speed, signal quality and other settings. You need to have a high speed connection for your modem.

Distruption during playback or slow reactions

You could try the following in such a case:

Keep at least three meters distance from microwave ovens, mobile telephones, bluetooth devices or any other Wi-Fi compatible devices. Try changing the active channel on the WLAN router.

Internet Connection Not Available / Audio Video Sharing Not Working

If the MAC address (a unique identifier number) of your PC or modem has been permanently registered, it is possible that your TV might not connect to the internet. In such a case, the MAC address is authenticated each time when you connect to the internet. This is a precaution against unauthorized access. Since your TV has its own MAC address, your internet service provider cannot validate the MAC address of your TV. For this reason, your TV cannot connect to the internet. Contact your internet service provider and request information on how to connect a different device, such as your TV, to the internet.

It is also possible that the connection may not be available due to a firewall problem. If you think this causes your problem, contact your internet service provider. A firewall might be the reason of a connectivity and discovery problem while using the TV in Audio Video Sharing mode or while browsing via Audio Video Sharing feature.

Invalid Domain

Ensure that you have already logged on to your PC with an authorized username/password and also ensure that your domain is active, prior to sharing any files in your media server program on your PC. If the domain is invalid, this might cause problems while browsing files in Audio Video Sharing mode.

Using Audio Video Sharing Network Service

Audio Video Sharing feature uses a standard that eases the viewing process of digital electronics and makes them more convenient to use on a home network.

This standard allows you to view and play photos, music and videos stored in the media server connected to your home network.

1. Nero Media Home Installation

The Audio Video Sharing feature cannot be used if the server programme is not installed onto your PC or if the required media server software is not installed onto the companion device. Please prepare your PC with the Nero Media Home programme. For more information about the installation, please refer to the “**Nero Media Home Installation**” section.

2. Connect to a Wired or Wireless Network

See the **Wired/Wireless Connectivity** chapters for detailed configuration information.

3. Play Shared Files via Media Browser

Select **Media Browser** by using the **directional** buttons from the main menu and press **OK**. The media browser will then be displayed.

Audio Video Sharing

Audio Video Sharing support is only available in the **Media Browser Folder** mode. To enable folder mode, go to the **Settings** tab in the main media browser screen and press **OK**. Highlight **View Style** and set to **Folder** using the **Left** or **Right** buttons. Select the desired media type and press **OK**.

If sharing configurations are set properly, **Device Selection** screen will be displayed after selecting the desired media type. If available networks are found, they will be listed on this screen. Select media server or network that you want to connect to using the Up or Down buttons and press **OK**. If you want to refresh the device list, press the **Green** button. You can press **Menu** to exit.

If you select the media type as **Videos** and choose a device from the selection menu. Then select the folder with video files in it on the next screen and all the available video files will be listed.

To play other media types from this screen, you can go back to main **Media Browser** screen and select the media type as desired and then perform the network selection again. Or press the **Blue** button to switch to next media type quickly without changing the network.

Refer to the **Media Browser** menu section for further information on file playback.

Subtitle files do not work if you watch videos from your network through Audio Video Sharing feature.

You can connect only one television to the same network. If a problem occurs with the network, please switch your television off at the wall socket and back on again. Trick mode and jump are not supported with the Audio Video Sharing feature.

Note: *There may be some PC's which may not be able to utilize the Audio Video Sharing feature due to administrator and security settings (such as business PC's).*

For best home network streaming with this TV, the Nero software should be installed.

Nero MediaHome Installation

To install Nero MediaHome, please proceed as follows:

Note: *The Audio Video Sharing feature cannot be used if the server programme is not installed onto your PC or if the required media server software is not installed onto the companion device.*

1. Enter the link below completely in the address-bar of your web browser.
<http://www.nero.com/mediahome-tv>
2. Click the **Download** button on the opening page. The installation file will be downloaded onto your PC.
3. After the download is completed, double click on the installation file to start the installation. The installation wizard will guide you through the installation process.
4. The prerequisites screen will be displayed first. The installation wizard checks the availability of required third-party software on your PC. If applications are missing they are listed and must be installed before continuing installation.
5. Click the **Install** button. The integrated serial will be displayed. Please do not change the displayed serial.
6. Click the **Next** button. The License Conditions (EULA) screen will be displayed. Please read the license agreement carefully and select the appropriate check box if you agree to the terms of the agreement. Installation is not possible without this agreement.
7. Click the **Next** button. On the next screen you can set your installation preferences.
8. Click the **Install** button. The installation begins and finishes automatically. A progress bar will indicate the state of the installation process.
9. Click the **Finish** button. The installation is completed. You will be directed to the web site of the nero software.

10. A shortcut is now placed on your desktop.

Congratulations! You successfully installed Nero MediaHome on your PC.

Run Nero MediaHome by double clicking on the shortcut icon.

Internet Portal

HINT: A broadband internet connection is required for high quality viewing. You must set the country option accordingly in the **First Time Installation** for proper operation of the internet portal.

Portal feature adds your TV a feature that allows you to connect a server on the Internet and view the content provided by this server over your Internet connection. Portal feature allows you to view the music, video, clip or web content with defined short-cuts. Whether you can view this content without interruption depends on the connection speed provided by your internet service provider.

Press the **Internet** button on your remote control to open internet portal page. You will see icons of the available applications and services on the portal screen. Use the directional buttons on your remote to select the desired one. You may view the desired content by pressing **OK** after selecting. Press **Back/Return** button to return back to the previous screen.

Moreover, you can access some features using the short-cut feature defined for the coloured or numeric buttons of your remote.

Press the **Exit** button to quit the Internet portal mode.

PIP Window (depending on portal service)

Current source content will be displayed in the PIP window, if you switch to portal mode while on any active source.

If you switch to portal mode while watching TV channels, current programme will be displayed in the PIP window. You can change channels using **Programme +/-** buttons.

Notes:

Possible application dependent problems may be caused by the content service provider.

Portal service content and the interface may be changed at any time without prior notice.

Third party internet services may change, be discontinued or restricted at any time.



Internet Browser

To use the internet browser, enter the portal first. Then launch the **Internet** application on the portal.

(*) *The appearance of the internet browser logo may change*

In the initial screen of the browser, the thumbnails of the predefined (if any) links to web sites available will be displayed as **Speed Dial** options along with the **Edit Speed Dial** and the **Add to Speed Dial** options.

To navigate the web browser, use the directional buttons on the remote or a connected mouse. To see the browser options bar, move the cursor to the top of the page or press the **Back/Return** button. **History**, **Tabs** and **Bookmarks** options and the browser bar which contains previous/next buttons, the refresh button, the address/search bar, the **Speed Dial** and the **Opera** buttons are available.

To add a desired website to the **Speed Dial** list for quick access, move the cursor to the top of the page or press the **Back/Return** button. The browser bar will appear. Highlight the **Speed Dial** -  button and press the **OK** button. Then select **Add to Speed Dial** option and press the **OK** button. Fill in the blanks for **Name** and **Address**, highlight **OK** and press the **OK** button to add. Whilst you are on the site you wish to add to the **Speed Dial** list, highlight the **Opera** -  button and press the **OK** button. Then highlight **Add to Speed Dial** option in the submenu and press the **OK** button again. **Name** and **Address** will be filled automatically according to the site you are visiting. Highlight **OK** and press the **OK** button to add.

You can also use the **Opera** menu options to manage the browser. Highlight the **Opera** -  button and press the **OK** button to see available page specific and general options.

There are various ways to search or visit websites using the web browser.

Enter the address of a website(URL) into the search/address bar and highlight the **Submit** button on the virtual keyboard and press the **OK** button to visit the site.

Enter keyword/s into the search/address bar and highlight the **Submit** button on the virtual keyboard and press the **OK** button to start a search for the related websites.

Highlight a Speed Dial thumbnail and press the **OK** button to visit the related website.

Your TV is compatible with USB mice. Plug your mouse or wireless mouse adaptor into the USB input of your TV for easier and quicker navigation.

Some web pages include flash content. These are not supported by the browser.

Your TV does not support any download processes from the internet via the browser.

All sites on the internet might not be supported. According to the site; content problems may occur. In some circumstances video contents might not be able to be played.

HBBTV System

HbbTV (Hybrid Broadcast Broadband TV) is a new industry standard that seamlessly combines TV services delivered via broadcast with services delivered via broadband and also enables access to Internet only services for consumers using connected TVs and set-top boxes. Services delivered through HbbTV include traditional broadcast TV channels, catch-up services, video-on-demand, EPG, interactive advertising, personalisation, voting, games, social networking and other multimedia applications.

HbbTV applications are available on channels where they are signalled by the broadcaster (currently various channels on Astra broadcast HbbTV applications). The broadcaster marks one application as “autostart” and this one is started by the platform automatically. The autostart applications are generally launched with a small red button icon to notify the user that there is an HbbTV application on that channel. Press the red button to open the application page. After the page is displayed you can go back to the initial red button icon state by pressing the red button again. You can toggle between the red button icon mode and full UI mode of the application via pressing red button. It should be noted that the red button switching capability is provided by the application and some application may behave differently.

If you switch to another channel while an HbbTV application is active (either in red button icon mode or full UI mode), the following scenarios can occur.

- The application can continue running.
- The application can be terminated.
- The application can be terminated and another autostart red button application can be launched.

HbbTV allows the applications to be retrieved both from broadband or broadcast. The broadcaster may enable both ways or one of them. If the platform does not have an operational broadband connection, the platform can still launch applications transmitted on broadcast.

The autostart red button applications generally provide links to other applications. An example of this is shown below. The user then can switch to other applications by using the links provided. The applications should provide a way to terminate themselves, usually **Exit** button is used for this.



Figure a: Start bar application



Figure b: EPG application, broadcast video is shown on the left bottom, can be terminated by pressing 0.

HbbTV applications use keys on the remote control to interact with the user. When an HbbTV application is launched, the control of some keys are owned by the application. For example, numeric channel selection may not work on a teletext application where the numbers indicate teletext pages.

HbbTV requires AV streaming capability for the platform. There are numerous applications providing VOD (video on demand) and catch-up TV services. The user can use play, pause, stop, forward, and rewind keys on the remote control to interact with the AV content.

Note: You can enable or disable this feature from the **More** menu in **System>Settings** menu.

Smart Center

Smart Center is a mobile application running on iOS and Android platforms. With your tablet or phone, you can easily stream your favourite live shows and programmes from your smart TV. Also; you can launch your portal applications, use your tablet as a remote control for your TV and share media files.

Note: *Being able to use all functions of this application depends on the features of your TV.*

Getting Started

To use Smart Center features, connections have to be done properly. To get connected to your network wirelessly, plug in the Wi-Fi dongle to one of the USB ports if your TV doesn't have internal wifi feature. To be able to use internet based features, your modem/router must be connected to the internet.

IMPORTANT: *Make sure the TV and mobile device are connected to the same network.*

For media sharing feature **Audio Video Sharing** option should be enabled(if available). Press the **Menu** button on the remote, select **System>Settings>More** menu and press **OK**. Highlight **Audio Video Sharing** and change as **Enabled**. Your TV is ready to connect to your mobile device now.

Install the **Smart Center** application onto your mobile device.

Start the smart center application. If all connections are configured properly, you will see your TV's name on your mobile device. If your TV's name doesn't appear on the list, wait a while and tap on the **Refresh** widget. Select your TV from the list.

Mobile Device screen

On the main screen you can find tabs to access various features.

The application retrieves actual channel list from TV first when it starts.

MY CHANNELS: The programmes of first four channels from the channel list retrieved from the TV are shown. You can change the listed channels. Press on the channel thumbnail and hold. A list of channels will be displayed and you can choose your desired channel to be replaced.

TV: You can watch content through the TV tab. In this mode you can navigate through the channel list retrieved from your TV and click on thumbnails to view the detail pages.

RECORDINGS: You can view your active recordings(if available) and reminders through this tab. To delete any item, simply press on the delete icon found on each row.

EPG: You can view the broadcast schedules of selected channel lists through this tab. You can also navigate through channels by pressing on the selected channel on the EPG grid. Please note that updating

/ refreshing the EPG information may take a while depending on your network and web service quality.

Note: *Internet connection is required for WEB based EPG informations.*

PORTAL: This tab displays the Portal applications in scrollable view. Unless **FollowMeTV** (if available) is active, the selected application will be displayed on your TV screen.

Note: *Internet connection is required. This tab is enabled if a portal page is in use.*

SETTINGS: Configure the application to your liking. You can change;

Auto-lock (Only in IOS): The screen of the device automatically turns off after a certain amount of time. Default is off, which means the screen will always stay on.

Auto-enable FollowMeTV: FollowMeTV function (if available) will start automatically when this setting is enabled. Default is disabled.

Auto-connection to TV: When enabled, your mobile device will automatically connect to last connected TV and skips the TV search screen.

Change TV (Only in IOS): Shows the currently connected TV. You can press on this setting to go to the "TV search" screen and change to a different TV.

Edit custom channel list: You can edit your custom channel list using this setting.

Choose channel list source: You can choose the channel list source to be used in the application. The options are "TV List" and "Custom List". Additionally you can activate "Remember my choice" option to set the selected channel list source as a constant choice. In this case if the selected source is available it will be used in the application.

Version No: Displays the current version of the application.

Detail Page

To open detail page tap on a programme. On the detail page screen you can get detailed information of the programmes you select. There are "Details", "Cast&Crew" and "Videos" tabs to find on this page.

DETAILS: This tab provides summary and information about the selected programme. Also there are links to facebook and twitter pages of the programme selected.

CAST&CREW: Shows all the people contributed to the current programme.

VIDEOS: Provides videos on Youtube related to the selected programme.

Note: *For some functions an internet connection may be required.*

FollowMe TV Feature (if available)

Tap on the **FOLLOW ME TV** widget located at the bottom left of the screen of your mobile device to change the layout for **FollowMe TV** feature.

Tap the play icon to start streaming of the content from the TV to your mobile device. Available if your device is in your routers operation range.

Mirror Mode

This mode of FollowMe TV feature is enabled by default and allows streaming the content from any other selected TV sources and Media Browser.

Notes:

Note that only digital(DVB-T/C/S) SD and HD channels are supported.

Multilanguage audio support and subtitle on/off features are not functional.

The streaming performance may change depending on the quality of your connection.

Media Share Page

To access the **Media Share** widget tap on the **Up-arrow** on the bottom left side of the screen.

If the Media Share widget is pressed, a screen is displayed where you can select the media file type to share with your TV.

Note: *Not all image file formats are supported. This function will not work if Audio Video Sharing feature is not supported.*

Portal Launcher

To access the **Portal Launcher**  widget tap on the **Up-arrow** on the bottom left side of the screen.

You can access the portal page by tapping on the **Portal Launcher** widget.

Note: *Internet connection is required. This function will not work if a portal page is not in use.*

Smart Remote Feature

You can use your mobile device as a remote control for your TV once it has connected to the TV. To use smart remote's full features tap on the **Up-arrow** on the bottom left side of the screen.

Voice Recognition

You can tap on the **Microphone**  widget and manage your application, giving voice commands such as "Portal!", "Volume Up/Down!", "Programme Up/Down!".

Note: *This feature is only for android based devices available.*

Keyboard Page

The keyboard page can be opened in two ways; by pressing the **Keyboard**  widget on the application screen or automatically by receiving a command from the TV.

Requirements

1. Smart TV
2. Network connection
3. Mobile Device based on Android or iOS platform (Android OS 4.0 or higher; IOS 6 or higher version)
4. Smart Center app.(to be found on online application stores based on Android and iOS platforms)
5. Router modem
6. USB storage device in FAT32 format (required for PVR feature, if available)

Notes:

For Android devices, Normal(mdpi), Large(hdpi) and Extra Large(xhdpi) screen sizes are supported. Devices with 3" or smaller screen sizes are not supported.

For iOS devices, all screen sizes are supported.

User interface of the Smart Center application is subject to change according to version installed on your device.