

RIG 800 series

RIG 800HS, RIG 800HX

User Guide

Contents

Setup and basics	3
Fit	3
Setup PS4	4
Setup Xbox One	4
Charge	5
Adjust volume	6
Mute	6
Set EQ	6
Support	8

Setup and basics

Your adapter comes pre-paired to your headset. After you adjust and charge your headset and configure your adapter, power on your headset and it's ready to go.

Fit Your headset components easily snap into the headset frame to configure the best fit and sound. The headband adjusts to three sizes (small, medium, large) by moving the earcups. To remove an earcup, press the earcup to detach it from the headband.

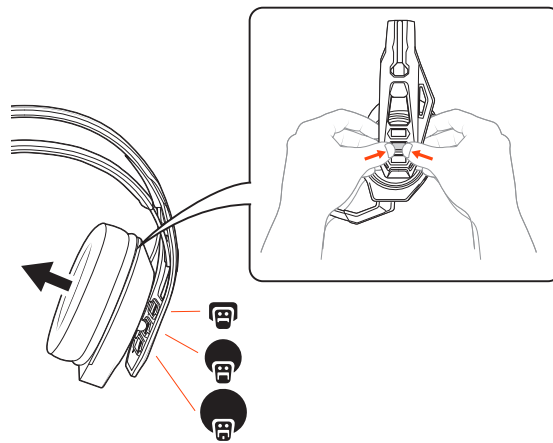

Setup PS4

PS4

- 1 Connect your adapter to your system.

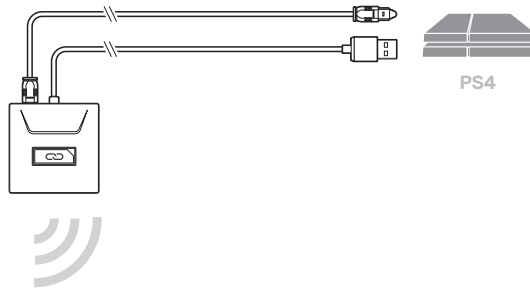

- 2 Power on your PS4 and Check for updates
- 3 Go to **Settings > Sound and Screen > Audio Output Settings > Select Digital Out (Optical)**
- 4 Go to **Settings > Devices > Audio Devices > Output Devices** Select Plantronics RIG800XX

PS4 (slim version)

- 1 Connect your adapter to your system.

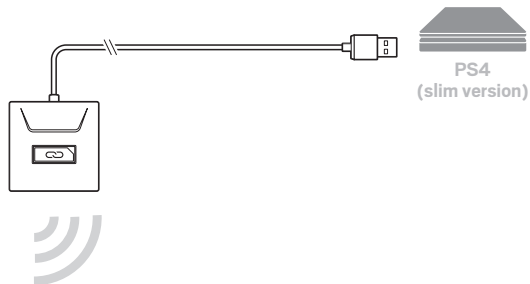

- 2 Power on your PS4 and Check for updates
- 3 Go to **Settings > Devices > Audio Devices > Output Devices** Select Plantronics RIG800XX
- 4 Go to **Settings > Devices > Audio Devices > Output to headphones > All audio**

Setup Xbox One

- 1 Connect your adapter to your system.

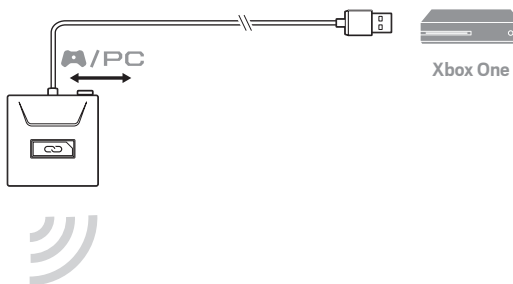

NOTE Ensure the switch on the back of the adapter is set to your preference: console or PC.

- 2 Power on your Xbox One and Check for updates
- 3 Go to **All settings > Kinect and Devices > Device Options and Accessories > Assign**

Charge

It takes up to 4.5 hours to fully charge your headphones. The headset LED is red while charging and turns off when complete.

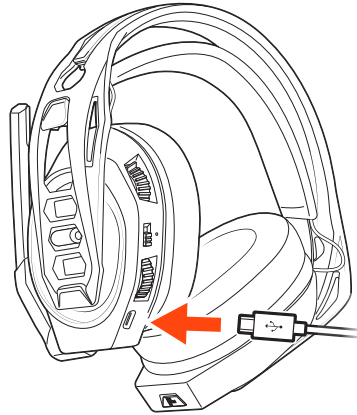

🕒 04:30:00 = 🔋 100%

- Adjust volume
- 1 To increase or decrease the game and chat volume, adjust the top headset dial.
 - 2 To increase or decrease the master volume, adjust the bottom headset dial.

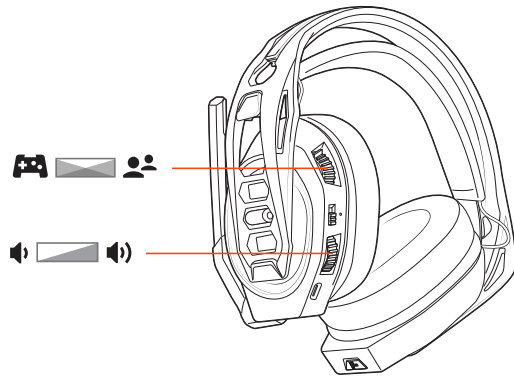

IMPORTANT For the *PS4 (slim version)*, set the top headset dial in the middle; game and chat remain balanced. Use the bottom headset dial to increase or decrease the master volume.

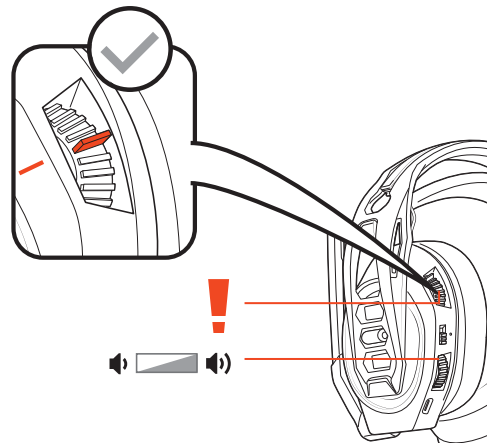

- Mute
- Lift the boom to a full stop to mute the microphone.

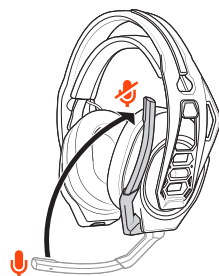

CAUTION Do not force the boom past its upper or lower limits.

- Set EQ
- Cycle through the EQ modes by tapping the EQ button.

Tap the EQ button and hear

EQ mode

one tone

Pure EQ maintains high frequencies.

two tones

Seismic EQ emphasizes mid-range sounds.

three tones

Intensify EQ boosts bass.

four tones

Vocal Focus EQ

Support

EN 0800 410014	FI 0800 117095	NO 80011336
AR +44 (0)1793 842443*	FR 0800 945770	PL +44 (0)1793 842443*
CS +44 (0)1793 842443*	GA 1800 551 896	PT 800 84 45 17
DA 80 88 46 10	HE +44 (0)1793 842443*	RO +44 (0)1793 842443*
DE Deutschland 0800 9323 400 Österreich 0800 242 500 Schweiz 0800 932 340	HU +44 (0)1793 842443*	RU 8-800-100-64-14 +44 (0)1793 842443*
EL +44 (0)1793 842443*	IT 800 950934	SV 0200 21 46 81
ES 900 803 666	NL NL 0800 7526876 BE 0800 39202 LUX 800 24870	TR +44 (0)1793 842443*

**Support in English*

For warranty details, go to plantronics.com/warranty.

NEED MORE HELP?

plantronics.com/support

plantronics®

Simply Smarter Communications™

Plantronics, Inc.

345 Encinal Street
Santa Cruz, CA 95060
United States

Plantronics B.V.

Scorpius 171
2132 LR Hoofddorp
Netherlands

© 2016 Plantronics, Inc. Plantronics and RIG are trademarks of Plantronics, Inc. registered in the US and other countries. Manufactured under license from Dolby Laboratories. Dolby and the double-D symbol are registered trademarks of Dolby Laboratories. All other trademarks are the property of their respective owners.

Patents pending.

208788-06 (12.16)