

**SHARP**<sup>®</sup>

**PN-R706**

**PN-R606**

**PN-R556**

**PN-R496**

**PN-R426**

**LCD MONITOR**

**OPERATION MANUAL**

**HDMI**



### **Information on the Disposal of this Equipment and its Batteries**

**IF YOU WISH TO DISPOSE OF THIS EQUIPMENT OR ITS BATTERIES, DO NOT USE THE ORDINARY WASTE BIN, AND DO NOT PUT THEM INTO A FIREPLACE!**

Used electrical and electronic equipment and batteries should always be collected and treated **SEPARATELY** in accordance with local law.

Separate collection promotes an environment-friendly treatment, recycling of materials, and minimizing final disposal of waste. **IMPROPER DISPOSAL** can be harmful to human health and the environment due to certain substances! Take **USED EQUIPMENT** to a local, usually municipal, collection facility, where available.

Remove **USED BATTERIES** from equipment, and take them to a battery collection facility; usually a place where new batteries are sold.

If in doubt about disposal, contact your local authorities or dealer and ask for the correct method of disposal.

**ONLY FOR USERS IN THE EUROPEAN UNION, AND SOME OTHER COUNTRIES; FOR INSTANCE NORWAY AND SWITZERLAND:** Your participation in separate collection is requested by law.

The symbol shown above appears on electrical and electronic equipment and batteries (or the packaging) to remind users of this. If 'Hg' or 'Pb' appears below the symbol, this means that the battery contains traces of mercury (Hg) or lead (Pb), respectively.



Users from **PRIVATE HOUSEHOLDS** are requested to use existing return facilities for used equipment and batteries.

Batteries are collected at points of sale. Return is free of charge.

If the equipment has been used for **BUSINESS PURPOSES**, please contact your SHARP dealer who will inform you about take-back. You might be charged for the costs arising from take-back. Small equipment (and small quantities) might be taken back by your local collection facility. For Spain: Please contact the established collection system or your local authority for take-back of your used products.

# IMPORTANT INFORMATION

**WARNING:** TO REDUCE THE RISK OF FIRE OR ELECTRIC SHOCK, DO NOT EXPOSE THIS PRODUCT TO RAIN OR MOISTURE.

	<b>CAUTION</b> RISK OF ELECTRIC SHOCK DO NOT OPEN	
<p>CAUTION: TO REDUCE THE RISK OF ELECTRIC SHOCK, DO NOT REMOVE COVER. NO USER-SERVICEABLE PARTS INSIDE. REFER SERVICING TO QUALIFIED SERVICE PERSONNEL.</p>		



The lightning flash with arrowhead symbol, within a triangle, is intended to alert the user to the presence of uninsulated "dangerous voltage" within the product's enclosure that may be of sufficient magnitude to constitute a risk of electric shock to persons.



The exclamation point within a triangle is intended to alert the user to the presence of important operating and maintenance (servicing) instructions in the literature accompanying the product.

## FOR CUSTOMERS IN U.K. IMPORTANT

The wires in this mains lead are coloured in accordance with the following code:

<b>GREEN-AND-YELLOW:</b>	<b>Earth</b>
<b>BLUE:</b>	<b>Neutral</b>
<b>BROWN:</b>	<b>Live</b>

As the colours of the wires in the mains lead of this apparatus may not correspond with the coloured markings identifying the terminals in your plug proceed as follows:

- The wire which is coloured GREEN-AND-YELLOW must be connected to the terminal in the plug which is marked by the letter **E** or by the safety earth  $\perp$  or coloured green or green-and-yellow.
- The wire which is coloured BLUE must be connected to the terminal which is marked with the letter **N** or coloured black.
- The wire which is coloured BROWN must be connected to the terminal which is marked with the letter **L** or coloured red.

Ensure that your equipment is connected correctly. If you are in any doubt consult a qualified electrician.

**"WARNING: THIS APPARATUS MUST BE EARTHED."**

# DEAR SHARP CUSTOMER

---

Thank you for your purchase of a SHARP LCD product. To ensure safety and many years of trouble-free operation of your product, please read the Safety Precautions carefully before using this product.

## SAFETY PRECAUTIONS

---

Electricity is used to perform many useful functions, but it can also cause personal injuries and property damage if improperly handled. This product has been engineered and manufactured with the highest priority on safety. However, improper use can result in electric shock and/or fire. In order to prevent potential danger, please observe the following instructions when installing, operating and cleaning the product. To ensure your safety and prolong the service life of your LCD product, please read the following precautions carefully before using the product.

1. Read instructions — All operating instructions must be read and understood before the product is operated.
2. Keep this manual in a safe place — These safety and operating instructions must be kept in a safe place for future reference.
3. Observe warnings — All warnings on the product and in the instructions must be observed closely.
4. Follow instructions — All operating instructions must be followed.
5. Cleaning — Unplug the power cord from the AC outlet before cleaning the product. Use a dry cloth to clean the product. Do not use liquid cleaners or aerosol cleaners. Do not use dirty cloths. Doing so may damage the product.
6. Attachments — Do not use attachments not recommended by the manufacturer. Use of inadequate attachments can result in accidents.
7. Water and moisture — Do not use the product near water. Do not install the product in a place where water may splash onto it. Be careful of equipment which drains water such as an air-conditioner.
8. Ventilation — The vents and other openings in the cabinet are designed for ventilation. Do not cover or block these vents and openings since insufficient ventilation can cause overheating and/or shorten the life of the product. Do not place the product on a sofa, rug or other similar surface, since they can block ventilation openings. Do not place the product in an enclosed place such as a bookcase or rack, unless proper ventilation is provided or the manufacturer's instructions are followed.
9. Power cord protection — The power cords must be routed properly to prevent people from stepping on them or objects from resting on them.
10. The LCD panel used in this product is made of glass. Therefore, it can break when the product is dropped or applied with impact. Be careful not to be injured by broken glass pieces in case the LCD panel breaks.
11. Overloading — Do not overload AC outlets or extension cords. Overloading can cause fire or electric shock.
12. Entering of objects and liquids — Never insert an object into the product through vents or openings. High voltage flows in the product, and inserting an object can cause electric shock and/or short internal parts. For the same reason, do not spill water or liquid on the product.
13. Servicing — Do not attempt to service the product yourself. Removing covers can expose you to high voltage and other dangerous conditions. Request a qualified service person to perform servicing.
14. Repair — If any of the following conditions occurs, unplug the power cord from the AC outlet, and request a qualified service person to perform repairs.
  - a. When the power cord or plug is damaged.
  - b. When a liquid was spilled on the product or when objects have fallen into the product.
  - c. When the product has been exposed to rain or water.
  - d. When the product does not operate properly as described in the operating instructions.

Do not touch the controls other than those described in the operating instructions. Improper adjustment of controls not described in the instructions can cause damage, which often requires extensive adjustment work by a qualified technician.
  - e. When the product has been dropped or damaged.
  - f. When the product displays an abnormal condition. Any noticeable abnormality in the product indicates that the product needs servicing.
15. Replacement parts — In case the product needs replacement parts, make sure that the service person uses replacement parts specified by the manufacturer, or those with the same characteristics and performance as the original parts. Use of unauthorized parts can result in fire, electric shock and/or other danger.
16. Safety checks — Upon completion of service or repair work, request the service technician to perform safety checks to ensure that the product is in proper operating condition.
17. Wall mounting — When mounting the product on a wall, be sure to install the product according to the method recommended by the manufacturer.
18. Heat sources — Keep the product away from heat sources such as radiators, heaters, stoves and other heat-generating products (including amplifiers).

# SAFETY PRECAUTIONS (Continued)

19. Batteries — Incorrect use of batteries may cause the batteries to burst or ignite. A leaky battery may corrode the equipment, dirty your hands or spoil your clothing. In order to avoid these problems, make sure to observe the precautions below:
  - Use the specified batteries only.
  - Install the batteries with due attention to the plus (+) and minus (-) sides of the batteries according to the instructions in the compartment.
  - Do not mix old and new batteries.
  - Do not mix batteries of different types. Voltage specifications of batteries of the same shape may vary.
  - Replace an exhausted battery with a new one promptly.
  - If you will not use the remote control for a long time, remove the batteries.
  - If leaked battery fluid gets on your skin or clothing, rinse immediately and thoroughly. If it gets into your eye, bathe your eye well rather than rubbing and seek medical treatment immediately. Leaked battery fluid that gets into your eye or your clothing may cause a skin irritation or damage your eye.
20. Usage of the monitor must not be accompanied by fatal risks or dangers that, could lead directly to death, personal injury, severe physical damage or other loss, including nuclear reaction control in nuclear facility, medical life support system, and missile launch control in a weapon system.
21. Do not stay in contact with the parts of the product that become hot for long periods of time. Doing so may result in low-temperature burns.
22. Do not modify this product.

## **WARNING:**

This is a Class A product. In a domestic environment this product may cause radio interference in which case the user may be required to take adequate measures.

An apparatus with CLASS I construction shall be connected to a MAIN socket outlet with a protective earthing connection.

To maintain compliance with EMC regulations, use shielded cables to connect to the following terminals: DVI-D input terminal, HDMI input terminal, D-sub input terminal, RS-232C input/output terminals, and DisplayPort input/output terminals.

If a monitor is not positioned in a sufficiently stable location, it can be potentially hazardous due to falling. Many injuries, particularly to children, can be avoided by taking simple precautions such as:

- Using fixing devices like wall mount brackets recommended by the manufacturer.
- Only using furniture that can safely support the monitor.
- Ensuring the monitor is not overhanging the edge of the supporting furniture.
- Not placing the monitor on tall furniture (for example, cupboards or bookcases) without anchoring both the furniture and the monitor to a suitable support.
- Not standing the monitors on cloth or other materials placed between the monitor and supporting furniture.
- Educating children about the dangers of climbing on furniture to reach the monitor or its controls.
- This equipment is not suitable for use in locations where children are likely to be present unsupervised.

## **Especially for child safety**

- Don't allow children to climb on or play with the monitor.
- Don't place the monitor on furniture that can easily be used as steps, such as a chest of drawers.
- Remember that children can become excited while watching a program, especially on a "larger than life" monitor. Care should be taken to place or install the monitor where it cannot be pushed, pulled over, or knocked down.
- Care should be taken to route all cords and cables connected to the monitor so that they cannot be pulled or grabbed by curious children.

# TIPS AND SAFETY INSTRUCTIONS

- The TFT color LCD panel used in this monitor is made with the application of high precision technology. However, there may be minute points on the screen where pixels never light or are permanently lit. Also, if the screen is viewed from an acute angle there may be uneven colors or brightness. Please note that these are not malfunctions but common phenomena of LCDs and will not affect the performance of the monitor.
- Do not display a still picture for a long period, as this could cause a residual image.
- Never rub or tap the monitor with hard objects.
- Please understand that SHARP CORPORATION bears no responsibility for errors made during use by the customer or a third party, nor for any other malfunctions or damage to this product arising during use, except where indemnity liability is recognized under law.
- This monitor and its accessories may be upgraded without advance notice.
- Do not use the monitor where there is a lot of dust, where humidity is high, or where the monitor may come into contact with oil or steam. Do not use in an environment where there are corrosive gases (sulfur dioxide, hydrogen sulfide, nitrogen dioxide, chlorine, ammonia, ozone, etc.). As this could lead to fire.
- Ensure that the monitor does not come into contact with water or other fluids. Ensure that no objects such as paper clips or pins enter the monitor as this could lead to fire or electric shock.
- Do not place the monitor on top of unstable objects or in unsafe places. Do not allow the monitor to receive strong shocks or to strongly vibrate. Causing the monitor to fall or topple over may damage it.
- Do not use the monitor near heating equipment or in places where there is likelihood of high temperature, as this may lead to generation of excessive heat and outbreak of fire.
- Do not use the monitor in places where it may be exposed to direct sunlight. Risk of cabinet deformation and failure if the monitor is used in direct sunlight.
- If the monitor is installed in a location exposed to sunlight such as next to a window, measures to reduce ultraviolet and infrared radiation and temperature measures are required. For details, consult your dealer.
- Please be sure to constantly remove dust and garbage that has attached to the ventilation opening. If dust collects in the ventilation opening or the inside of the monitor, it may lead to excessive heat, outbreak of fire, or malfunction. Please request a cleaning of the inside of the monitor from an authorized SHARP servicing dealer or service center.
- Images cannot be rotated on this monitor. When using in portrait orientation, you will need to prepare appropriately orientated content in advance.
- The AC outlet shall be installed near the equipment and shall be easily accessible.

## The Power Cord

- Use only the power cord supplied with the monitor.
- Do not damage the power cord nor place heavy objects on it, stretch it or over bend it. Also, do not add extension cords. Damage to the cord may result in fire or electric shock.
- Do not use the power cord with a power tap. Adding an extension cord may lead to fire as a result of overheating.
- Do not remove or insert the power plug with wet hands. Doing so could result in electric shock.
- Unplug the power cord if it is not used for a long time.
- Do not attempt to repair the power cord if it is broken or malfunctioning. Refer the servicing to the service representative.

## Manual Scope

- Microsoft and Windows are either registered trademarks or trademarks of Microsoft Corporation in the United States and/or other countries.
- The terms HDMI and HDMI High-Definition Multimedia Interface, and the HDMI Logo are trademarks or registered trademarks of HDMI Licensing Administrator, Inc. in the United States and other countries.
- DisplayPort is a registered trademark of Video Electronics Standards Association.
- Adobe, Acrobat, and Acrobat Reader are either registered trademarks or trademarks of Adobe Systems Incorporated in the United States and/or other countries.
- RoomView, Crestron RoomView and Crestron Connected are either trademarks or registered trademarks of Crestron Electronics, Inc. in the United States and/or other countries.
- All other brand and product names are trademarks or registered trademarks of their respective holders.
- Language of OSD menu used in this manual is English by way of example.
- Illustrations in this manual may not exactly represent the actual product or display.
- This manual assumes use in landscape orientation, except where specifically noted.

## LED Backlight

- The LED backlight in this product has a limited lifetime.
  - \* If the screen gets dark or does not turn on, it may be necessary to replace the LED backlight.
  - \* This LED backlight is exclusive to this product and must be replaced by an authorized SHARP servicing dealer or service center. Please contact an authorized SHARP servicing dealer or service center for assistance.

# MOUNTING PRECAUTIONS

- This product is for use indoors.
- A mounting bracket compliant with VESA specifications is required.
- Since the monitor is heavy, consult your dealer before installing, removing or moving the monitor.
- Mounting the monitor on the wall requires special expertise and the work must be performed by an authorized SHARP dealer. You should never attempt to perform any of this work yourself. Our company will bear no responsibility for accidents or injuries caused by improper mounting or mishandling.
- Use the monitor with the surface perpendicular to a level surface. If necessary, the monitor may be tilted up to 20 degrees upward or downward.
- This monitor should be used at an ambient temperature between 32°F (0°C) and 104°F (40°C). Provide enough space around the monitor to prevent heat from accumulating inside.

## For the monitor in landscape orientation

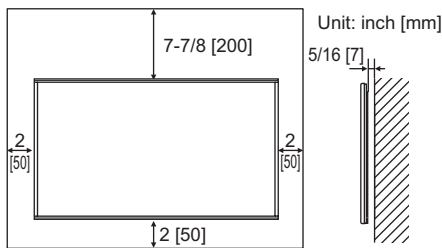

## For the monitor in portrait orientation

### [PN-R706/PN-R606]

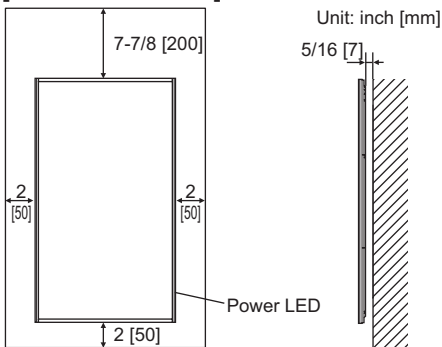

### [PN-R556/PN-R496/PN-R426]

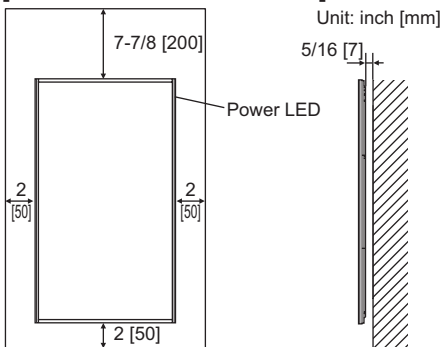

- If it is difficult to provide sufficient space for any reason such as the installation of the monitor inside a housing or of several units side-by-side, or if the ambient temperature may be outside of the range of 32°F (0°C) to 104°F (40°C), install a fan or take other measures to keep the ambient temperature within the required range. When installing two or more monitor units side-by-side, provide space of at least 3/16 inch (5 mm) around them to prevent stress on the adjacent unit or structure due to thermal expansion.
- Temperature condition may change when using the monitor together with the optional equipments recommended by SHARP. In such cases, please check the temperature condition specified by the optional equipments.

- Do not block any ventilation openings. If the temperature inside the monitor rises, this could lead to a malfunction.
- Do not place the monitor on a device which generates heat.
- Adhere to the following when installing the monitor in its portrait orientation. Failing to adhere to the following may cause malfunctions.
  - Install the monitor such that the power LED is located on the right side.
  - Set the PORTRAIT/LANDSCAPE INSTALL in the MONITOR menu to PORTRAIT. (See page 28.)
  - Be sure to clamp the power cord (supplied) by using the supplied cable clamp (affixing type). When clamping the power cord, take care not to stress the terminal of the power cord. Do not bend the power cord excessively.

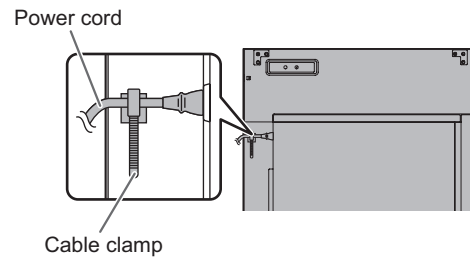

## Mounting the monitor laying flat on a surface

- When using the monitor laying flat on a surface (when the monitor is tilted 20 degrees or more upward or downward from the perpendicular in relation to a level surface), consult an authorized SHARP dealer because there are some specific mounting conditions. Adhere to the following. Failing to adhere to the following may cause malfunctions.
  - The PN-R706/PN-R606 can be tilted by up to 90 degrees upward and by up to 45 degrees downward.
  - The PN-R556/PN-R496/PN-R426 can be tilted by up to 90 degrees upward and downward.
  - Set HORIZONTAL INSTALLATION in the MONITOR menu to UPWARD or DOWNWARD. (See page 28.)
  - Use the monitor at the ambient temperature within the range of 32°F (0°C) to 86°F (30°C). Provide 7-7/8 inch (200 mm) or more space between the monitor and the ceiling or other mounting surfaces and surrounding objects to prevent heat from accumulating inside. If it is difficult to provide sufficient space or if the ambient temperature may be outside of the range of 32°F (0°C) to 86°F (30°C), install a fan or take other measures to keep the ambient temperature within the required range.

### For the monitor laying flat on a surface (facing up)

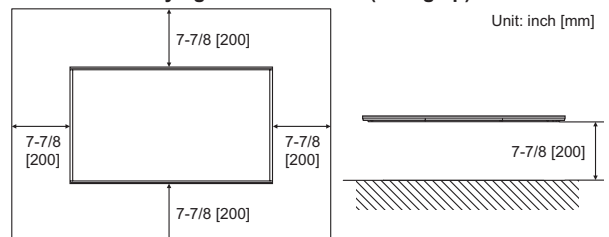

### For the monitor laying flat on a surface (facing down)

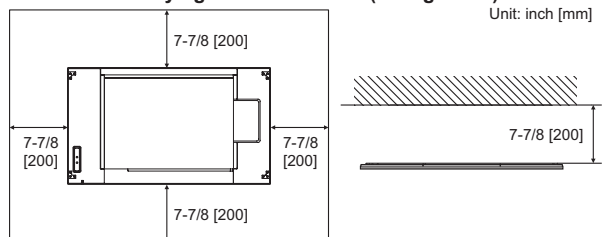

- Do not press hard on the LCD panel or otherwise subject it to impacts.

# Contents

<b>IMPORTANT INFORMATION</b> .....	3	<b>Initialization (Reset)/Functional Restriction Setting (FUNCTION)</b> .....	34
<b>DEAR SHARP CUSTOMER</b> .....	4	<b>Controlling the Monitor with a PC (RS-232C)</b> .....	35
<b>SAFETY PRECAUTIONS</b> .....	4	PC connection.....	35
<b>TIPS AND SAFETY INSTRUCTIONS</b> .....	6	Communication conditions.....	35
<b>MOUNTING PRECAUTIONS</b> .....	7	Communication procedure.....	35
<b>Supplied Components</b> .....	8	Setting of the GAMMA user data.....	38
<b>Part Names</b> .....	9	RS-232C command table.....	39
<b>Connecting Peripheral Equipment</b> .....	11	<b>Controlling the Monitor with a computer (LAN)</b> .....	47
Connection with a PC or AV equipment.....	11	Settings to connect to a LAN.....	47
<b>Connecting the Power Cord</b> .....	13	Controlling with a computer.....	49
<b>Binding Cables</b> .....	13	[Advanced operation]	
<b>Removing the Handles (PN-R706/PN-R606 only)</b> .....	14	Command-based control.....	55
<b>Attaching Ceiling Mounting Brackets</b> .....	14	<b>Troubleshooting</b> .....	56
<b>Attaching the logo sticker</b> .....	15	<b>Specifications</b> .....	58
<b>Preparing the Remote Control Unit</b> .....	15	<b>Mounting Precautions</b>	
Installing the batteries.....	15	<b>(For SHARP dealers and service engineers)</b> .....	65
Remote control operation range.....	15		
<b>Turning Power On/Off</b> .....	17		
Turning on the main power.....	17		
Turning power on/off.....	17		
Disabling power on/off operations.....	18		
<b>Basic Operation</b> .....	19		
<b>Menu Items</b> .....	22		
Displaying the menu screen.....	22		
Menu item details.....	23		
Adjustments for computer screen display.....	33		

## Supplied Components

If any component should be missing, please contact your dealer.

- Liquid Crystal Display Monitor: 1
- Remote control unit: 1
- Power cord
- R-03 battery ("AAA" size): 2
- CD-ROM (Utility Disk for Windows): 1
- Setup Manual: 1
- Cable clamp: 2
- Logo sticker: 1
- Hole cover sticker (PN-R706 only): 2

- [PN-R706/PN-R606]
- Ceiling mounting bracket: 8
  - Ceiling mounting bracket fixing screw: 24

- [PN-R556/PN-R496/PN-R426]
- Ceiling mounting bracket: 4
  - Ceiling mounting bracket fixing screw: 12

- \* SHARP Corporation holds authorship rights to the Utility Disk program. Do not reproduce it without permission.
- \* For environmental protection!  
Do not dispose of batteries in household waste. Follow the disposal instructions for your area.



# Part Names

[PN-R706/PN-R606]

■ Front view

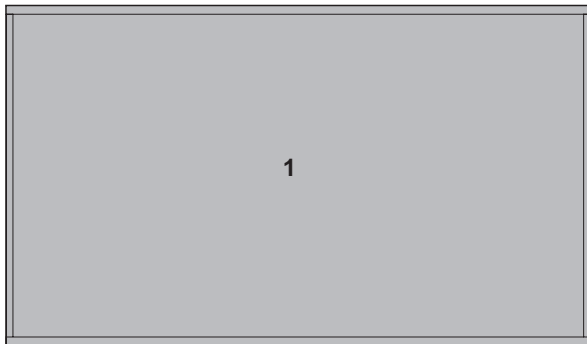

■ Rear view

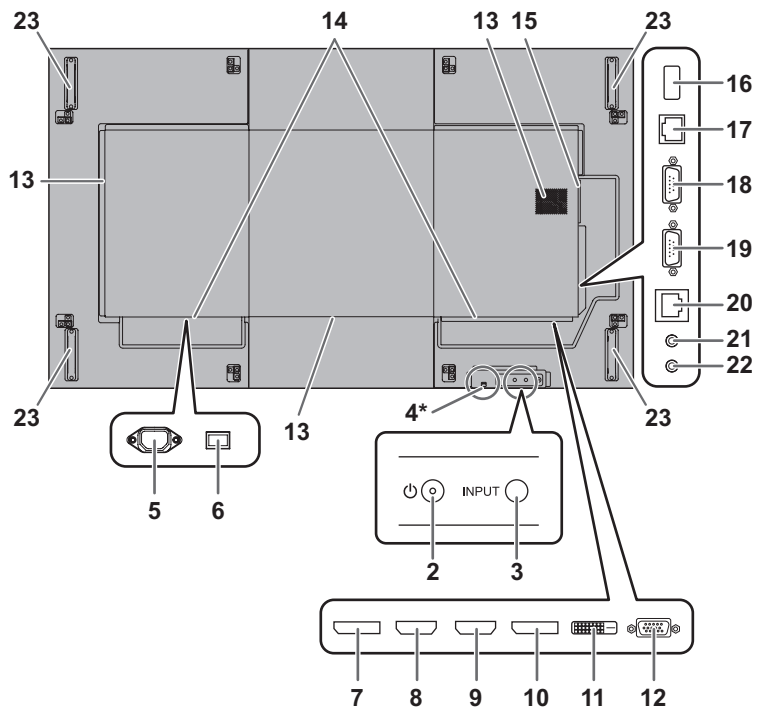

[PN-R556/PN-R496/PN-R426]

■ Front view

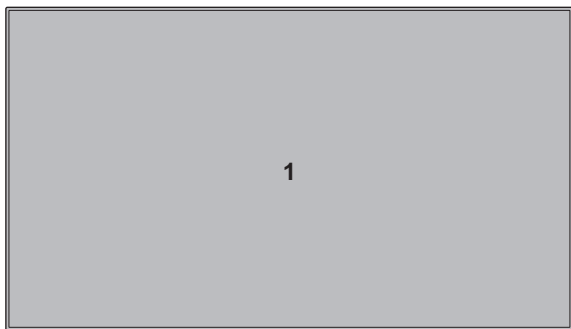

■ Rear view

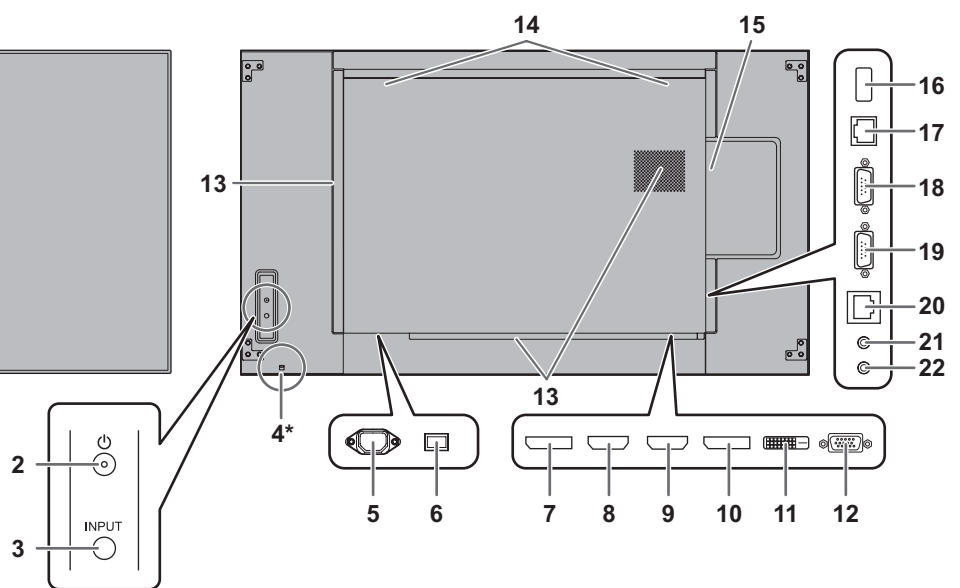

\* How to pull out the power LED/remote control sensor

Pull out

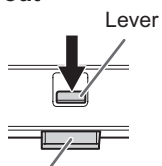

Store

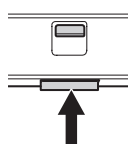

Power LED / Remote control sensor

- Slide the lever on the rear of the monitor to pull out the power LED/remote control sensor.
- Press the power LED/remote control sensor directly to store it inside the monitor.

## Part Names

1. LCD panel
2. Power button (See page 17.)
3. Input button (See page 20.)
4. Power LED (See page 17.) / Remote control sensor (See page 15.)
5. AC input terminal (See page 13.)
6. Main power switch (See page 13.)
7. DisplayPort output terminal (See page 11.)
8. HDMI1 input terminal (See page 12.)
9. HDMI2 input terminal (See page 12.)
10. DisplayPort input terminal (See page 12.)
11. DVI-D input terminal (See page 12.)
12. D-sub input terminal (See page 12.)
13. Vents
14. Speakers
15. Expansion slot  
This section is used to connect optional hardware for function expansion. Offering this attachment location is not a guarantee that future compatible hardware attachments will be released.
16. 5 V power supply terminal (See page 12.)
17. LAN terminal (See page 12.)
18. RS-232C output terminal (See page 12.)
19. RS-232C input terminal (See page 12.)
20. Optional terminal  
This terminal is provided for possible future (optional) function expansion. Offering of this terminal is not a guarantee that future expanded functionality will be released.
21. Audio output terminal (See page 12.)
22. Audio input terminal (See page 12.)
23. Handle (PN-R706/PN-R606 only; two handles on the PN-R606)

### ! Caution

- Consult your SHARP dealer for attachment/detachment of optional parts.

## ■ Remote control unit

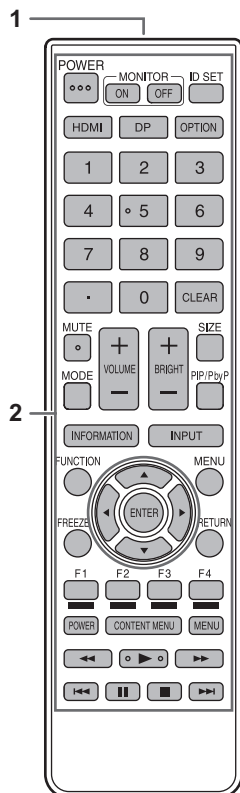

1. Signal transmitter
2. Operation buttons (See pages 17 and 19.)

# Connecting Peripheral Equipment

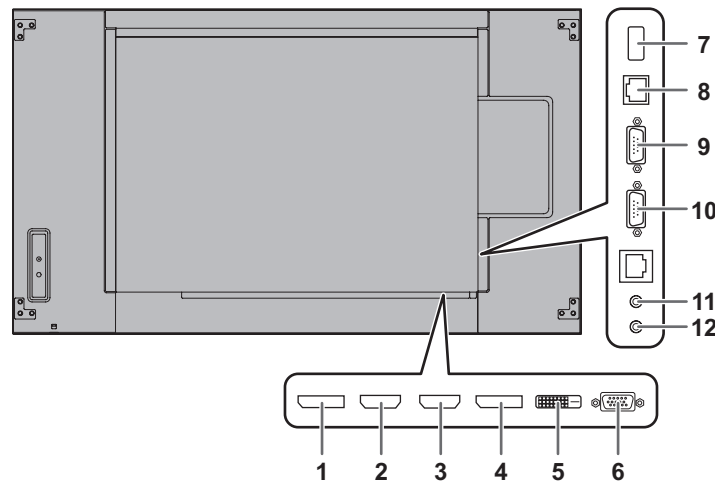

## ! Caution

- Be sure to turn off the main power switch and disconnect the plug from the power outlet before connecting/disconnecting cables. Also, read the manual of the equipment to be connected.
- Be careful not to confuse the input terminal with the output terminal when connecting cables. Accidentally reversing cables connected to the input and output terminals may cause malfunctions and the other problems.
- Do not use any cable that has a damaged or deformed terminal. Using such cables may cause malfunctions.
- Use the following cable terminal connector for the DVI-D input terminal.

Length between the terminal base to the cable section:

1-7/16 inch (37mm) or less

Maximum thickness: 5/8 inch (16mm) or less

Cable diameter: 1/4 inch (6.5mm) or less

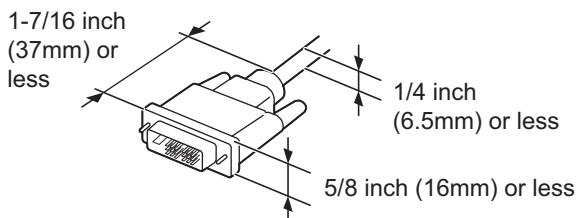

## TIPS

- Images may not be displayed properly depending on the computer (video card) to be connected.
- Use the automatic screen adjustment when a PC screen is displayed for the first time using D-SUB[RGB] or when the setting of the PC is changed. The screen is adjusted automatically when SELF ADJUST in the MONITOR menu is set to ON.
- If the audio output from the playback device is connected directly to speakers or other devices, the video on the monitor may appear delayed from the audio portion. Audio should be played through this monitor by connecting the playback device to the monitor's audio input, and connecting the monitor's audio output to the speakers or other devices.

- The audio input terminals used in each input mode are factory-set as follows.

Input mode	Audio input terminal (Factory setting)
DVI-D	Audio input terminal
DisplayPort	DisplayPort input terminal
HDMI1	HDMI1 input terminal
HDMI2	HDMI2 input terminal
D-SUB[RGB], D-SUB[COMPONENT]	Audio input terminal
OPTION *	Expansion slot

\* When you have used the expansion slot to expand the functions.

## Connection with a PC or AV equipment

### 1. DisplayPort output terminal

- The video of the current input mode can be output to an external device.
- Use a commercially available DisplayPort cable.
- Outputting HDCP-encrypted video requires an external device which supports HDCP.
- This terminal can be used to make a daisy chain connection\* by connecting the monitors to each other through the DisplayPort input terminal of each monitor.

\*: Up to 25 monitors.

Up to 4 monitors when the video signal is encrypted by HDCP.

Up to 4 monitors when the first monitor's input mode is D-SUB[COMPONENT].

Up to 2 monitors when the first monitor's input mode is DisplayPort (MST).

## TIPS

- The length of the signal cables or surrounding environment may affect the image quality.
- The output screen may not be displayed properly. In this case, turn off the power to all the monitors connected in a daisy chain and then turn the power on again.
- When connecting monitors in a daisy chain set NO SIGNAL AUTO INPUT SEL. to OFF.
- Video output is disabled in the following cases:  
When the power is turned off  
When the monitor is in input signal waiting mode

## Connecting Peripheral Equipment

### 2. HDMI1 input terminal

### 3. HDMI2 input terminal

- Use a commercially available HDMI cable (conforming to the HDMI standard).
- Select the audio input terminal to be used in HDMI1 or HDMI2 of AUDIO SELECT on the SETUP menu.  
When HDMI is selected, connection to the audio input terminal is unnecessary.

### 4. DisplayPort input terminal

- Use a commercially available DisplayPort cable.
- Select the audio input terminal to be used in DisplayPort of AUDIO SELECT on the SETUP menu.  
When DisplayPort is selected, connection to the audio input terminal is unnecessary.

### 5. DVI-D input terminal

- Use a commercially available signal cable (DVI-D 24 pin).

### 6. D-sub input terminal

- Set D-SUB of INPUT SELECT on the SETUP menu according to the device to be connected.

### 7. 5 V power supply terminal

- You can use this terminal to supply power.

### 8. LAN terminal

- You can control the monitor from a computer on a network by connecting a commercially available LAN cable between this terminal and a network.

### 9. RS-232C output terminal

### 10. RS-232C input terminal

- You can control the monitor from a computer by connecting a commercially available RS-232 straight cable between these terminals and the computer.

### 11. Audio output terminal

- The output sound varies depending on the input mode.
- The volume of the output sound can be fixed by setting AUDIO OUTPUT of AUDIO OPTION on the SETUP menu.
- It is not possible to control the sound output from the audio output terminals with the AUDIO menu.

### 12. Audio input terminal

- Use an audio cable without resistance.
- Set the audio input terminal to be used in AUDIO SELECT on the SETUP menu.

# Connecting the Power Cord

## ! Caution

- Use only the power cord supplied with the monitor.
1. Turn off the main power switch.
  2. Plug the power cord (supplied) into the AC input terminal.
  3. Plug the power cord (supplied) into the AC power outlet.

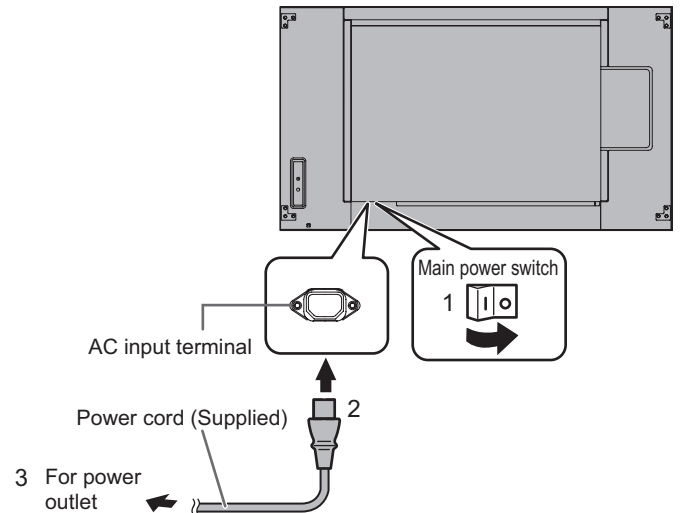

# Binding Cables

The supplied cable clamps (affixing type) can be used to clamp the power code and cables connected to the back of the monitor.

## ! Caution

- Attach the supplied cable clamps to a flat surface. Do not attach over a vent.
- Remove any dust or dirt before attaching.

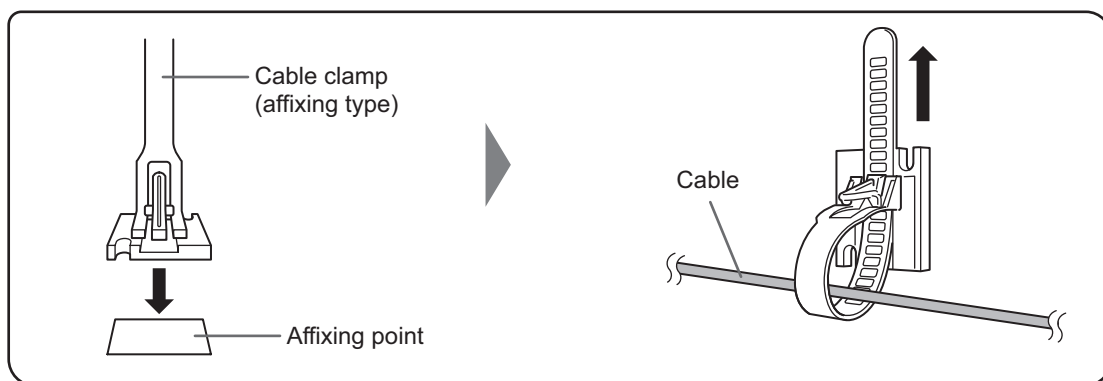

# Removing the Handles (PN-R706/PN-R606 only)

The handles can be removed.

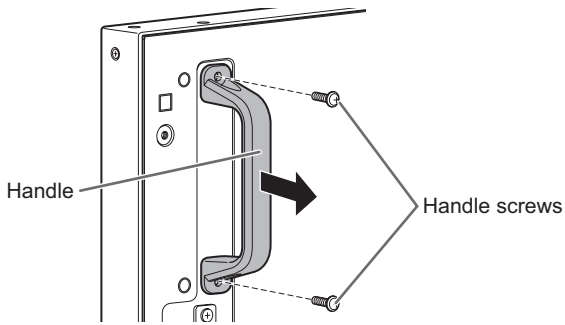

## ! Caution

- The removable handles and handle screws are for use with this monitor. Do not use them for any other devices.
- To attach handles, be sure to use the handles and handle screws which were removed from this monitor.
- Be sure the handles are attached securely.
- Do not attach the handle screws with the handles removed. Doing so may damage the inside of the monitor.

# Attaching Ceiling Mounting Brackets

You can use the ceiling mounting brackets to prevent dropping/falling down.  
Use the supplied ceiling mounting bracket fixing screws to secure the brackets.

## [PN-R706]

Ceiling mounting bracket installation position

Ceiling mounting bracket installation position

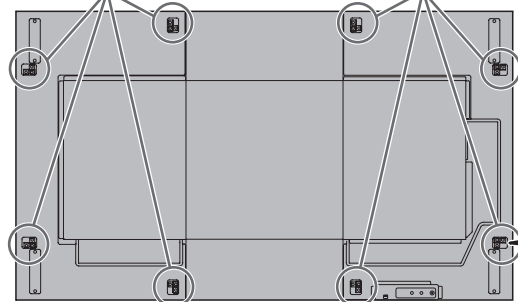

Ceiling mounting bracket fixing screw

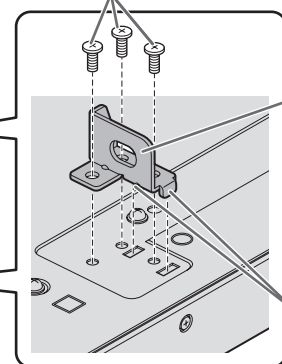

Ceiling mounting bracket

Protrusion

## [PN-R606]

Ceiling mounting bracket installation position

Ceiling mounting bracket installation position

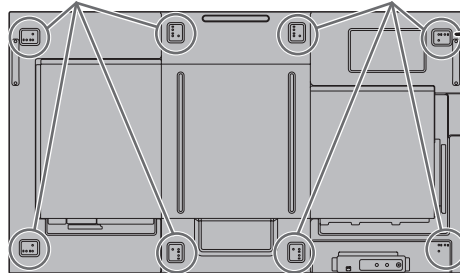

## [PN-R556/PN-R496/PN-R426]

Ceiling mounting bracket installation position

Ceiling mounting bracket fixing screw

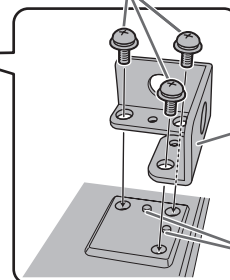
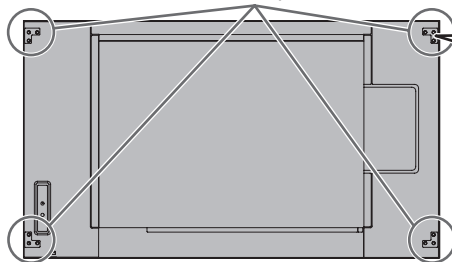

Ceiling mounting bracket

Protrusion

## ! Caution

- When hanging the monitor from a ceiling, contact an authorized SHARP dealer. A special installation is required.

# Attaching the logo sticker

You can attach the supplied logo sticker on the monitor.  
Refer to the following example to attach the sticker as necessary.

## Example for landscape orientation

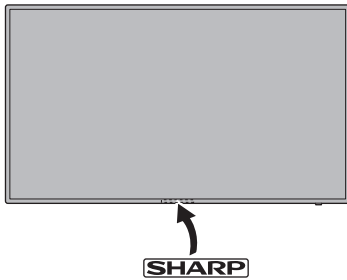

## Example for portrait orientation



# Preparing the Remote Control Unit

## Installing the batteries

1. Place your finger on the part marked with the ▲, and then pull the cover off.

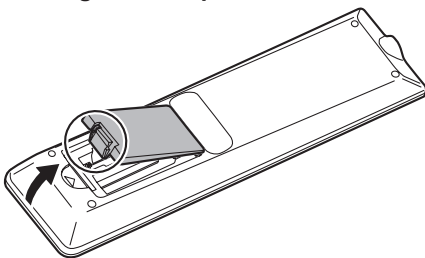

2. See the instructions in the compartment and put in the supplied batteries (R-03 ("AAA" size) x 2) with their plus (+) and minus (-) sides oriented correctly.
3. Close the cover.

### TIPS

- When the batteries become exhausted, replace them with new (commercially available) batteries.
- The supplied batteries (R-03 ("AAA" size) x 2) may become exhausted quickly depending on how they are stored.
- If you will not be using the remote control for a long time, remove the batteries.
- Use manganese or alkaline batteries only.

## Remote control operation range

### Remote control sensor in

The remote control can be operated even when the remote control sensor is stored inside the monitor.  
Point the remote control toward the remote control sensor on the bottom of the monitor (or the right side of the monitor if using portrait orientation).

### [PN-R706/PN-R606]

#### For the monitor in landscape orientation

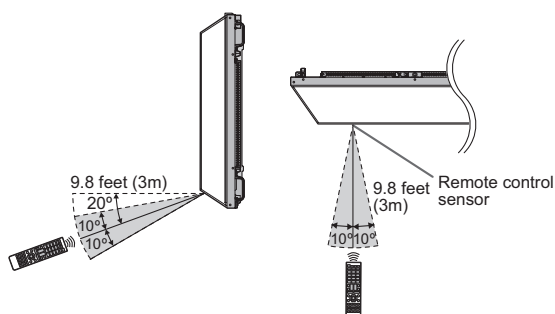

#### For the monitor in portrait orientation

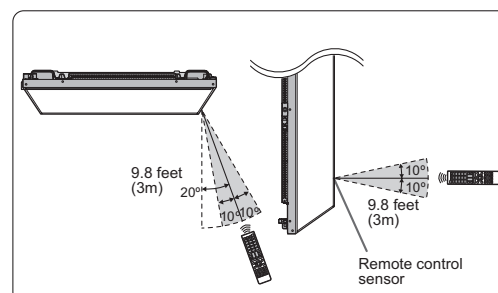

# Preparing the Remote Control Unit

[PN-R556/PN-R496/PN-R426]

For the monitor in landscape orientation

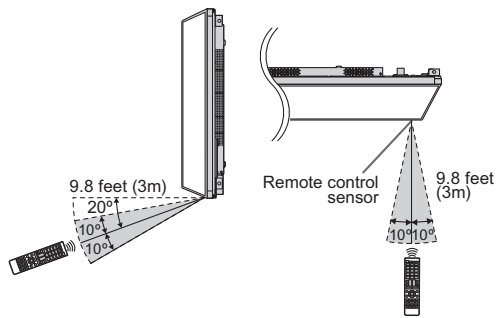

For the monitor in portrait orientation

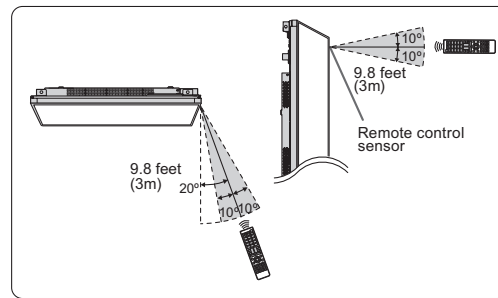

## Remote control sensor out

Point the remote control toward the remote control sensor on the front of the monitor.

[PN-R706/PN-R606]

For the monitor in landscape orientation

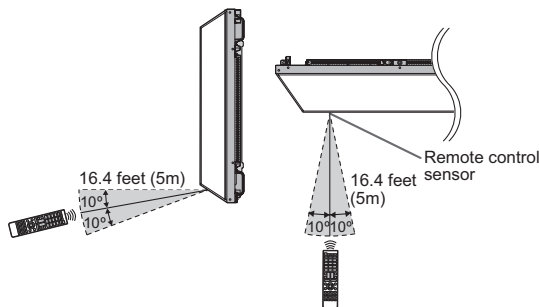

For the monitor in portrait orientation

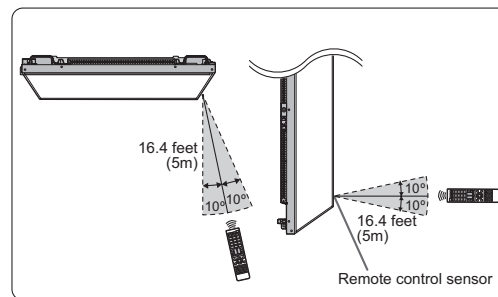

[PN-R556/PN-R496/PN-R426]

For the monitor in landscape orientation

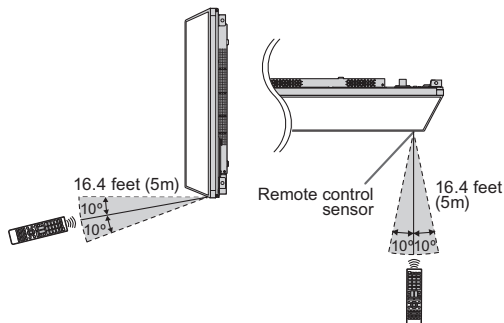

For the monitor in portrait orientation

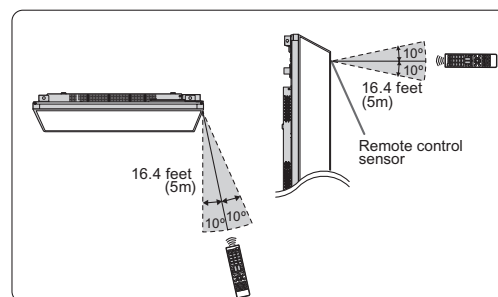

## TIPS

- Do not expose the remote control unit to shock by dropping or stepping on it. This could lead to a malfunction.
- Do not expose the remote control unit to liquids, and do not place it in an area with high humidity.
- The remote control unit may not work properly if the remote control sensor is under direct sunlight or strong lighting.
- Objects between the remote control unit and the remote control sensor may prevent proper operation.
- Replace the batteries when they run low as this may shorten the remote control's operation range.
- If a fluorescent light is illuminated near the remote control unit, it may interfere with proper operation.
- Do not use it with the remote control of other equipment such as air conditioner, stereo components, etc.



# Turning Power On/Off

## ! Caution

- Turn on the monitor first before turning on the computer or playback device.
- When switching the main power switch or the POWER button off and back on, always wait for at least 5 seconds. A short interval may result in a malfunction.

## Turning on the main power

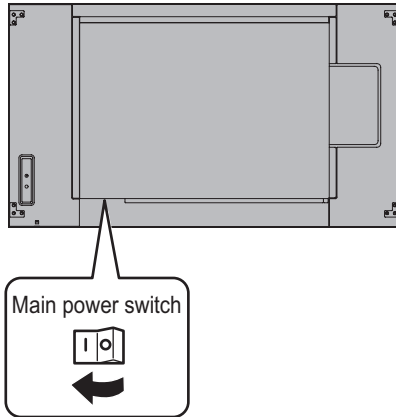

## ! Caution

- The main power must be turned on/off with the main power switch. Do not connect/disconnect the power cord or turn the breaker on/off while the main power switch is on.
- For a complete electrical disconnection, pull out the main plug.

## Turning power on/off

Press the POWER button to turn the power ON/OFF. You can also turn the power ON/OFF by pressing the MONITOR ON button/MONITOR OFF button on the remote control unit.

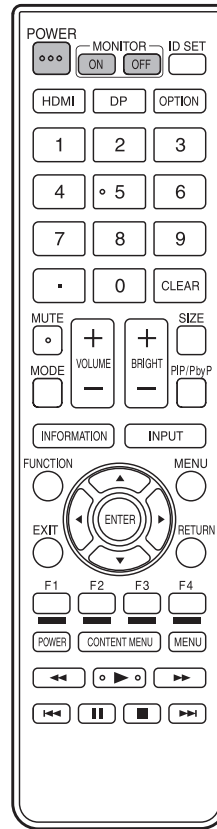

### [PN-R706/PN-R606]

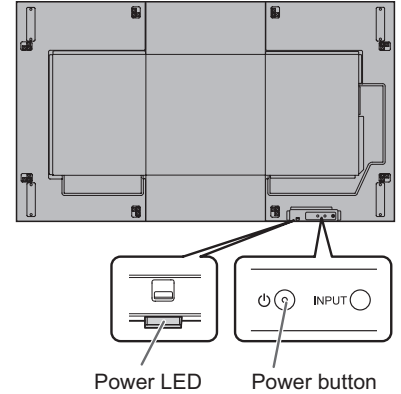

### [PN-R556/PN-R496/PN-R426]

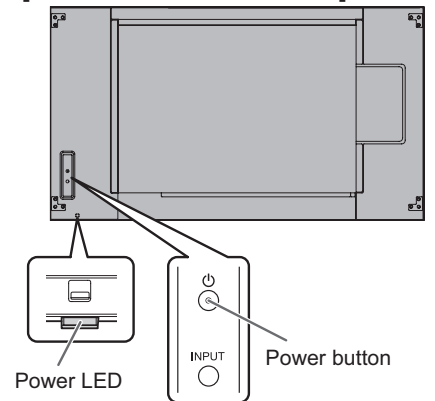

Status	Status of the monitor
Green lit	Power on
Orange lit	Power off (Standby mode)
Green flashing	Input signal waiting mode

## TIPS

- When the main power switch is off, the monitor cannot be turned on.
- If the monitor is in the input signal waiting mode and you press the POWER button, the monitor enters standby mode.
- Setting the SCHEDULE flashes the power LED alternately in red and orange in standby mode.
- To disable the logo screen from displaying when turning the power ON, set LOGO SCREEN to OFF on the OTHERS menu. (See page 30.)

## Turning Power On/Off

### ■Mode setting

When the monitor is turned on for the first time after being shipped from the factory, the mode setting screen will be displayed.

(1) Press  or  to select YES or NO.

(2) Press the ENTER button.

YES:

- OPERATION MODE is set to MODE1.
- OFF IF NO OPERATION is set to ON, and POWER SAVE MODE is set to ON. (These settings can not be changed.)
- If there is no operation for 4 hours or more, the monitor automatically enters standby mode.
- Compared to when set to OFF, the current consumption is reduced while the monitor is in standby mode, but the startup time from standby mode becomes longer.
- While the monitor is in standby mode, control via LAN will be disabled.
- While the monitor is in standby mode, only certain RS-232C commands can be used.

NO:





- OPERATION MODE is set to MODE2.
- OFF IF NO OPERATION is set to OFF, and POWER SAVE MODE is set to OFF. (These settings can be changed.)
- Compared to when set to ON, the startup time from standby mode is reduced, but more power will be consumed in standby mode.

Even after being set, changes can be made using OPERATION MODE, located in MONITOR menu. (See page 28.)

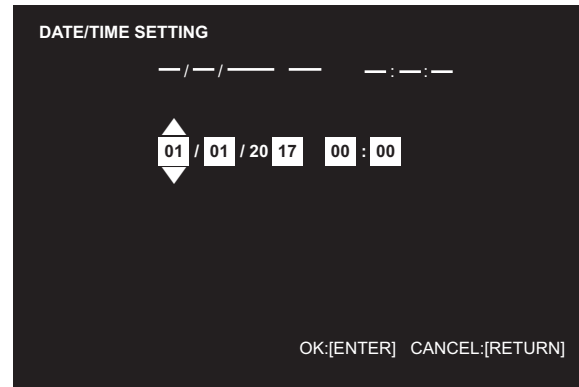
### ■Date/time setting

- If the time has yet to be set when the monitor is first turned on, the date/time setting screen appears. Set the date and time.



1. Press  or  to select the date and time, and press  or  to change the numerical values.
  2. Press the ENTER button.
- Be sure to set the date and time.
  - The date/time setting screen will close automatically if no operation is performed for about 15 seconds. The date and time can be set using DATE/TIME SETTING from the SETUP menu when the date/time setting screen disappears.

#### TIPS

- Set the date in “Day/Month/Year” order.
- Set the time on a 24-hour basis.
- The clock is maintained by the internal battery.
- If you already set the time but the date/time setting screen appears when the power is turned on, the internal battery may be exhausted. Please contact an authorized SHARP servicing dealer or service center for assistance with battery replacement.
- Estimated service life of the internal battery: About 5 years (depending on monitor operation)
- The initial battery was inserted at the factory when the monitor was shipped, so it may run out of power before its expected operation life.

## Disabling power on/off operations

Power on/power off operations can be disabled in order to protect the monitor from an accidental power off. Set the ADJUSTMENT LOCK in FUNCTION menu to “ON 2”. (See page 34.)

# Basic Operation

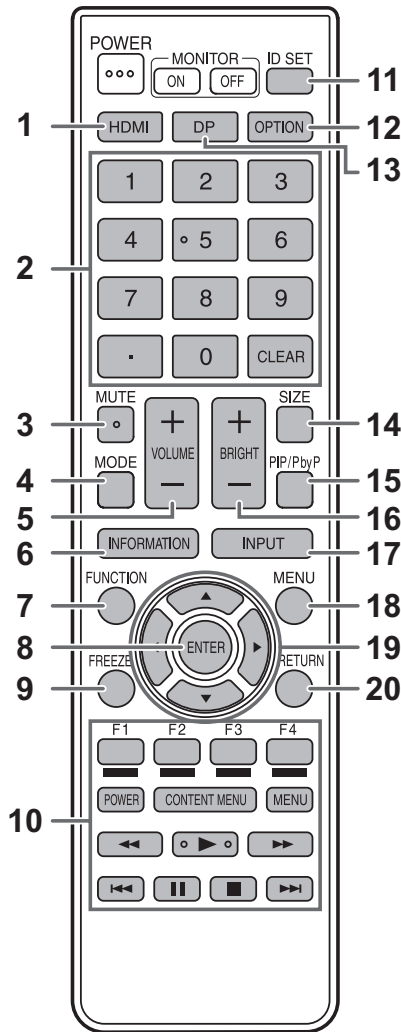

## 1. HDMI

Switch the input mode to HDMI1 or HDMI2.

## 2. Numeric input buttons

When HDMI CEC LINK is set to AUTO, use these buttons to operate the device connected through the HDMI interface. 0 to 9 are also used in conjunction with the ID SET button.

## 3. MUTE

Turns off the volume temporarily. Press the MUTE button again to turn the sound back to the previous level.

## 4. MODE (Color mode selection)

Each time you press this button, the color mode changes in the following order:

STD (Standard) → VIVID → sRGB → HIGH ILLUMINANCE → STD...

- HIGH ILLUMINANCE is a display with colors suited to bright locations.
- sRGB cannot be used when input mode is D-SUB[COMPONENT]. sRGB is international standard of color representation specified by IEC (International Electrotechnical Commission). Color conversion is made in taking account of liquid crystal's characteristics and represents color tone close to its original image.

## 5. VOLUME +/- (Volume adjustment)

Pressing + or - displays the VOLUME menu.



Press + or - to adjust the volume of the sound.

\* If you do not press any buttons for about 4 seconds, the VOLUME menu automatically disappears.

## 6. INFORMATION

Displays monitor information.

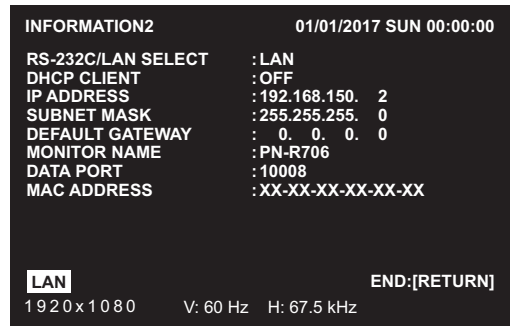
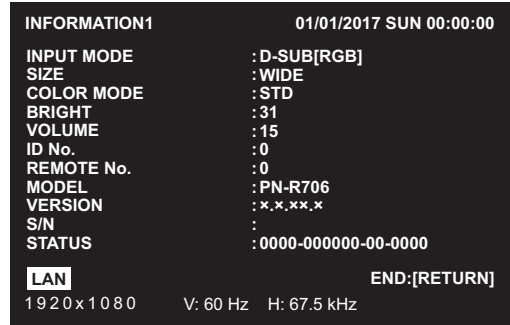

The display changes from INFORMATION1 → INFORMATION2 → INFORMATION3 → clear display, and so on every time you press this button.

- INFORMATION3 shows the information when you have used the expansion slot to expand the functions.
- The display disappears automatically after about 15 seconds.
- [LAN] is displayed during LAN communication.
- If [LAN] is displayed in red, there is a duplicate IP address.

## 7. FUNCTION

Use this to display the FUNCTION menu. (See page 34.)

## 8. ENTER

Confirms the setting.

## 9. FREEZE

This is not used with this monitor.

## 10. Buttons for operating the HDMI-connected device

When HDMI CEC LINK is set to AUTO, use these buttons to operate the device connected through the HDMI interface.

## 11. ID SET

Set a number on the remote control. (See page 33.)

## Basic Operation

### 12. OPTION



Switch the input mode to OPTION.

### 13. DP (DisplayPort)

Switch the input mode to DisplayPort.

### 14. SIZE (Screen size selection)

The menu is displayed.

Press  or  to select the screen size. (See page 21.)

### 15. PIP/PbyP

Each time you press the button, PIP MODES switches in the following order: OFF → PIP → PbyP → PbyP2 → OFF.

### 16. BRIGHT +/- (Brightness adjustment)



Pressing + or - displays the BRIGHT menu.



Press + or - to adjust the brightness.

\* If you do not press any buttons for about 4 seconds, the BRIGHT menu automatically disappears.

### 17. INPUT (Input mode selection)

The menu is displayed. Press  or  to select the input mode, and press the ENTER button to enter.

\* You can select the input mode by pressing the INPUT button of the monitor.

Input mode	Video	Audio
DVI-D	DVI-D input terminal	Audio input terminal
DisplayPort	DisplayPort input terminal	*3
HDMI1	HDMI1 input terminal	
HDMI2	HDMI2 input terminal	
D-SUB[RGB]	D-sub input terminal*2	Audio input terminal
D-SUB[COMPONENT]		
OPTION*1	Expansion slot	*3

\*1 This is displayed when you have used the expansion slot to expand the functions.

\*2 Select the input mode to be used for D-SUB of INPUT SELECT. (See page 26.)

\*3 Select the terminal for AUDIO SELECT which is used for audio input. (See page 26.)

### 18. MENU

Displays and turns off the menu screen. (See page 22.)

### 19. Cursor ( )

These buttons are used to perform operations such as selecting items, changing adjustment values, and moving the cursor.

### 20. RETURN

Returns to the previous screen.

## ■Switching the screen size

Even when the screen size is changed, the display may remain the same depending on the input signal.

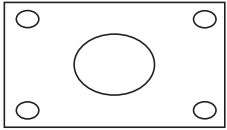
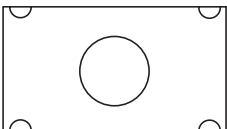
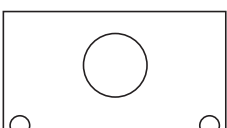
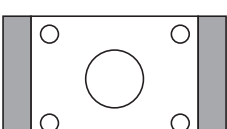
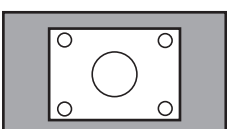
<b>WIDE</b>		Displays image so it fills the entire screen.
<b>ZOOM 1</b>		The image is enlarged to fill the entire screen without changing the aspect ratio. The edges of the image may be cut off.
<b>ZOOM 2</b>		Use this size if ZOOM 1 cuts off the subtitles.
<b>NORMAL</b>		Displays the image so it fills the screen without changing the aspect ratio.
<b>Dot by Dot</b>		Displays the dots of the input signals as the corresponding dots on the screen.

### TIPS

- Using this monitor's screen-size switching to compress or expand the screen for commercial or public viewing in establishments like cafes or hotels may infringe on the rights of the creators, as protected by Copyright Law, so please be careful.
- When "Enlarge" is set, the screen size is fixed to "WIDE" mode.
- When dual-screen display is selected, the screen size cannot be changed.
- The appearance of the original video may change if you select a screen size with a different aspect ratio than the original image (e.g. TV broadcast or video input from external equipment).
- When 4:3 video is viewed with the whole screen using the screen-size switching function of this monitor, the edge of the video may be lost or appear distorted. If you wish to respect the creator's intentions, set the screen size to "NORMAL".
- When playing commercial software, parts of the image (like subtitles) may be cropped. In this case select the optimal screen size using the screen-size switching function of this monitor. With some software, there may be noise or distortion at the edges of the screen. This is due to the characteristics of the software, and is not a malfunction.
- Depending on the original image size, black bands may remain at the edges of the screen.

# Menu Items

## Displaying the menu screen

Video and audio adjustment and settings of various functions are enabled. This section describes how to use the menu items. See pages 23 to 33 for details of each menu items.

### Caution

- Do not turn the main power switch off while the menu items are being displayed. Doing so may initialize the settings.

## Example of operation

(Adjusting CONTRAST in the PICTURE menu)

- Press the MENU button to display the menu screen.

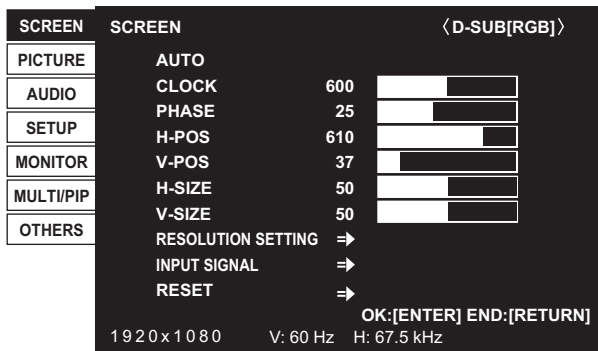

- Press **▲** or **▼** to select PICTURE, and press the ENTER button.

- Press **▲** or **▼** to select CONTRAST.

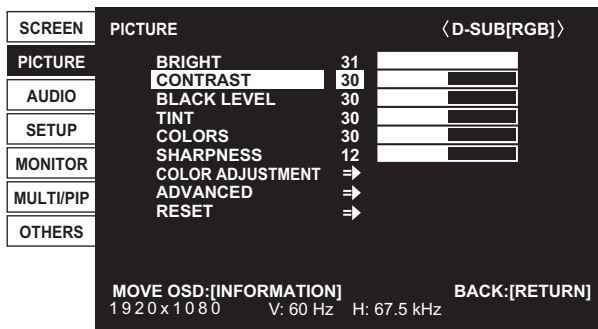

- Press **◀** or **▶** to adjust the setting.

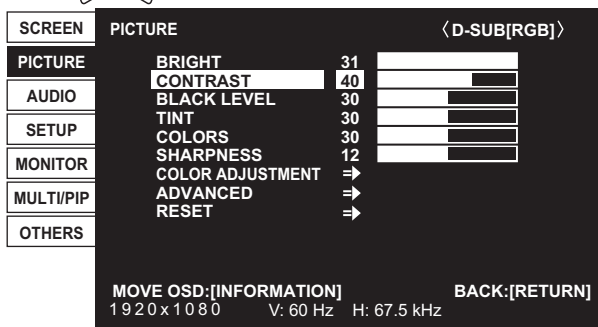

For items that have **⇒**, press the ENTER button to display the sub menu.

- Press the MENU button to close the menu screen.

### TIPS

- The menu will differ depending on the input mode.
- The menu screen will close automatically if no operation is performed for about 15 seconds. (DATE/TIME SETTING, SCHEDULE and LAN SETUP screens will close in about 4 minutes.)

## Menu screen display

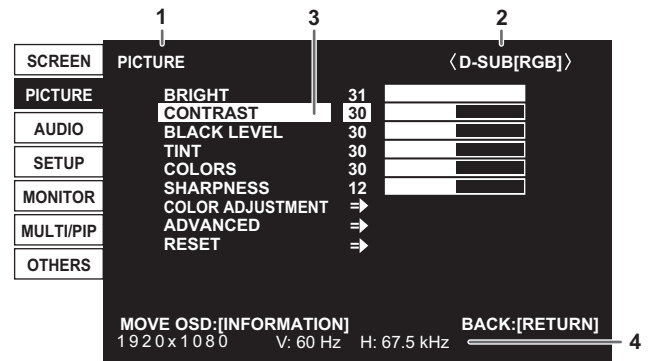

- Name of the menu
- Input mode
- An item being selected (highlighted)
- Screen resolution of input signal, and other data.

### TIPS

- Items that cannot be selected appear in gray. (e.g. Function not supported by the current input signal)

## Menu item details

The menu will differ depending on the input mode.

### ■SCREEN

You can move the menu screen display position each time the INFORMATION button is pressed.

#### **AUTO (D-SUB[RGB])**

The CLOCK, PHASE, H-POS, and V-POS are automatically adjusted.

Pressing the ENTER button performs adjustment. Use this automatic adjustment when you use the D-SUB[RGB] to display a computer screen for the first time or when you change the setting of the computer. (See page 33.)

#### **CLOCK (D-SUB[RGB])**

Adjusts frequency for sampling clock for applicable video.

Adjust when there is flickering in the form of vertical stripes.

When using the adjustment pattern (see page 33), make adjustments so that no vertical stripe noise appears in it.

#### **PHASE (D-SUB[RGB])**

Adjusts sampling clock phase for applicable video. Useful when small characters appear with low contrast and/or there are flickers at corners. When using the adjustment pattern (see page 33), make adjustments so that no horizontal stripe noise appears in it.

\* Adjustments to PHASE should be made only after CLOCK has been correctly set.

#### **H-POS**

Adjust the horizontal position of the image.

#### **V-POS**

Adjust the vertical position of the image.

#### **H-SIZE**

Adjust the horizontal size of the image.

#### **V-SIZE**

Adjust the vertical size of the image.

#### **RESOLUTION SETTING (D-SUB[RGB])**

##### **H-RESOLUTION**

Sets proper horizontal resolution when the resolution of input signals is not recognized properly.  
(Adjustment may be impossible with some signals.)

##### **V-RESOLUTION**

Sets proper vertical resolution when the resolution of input signals is not recognized properly.  
(Adjustment may be impossible with some signals.)

#### **INPUT SIGNAL (D-SUB[RGB])**

If a computer connected to the D-SUB[RGB] outputs any of the following resolutions, make a selection from the following options.

480 LINES .....AUTO, 640x480 or 848x480

768 LINES .....AUTO, 1024x768, 1280x768, or 1360x768

1050 LINES ..... 1400x1050 or 1680x1050

ZOOM2 SPECIAL SETTING (See page 31.)

#### **RESET**

Resets the values of the SCREEN menu items to the factory preset values.

Select ON and then press the ENTER button.

## Menu Items

### ■ PICTURE

You can move the menu screen display position each time the INFORMATION button is pressed.

#### **BRIGHT**

Adjusts the backlight brightness.

#### **CONTRAST**

Adjusts the difference between the bright and dark portions of the image.

#### **BLACK LEVEL**

Adjusts the entire brightness of the video signals.

#### **TINT**

Adjusts the hue. Selecting + changes the color towards green, and selecting - changes it towards magenta.

#### **COLORS**

Adjusts the color intensity.

#### **SHARPNESS**

Adjusts the sharpness of the image.

#### **COLOR ADJUSTMENT**

##### **COLOR MODE**

Changes the color mode on the screen. The color mode on the screen can also be changed using a remote control unit. (See page 19.)

\* sRGB cannot be used when input mode is D-SUB[COMPONENT]. See page 19 for details.

##### **WHITE BALANCE**

THRU ..... Displays the input signal level as is.

PRESET ..... Selects the color temperature using PRESET.

USER ..... Adjusts R-/G-/B-CONTRAST and R-/G-/B-OFFSET respectively using USER.

##### **PRESET**

Selects the color temperature when the WHITE BALANCE is set to PRESET.

The setting values are shown for reference. The color temperature of the screen varies over time. This function is not intended to keep the color temperature constant.

##### **USER**

Adjusts each item when the WHITE BALANCE is set to USER.

R-CONTRAST.... Adjusts bright-toned red component.

G-CONTRAST ... Adjusts bright-toned green component.

B-CONTRAST .... Adjusts bright-toned blue component.

R-OFFSET ..... Adjusts dark-toned red component.

G-OFFSET ..... Adjusts dark-toned green component.

B-OFFSET ..... Adjusts dark-toned blue component.

##### **COPY TO USER**

Copies the value of white set for PRESET to the USER setting.

Select ON and then press the ENTER button.

(In the case other than white, color tone may differ from the PRESET.)

##### **GAMMA**

Selects the gamma. USER sets the gamma to the sent value. (See page 38.)

##### **FLESH TONE**

Adjust the hue control.

##### **C.M.S.-HUE**

Adjusts color tone with 6 colors of R (red), Y (yellow), G (green), C (cyan), B (blue), and M (magenta).

##### **C.M.S.-SATURATION**

Adjusts color vividness with 6 colors of R (red), Y (yellow), G (green), C (cyan), B (blue), and M (magenta).



**ADVANCED****AUTO (D-SUB[RGB])**

The ANALOG GAIN and ANALOG OFFSET are automatically adjusted.

Pressing the ENTER button performs adjustment.

**ANALOG GAIN (D-SUB[RGB])**

Adjusts the bright portions of the video input signal.

**ANALOG OFFSET (D-SUB[RGB])**

Adjusts the dark portions of the video input signal.

**NR**

Reduce the image noise.

Setting a higher level reduces more noise. However, it may cause blurring on an image.

**RGB INPUT RANGE (DVI-D/HDMI/D-SUB[RGB]/DisplayPort/OPTION)**

Sets the RGB input signal range.

When using HDMI, DisplayPort or OPTION set to AUTO, the RGB input signal is detected automatically. Use AUTO normally.

If the RGB input signal range cannot be set appropriately even when using AUTO, set according to the image. When the setting is different, images will be displayed with washed out blacks and compressed gradients.

**DISPLAY COLOR PATTERN**

Displays a color pattern. Can be displayed while the menu screen is displayed, so you can refer to the pattern while adjusting the image. When WHITE, RED, GREEN, or BLUE is displayed, you can set the level in the range of 0 to 255.

OFF .....No pattern display.

WHITE.....White single color pattern display.

RED.....Red single color pattern display.

GREEN .....Green single color pattern display.

BLUE.....Blue single color pattern display.

USER .....Red/green/blue mixed color pattern display. When USER is selected, set each color's level.

**RESET**

Resets the values of the PICTURE menu items to the factory preset values.

Select "ON" and then press the ENTER button.

**■AUDIO****TREBLE**

Adjusts the volume of treble-level sound.

**BASS**

Adjusts the volume of bass-level sound.

**BALANCE**

Adjusts the balance of the audio sound between right and left.

**RESET**





Resets the values of the AUDIO menu items to the factory preset values.

Select ON and then press the ENTER button.

## Menu Items

### ■SETUP

#### DATE/TIME SETTING

Set the date and time. Press  or  to select the date and time, and press  or  to change the numerical values.

Set the date in "Day/Month/Year" order.

Set the time on a 24-hour basis. (Factory default)

#### DATE/TIME FORMAT

Sets the date/time display format.

DATE .....MM/DD/YYYY, DD/MM/YYYY, YYYY/MM/DD  
(YYYY: Year, MM: Month, DD: Day)

TIME .....Select 12- or 24-hour time.

#### SCHEDULE (See page 32.)

You can turn the power on/off and change the screen brightness at a specified time.

#### LANGUAGE

Sets the display language for the menu screen.

#### INPUT SELECT

##### D-SUB

Select the input mode to be used in D-sub input terminal.

##### HDMI CEC LINK

AUTO .....Use the HDMI CEC function.

If the device connected to the HDMI input terminal supports CEC, the input mode of the monitor changes to HDMI when playback starts on the device.

OFF .....HDMI CEC function is not used.

##### AUTO POWER ON

This can be set when HDMI CEC LINK is set to AUTO.

If the device connected to the HDMI input terminal supports CEC, you can specify whether or not the monitor power turns on when the device power is turned on.

##### HDMI AUTO VIEW

When ON is selected, the screen size is adjusted automatically according to the screen size control signal included in the video signal input from the HDMI1 and HDMI2 input terminals or the expansion slot (when the expansion function is used).

##### HOT PLUG CONTROL

Sets whether to use hot plug control for the DVI-D, HDMI1 and HDMI2 input terminals, and the expansion slot (when the expansion function is used).

##### DisplayPort STREAM

Selecting MST (Multi Stream Transport) allows different images to be displayed when daisy chaining two devices through the monitor's DisplayPort. Image may not be displayed properly depending on the computer (video card) to be connected.

##### DisplayPort SETTING

Sets FILTER SETTING, GAIN, and OFFSET for the signal from the DisplayPort input terminal.

#### AUDIO SELECT

Selects the terminal used to input audio signals in each input mode.

#### AUDIO OPTION

##### AUDIO OUTPUT

Sets the volume of sound output from the audio output terminal.

VARIABLE1 ..... You can adjust the volume from the speakers of this monitor and the audio output terminal simultaneously by using VOLUME.

VARIABLE2 ..... You can adjust the volume from the audio output terminal by using VOLUME.  
Sound will not be output from the speakers of this monitor.

FIXED ..... Fixes the volume from the audio output terminal. Adjust the volume by using an external device.  
You can adjust the volume from the speakers of this monitor by using VOLUME.

##### AUDIO INPUT LEVEL

Selects the maximum audio input level of the audio input terminal.

##### MONAURAL AUDIO

Outputs audio signals as monaural.

**START INPUT MODE**

You can set the input mode that will be in effect when the power is turned on.  
When this is set to LAST INPUT MODE, the input mode when the power was last turned off will appear.

**COMMUNICATION SETTING****RS-232C/LAN SELECT**

Selects the method with which to control the monitor from the computer.

**BAUD RATE**

Selects the communication speed used for RS-232C communication.

**LAN SETUP**

Configures the settings to control the monitor from the computer via LAN. (See page 47.)

**AUTO ASSIGN FIXED IP ADDR.**

Can be enabled when RS-232C/LAN SELECT is LAN and the DHCP CLIENT is OFF.

Set DHCP CLIENT to OFF for the monitor connected to the RS-232C output terminal and the daisy chain of connected monitors that follows. Fixed IP addresses are automatically allocated.

If the IP address is a duplicate with a network device other than a monitor, individually change the IP address.

**Crestron Connected**

Select this when using a Crestron device. When this function is set to ON, the monitor can be controlled via network using equipment and application software of Crestron Electronics, Inc. This monitor supports application software RoomView from Crestron Electronics, Inc. This is a function to connect a system developed by Crestron Electronics, Inc. which manages and controls multiple system devices connected to the network.

For details of Crestron Connected, refer to the Crestron Electronics, Inc. website. (Provided only In English.)

<http://www.crestron.com/>

For the download of RoomView Express, refer to the Crestron Electronics, Inc. website. (Provided only in English.)

<http://www.crestron.com/getroomview>

**ID SETTING****ID No. SET**

Assigns ID numbers to monitors connected in a daisy chain (see page 35), using the RS-232 cables.

The numbers 1 to 255 are available for ID numbers.

If "0" is set, the system regards this as the state where no ID number is set.

**AUTO ASSIGN ID No.**

ID No. to be used will be automatically assigned when multiple monitors are connected with RS-232C.

Select ON, then press the ENTER button.

Perform operations using the first monitor in the daisy chain.

**REMOTE No.**

Sets the number of the remote control. (See page 33.)

**COPY SETTING VALUE**

When the monitor has been connected to multiple monitors by RS-232C, the settings in the monitor can be copied to the monitor connected to the RS-232C output terminal and to the daisy chain of connected monitors that follows.

Selects the settings to copy with COPY SETTING VALUE TARGET.

"PICTURE" ONLY ..... Copies the PICTURE menu settings.\*

ALL ..... Copies all the settings.\*

Select the ID No. of the monitor that you would like copy to with COPY TO ID No., then select COPY and press the ENTER button.

If you select ALL, settings will be copied to all monitors.

When you would like to confirm the ID No. that is set to the monitor, select ID No. DISPLAY and press the ENTER button. The ID No. will be displayed on the screen.

\* Certain setting details such as ANALOG GAIN, ANALOG OFFSET, and DISPLAY COLOR PATTERN cannot be copied.

**SUPPLY USB POWER**

ALWAYS .....The power can be supplied all the time, which increases the power consumption in the Standby mode/ Input signal waiting mode.

POWER ON ONLY ...The power is supplied while the monitor is turned on. The power supply stops in the Standby mode/Input signal waiting mode.

### ■MONITOR

#### PORTRAIT/LANDSCAPE INSTALL

LANDSCAPE .....Landscape orientation

PORTRAIT .....Portrait orientation

#### HORIZONTAL INSTALLATION

OFF .....Portrait/landscape installation

UPWARD.....The display screen faces up.

DOWNWARD .....The display screen faces down.

#### ROTATE 180°

If video is upside down when the monitor is installed in portrait orientation, you can rotate the video 180 degrees.

Interlaced signals may not be displayed properly.

#### OSD H-POSITION

Adjusts the horizontal display position of menu screen.

#### OSD V-POSITION

Adjusts the vertical display position of menu screen.

#### OPERATION MODE

MODE1.....OFF IF NO OPERATION is set to ON, and POWER SAVE MODE is set to ON.

(These settings can not be changed.)

MODE2.....Will perform standard operation. OFF IF NO OPERATION is set to OFF, and POWER SAVE MODE is set to OFF.

These settings can be changed.

#### POWER SAVE MODE

When OFF is selected, startup time from standby mode is reduced. Note, however that, more power will be consumed in standby mode.

When ON is selected, current consumption is reduced while the monitor is in standby mode. Note, however, that the startup time from standby mode becomes longer.

If set to ON, certain RS-232C commands cannot be used in standby mode, and control via LAN will be disabled. (See pages 35 and 47.)

#### OFF IF NO OPERATION

Determines whether or not to set the monitor to go into standby mode when there is no operation from the remote control unit, RS-232C commands, or LAN.

When the setting is ON, set the time until standby mode is entered in TIME.

#### POWER ON DELAY

When ON is set, you can delay the screen display after the monitor is turned on.

When ON is selected, set the delay time with INTERVAL (interval can be set up to 60 seconds in units of 1 second).

When this function is activated, the power LED flashes (at approx. 0.5 second interval) in green.

#### SELF ADJUST

On a D-SUB[RGB] screen, specify whether to perform screen adjustment automatically or not.

When ON is selected, the screen is automatically adjusted when its resolution is 800 x 600 or higher and the timing of input signals changes. "ADJUSTING" appears on the screen during the adjustment.

If SELF ADJUST is set to ON, set the time it takes to start the SELF ADJUST function in START TIMING.

For images with black edges, etc., depending on the signal, adjustment may not be possible. In this case select OFF. (Perform manual adjustment of the screen.)

**■MULTI/PIP****MULTI****ENLARGE (See page 31.)**

Sets whether or not to use the enlarge function.

**ADVANCED (ENLARGE)**

ENLARGE H / ENLARGE V

.....Sets the number of screen splits (number of monitors) in the horizontal/vertical direction used for the enlargement.

ENLARGE-POS

.....Specify the split screen to be displayed when the enlargement function is used.

H-POS / V-POS

.....Adjust the horizontal/vertical position of the enlarged screen.

**BEZEL ADJUST**

Sets whether or not to use the frame correction function.

**ADVANCED (BEZEL ADJUST)**

BEZEL ADJUST (TOP) / BEZEL ADJUST (BOTTOM) / BEZEL ADJUST (RIGHT) / BEZEL ADJUST (LEFT)

.....Adjusts so that the top/bottom/left/right connecting joints of grouped units will be displayed smoothly when a group of monitors are aligned in multiples to display a single image.

BEZEL (TOP) / BEZEL (BOTTOM) / BEZEL (RIGHT) / BEZEL (LEFT)

.....Sets the frame width of the display.

**PIP/PbyP****PIP MODES**

Sets the display method.

OFF ..... Displays one screen.

PIP ..... Displays a sub screen inside a main screen.

PbyP ..... Displays a main screen and a sub screen in a line.

PbyP2 ..... Displays a main screen which measures 1280 pixels in the longest direction and a sub screen in a line.

**PIP SIZE**

Sets the size of the sub screen in PIP mode.

**PIP H-POS**

Adjusts the horizontal position of the sub screen in PIP mode.

**PIP V-POS**

Adjusts the vertical position of the sub screen in PIP mode.

**PIP BLEND**

In PIP mode, use this menu item to display the sub screen transparently.

**PIP SOURCE**

Selects the input signal of the sub screen in PIP, PbyP, or PbyP2 mode.

**SOUND CHANGE**

Sets the sound which is output in PIP, PbyP, or PbyP2 mode.

**MAIN POS**

Sets the position of the main screen in PbyP or PbyP2 mode.

**PbyP2 POS**

Sets the position of the sub screen in PbyP2 mode.

## OTHERS

### SCREEN MOTION

#### PATTERN

Residual images are reduced by moving the screen.

OFF ..... SCREEN MOTION function is disabled.

PATTERN1 ..... The whole screen moves vertically and horizontally.

PATTERN2 ..... A black screen spreads from the bottom of the screen and then shrinks to the bottom of the screen. If the monitor is installed in the portrait orientation, a black screen spreads from the right end of the screen and then shrinks to the right end of the screen.

PATTERN3 ..... A black bar moves from the left end to the right end of the screen. If the monitor is installed in the portrait orientation, a black bar moves from the bottom to the top of the screen.

PATTERN4 ..... Black screens appear from both sides of the screen, and the displayed image is compressed into the central field. If the monitor is installed in the portrait orientation, the screen is compressed from the top and bottom ends.



#### MOTION TIME 1

Specify a time period (operating interval) until SCREEN MOTION starts.

#### MOTION TIME 2

Specify a time period during which SCREEN MOTION operates (time period during which the screen will move).

### POWER MANAGEMENT

POWER MANAGEMENT determines whether or not to switch modes from no signal to the input signal waiting mode.

#### CONNECT AUTO INPUT SELECT

Sets whether the input into the input terminal automatically changes when a video signal is input into that terminal. The input via the expansion slot is ignored.

(With some input signals, the input may not change.)

#### NO SIGNAL AUTO INPUT SEL.

Specify whether to change inputs automatically. When ON is selected and no signal is present in the selected input mode, the monitor automatically changes the selected mode to another mode where a video signal is present.

When there are video signals in multiple input modes, switching takes place according to the order of priority set in AUTO INPUT SELECT PRIORITY.

#### AUTO INPUT SELECT PRIORITY

Sets the order of input terminal priority for NO SIGNAL AUTO INPUT SEL..

When an option that supports this function is connected to the expansion slot, you can set the order in OPTION.

(If the option does not support this function, "OPTION" will not appear.)

Input does not change automatically for terminals without a priority setting.

#### LOGO SCREEN

Sets whether or not to display the logo screen.

#### SCAN MODE (HDMI1/HDMI2/D-SUB[COMPONENT]/OPTION)

Sets the scan mode used for video input.

MODE1 ..... Over-scan display

MODE2 ..... Under-scan display

MODE3 ..... Under-scan display when the input signal is 1080i/p. Otherwise, over-scan display

\* Even when MODE1 is selected, under-scan display is used when the input signal is 1080i/p and the screen size is Dot by Dot.

#### VOLUME

Adjusts the volume.

#### MUTE AUDIO

Temporarily mutes the audio.

#### TIPS

- When WHITE BALANCE is set to THRU, BLACK LEVEL, CONTRAST, TINT, COLORS, GAMMA, PRESET, USER, FLESH TONE, C.M.S.-HUE, C.M.S.-SATURATION and COPY TO USER cannot be set.
- If COLOR MODE is set to sRGB, the following items cannot be set. WHITE BALANCE, PRESET, USER, COPY TO USER, and GAMMA
- When the COLOR MODE is set to VIVID or HIGH ILLUMINANCE, GAMMA cannot be adjusted.
- When SUPPLY USB POWER is set to ALWAYS, you cannot set POWER SAVE MODE to ON.
- When displaying the color pattern, it is possible to adjust certain items of the PICTURE menu. Non-adjustable items cannot be selected.
- CONNECT AUTO INPUT SELECT and NO SIGNAL AUTO INPUT SEL. do not work for the Sync-on-green signal of D-SUB[RGB] or the signals of D-SUB[COMPONENT].

## ■Dual screen display

You can display two screens simultaneously. Set this function with PIP MODES of PIP/PbyP in the MULTI/PIP menu.

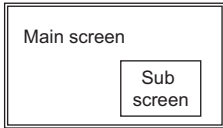
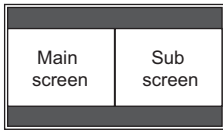
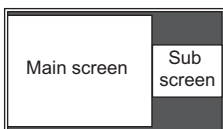
<b>PIP</b>		A sub screen is displayed inside a main screen.
<b>PbyP</b>		A main screen and a sub screen are displayed in a line.
<b>PbyP2</b>		Displays a main screen which measures 1280 pixels in the longest direction and a sub screen in a line.

- \* The currently selected input signal is displayed on the main screen.
- \* The following combinations are available for display:
  - DisplayPort - DVI-D
  - DisplayPort - HDMI1 or HDMI2
  - DisplayPort - D-SUB[RGB]
  - DisplayPort - D-SUB[COMPONENT]
  - DisplayPort - OPTION
  - DVI-D - D-SUB[RGB]
  - DVI-D - D-SUB[COMPONENT]
  - HDMI1 or HDMI2 - D-SUB[RGB]
  - HDMI1 or HDMI2 - D-SUB[COMPONENT]
  - D-SUB[RGB] or D-SUB[COMPONENT] - OPTION

### TIPS

- You might infringe on a copyright of the author which is protected by copyright law when you display the images of the computer screen and television/VCR simultaneously for profit-making or to show the image to the public.
- The screen size for dual-screen display is the same as the screen size for single-screen display. The Dot by Dot screen is displayed in NORMAL size except when it is set as the PIP main screen.
- When dual-screen display is selected, the SCREEN MOTION function is disabled.
- When dual-screen display is selected, the CONNECT AUTO INPUT SELECT function and NO SIGNAL AUTO INPUT SEL. function are disabled.
- When dual-screen display is selected, the screen cannot be enlarged.
- When dual-screen display is selected, D-SUB of the INPUT SELECT options cannot be set.
- When dual-screen display is selected and an interlaced signal (1080i, 480i) is input to the main or sub screen, the image is not displayed properly.
- When dual-screen display is selected, you cannot set TREBLE, BASS, or BALANCE on the AUDIO menu.
- When a signal of 3840×2160 or 4096×2160 is input to the sub screen, the sub screen does not display an image.
- When DisplayPort STREAM is set to MST or when ROTATE 180° is set to ON, you cannot set PIP MODES to PIP, PbyP, or PbyP2.
- When HDMI CEC LINK is set to AUTO, SOUND CHANGE on the PIP/PbyP menu may be changed to MAIN due to the switching of the monitor's input or due to the operation of the HDMI-connected device.

## ■Enlarge

- You can align several monitors and integrate them into a single large screen to display.
- Up to 5 monitors can be aligned in both the horizontal and vertical directions.
- Each monitor displays enlarged views of separated images.

(Example)

Horizontal direction: 2 monitors

Vertical direction: 2 monitors

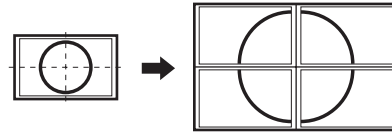



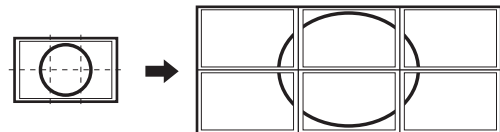

Horizontal direction: 3 monitors

Vertical direction: 2 monitors



### Setting procedure

Set using MULTI in the MULTI/PIP menu.

1. Set **ENLARGE** to **ON**.
2. Select **ADVANCED (ENLARGE)**.
3. Set the number of monitors aligned in the horizontal direction in **ENLARGE H**.
4. Set the number of monitors aligned in the vertical direction in **ENLARGE V**.
5. Set the section of the separated image to be displayed on each monitor in **ENLARGE-POS**.
  - 1) Press the **ENTER** button.
  - 2) Press , ,  or  to select position, then press **MENU** button.

### TIPS

- When Enlarge is used, the SCREEN MOTION function is disabled.
- When Enlarge is used, the CONNECT AUTO INPUT SELECT function and NO SIGNAL AUTO INPUT SEL. function are disabled.
- When Enlarge is used, the HDMI AUTO VIEW function is disabled.

## ■ZOOM2 SPECIAL SETTING

If you connect a laptop computer with any of the following screen resolutions and black bands appear around the screen, set ZOOM2 SPECIAL SETTING of INPUT SIGNAL on the SCREEN menu to ON and then select ZOOM2 in the SIZE setting.

This displays the area inside the black band.

Laptop computer resolution	Corresponding signal*1
1280x800	1280x1024, 1280x960, 1400x1050*2
1280x600	1280x720
1024x600	1024x768

\*1: This setting is effective only when the screen resolution, including the black band, is one of the resolutions listed above.

\*2: Use the automatic screen adjustment.

## ■ SCHEDULE

You can set the time to switch the monitor on and off.  
Set this function with SCHEDULE in the SETUP menu. (See page 26.)

SCHEDULE						<D-SUB[RGB]>
No.	(1) POWER	(2) DAY OF THE WEEK	(3) TIME	(4) INPUT	(5) BRIGHT	(6)
1	●	---	--:--	---	---	---
2	●	---	--:--	---	---	---
3	●	---	--:--	---	---	---
4	●	---	--:--	---	---	---
5	●	---	--:--	---	---	---
6	●	---	--:--	---	---	---
7	●	---	--:--	---	---	---
8	●	---	--:--	---	---	---

OK:[ENTER] CANCEL:[RETURN]

- Press or to select the SCHEDULE number, and press .
- Set the SCHEDULE. (See the description below.)  
Press or to select items, and press or to change the setting.
- Press the ENTER button.  
SCHEDULE becomes effective.

### (1)

- : SCHEDULE effective
- : SCHEDULE not effective

### (2) POWER

ON: Switches the monitor on at the specified time.  
OFF: Switches the monitor off at the specified time and puts the monitor in standby mode.

### (3) DAY OF THE WEEK

Specifies the day of the week to execute the SCHEDULE.  
0: ONLY ONCE  
Executes the SCHEDULE once on the specified day.  
Specify the day of the week to execute the SCHEDULE.  
1: EVERY WEEK  
Executes the SCHEDULE on the specified day of the week every week. Specify the day of the week to execute the SCHEDULE.  
Periodic setting such as “Monday through Friday” is also possible.  
2: EVERY DAY  
Executes the SCHEDULE every day regardless of the day of the week.

### (4) TIME

Specifies the time to execute the SCHEDULE.  
Set the time on a 24-hour basis. (Factory default)  
Can be entered as 12-hour time using the TIME setting in DATE/TIME FORMAT.

### (5) INPUT

Specifies the input mode at power-on. If you don't specify this the input active at the last power-off will appear.  
When START INPUT MODE is set to a value other than LAST INPUT MODE, the input mode configured for START INPUT MODE will be set.  
Input modes displayed on D-SUB will depend upon the INPUT SELECT settings.

### (6) BRIGHT

Sets the brightness when changing the screen brightness at a specified time.

### ! Caution

- Do not switch off the main power after setting the SCHEDULE.
- Specify the correct date and time. (See page 26.)  
SCHEDULE does not function unless the date and time are specified.
- Check regularly that the set date and time are correct.
- When a temperature abnormality occurs and the backlight brightness is reduced, the brightness is not changed even if a schedule set to BRIGHT is executed.

### TIPS

- Up to 8 SCHEDULE items can be registered.
- Setting the SCHEDULE flashes the power LED alternately in red and orange in standby mode.
- A SCHEDULE that has a large number has precedence over that of a small number when schedules overlap.



## ■About remote control numbers



If there is the chance that you will operate the wrong set from the remote control, you can prevent this from happening by changing the remote control numbers to different values in advance. You have to make changes on the monitor and on the remote control.

### TIPS

- You can set remote control numbers to values from 0 to 9.
- When the remote control batteries become exhausted and when you replace the batteries, the number on the remote control may be reset to 0.

### Changing the remote control number on the monitor

Use REMOTE No. on the SETUP menu to set the number. (See page 27.)

1. Use   to select the remote control number.
2. Select ON and press the ENTER button.

The remote control number is set on the monitor.

### Changing the remote control number on the remote control

1. While holding down the ID SET button, hold down the number that corresponds to the remote control number set on the monitor for 5 seconds or more, and then release these buttons.

The remote control number is set on the remote control.

### Checking the remote controller number

1. Press the INFORMATION button to display INFORMATION1.
2. Check that REMOTE No. is the remote control number that you have set in the above procedure.
3. Press the RETURN button to close the monitor INFORMATION screen.



### TIPS

- If the remote control numbers on the monitor and remote control are different, they will both be displayed on INFORMATION1. On this screen, you can press the ENTER button to match the number on the monitor with the number on the remote control.
- Even if the remote control numbers are different, you can use the remote control to display the INFORMATION screen.

## Adjustments for computer screen display

### ■Automatic adjustment

When you use the D-SUB[RGB] to display a computer screen for the first time, or when you change the setting of the computer, use the automatic screen adjustment.

1. Switch the input to D-SUB[RGB] and display the adjustment pattern. (See the description below.)
2. Press the MENU button and use  or  to display the SCREEN menu.
3. Press the ENTER button and select "AUTO".
4. Press the ENTER button.  
The automatic adjustment is complete in several seconds.
5. Press the MENU button to close the menu screen.

### TIPS

- If the screen cannot be adjusted properly with one automatic adjustment, repeat the automatic adjustment two or three times. Try manual adjustment if necessary.

### ■Screen display for adjustment

Before making adjustments in the SCREEN menu or PICTURE menu, display an image to brighten the entire screen. If you are using a Windows computer, use the adjustment pattern on the supplied CD-ROM.

#### Opening the adjustment pattern

The following example is performed in Windows 7.

1. Load the supplied CD-ROM into the computer's CD-ROM drive.
2. Open [CD Drive] in [Computer].
3. Double-click [Adj\_uty.exe].

The adjustment pattern will appear.

Adjust the screen automatically or manually.

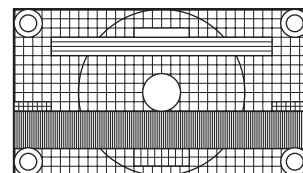

4. When adjustment is finished, press the [Esc] on the computer's keyboard to quit the adjustment program.
5. Eject the CD-ROM from the CD-ROM drive.

### TIPS

- If the display mode on the computer you are using is 65,000 colors, the color levels in the color pattern may appear differently or grayscale may appear to be colored. (This is due to the specifications of the input signal and is not a malfunction.)

# Initialization (Reset)/Functional Restriction Setting (FUNCTION)

You can reset the settings to the factory default settings or restrict operations.

1. Press the **FUNCTION** button, and then press the **MENU** button within 10 seconds.

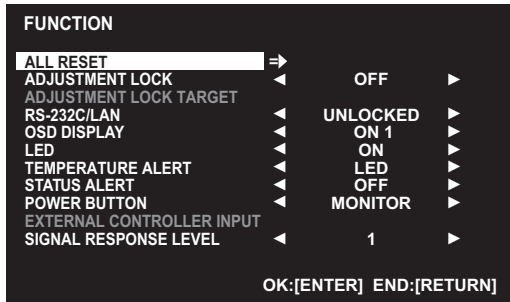

2. Select and set the items.

## ALL RESET

Resets the settings to the factory default settings.

Press the ENTER button, select the resetting method, and then press the ENTER button.

After initialization, turn the main power switch off and then back on.

ALL RESET1 ....Resets all the settings to the factory default settings.

ALL RESET2 ....Returns all settings to the factory default settings except for the following items:  
LAN SETUP, RS-232C/LAN SELECT, ID No. SET, REMOTE No., BAUD RATE, NETWORK, MAIL, SERVICE & SUPPORT, and SNMP (See page 27, and pages 51 to 54.)

## ADJUSTMENT LOCK

You can disable operations on the monitor and the remote control unit that use buttons.

OFF ... Enables operation.

ON 1 .. Disables all operations other than turning power on/off and FUNCTION.

ON 2 .. Only the FUNCTION operation is enabled.  
Disables all operations other than FUNCTION (not even power on/off).

## ADJUSTMENT LOCK TARGET

Sets the target to prohibit operation of with ADJUSTMENT LOCK.

REMOTE CONTROL..... Prohibits remote control operation

MONITOR BUTTONS ... Prohibits monitor button operation

BOTH..... Prohibits remote control and monitor button operation

## RS-232C/LAN

Specifies whether to allow control via RS-232C or LAN. (See pages 35 and 47.)

## OSD DISPLAY

Shows/hides the menu, modes and messages.

The FUNCTION screen cannot be hidden.

ON 1 ..... Shows all menus, modes and messages.

ON 2 ..... Hides messages automatically displayed by the display. Shows messages during operation.

OFF ..... Hides all menus, modes and messages.

## LED

Specifies whether to light the power LED.

## TEMPERATURE ALERT

Selects the notification method for an abnormal temperature.

OFF ..... Do not notify about an abnormal temperature.

OSD & LED .. When an abnormal temperature is detected, the power LED flashes in red and green alternately and the screen displays a message: TEMPERATURE.

LED..... When an abnormal temperature is detected, the power LED flashes in red and green alternately.

## STATUS ALERT

Selects the notification method for a hardware error.

OFF ..... Do not notify about the error.

OSD & LED .. When a hardware error is detected, the power LED flashes in red and the screen displays a message: STATUS [xxxx].

LED..... When a hardware error is detected, the power LED flashes in red.

## POWER BUTTON

Normally, leave this setting as MONITOR.

When using an optional part, if instruction appears, change the setting accordingly.

## EXTERNAL CONTROLLER INPUT

Normally, you do not need to change this setting.

When using an optional part, if instruction appears, change the setting accordingly.

## SIGNAL RESPONSE LEVEL

Normally, you do not need to change this setting. Use this option to set the level of response to signal changes.

3. Press the **RETURN** button to return to the normal screen.

## TIPS

- When both abnormal temperature and hardware error are detected, the hardware error notification overrides.
- If TEMPERATURE ALERT or STATUS ALERT is set to OSD&LED, alert messages will appear even if the OSD DISPLAY is set to ON 2 or OFF.
- If TEMPERATURE ALERT or STATUS ALERT is set to LED or OSD & LED, the LED lights even if the LED function is set to OFF.

# Controlling the Monitor with a PC (RS-232C)

You can control this monitor from a PC via RS-232C (COM port) on the PC.

You can also connect multiple monitors via a daisy chain by using a PC. By assigning ID numbers to each monitor (see page 36), you can make input mode selection/adjustment or can check the status of a specific monitor.

## TIPS

- To control the monitor via RS-232C, set RS-232C/LAN SELECT to RS-232C.
- You cannot use RS-232C and LAN control simultaneously.

## PC connection

### ■ One-to-one connection with a PC

Connect with RS-232 straight cable between the PC's COM port (RS-232C connector) and the RS-232C input terminal on the monitor.

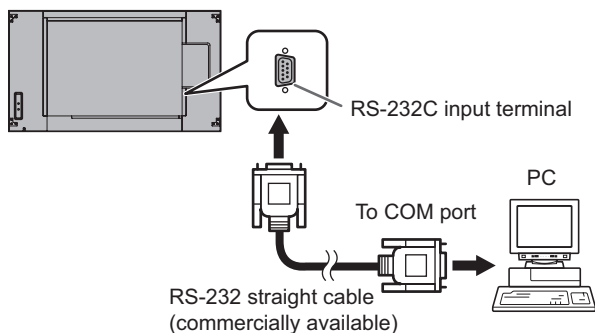

### ■ Daisy chain connection... Advanced operation

Connect with RS-232 straight cable between the PC's COM port (RS-232C connector) and the RS-232C input terminal on the first monitor.

Next, connect RS-232 straight cable to the first monitor's RS-232C output terminal and to the second monitor's RS-232C input terminal. Connect in the same way to the third and subsequent monitors.

Up to 25 monitors can be connected. (Depending on the length of the cable used and the surrounding environment.)

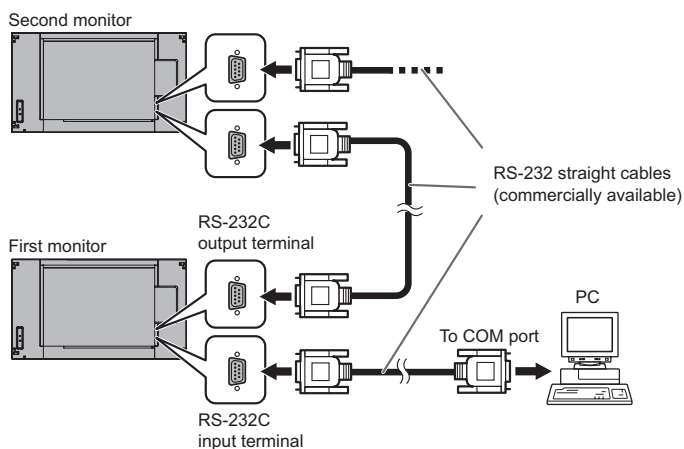

## Communication conditions

Set the RS-232C communication settings on the PC to match the monitor's communication settings as follows:

Baud rate	*	Stop bit	1 bit
Data length	8 bits	Flow control	None
Parity bit	None		

\* Set to the same baud rate as the BAUD RATE setting of SETUP menu. (Initial setting: 38400 bps)

\* When connecting multiple monitors in a daisy chain, set all monitors to the same BAUD RATE.

## Communication procedure

### ■ Command format

When a command is sent from the PC to the monitor, the monitor operates according to the received command and sends a response message to the PC.

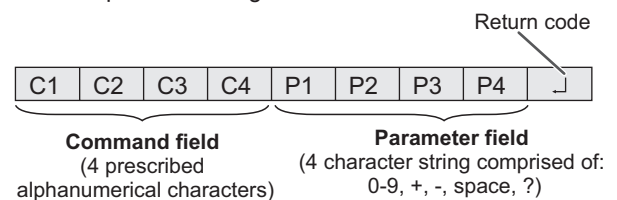

Example: VOLM0030  
VOLM \_ \_ 30

\* Be sure to input 4 characters for the parameter. Pad with spaces (" ") if necessary.

(" " is a return code (0DH, 0AH or 0D))

Wrong : VOLM30

Right : VOLM \_ \_ 30

When inputting a negative value, specify a numerical value in three digits.

Example: AUTC-005

Do not use spaces for MPOS, DATE, SC01 through SC08, UGRW, UGGW, and UGBW. Specify parameters using a specified number of characters.

Example: MPOS010097

If a command has "R" listed for "Direction" in the "RS-232C command table" on page 39, the current value can be returned by using "?" as the parameter.

Example:

VOLM ? ? ? ? ← From PC to monitor (How much is current volume setting?).

30 ← From monitor to PC (Current volume setting: 30).

\* If an ID number (see page 36) has been assigned (For example, ID number = 1).

VOLM \_ \_ \_ ? ← From PC to monitor.

30 \_ 001 ← From monitor to PC.

# Controlling the Monitor with a PC (RS-232C)

## Response code format

When a command has been executed correctly

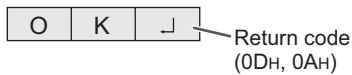

A response is returned after a command is executed.

\* If an ID number has been assigned

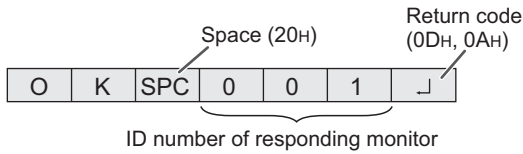

When a command has not been executed



\* If an ID number has been assigned

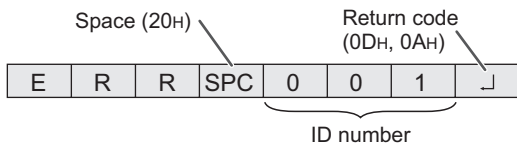

### TIPS

- “ERR” is returned when there is no relevant command or when the command cannot be used in the current state of the monitor.
- If communication has not been established for reasons such as a bad connection between the PC and monitor, nothing is returned (not even ERR).
- “ERR” may be returned when a command cannot be received correctly due to interference from the surrounding environment.  
Please ensure that the system or software retries the command if this occurs.
- If no monitor has been assigned the designated ID number (e.g. if the command IDSL0002  is used, but no monitor with ID number: 2 is found), no response is returned.

If execution of the command is taking some time



When the following commands are used, “WAIT” is returned. In this case, a value will be returned if you wait a while. Do not send any command during this period.

No ID number is attached to WAIT response.

- Commands which return WAIT:
  1. When repeater control is used
  2. When an IDSL or IDLK command is used
  3. When one of the following commands is used: RSET, INPS, ASNC, WIDE, EMAG, EPOS, PXSL, POWR, AGIN, MWIN, MWIP, MWPP, ESTG, EMHV, EPHV, ESHV, ENLG, DPST

When control via RS-232C is locked (to prevent use) using the operation lock function (see page 34)



When RS-232C/LAN SELECT is set to LAN

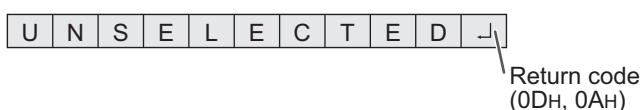

## Communication interval

- After OK or ERR is returned, you must send the following commands.

To set a timeout for the command response, specify 10 seconds or longer.

When connecting multiple monitors in a daisy chain, set the timeout to at least the product of the monitor’s position from the computer multiplied by 10 seconds.

Example) 3rd monitor from computer: 30 seconds or longer.

- Provide an interval of 100 ms or more between the command response and the transmission of the next command.

VOLM0020

OK

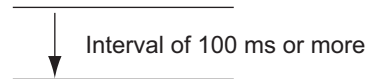

INPS0001

WAIT

OK

### TIPS

- When executing ALL RESET, set the timeout period to 30 seconds or longer.
- When turning the power on while the POWER ON DELAY function is in use, set the timeout period to the POWER ON DELAY period + 10 seconds or longer.

### Advanced operation

This section explains commands for daisy chain connection. The basic communication procedure is the same as in the “One-to-one connection with a PC” section.

## ID numbers

You can assign a unique ID number to each monitor. (See page 27.) This allows you to control a particular monitor in a daisy chain of monitors.

You can assign ID numbers either from the menu screen or from the PC using RS-232 cable.

[Example]

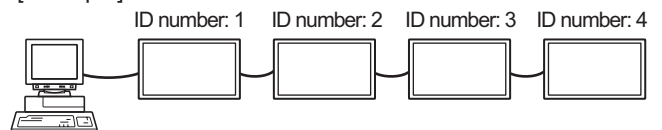

If monitors are connected as shown above, you can execute commands like “Set the volume of the monitor with ID 4 to 20”.

When designating ID numbers for a set of monitors linked in a daisy chain, you should basically avoid any duplication of ID numbers.

ID numbers do not have to be assigned in ascending order starting from the PC. They can also be connected as shown below.

[Example]

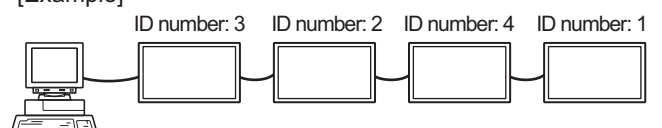

## ■ Commands for ID control

The command examples shown on this page assume the following connection and ID number set up.

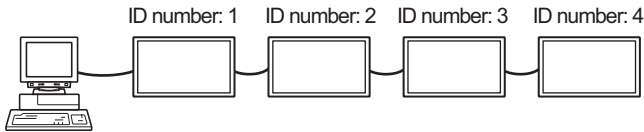

**IDST** .....A monitor receiving this command sets its own ID number in the parameter field.

Example:

```
IDST0001
OK _ 001 ← The ID number of this monitor is set to 1.
```

### TIPS

You can automatically assign ID numbers by using the IDST command with the Repeater control (see "Repeater control" on page 38).

For example, using the command "IDST001+" automatically sets the ID numbers, as shown below.

[Example]

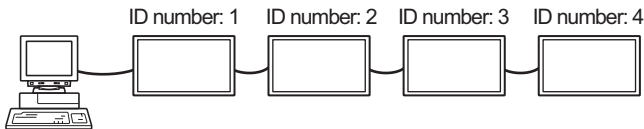

```
IDST001 + ← ID setting command with repeater control
WAIT
OK _ 001 ← "OK" response from ID number: 1
OK _ 002 ← "OK" response from ID number: 2
OK _ 003 ← "OK" response from ID number: 3
OK _ 004 ← "OK" response from ID number: 4 (End)
```

**IDSL** .....The parameter of this command sets the ID number of the monitor. The monitor is subject to the next command.

Example:

```
IDSL0002 ← The next command is for the monitor with ID number: 2.
WAIT ← Searching for monitor with ID number: 2
OK _ 002 ← Found monitor with ID number: 2
VOLM0030 ← Sets volume of monitor with ID number: 2 to 30.
WAIT ← Processing
OK _ 002 ← OK response from monitor with ID number: 2
VOLM0020 ← Sets volume to 20.
OK _ 001 ← The volume of the monitor with ID number: 1 (the one directly connected to the PC) is set to 20.*
```

\* The IDSL command is effective only once, for the immediately succeeding command.

**IDLK** .....The parameter of this command sets the ID number of the monitor. The monitor is subject to all subsequent commands.

Example:

```
IDLK0002 ← Following commands are for the monitor with ID number: 2.
WAIT ← Searching for monitor with ID number: 2
OK _ 002 ← Found monitor with ID number: 2
VOLM0030 ← Sets volume of monitor with ID number: 2 to 30.*
WAIT ← Processing
OK _ 002
VOLM0020 ← Sets volume of monitor with ID number: 2 to 20.*
WAIT
OK _ 002
IDLK0000 ← Canceling fixed ID number setting
WAIT ← Canceling IDLK
OK _ 002 ← Cancellation complete
VOLM0010
OK _ 001 ← The volume of the monitor with ID number: 1 (the one directly connected to the PC) is set to 10. (IDLK is canceled.)
```

\* The IDLK command remains effective until it is canceled, or power is shut off.

**IDCK**.....Provides screen display of the ID number currently assigned to a monitor, and the ID number currently set for IDLK (if any).

Example:

(After executing IDLK0002)

```
IDCK0000 ← (Parameter has no meaning.)
ID : 001 IDLK : 002 ← Returned response. The ID number is also displayed on the monitor screen.
IDCK0000 + ← Repeater control. (If a command is used with repeater control, ID designation using IDSL or IDLK is canceled.)
WAIT
ID : 001 IDLK : 000
ID : 002 IDLK : 000
ID : 003 IDLK : 000
ID : 004 IDLK : 000
```

## Controlling the Monitor with a PC (RS-232C)

### ■ Repeater control

This system has a function to allow setting of multiple monitors connected in a daisy chain using a single command. This function is called repeater control. You can use Repeater control function without assigning ID numbers.

[Example]

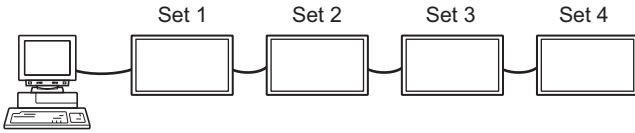

\* If monitors are connected as shown above, you can execute a command like "Set all monitors' input settings to D-SUB[RGB]".

### ■ Repeater control command

Repeater control is achieved by setting the FOURTH CHARACTER of the parameter to "+".

Example:

VOLM030 + ← Sets volume of all monitors to 30.

In repeater control, responses are returned by all the connected monitors.

If you want to determine that a value has been returned by a specific set, assign ID numbers to each monitor in advance. When some monitors do not return their responses, the probable cause is that the monitors could not receive the command or command processing is not complete. Do not send a new command.

Example: (When 4 monitors are connected, and assigned ID numbers: 1 through 4)

```
VOLM030 +
WAIT
OK _ 001
OK _ 002
OK _ 003
OK _ 004 ← If 4 monitors are connected in
a chain, reliable operation can
be ensured by sending a new
command only after a reply
has been returned by 4th (last)
monitor.
```

Repeater control can also be used for reading settings.

Example:

```
VOLM ??? +
WAIT
10 _ 001
20 _ 002
30 _ 003
30 _ 004
```

Volume settings for all monitors are returned.

#### TIPS

- If repeater control is used during ID designation (IDSL, IDLK), the ID designation is canceled.

## Setting of the GAMMA user data

### ■ To transfer the GAMMA user data

Use the user data transfer commands (UGRW, UGGW and UGBW). For each of the R, G and B colors, divide the total 512 pieces of user data into 16 blocks, and transfer 32 pieces of data with each command.

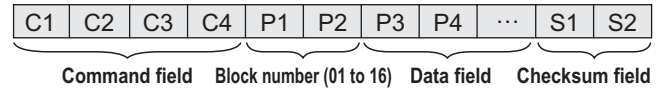

Example: To transfer the data of block 1 (0 to 31 levels) of red (R) data

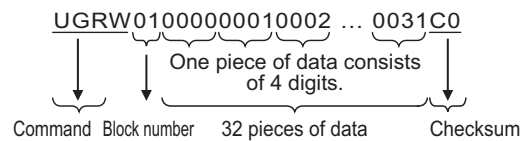

- \* If data is less than 4 digits, add a "0" (zero) to make it 4 digits.
- \* The checksum field is the character string (ASCII) data of lower-order one byte which indicates the sum of the block number and 32 pieces of data in hexadecimal (0 to F).

### ■ Saving the GAMMA user data

Use the user data save command (UGSV) to save the transferred user data in the monitor.

If the data is not saved, it will be cleared when:

- The main power switch is off
- POWER SAVE MODE is ON and the monitor enters standby mode

### ■ Activating the GAMMA user data

To activate the transferred user data, select USER for GAMMA of the PICTURE menu, or send the corresponding RS-232C command.

### ■ Checking the GAMMA user data

Use the user data read commands (UGRR, UGGR and UGBR) to return 512 pieces of user data for each of the R, G and B colors. Divide the data into 16 blocks and return 32 pieces of data with each command. The value to be returned is not the value stored in the monitor, but the value in the temporary memory for display. (These values are the same when the user data save command (UGSV) above has been sent.)

#### TIPS

- The user data is not initialized by RESET of the PICTURE menu. To initialize the user data, use ALL RESET of the FUNCTION menu.  
The GAMMA user data initialize command (UGRS) allows the initialization of the user data only.

## RS-232C command table

### How to read the command table

- Command: Command field (See page 35.)
- Direction: W When the "Parameter" is set in the parameter field (see page 35), the command functions as described under "Control/Response Contents".  
 R The returned value indicated under "Reply" can be obtained by setting "????", "???" or "???" (repeater field) in the parameter field. (See page 35.)
- Parameter: Parameter field (See page 35.)
- Reply: Response (Returned value)
- \* : "●" indicates a command which can be used in standby mode regardless of the POWER SAVE MODE setting.  
 "○" indicates a command which cannot be used in standby mode when POWER SAVE MODE is set to ON.  
 "—" indicates a command which cannot be used in standby mode regardless of the POWER SAVE MODE setting.

### Power control/Input mode selection

Function	Command	Direction	Parameter	Reply	Control/Response contents	*	
POWER CONTROL	POWR	W	0		Switches to standby mode.		
			1		Returns from standby mode.		
		R	0		Standby mode		
			1		Normal mode		
			2		Input signal waiting mode		
INPUT MODE SELECTION	INPS	W	0		Toggle change for input mode. Terminals not selected in INPUT SELECT cannot be selected.		
			1		DVI-D		
			2		D-SUB[RGB] "ERR" when other than RGB is selected for D-SUB of INPUT SELECT.		
			3		D-SUB[COMPONENT] "ERR" when other than COMPONENT is selected for D-SUB of INPUT SELECT.		
			10		HDMI1		
			13		HDMI2		
			14		DisplayPort		
			21		OPTION "ERR" when nothing is attached in the expansion slot.		
			R	1		DVI-D	
				2		D-SUB[RGB]	
		3			D-SUB[COMPONENT]		
		10			HDMI1		
		13			HDMI2		
				14		DisplayPort	
				21		OPTION	

## Controlling the Monitor with a PC (RS-232C)

### SCREEN menu

Function		Command	Direction	Parameter	Reply	Control/Response contents	*
AUTO		ASNC	W		1	When the input mode is D-SUB[RGB].	
CLOCK		CLCK	WR	0-1200	0-1200	When the input mode is D-SUB[RGB]. Varies depending on the signal.	
PHASE		PHSE	WR	0-63	0-63	When the input mode is D-SUB[RGB].	
POSITIONING	POSITION OF THE LONGEST DIRECTION	HPOS	WR	0-100	0-100	0-800 on D-SUB[RGB]. Varies depending on the signal.	
	POSITION OF THE SHORTEST DIRECTION	VPOS	WR	0-100	0-100	0-200 on D-SUB[RGB]. Varies depending on the signal.	
SIZE	SIZE OF THE LONGEST DIRECTION	HSIZ	WR	0-100	0-100		
	SIZE OF THE SHORTEST DIRECTION	VSIZ	WR	0-100	0-100		
RESOLUTION SETTING	LONGEST DIRECTION RESOLUTION	HRES	WR	300-1920	300-1920	When the input mode is D-SUB[RGB]. Only even numbers are valid for parameters. Varies depending on the signal.	
	SHORTEST DIRECTION RESOLUTION	VRES	WR	200-1200	200-1200		
INPUT SIGNAL (D-SUB[RGB])		PXSL	WR		1	768) 1360 x 768	
					2	768) 1280 x 768	
					3	768) 1024 x 768	
					5	480) 848 x 480	
					6	480) 640 x 480	
					7	1050) 1680 x 1050	
					8	1050) 1400 x 1050	
					9	768) AUTO	
					10	480) AUTO	
				Check the resolution (other than D-SUB[COMPONENT])		PXCK	R
Check the resolution (HDMI1, HDMI2, D-SUB[COMPONENT], OPTION (When you have used the expansion slot to expand the functions.))		RESO	R			- 480i, 480p, 1080i, 720p, 1080p, VGA, etc.	
ZOOM2 SPECIAL SETTING (D-SUB[RGB])		Z2SP	WR	0-1	0-1	0: OFF, 1: ON	○
RESET		ARST	W		1		-



## PICTURE menu

Function		Command	Direction	Parameter	Reply	Control/Response contents	*	
BRIGHT		VLMP	WR	0-31	0-31			
CONTRAST		CONT	WR	0-60	0-60			
BLACK LEVEL		BLVL	WR	0-60	0-60			
TINT		TINT	WR	0-60	0-60			
COLORS		COLR	WR	0-60	0-60			
SHARPNESS		SHRP	WR	0-24	0-24			
COLOR ADJUSTMENT	COLOR MODE	BMOD	WR	0	0	STD		
				2	2	VIVID		
				3	3	sRGB (sRGB cannot be used when input mode is D-SUB[COMPONENT].)		
				4	4	HIGH ILLUMINANCE		
	WHITE BALANCE		WHBL	WR	0-2	0-2	0:THRU, 1:PRESET, 2:USER	
	PRESET		CTMP	WR	1-28	1-28	From 1: approximately 3000K to 15: approximately 1000K (500K steps) 16: approximately 5600K, 17: approximately 9300K, 18: approximately 3200K From 19: approximately 10500K to 28: approximately 15000K (500K steps) "ERR" when WHBL is not set to 1.	
	USER	R-CONTRAST	CRTR	WR	0-256	0-256	"ERR" when WHBL is not set to 2.	
		G-CONTRAST	CRTG	WR	0-256	0-256		
		B-CONTRAST	CRTB	WR	0-256	0-256		
		R-OFFSET	OFSR	WR	-127-127	-127-127		
		G-OFFSET	OFSG	WR	-127-127	-127-127		
		B-OFFSET	OFSB	WR	-127-127	-127-127		
	COPY TO USER		CPTU	W	0		Copies a preset value to the user setting.	
	GAMMA		GAMM	WR	0-9	0-9	0: 1.8, 1: 2.2, 2: 2.4, 3: DICOM SIMULATION, 4:USER, 5:2.0, 6:STD, 7:LIGHT 2, 8:LIGHT 1, 9:DARK	
	FLESH TONE		FLES	WR	0-2	0-2	0: OFF, 1: LOW, 2: HIGH	
	C.M.S.-HUE	CMHR	WR		-10-10	-10-10	R	
							Y	
							G	
							C	
							B	
M								
CRST		W		1		Resets the hue.		
C.M.S.-SATURATION	CMSR	WR		-10-10	-10-10	R		
						Y		
						G		
						C		
						B		
						M		
	CRST	W		2		Resets the saturation.		
ADVANCED	AUTO	AGIN	W	1		When the input mode is D-SUB[RGB].	-	
	ANALOG GAIN	ANGA	WR	0-127	0-127	When the input mode is D-SUB[RGB].		
	ANALOG OFFSET	ANOF	WR	0-127	0-127	When the input mode is D-SUB[RGB].		
	NR	TDNR	WR	0-2	0-2	0: OFF, 1: LOW, 2: HIGH		
	RGB INPUT RANGE	INPR	WR	0-2	0-2	0: AUTO, 1: FULL, 2: LIMITED "ERR" when the input mode is D-SUB[COMPONENT]. When the input mode is DVI-D, or D-SUB[RGB] the value 0 is invalid.		
	DISPLAY COLOR PATTERN	PTDF	WR		0	0	No pattern display.	
					1	1	White single color pattern display.	
					2	2	Red single color pattern display.	
					3	3	Green single color pattern display.	
					4	4	Blue single color pattern display.	
99	99	Red/green/blue mixed color pattern display. Set each color's level with PTDR, PTDG, PTDB.						
DISPLAY COLOR PATTERN (R)	PTDR	WR	0-255	0-255	Set the R, G, and B levels of the mixed color pattern. "ERR" when PTDF is not set to 99.			
DISPLAY COLOR PATTERN (G)	PTDG	WR	0-255	0-255				
DISPLAY COLOR PATTERN (B)	PTDB	WR	0-255	0-255				
DISPLAY COLOR PATTERN (LEVEL)	PTDL	WR	0-255	0-255	Set the white, red, green, and blue levels of the single color pattern. "ERR" when the DISPLAY COLOR PATTERN is set to a color other than white, red, green, or blue.			
RESET	ARST	W	2					

# Controlling the Monitor with a PC (RS-232C)

## AUDIO menu

Function	Command	Direction	Parameter	Reply	Control/Response contents	*
TREBLE	AUTR	WR	-5-5	-5-5		
BASS	AUBS	WR	-5-5	-5-5		○
BALANCE	AUBL	WR	-10-10	-10-10		
RESET	ARST	W	3			-

## SETUP menu

Function	Command	Direction	Parameter	Reply	Control/Response contents	*	
DATE/TIME SETTING	DATE	WR	AABBCCDDEE	AABBCCDDEE	AA: Year, BB: Month, CC: Day, DD: Hour, EE: Minute		
DATE FORMAT	DTFT	WR	0-2	0-2	0: YYYY/MM/DD, 1: MM/DD/YYYY, 2: DD/MM/YYYY YYYY: Year, MM: Month, DD: Day		
TIME FORMAT	TMFT	WR	0-1	0-1	0: 24-HOUR TIME, 1: 12-HOUR TIME		
SCHEDULE	SC01-SC08	WR	ABCDEFGHIJGH	ABCDEFGHIJGH	Schedule of a specified number A: Schedule 0= Not effective, 1 = Effective B: Power 0 = OFF, 1 = ON C: Day of the week 1 0 = Only once, 1 = Every week, 2 = Every day D: Day of the week 2 0 = Sunday, 1 = Monday through 6 = Saturday, 9 = Not exist E: Day of the week 3 0 = Sunday, 1 = Monday through 6 = Saturday, 9 = Not exist F: Hour 00-23 G: Minute 00-59 H: Input 0 = Not specified, 1=HDMI1, 2=HDMI2, 4=D-SUB, 6=DisplayPort, 7=DVI-D, 8=OPTION(valid when an option is attached)		
SCHEDULE BRIGHTNESS	SB01-SB08	WR	0-31	0-31	Screen brightness to change		
			99	99	Disable brightness setting		
LANGUAGE	LANG	WR	14	14	ENGLISH		
			1	1	DEUTSCH		
			2	2	FRANÇAIS		
			3	3	ITALIANO		
			4	4	ESPAÑOL		
			5	5	РУССКИЙ		
			6	6	日本語		
7	7	中文					
INPUT SELECT	D-SUB	SLDS	WR	0-1	0-1	0: RGB, 1: COMPONENT	
	HDMI CEC LINK	CELK	WR	0-1	0-1	0: OFF, 1: AUTO	
	AUTO POWER ON	ATPO	WR	0-1	0-1	0: OFF, 1: ON	
	HDMI AUTO VIEW (HDMI1)	HDAW	WR	0-1	0-1	0: OFF, 1: ON	
	HDMI AUTO VIEW (HDMI2)	H2AW	WR	0-1	0-1	0: OFF, 1: ON	
	HDMI AUTO VIEW (OPTION)	OPAW	WR	0-1	0-1	0: OFF, 1: ON (valid when you have used the expansion slot to expand the functions)	
	HOT PLUG CONTROL (DVI-D)	HPCT	WR	0-1	0-1	0: OFF, 1: ON	
	HOT PLUG CONTROL (HDMI1)	HPCH	WR	0-1	0-1	0: OFF, 1: ON	
	HOT PLUG CONTROL (HDMI2)	HPH2	WR	0-1	0-1	0: OFF, 1: ON	
	HOT PLUG CONTROL (OPTION)	HPOP	WR	0-1	0-1	0: OFF, 1: ON (valid when you have used the expansion slot to expand the functions)	
	DisplayPort STREAM	DPST	WR	0-1	0-1	0: SST, 1: MST "ERR" when PIP MODES is a value other than OFF.	
DisplayPort SETTING	HIGH-FREQUENCY GAIN	DPHG	WR	0-31	0-31		
	LOW-FREQUENCY GAIN	DPLG	WR	0-31	0-31		
	FILTER SETTING	DPFL	WR	0-15	0-15		
	OFFSET	DPOF	WR	0-15	0-15		
	RESET	DPRS	W	1			
AUDIO SELECT	HDMI1	ASHP	WR	0-1	0-1	0: HDMI, 1: AUDIO	
	HDMI2	AH2P	WR	0-1	0-1	0: HDMI, 1: AUDIO	
	DisplayPort	ASDI	WR	1, 3	1, 3	1: AUDIO, 3: DisplayPort	
	OPTION	ASOP	WR	0-1	0-1	0: OPTION, 1: AUDIO (valid when you have used the expansion slot to expand the functions)	
AUDIO OPTION	AUDIO OUTPUT	AOUT	WR	0-2	0-2	0: VARIABLE1, 1: FIXED, 2: VARIABLE2	
	AUDIO INPUT LEVEL	AIVP	WR	0-1	0-1	0: 1.0Vrms, 1: 0.5Vrms	
	MONAURAL AUDIO	MONO	WR	0-1	0-1	0: OFF, 1: ON	
START INPUT MODE	SUIM	WR	1-4, 6-7, 10	1-4, 6-7, 10	1: LAST INPUT MODE, 2: DisplayPort, 3: HDMI1, 4: HDMI2, 6: DVI-D, 7: D-SUB, 10: OPTION (valid when you have used the expansion slot to expand the functions)		
COMMUNICATION SETTING	RS-232C/LAN SELECT	CTLS	WR	0-1	0-1	0: RS-232C, 1: LAN	●
	BAUD RATE	BAUD	WR	0-2	0-2	0: 9600bps, 1: 19200bps, 2: 38400bps	
	Creston Connected	CRCN	WR	0-1	0-1	0: OFF, 1: ON	○

## Controlling the Monitor with a PC (RS-232C)

Function		Command	Direction	Parameter	Reply	Control/Response contents	*
ID SETTING	ID No. SET	IDST	W	0-255	0-255	Sets the monitor's ID number. ("0" means "no ID number".)	○
			R			Returns the monitor's ID number.	
	ID NO. SETTING (ONCE)	IDSL	W	1-255	0	Set a monitor's ID number to send a command. This ID number is only effective for the command immediately after this command.	
				0		Clears the ID number if one has been designated.	
	ID NO. SETTING (SUBSEQUENT)	IDLK	W	1-255	0	Set a monitor's ID number to send a command. This ID number is effective for the next and all subsequent commands after this command.	
				0		Clears the ID number if one has been designated.	
ID CHECK	IDCK	W	0	ID : xxx IDLK : yyy	Displays monitor's own ID number and the selected ID number on the screen.		
ID DISPLAY	IDDP	W	0-2		0: OFF, 1: ON, 2: ON (turns OFF after 4 sec.) (The IP address and MAC address are both displayed.)	-	
REMOTE No.		RCNO	WR	0-9	0-9	Sets the number of the remote control.	
COPY SETTING VALUE	COPY TO ID No.	CPMD	WR	0	0	Copy to all monitors.	○
				1-255	1-255	Copy to the monitor with the set ID number.	
	COPY SETTING VALUE TARGET	CPTG	WR	0	0	Copies the PICTURE menu settings.	
				1	1	Copies all the settings.	
SUPPLY USB POWER		PWSP	WR	0-1	0-1	0: POWER ON ONLY, 1: ALWAYS	-

## MONITOR menu

Function		Command	Direction	Parameter	Reply	Control/Response contents	*
PORTRAIT/LANDSCAPE INSTALL		STDR	WR	0-1	0-1	0: LANDSCAPE, 1: PORTRAIT	○
HORIZONTAL INSTALLATION		MLAY	WR	0-2	0-2	0: OFF, 1: UPWARD, 2: DOWNWARD	
ROTATE 180°		PFIL	WR	0, 3	0, 3	0: OFF, 3: ON "ERR" when PIP MODES is a value other than OFF.	
OSD H-POSITION		OSDH	WR	0-100	0-100	"ERR" when PORTRAIT/LANDSCAPE INSTALL is set to PORTRAIT.	
OSD V-POSITION		OSDV	WR	0-100	0-100		
OPERATION MODE		FNCM	WR	0-1	0-1	0: MODE1, 1: MODE2	
POWER SAVE MODE		STBM	WR	0-1	0-1	0: OFF, 1: ON "ERR" when SUPPLY USB POWER is set to ALWAYS.	
OFF IF NO OPERATION	SET	ATOF	WR	0-1	0-1	0: OFF, 1: ON	
	TIME	AOFT	WR	1-12	1-12	1-12: 1-12 hours	
POWER ON DELAY	SET	PODS	WR	0-1	0-1	0: OFF, 1: ON	
	INTERVAL	PWOD	WR	1-60	1-60	1-60: 1-60 seconds	
SELF ADJUST	SELF ADJUST	AADJ	WR	0-1	0-1	0: OFF, 1: ON	
	START TIMING	AADD	WR	10-200	10-200	10: 1 second through 200: 20 seconds	

# Controlling the Monitor with a PC (RS-232C)

## MULTI/PIP menu

Function	Command	Direction	Parameter	Reply	Control/Response contents	*	
ENLARGE	ENLG	WR	0-1	0-1	0: OFF, 1: ON		
ENLARGE MODE	EMAG	WR	1-4	1-4	1: 2 x 2, 2: 3 x 3, 3: 4 x 4, 4: 5 x 5		
	EMHV	WR	12(21)-55	12(21)-55	1 x 2 (2 x 1) to 5 x 5 ("m x n" is expressed as "mn", where m and n are the numbers of monitors specified for the longest direction and the shortest direction respectively.)		
IMAGE POSITION (M x N)	EPHV	WR	11-55	11-55	Specifies values in the order of IMAGE POSITION IN LONGEST/ SHORTEST DIRECTION.		
IMAGE POSITION (2 x 2)	EPOS	WR	0-3	0-3	See the description below.		
IMAGE POSITION (3 x 3)	EPOS	WR	0-8	0-8			
IMAGE POSITION (4 x 4)	EPOS	WR	0-15	0-15			
IMAGE POSITION (5 x 5)	EPOS	WR	0-24	0-24			
ENLARGED SCREEN POSITIONING	THE LONGEST DIRECTION	EPSH	WR	-999-999	-999-999	The setting range depends on the ENLARGE MODE setting and the IMAGE POSITION.	
	THE SHORTEST DIRECTION	EPSV	WR	-999-999	-999-999		
BEZEL ADJUST	BZCO	WR	0-1	0-1	0: OFF, 1: ON		
BEZEL ADJUST	TOP	BZCT	WR	0-1	0-1	0: OFF, 1: ON	
	BOTTOM	BZCB	WR	0-1	0-1	0: OFF, 1: ON	
	RIGHT	BZCR	WR	0-1	0-1	0: OFF, 1: ON	
	LEFT	BZCL	WR	0-1	0-1	0: OFF, 1: ON	
BEZEL WIDTH	TOP	BZWT	WR	0-100	0-100		
	BOTTOM	BZWB	WR	0-100	0-100		
	RIGHT	BZWR	WR	0-100	0-100		
	LEFT	BZWL	WR	0-100	0-100		
ENLARGE/IMAGE POSITION SETTING	ESTG	WR	XXYY	XXYY	XX: ENLARGE MODE (Same as EMAG), YY: IMAGE POSITION (Same as EPOS)		
	ESHV	WR	XXYY	XXYY	XX: ENLARGE MODE (Same as EMHV), YY: IMAGE POSITION (Same as EPHV)		

### • IMAGE POSITION (EPOS) setting In landscape orientation

2 x 2

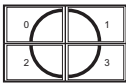

3 x 3

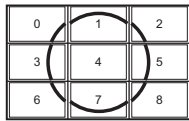

4 x 4

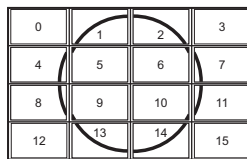

5 x 5

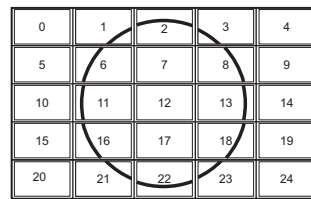

### In portrait orientation

2 x 2



3 x 3

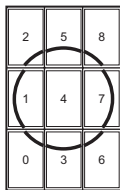

4 x 4

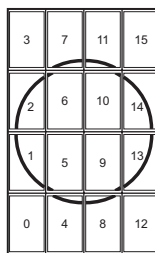

5 x 5

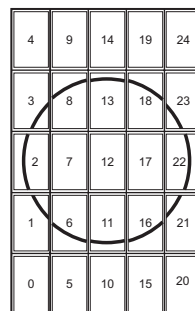

## Controlling the Monitor with a PC (RS-232C)

Function		Command	Direction	Parameter	Reply	Control/Response contents	*
PIP MODES		MWIN	WR	0-3	0-3	0: OFF, 1: PIP, 2: PbyP, 3: PbyP2	
PIP SIZE		MPSZ	WR	1-64	1-64		
PIP POS	THE LONGEST DIRECTION	MHPS	W	0-100			
			R		0-100		
PIP POS	THE SHORTEST DIRECTION	MVPS	W	0-100			
			R		0-100		
PIP POS LD+SD BATCH		MPOS	W	0-100,0-100		Specify the position in MPOSxxxxxy format. (xxx: Longer side, yyy: Shorter side position)	
			R		0-100,0-100	Returns a response in (xxx,yyy) format. (xxx: Longer side, yyy: Shorter side position)	
PIP BLEND		MWBL	WR	0-7	0-7		
PIP SOURCE		MWIP	WR	1	1	DVI-D	
				2	2	D-SUB[RGB]	
				3	3	D-SUB[COMPONENT]	
				10	10	HDMI1	
				13	13	HDMI2	
				14	14	DisplayPort	
SOUND CHANGE		MWAD	WR	1-2	1-2	1: MAIN, 2: SUB	
MAIN POS (Main screen)		MWPP	WR	0-1	0-1	0: POS1, 1: POS2	
PbyP2 POS (Sub screen)		MW2P	WR	0-2	0-2	0: POS1, 1: POS2, 2: POS3	

### OTHERS menu

Function		Command	Direction	Parameter	Reply	Control/Response contents	*
SCREEN MOTION	PATTERN	SCSV	WR	0-4	0-4	0: OFF, 1-4: PATTERN1-4	
	MOTION TIME1	MTIM	WR	0-20	0-20		
	MOTION TIME2 (PATTERN1)	MINT	WR	10-990	10-990	Per 10 seconds	
	MOTION TIME2 (PATTERN2-4)	MINT	WR	5-20	5-20	Per second	
POWER MANAGEMENT		PMNG	WR	0-1	0-1	0: OFF, 1: ON	
CONNECT AUTO INPUT SELECT		AICO	WR	0-1	0-1	0: OFF, 1: ON The input via the expansion slot is ignored.	
NO SIGNAL AUTO INPUT SEL.		AINO	WR	0-1	0-1	0: OFF, 1: ON	
AUTO INPUT SELECT PRIORITY	DisplayPort	APDP	WR	0-10	0-10	0: Not selected by auto input selection, 1-10: Priority "ERR" when OFF is selected for NO SIGNAL AUTO INPUT SEL.. APOP will result in an error ("ERR") when an optional part that is not a target for this function is connected. All input terminals cannot be set to 0 simultaneously.	
	HDMI1	APH1					
	HDMI2	APH2					
	DVI-D	APDV					
	D-SUB	APD1					
	OPTION	APOP					
LOGO SCREEN		BTSC	WR	0-1	0-1	0: OFF, 1: ON	
SCAN MODE (HDMI1, HDMI2, D-SUB[COMPONENT], OPTION (When you have used the expansion slot to expand the functions.))		SCAN	WR	0-2	0-2	0: MODE1, 1: MODE2, 2: MODE3	

### Initialization/Functional Restriction Setting (FUNCTION) menu

Function		Command	Direction	Parameter	Reply	Control/Response contents	*
ALL RESET		RSET	W	0-1		0: ALL RESET 1, 1: ALL RESET 2	-
ADJUSTMENT LOCK		ALCK	WR	0-2	0-2	0: OFF, 1:ON1, 2:ON2	●
ADJUSTMENT LOCK TARGET		ALTG	WR	0-2	0-2	0: REMOTE CONTROL, 1: MONITOR BUTTONS, 2: BOTH	
OSD DISPLAY		LOSD	WR	0-2	0-2	0: ON1, 1: OFF, 2: ON2	
LED		OFLD	WR	0-1	0-1	0: ON, 1: OFF	
TEMPERATURE ALERT		TALT	WR	0-2	0-2	0: OFF, 1: OSD & LED, 2: LED	
STATUS ALERT		SALT	WR	0-2	0-2	0: OFF, 1: OSD & LED, 2: LED	
POWER BUTTON		PBTN	WR	0-1	0-1	0: MONITOR, 1: EXT. CONTROLLER	
EXTERNAL CONTROLLER INPUT		PCIP	WR	0-4	0-4	0: D-SUB, 1: DisplayPort, 2: HDMI1, 3: HDMI2, 4: DVI-D ("ERR" when MONITOR is selected for POWER BUTTON.)	
SIGNAL RESPONSE LEVEL		HDUC	WR	1-200	1-200		

# Controlling the Monitor with a PC (RS-232C)

## Others

Function	Command	Direction	Parameter	Reply	Control/Response contents	*
SCREEN SIZE	WIDE	WR	1-5	1-5	1: WIDE, 2: NORMAL, 3: Dot by Dot, 4: ZOOM1, 5: ZOOM2	○
VOLUME	VOLM	WR	0-31	0-31		
MUTE AUDIO	MUTE	WR	0-1	0-1	0: OFF, 1: ON	-
INFORMATION	MODEL	INF1		Value		
	SERIAL NO	SRNO		Value		
TEMPERATURE SENSOR	DSTA	R		0	Internal temperature normal	
				1	Internal temperature abnormal has occurred and the monitor is in standby mode	●
				2	Internal temperature abnormal occurred (To delete the information of temperature abnormal, turn off the main power.)	
				3	Internal temperature abnormal has occurred and backlight brightness is dimmed	
				4	Temperature sensor abnormal	
TEMPERATURE ACQUISITION	ERRT	R		Value	Returns the temperature at the temperature sensors. Indicates a temperature sensor abnormality when "126" is returned.	○
CAUSE OF LAST STANDBY MODE	STCA	W	0		Initialization	
		R	0	No detectable error has occurred		
			1	Standby mode by POWER button		
			2	Main power off by the main power switch		
			3	Standby mode by RS-232C or LAN		
			4	Input signal waiting mode by No Signal		
			6	Standby mode by abnormal temperature	●	
			8	Standby mode by SCHEDULE setting		
			9	Standby mode by DDC/CI		
			10	Standby mode by HDMI CEC		
			20	Standby mode by OFF IF NO OPERATION setting		

## Commands for setting of the GAMMA user data

Function	Command	Direction	Parameter	Reply	Control/Response contents	*
RED GAMMA DATA TRANSFER	UGRW	W	aa: Block number xxxx: 32 pieces of user data cc: Checksum (ASCII data) of the block number and user data		aa: Block number xxxx: 32 pieces of user data cc: Checksum (ASCII data) of the block number and user data	○
GREEN GAMMA DATA TRANSFER	UGGW	W				
BLUE GAMMA DATA TRANSFER	UGBW	W				
RED GAMMA DATA READ	UGRR	W	1-16	xxxx ... xxxx	xxxx: User data of 32 pieces	
GREEN GAMMA DATA READ	UGGR	W	1-16	(xxxx: 32 pieces)		
BLUE GAMMA DATA READ	UGBR	W	1-16	xxxx: 0000-1023		
USER DATA INITIALIZE	UGRS	W	0		Initialize the user data.	
USER DATA SAVE	UGSV	W	0		Save the user data in the monitor.	

# Controlling the Monitor with a computer (LAN)

Your monitor can be connected to a LAN allowing you to control it from a computer on the LAN. You can also configure the monitor to send e-mail notification when it has a problem. The connection requires a commercially available LAN cable (UTP cable, Category 5, straight through).

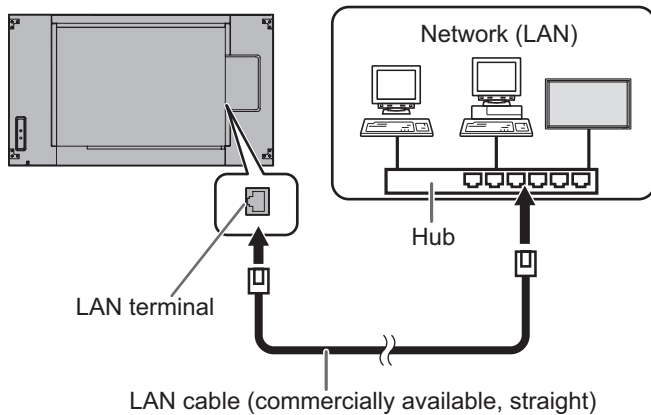

## TIPS

- You must assign an IP address to the monitor by following the procedures in "Settings to connect to a LAN". (See the description on the right.)
- Your computer must be installed with the web browser.
- When POWER SAVE MODE is set to ON, the control is disabled in the standby mode.
- To control the monitor via LAN, set RS-232C/LAN SELECT to LAN. (See page 27.)
- You cannot use RS-232C and LAN control simultaneously.

## Initializing personal information

- Personal information such as e-mail addresses can be registered in the monitor. Before transferring or disposing of the monitor, initialize all settings by selecting ALL RESET 1. (See page 34.) Note that ALL RESET 2 will not initialize e-mail addresses and other settings.

## Settings to connect to a LAN

Set the monitor's IP address and subnet mask to match the settings of your LAN.

These settings can be made on either the monitor or a computer connected to the monitor.

The settings depend on the configuration of your LAN. Ask your LAN administrator for details.

### ■ To set on the monitor

Set RS-232C/LAN SELECT of COMMUNICATION SETTING on the SETUP menu to LAN, and then set the LAN SETUP options. (See page 27.)

After setting each item, select SET and press the ENTER button.

#### DHCP CLIENT

If your LAN has a DHCP server and you wish to obtain an address automatically, change this setting to "ON".

To set the address manually, set this to "OFF".

#### IP ADDRESS

If the DHCP CLIENT is set to "OFF", specify an IP address.

Press or to select items, and press or to change the values.

#### SUBNET MASK

If the DHCP CLIENT is set to "OFF", specify the subnet mask.

Press or to select items, and press or to change the values.

#### DEFAULT GATEWAY

If the DHCP CLIENT is set to "OFF", specify the default gateway.

If you are not using a default gateway, specify "0.0.0.0".

Press or to select items, and press or to change the values.

#### RESET

Resets the values of the LAN settings to the factory preset values.

Select ON and then press the ENTER button.

## TIPS

- When the IP address is set manually, the IP addresses of the monitor connected to the RS-232C output terminal and the daisy chain of connected monitors that follows can be assigned automatically. (See page 27.)

## Controlling the Monitor with a computer (LAN)

### ■ To set from a computer

When the monitor is connected to a computer, LAN settings can be configured via computer.

#### Set up process

- (1) Connect your monitor to a computer
- (2) Specify the computer's IP address
- (3) Configure the monitor's LAN settings

#### (1) Connecting your monitor to a computer

Connect a commercially available crossover LAN cable (UPT cable, Category 5) to the LAN port on the computer and this monitor.

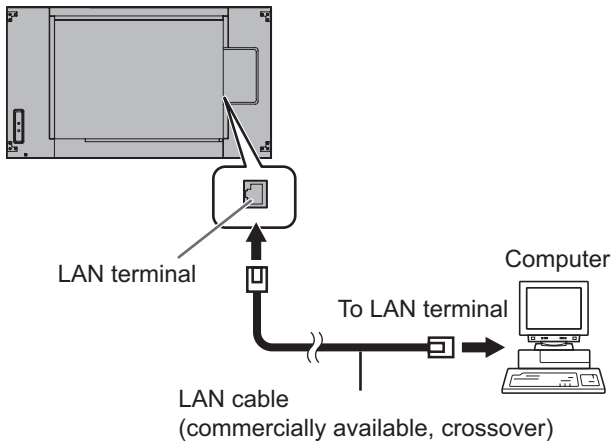

#### (2) Specifying the computer's IP address

To configure the monitor's LAN settings, you must temporarily change the settings on the computer.

This explanation is based on Windows 7.

1. Log on to the computer with an administrator account.
2. Click [Start], and then click "Control Panel".
3. Click "View network status and tasks" in "Network and Internet".

In "Classic View", click "Network and Sharing Center".

4. Click "Local Area Connection" and then "Properties".
5. Click "Internet Protocol Version 4 (TCP/IPv4)" and then "Properties".
6. Make a note of the current IP address, subnet mask, and default gateway settings.

Make sure you write this information now as you will be changing the IP address, subnet mask, and default gateway settings back to these settings afterwards.

7. Temporarily change the IP address and subnet mask. To access the monitor as it is shipped from the factory, set as follows.

- IP Address : 192.168.150.1
- Subnet Mask : 255.255.255.0
- Default Gateway : (leave blank)

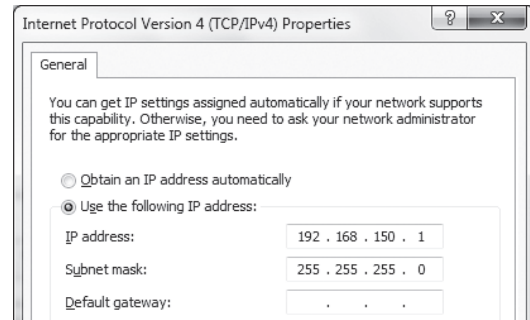

8. Click [OK] and then reboot the computer.

#### TIPS

- This monitor is factory preset as shown below. (When DHCP CLIENT is set to "OFF")  
IP Address : 192.168.150.2  
Subnet Mask : 255.255.255.0  
Default Gateway : 0.0.0.0

#### (3) Configuring the monitor's LAN settings

Access the monitor using the web browser.

##### Controlling the monitor

1. Turn the power ON to the monitor.
2. Set RS-232C/LAN SELECT of COMMUNICATION SETTING on the SETUP menu to LAN.
3. Set DHCP CLIENT of LAN SETUP of COMMUNICATION SETTING on the SETUP menu to "OFF".

##### Computer operation

4. Launch the web browser, in the "Address" box type "http://192.168.150.2/" and press the Enter key.



5. Enter the USER NAME and PASSWORD. The following values are set in the initial settings.  
User name: admin, password: admin  
\* To enable security on the monitor, change the user name and password. (See page 51.)



## 6. Click on "LAN SETUP" under NETWORK.

## 7. Specify the "DHCP CLIENT", "IP ADDRESS", etc.

### DHCP CLIENT

If your LAN has a DHCP server and you wish to obtain an address automatically, change this setting to ON. To set the address manually, set this to OFF.

### IP ADDRESS

If the DHCP CLIENT is set to OFF, specify an IP address.

### SUBNET MASK

If the DHCP CLIENT is set to OFF, specify the subnet mask.

### DEFAULT GATEWAY

If the DHCP CLIENT is set to OFF, specify the default gateway. If you are not using a default gateway, specify "0.0.0.0".

8. When the setting is changed, click [Apply].
9. Check the message and click [OK].
10. Exit the web browser.
11. Restore the computer's IP address jotted in Step 6, "(2) Specifying the computer's IP address".
12. Connect the monitor and the computer to the LAN.

### ! Caution

- Wait 10 seconds after clicking [OK] before proceeding.
- When operating using the remote control unit or similar, click [Refresh].

### TIPS

- When the IP address is set manually, the IP addresses of the monitor connected to the RS-232C output terminal and the daisy chain of connected monitors that follows can be assigned automatically. (See page 27.)

## Controlling with a computer

### Basic operation

You use the web browser on a computer on the LAN to control the monitor.

1. Launch the web browser on the computer.
2. In the "Address" box, type "http://" followed by your monitor's IP address followed by "/", then press the Enter key. You can confirm the IP address with the INFORMATION function.



A screen for entering the user name and password is displayed, so type the user name and password that you specified in the security settings (see page 51), and then click [OK].

The following values are set in the initial settings.

User name: admin, password: admin

\* To enable security on the monitor, change the user name and password. (See page 51.)

3. You can check, control, and change the monitor's status and settings by clicking the menu items on the left side of the screen.

- If you see an [Apply] button next to a setting, click it after you change that setting.

### TIPS

- See pages 50 to 54 for details on each setting.
- If you click [Refresh] before the screen finishes updating the current display, the "Server Busy Error" will appear. Wait for a moment before operating your monitor again.
- You cannot operate the monitor while it is warming up.
- If DHCP CLIENT is set to ON, press INFORMATION button on the remote control unit two times and then check the monitor's IP address.

# Controlling the Monitor with a computer (LAN)

## ■ INFORMATION

Information about this monitor appears.

INFORMATION		DP-1000 D-BUS (P04E) 1900A090
MODEL	DP-1000	
VERSION	1.0.0.0.0	
S/N	XXXXXXXXXX	
INSTALLATION INFORMATION		
NAME		
LOCATION		
MONITOR POWER		
DATE/TIME	ON	
PIPET MODE	* [On/Off] PIPe and PIPyP when you connected 3 wire Ethernet	
PIPET MODE	D-STATUS (P04E)	
SIZE	19" E	
COLOR MODE	STD	
BRIGHT	31	
VOLUME	19	
ED No.	0	
REMOTE CONTROL No.	0	
STATUS	0000-00000-00-0000	
URL INFORMATION		
IP-ADDRESS SELECT	LAN	
SMTP CLIENT	OFF	
IP ADDRESS	192.168.150.2	
RUBINET MARK	255.255.255.0	
DEFAULT GATEWAY	0.0.0.0	
MONITOR NAME	DP-1000	
DATA PORT	10000	
MAC ADDRESS	00-00-00-00-00-00	
TYPE	NOT CONNECTED	
VERSION	1.0.0.0	

## ■ CONTROL

You can control the operations corresponding to the POWER button, INPUT button, etc. on the remote control unit. (See page 19.)

CONTROL		DP-1000 D-BUS (P04E) 1900A090
MONITOR POWER	ON OFF	
PIPET MODE	[ON/OFF] ON	
SIZE	[19"] 19"	
COLOR MODE	[STD] STD	
BRIGHT	[31] 31	
VOLUME	[19] 19	
MUTE	ON OFF	

\* Press the [Refresh] button to check the status of each item after you change it.

## ■ ADJUSTMENT

You can adjust these settings which are also available on the monitor's menu.

- SCREEN (See page 23.)
- PICTURE (See page 24.)
- PICTURE (ADVANCED) (See page 25.)
- AUDIO (See page 25.)
- SETUP (See page 26.)
- MONITOR (See page 28.)
- OTHERS (See page 30.)
- SCHEDULE (See page 32.)
- MULTI (See page 29.)
- PIP/PbyP (See page 29.)
- FUNCTION (See page 34.)

ADJUSTMENT - SCREEN		DP-1000 D-BUS (P04E) 1900A090
AUTO		
CLOCK	[00:00] 00:00	
PHASE	[00:00] 00:00	
PI-POS	[00:00] 00:00	
LI-POS	[00:00] 00:00	
HI-SE	[00:00] 00:00	
VI-SE	[00:00] 00:00	
RESOLUTION GETTING		
H-RESOLUTION	[1280] 1280	
V-RESOLUTION	[1024] 1024	
INPUT SIGNAL		
	[480] 480	
	[720] 720	
	[1080] 1080	
	[2304] 2304	
SPECIAL SETTING: COLOR		
	[OFF] OFF	
RESET		
	[Factory] Factory	
* Press the [Refresh] button to check the status of each item after you change it.		

## TIPS

- After changing DISPLAY COLOR PATTERN to "OFF", click [Refresh] to correctly retrieve the status of the monitor.

## TIPS

- In standby mode, only Power ON operation is available.

## ■ NETWORK (LAN SETUP)

This screen allows you to set the settings necessary when the monitor is connected to a LAN.

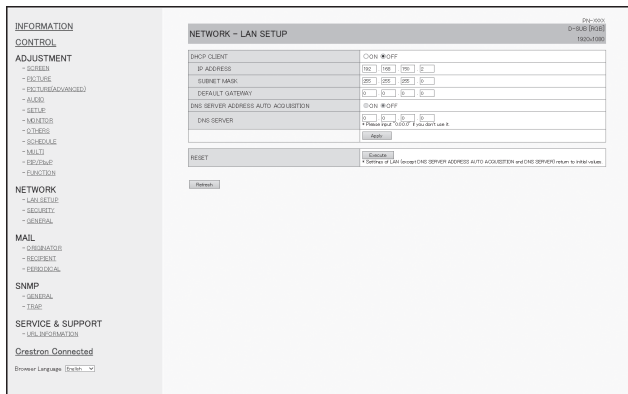

### DHCP CLIENT

If your LAN has a DHCP server and you wish to obtain an address automatically, change this setting to "ON". To set the address manually, set this to "OFF".

### IP ADDRESS

If the DHCP CLIENT is set to "OFF", specify an IP address.

### SUBNET MASK

If the DHCP CLIENT is set to "OFF", specify the subnet mask.

### DEFAULT GATEWAY

If the DHCP CLIENT is set to "OFF", specify the default gateway. If you are not using a default gateway, specify "0.0.0.0".

### DNS SERVER ADDRESS AUTO ACQUISITION

If the DHCP CLIENT is set to "ON", specify whether or not to automatically obtain the DNS server address.

### DNS SERVER

Specify the DNS server address if the DHCP CLIENT is set to "OFF" or the DNS SERVER ADDRESS AUTO ACQUISITION is set to "OFF". If you are not using a DNS server, specify "0.0.0.0".

### RESET

Clicking [Execute] returns all of the LAN SETUP settings to the factory-preset values except for the DNS SERVER ADDRESS AUTO ACQUISITION and DNS SERVER settings.

### TIPS

- When the IP address is set manually, the IP addresses of the monitor connected to the RS-232C output terminal and the daisy chain of connected monitors that follows can be assigned automatically. (See page 27.)

## ■ NETWORK (SECURITY)

This screen allows you to specify the security-related settings.

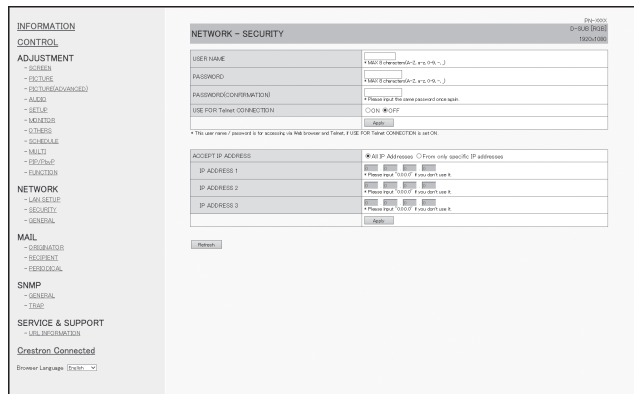

### USER NAME / PASSWORD

Sets up a user name and password to restrict access to this monitor.

The following values are set in the initial settings.

User name: admin, password: admin

\* To enable security on the monitor, change the user name and password.

After entering a user name and password, click [Apply].

### USE FOR Telnet CONNECTION

Sets whether to use a user name and password when connecting over TELNET.

### ACCEPT IP ADDRESS

You can limit access to this monitor by registering IP addresses of PCs that should have access.

To limit access, specify the option "From only specific IP addresses". Otherwise, to allow access from any PC, specify "All IP Addresses".

### IP ADDRESS 1 to 3

If "ACCEPT IP ADDRESS" is set to "From only specific IP addresses", enter the IP addresses that you want to allow.

### TIPS

- The USER NAME and PASSWORD can be up to 8 alphanumeric characters (hyphens and underscores allowed).
- To cancel the user name and/or password after it has been set, make the box empty and click [Apply].

# Controlling the Monitor with a computer (LAN)

## ■ NETWORK (GENERAL)

This screen allows you to specify the general LAN settings.

### MONITOR NAME

Specify a name for this monitor as it should appear on the web browser screen.

### AUTO LOGOUT TIME

Specify the time (in minutes) to elapse before automatically disconnecting this monitor from the network. Specify in minutes from 1 to 65535. A value of '0' will disable this function.

### DATA PORT

Specify the TCP port number to use for exchanging data with the monitor.

Specify a value from 1025 to 65535.

### SEARCH PORT

Specify the port number to use when searching for this monitor.

Specify a value from 1025 to 65535.

### INSTALLATION INFORMATION (NAME/LOCATION)

Specify the information to display for this monitor in the web browser window.

### LINK MODE

Selects the link speed and duplex. Use AUTO normally.

### TIPS

- The MONITOR NAME can be up to 16 alphanumeric characters or symbols.
- Enter up to 50 characters in the NAME field in the INSTALLATION INFORMATION.
- Enter up to 100 characters in the LOCATION field in the INSTALLATION INFORMATION.

## ■ MAIL (ORIGINATOR)

This screen allows you to configure the e-mail sent periodically or when the monitor has an error.

The settings depend on the configuration of your LAN. Ask your LAN administrator for details.

### SMTP SERVER

Specify the SMTP server address for sending e-mail.

\* When using a domain name, make sure to specify the DNS SERVER as well. (See page 51.)

### SMTP PORT

If the "AUTHENTICATION" is "SMTP-AUTH", specify the port number.

### ORIGINATOR E-MAIL ADDRESS

Specify the e-mail address for this monitor.

This address becomes the e-mail address of the originator.

### ORIGINATOR NAME

Specify the name for the originator.

This name appears in the "Originator Name" field of the e-mail.

### AUTHENTICATION

Specify the authentication method to use when sending e-mail.

### POP SERVER

If the "AUTHENTICATION" is "POP before SMTP", specify the POP server address.

### ACCOUNT NAME / PASSWORD

If the "AUTHENTICATION" is "POP before SMTP" or "SMTP-AUTH", specify the account name and password to connect to the SMTP server.

### TIPS

- You can enter up to 64 alphanumeric characters or symbols for the ORIGINATOR E-MAIL ADDRESS, ORIGINATOR NAME, ACCOUNT NAME, and PASSWORD.
- The SMTP SERVER and POP SERVER can be up to 64 characters.  
The following characters can be used: a-z, A-Z, 0-9, - , .

## MAIL (RECIPIENT)

This screen allows you to specify the recipients of the e-mail sent periodically or when the monitor has an error.

### RECIPIENT E-MAIL ADDRESSES

Specify the e-mail addresses to send error notification e-mail to.

### CONDITION

Specify the conditions to send mails.  
When you check PERIODICAL, specify the date and time to send the mails in the PERIODICAL setting.

### CONFIRMATION

Sends test e-mail.  
This allows you to confirm that the e-mail settings are configured properly.

### Attach the log file to a TEMPERATURE/HARDWARE error e-mail.

When this option is checked, a log is added to the mail which notifies a temperature or status error.

### E-MAIL TRANSMISSION ERROR REPORT

A report of the latest e-mail transmission errors will be displayed.  
The error report will be displayed when an e-mail transmission error occurs.  
Also, the e-mail transmission errors will be cleared when ALL RESET 1 is executed. (See page 34.)

### TIPS

- The RECIPIENT E-MAIL ADDRESSES can be up to 64 alphanumeric characters or symbols.

## MAIL (PERIODICAL)

When PERIODICAL for CONDITION of MAIL (RECIPIENT) is checked, set the date and time to send the mail.

### DAY OF THE WEEK

Specify the day of the week to send the periodical mails.

### TIME

Specify the time of the day to send the periodical mails.

### ! Caution

- Do not turn off the main power when you set to send the periodical mails.
- Specify the correct date and time. (See page 26.)  
If the date and time settings are incorrect, the periodical mail is not sent properly.
- Regularly confirm that the specified date and time is correct.

# Controlling the Monitor with a computer (LAN)

## ■SNMP

You can configure settings related to SNMP.

**SNMP - GENERAL**

TRAP SETTING: ON/OFF

VERSION:  v1  v2c  v3

COMMUNITY NAME 1: [Field] (1-16 alphanumeric)

COMMUNITY NAME 2: [Field] (1-16 alphanumeric)

COMMUNITY NAME 3: [Field] (1-16 alphanumeric)

USER 1: [Field] (1-16 alphanumeric), [Field] (1-16 alphanumeric), [Field] (1-16 alphanumeric), [Field] (1-16 alphanumeric)

USER 2: [Field] (1-16 alphanumeric), [Field] (1-16 alphanumeric), [Field] (1-16 alphanumeric), [Field] (1-16 alphanumeric)

USER 3: [Field] (1-16 alphanumeric), [Field] (1-16 alphanumeric), [Field] (1-16 alphanumeric), [Field] (1-16 alphanumeric)

Buttons: [Apply] [Reset]

**SNMP - TRAP**

TRAP SETTING: ON/OFF

TRAP SETTING OF AUTHENTICATION ERROR:  ON  OFF

TRAP ADDRESS	PORT	TRAP ADDRESS	PORT
[Field]	[Field]	[Field]	[Field]
[Field]	[Field]	[Field]	[Field]
[Field]	[Field]	[Field]	[Field]

Buttons: [Apply] [Reset]

### SNMP SETTING

Set whether to enable or disable SNMP.

### VERSION

Set the version of the SNMP to be supported.

### COMMUNITY NAME 1 to 3

Set the name of the community required for the access.

### USER 1 to 3

Set the user name, password, authentication method and other options required for access.

### TRAP SETTING

Set whether to enable or disable the trap function. When this function is enabled, a trap will be sent when the monitor is turned on.

### TRAP SETTING OF AUTHENTICATION ERROR

Set whether the trap function sends a notification when authentication fails.

### TRAP ADDRESS & PORT

Set the destination address and port number of the notification sent by the trap function.

## ! Caution

- After you set SNMP, click [Switch the main power of monitor off and on now.] or turn off the monitor and then turn it on again with the main power switch. When the monitor restarts, wait about 30 seconds and then start the next operation.
- If the IP address is changed while the SNMP function is operational, turn off the monitor and then turn it on again with the main power switch.

## TIPS

- Depending on the SNMP settings, a short delay may occur before the SNMP is usable. (About 5 minutes)
- Up to 16 alphanumeric letters and symbols can be used for the community name, user name and password.

## ■SERVICE & SUPPORT (URL INFORMATION)

You can display a specific URL in the URL INFORMATION field on the INFORMATION screen when an error occurs in the monitor. (See page 50.)

**SERVICE & SUPPORT - URL INFORMATION**

URL INFORMATION: [Field] (1-64 alphanumeric)

CONDITION:  ALWAYS  TRIGGERING  MESSAGE

CONFIRMATION: [Field] (1-16 alphanumeric)

Buttons: [Apply] [Reset]

### URL INFORMATION

Enter the URL to display on the INFORMATION screen when an error occurs on the monitor.

Up to 64 alphanumeric characters or symbols can be used.

### CONDITION

Specify the condition to display the URL.

### CONFIRMATION

The home page of the specified URL is displayed.

You can check whether the URL you entered is correct.

## TIPS

- It is also possible to specify the message text, such as the name of a contact or a telephone number, to be displayed instead of the linked URL.

## ■Crestron Connected

Display the Crestron Connected control menu.

### Control Menu



1. Operate below functions.
  - Power..... Turn the power ON/OFF.
  - Mute..... Turns off the volume temporarily.
  - Vol-/Vol+..... Adjust the volume of the sound.
2. Change the input mode.
3. Operate below functions.
  - Contrast..... Adjusts the contrast.
  - Black Level.. Adjusts the brightness.
  - Colors..... Adjusts the color intensity.
  - Sharpness... Adjusts the sharpness.
4. Operate the menu screen for the monitor.
5. Switches the pages to tools, information, help tab.

### Tools

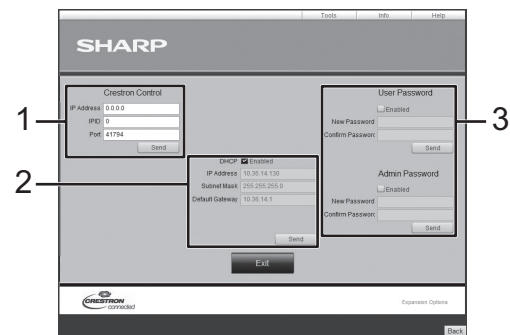

1. Settings for the Crestron Control.
2. Setting for monitor network.
  - DHCP
  - IP Address
  - Subnet Mask
  - Default Gateway
3. Security Setting.  
Sets the password for the user and administrators rights on Control Menu.

### Info

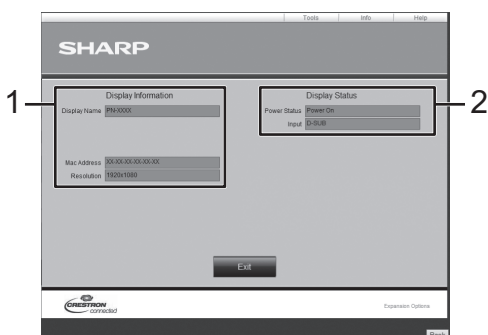

1. Display below information.
  - Display Name
  - Mac Address
  - Resolution
2. Display below status.
  - Power Status
  - Input

### Help



Sends or receives messages to the administrators who uses "Crestron Connected".

## [Advanced operation]

### Command-based control

You can control the monitor using RS-232C commands (see page 39) via terminal software and other appropriate applications.

In order to use this function, enable a connection to the monitor through the web browser.

Read the manual for the terminal software for detailed instructions.

#### (1) Connect the computer to the monitor.

1. Specify the IP address and data port number and connect the computer to the monitor.  
When connection has been established successfully, [Login:] is returned as response.
2. Send the user name set in the SECURITY settings. (See page 51.)
  - Send [User name] + [Enter].
  - If the user name is not set or if USE FOR Telnet CONNECTION is set to OFF, send [Enter].
  - When the transmission is successful, [Password:] is returned as response.
3. Send the password set in the SECURITY settings. (See page 51.)
  - Send [Password] + [Enter].
  - If the password is not set or if USE FOR Telnet CONNECTION is set to OFF, send [Enter].
  - When the transmission is successful, [OK Enter] is returned as response.

#### (2) Send commands to control the monitor.

- The commands used are the same as those for RS-232C. Refer to the communication procedure (see page 35) for operation.
- Usable commands are provided in the RS-232C command table. (See page 39.)

#### (3) Disconnect the connection with the monitor and quit the function.

1. Send [BYE Enter].  
When the transmission is successful, [goodbye] is returned and the connection is disconnected.

### TIPS

- Connection is automatically disconnected when the time specified in AUTO LOGOUT TIME elapses over a no-communication period.

# Troubleshooting

If you are experiencing any problem with your display, before calling for service, please review the following troubleshooting tips.

## **There is no picture or sound.**

- Is the power cord disconnected? (See page 13.)
- Is the main power switch off? (See page 17.)
- Is the monitor in standby mode (the power LED illuminating in orange)? (See page 17.)
- Make sure correct input mode is selected. (See page 20.)
- If any external equipment is connected, make sure the equipment is operating (playing back).

## **Remote control does not work.**

- Are the batteries inserted with polarity (+,-) aligned? (See page 15.)
- Are the batteries exhausted?
- Point the remote control unit toward the monitor's remote control sensor. (See page 15.)
- Is the menu display hidden or is operation disabled? (See page 34.)
- Do the remote control numbers on the remote control unit and on the monitor match?  
Check the numbers on INFORMATION. (See page 33.)

## **The remote control unit's buttons for operating the HDMI-connected device do not work.**

- Is HDMI CEC LINK set to AUTO under INPUT SELECT on the SETUP menu?
- Switch to a different input mode, and then try switching the input mode back to HDMI.

## **Sound from left and right speakers is reversed.**

### **Sound is heard from only one side.**

- Are audio cables connected properly?
- Check the setting of BALANCE for AUDIO menu. (See page 25.)

## **There is a picture but no sound.**

- Is the sound muted?
- Make sure the volume is not set to minimum.
- Are audio cables connected properly?
- Is the setting of AUDIO SELECT on the SETUP menu correct? (See page 26.)

## **Unstable video.**

- The signal may be incompatible.
- Try the automatic screen adjustment when D-SUB[RGB] is in use.

## **The video from the HDMI input terminal does not appear properly.**

- Is the HDMI cable HDMI standard compliant? The monitor will not work with cables that are not standard compliant.
- Is the input signal compatible with this monitor? (See pages 62 and 63.)

## **The video from the DVI-D input terminal does not appear properly.**

- Is the input signal compatible with this monitor? (See page 62.)
- Turn off the power to the connected equipment and then turn the power on again.

## **The video from D-Sub input terminal does not appear correctly.**

- Is the setting for D-SUB of INPUT SELECT on the SETUP menu correct? (See page 26.)
- Is the input signal compatible with this monitor? (See pages 62 and 63.)

## **The video from the DisplayPort does not appear properly.**

- Is the DisplayPort cable DisplayPort standard compliant? The monitor will not work with cables that are not standard compliant.
- Is the input signal compatible with this monitor? (See page 62.)
- If the monitors are connected in a daisy chain, turn off the power to all the monitors connected in a daisy chain and then turn the power on again.

## **Control buttons do not work.**

### **There is no picture.**

- Load noises from outside may be interfering with normal operation. Turn off the power and turn it on after waiting at least 5 seconds, and then check the operation.

## **The input mode changes automatically.**

- When NO SIGNAL AUTO INPUT SEL. is ON and the current video signal input stops, the input mode automatically changes to the mode of an active video signal.  
Consequently, the input mode may change even in the following cases:
  - When a computer enters standby mode.
  - When video play is stopped with a playback device.

## **Power LED flashes red.**

### **"STATUS [xxxx]" appears in the corner of the screen.**

- Hardware has a problem. Turn off the monitor and request repair from your SHARP dealer.  
(When STATUS ALERT is set to OSD & LED. This varies depending on the setting.)

## **When "AUTO DIMMING" is displayed.**

- When the internal temperature of the monitor rises excessively, the brightness of the backlight automatically decreases in order to prevent a further temperature rise. If you attempt to adjust the brightness while the monitor is in this state, "AUTO DIMMING" is displayed and you cannot change the brightness.
- Remove the cause of the excessive temperature rise.

## **The monitor makes a cracking sound.**

- You may occasionally hear a cracking sound from the monitor. This happens when the cabinet slightly expands and contracts according to change in temperature. This does not affect the monitor's performance.

## **The video does not appear properly even after the DisplayPort STREAM setting is changed.**

- Try restarting the monitor and computer.
- Is the video card MST (Multi Stream Transport) compatible? If not, set to SST (Single Stream Transport).



**The Power LED is flashing in red and green alternately.  
When “TEMPERATURE” is displayed in the corner of the screen.**

- When the internal temperature of the monitor rises excessively, the brightness of the backlight decreases automatically in order to prevent high-temperature-related problems. When this occurs, “TEMPERATURE” is displayed on the screen and the Power LED flashes red and green alternately. (When TEMPERATURE ALERT is set to OSD & LED. This varies depending on the setting.)
- If the internal temperature rises further, the monitor automatically enters standby mode. (The Power LED continues flashing red and green alternately.)
- Remove the cause of the excessive temperature rise.
  - If the monitor enters standby mode due to a rise in temperature, to return to normal display, turn the power switch off and then back on again. The monitor, however, will enter standby mode again if the cause of the temperature rise is not eliminated. (See page 7.)
  - Check whether the monitor is placed at a location where a quick rise in temperature is likely. Internal temperature rises quickly if the vents on the monitor are blocked.
  - Internal temperature rises quickly if dust accumulates inside the monitor or around the vents. Remove dust if possible. Ask SHARP dealer about removing internal dust.

# Specifications

## ■Product Specifications

Model		PN-R706	PN-R606
LCD component		70" Class [69-1/2 inch (176.56 cm) diagonal] TFT LCD	60" Class [60-1/8 inch (152.66 cm) diagonal] TFT LCD
Max. resolution	(pixels)	1920 x 1080	
Max. colors		Approx. 1.06 billion colors	
Pixel pitch		0.802 mm (H) × 0.802 mm (V)	0.693 mm (H) × 0.693 mm (V)
Max. brightness (typical)		700 cd/m <sup>2</sup> *1	
Contrast ratio (typical)		5000: 1	
Viewing angle		176° right/left/up/down (contrast ratio ≥ 10)	
Screen active area	inch (mm)	60-9/16 (W) x 34-1/16 (H) (1538.88 x 865.62)	52-3/8 (W) x 29-7/16 (H) (1330.56 x 748.44)
Computer input signal		Digital (DVI 1.0 standard-compliant), Analog RGB (0.7 Vp-p) [75 Ω], DisplayPort 1.2, HDMI	
Sync signal		Horizontal/vertical separate (TTL: positive/negative), Sync-on-green*2, Composite sync (TTL: positive/negative)*2	
Plug and play		VESA DDC2B	
Power management		VESA DPMS, DVI DMPM	
Input terminals	Video	HDMI x 2 DVI-D 24 pin (HDCP compatible) x 1 Mini D-sub 15 pin, 3 rows x 1 DisplayPort x 1	
	Audio	3.5 mm mini stereo jack x 1	
	Serial (RS-232C)	D-sub 9 pin x 1	
Output terminals	Video	DisplayPort x 1	
	Audio	3.5 mm mini stereo jack x 1	
	Serial (RS-232C)	D-sub 9 pin x 1	
LAN terminal		10 BASE-T/100 BASE-TX	
Power supply terminal		5 V, 2 A (5 V, 500 mA when the expansion slot is used) (USB Type-A connector)	
Expansion slot		12 V, 2.4 A (power supplied when expanding the functions with an optional part)	
Speaker output		10 W + 10 W	
Power requirement		AC 100 - 240 V, 2.6 A, 50/60 Hz	AC 100 - 240 V, 2.2 A, 50/60 Hz
Operating temperature *3		32°F to 104°F (0°C to 40°C)	
Operating humidity		20% to 80% (no condensation)	
Power consumption (Input signal waiting mode *4 / standby mode *5)		230 W (2.5 W / 0.5 W)	190 W (2.5 W / 0.5 W)
Dimensions (excluding protrusions)	inch (mm)	Approx. 62-3/16 (W) x 2-9/16 (D) x 36-1/8 (H) (1579 x 65 x 918)	Approx. 53-1/8 (W) x 2-3/8 (D) x 30-1/2 (H) (1349 x 60 x 775)
Weight	lbs. (kg)	Approx. 99.3 (45)	Approx. 72.8 (33)

\*1 Brightness will depend on input mode and other picture settings. Brightness level will decrease over time. Due to the nature of the equipment, it is not possible to precisely maintain a constant level of brightness.

\*2 D-Sub input terminal only.

\*3 When using the monitor laying flat on a surface (when the monitor is tilted more than 20 degrees upward or downward from the perpendicular in relation to a level surface), use the monitor at a temperature between 32°F (0°C) to 86°F (30°C). Temperature condition may change when using the monitor together with the optional equipments recommended by SHARP. In such cases, please check the temperature condition specified by the optional equipments.

\*4 When SUPPLY USB POWER is set to POWER ON ONLY and no optional part is attached.

\*5 When POWER SAVE MODE is set to ON, SUPPLY USB POWER is set to POWER ON ONLY, and no optional part is attached. When POWER SAVE MODE is set to OFF: 0.8 W

As a part of our policy of continuous improvement, SHARP reserves the right to make design and specification changes for product improvement without prior notice. The performance specification figures indicated are nominal values of production units. There may be some deviations from these values in individual units.

## Specifications

Model	PN-R556	PN-R496	PN-R426
LCD component	55" Class [54-5/8 inch (138.78cm) diagonal] TFT LCD	49" Class [48-1/2 inch (123.20cm) diagonal] TFT LCD	42" Class [41-7/8 inch (106.47cm) diagonal] TFT LCD
Max. resolution (pixels)	1920 x 1080		
Max. colors	Approx. 1.07 billion colors		
Pixel pitch	0.630 mm (H) × 0.630 mm (V)	0.559 mm (H) × 0.559 mm (V)	0.483 mm (H) × 0.483 mm (V)
Max. brightness (typical)	700 cd/m <sup>2</sup> *1		
Contrast ratio (typical)	1300: 1		
Viewing angle	178° right/left/up/down (contrast ratio ≥ 10)		
Screen active area inch (mm)	47-5/8 (W) x 26-13/16 (H) (1209.6 x 680.4)	42-1/4 (W) x 23-3/4 (H) (1073.8 x 604.0)	36-9/16 (W) x 20-9/16 (H) (927.94 x 521.96)
Computer input signal	Digital (DVI 1.0 standard-compliant), Analog RGB (0.7 Vp-p) [75 Ω], DisplayPort 1.2, HDMI		
Sync signal	Horizontal/vertical separate (TTL: positive/negative), Sync-on-green*2, Composite sync (TTL: positive/negative)*2		
Plug and play	VESA DDC2B		
Power management	VESA DPMS, DVI DMPM		
Input terminals	Video	HDMI x 2 DVI-D 24 pin (HDCP compatible) x 1 Mini D-sub 15 pin, 3 rows x 1 DisplayPort x 1	
	Audio	3.5 mm mini stereo jack x 1	
	Serial (RS-232C)	D-sub 9 pin x 1	
Output terminals	Video	DisplayPort x 1	
	Audio	3.5 mm mini stereo jack x 1	
	Serial (RS-232C)	D-sub 9 pin x 1	
LAN terminal	10 BASE-T/100 BASE-TX		
Power supply terminal	5 V, 2 A (5 V, 500 mA when the expansion slot is used) (USB Type-A connector)		
Expansion slot	12 V, 2.4 A (power supplied when expanding the functions with an optional part)		
Speaker output	10 W + 10 W		
Power requirement	AC 100 - 240 V, 2.0 A, 50/60 Hz	AC 100 - 240 V, 1.8 A, 50/60 Hz	AC 100 - 240 V, 1.5 A, 50/60 Hz
Operating temperature *3	32°F to 104°F (0°C to 40°C)		
Operating humidity	20% to 80% (no condensation)		
Power consumption (Input signal waiting mode *4 / standby mode *5)	175 W (2.5 W / 0.5 W)	155 W (2.5 W / 0.5 W)	135 W (2.5 W / 0.5 W)
Dimensions (excluding protrusions) inch (mm)	Approx. 48-7/16 (W) x 2-1/4 (D) x 27-5/8 (H) (1231 x 57 x 702)	Approx. 43-1/8 (W) x 2-1/4 (D) x 24-5/8 (H) (1095 x 57 x 626)	Approx. 37-3/8 (W) x 2-1/4 (D) x 21-3/8 (H) (949 x 57 x 543.5)
Weight lbs. (kg)	Approx. 55.1 (25)	Approx. 43 (19.5)	Approx. 34.2 (15.5)

\*1 Brightness will depend on input mode and other picture settings. Brightness level will decrease over time. Due to the nature of the equipment, it is not possible to precisely maintain a constant level of brightness.

\*2 D-Sub input terminal only.

\*3 When using the monitor laying flat on a surface (when the monitor is tilted more than 20 degrees upward or downward from the perpendicular in relation to a level surface), use the monitor at a temperature between 32°F (0°C) to 86°F (30°C). Temperature condition may change when using the monitor together with the optional equipments recommended by SHARP. In such cases, please check the temperature condition specified by the optional equipments.

\*4 When SUPPLY USB POWER is set to POWER ON ONLY and no optional part is attached.

\*5 When POWER SAVE MODE is set to ON, SUPPLY USB POWER is set to POWER ON ONLY, and no optional part is attached. When POWER SAVE MODE is set to OFF: 0.8 W

As a part of our policy of continuous improvement, SHARP reserves the right to make design and specification changes for product improvement without prior notice. The performance specification figures indicated are nominal values of production units. There may be some deviations from these values in individual units.

# Specifications

## ■ Dimensional Drawings

Note that the values shown are approximate values.

[PN-R706]

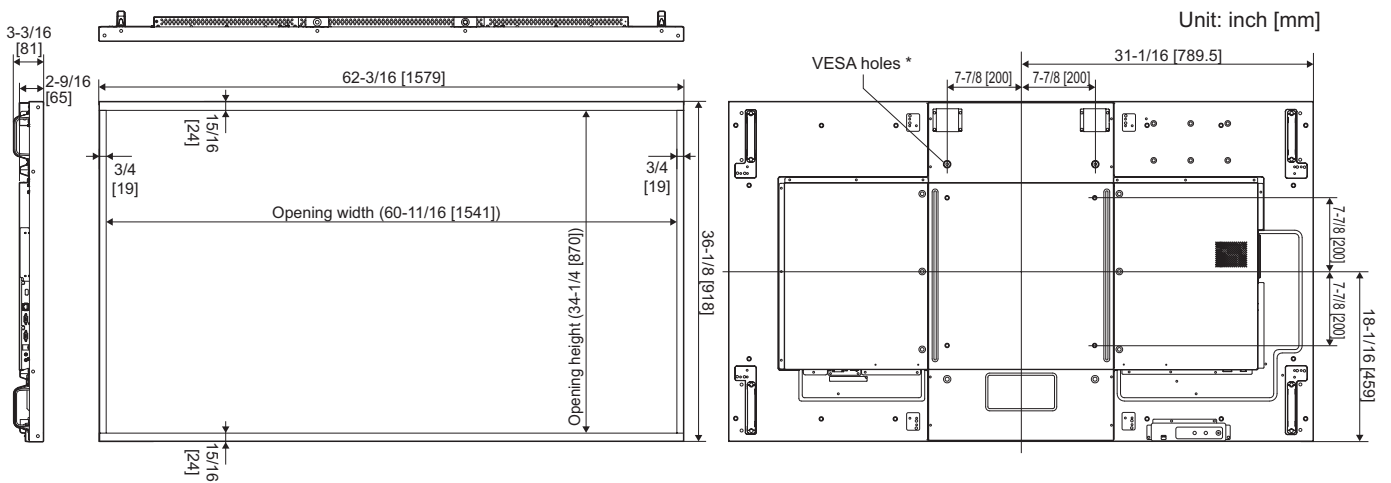

[PN-R606]

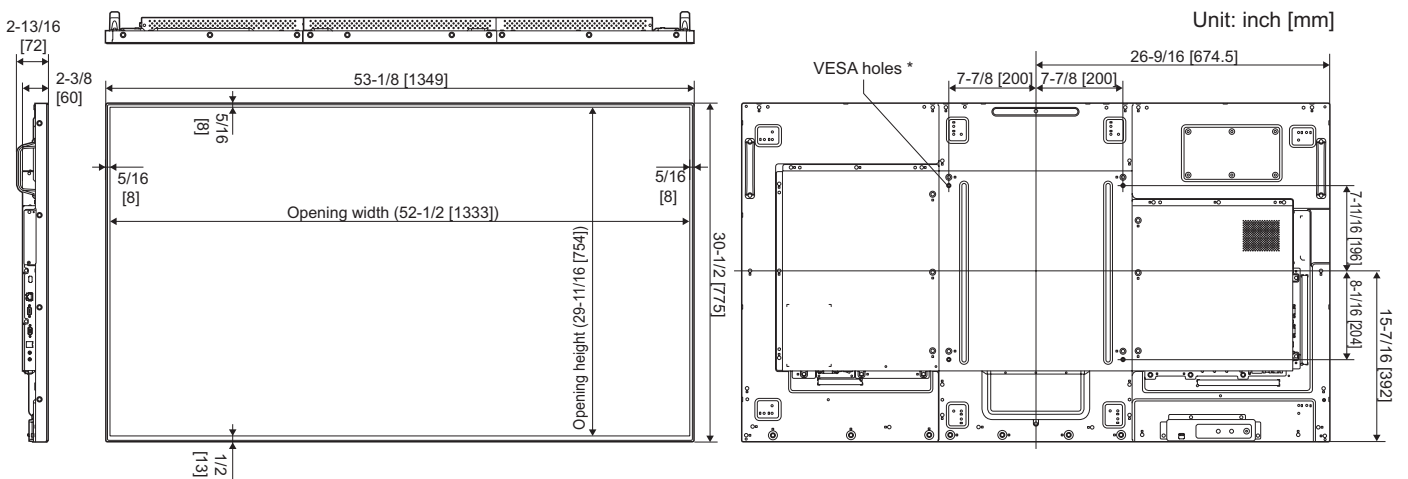

When mounting the monitor, be sure to use a wall-mount bracket that complies with the VESA-compatible mounting method. SHARP recommends using M6 screws and tighten the screws. Note that screw hole depth of the monitor is 9/16 inch (14 mm). Loose mounting may cause the product to fall, resulting in serious personal injuries as well as damage to the product. The screw and hole should come together with over 1/2 inch (12 mm) length of thread. Use a bracket which has been approved for UL1678 standard, and which can endure at least 4 times or more the weight of the monitor.

[PN-R556]

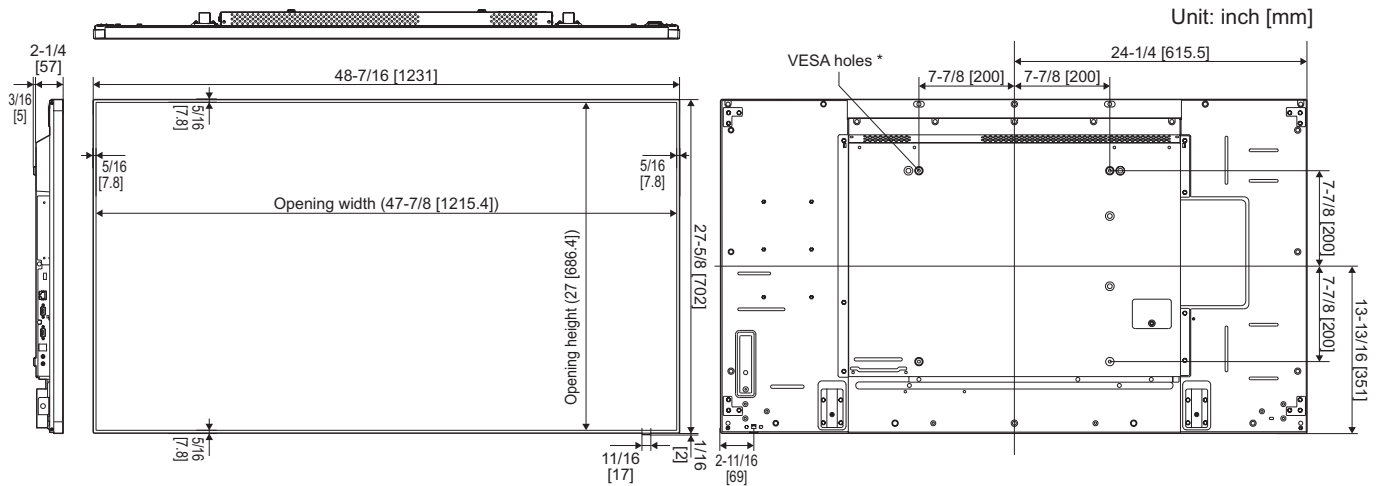

[PN-R496]

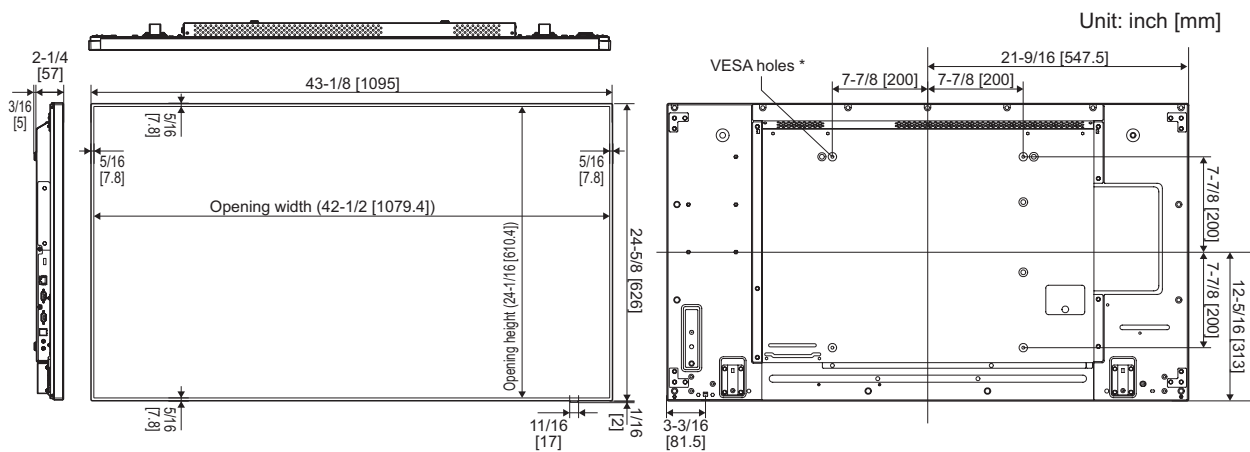

[PN-R426]

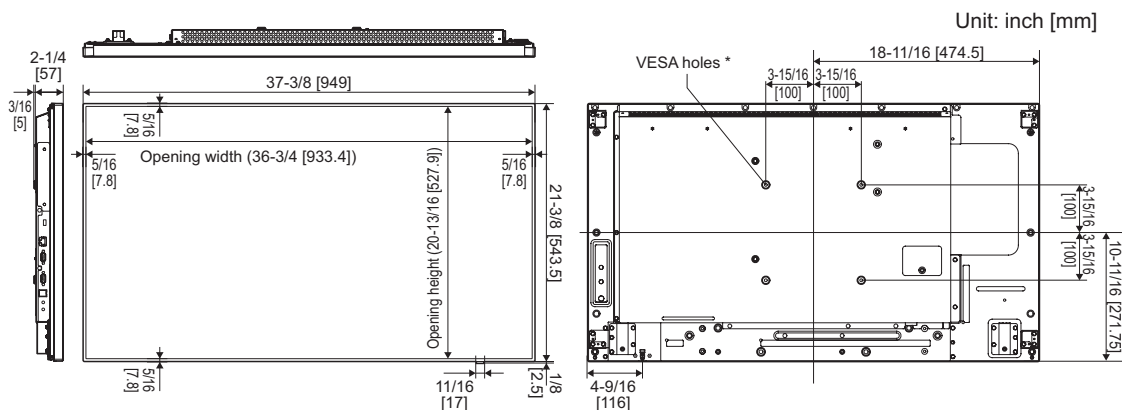

When mounting the monitor, be sure to use a wall-mount bracket that complies with the VESA-compatible mounting method. SHARP recommends using M6 screws and tighten the screws. Note that screw hole depth of the monitor is 3/8 inch (10 mm). Loose mounting may cause the product to fall, resulting in serious personal injuries as well as damage to the product. The screw and hole should come together with over 5/16 inch (8 mm) length of thread. Use a bracket which has been approved for UL1678 standard, and which can endure at least 4 times or more the weight of the monitor.

## ■DDC (plug and play)

The monitor supports the VESA DDC (Display Data Channel) standard. DDC is a signal standard for plug and play between monitors and computers. Information about resolution and other parameters is exchanged between the two. This function can be used if the computer supports DDC and it has been configured to detect plug-and-play monitors.

There are several types of DDC, depending on the communication method used. This monitor supports DDC2B.

## Specifications

### ■ Power management

This monitor conforms to VESA DPMS and DVI DMPM. Both your video card and computer must support the same standard in order for the monitor's power management function to work.

DPMS: Display Power Management Signaling

DPMS	Screen	Power consumption <sup>*1</sup>	Hsync	Vsync
ON STATE	Display	230 W 190 W 175 W 155 W 135 W	Yes	Yes
STANDBY	No display	2.5 W <sup>*2</sup> 2.5 W <sup>*2</sup> 2.5 W <sup>*2</sup> 2.5 W <sup>*2</sup>	No	Yes
SUSPEND			Yes	No
OFF STATE			No	No

DMPM: Digital Monitor Power Management

DMPM	Screen	Power consumption <sup>*1</sup>
Monitor ON	Display	230 W 190 W 175 W 155 W 135 W
Active OFF	No display	2.5 W <sup>*2</sup> 2.5 W <sup>*2</sup> 2.5 W <sup>*2</sup> 2.5 W <sup>*2</sup> 2.5 W <sup>*2</sup>

\*1 In order from the top, the values are for the PN-R706, PN-R606, PN-R556, PN-R496, and PN-R426.

\*2 When SUPPLY USB POWER is set to POWER ON ONLY and no optional part is attached.

### ■ Compatible signal timing (PC)

Screen resolution		Hsync	Vsync	Dot frequency	Digital			Analog (D-sub)
					DVI-D	HDMI	DisplayPort	
VESA	640 × 480	31.5kHz	60Hz	25.175MHz	Yes	Yes	Yes	Yes
		37.9kHz	72Hz	31.5MHz	Yes	Yes	Yes	Yes
		37.5kHz	75Hz	31.5MHz	Yes	Yes	Yes	Yes
	800 × 600	35.1kHz	56Hz	36.0MHz	-	-	-	Yes
		37.9kHz	60Hz	40.0MHz	Yes	Yes	Yes	Yes
		48.1kHz	72Hz	50.0MHz	Yes	Yes	Yes	Yes
		46.9kHz	75Hz	49.5MHz	Yes	Yes	Yes	Yes
	848 × 480	31.0kHz	60Hz	33.75MHz	Yes	-	-	Yes
	1024 × 768	48.4kHz	60Hz	65.0MHz	Yes	Yes	Yes	Yes
		56.5kHz	70Hz	75.0MHz	Yes	Yes	Yes	Yes
		60.0kHz	75Hz	78.75MHz	Yes	Yes	Yes	Yes
	1152 × 864	67.5kHz	75Hz	108.0MHz	Yes	Yes	Yes	Yes
	1280 × 768	47.8kHz	60Hz	79.5MHz	Yes	-	Yes	Yes
		60.3kHz	75Hz	102.25MHz	Yes	-	Yes	Yes
	1280 × 800	49.7kHz	60Hz	83.5MHz	Yes	Yes	Yes	Yes
	1280 × 960	60.0kHz	60Hz	108.0MHz	Yes	Yes	Yes	Yes
	1280 × 1024	64.0kHz	60Hz	108.0MHz	Yes	Yes	Yes	Yes
		80.0kHz	75Hz	135.0MHz	Yes	Yes	Yes	Yes
	1360 × 768	47.7kHz	60Hz	85.5MHz	Yes	Yes	Yes	Yes
1400 × 1050	65.3kHz	60Hz	121.75MHz	Yes	Yes	Yes	Yes	
1440 × 900	55.9kHz	60Hz	106.5MHz	Yes	Yes	Yes	Yes	
1600 × 1200 <sup>*1</sup>	75.0kHz	60Hz	162.0MHz	Yes	Yes	Yes	Yes	
1680 × 1050	65.3kHz	60Hz	146.25MHz	Yes	Yes	Yes	Yes	
1920 × 1200 <sup>*1</sup>	74.0kHz	60Hz	154.0MHz	Yes	Yes	-	Yes	
Wide	1280 × 720	44.7kHz	60Hz	74.4MHz	Yes	Yes	Yes	Yes
	1920 × 1080	67.5kHz	60Hz	148.5MHz	Yes	Yes	Yes	Yes
	3840 × 2160 <sup>*1*2</sup>	54.0kHz	24Hz	297.0MHz	-	Yes	Yes	-
		56.3kHz	25Hz	297.0MHz	-	Yes	Yes	-
		67.5kHz	30Hz	297.0MHz	-	Yes	Yes	-
4096 × 2160 <sup>*1*2</sup>	54.0kHz	24Hz	297.0MHz	-	Yes	-	-	
US TEXT	720 × 400	31.5kHz	70Hz	28.3MHz	Yes	Yes	Yes	Yes
Sun	1024 × 768	48.3kHz	60Hz	64.13MHz	-	-	-	Yes
		53.6kHz	66Hz	70.4MHz	-	-	-	Yes
		56.6kHz	70Hz	74.25MHz	-	-	-	Yes
	1152 × 900	61.8kHz	66Hz	94.88MHz	-	-	-	Yes
		71.8kHz	76.2Hz	108.23MHz	-	-	-	Yes
	1280 × 1024	71.7kHz	67.2Hz	117.01MHz	-	-	-	Yes
		81.1kHz	76Hz	134.99MHz	-	-	-	Yes
1600 × 1000	68.6kHz	66Hz	135.76MHz	-	-	-	Yes	

\*1 Displays a reduced image, except in Dot by Dot. In Dot by Dot, the image will be cut down to panel size then displayed.

\*2 Used when ENLARGE is ON. Using a single monitor for this setting causes image quality degradation. The image cannot be displayed on the sub screen.

- Depending on the connected computer, images may not be displayed properly even if the compatible signal described above is input.
- The frequency values for the Sun are reference values.

■Compatible signal timing (AV)

Screen resolution	Frequency	HDMI	Component
1920 × 1080p	24Hz	Yes	-
	50Hz	Yes	Yes
	59.94Hz	Yes	Yes
	60Hz	Yes	Yes
1920 × 1080i	50Hz	Yes	Yes
	59.94Hz	Yes	Yes
	60Hz	Yes	Yes
1280 × 720p	50Hz	Yes	Yes
	59.94Hz	Yes	Yes
	60Hz	Yes	Yes
720 × 576p	50Hz	Yes	Yes
720 × 480p	59.94Hz	Yes	Yes
	60Hz	Yes	Yes
640 × 480p(VGA)	59.94Hz	Yes	-
	60Hz	Yes	-
720(1440) × 576i	50Hz	Yes	Yes
720(1440) × 480i	59.94Hz	Yes	Yes
	60Hz	Yes	Yes

■HDMI input terminal pins  
(HDMI Connector)



No.	Function	No.	Function
1	TMDS data 2+	11	TMDS clock shield
2	TMDS data 2 shield	12	TMDS clock-
3	TMDS data 2-	13	CEC
4	TMDS data 1+	14	N.C.
5	TMDS data 1 shield	15	SCL
6	TMDS data 1-	16	SDA
7	TMDS data 0+	17	DDC/CEC GND
8	TMDS data 0 shield	18	+5V
9	TMDS data 0-	19	Hot-plug detection
10	TMDS clock+		

■D-sub input terminal pins  
(Mini D-sub 15 pin)

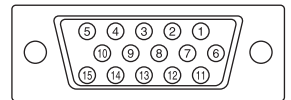

No.	Function	No.	Function
1	Red video signal input	9	+5V
2	Green video signal input	10	GND
3	Blue video signal input	11	N.C.
4	N.C.	12	DDC data
5	GND	13	Hsync signal input
6	GND for red video signal	14	Vsync signal input
7	GND for green video signal	15	DDC clock
8	GND for blue video signal		

■RS-232C input terminal pins  
(D-sub 9 pin)

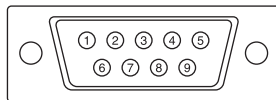

No.	Function	No.	Function
1	N.C.	6	N.C.
2	Transmitted data	7	N.C.
3	Received data	8	N.C.
4	N.C.	9	N.C.
5	GND		

■DisplayPort input terminal pins  
(DisplayPort 20 pin)

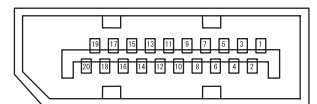

No.	Function	No.	Function
1	MainLane 3-	11	Gnd
2	Gnd	12	MainLane 0+
3	MainLane 3+	13	Gnd
4	MainLane 2-	14	Gnd
5	Gnd	15	Aux +
6	MainLane 2+	16	Gnd
7	MainLane 1-	17	Aux -
8	Gnd	18	Hot-plug detection
9	MainLane 1+	19	Gnd
10	MainLane 0-	20	3.3V

# Specifications

## ■DVI-D input terminal pins

(DVI-D 24 pin)

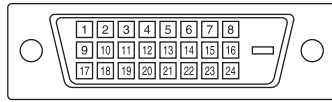

No.	Function	No.	Function
1	TMDS data 2-	13	N.C.
2	TMDS data 2+	14	+5V
3	TMDS data 2/4 shield	15	GND
4	N.C.	16	Hot-plug detection
5	N.C.	17	TMDS data 0-
6	DDC clock	18	TMDS data 0+
7	DDC data	19	TMDS data 0/5 shield
8	N.C.	20	N.C.
9	TMDS data 1-	21	N.C.
10	TMDS data 1+	22	TMDS clock shield
11	TMDS data 1/3 shield	23	TMDS clock+
12	N.C.	24	TMDS clock-

## ■RS-232C output terminal pins

(D-sub 9 pin)

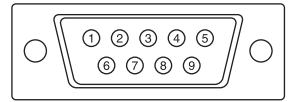

No.	Function	No.	Function
1	N.C.	6	N.C.
2	Received data	7	N.C.
3	Transmitted data	8	N.C.
4	N.C.	9	N.C.
5	GND		

## ■DisplayPort output terminal pins

(DisplayPort 20 pin)

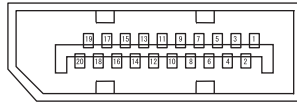

No.	Function	No.	Function
1	MainLane 0+	11	Gnd
2	Gnd	12	MainLane 3-
3	MainLane 0-	13	Gnd
4	MainLane 1+	14	Gnd
5	Gnd	15	Aux +
6	MainLane 1-	16	Gnd
7	MainLane 2+	17	Aux -
8	Gnd	18	Hot-plug detection
9	MainLane 2-	19	Gnd
10	MainLane 3+	20	3.3V



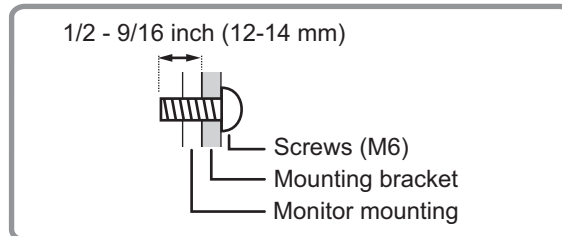

# Mounting Precautions (For SHARP dealers and service engineers)

- When installing, removing or moving the monitor, ensure that this is carried out by at least 3 people.  
(PN-R556/PN-R496/PN-R426: at least 2 people.)
- Be sure to use a wall-mount bracket designed or designated for mounting the monitor.
- This monitor is designed to be installed on a concrete wall or pillar. Reinforced work might be necessary for some materials such as plaster / thin plastic board / wood before starting installation.
- This monitor and bracket must be installed on a wall which can endure at least 4 times or more the weight of the monitor. Install by the most suitable method for the material and the structure.
- **[PN-R706/PN-R606]**  
To attach a VESA-compliant mounting bracket, use M6 screws that are 1/2 inch (12 mm) to 9/16 inch (14 mm) longer than the thickness of the mounting bracket.

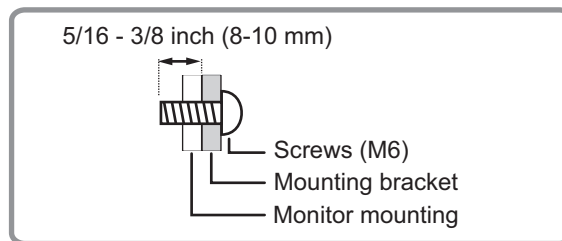

- **[PN-R556/PN-R496/PN-R426]**  
To attach a VESA-compliant mounting bracket, use M6 screws that are 5/16 inch (8 mm) to 3/8 inch (10 mm) longer than the thickness of the mounting bracket.



- Do not use an impact driver.
- **[PN-R706/PN-R606]**  
When moving the monitor, be sure to hold the handles or the top, bottom, and side areas shown in  in the figure below. Do not hold the LCD panel. This may cause product damage, failure, or injury.

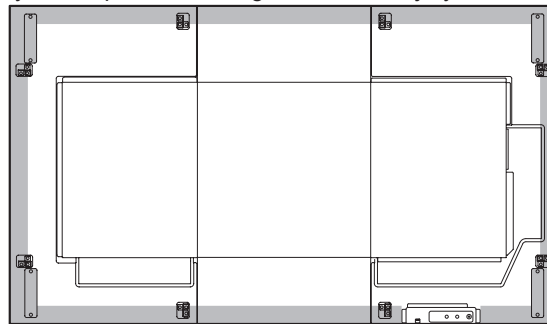

- **[PN-R556/PN-R496/PN-R426]**  
When moving the monitor, be sure to hold the top, bottom and side areas shown in  in the figure below. Do not hold the LCD panel. This may cause product damage, failure, or injury.

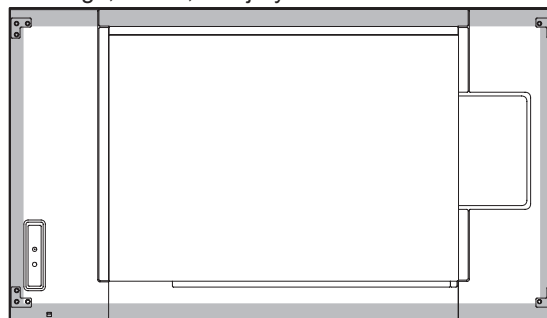

- After mounting, please carefully ensure the monitor is secure, and not able to come loose from the wall or mount.
- Do not use any screw holes other than VESA holes for installation.
- When using the monitor laying flat on a surface (when the monitor is tilted 20 degrees or more upward or downward from the perpendicular in relation to a level surface), consult an authorized SHARP dealer because there are some specific mounting conditions. (See page 7.)
- To conceal the eyebolt screw hole, affix an included hole cover stickers over the hole. (PN-R706 only)

**SHARP**<sup>®</sup>  
SHARP CORPORATION