

Micro Hi-Fi System



MC-120

MC-122

MC-130



PHILIPS

Important notes for users in the U.K.

Mains plug

This apparatus is fitted with an approved 13 Amp plug. To change a fuse in this type of plug proceed as follows:

- 1 Remove fuse cover and fuse.
- 2 Fix new fuse which should be a BS1362 5 Amp, A.S.T.A. or BSI approved type.
- 3 Refit the fuse cover.

If the fitted plug is not suitable for your socket outlets, it should be cut off and an appropriate plug fitted in its place.

If the mains plug contains a fuse, this should have a value of 5 Amp. If a plug without a fuse is used, the fuse at the distribution board should not be greater than 5 Amp.

Note: The severed plug must be disposed of to avoid a possible shock hazard should it be inserted into a 13 Amp socket elsewhere.

How to connect a plug

The wires in the mains lead are coloured with the following code: blue = neutral (N), brown = live (L).

- As these colours may not correspond with the colour markings identifying the terminals in your plug, proceed as follows:
 - Connect the blue wire to the terminal marked N or coloured black.
 - Connect the brown wire to the terminal marked L or coloured red.
 - Do not connect either wire to the earth terminal in the plug, marked E (or \perp) or coloured green (or green and yellow).

Before replacing the plug cover, make certain that the cord grip is clamped over the sheath of the lead - not simply over the two wires.

Copyright in the U.K.

Recording and playback of material may require consent. See Copyright Act 1956 and The Performer's Protection Acts 1958 to 1972.

Italia

DICHIARAZIONE DI CONFORMITA'

Si dichiara che l'apparecchio MC-120, MC-122, MC-130 Philips risponde alle prescrizioni dell'art. 2 comma 1 del D.M. 28 Agosto 1995 n. 548.

Fatto a Eindhoven

Philips Consumer Electronics
Philips, Glaslaan 2
5616 JB Eindhoven, The Netherlands

Norge

Typeskilt finnes på apparatens underside.

Observer: Nettbryteren er sekundert innkoplet. Den innebygde nettdelen er derfor ikke frakoplet nettet så lenge apparatet er tilsluttet nettkontakten.

For å redusere faren for brann eller elektrisk støt, skal apparatet ikke utsettes for regn eller fuktighet.

CAUTION

Use of controls or adjustments or performance of procedures other than herein may result in hazardous radiation exposure or other unsafe operation.

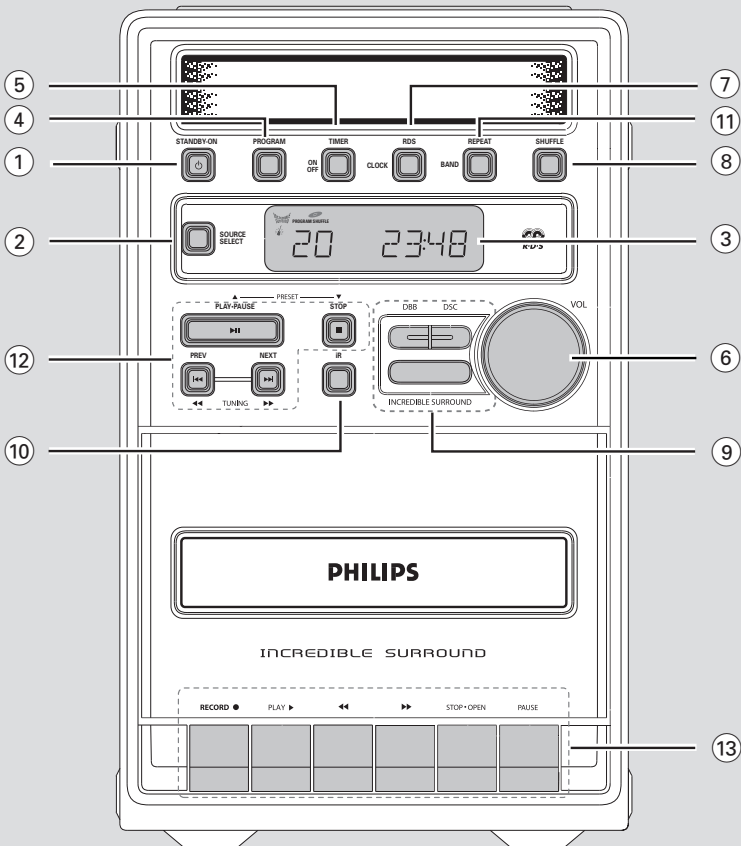
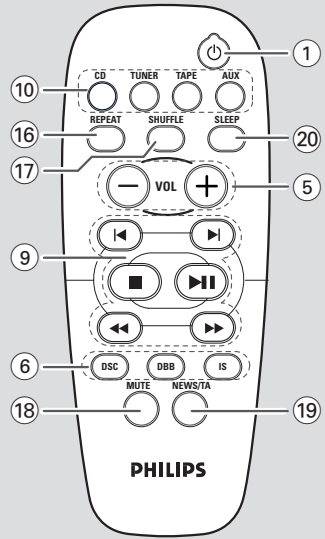
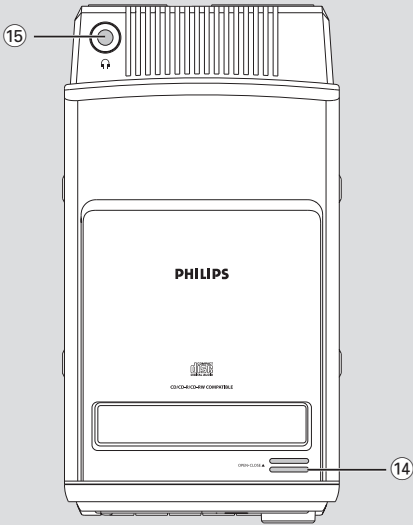

DK

Advarsel: Usynlig laserstråling ved åbning når sikkerhedsafbrydere er ude af funktion. Undgå udsættelse for stråling.

Bemærk: Netafbryderen er sekundært indkoblet og afbryder ikke strømmen fra nettet. Den indbyggede netdel er derfor tilsluttet til lysnettet så længe netstikket sidder i stikkontakten.

S

Klass 1 laseraparat

Varning! Om apparaten används på annat sätt än i denna bruksanvisning specificerats, kan användaren utsättas för osynlig laserstrålning, som överskrider gränsen för laserklass 1.

Observera! Stömbrytaren är sekundärt kopplad och bryter inte strömmen från nätet. Den inbyggda nätdelen är därför ansluten till elnätet så länge stickproppen sitter i vägguttaget.

SF

Luokan 1 laserlaite

Varoitus! Laitteen käyttäminen muulla kuin tässä käyttöohjeessa mainitulla tavalla saattaa altistaa käyttäjän turvallisuusluokan 1 ylittävälle näkymättömälle lasersäteilylle.

Oikeus muutoksiin varataan. Laite ei saa olla alttiina tippu- ja roiskevedelle.

Huom. Toiminnanvalitsin on kytketty toisiopuolelle, eikä se kytke laitetta irti sähköverkosta. Sisäänrakennettu verkko-osa on kytkettynä sähköverkkoon aina silloin, kun pistoke on pistorasiassa.

English	6
Français	23
Español	40
Deutsch	57
Nederlands	74
Italiano	91
Svenska	108
Dansk	125
Suomi	142
Português	159
Ελληνικά	176
Polski	193

English

Français

Español

Deutsch

Nederlands

Italiano

Svenska

Dansk

Suomi

Português

Ελληνικά

Polski

Contents

General Information

Environmental information	7
Supplied accessories	7
Safety information	7

Preparations

Rear connections	8–9
Optional connection	9
Inserting batteries into the remote control... ..	9

Controls

Controls on the system and remote control	10
---	----

Basic Functions

Switching the system on	11
Power-saving automatic standby	11
Adjusting volume and sound	11

CD Operation

Playing a disc	12
Selecting a different track	12
Finding a passage within a track	12
Different play modes: Shuffle and Repeat	13
Programming track numbers	13
Reviewing the programme	13
Erasing the programme	13

Radio Reception

Tuning to radio stations	14
Programming radio stations	14
Tuning to preset radio stations	15
RDS	15
EON	15
Searching programme type (PTY)	15
RDS News and Traffic Announcement (TA)	16

Tape Operation / Recording

Tape playback	17
General information on recording	17
Synchro start CD recording	17–18
Recording from the radio	18
Recording from the Aux	18

Maintenance

Clock/Timer

Setting the clock	19
Setting the timer	19
Activating and deactivating TIMER	19
Activating and deactivating SLEEP	20

Specifications

Troubleshooting

This product complies with the radio interference requirements of the European Community.

Environmental Information

All unnecessary packaging has been omitted. We have tried to make the packaging easy to separate into three materials: cardboard (box), polystyrene foam (buffer) and polyethylene (bags, protective foam sheet).

Your system consists of materials which can be recycled and reused if disassembled by a specialized company. Please observe the local regulations regarding the disposal of packaging materials, exhausted batteries and old equipment.

Supplied accessories

- 2 speaker boxes
- remote control
- AM loop antenna
- FM wire antenna

Safety Information

- Before operating the system, check that the operating voltage indicated on the typeplate (or the voltage indication beside the voltage selector) of your system is identical with the voltage of your local power supply. If not, please consult your dealer.
- Place the system on a flat, hard and stable surface.
- Place the system in a location with adequate ventilation to prevent internal heat build-up in your system. Allow at least 10 cm (4 inches) clearance from the rear and the top of the unit and 5 cm (2 inches) from each side.
- Do not expose the system, batteries or discs to excessive moisture, rain, sand or heat sources caused by heating equipment or direct sunlight.
- If the system is brought directly from a cold to a warm location, or is placed in a very damp room, moisture may condense on the lens of the disc unit inside the system. Should this occur, the CD player would not operate normally. Leave the power on for about one hour with no disc in the system until normal playback is possible.
- The mechanical parts of the set contain self-lubricating bearings and must not be oiled or lubricated.
- **When the system is switched to Standby mode, it is still consuming some power. To disconnect the system from the power supply completely, remove the AC power plug from the wall socket.**

Preparations

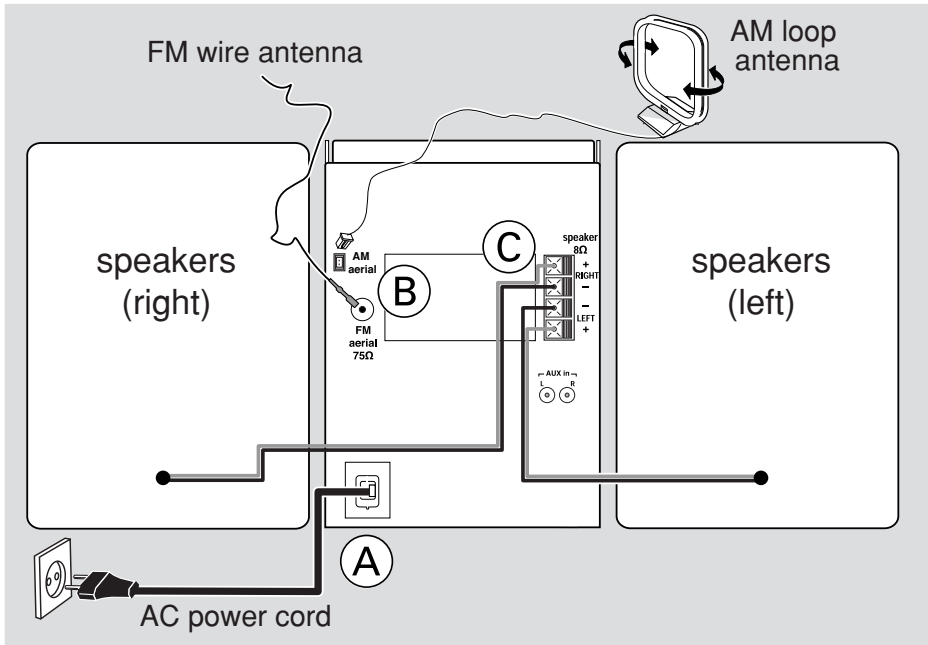

Rear connections

The type plate is located at the rear of the system.

A Power

Before connecting the AC power cord to the wall outlet, ensure that all other connections have been made.

WARNING!

- For optimal performance, use only the original power cable.
- Never make or change any connections with the power switched on.

To avoid overheating of the system, a safety circuit has been built in. Therefore, your system may switch to Standby mode automatically under extreme conditions. If this happens, let the system cool down before reusing it (not available for all versions).

B Antennas Connection

Connect the supplied AM loop antenna and FM antenna to the respective terminals. Adjust the position of the antenna for optimal reception.

AM Antenna

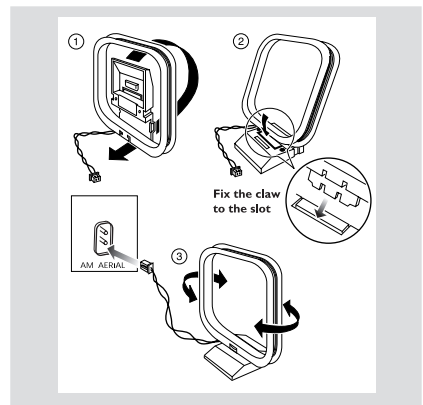

- Position the antenna as far as possible from a TV, VCR or other radiation source.

FM Antenna

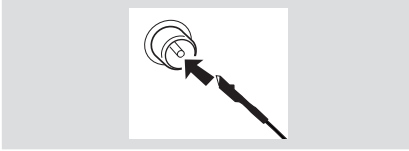

- For better FM stereo reception, connect an outdoor FM antenna to the FM AERIAL (FM ANTENNA) terminal.

C Speakers Connection

Front Speakers

Connect the speaker wires to the SPEAKERS terminals, right speaker to "RIGHT" and left speaker to "LEFT", coloured (marked) wire to "+" and black (unmarked) wire to "-".

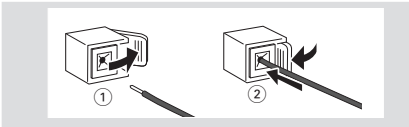

- Fully insert the stripped portion of the speaker wire into the terminal as shown.

Notes:

- For optimal sound performance, use the supplied speakers.
- Do not connect more than one speaker to any one pair of + / - speaker terminals.
- Do not connect speakers with an impedance lower than the speakers supplied. Please refer to the SPECIFICATIONS section of this manual.

Optional connection

The optional equipment and connecting cords are not supplied. Refer to the operating instructions of the connected equipment for details.

Connecting other equipment to your system

Connect the audio left and right OUT terminals of a TV, VCR, Laser Disc player, DVD player or CD Recorder to the **AUX IN** terminals.

Note:

- If you are connecting equipment with a mono output (a single audio out terminal), connect it to the AUX IN left terminal. Alternatively, you can use a "single to double" cinch cable (the output sound still remain mono).

Inserting batteries into the remote control

Insert two batteries (not supplied) type R03 or AAA into the remote control with the correct polarity as indicated by the "+" and "-" symbols inside the battery compartment.

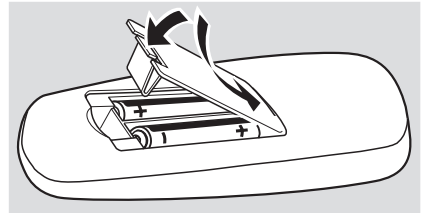



















CAUTION!



- Remove batteries if they are exhausted or will not be used for a long time.
- Do not use old and new or different types of batteries in combination.
- Batteries contain chemical substances, so they should be disposed off properly.

Controls on the system and remote control

- ① **STANDBY ON** 
 - switches the system to standby/on.
 - *on the remote control only* - switches the system to standby.
- ② **SELECT SOURCE**
 - selects the respective sound source for CD/TUNER/TAPE/AUX.
 - switches on the system.
- ③ **Display**
 - shows the status of the system.
- ④ **PROGRAM**
 - for CD programmes tracks and reviews the programme.
 - for Tuner programmes tuner stations manually or automatically.
- ⑤ **TIMER ON-OFF**
 - activates/deactivates or sets the timer function.
- ⑥ **VOLUME (VOL -/+)**
 - adjusts the volume level.
 - *on the system only* - adjusts the hour and minutes for the clock/timer functions.
- ⑦ **CLOCK / RDS**
 - for Tuner displays RDS information.
 - for Clock sets the clock function.
- ⑧ **SHUFFLE**
 - plays CD tracks in random order.
- ⑨ **INTERACTIVE SOUND controls:**
 - DBB** (Dynamic Bass Boost) enhances the bass.
 - DSC** (Digital Sound Control) selects sound characteristics: CLASSIC/ROCK/JAZZ/POP.
 - INCREDIBLE SURR.**
 - (IS)** creates a super-enhanced stereo effect.
- ⑩ **IR SENSOR**
 - infrared sensor for remote control.
- ⑪ **REPEAT / BAND**
 - for CD repeats a track/CD programme/entire CD.
 - for Tuner selects waveband.

- ⑫ **Mode Selection**
 - STOP**  stops CD playback or erase a CD programme.
 - PLAY-PAUSE**  **II**
 - starts or interrupts CD playback.
 - PRESET** 
 - ( ) selects a preset radio station.
 - PREV**  **/ NEXT** 
 - ( ) skips to the beginning of a current track/previous/subsequent track.
 - ( ) fast searches back and forward within a track/CD.
 - TUNING**  
 - ( ) tunes to radio stations.
- ⑬ **Tape Deck Operation**
 - RECORD** starts recording.
 - PLAY**  starts playback.
 -   fast rewinds/winds the tape.
 - STOP-OPEN** ... stops the tape; opens the tape compartment.
 - PAUSE** interrupts recording or playback.
- ⑭ **OPEN-CLOSE**
 - opens/closes the CD door:
- ⑮ 
 - connect headphones.
- ⑯ **REPEAT**
 - repeats a track/CD programme/entire CD.
- ⑰ **MUTE**
 - interrupts and resumes sound reproduction.
- ⑱ **NEWS/TA**
 - activates RDS news and Traffic Announcement.
- ⑲ **SLEEP**
 - activates/deactivates or selects the sleeper time.

Notes for remote control:

- **First select the source you wish to control by pressing one of the source select keys on the remote control (for example CD, TUNER).**
- **Then select the desired function (for example , , ).**

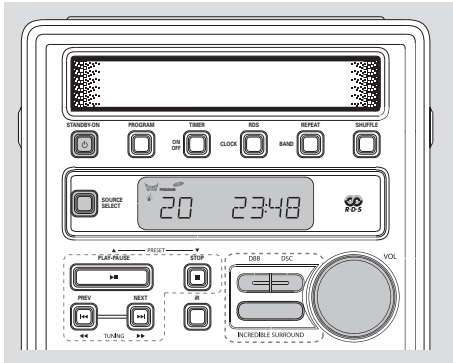

IMPORTANT:

Before you operate the system, complete the preparation procedures.

Switching the system on

- Press **STANDBY ON** or **SELECT SOURCE**.
→ The system will switch to the last selected source.
- Press **CD, TUNER, TAPE** or **AUX** on the remote control.
→ The system will switch to the selected source.

To switch the system to standby mode

- Press **STANDBY ON** on the system or remote control.
- If in tape mode or recording mode, press **STOP•OPEN** first.
→ The volume level, interactive sound settings, last selected source and tuner presets will be retained in the player's memory.

Power-saving automatic standby

As a power-saving feature, the system automatically switches to standby 15 minutes after a tape or CD has reached the end and no control is operated.

Adjusting volume and sound

- 1 Turn the **VOLUME** control anti-clockwise to decrease or clockwise to increase volume on the system (or press **VOL -/+** on the remote control).
→ Display shows the volume level **VOL** and a number from 0-32.
- 2 Press **DSC** repeatedly to select the desired sound effect: **CLASSIC** (no indication) / **ROCK** (🎸) / **JAZZ** (🎷) / **POP** (🎵).
- 3 Press **DBB** to switch bass enhancement on or off.
→ Display shows: **DBB** if the DBB is activated.
- 4 Press **INCREDIBLE SURR. (IS)** on the remote control to switch the surround sound effect on or off.
→ Display shows: **INCREDIBLE Surround** if activated.

Note:

– The effect of **INCREDIBLE SURROUND** may vary with different types of music.

- 5 Press **MUTE** on the remote control to interrupt sound reproduction instantly.
→ Playback will continue without sound and the display shows **MUTE**.
- To activate sound reproduction you can:
 - press **MUTE** again;
 - adjust the volume controls;
 - change source.

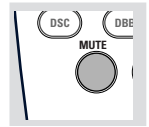

CD Operation

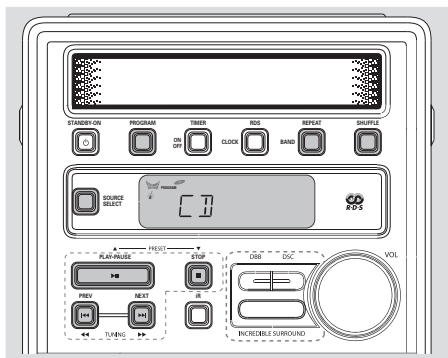

IMPORTANT:

The lens of the CD player should never be touched.

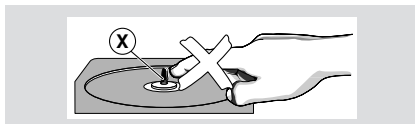

Playing a disc

This CD player plays Audio Discs including CD-Recordables and CD-Rewritables.

- CD-ROM, CD-I, CDV, VCD, DVD or computer CDs, however, are not possible.

- 1 Select **CD** source.
- 2 Press **OPEN•CLOSE** on the top of the system to open the CD compartment.
→ **OPEN** is displayed when open the CD compartment.

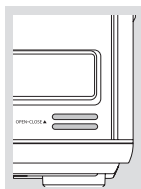

- 3 Insert a disc with the printed side facing up and press down on **OPEN•CLOSE** to close the CD door.
→ **READY** is displayed as the CD player scans the contents of a disc, and then the total number of tracks and playing time are shown.
- 4 Press **PLAY•PAUSE ►II** (on the remote control ►II) to start playback.
→ Current track number and elapsed playing time of the track are displayed during disc playback.

- 5 To interrupt playback press **PLAY•PAUSE ►II** (on the remote control ►II). Press **PLAY•PAUSE ►II** (on the remote control ►II) again to resume play.

→ The display freezes and the elapsed playing time flashes when playback is interrupted.

- 6 To stop disc playback, press **STOP ■**.

Note: CD play will also stop when;

- the CD door is opened.
- the disc has reached the end.
- you select another source: **TAPE, TUNER** or **AUX**.
- you select to standby.
- you press the tape deck **PLAY ►** key.

Selecting a different track

- Press **PREV ◀◀** or **NEXT ▶▶** (on the remote control ◀◀ or ▶▶) once or repeatedly until the desired track number appears in the display.
- If you have selected a track number shortly after loading a disc or in the PAUSE position, you will need to press **PLAY•PAUSE ►II** (on the remote control ►II) to start playback.

Finding a passage within a track

- 1 Press and hold down on **PREV ◀◀** or **NEXT ▶▶** (on the remote control ◀◀ or ▶▶).
→ The disc is played at high speed and low volume.
- 2 When you recognise the passage you want, release **PREV ◀◀** or **NEXT ▶▶** (on the remote control ◀◀ or ▶▶).
→ Normal playback continues.

Note:

- During a disc programme or if **SHUFFLE/REPEAT** active, searching is only possible within the same track.

Different play modes: SHUFFLE and REPEAT

You can select and change the various play modes before or during playback. The play modes can also be combined with PROGRAMME.

SHUFFLEtracks of the entire disc/ programme are played in random order

SHUFFLE and **REPEAT ALL** ...to repeat the entire disc/ programme continuously in random order

REPEAT ALL ...repeats the entire disc/ programme

REPEATplays the current track continuously

- 1 To select your play mode, press the **SHUFFLE** or **REPEAT** button before or during playback until the display shows the desired function.
- 2 Press **PLAY•PAUSE ▶II** (on the remote control ▶II) to start playback if in the STOP position.
→ If you have selected SHUFFLE, playback starts automatically.
- 3 To return to normal playback, press the respective **SHUFFLE** or **REPEAT** button until the various SHUFFLE/ REPEAT modes are no longer displayed.
- You can also press **STOP ■** to cancel your play mode.

Programming track numbers

Programme in the STOP position to select and store your disc tracks in the desired sequence. If you like, store any track more than once. Up to 20 tracks can be stored in the memory.

- 1 Press **PROGRAM** to enter the programming mode.
→ A track number is shown and **PROGRAM** flashes.
- 2 Use the **PREV ◀◀** or **NEXT ▶▶** (on the remote control ◀ or ▶) to select your desired track number.
- 3 Press **PROGRAM** to confirm the track number to be stored.
→ The number of tracks programmed and total playing time of the programme is shown briefly, then the selected track and *PRG5*.
- 4 Repeat steps 2-3 to select and store all desired tracks.
→ *FULL* is displayed if you attempt to programme more than 20 tracks.
- 5 To start playback of your disc programme, press **PLAY•PAUSE ▶II** (on the remote control ▶II).

Reviewing the programme

In STOP mode, press and hold down **PROGRAM** for a while until the display shows all your stored track numbers in sequence.

Erasing the programme

You can erase the programme by:

- pressing **STOP ■** once in the STOP mode;
- pressing **STOP ■** twice during playback;
- opening the CD compartment;
→ **PROGRAM** disappears from the display.

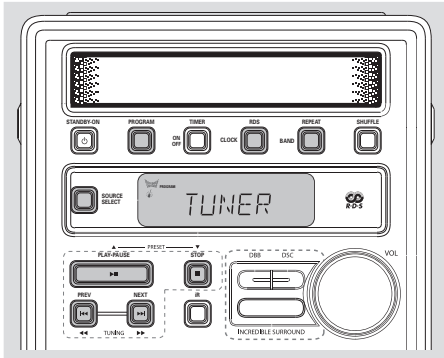

Tuning to radio stations

- 1 Select **TUNER** source.
→ **TUNER** is displayed briefly.
 - 2 Press **BAND** once or more to select your waveband.
 - 3 Press down on **TUNING** ◀◀ or ▶▶ and release button.
→ The radio automatically tunes to a station with sufficient reception. Display indication during automatic tuning: **SEARCH**.
→ If a FM station is received in stereo, **STEREO** is shown.
 - 4 Repeat step 3 if necessary until you find the desired station.
- To tune to a weak station, press **TUNING** ◀◀ or ▶▶ briefly and repeatedly until you have found optimal reception.

Programming radio stations

You can store up to a total of 40 radio stations in the memory.

Automatic programming

Automatic programming will start with a chosen preset number. From this preset number upwards, former programmed radio stations will be overridden. The system will only programme stations which are not in the memory already.

- 1 Press **PRESET** ▲ or ▼ (on the remote control ◀ or ▶) to select the preset number where programming should start.

Note:

– If no preset number is selected, default is preset (1) and all your presets will be overridden.

- 2 Press **PROGRAM** for more than 2 seconds to activate programming.
→ **AUTO** is displayed and available stations are programmed in order of waveband reception strength: FM followed by MW and LW. The last preset automatically stored will then be played.

Manual programming

- 1 Tune to your desired station (see Tuning to radio stations).
 - 2 Press **PROGRAM** to activate programming.
→ **PROGRAM** flashes in the display.
 - 3 Press **PRESET** ▲ or ▼ (on the remote control ◀ or ▶) to allocate a number from 1 to 40 to this station.
 - 4 Press **PROGRAM** again to confirm the setting.
→ **PROGRAM** disappears, the preset number and the frequency of the preset station are shown.
 - 5 Repeat the above four steps to store other stations.
- You can override a preset station by storing another frequency in its place.

Tuning to preset radio stations

- Press **PRESET ▲** or **▼** (on the remote control **◀** or **▶**) until the desired preset station is displayed.

RDS

Radio Data System is a service that allows FM stations to show additional information. If you are receiving a RDS station, **R·D·S** and the station name are displayed.

When automatic programming is used, RDS stations will be programmed first.

Scrolling through different RDS information

- Press **RDS** briefly and repeatedly to scroll through the following information (if available):
 - Station name
 - Programme type such as *NEWS, SPORT, POP M ...*
 - Radio text messages
 - Frequency

Note:

- If you press **RDS** and the RDS signal is not available **NO RDS** is displayed.

EON

Enhanced Other Network allows you to search for an RDS station offering a certain programme type. If EON is available, **EON** is shown.

Searching programme type (PTY)

PTY helps you find a desired programme type. To enable PTY, first programme RDS stations into the tuner memory (see Programming radio stations)

- 1 While receiving an RDS station, press **RDS** briefly until the programme type is displayed.
- 2 Press **PRESET ▲** or **▼** (on the remote control **◀** or **▶**) until the desired programme type is displayed.
- 3 Press and hold down on **TUNING ◀◀** or **▶▶** (on the remote control **◀◀** or **▶▶**) to start searching.

→ The radio tunes to a RDS station broadcasting this programme type. If the programme type is not available **TYPE NOT FOUND** is displayed.

RDS Programme types

NO TYPE	No RDS programme type
NEWS	News services
AFFAIRS	Politics and current affairs
INFO	Special information programmes
SPORT	Sports
EDUCATE	Education and advanced training
DRAMA	Radio plays and literature
CULTURE	Culture, religion and society
SCIENCE	Science
VARIETY	Entertainment programmes
POP M	Pop music
ROCK M	Rock music
MOR M	Light music
LIGHT M	Light classical music
CLASSICS	Classical music
OTHER M	Special music programmes

RDS News and Traffic Announcement (TA)

You may set up the tuner in such a way that listening to CD or tape is interrupted by the **NEWS** of a RDS station. This only works if the RDS station broadcasts a **NEWS** signal while sending the news.

Radio Reception

- 1 Tune to the desired RDS station.
- 2 Press **NEWS/TA** once or more on the remote control to select the NEWS option.
 - **NEWS ON, TR ON** or **OFF** is displayed briefly.
 - **NEWS** is displayed if you have activated the NEWS or TA option. Changing listening source will not disarm the function.

Notes:

- To avoid unwanted recordings, the NEWS announcement does not work while recording a tape.
- When you receive RDS news or traffic announcements during CD playback, playback will pause and you will be able to hear the news/TA. Playback resumes after the broadcast has finished. In tape mode, the tape continues playing but you will hear the news/TA only until the broadcast has finished.
- If you are using the RDS NEWS announcement with an EON station, the whole network is searched for the respective news.

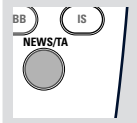

Disarming RDS News and Traffic Announcement

There are a number of ways to disarm the news feature:

- Press **NEWS/TA** on the remote control during reception of the news option.
- Press **STANDBY ON** on the system or remote control.
- Tune to a non-RDS-station.

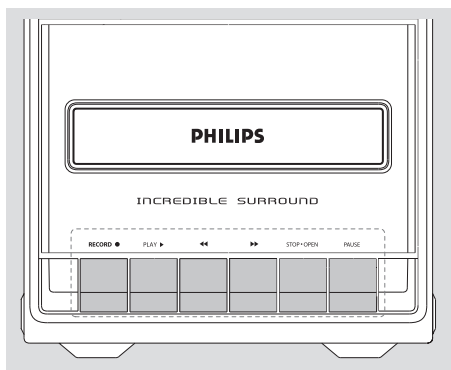

Tape playback

- 1 Select **TAPE** source.
→ The display shows **TAPE** throughout tape operation.
- 2 Press **STOP-OPEN** to open the tape door.
- 3 Insert a recorded tape and close the tape door.
 - Load the tape with the open side downward and the full spool to the left.
- 4 Press **PLAY ▶** to start playback.
- 5 To interrupt playback, press **PAUSE**. To resume, press this key again.
- 6 By pressing **◀◀** or **▶▶** on the system fast winding of tape is possible in both directions.
- 7 To stop the tape, press **STOP-OPEN**.
 - The keys are automatically released at the end of the tape, except if **PAUSE** has been activated.

Note:

- The sound source cannot be changed while recording a tape.

General information on recording

- Recording is permissible insofar as copyright or other rights of third parties are not infringed.
- For recording, use only **NORMAL** (IEC type I) tapes on which the tabs have not yet been broken. This deck is not suited for recording on **METAL** (IEC IV) type tapes.
- The best recording level is set automatically. Altering the **VOLUME**, **INCREDIBLE SURROUND**, **DBB** or **INTERACTIVE SOUND** controls will not affect the recording in progress.
- At the very beginning and end of the tape, no recording will take place during the 7 seconds when the leader tape passes the recorder heads.
- To protect a tape from accidental erasure, have the tape in front of you and break out the left tab. Recording on this side is no longer possible. If, however, you wish to record over this side again, cover the tabs with a piece of adhesive tape.

Synchro start CD recording

- 1 Select **CD** source.
- 2 Insert a disc and if desired, programme track numbers.
- 3 Press **STOP-OPEN** to open the tape door.
- 4 Insert a suitable tape into the deck and close the tape door.
- 5 Press **RECORD** to start recording.
→ Playing of the CD programme starts automatically from the beginning of the CD after 7 seconds. It is not necessary to start the CD player separately.

To select and record a particular passage within a track:

- Press and hold down on **PREV ◀◀** or **NEXT ▶▶** (on the remote control **◀◀** or **▶▶**).
- When you recognise the passage you want, release **PREV ◀◀** or **NEXT ▶▶**.
- To interrupt disc playback, press **PLAY-PAUSE ▶||** (on the remote control **▶||**).
- Recording will begin from this exact point in the track when you press **RECORD**.

Tape Operation / Recording

- For brief interruptions during recording, press **PAUSE**. To resume recording, press **PAUSE** again.
- To stop recording, press **STOP•OPEN**.

Recording from the radio

- Tune to the desired radio station (see Tuning to radio stations).
- Press **STOP•OPEN** to open the tape door.
- Insert a suitable tape into the deck and close the tape door.
- Press **RECORD** to start recording.
- For brief interruptions, press **PAUSE**. To resume recording, press **PAUSE** again.
- To stop recording, press **STOP•OPEN**.

Recording from Aux

- Select **AUX** source.
- If necessary, prepare the additional appliance for recording.
- Press **RECORD** to start recording.

Maintenance

Cleaning the Cabinet

- Use a soft cloth slightly moistened with a mild detergent solution. Do not use a solution containing alcohol, spirits, ammonia or abrasives.

Cleaning Discs

- When a disc becomes dirty, clean it with a cleaning cloth. Wipe the disc from the centre out.
- Do not use solvents such as benzene, thinner, commercially available cleaners, or antistatic spray intended for analogue records.

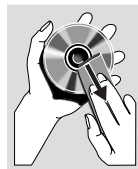

Cleaning the disc lens

- After prolonged use, dirt or dust may accumulate at the disc lens. To ensure good playback quality, clean the disc lens with Philips CD Lens Cleaner or any commercially available cleaner. Follow the instructions supplied with cleaner.

Cleaning the Heads and the Tape Paths

- To ensure good recording and playback quality, clean the heads (A), the capstan(s) (B), and pressure roller(s) (C) after every 50 hours of tape operation.
- Use a cotton swab slightly moistened with cleaning fluid or alcohol.
- You can also clean the heads by playing a cleaning tape once.

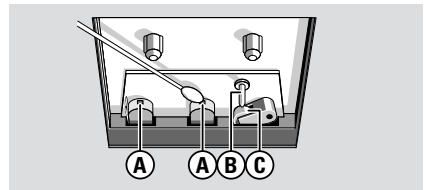

Demagnetising the heads

- Use a demagnetising tape available at your dealer.

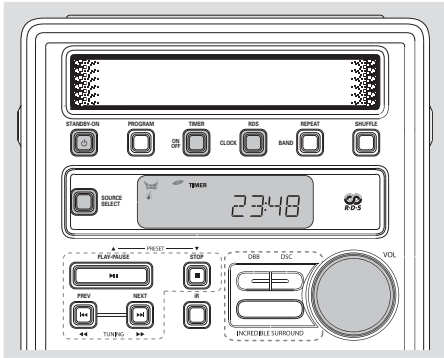

Setting the clock

There are two possible methods for setting the clock: manually or automatically by using RDS.

Automatic clock setting (RDS versions only)

- 1 Tune to a RDS station (see Radio Reception).
- 2 Press **CLOCK** for more than 2 seconds.
→ **SEARCH RDS TIME** is displayed for a maximum of 90 seconds; the time is then displayed.
→ **NO RDS TIME** is displayed if no time signal has been received and you will have to set the clock manually.

Manual clock setting

- 1 In standby, press **CLOCK**.
→ The clock digits for the hours flash.
- 2 Turn **VOLUME** to set the hours: clockwise for hours up; anti-clockwise for hours down.
- 3 Press **CLOCK** again.
→ The clock digits for the minutes flash.
- 4 Turn **VOLUME** to set the minutes: clockwise for minutes up; anti-clockwise for minutes down.
- 5 Press **CLOCK** to confirm the time.

Setting the timer

- The system can be used as an alarm clock, whereby the CD or TUNER is switched on at a set time. The clock time needs to be set first before the timer can be used.
- During setting, if no button is pressed within 90 seconds, the system will exit timer setting mode automatically.

- 1 In any mode, press **TIMER ON-OFF** for more than 2 seconds.
- 2 Turn **VOLUME** clockwise (or press **SELECT SOURCE**) to select sound source.
- 3 Press **TIMER ON-OFF** to confirm your desired mode.
→ The selected source **CD** or **TUNER** is shown. The clock digits for the hours flash.
- 4 Turn **VOLUME** to set the hours: clockwise for hours up; anti-clockwise for hours down.
- 5 Press **TIMER ON-OFF** again.
→ The clock digits for the minutes flash.
- 6 Turn **VOLUME** to set the minutes: clockwise for minutes up; anti-clockwise for minutes down.
- 7 Press **TIMER ON-OFF** to confirm the time.
→ The timer is now set and activated.

Activating and deactivating TIMER

- In standby or during playback, press **TIMER ON-OFF** once.
→ Display shows **TIMER** if activated, and disappears if deactivated.

Clock/Timer

Activating and deactivating SLEEP

The sleep timer enables the system to switch off by itself after a set period of time. The clock time needs to be set first before the sleep timer can be used.

- Press **SLEEP** on the remote control once or more.

→ Display shows *SLEEP* and one of the sleep time options in sequence: 60, 45, 30, 15, *SLEEP OFF*, 60... if you have selected a time. Once **SLEEP** is activated, *SLEEP ON* scrolls across the display at repeated intervals.

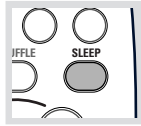

- To deactivate, press **SLEEP** on the remote control once or more until *SLEEP OFF* is shown, or press **STANDBY ON** on the system or remote control.
→ *SLEEP OFF* scrolls across the display.

Specifications

AMPLIFIER

Output power 2 x 5 W RMS
..... 10 W + 10 W MPO
Signal-to-noise ratio ≥ 65 dBA (IEC)
Frequency response 40 – 20000 Hz, ± 3 dB
Input sensitivity AUX 0.5 V (max. 2 V)
Impedance loudspeakers 8 Ω
Impedance headphones 32 Ω – 1000 Ω

CD PLAYER

Frequency range 20 – 20000 Hz
Signal-to-noise ratio 75 dBA

TUNER

FM wave range 87.5 – 108 MHz
MW wave range 531 – 1602 kHz
LW wave range 153 – 279 kHz
Sensitivity at 75 Ω
– mono, 26 dB signal-to-noise ratio 2.8 μV
– stereo, 46 dB signal-to-noise ratio 61.4 μV
Selectivity ≥ 28 dB
Total harmonic distortion ≤ 5%
Frequency response 63 – 12500 Hz (± 3 dB)
Signal-to-noise-ratio ≥ 50 dBA

TAPE DECK

Frequency response
Normal tape (type I) ... 120 – 10000 Hz (8 dB)
Signal-to-noise ratio
Normal tape (type I) 48 dBA
Wow and flutter ≤ 0.4% DIN

SPEAKERS

Bass reflex system
Dimensions (w x h x d) . 140 x 231 x 202 (mm)

GENERAL INFORMATION

AC Power 220 – 230 V / 50 Hz
Dimensions (w x h x d) ... 140 x 231 x 280 (mm)
Weight (with/without speakers)
..... approx. 5.7 / 2.7 kg
Standby power consumption < 3 W

Subject to modification

WARNING

Under no circumstances should you try to repair the system yourself, as this will invalidate the warranty. Do not open the system as there is a risk of electric shock.

If a fault occurs, first check the points listed below before taking the system for repair. If you are unable to remedy a problem by following these hints, consult your dealer or service centre.

Problem	Solution
CD OPERATION	
"NO DISC" is displayed.	<ul style="list-style-type: none"> – Insert a disc. – Check if the disc is inserted upside down. – Wait until the moisture condensation at the lens has cleared. – Replace or clean the disc, see "Maintenance". – Use a finalised CD-RW or CD-R.
RADIO RECEPTION	
Radio reception is poor.	<ul style="list-style-type: none"> – If the signal is too weak, adjust the antenna or connect an external antenna for better reception. – Increase the distance between the Micro HiFi System and your TV or VCR.
TAPE OPERATION / RECORDING	
Recording or playback cannot be made.	<ul style="list-style-type: none"> – Clean deck parts, see "Maintenance". – Use only normal (IEC I) tape for recording. – Apply a piece of adhesive tape over the missing tab space.
GENERAL	
The system does not react when buttons are pressed.	<ul style="list-style-type: none"> – Remove and reconnect the AC power plug and switch on the system again.
Sound cannot be heard or is of poor quality.	<ul style="list-style-type: none"> – Adjust the volume. – Disconnect the headphones. – Check that the speakers are connected correctly. – Check if the stripped speaker wire is clamped.
The left and right sound outputs are reversed.	<ul style="list-style-type: none"> – Check the speaker connections and location.

Troubleshooting

The remote control does not function properly.

- Select the source (CD or TUNER, for example) before pressing the function button (▶, ◀, ▶).
 - Reduce the distance between the remote control and the system.
 - Insert the batteries with their polarities (+/- signs) aligned as indicated.
 - Replace the batteries.
 - Point the remote control directly toward IR sensor on the front of the system.
-

The timer is not working.

- Set the clock correctly.
 - Press TIMER ON•OFF to switch on the timer.
 - If a recording is in progress, stop the recording.
-

The Clock/Timer setting is erased.

- Power has been interrupted or the power cord has been disconnected. Reset the clock/timer.
-