



VivoPC VM Series

User Manual

E9486

First Edition

June 2014

COPYRIGHT INFORMATION

No part of this manual, including the products and software described in it, may be reproduced, transmitted, transcribed, stored in a retrieval system, or translated into any language in any form or by any means, except documentation kept by the purchaser for backup purposes, without the express written permission of ASUSTeK COMPUTER INC. ("ASUS").

ASUS PROVIDES THIS MANUAL "AS IS" WITHOUT WARRANTY OF ANY KIND, EITHER EXPRESS OR IMPLIED, INCLUDING BUT NOT LIMITED TO THE IMPLIED WARRANTIES OR CONDITIONS OF MERCHANTABILITY OR FITNESS FOR A PARTICULAR PURPOSE. IN NO EVENT SHALL ASUS, ITS DIRECTORS, OFFICERS, EMPLOYEES OR AGENTS BE LIABLE FOR ANY INDIRECT, SPECIAL, INCIDENTAL, OR CONSEQUENTIAL DAMAGES (INCLUDING DAMAGES FOR LOSS OF PROFITS, LOSS OF BUSINESS, LOSS OF USE OR DATA, INTERRUPTION OF BUSINESS AND THE LIKE), EVEN IF ASUS HAS BEEN ADVISED OF THE POSSIBILITY OF SUCH DAMAGES ARISING FROM ANY DEFECT OR ERROR IN THIS MANUAL OR PRODUCT.

Products and corporate names appearing in this manual may or may not be registered trademarks or copyrights of their respective companies, and are used only for identification or explanation and to the owners' benefit, without intent to infringe.

SPECIFICATIONS AND INFORMATION CONTAINED IN THIS MANUAL ARE FURNISHED FOR INFORMATIONAL USE ONLY, AND ARE SUBJECT TO CHANGE AT ANY TIME WITHOUT NOTICE, AND SHOULD NOT BE CONSTRUED AS A COMMITMENT BY ASUS. ASUS ASSUMES NO RESPONSIBILITY OR LIABILITY FOR ANY ERRORS OR INACCURACIES THAT MAY APPEAR IN THIS MANUAL, INCLUDING THE PRODUCTS AND SOFTWARE DESCRIBED IN IT.

Copyright © 2014 ASUSTeK COMPUTER INC. All Rights Reserved.

LIMITATION OF LIABILITY

Circumstances may arise where because of a default on ASUS' part or other liability, you are entitled to recover damages from ASUS. In each such instance, regardless of the basis on which you are entitled to claim damages from ASUS, ASUS is liable for no more than damages for bodily injury (including death) and damage to real property and tangible personal property; or any other actual and direct damages resulted from omission or failure of performing legal duties under this Warranty Statement, up to the listed contract price of each product.

ASUS will only be responsible for or indemnify you for loss, damages or claims based in contract, tort or infringement under this Warranty Statement.

This limit also applies to ASUS' suppliers and its reseller. It is the maximum for which ASUS, its suppliers, and your reseller are collectively responsible.

UNDER NO CIRCUMSTANCES IS ASUS LIABLE FOR ANY OF THE FOLLOWING: (1) THIRD-PARTY CLAIMS AGAINST YOU FOR DAMAGES; (2) LOSS OF, OR DAMAGE TO, YOUR RECORDS OR DATA; OR (3) SPECIAL, INCIDENTAL, OR INDIRECT DAMAGES OR FOR ANY ECONOMIC CONSEQUENTIAL DAMAGES (INCLUDING LOST PROFITS OR SAVINGS), EVEN IF ASUS, ITS SUPPLIERS OR YOUR RESELLER IS INFORMED OF THEIR POSSIBILITY.

SERVICE AND SUPPORT

Visit our multi-language web site at <http://support.asus.com>

Contents

About this manual	4
Conventions used in this manual	4
Typography.....	4
Package contents.....	5
Getting to know your VivoPC	7
Features	8
Front panel.....	8
Left side	9
Rear panel	10
Using your VivoPC	13
Getting started.....	14
Connect the AC power adapter to your VivoPC	14
Connect a display panel to your VivoPC	16
Connect the USB cable from keyboard or mouse	17
Turn on your Vivo PC.....	18
Turning your VivoPC off	19
Putting your VivoPC to sleep	19
Entering the BIOS Setup	19
Quickly enter the BIOS.....	20
Memory upgrade	21
Upgrading memory modules.....	22
Appendix	29
Safety information	30
Setting up your system.....	30
Care during use	30
Regulatory notices.....	32
ASUS contact information	38

About this manual

This manual provides information about the hardware and software features of your PC, organized through the following chapters:

Chapter 1: Getting to know your VivoPC

This chapter details the hardware components of your VivoPC.

Chapter 2: Using your VivoPC

This chapter provides you with information on using your VivoPC.

Chapter 3: Memory upgrade

This chapter provides you with information on how to upgrade the memory modules of your VivoPC.

Appendices

This section includes notices and safety statements your VivoPC.

Conventions used in this manual

To highlight key information in this manual, some text are presented as follows:

IMPORTANT! This message contains vital information that must be followed to complete a task.

NOTE: This message contains additional information and tips that can help complete tasks.

WARNING! This message contains important information that must be followed to keep you safe while performing certain tasks and prevent damage to your Vivo PC's data and components.

Typography

Bold text

Indicates a menu or an item to select.

Italic

This indicates sections that you can refer to in this manual.

Package contents

Your VivoPC package contains the following items:

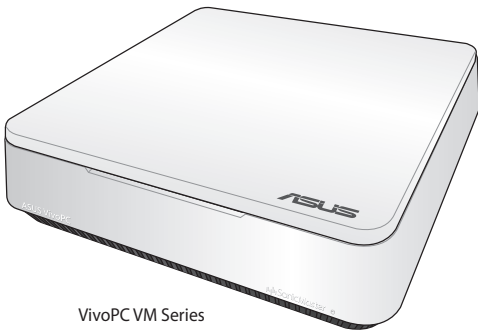

VivoPC VM Series

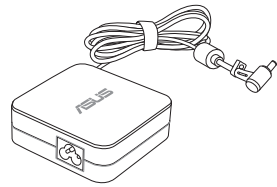

AC power adapter*

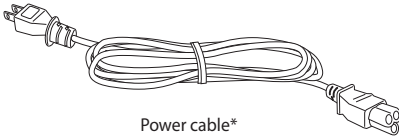

Power cable*



Technical documentations

NOTES:

- *Actual product specifications and package contents may vary with your VivoPC's model type or with country or region.
 - If the device or its components fail or malfunction during normal and proper use within the warranty period, bring the warranty card to the ASUS Service Center for replacement of the defective components.
-

1

Getting to know your VivoPC

Features

Front panel

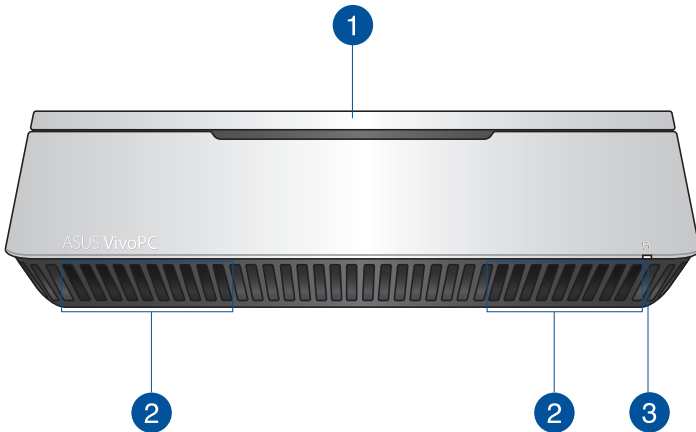

1

Top cover

The removable top cover allows you access to the hard disk drive and the memory modules.

IMPORTANT! Before removing the top cover, turn off your VivoPC and unplug the power cable.

2

Audio speakers

Your VivoPC uses SonicMaster technology to provide hi-fi sound quality, with richer bass sounds, straight from the built-in audio speakers.

3

Drive activity indicator

This indicator lights up when your VivoPC is accessing the internal storage drive.

Left side

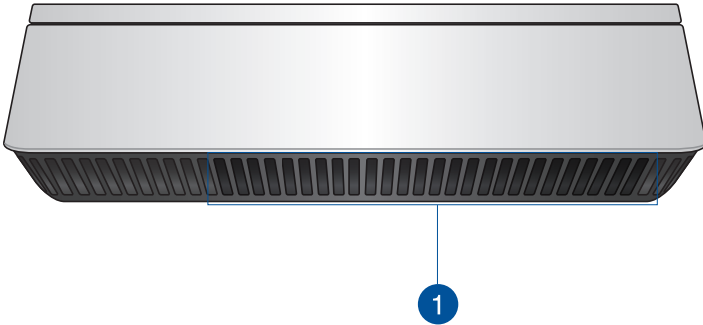

1





Air vents

The air vents on the left side allow cooler air to enter your VivoPC chassis.

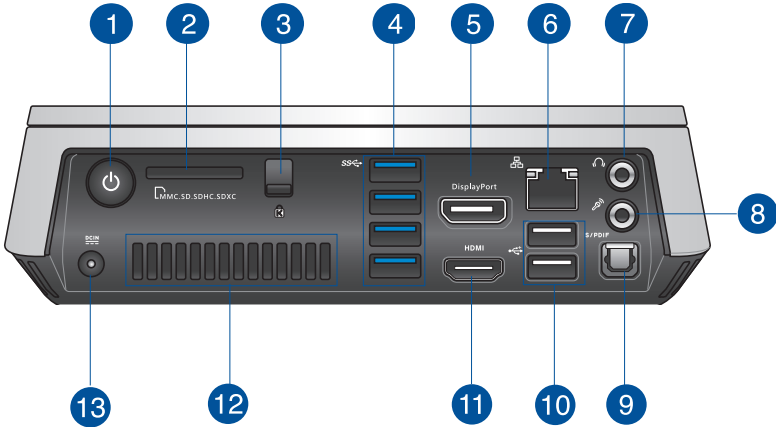
IMPORTANT! For optimum heat dissipation and air ventilation, ensure that the air vents are free from obstructions.

Rear panel



- 1**  **Power button**
The power button allows you to turn the VivoPC on or off. You can also press the power button once to put your VivoPC to sleep mode.
- 2**  **Memory card slot**
The built-in memory card reader enables your PC to read and write data to and from MMC/SD cards.
- 3**  **Top cover lock latch + Kensington security slot**
The top cover lock latch fastens the top cover on your VivoPC.
The Kensington security slot allows you to secure your VivoPC using Kensington® security products.
- 4**  **USB 3.0 ports**
These Universal Serial Bus 3.0 (USB 3.0) ports provide a transfer rate of up to 5 Gbit/s and are backward compatible with USB 2.0.

5

DisplayPort

DisplayPort port

Use this port to connect your ViVo PC to a DisplayPort or VGA, DVI, or HDMI external display.

6



LAN port

The 8-pin RJ-45 LAN port supports a standard Ethernet cable for connection to a local network.

7



Headphone/Audio Out jack

The stereo headphone jack is used to connect the system's audio out signal to amplified speakers or headphones.

8



Microphone jack

The microphone jack is designed to connect the microphone used for video conferencing, voice narrations, or simple audio recordings.

9

S/PDIF

Digital audio out port (S/PDIF optical)

The Sony/Philips Digital Interface (S/PDIF) optical out port allows you to transfer digital audio from your VivoPC into an amplifier or your TV.

10



USB 2.0 ports

The USB (Universal Serial Bus) 2.0 ports are compatible with USB 2.0/1.1 devices such as keyboards, mouse devices, cameras, and hard disk drives. USB allows many devices to run simultaneously on a single computer, with some peripheral acting as additional plug-in sites or hubs.

11

HDMI

HDMI port

The HDMI (High Definition Multimedia Interface) port supports a Full-HD device such as an LCD TV or monitor to allow viewing on a larger external display.

12

Rear air vents

The air vents on the rear allow warm air to exit the VivoPC.

IMPORTANT! For optimum heat dissipation and air ventilation, keep the air vents at least 10cm away from any obstructions.

13

DCIN
≡≡≡

Power input (DC 19V)

The supplied power adapter converts AC power to DC power for use with this jack. Power supplied through this jack supplies power to the PC. To prevent damage to the PC, always use the bundled power adapter.

WARNING! The power adapter may become warm to hot when in use. Do not cover the adapter and keep it away from your body.

Using your VivoPC

2

Getting started

Connect the AC power adapter to your VivoPC

To connect the AC power adapter to your VivoPC:

- A. Connect the AC power cord to the AC/DC adapter.
- B. Plug the AC power cord into a 100V~240V power source.
- C. Connect the DC power connector into your VivoPC's power (DC) input port.

NOTE: The power adapter may vary in appearance, depending on models and your region.

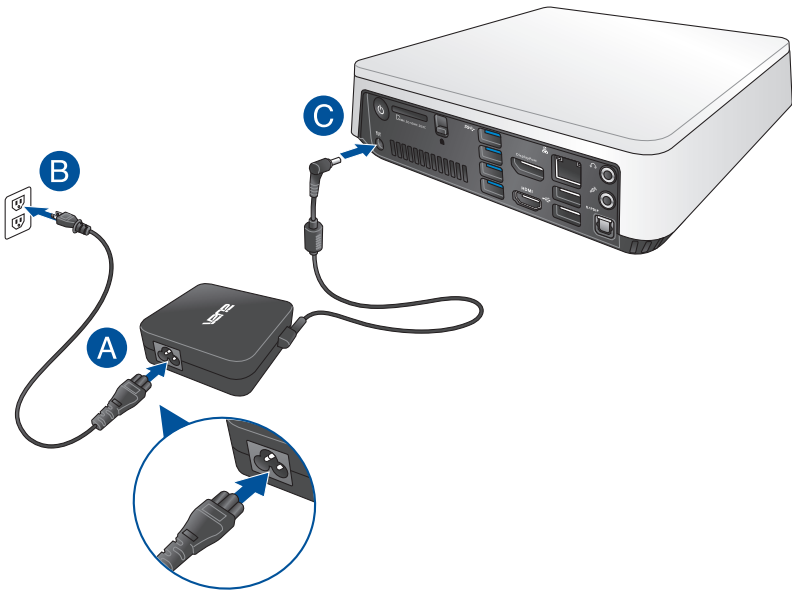

IMPORTANT!

- We strongly recommend that you use only the AC power adapter and cable that came with your VivoPC.
 - We strongly recommend that you use a grounded wall socket while using your VivoPC.
 - The socket outlet must be easily accessible and near your VivoPC.
 - To disconnect your VivoPC from its main power supply, unplug your VivoPC from the power socket.
-

NOTE:

Power adapter information:

- Input voltage: 100-240Vac
 - Input frequency: 50-60Hz
 - Rating output current: 3.42A(65W) or 4.74A(90W) (varies per model)
 - Rating output voltage: 19V
-

Connect a display panel to your VivoPC

You can connect a display panel or projector to your VivoPC that has the following connectors:

- HDMI connector
- DisplayPort connector
- VGA connector (use with a DisplayPort to VGA adapter or HDMI to VGA adapter)
- DVI connector (use with an HDMI to DVI adapter)

NOTE: The HDMI to DVI adapter, DisplayPort to VGA adapter, or HDMI to VGA adapter are each sold separately.

To connect a display panel to your VivoPC:

Connect a display cable either to the HDMI or DisplayPort port.

Connecting display via HDMI port

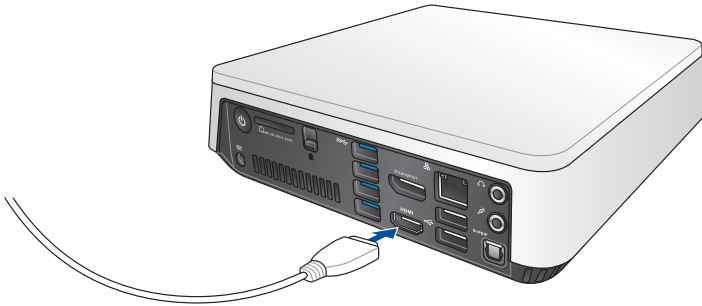

Connecting display via DisplayPort port

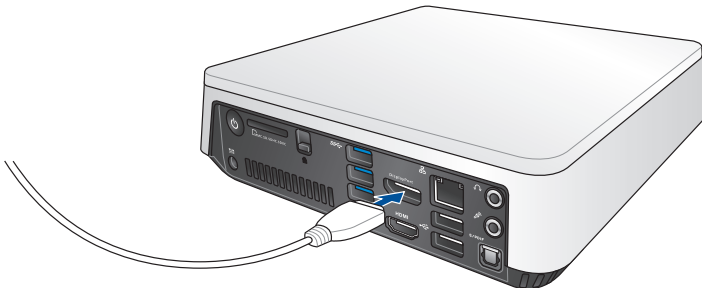

Connect the USB cable from keyboard or mouse

You can connect generally any USB keyboard and mouse to your VivoPC. You can also connect a USB dongle for a wireless keyboard and mouse set.

To connect a keyboard and mouse to your VivoPC:

Connect the USB cable from your keyboard and mouse to any of the USB 2.0 ports of your VivoPC.

Connecting keyboard or mouse via USB 2.0 port

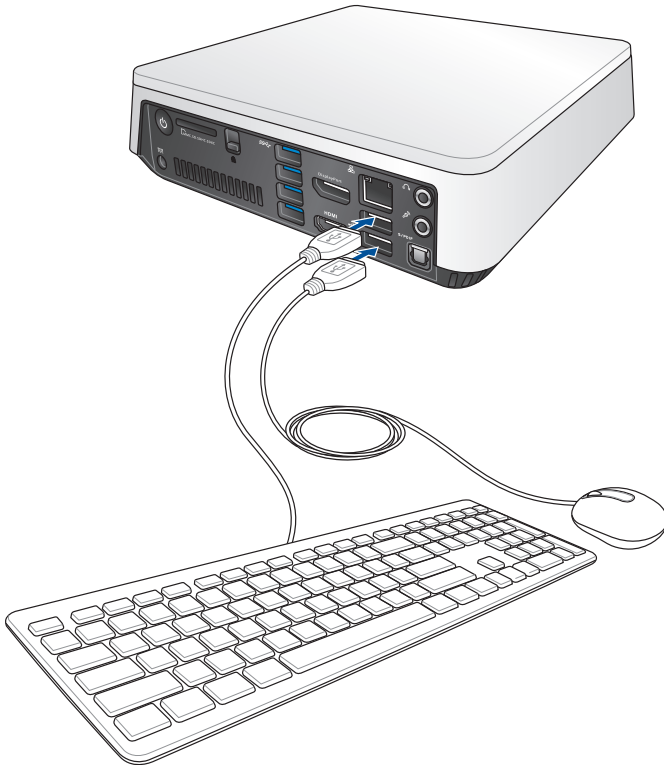

Turn on your Vivo PC

Press the power button to turn on your VivoPC.

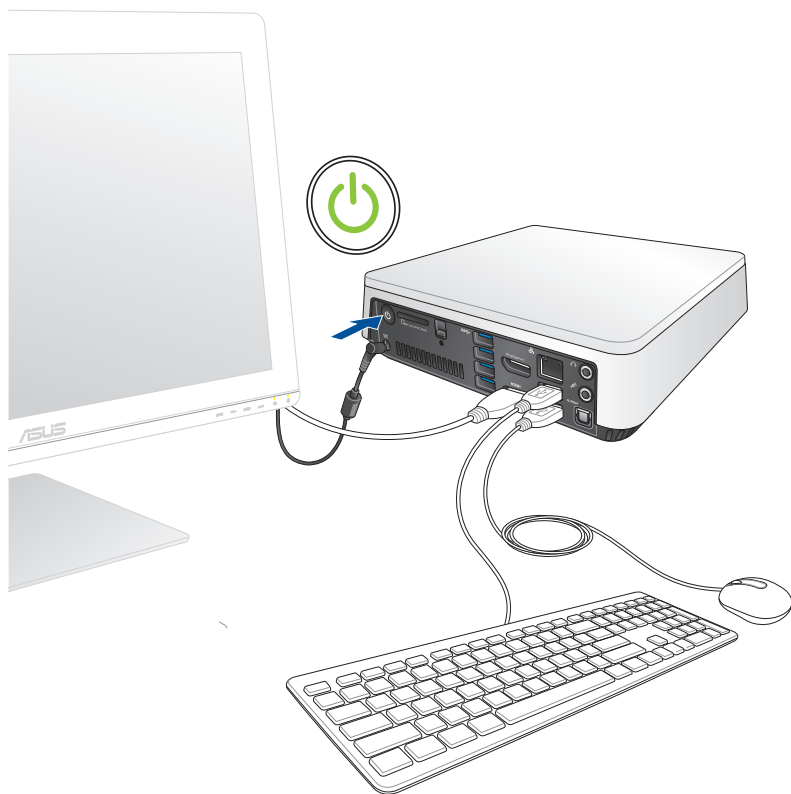

Turning your VivoPC off

If your VivoPC is unresponsive, press and hold the power button for at least four (4) seconds until your VivoPC turns off.

Putting your VivoPC to sleep

To put your VivoPC on Sleep mode, press the Power button once.

Entering the BIOS Setup

BIOS (Basic Input and Output System) stores system hardware settings that are needed for system startup in the VivoPC.

In normal circumstances, the default BIOS settings apply to most conditions to ensure optimal performance. Do not change the default BIOS settings except in the following circumstances:

- An error message appears on the screen during the system bootup and requests you to run the BIOS Setup.
- You have installed a new system component that requires further BIOS settings or update.

WARNING! Inappropriate BIOS settings may result to instability or boot failure. We strongly recommend that you change the BIOS settings only with the help of a trained service personnel.

Quickly enter the BIOS

To quickly enter the BIOS:

- Press the power button for at least four (4) seconds to shut down your VivoPC, then press the power button again to turn your VivoPC back on, then press <F2> or during POST.
- When your PC is off, disconnect the power cord from your VivoPC's power connector. Reconnect the power cable and press the power button to turn on your VivoPC. Press <F2> or during POST.

NOTE: POST (Power-On Self Test) is a series of software controlled diagnostic tests that run when you turn on your PC.

3

Memory upgrade

Upgrading memory modules

Your VivoPC comes with two SO-DIMM memory slots that allow you to install two 2 GB, 4 GB, or 8GB unbuffered with non-ECC DDR3 204-pin SO-DIMMs for a maximum of 16 GB memory.

IMPORTANT! You can only install DDR3 SO-DIMM to the VivoPC's DIMM slots.

NOTE: Refer to <http://www.asus.com> for the list of compatible DIMMs.

To install or upgrade the memory modules:

1. Turn off your VivoPC.
2. Disconnect all cables and peripherals.
3. Place the VivoPC on a stable and flat surface.

4. Press down the latch at the rear panel to release the top cover.

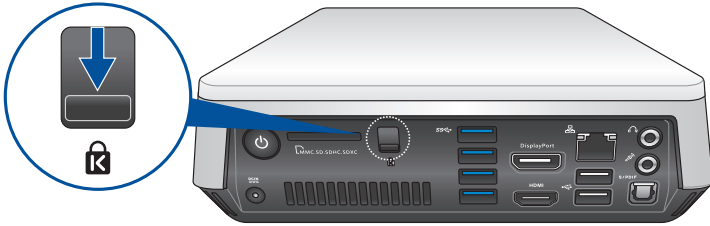

5. Slide the top cover towards the rear of VivoPC until it is detached from the chassis.

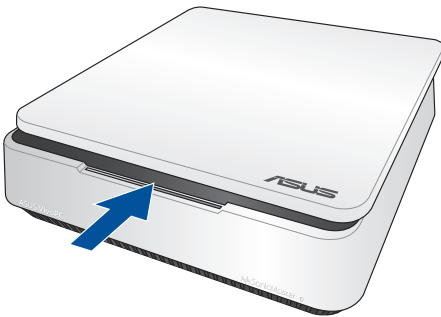

6. Remove the cover and set aside.

- Carefully slide the HDD or the dualbay adapter (with SSD or 2.5-inch HDD inside) from the SATA connector, then remove it from the drive bay.

Removing the HDD from drive bay

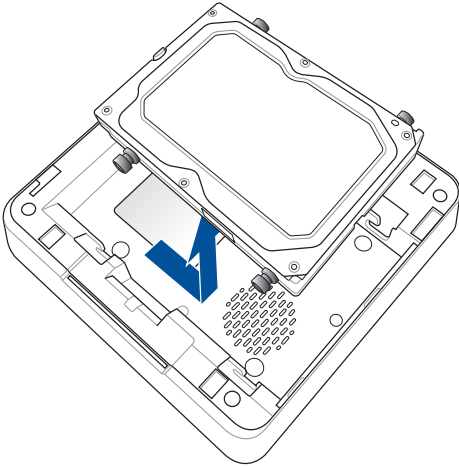

Removing the dualbay adapter (with SSD or 2.5-inch HDD inside) from drive bay

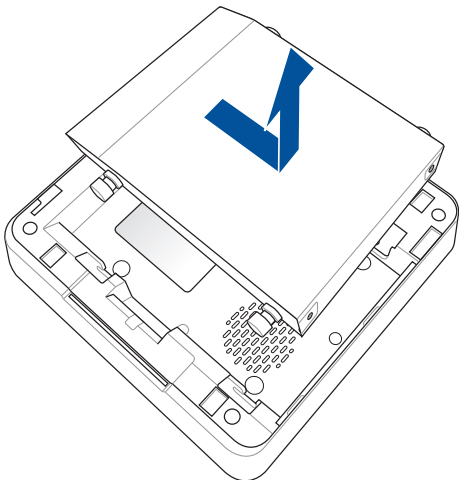

8. Prepare the memory module.
9. Release the screw that secures the SO-DIMM slot cover, then pry the slot cover open.

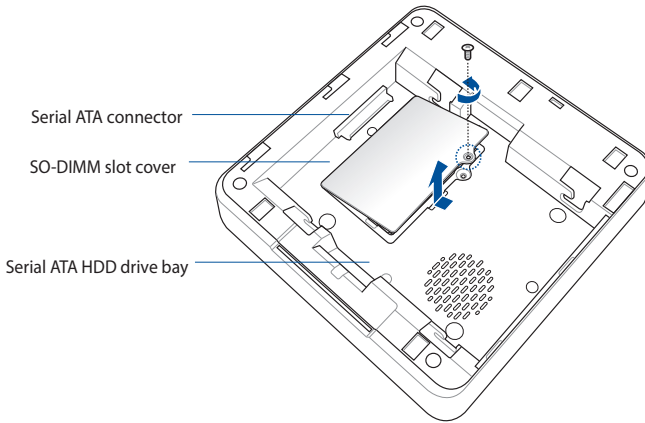

10. Align and insert the memory module into the slot (A) and press it down (B), until it is securely seated in place.

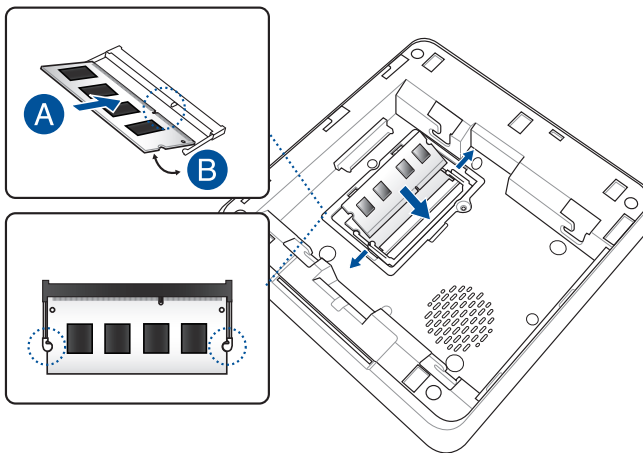

11. Replace the SO-DIMM slot cover and secure it with the screw.

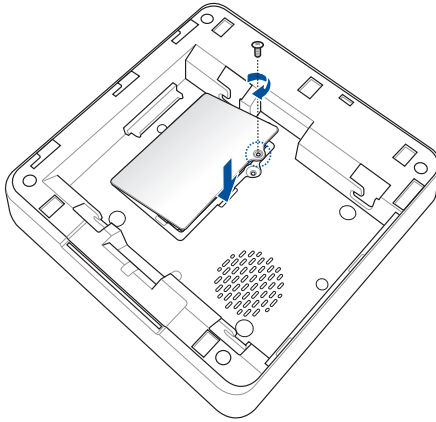

12. For HDD and dualbay adapter, match the rubber heads of the screws with the four screw slots on the drive bay.

- Carefully place the Serial ATA HDD or the dualbay adapter (with SSD or 2.5-inch HDD inside) into the drive bay, then slide the drive towards the SATA connector.

Re-installing the HDD to the drive bay

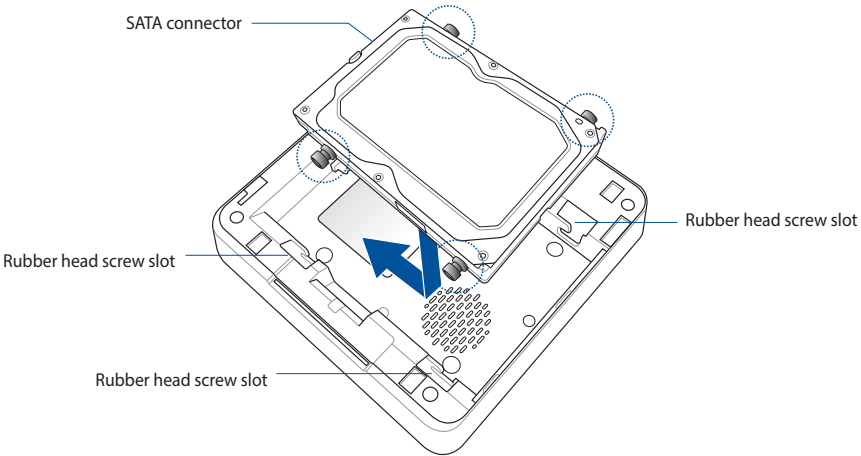

Re-installing the dualbay adapter (with SSD or 2.5-inch HDD inside) to the drive bay

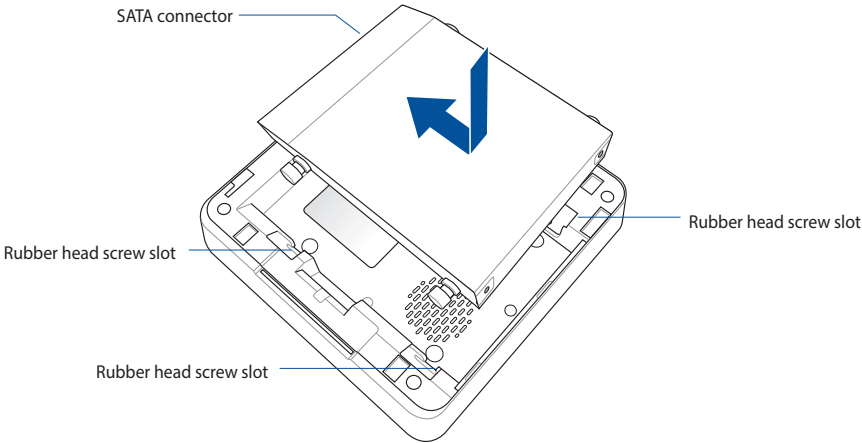

14. Replace the top cover then slide it towards the front of VivoPC to re-attach.



15. Lock the latch to securely fasten the top cover to the chassis.



Appendix

Safety information

Your VivoPC is designed and tested to meet the latest standards of safety for information technology equipment. However, to ensure your safety, it is important that you read the following safety instructions.

Setting up your system

- Read and follow all instructions in the documentation before you operate your system.
- Do not use this product near water or a heated source.
- Set up the system on a stable surface.
- Openings on the chassis are for ventilation. Do not block or cover these openings. Make sure you leave plenty of space around the system for ventilation. Never insert objects of any kind into the ventilation openings.
- Use this product in environments with ambient temperatures between 0°C and 35°C.
- If you use an extension cord, make sure that the total ampere rating of the devices plugged into the extension cord does not exceed its ampere rating.

Care during use

- Do not walk on the power cord or allow anything to rest on it.
- Do not spill water or any other liquids on your system.
- When the system is turned off, a small amount of electrical current still flows. Always unplug the power cord from the power outlets before cleaning the system.
- If you encounter the following technical problems with the product, unplug the power cord and contact a qualified service technician or your retailer.
 - The power cord or plug is damaged.
 - Liquid has been spilled into the system.
 - The system does not function properly even if you follow the operating instructions.
 - The system was dropped or the cabinet is damaged.
 - The system performance changes.

Lithium-Ion Battery Warning

CAUTION: Danger of explosion if battery is incorrectly replaced. Replace only with the same or equivalent type recommended by the manufacturer. Dispose of used batteries according to the manufacturer's instructions.

NO DISASSEMBLY

The warranty does not apply to the products that have been disassembled by users



DO NOT throw the VivoPC in municipal waste. This product has been designed to enable proper reuse of parts and recycling. This symbol of the crossed out wheeled bin indicates that the product (electrical, electronic equipment, and mercury-containing button cell battery) should not be placed in municipal waste. Check local technical support services for product recycling.

Regulatory notices

REACH

Complying with the REACH (Registration, Evaluation, Authorization, and Restriction of Chemicals) regulatory framework, we publish the chemical substances in our products at ASUS REACH website at <http://csr.asus.com/english/REACH.htm>

ASUS Recycling/Takeback Services

ASUS recycling and takeback programs come from our commitment to the highest standards for protecting our environment. We believe in providing solutions for you to be able to responsibly recycle our products, batteries, other components, as well as the packaging materials. Please go to <http://csr.asus.com/english/Takeback.htm> for the detailed recycling information in different regions.

COATING NOTICE

IMPORTANT! To provide electrical insulation and maintain electrical safety, a coating is applied to insulate the device except on the areas where the I/O ports are located.

Federal Communications Commission Statement

This device complies with Part 15 of the FCC Rules. Operation is subject to the following two conditions:

- This device may not cause harmful interference, and
- This device must accept any interference received including interference that may cause undesired operation.

This equipment has been tested and found to comply with the limits for a Class B digital device, pursuant to Part 15 of the FCC Rules. These limits are designed to provide reasonable protection against harmful interference in a residential installation. This equipment generates, uses and can radiate radio frequency energy and, if not installed and used in accordance with manufacturer's instructions, may cause harmful interference to radio communications. However, there is no guarantee that interference will not occur in a particular installation. If this equipment does cause harmful interference to

radio or television reception, which can be determined by turning the equipment off and on, the user is encouraged to try to correct the interference by one or more of the following measures:

- Reorient or relocate the receiving antenna.
- Increase the separation between the equipment and receiver.
- Connect the equipment to an outlet on a circuit different from that to which the receiver is connected.
- Consult the dealer or an experienced radio/TV technician for help.

CAUTION: Any changes or modifications not expressly approved by the grantee of this device could void the user's authority to operate the equipment.

RF exposure warning

This equipment must be installed and operated in accordance with provided instructions and the antenna(s) used for this transmitter must be installed to provide a separation distance of at least 20 cm from all persons and must not be co-located or operating in conjunction with any other antenna or transmitter. End-users and installers must be provide with antenna installation instructions and transmitter operating conditions for satisfying RF exposure compliance.

Declaration of Conformity (R&TTE directive 1999/5/EC)

The following items were completed and are considered relevant and sufficient:

- Essential requirements as in [Article 3]
- Protection requirements for health and safety as in [Article 3.1a]
- Testing for electric safety according to [EN 60950]
- Protection requirements for electromagnetic compatibility in [Article 3.1b]
- Testing for electromagnetic compatibility according to [EN 301 489-1] & [EN 301 489-17]
- Effective use of the radio spectrum as in [Article 3.2]
- Radio test suites according to [EN 300 328-2]

France Restricted Wireless Frequency Bands

Some areas of France have a restricted frequency band. The worst case maximum authorized power indoors are:

- 10mW for the entire 2.4 GHz band (2400 MHz–2483.5 MHz)
- 100mW for frequencies between 2446.5 MHz and 2483.5 MHz

NOTE: Channels 10 through 13 inclusive operate in the band 2446.6 MHz to 2483.5 MHz.

There are few possibilities for outdoor use: On private property or on the private property of public persons, use is subject to a preliminary authorization procedure by the Ministry of Defense, with maximum authorized power of 100mW in the 2446.5–2483.5 MHz band. Use outdoors on public property is not permitted.

In the departments listed below, for the entire 2.4 GHz band:

- Maximum authorized power indoors is 100mW
- Maximum authorized power outdoors is 10mW

Departments in which the use of the 2400–2483.5 MHz band is permitted with an EIRP of less than 100mW indoors and less than 10mW outdoors:

01	Ain	02	Aisne	03	Allier
05	Hautes Alpes	08	Ardennes	09	Ariège
11	Aude	12	Aveyron	16	Charente
24	Dordogne	25	Doubs	26	Drôme
32	Gers	36	Indre	37	Indre et Loire
41	Loir et Cher	45	Loiret	50	Manche
55	Meuse	58	Nièvre	59	Nord
60	Oise	61	Orne	63	Puy du Dôme
64	Pyrénées Atlantique	66	Pyrénées Orientales	67	Bas Rhin
70	Haute Saône	71	Saône et Loire	75	Paris
82	Tarn et Garonne	84	Vaucluse	88	Vosges
89	Yonne	90	Territoire de Belfort	94	Val de Marne

This requirement is likely to change over time, allowing you to use your wireless LAN card in more areas within France. Please check with ART for the latest information (www.art-telecom.fr)

NOTE: Your WLAN Card transmits less than 100mW, but more than 10mW.

Canadian Department of Communications Statement

This digital apparatus does not exceed the Class B limits for radio noise emissions from digital apparatus set out in the Radio Interference Regulations of the Canadian Department of Communications.

This class B digital apparatus complies with Canadian ICES-003.

IC Radiation Exposure Statement for Canada

This equipment complies with IC radiation exposure limits set forth for an uncontrolled environment. To maintain compliance with IC RF exposure compliance requirements, please avoid direct contact to the transmitting antenna during transmitting. End users must follow the specific operating instructions for satisfying RF exposure compliance.

Operation is subject to the following two conditions:

- This device may not cause interference and
- This device must accept any interference, including interference that may cause undesired operation of the device.

CE Mark Warning



CE marking for devices without wireless LAN/Bluetooth

The shipped version of this device complies with the requirements of the EEC directives 2004/108/EC “Electromagnetic compatibility” and 2006/95/EC “Low voltage directive”.



CE marking for devices with wireless LAN/ Bluetooth

This equipment complies with the requirements of Directive 1999/5/EC of the European Parliament and Commission from 9 March, 1999 governing Radio and Telecommunications Equipment and mutual recognition of conformity.

Wireless Operation Channel for Different Domains

N. America	2.412-2.462 GHz	Ch01 through CH11
Japan	2.412-2.484 GHz	Ch01 through Ch14
Europe ETSI	2.412-2.472 GHz	Ch01 through Ch13

ENERGY STAR complied product



ENERGY STAR is a joint program of the U.S. Environmental Protection Agency and the U.S. Department of Energy helping us all save money and protect the environment through energy efficient products and practices.

All ASUS products with the ENERGY STAR logo comply with the ENERGY STAR standard, and the power management feature is enabled by default. The monitor and computer are automatically set to sleep after 10 and 30 minutes of user inactivity. To wake your computer, click the mouse or press any key on the keyboard.

Please visit <http://www.energy.gov/powermanagement> for detail information on power management and its benefits to the environment. In addition, please visit <http://www.energystar.gov> for detail information on the ENERGY STAR joint program.

NOTE: Energy Star is NOT supported on FreeDOS and Linux-based products.

ASUS contact information

ASUSTeK COMPUTER INC.

Address 15 Li-Te Road, Peitou, Taipei, Taiwan 11259
Telephone +886-2-2894-3447
Fax +886-2-2890-7798
E-mail info@asus.com.tw
Web site <http://www.asus.com>

Technical Support

Telephone +86-21-3842-9911
Fax +86-21-5866-8722, ext. 9101#
Online support <http://support.asus.com/techserv/techserv.aspx>

ASUS COMPUTER INTERNATIONAL (America)

Address 800 Corporate Way, Fremont, CA 94539, USA
Telephone +1-510-739-3777
Fax +1-510-608-4555
Web site <http://usa.asus.com>

Technical Support

Support fax +1-812-284-0883
General support +1-812-282-2787
Online support <https://support.asus.com/techserv/techserv.aspx>

ASUS COMPUTER GmbH (Germany and Austria)

Address Harkort Str. 21-23, D-40880 Ratingen, Germany
Fax +49-2102-959931
Web site <http://www.asus.com/de>
Online contact <http://eu-rma.asus.com/sales>

Technical Support

Telephone +49-2102-5789555
Support Fax +49-2102-959911
Online support <http://support.asus.com/techserv/techserv.aspx>

Manufacturer	ASUSTeK Computer Inc.	
	Tel:	+886-2-2894-3447
	Address:	No. 150, LI-TE RD., PEITOU, TAIPEI 112, TAIWAN R.O.C
Authorised representative in Europe	ASUSTeK Computer GmbH	
	Address:	HARKORT STR. 21-23, 40880 RATINGEN, GERMANY

EC Declaration of Conformity



We, the undersigned,

Manufacturer:	ASUSTeK COMPUTER INC.
Address:	4F, No. 150, LI-TE Rd., PEITOU, TAIPEI 112, TAIWAN
Authorized representative in Europe:	ASUS COMPUTER GmbH
Address, City:	HARKORT STR. 21-23, 40880 RATINGEN
Country:	GERMANY

declare the following apparatus:

Product name :	VivoPC
Model name :	VM42,VM62,VM62N

conform with the essential requirements of the following directives:

2004/108/EC-EMC Directive

<input checked="" type="checkbox"/> EN 55022:2010+AC:2011	<input checked="" type="checkbox"/> EN 55024:2010
<input checked="" type="checkbox"/> EN 61000-3-2:2006+A2:2009	<input checked="" type="checkbox"/> EN 61000-3-3:2008
<input checked="" type="checkbox"/> EN 55013:2001+A1:2003+A2:2006	<input type="checkbox"/> EN 55020:2007+A11:2011

1999/5/EC-R&TTE Directive

<input checked="" type="checkbox"/> EN 300 328 V1.7.1(2006-10)	<input checked="" type="checkbox"/> EN 301 489-1 V1.9.2(2011-09)
<input type="checkbox"/> EN 300 440-1 V1.6.1(2010-08)	<input type="checkbox"/> EN 301 489-3 V1.4.1(2002-08)
<input type="checkbox"/> EN 300 440-2 V1.4.1(2010-08)	<input type="checkbox"/> EN 301 489-4 V1.4.1(2009-05)
<input type="checkbox"/> EN 301 511 V9.0.2(2003-03)	<input type="checkbox"/> EN 301 489-7 V1.3.1(2005-11)
<input type="checkbox"/> EN 301 908-1 V5.2.1(2011-05)	<input type="checkbox"/> EN 301 489-9 V1.4.1(2007-11)
<input type="checkbox"/> EN 301 908-2 V5.2.1(2011-07)	<input checked="" type="checkbox"/> EN 301 489-17 V2.2.1(2012-09)
<input checked="" type="checkbox"/> EN 301 893 V1.6.1(2011-11)	<input type="checkbox"/> EN 301 489-24 V1.5.1(2010-09)
<input type="checkbox"/> EN 302 544-2 V1.1.1(2009-01)	<input type="checkbox"/> EN 302 326-2 V1.2.2(2007-06)
<input type="checkbox"/> EN 302 623 V1.1.1(2009-01)	<input type="checkbox"/> EN 302 326-3 V1.3.1(2007-09)
<input type="checkbox"/> EN 50360:2001	<input type="checkbox"/> EN 301 357-2 V1.4.1(2008-11)
<input type="checkbox"/> EN 62479:2010	<input type="checkbox"/> EN 302 291-1 V1.1.1(2005-07)
<input type="checkbox"/> EN 50385:2002	<input type="checkbox"/> EN 302 291-2 V1.1.1(2005-07)
<input type="checkbox"/> EN 62311:2008	

2006/95/EC-LVD Directive

<input checked="" type="checkbox"/> EN 60950-1 / A12:2011	<input type="checkbox"/> EN 60065:2002 / A12:2011
---	---

2009/125/EC-ErP Directive

<input checked="" type="checkbox"/> Regulation (EC) No. 1275/2008	<input checked="" type="checkbox"/> Regulation (EC) No. 278/2009
<input type="checkbox"/> Regulation (EC) No. 642/2009	<input checked="" type="checkbox"/> Regulation (EC) No. 617/2013

2011/65/EU-RoHS Directive

Ver. 140331

CE marking



(EC conformity marking)

Position : CEO

Name : Jerry Shen

Declaration Date: 25/06/2014

Year to begin affixing CE marking: 2014

Signature : _____

DECLARATION OF CONFORMITY

Per FCC Part 2 Section 2. 1077(a)



Responsible Party Name: Asus Computer International

Address: 800 Corporate Way, Fremont, CA 94539.

Phone/Fax No: (510)739-3777/(510)608-4555

hereby declares that the product

Product Name : VivoPC

Model Number : VM42,VM62,VM62N

Conforms to the following specifications:

FCC Part 15, Subpart B, Unintentional Radiators

Supplementary Information:

This device complies with part 15 of the FCC Rules. Operation is subject to the following two conditions: (1) This device may not cause harmful interference, and (2) this device must accept any interference received, including interference that may cause undesired operation.

Representative Person's Name : Steve Chang / President

A handwritten signature in blue ink that reads "Steve Chang". The signature is written in a cursive style and is placed over a light blue rectangular background.

Signature :

Date : Jun. 25, 2014

Ver. 140331