



Dell UltraSharp U2417HA User's Guide

Model: U2417HA
Regulatory model: U2417Ht



-  **NOTE:** A NOTE indicates important information that helps you make better use of your computer.
-  **CAUTION:** A CAUTION indicates potential damage to hardware or loss of data if instructions are not followed.
-  **WARNING:** A WARNING indicates a potential for property damage, personal injury, or death.

Copyright © 2016 Dell Inc. All rights reserved. This product is protected by U.S. and international copyright and intellectual property laws.

Dell™ and the Dell logo are trademarks of Dell Inc. in the United States and/or other jurisdictions. All other marks and names mentioned herein may be trademarks of their respective companies.

Contents

About Your Monitor	5
Package Contents	5
Product Features	6
Identifying Parts and Controls	7
Monitor Specifications	10
Plug-and-Play	21
LCD Monitor Quality and Pixel Policy	21
Setting Up the Monitor	22
Installing the Arm	22
Organizing Your Cables	29
Using the Tilt, Swivel, Pivot, Vertical and Horizontal Extension	30
Adjusting the Rotation Display Settings of Your System	32
Connecting Your Monitor	33
Removing the Monitor Arm	36
Wall Mounting (Optional)	37
Operating the Monitor	38
Turning on the Monitor	38
Using the Front Panel Controls	38
Using the On-Screen Display (OSD) Menu	41

Troubleshooting	53
Self-Test	53
Built-in Diagnostics	55
Common Problems.	56
Product Specific Problems	57
Mobile High-Definition Link (MHL) Specific Problems.	58
Appendix	59
Safety Instructions	59
FCC Notices (U.S. only) and Other Regulatory Information	59
Contacting Dell	59
Setting Up Your Monitor	60
Maintenance Guidelines.	62



About Your Monitor

Package Contents

Your monitor ships with the components shown below. Make sure that you have received all the components and [contact Dell](#) if something is missing.

 **NOTE:** Some items may be optional and may not ship with your monitor. Some features or media may not be available in certain countries.

	Monitor
	Arm riser
	Arm base
	Allen key
	Power cable (varies by country)

	USB 3.0 upstream cable (enables the USB ports on the monitor)
	DP cable (DP to mDP)
	<ul style="list-style-type: none"> • Drivers and documentation media • Quick Setup Guide • Safety and Regulatory Information • Factory Calibration Report

Product Features

The **Dell UltraSharp U2417HA** monitor has an active matrix, thinfilm transistor (TFT), liquid crystal display (LCD), and LED backlight. The monitor features include:

- 60.47 cm (23.8-inch) active area display (Measured diagonally) 1920 x 1080 resolution, plus full-screen support for lower resolutions.
- Wide viewing angles with 99% sRGB color.
- Tilt, swivel, pivot, vertical and horizontal extension adjustment capabilities.
- Removable pedestal and Video Electronics Standards Association (VESA™) 100 mm mounting holes for flexible mounting solutions.
- Ultra-thin bezel minimizes the bezel gap in multi-monitor usage, enabling easier set up with an elegant viewing experience.
- Extensive digital connectivity with DP, mDP, HDMI/MHL, and USB 3.0 helps future-proof your monitor.
- Plug and play capability if supported by your system.
- On-Screen Display (OSD) adjustments for ease of set-up and screen optimization.
- Software and documentation media includes an information file (INF), Image color Matching File (ICM), Dell Display Manager software application and product documentation. Dell Display Manager included (comes in the CD attached with the monitor).
- Security lock slot.
- Asset Management Capability.
- Energy Star Compliant.
- EPEAT Gold Compliant.
- RoHS compliant.
- BFR/PVC Free monitor (excluding cables).
- Arsenic-Free glass and Mercury Free for Panel only.
- Energy Gauge shows the energy level being consumed by the monitor in real time.
- 0.5 W standby power when in the sleep mode.
- TCO Certified Displays.

Identifying Parts and Controls

Front view

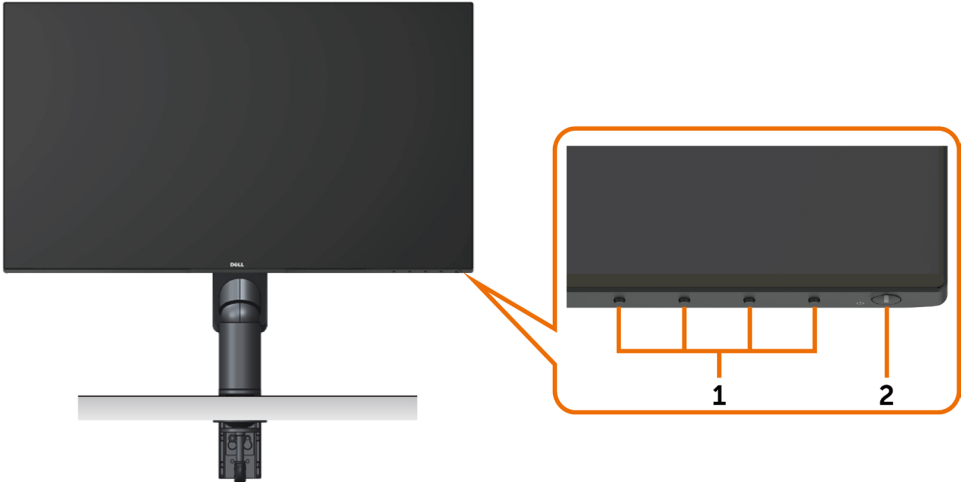

Label	Description
1	Function buttons (For more information, see Operating the Monitor)
2	Power on/off button (with LED indicator)

Back View

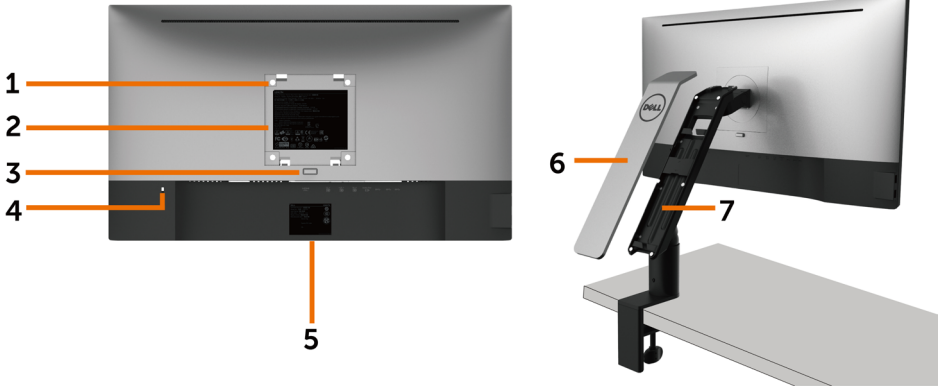

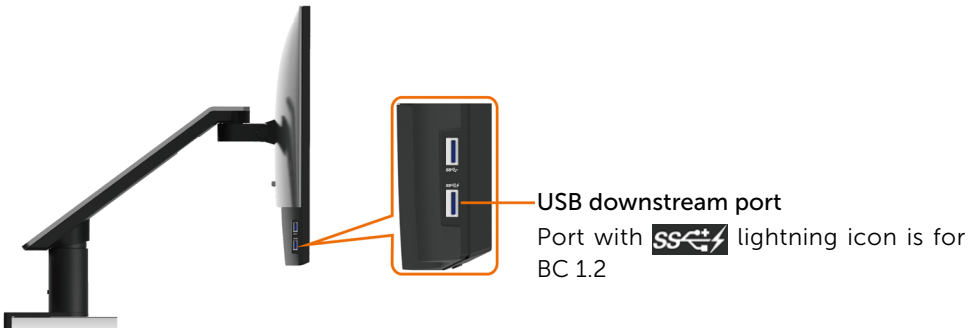

Label	Description	Use
1	VESA mounting holes (100 mm x 100 mm-behind attached VESA cover)	Wall mount monitor using VESA-compatible wall mount kit (100 mm x 100 mm).
2	Regulatory label	Lists the regulatory approvals.
3	Arm release button	Release arm from monitor.
4	Security lock slot	Secures monitor with security cable lock (sold separately).
5	Barcode, serial number, and Service Tag label	Refer to this label if you need to contact Dell for technical support. NOTE: All except APJ having service tag.
6	Arm cover	Remove the cover to access the cable management compartment.
7	Cable management compartment	Use to organize cables by routing them through the compartment. See Organizing Your Cables .

Side View

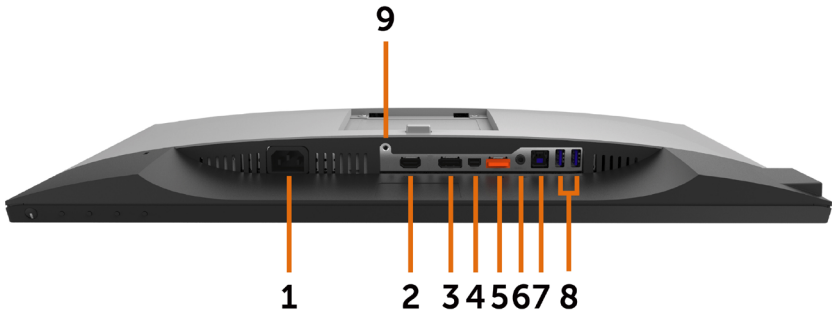

Bottom View



Label	Description	Use
1	AC power connector	To connect the monitor power cable.
2	HDMI/MHL connector	Connect your computer with HDMI cable or MHL devices with MHL cable (optional).
3	DP connector (in)	Connect your computer with DP cable.
4	mDP connector (in)	Connect your computer with mDP to DP cable.
5	DP connector (out) 	DP output for MST (multi-stream transport) capable monitor. DP 1.1 monitor can only be connected as the last monitor in the MST chain. To enable MST, refer to instruction on section “Connecting the Monitor for DP MST Function” . NOTE: Remove the rubber plug when use DP out connector.
6	Audio line-out port	Connect speakers to playback audio coming through HDMI or DP audio channels. Only supports 2-channel audio. NOTE: The audio line-out port does not support headphones. ⚠️ WARNING: Excessive sound pressure from earphones or headphones can cause hearing damage or loss.
7	USB upstream port	Connect the USB cable that comes with your monitor to the computer. Once this cable is connected, you can use the USB downstream connectors on the monitor.
8	USB downstream ports (2)	Connect your USB device. You can only use this connector after you have connected the USB cable to the computer and USB upstream connector on the monitor.
9	Arm lock	Lock the arm to the monitor using a M3 x 6 mm screw (screw not included).

Monitor Specifications

Flat Panel Specifications

Screen type	Active matrix - TFT LCD
Panel type	In-plane switching (IPS)
Viewable image	
Diagonal	60.47 cm (23.80 inches)
Active Area	
Horizontal	527.04 mm (20.75 inches)
Vertical	296.46 mm (11.67 inches)
Area	156246.28 mm ² (242.18 inches ²)
Pixel pitch	0.2745 mm x 0.2745 mm
Viewing angle	
Horizontal	178° (typical)
Vertical	178° (typical)
Luminance output	250 cd/m ² (typical)
Contrast ratio	1000 to 1 (typical)
Faceplate coating	Anti-glare treatment of the front polarizer (3H)
Backlight	LED
Response Time	8 ms (typical), 6 ms (fast mode)
Color depth	16.7 million colors
Color gamut	99% sRGB

Resolution Specifications

Horizontal scan range	30 kHz to 83 kHz (DP/HDMI) 27 kHz to 70 kHz (MHL)
Vertical scan range	50 Hz to 75 Hz (DP/HDMI) 24 Hz to 60 Hz (MHL)
Maximum preset resolution	1920 x 1080 at 60 Hz
Video display capabilities (DP & HDMI & MHL playback)	480i, 480p, 576i, 576p, 720p, 1080i, 1080p

Preset Display Modes

Display Mode	Horizontal Frequency (kHz)	Vertical Frequency (Hz)	Pixel Clock (MHz)	Sync Polarity (Horizontal/Vertical)
720 x 400	31.5	70.0	28.3	-/+
VESA, 640 x 480	31.5	60.0	25.2	-/-
VESA, 640 x 480	37.5	75.0	31.5	-/-
VESA, 800 x 600	37.9	60.3	40.0	+/+
VESA, 800 x 600	46.9	75.0	49.5	+/+
VESA, 1024 x 768	48.4	60.0	65.0	-/-
VESA, 1024 x 768	60.0	75.0	78.8	+/+
VESA, 1152 x 864	67.5	75.0	108.0	+/+
VESA, 1280 x 1024	64.0	60.0	108.0	+/+
VESA, 1280 x 1024	80.0	75.0	135.0	+/+
VESA, 1600 x 1200	75.0	60.0	162.0	+/+
VESA, 1920 x 1080	67.5	60.0	148.5	+/+

MHL Source Display Modes

Display Mode	Frequency (Hz)
640 x 480p	60
720 x 480p	60
720 x 576p	50
720 (1440) x 480i	60
720 (1440) x 576i	50
1280 x 720p	60
1280 x 720p	50
1920 x 1080i	60
1920 x 1080i	50
1920 x 1080p	30
1920 x 1080p	60

MST Multi-Stream Transport (MST) Modes

MST Source Monitor	Maximum number of external monitor that can be supported
	1920 x 1080/60 Hz
1920 x 1080/60 Hz	2

NOTE: Maximum external monitor resolution supported is 1920x1080 60Hz only.

Electrical Specifications

Video input signals	<ul style="list-style-type: none"> • Digital video signal for each differential line Per differential line at 100 ohm impedance • DP/HDMI/MHL signal input support
Input voltage/ frequency/current	100-240 VAC / 50 or 60 Hz \pm 3 Hz / 1.6 A (maximum)
Inrush current	120 V: 40 A (Max.) 240 V: 80 A (Max.)

Physical Characteristics

Connector type	<ul style="list-style-type: none"> • DP connector (include DP in and DP out) • mDP connector • HDMI/MHL connector • Audio line-out • USB 3.0 upstream port connector • USB 3.0 downstream port connector x 4 (Port with  lightning icon is for BC 1.2)
Signal cable type	DP to mDP 1.8 M cable USB 3.0 1.8 M cable
Dimensions (with arm)	
Height (extended)	497.7 mm (19.59 inches)
Height (compressed)	317 mm (12.48 inches)
Depth (extended)	408.3 mm (16.07 inches)
Depth (compressed)	184.2 mm (7.25 inches)
Width	537.6 mm (21.17 inches)
Dimensions (without arm)	
Height	314.3 mm (12.37 inches)
Width	537.6 mm (21.17 inches)
Depth	46.1 mm (1.81 inches)

Arm dimensions	
Height	441.6 mm (17.39 inches)
Width	121.6 mm (4.79 inches)
Depth	384.3 mm (15.13 inches)
Weight	
Weight with packaging	8.2 kg (18.08 lb)
Weight with arm assembly and cables	5.9 kg (13.01 lb)
Weight without arm assembly (For wall mount or VESA mount considerations - no cables)	3.2 kg (7.05 lb)
Weight of arm assembly	2.3 kg (5.07 lb)

Environmental Characteristics

Temperature	
Operating	0°C to 40°C (32°F to 104°F)
Non-operating	-20°C to 60°C (-4°F to 140°F)
Humidity	
Operating	10% to 80% (non-condensing)
Non-operating	5% to 90% (non-condensing)
Altitude	
Operating	5,000 m (16,404 ft) (maximum)
Non-operating	12,192 m (40,000 ft) (maximum)
Thermal dissipation	232 BTU/hour (maximum) 64.8 BTU/hour (typical)

Power Management Modes

If you have VESA’s DPM-compliant video card or software installed in your PC, the monitor can automatically reduce its power consumption when not in use. This is referred to as power save mode*. If the computer detects input from the keyboard, mouse, or other input devices, the monitor automatically resumes functioning. The following table shows the power consumption and signaling of this automatic power saving feature.

VESA Modes	Horizontal Sync	Vertical Sync	Video	Power Indicator	Power Consumption
Normal operation	Active	Active	Active	White	68 W (maximum)** 19 W (typical)
Active-off mode	Inactive	Inactive	Off	White (blinking slowly)	Less than 0.5 W
Switch off	-	-	-	Off	Less than 0.3 W

Energy Star	Power Consumption
On Mode	16.93 W***

The OSD operates only in the normal operation mode. If you press any button in the active-off mode, one of the following message is displayed:

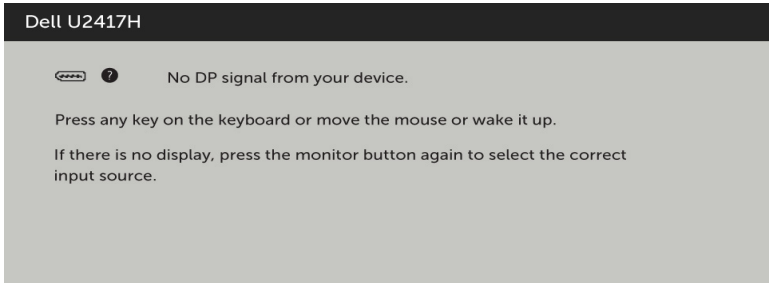

*Zero power consumption in OFF mode can only be achieved by disconnecting the AC mains cable from the monitor.

**Maximum power consumption with maximum luminance.

*** Energy consumption (On Mode) is tested at 230 Volts / 50 Hz.

This document is informational only and reflects laboratory performance. Your product may perform differently, depending on the software, components and peripherals you ordered and shall have no obligation to update such information. Accordingly, the customer should not rely upon this information in making decisions about electrical tolerances or otherwise. No warranty as to accuracy or completeness is expressed or implied.

Activate the computer and the monitor to gain access to the OSD.

NOTE: This monitor is **ENERGY STAR** -compliant.



Pin Assignments

DP connector (in)

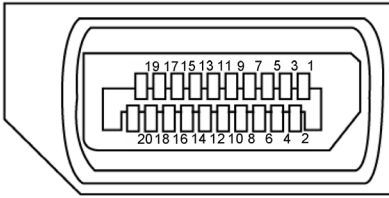

Pin number	20-pin side of the connected signal cable
1	ML3(n)
2	GND
3	ML3(p)
4	ML2(n)
5	GND
6	ML2(p)
7	ML1(u)
8	GND
9	ML1(p)
10	ML0(n)
11	GND
12	ML0(p)
13	CONFIG1
14	CONFIG2
15	AUX CH (p)
16	GND
17	AUX CH (n)
18	Hot Plug Detect
19	Return
20	DP_PWR

DP connector (out)

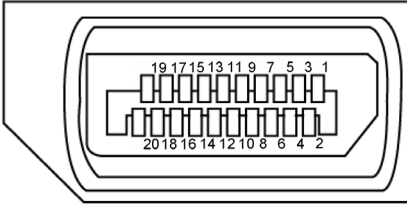

Pin number	20-pin side of the connected signal cable
1	ML0(p)
2	GND
3	ML0(n)
4	ML1(p)
5	GND
6	ML1(n)
7	ML2(p)
8	GND
9	ML2(n)
10	ML3(p)
11	GND
12	ML3(n)
13	CONFIG1
14	CONFIG2
15	AUX CH(p)
16	GND
17	AUX CH(n)
18	Hot Plug Detect
19	Return
20	DP_PWR

mDP connector

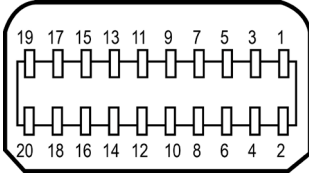

Pin number	20-pin side of the connected signal cable
1	GND
2	Hot Plug Detect
3	ML3 (n)
4	CONFIG1
5	ML3 (p)
6	CONFIG2
7	GND
8	GND
9	ML2 (n)
10	ML0 (p)
11	ML2 (p)
12	ML0 (p)
13	GND
14	GND
15	ML1 (n)
16	AUX (p)
17	ML1 (p)
18	AUX (n)
19	GND
20	DP_PWR

HDMI connector

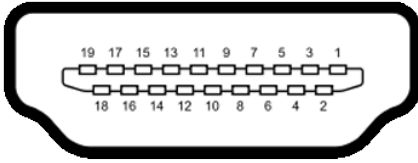

Pin number	19-pin side of the connected signal cable
1	TMDS DATA 2+
2	TMDS DATA 2 SHIELD
3	TMDS DATA 2-
4	TMDS DATA 1+
5	TMDS DATA 1 SHIELD
6	TMDS DATA 1-
7	TMDS DATA 0+
8	TMDS DATA 0 SHIELD
9	TMDS DATA 0-
10	TMDS CLOCK+
11	TMDS CLOCK SHIELD
12	TMDS CLOCK-
13	CEC
14	Reserved (N.C. on device)
15	DDC CLOCK (SCL)
16	DDC DATA (SDA)
17	DDC/CEC Ground
18	+5 V POWER
19	HOT PLUG DETECT

MHL connector

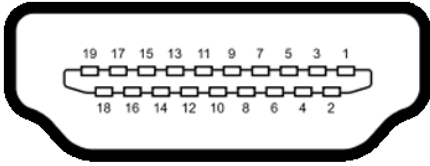

Pin number	19-pin side of the connected signal cable
1	N/C
2	CD_SENSE
3	N/C
4	N/C
5	TMDS_GND
6	N/C
7	MHL+
8	MHL_Shield
9	MHL-
10	N/C
11	TMDS_GND
12	N/C
13	N/C
14	N/C
15	CD_PULLUP
16	N/C
17	VBUS_CBUS_GND
18	VBUS
19	CBUS
2Shell	Shield

Universal Serial Bus (USB)

This section gives you information about the USB ports available on your monitor.

NOTE: Up to 2 A on USB downstream port (port  with lightning icon) with BC 1.2 compliance devices; up to 0.9 A on the other 3 USB downstream ports.

Your computer has the following USB ports:

- 1 upstream - bottom
- 4 downstream - 2 at left side, 2 at bottom

Power Charging Port - the one on the left side (Port with  lightning icon); supports fast current charging capability if the device is BC 1.2 compatible.

NOTE: The monitor's USB ports work only when the monitor is on or in the power save mode. If you turn off the monitor and then turn it on, the attached peripherals may take a few seconds to resume normal functionality.

Transfer speed	Data rate	Power consumption
SuperSpeed	5 Gbps	4.5 W (Max., each port)
Hi-Speed	480 Mbps	2.5 W (Max., each port)
Full speed	12 Mbps	2.5 W (Max., each port)

USB upstream port

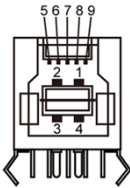

Pin number	Signal name
1	VBUS
2	D-
3	D+
4	GND
5	StdB_SSTX-
6	StdB_SSTX+
7	GND_DRAIN
8	StdB_SSRX-
9	StdB_SSRX+
Shell	Shield

USB downstream port

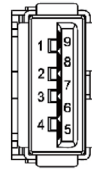

Pin number	Signal name
1	VBUS
2	D-
3	D+
4	GND
5	StdA_SSRX-
6	StdA_SSRX+
7	GND_DRAIN
8	StdA_SSTX-
9	StdA_SSTX+
Shell	Shield

Plug-and-Play



You can install the monitor in any Plug-and-Play-compatible system. The monitor automatically provides the computer system with its extended display identification data (EDID) using display data channel (DDC) protocols so the computer can configure itself and optimize the monitor settings. Most monitor installations are automatic; you can select different settings if desired. For more information about changing the monitor settings, see [Operating the Monitor](#).

LCD Monitor Quality and Pixel Policy

During the LCD monitor manufacturing process, it is not uncommon for one or more pixels to become fixed in an unchanging state which are hard to see and do not affect the display quality or usability. For more information on LCD Monitor Pixel Policy, see Dell support site at: <http://www.dell.com/support/monitors>.

Setting Up the Monitor

Installing the Arm

-  **NOTE:** The arm riser and arm base are detached when the monitor is shipped from the factory.
-  **NOTE:** The arm installing instruction is applicable to the arm shipped with the monitor. For other mounting solutions (optional), please refer to their respective set up instructions.

Installing the Arm Base

There are a few types of table configurations which the arm base could be installed:

- A. Table with open edge
- B. Table with partition with gap between
- C. Table with grommet hole
- D. Others

A. Table with open edge



- Install the 2 screws either on top row or the bottom row of arm base bracket depending on the table thickness.
- Insert the clamp bracket key holes to the screws and slide down to secure in place.

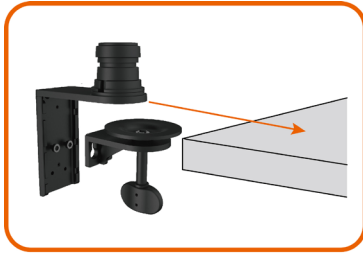

- Slide the arm base assembly completely into the table.

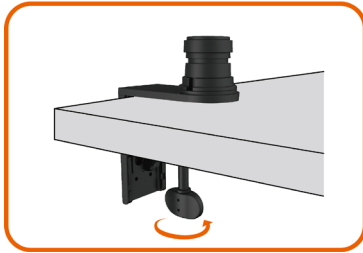

- Tighten the thumbscrew until the clamp disc is fully in contact with the underside of table.

B. Table with partition with gap between

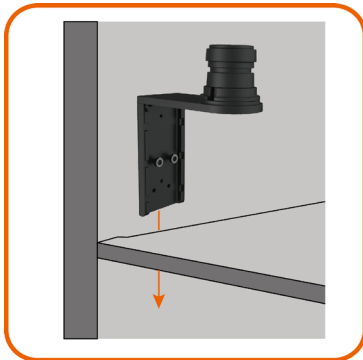

- Insert the arm base bracket through the gap between table and partition.



- Install the 2 screws either on top row or the bottom row of arm base bracket depending on the table thickness.



- Insert the clamp bracket key holes to the screws and slide down to secure in place.

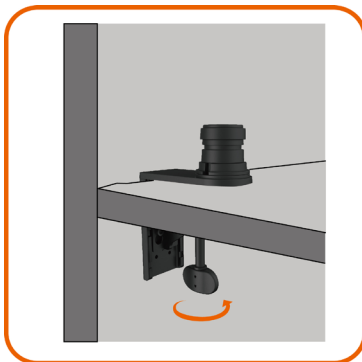

- Tighten the thumbscrew until the clamp disc is fully in contact with the underside of table.

C. Table with grommet hole

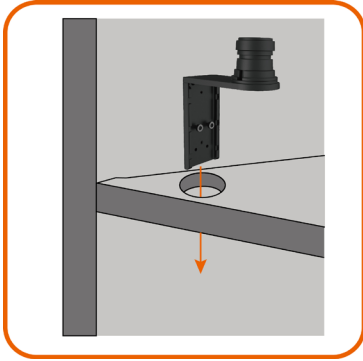

- Insert the arm base bracket through the grommet hole.



- Install the 2 screws either on top row or the bottom row of arm base bracket depending on the table thickness.



- Insert the clamp bracket key holes to the screws and slide down to secure in place.

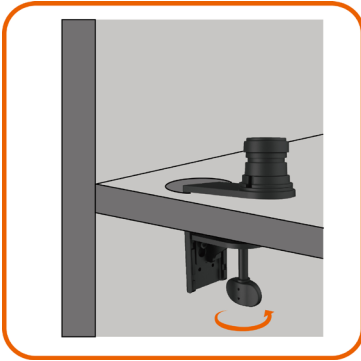

- Tighten the thumbscrew until the clamp disc is fully in contact with the underside of table.

D. Others

Some office partition systems have a swing-open panel for cable management. In certain cases, the swing-open panel might cause obstruction to the arm base installation as illustrated below.

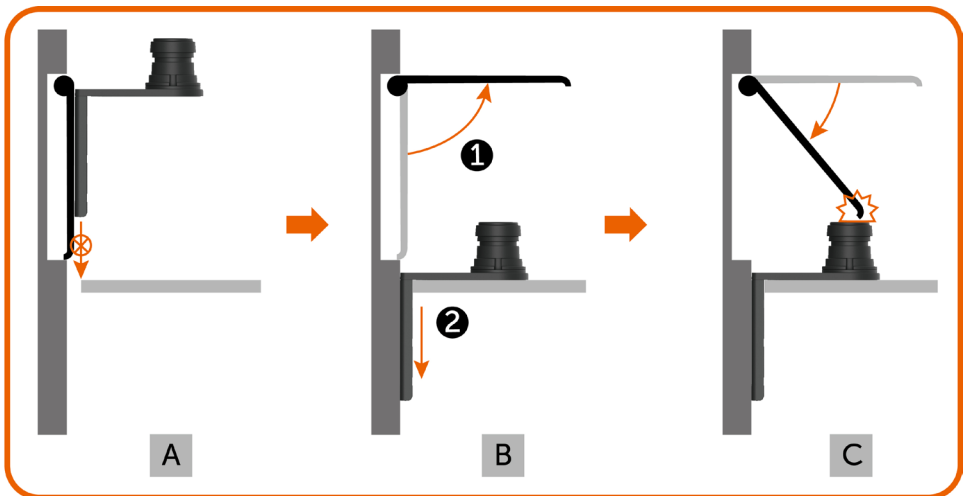

- Without opening the panel, the gap is too small to insert the arm base bracket.
- The panel need to be opened first before inserting the arm base bracket into the gap.
- However, the height of the arm base pole obstructs the panel from closing back.

The recommended arm base installation steps to overcome this issue:

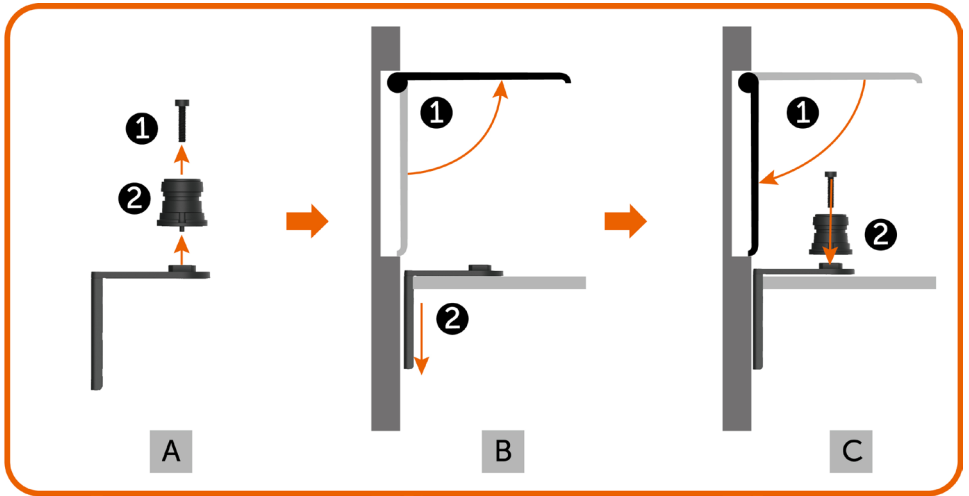

- A. Remove the pole from the arm base by removing the center screw.
- B. Open the panel and insert the arm base bracket through the gap.
- C. Close the panel and install back the pole to the arm base bracket.

Installing the Arm Riser



- Insert the arm riser fully into the pole of the arm base which has been installed to the table.
- Fully tighten the set screw using the Allen key to prevent the arm riser accidentally detaching from the arm base.



- Place the grooves on the back of monitor into the two tabs on the top part of the arm.
- Tilt the monitor down till the monitor snaps into its place.

Organizing Your Cables



1. Remove the arm cover which is attached with magnets to the arm riser.
2. Slide the cable bracket upwards to unlock.
3. Flip the cable bracket up until it holds still in position.



- Thread the cables from bottom up through the cable clips and bracket.
- The cables should exit from the arm bottom opening and connected to the respective connectors on the monitor.



1. Flip down the cable bracket fully.
2. Slide the cable bracket downward until it is locked in place.

 **NOTE:** Ensure the cables do not overlap on top of each other.



- Attach the arm cover.

Using the Tilt, Swivel, Pivot, Vertical and Horizontal Extension

NOTE: This is applicable to the arm shipped with this monitor. For other mounting solutions please refer to their respective set up instructions.

Tilt and Vertical Extension

With arm attached to the monitor, you can tilt and lift the monitor to the most comfortable viewing position.

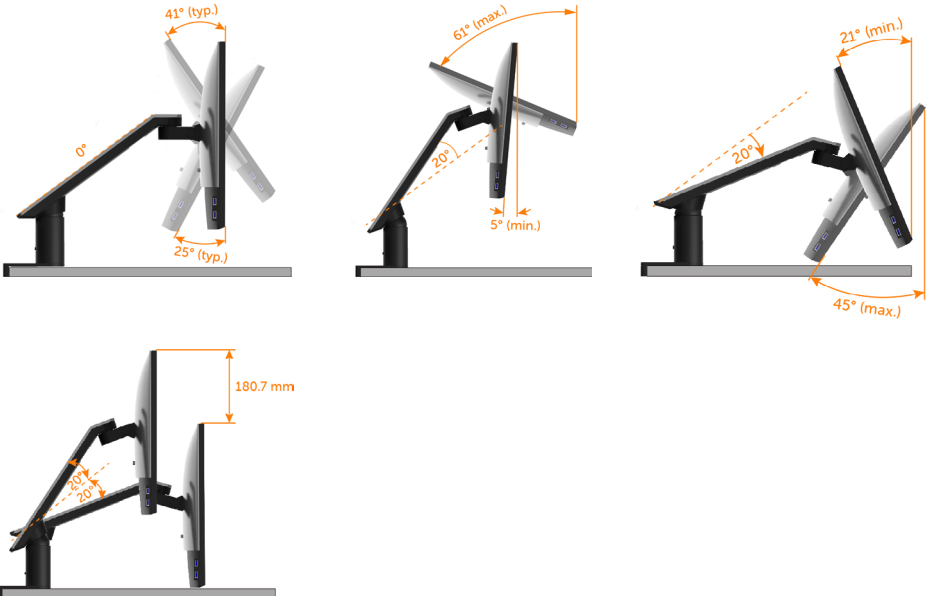

Swivel and Horizontal Extension

With arm attached to the monitor, you can swivel the monitor and pan the arm to an optimum monitor viewing distance or just simply to compact the monitor to have a clear desk.

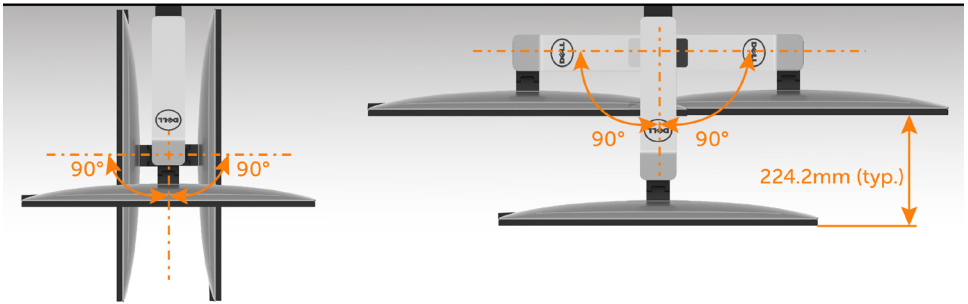

Pivoting

Before you pivot the monitor, your monitor should be fully lifted vertically and fully tilted up to avoid hitting the bottom edge of the monitor.

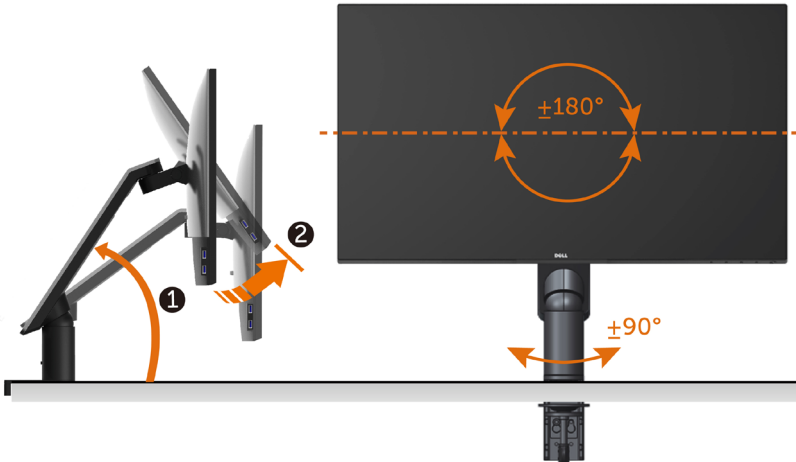

- NOTE:** To use the Display Rotation function (Landscape versus Portrait view) with your Dell computer, you require an updated graphics driver that is not included with this monitor. To download the graphics driver, go to www.dell.com/support and see the Download section for Video Drivers for latest driver updates.
- NOTE:** When in the Portrait View Mode, you may experience performance degradation in graphic-intensive applications (3D Gaming and etc.).

Adjusting the Rotation Display Settings of Your System

After you have rotated your monitor, you need to complete the procedure below to adjust the Rotation Display Settings of your System.

 **NOTE:** If you are using the monitor with a non-Dell computer, you need to go to the graphics driver website or your computer manufacturer website for information on rotating the 'contents' on your display.

To adjust the Rotation Display Settings:

- 1 Right-click on the desktop and click Properties.
- 2 Select the Settings tab and click Advanced.
- 3 If you have an ATI graphics card, select the Rotation tab and set the preferred rotation.
- 4 If you have an nVidia graphics card, click the nVidia tab, in the left-hand column select NVRotate, and then select the preferred rotation.
- 5 If you have an Intel® graphics card, select the Intel graphics tab, click Graphic Properties, select the Rotation tab, and then set the preferred rotation.

 **NOTE:** If you do not see the rotation option or it is not working correctly, go to www.dell.com/support and download the latest driver for your graphics card.

Connecting Your Monitor

⚠ WARNING: Before you begin any of the procedures in this section, follow the [Safety Instructions](#).

To connect your monitor to the computer:

- 1 Turn off your computer.
- 2 Connect the HDMI/DP-mDP/USB cable from your monitor to the computer. (Vertically extend and tilt the monitor completely to rotate it for cable connection. See [Pivoting](#).)
- 3 Switch on your monitor.
- 4 Select the correct input source at Monitor OSD Menu and turn on your computer.

📎 NOTE: U2417HA default setting is DP 1.2. DP 1.1 Graphic card may not display normally. Please refer to "[product specific problems – No image when using DP connection to the PC](#)" to change default setting.

Connecting the HDMI cable(Optional)

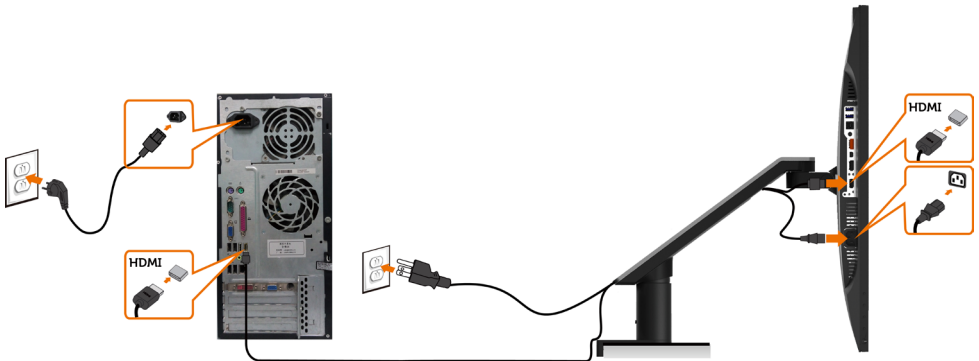

Connecting the DP (or mDP) cable

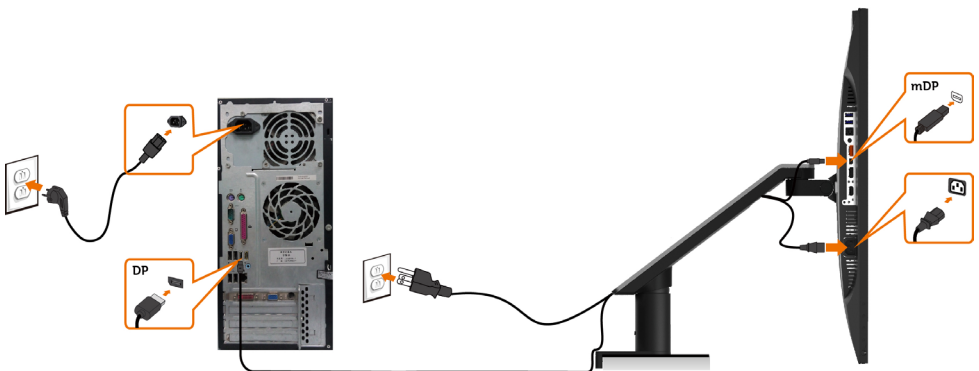

📎 NOTE: Default is DP port. Select input source on monitor to switch to mDP.

Connecting the monitor for DP Multi-Stream Transport (MST) function

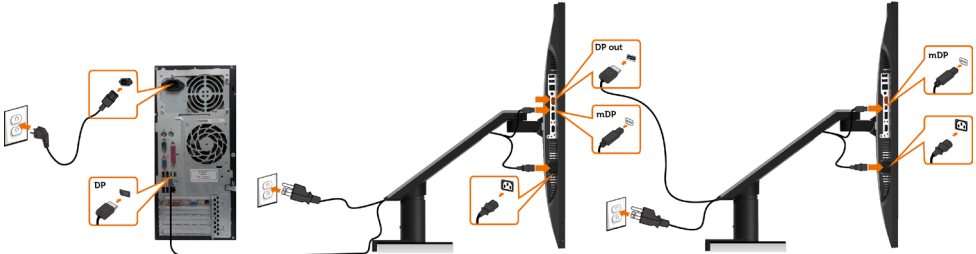



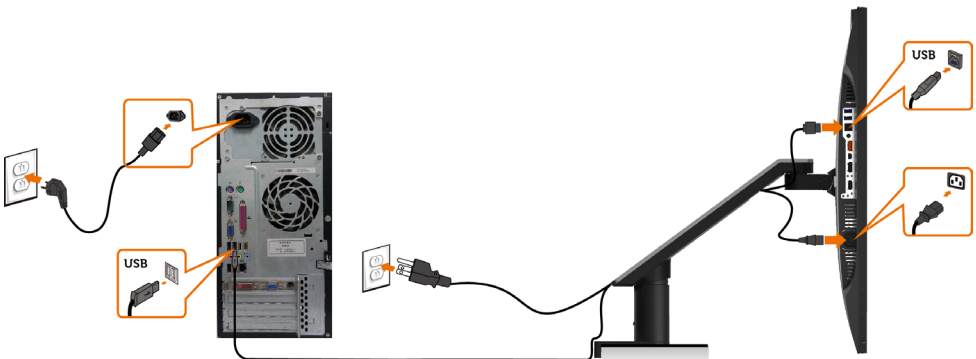

- NOTE:** Supports the DP MST feature. To make use of this feature, your PC Graphics Card must be certified to DP1.2 with MST option.
- NOTE:** Remove the rubber plug when using the DP out connector.

Connecting the USB cable



Using the Mobile-High Definition Link (MHL)

-  **NOTE:** This monitor is MHL ready.
-  **NOTE:** To use the MHL function, use only MHL-certified cable and source devices that support MHL output.
-  **NOTE:** Some MHL source devices may take more than a few seconds or longer to output an image, depending on MHL source devices.
-  **NOTE:** When the connected MHL source device enters standby mode, the monitor displays a black screen or the message below, depending on MHL source device's output.

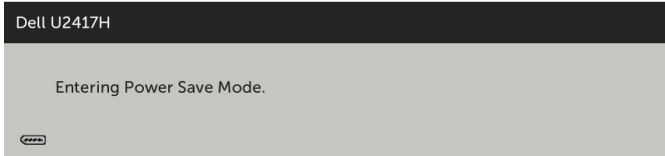

To enable MHL connection, please perform the below steps:

- 1 Plug the power cable on your monitor into a AC outlet.
- 2 Connect the (micro) USB port on your MHL source device to HDMI/MHL port on the monitor with a MHL certified cable (see [Bottom View](#) for details).
- 3 Turn on the monitor and the MHL source device.

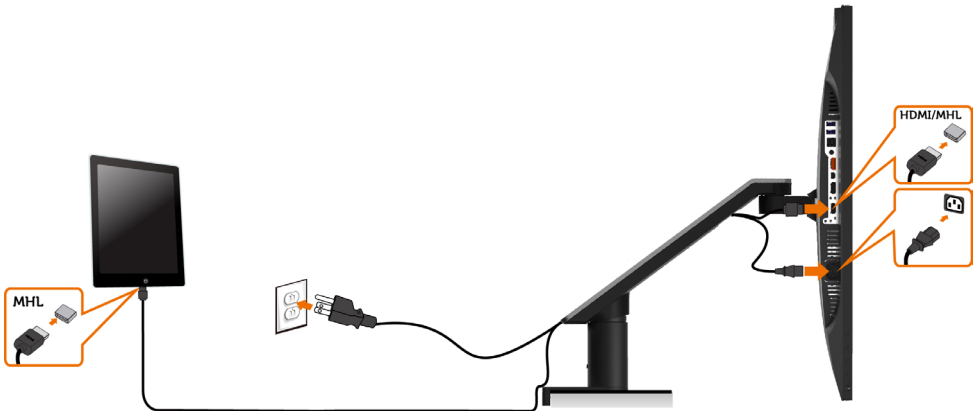

- 4 Select input source on monitor to HDMI/MHL by using OSD menu (see [Using the On-Screen Display \(OSD\) Menu](#) for details).
- 5 If the monitor does not display an image, see [Mobile High-Definition Link \(MHL\) Specific Problems](#).

Removing the Monitor Arm



CAUTION: Place monitor on a flat, clean, and soft surface to avoid scratching the display panel.



NOTE: The arm installing instruction is applicable to the arm shipped with the monitor. For other mounting solutions (optional), please refer to their respective set up instructions.

To remove the arm:



1. Press and hold the arm-release button.
2. Lift the monitor up and away from the arm.



- Turn the screw anticlockwise with an Allen key.
- Remove the arm riser from the arm base by pulling it in the direction of the arrow as shown in the figure.



- Turn the fixed screw at the bottom of the arm base to separate it.

Wall Mounting (Optional)



 **NOTE:** Use M4 x 10 mm screws to connect the monitor to the wall-mounting kit.

Refer to the instructions that come with the VESA-compatible wall mounting kit.

- 1 Place the monitor on a soft cloth or cushion on a stable, flat table.
- 2 Remove the arm.
- 3 Use a Phillips crosshead screwdriver to remove the four screws securing the plastic cover.
- 4 Attach the mounting bracket from the wall mounting kit to the monitor.
- 5 Mount the monitor on the wall by following the instructions that comes with the wall mounting kit.

 **NOTE:** For use only with UL or CSA or GS-listed wall mount bracket with minimum weight/load bearing capacity of 3.2 kg (7.05 lb).

Operating the Monitor

Turning on the Monitor

Press the  button to turn on the monitor.





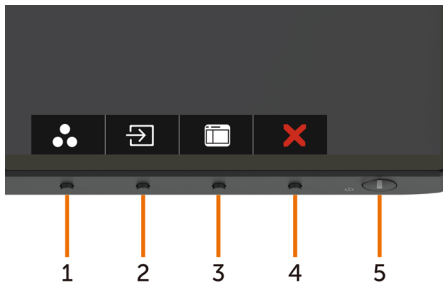

Using the Front Panel Controls

Use the control buttons on the front of the monitor to adjust the characteristics of the image being displayed. As you use these buttons to adjust the controls, an OSD shows the numeric values of the characteristics as they change.







The following table describes the front panel buttons:

Front-Panel Button	Description
1  Shortcut key: Preset Modes	Use this button to choose from a list of preset color modes.
2  Shortcut key: Input Source	Use this button to choose from a list of Input Source.
3  Menu	Use this menu button to launch the on-screen display (OSD) and select the OSD menu. See Accessing the Menu System .
4  Exit	Use this button to go back to the main menu or exit the OSD main menu.
5  Power (with power light indicator)	Use the Power button to turn the monitor On and Off. The white LED indicates the monitor is On and fully functional. A glowing white LED indicates DPMS Power Save Mode.

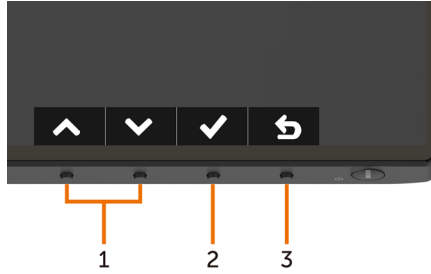
Front-Panel Button

Use the buttons on the front of the monitor to adjust the image settings.



Front Panel Button	Description
1  Up  Down	Use the Up (increase) and Down (decrease) keys to adjust items in the OSD menu.
2  OK	Use the OK button to confirm your selection.
3  Back	Use the Back button to go back to the previous menu.









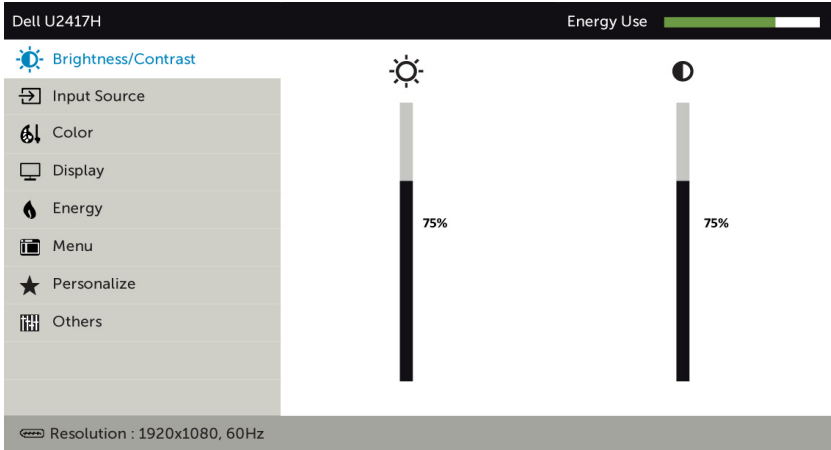



Using the On-Screen Display (OSD) Menu

Accessing the Menu System

 **NOTE:** Any changes you make using the OSD menu are automatically saved if you move to another OSD menu, exit the OSD menu, or wait for the OSD menu to disappear.



- 1 Press the  button to launch the OSD menu and display the main menu.



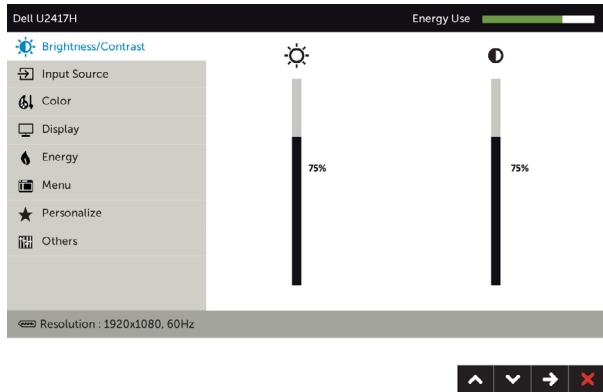

- 2 Press the  and  buttons to move between options. As you move from one icon to another, the option name is highlighted.
- 3 Press the  or  or  button once to activate the highlighted option.
- 4 Press the  and  buttons to select the desired parameter.
- 5 Press  to enter the slide bar and then use the  or  button, according to the indicators on the menu, to make your changes.
- 6 Select the  to return to previous menu or  to accept and return to previous menu.

Icon	Menu and Submenus	Description
	Brightness/Contrast	Use this menu to activate Brightness/Contrast adjustment.





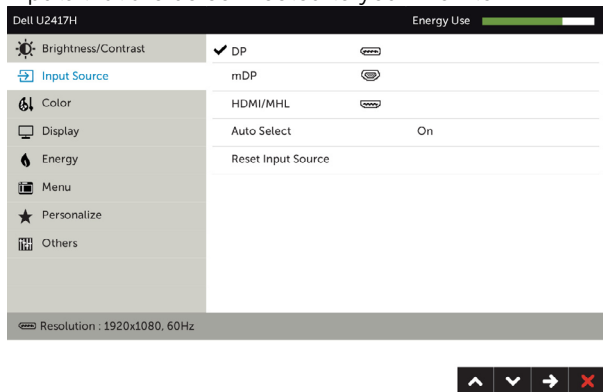

Brightness **Brightness** adjusts the luminance of the backlight (minimum 0; maximum 100).
 Press the  button to increase brightness.
 Press the  button to decrease brightness.
NOTE: Manual adjustment of **Brightness** is disabled when **Dynamic Contrast** is switched on.

Contrast Adjust the **Brightness** first, and then adjust **Contrast** only if further adjustment is necessary.
 Press the  button to increase contrast and press the  button to decrease contrast (between 0 and 100).
 Contrast adjusts the difference between darkness and lightness on the monitor.

	Input Source	Use the Input Source menu to select between different video inputs that are be connected to your monitor.
---	---------------------	--



Icon	Menu and Submenus	Description
	DP	Select DP input when you are using the DP (DisplayPort) connector. Use  to select the DP input source.
	mDP	Select mDP input when you are using the mDP (mini DisplayPort) connector. Use  to select the mDP input source.
	HDMI/MHL	Select the HDMI/MHL input when you are using the HDMI connector. Use  to select the HDMI/MHL input source.
	Auto Select	Use  to select Auto Select , the monitor scans for available input sources.
	Reset Input Source	Resets your monitor's Input Source settings to the factory defaults.



Color

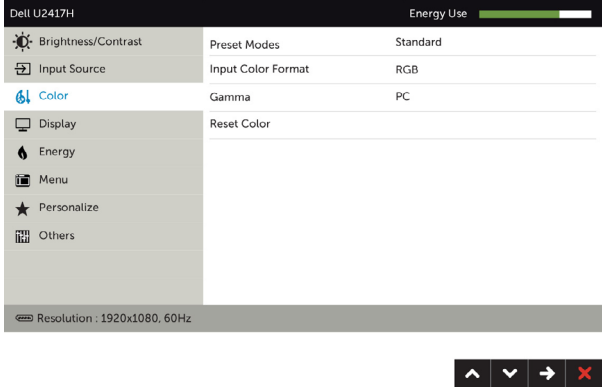

Use the **Color** menu to adjust the color setting mode.

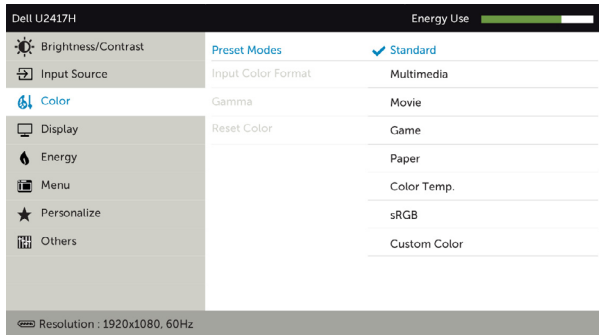

Icon	Menu and Submenus	Description
------	-------------------	-------------

Preset Modes When you select **Preset Modes**, you can choose **Standard, Multimedia, Movie, Game, Paper, Color Temp., sRGB or Custom Color** from the list.



- **Standard:** Default color settings. This is the default preset mode.
- **Multimedia:** Ideal for multimedia applications.
- **Movie:** Ideal for movies.
- **Game:** Ideal for most gaming applications.
- **Paper:** Loads brightness and sharpness settings ideal for viewing text. Blend the text background to simulate paper media without affecting color images.
- **Color Temp.:** The screen appears warmer with a red/yellow tint with slider set at 5,000K or cooler with blue tint with slider set at 10,000K.
- **sRGB:** Emulates 99% sRGB.
- **Custom Color:** Allows you to manually adjust the color settings. Press the  and  buttons to adjust the Red, Green, and Blue values and create your own preset color mode.

Icon	Menu and Submenus	Description
------	-------------------	-------------

Input Color Format

Allows you to set the video input mode to:

- **RGB**: Select this option if your monitor is connected to a computer (or DVD player) using the HDMI, DP-mDP cable or MHL devices using the MHL cable.
- **YPbPr**: Select this option if your DVD player supports only YPbPr output.

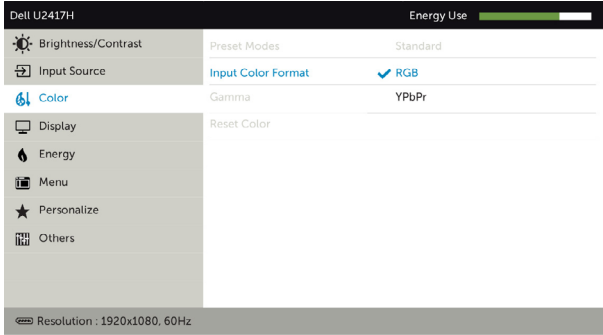





Gamma Allows you to set the Gamma to **PC** or **MAC**.

Hue Use or to adjust the hue from 0 to 100.
NOTE: Hue adjustment is available only for Movie and Game mode.

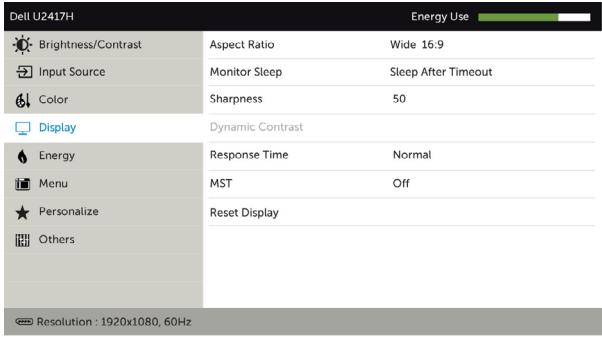
Saturation Use or to adjust the saturation from 0 to 100.
NOTE: Saturation adjustment is available only for Movie and Game mode.

Reset Color Resets your monitor's color settings to the factory defaults.

Icon	Menu and Submenus	Description
	Display	Use the Display menu to adjust image.
		
		
	Aspect Ratio	Adjust the image ratio to Wide 16:9 , 4:3 , or 5:4 .
	Monitor Sleep	Sleep After Timeout: Monitor goes into sleep after timeout. Never: Monitor never goes into sleep.
	Sharpness	Makes the image look sharper or softer. Use  or  to adjust the sharpness from '0' to '100'.
	Dynamic Contrast	Allows you to increase the level of contrast to provide sharper and more detailed image quality. Push the  button to select the Dynamic Contrast "On" or "Off". NOTE: For Game and Movie preset mode only. NOTE: Dynamic Contrast provides higher contrast if you select Game or Movie preset mode.
	Response Time	Allows you to set the Response Time to Normal or Fast .
	MST	DP Multi Stream Transport, Set to ON enables MST(DP out), Set to OFF disables MST function.
	Reset Display	Restores the display settings to factory defaults.

Icon	Menu and Submenus	Description
------	-------------------	-------------



Energy

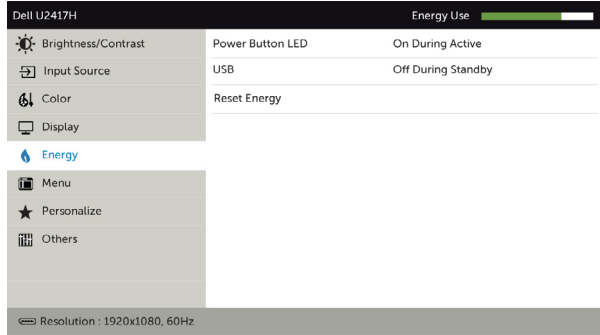

Power Button LED

Allows you to set the state of the power light to save energy.

USB

Allows you to enable or disable USB function during monitor standby mode.

NOTE: USB ON/OFF under standby mode is only available when the USB upstream cable is unplugged. This option will be greyed out when the USB upstream cable plugs in.

Reset Energy





Select this option to restore default **Energy** settings.

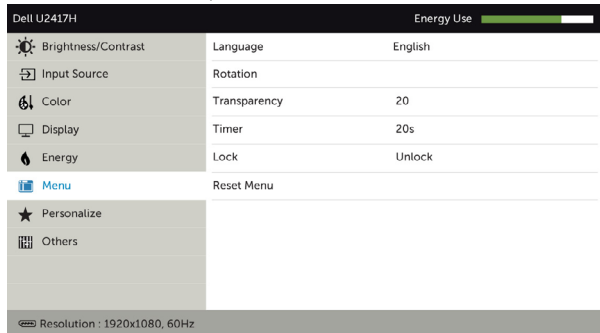

Menu

Select this option to adjust the settings of the OSD, such as, the languages of the OSD, the amount of time the menu remains on screen, and so on.



Icon	Menu and Submenus	Description
	Language	Set the OSD display to one of eight languages. (English, Spanish, French, German, Brazilian Portuguese, Russian, Simplified Chinese, or Japanese).
	Rotation	Rotates the OSD by 0/90/180/270 degrees. You can adjust the menu according to your display rotation.
	Transparency	Select this option to change the menu transparency by using  and  (min. 0 / max. 100).
	Timer	OSD Hold Time: Sets the length of time the OSD remains active after you press a button. Use the  and  buttons to adjust the slider in 1-second increments, from 5 to 60 seconds.
	Lock	Controls user access to adjustments. When Lock is selected, no user adjustments are allowed. All buttons are locked. NOTE: Lock function – Either soft lock (through OSD menu) or hard lock (Press and hold the exit button 6 sec) Unlock function – Only hard unlock (Press and hold the exit button 6 sec)
	Reset Menu	Restore the menu settings to factory defaults.



Personalize Select from **Preset Modes, Brightness/Contrast, Input Source, Aspect Ratio, Rotation** set as shortcut key.

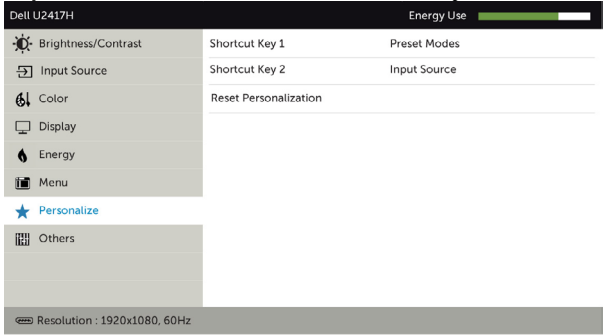

Reset Personalization Restores shortcut keys to factory defaults.

Icon Menu and Submenus

Description



Other

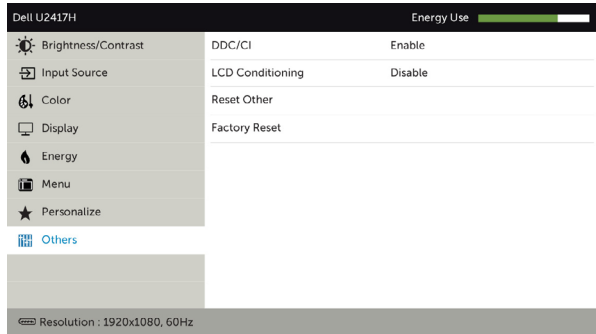

Select this option to adjust the OSD settings, such as the **DDC/CI**, **LCD conditioning**, and so on.

DDC/CI

DDC/CI (Display Data Channel/Command Interface) allows you to adjust the monitor settings using software on your computer.

Select **Disable** to turn off this feature.

Enable this feature for best user experience and optimum performance of your monitor.

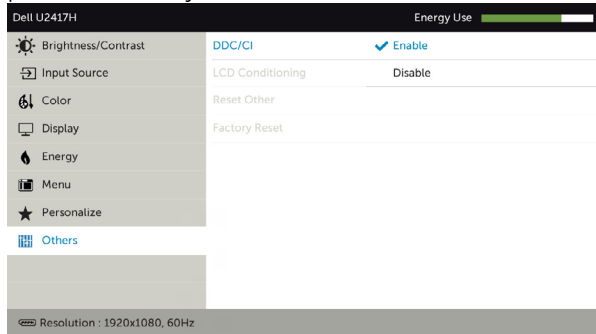

Icon	Menu and Submenus	Description
------	-------------------	-------------

LCD Conditioning

Helps reduce minor cases of image retention. Depending on the degree of image retention, the program may take some time to run. Select **Enable** to start the process.

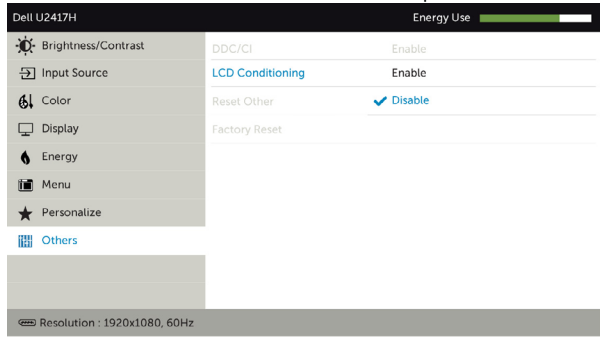

Reset Others Restores other settings, such as **DDC/CI**, to factory defaults.

Factory Reset Restores all OSD settings to the factory defaults.



NOTE: This monitor has a built-in feature to automatically calibrate the brightness to compensate for LED aging.

OSD Warning Messages

When the **Dynamic Contrast** feature is enabled (in these preset modes: **Game** or **Movie**), manual brightness adjustment is disabled.



When the monitor does not support a particular resolution mode, you can see the following message:

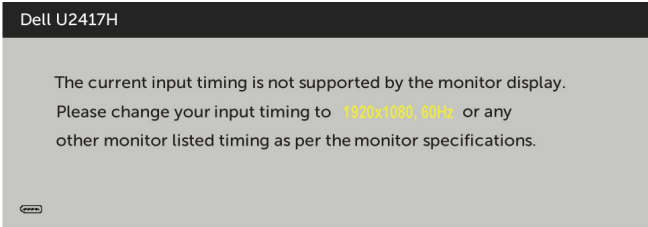

This means that the monitor cannot synchronize with the signal that it is receiving from the computer. See [Monitor Specifications](#) for the Horizontal and Vertical frequency ranges addressable by this monitor. Recommended mode is 1920 x 1080.

You can see the following message before the DDC/CI function is disabled:

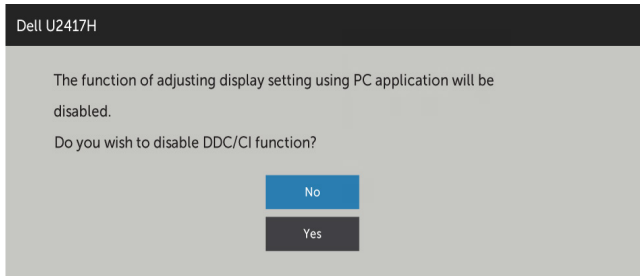

When the monitor enters the **Power Save** mode, the following message appears:

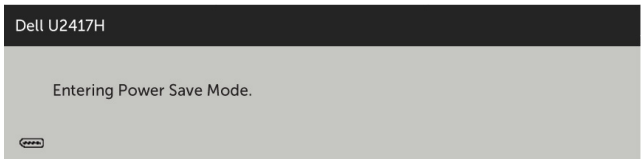

Activate the computer and wake up the monitor to gain access to the [OSD](#).
If you press any button other than the power button, the following messages will appear depending on the selected input:

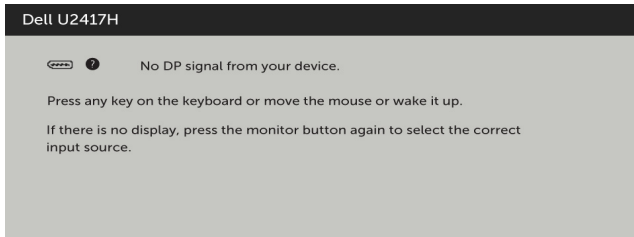

If either DP, mDP, HDMI/MHL input is selected and the corresponding cable is not connected, a floating dialog box as shown below appears.

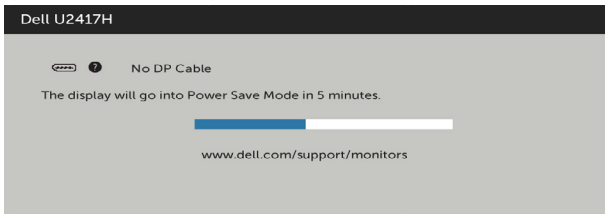

or

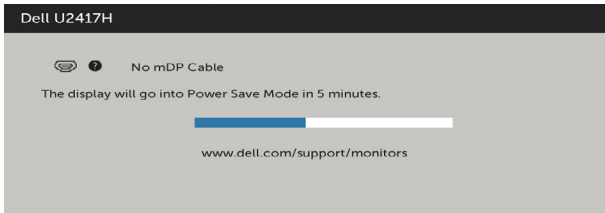

or

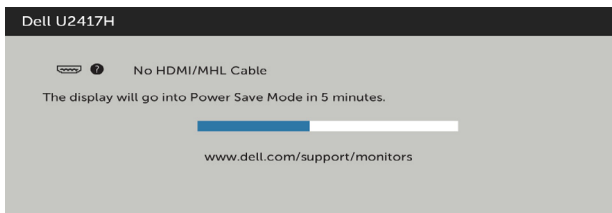

See [Troubleshooting](#) for more information.

Troubleshooting

⚠ WARNING: Before you begin any of the procedures in this section, follow the [Safety Instructions](#).

Self-Test

Your monitor provides a self-test feature that allows you to check whether your monitor is functioning properly. If your monitor and computer are properly connected but the monitor screen remains dark, run the monitor self-test by performing the following steps:

- 1 Turn off both your computer and the monitor.
- 2 Unplug the video cable from the back of the computer. To ensure proper Self-Test operation, remove all digital and the analog cables from the back of computer.
- 3 Turn on the monitor.

The floating dialog box should appear on-screen (against a black background), if the monitor cannot sense a video signal and is working correctly. While in self-test mode, the power LED remains white. Also, depending upon the selected input, one of the dialogs shown below will continuously scroll through the screen.

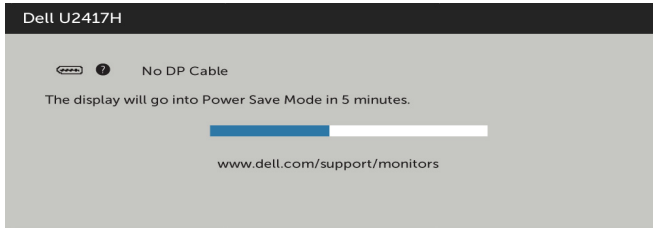

or

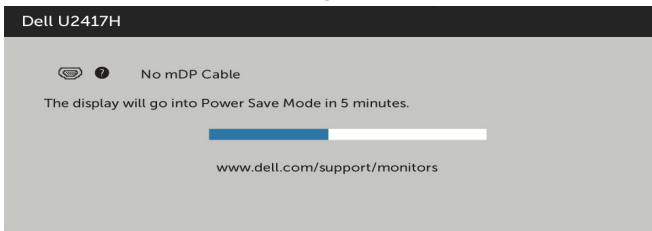

or

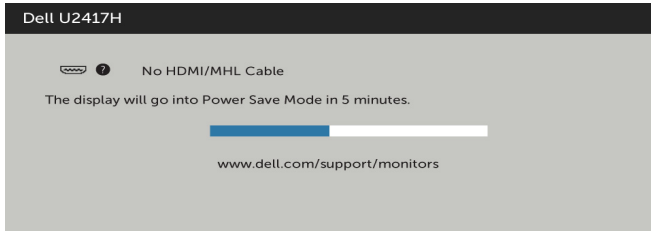

- 4 This box also appears during normal system operation, if the video cable becomes disconnected or damaged.
- 5 Turn off your monitor and reconnect the video cable; then turn on both your computer and the monitor.

If your monitor screen remains blank after you use the previous procedure, check your video controller and computer, because your monitor is functioning properly.

Built-in Diagnostics

Your monitor has a built-in diagnostic tool that helps you determine if the screen abnormality you are experiencing is an inherent problem with your monitor, or with your computer and video card.

 **NOTE:** You can run the built-in diagnostics only when the video cable is unplugged and the monitor is in self-test mode.

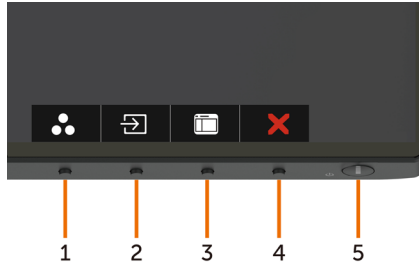

To run the built-in diagnostics:

- 1 Make sure that the screen is clean (no dust particles on the surface of the screen).
- 2 Unplug the video cable(s) from the back of the computer or monitor. The monitor then goes into the self-test mode.
- 3 Press and hold **Button 1** and **Button 4** on the front panel simultaneously for 2 seconds. A gray screen appears.
- 4 Carefully inspect the screen for abnormalities.
- 5 Press **Button 4** on the front panel again. The color of the screen changes to red.
- 6 Inspect the display for any abnormalities.
- 7 Repeat steps 5 and 6 to inspect the display in green, blue, black, white, and text screens.

The test is complete when the text screen appears. To exit, press **Button 4** again. If you do not detect any screen abnormalities upon using the built-in diagnostic tool, the monitor is functioning properly. Check the video card and computer.

Common Problems

The following table contains general information about common monitor problems you might encounter and the possible solutions:

Common Symptoms	What You Experience	Possible Solutions
No Video/Power LED off	No picture	<ul style="list-style-type: none">• Ensure that the video cable connecting the monitor and the computer is properly connected and secure.• Verify that the power outlet is functioning properly using any other electrical equipment.• Ensure that the power button is depressed fully.• Ensure that the correct input source is selected in the Input Source menu.
No Video/Power LED on	No picture or no brightness	<ul style="list-style-type: none">• Increase brightness & contrast controls via OSD.• Perform monitor self-test feature check.• Check for bent or broken pins in the video cable connector.• Run the built-in diagnostics.• Ensure that the correct input source is selected in the Input Source menu.
Missing Pixels	LCD screen has spots	<ul style="list-style-type: none">• Cycle power on-off.• Pixel that is permanently off is a natural defect that can occur in LCD technology.• For more information on Dell Monitor Quality and Pixel Policy, see Dell Support site at: http://www.dell.com/support/monitors.
Stuck-on Pixels	LCD screen has bright spots	<ul style="list-style-type: none">• Cycle power On-Off.• Pixel that is permanently off is a natural defect that can occur in LCD technology.• For more information on Dell Monitor Quality and Pixel Policy, see Dell Support site at: http://www.dell.com/support/monitors.
Brightness Problems	Picture too dim or too bright	<ul style="list-style-type: none">• Reset the monitor to factory settings.• Adjust brightness & contrast controls via OSD.
Safety Related Issues	Visible signs of smoke or sparks	<ul style="list-style-type: none">• Do not perform any troubleshooting steps.• Contact Dell immediately.
Intermittent Problems	Monitor malfunctions on & off	<ul style="list-style-type: none">• Ensure that the video cable connecting the monitor to the computer is connected properly and is secure.• Reset the monitor to factory settings.• Perform monitor self-test feature check to determine if the intermittent problem occurs in self-test mode.

Common Symptoms	What You Experience	Possible Solutions
Missing Color	Picture missing color	<ul style="list-style-type: none"> • Perform monitor self-test. • Ensure that the video cable connecting the monitor to the computer is connected properly and is secure. • Check for bent or broken pins in the video cable connector.
Wrong Color	Picture color not good	<ul style="list-style-type: none"> • Change the settings of the Preset Modes in the Color menu OSD depending on the application. • Adjust R/G/B value under Custom. Color in Color menu OSD. • Change the Input Color Format to PC RGB or YPbPr in the Color menu OSD. • Run the built-in diagnostics.
Image retention from a static image left on the monitor for a long period of time	Faint shadow from the static image displayed appears on the screen	<ul style="list-style-type: none"> • Use the Power Management feature to turn off the monitor at all times when not in use (for more information, see Power Management Modes). • Alternatively, use a dynamically changing screensaver.

Product Specific Problems

Specific Symptoms	What You Experience	Possible Solutions
Screen image is too small	Image is centered on screen, but does not fill entire viewing area	<ul style="list-style-type: none"> • Check the Aspect Ratio setting in the Display menu OSD. • Reset the monitor to factory settings.
Cannot adjust the monitor with the buttons on the front panel	OSD does not appear on the screen	<ul style="list-style-type: none"> • Turn off the monitor, unplug the monitor power cable, plug it back, and then turn on the monitor. • Check whether the OSD menu is locked. If yes, press and hold the button beside the power button for 6 seconds to unlock (for more information, see Lock).
No Input Signal when user controls are pressed	No picture, the LED light is white	<ul style="list-style-type: none"> • Check the signal source. Ensure the computer is not in the power saving mode by moving the mouse or pressing any key on the keyboard. • Check whether the signal cable is plugged in properly. Re-plug the signal cable if necessary. • Reset the computer or video player.
The picture does not fill the entire screen	The picture cannot fill the height or width of the screen	<ul style="list-style-type: none"> • Due to different video formats (aspect ratio) of DVDs, the monitor may display in full screen. • Run the built-in diagnostics.

Specific Symptoms	What You Experience	Possible Solutions
No image when using DP connection to the PC	Black screen	<ul style="list-style-type: none"> • Verify which DP standard (DP 1.1a or DP 1.2) is your Graphics Card certified to. Download and install the latest graphics card driver. • Some DP 1.1a graphics card cannot support DP 1.2 monitors. Go to OSD menu, under Input Source selection, press and hold DP select  key for 8 sec to change the monitor setting from DP 1.2 to DP 1.1a.

Mobile High-Definition Link (MHL) Specific Problems

Specific Symptoms	What You Experience	Possible Solutions
MHL interface is not working	Cannot see MHL device image shown on the monitor	<ul style="list-style-type: none"> • Ensure your MHL cable and MHL device are MHL certified. • Check your MHL device is turned on. • Check your MHL device is not in standby mode. • Check physical MHL cable connection is corresponding to input source selected on OSD Menu: HDMI/MHL. • Wait for 30 seconds after connecting MHL cable as some MHL devices require longer recovery time.

Appendix

Safety Instructions

For displays with glossy bezels the user should consider the placement of the display as the bezel may cause disturbing reflections from surrounding light and bright surfaces.

 **WARNING: Use of controls, adjustments, or procedures other than those specified in this documentation may result in exposure to shock, electrical hazards, and/or mechanical hazards.**

For information on safety instructions, see the Safety, Environmental, and Regulatory Information (SERI).

FCC Notices (U.S. only) and Other Regulatory Information

For FCC notices and other regulatory information, see the regulatory compliance website located at www.dell.com/regulatory_compliance.

Contacting Dell

 **NOTE:** If you do not have an active Internet connection, you can find contact information on your purchase invoice, packing slip, bill, or Dell product catalog.

Dell provides several online and telephone-based support and service options. Availability varies by country and product, and some services may not be available in your area.

To get online Monitor support content:

See www.dell.com/support/monitors.

To contact Dell for sales, technical support, or customer service issues:

- 1 Go to www.dell.com/support.
- 2 Verify your country or region in the Choose A Country/Region drop-down menu at the top-left corner of the page.
- 3 Click **Contact Us** next to the country dropdown.
- 4 Select the appropriate service or support link based on your need.
- 5 Choose the method of contacting Dell that is convenient for you.

Setting Up Your Monitor

Setting Display Resolution to 1920 x 1080 (maximum)

For best performance, set the display resolution to 1920 x 1080 pixels by performing the following steps:

In Windows Vista, Windows 7, Windows 8 or Windows 8.1:

- 1 For Windows 8 or Windows 8.1 only, select the Desktop tile to switch to classic desktop.
- 2 Right-click on the desktop and click **Screen Resolution**.
- 3 Click the Dropdown list of the Screen Resolution and select 1920 x 1080.
- 4 Click **OK**.

In Windows 10:

- 1 Right-click on the desktop and click **Display Settings**.
- 2 Click **Advanced display settings**.
- 3 Click the dropdown list of **Resolution** and select 1920 x 1080.
- 4 Click **Apply**.

If you do not see the recommended resolution as an option, you may need to update your graphics driver. Please choose the scenario below that best describes the computer system you are using, and follow the given steps.

Dell computer

- 1 Go to www.dell.com/support, enter your service tag, and download the latest driver for your graphics card.
- 2 After installing the drivers for your graphics adapter, attempt to set the resolution to 1920 x 1080 again.

 **NOTE:** If you are unable to set the resolution to 1920 x 1080, please contact Dell to inquire about a graphics adapter that supports these resolutions.

Non-Dell computer

In Windows Vista, Windows 7, Windows 8 or Windows 8.1:

- 1 For Windows 8 or Windows 8.1 only, select the Desktop tile to switch to classic desktop.
- 2 Right-click on the desktop and click **Personalization**.
- 3 Click **Change Display Settings**.
- 4 Click **Advanced Settings**.
- 5 Identify your graphics controller supplier from the description at the top of the window (e.g. NVIDIA, ATI, Intel etc.).
- 6 Refer to the graphic card provider website for updated driver (for example, <http://www.ATI.com> or <http://www.NVIDIA.com>).
- 7 After installing the drivers for your graphics adapter, attempt to set the resolution to **1920 x 1080** again.

In Windows 10:

- 1 Right-click on the desktop and click **Display Settings**.
- 2 Click **Advanced display settings**.
- 3 Click **Display adapter properties**.
- 4 Identify your graphics controller supplier from the description at the top of the window (e.g. NVIDIA, ATI, Intel etc.).
- 5 Refer to the graphic card provider website for updated driver (for example, <http://www.ATI.com> or <http://www.NVIDIA.com>).
- 6 After installing the drivers for your graphics adapter, attempt to set the resolution to 1920 x 1080 again.



NOTE: If you are unable to set the recommended resolution, please contact the manufacturer of your computer or consider purchasing a graphics adapter that supports the video resolution.

Maintenance Guidelines

Cleaning Your Monitor



WARNING: Before cleaning the monitor, unplug the monitor power cable from the electrical outlet.



CAUTION: Read and follow the [Safety Instructions](#) before cleaning the monitor.

For best practices, follow these instructions in the list below while unpacking, cleaning, or handling your monitor:

- To clean your anti-static screen, lightly dampen a soft, clean cloth with water. If possible, use a special screen-cleaning tissue or solution suitable for the anti-static coating. Do not use benzene, thinner, ammonia, abrasive cleaners, or compressed air.
- Use a lightly-dampened, soft cloth to clean the monitor. Avoid using detergent of any kind as some detergents leave a milky film on the monitor.
- If you notice white powder when you unpack your monitor, wipe it off with a cloth.
- Handle your monitor with care as a darker-colored monitor may get scratched and show white scuff marks more than a lighter-colored monitor.
- To help maintain the best image quality on your monitor, use a dynamically changing screen saver and turn off your monitor when not in use.