

Inspiron 17 5000

Service Manual

Computer Model: Inspiron 17-5767
Regulatory Model: P32E
Regulatory Type: P32E001

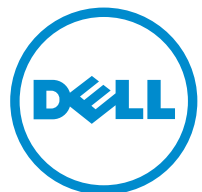

Notes, cautions, and warnings



NOTE: A NOTE indicates important information that helps you make better use of your computer.



CAUTION: A CAUTION indicates either potential damage to hardware or loss of data and tells you how to avoid the problem.



WARNING: A WARNING indicates a potential for property damage, personal injury, or death.

© 2016 Dell Inc. All rights reserved. This product is protected by U.S. and international copyright and intellectual property laws. Dell and the Dell logo are trademarks of Dell Inc. in the United States and/or other jurisdictions. All other marks and names mentioned herein may be trademarks of their respective companies.

2016-09

Rev. A00

Contents

Before working inside your computer.....	10
Before you begin	10
Safety instructions.....	10
Recommended tools.....	11
Screw list.....	12
After working inside your computer.....	14
Removing the optical drive.....	15
Procedure.....	15
Replacing the optical drive.....	18
Procedure.....	18
Removing the base cover.....	19
Prerequisites.....	19
Procedure.....	20
Replacing the base cover.....	22
Procedure.....	22
Post-requisites.....	22
Removing the battery.....	23
Prerequisites.....	23
Procedure.....	23
Replacing the battery.....	25
Procedure.....	25
Post-requisites.....	25

Removing the hard drive.....	26
Prerequisites.....	26
Procedure.....	26
Replacing the hard drive.....	29
Procedure.....	29
Post-requisites.....	29
Removing the memory modules.....	30
Prerequisites.....	30
Procedure.....	30
Replacing the memory modules.....	32
Procedure.....	32
Post-requisites.....	33
Removing the wireless card.....	35
Prerequisites.....	35
Procedure.....	35
Replacing the wireless card.....	37
Procedure.....	37
Post-requisites.....	38
Removing the coin-cell battery.....	40
Prerequisites.....	40
Procedure.....	40
Replacing the coin-cell battery.....	42
Procedure.....	42
Post-requisites.....	42

Removing the touch pad.....	43
Prerequisites.....	43
Procedure.....	43
Replacing the touch pad.....	46
Procedure.....	46
Post-requisites.....	46
Removing the speakers.....	47
Prerequisites.....	47
Procedure.....	47
Replacing the speakers.....	49
Procedure.....	49
Post-requisites.....	49
Removing the I/O board.....	50
Prerequisites.....	50
Procedure.....	50
Replacing the I/O board.....	52
Procedure.....	52
Post-requisites.....	52
Removing the status-light board.....	53
Prerequisites.....	53
Procedure.....	53
Replacing the status-light board.....	56
Procedure.....	56
Post-requisites.....	56

Removing the optical-drive interposer.....	57
Prerequisites.....	57
Procedure.....	57
Replacing the optical-drive interposer.....	59
Procedure.....	59
Post-requisites.....	59
Removing the heat-sink assembly.....	60
Prerequisites.....	60
Procedure.....	60
Replacing the heat-sink assembly.....	62
Procedure.....	62
Post-requisites.....	62
Removing the display assembly.....	63
Prerequisites.....	63
Procedure.....	63
Replacing the display assembly.....	66
Procedure.....	66
Post-requisites.....	66
Removing the system board.....	67
Prerequisites.....	67
Procedure.....	67
Replacing the system board.....	72
Procedure.....	72
Post-requisites.....	73

Removing the power-button board.....	74
Prerequisites.....	74
Procedure.....	74
Replacing the power-button board.....	76
Procedure.....	76
Post-requisites.....	76
Removing the power-adapter port.....	77
Prerequisites.....	77
Procedure.....	77
Replacing the power-adapter port.....	79
Procedure.....	79
Post-requisites.....	79
Removing the palm rest and keyboard assembly.....	80
Prerequisites.....	80
Procedure.....	80
Replacing the palm rest and keyboard assembly.....	82
Procedure.....	82
Post-requisites.....	82
Removing the display bezel.....	83
Prerequisites.....	83
Procedure.....	83
Replacing the display bezel.....	85
Procedure.....	85
Post-requisites.....	85

Removing the display panel.....	86
Prerequisites.....	86
Procedure.....	86
Replacing the display panel.....	89
Procedure.....	89
Post-requisites.....	89
Removing the display hinges.....	90
Prerequisites.....	90
Procedure.....	90
Replacing the display hinges.....	92
Procedure.....	92
Post-requisites.....	92
Removing the camera.....	93
Prerequisites.....	93
Procedure.....	93
Replacing the camera.....	95
Procedure.....	95
Post-requisites.....	95
Removing the display cable.....	96
Prerequisites.....	96
Procedure.....	96
Replacing the display cable.....	99
Procedure.....	99
Post-requisites.....	99



Removing the display back-cover and antenna assembly.....	100
Prerequisites.....	100
Procedure.....	100
Replacing the display back-cover and antenna assembly.....	102
Procedure.....	102
Post-requisites.....	102
Flashing the BIOS.....	103
System diagnostic lights.....	104
Getting help and contacting Dell.....	106
Self-help resources.....	106
Contacting Dell.....	107

Before working inside your computer

 **NOTE:** The images in this document may differ from your computer depending on the configuration you ordered.

Before you begin

- 1 Save and close all open files and exit all open applications.
- 2 Shut down your computer.
The shut-down instruction varies depending on the operating system installed on your computer.









- Windows 10: Click **Start** →  **Power** → **Shut down**.
- Windows 8.1: On the **Start** screen, Click the power icon  → **Shut down**.
- Windows 7: Click **Start** → **Shut down**.

 **NOTE:** If you are using a different operating system, see the documentation of your operating system for shut-down instructions.

- 3 Disconnect your computer and all attached devices from their electrical outlets.
- 4 Disconnect all cables such as telephone cables and network cables, from your computer.
- 5 Disconnect all attached devices and peripherals, such as keyboard, mouse, and monitor, from your computer.
- 6 Remove any media card and optical disc from your computer, if applicable.
- 7 Close the display and turn the computer over.

Safety instructions

Use the following safety guidelines to protect your computer from potential damage and ensure your personal safety.

-  **WARNING:** Before working inside your computer, read the safety information that shipped with your computer. For more safety best practices, see the Regulatory Compliance home page at www.dell.com/regulatory_compliance.
-  **WARNING:** Disconnect all power sources before opening the computer cover or panels. After you finish working inside the computer, replace all covers, panels, and screws before connecting to the electrical outlet.
-  **CAUTION:** To avoid damaging the computer, ensure that the work surface is flat and clean.
-  **CAUTION:** To avoid damaging the components and cards, handle them by their edges, and avoid touching pins and contacts.
-  **CAUTION:** You should only perform troubleshooting and repairs as authorized or directed by the Dell technical assistance team. Damage due to servicing that is not authorized by Dell is not covered by your warranty. See the safety instructions that shipped with the product or at www.dell.com/regulatory_compliance.
-  **CAUTION:** Before touching anything inside your computer, ground yourself by touching an unpainted metal surface, such as the metal at the back of the computer. While you work, periodically touch an unpainted metal surface to dissipate static electricity, which could harm internal components.
-  **CAUTION:** When you disconnect a cable, pull on its connector or on its pull tab, not on the cable itself. Some cables have connectors with locking tabs or thumb-screws that you must disengage before disconnecting the cable. When disconnecting cables, keep them evenly aligned to avoid bending any connector pins. When connecting cables, ensure that the ports and connectors are correctly oriented and aligned.
-  **CAUTION:** Press and eject any installed card from the media-card reader.

Recommended tools











The procedures in this document may require the following tools:

- Phillips screwdriver

- Plastic scribe

Screw list

Component	Secured to	Screw type	Quantity	Screw image
Base cover	Palm rest and keyboard assembly	M2x2 Big Head	3	
Base cover	Palm rest and keyboard assembly	M2x4	2	
Base cover	Palm rest and keyboard assembly	M2.5x8	13	
Battery	Palm rest and keyboard assembly	M2x3	4	
Fan	Palm rest and keyboard assembly	M2.5x5	1	
Hard drive	Hard-drive bracket	M3x3	4	
Hard-drive bracket	Palm rest and keyboard assembly	M2.5x5	3	
Heat-sink assembly	System board	M2x3	3	
Hinge brackets	Display back-cover and antenna assembly	M2.5x4	8	
Hinge brackets	Palm rest and key board assembly	M2.5x5	4	
Hinge (LCD side)	Display back-cover and	M2x3	2	

Component	Secured to	Screw type	Quantity	Screw image
	antenna assembly			
I/O board	Palm rest and keyboard assembly	M2.5x5	1	
Optical-drive bracket	Optical drive	M2x3	2	
Optical-drive interposer	Palm rest and keyboard assembly	M2x2 Big Head	2	
Panel	Display back-cover and antenna assembly	M2x3	4	
Power-adapter port	Palm rest and keyboard assembly	M2x3	1	
Power-button board	Palm rest and keyboard assembly	M2x3	1	
System board	Palm rest and keyboard assembly	M2x3	3	
Touch pad	Palm rest and keyboard assembly	M2x2	4	
Touch-pad bracket	Palm rest and keyboard assembly	M2x2	3	
Wireless-card bracket	System board	M2x3	1	

After working inside your computer



CAUTION: Leaving stray or loose screws inside your computer may severely damage your computer.

- 1 Replace all screws and ensure that no stray screws remain inside your computer.
- 2 Connect any external devices, peripherals, or cables you removed before working on your computer.
- 3 Replace any media cards, discs, or any other parts that you removed before working on your computer.
- 4 Connect your computer and all attached devices to their electrical outlets.
- 5 Turn on your computer.

Removing the optical drive



WARNING: Before working inside your computer, read the safety information that shipped with your computer and follow the steps in [Before working inside your computer](#). After working inside your computer, follow the instructions in [After working inside your computer](#). For more safety best practices, see the Regulatory Compliance home page at www.dell.com/regulatory_compliance.

Procedure

- 1 Remove the screw that secures the optical-drive assembly to the palm rest and keyboard assembly.
- 2 Using a plastic scribe, push the optical drive through the slot to release the optical-drive assembly out of the optical-drive bay.

3 Slide the optical-drive assembly out of the optical-drive bay.



1 optical-drive assembly

2 palm rest and keyboard assembly

3 M2x4 screw

4 plastic scribe

4 Remove the screws that secure the optical-drive bracket to the optical drive.

5 Remove the optical-drive bracket.

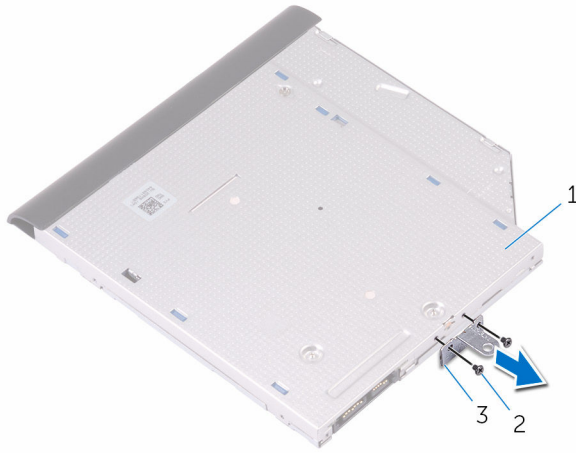

1 optical drive

2 M2x3 screws (2)

3 optical-drive bracket

6 Pull the optical-drive bezel carefully to remove it from the optical drive.



1 optical-drive bezel

2 optical drive

3 tabs (3)

Replacing the optical drive



WARNING: Before working inside your computer, read the safety information that shipped with your computer and follow the steps in [Before working inside your computer](#). After working inside your computer, follow the instructions in [After working inside your computer](#). For more safety best practices, see the Regulatory Compliance home page at www.dell.com/regulatory_compliance.

Procedure

- 1 Align the tabs on the optical-drive bezel with the slots on the optical drive and snap the optical-drive bezel into place.
- 2 Align the screw holes on the optical-drive bracket with the screw holes on the optical drive.
- 3 Replace the screws that secure the optical-drive bracket to the optical drive.
- 4 Slide the optical-drive assembly into the optical-drive bay.
- 5 Align the screw hole on the optical-drive bracket with the screw hole on the base cover.
- 6 Replace the screw that secures the optical-drive assembly to the base cover.

Removing the base cover



WARNING: Before working inside your computer, read the safety information that shipped with your computer and follow the steps in [Before working inside your computer](#). After working inside your computer, follow the instructions in [After working inside your computer](#). For more safety best practices, see the Regulatory Compliance home page at www.dell.com/regulatory_compliance.

Prerequisites

Remove the [optical drive](#).

Procedure

- 1 Remove the screws that secure the base cover to the palm rest and keyboard assembly.

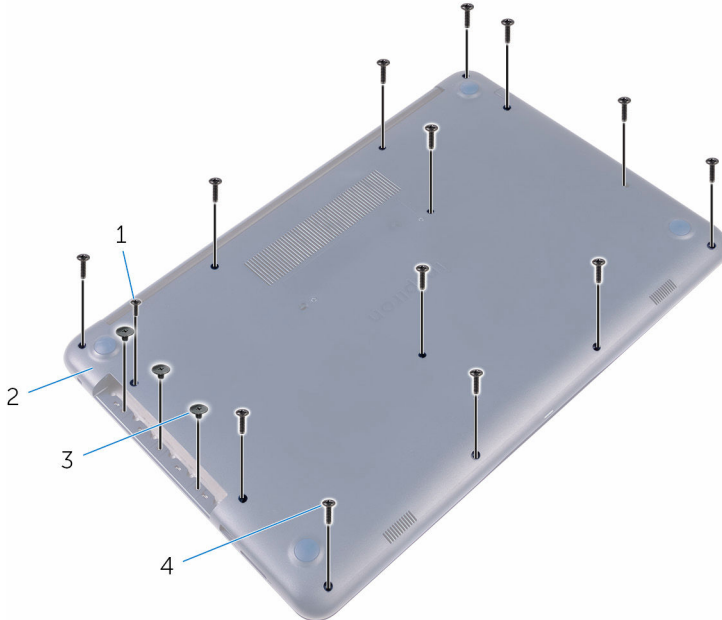

- | | | | |
|---|-----------------|---|--------------------|
| 1 | M2x4 screw | 2 | base cover |
| 3 | M2x2 screws (3) | 4 | M2.5x8 screws (13) |

- 2 Using a plastic scribe, pry the base cover off starting from the top-left corner of the computer base.

- 3 Lift the base cover off the palm rest and keyboard assembly at an angle.

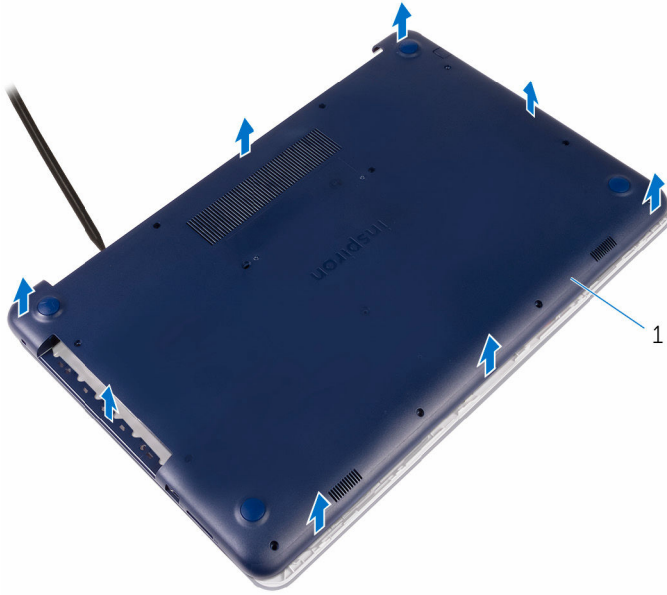

1 base cover

Replacing the base cover



WARNING: Before working inside your computer, read the safety information that shipped with your computer and follow the steps in [Before working inside your computer](#). After working inside your computer, follow the instructions in [After working inside your computer](#). For more safety best practices, see the Regulatory Compliance home page at www.dell.com/regulatory_compliance.

Procedure

- 1 Slide the tabs on the base cover into the slots on the palm rest and keyboard assembly and snap the base cover into place.
- 2 Replace the screws that secure the base cover to the palm rest and keyboard assembly.

Post-requisites

Replace the [optical drive](#).

Removing the battery



WARNING: Before working inside your computer, read the safety information that shipped with your computer and follow the steps in [Before working inside your computer](#). After working inside your computer, follow the instructions in [After working inside your computer](#). For more safety best practices, see the Regulatory Compliance home page at www.dell.com/regulatory_compliance.

Prerequisites

- 1 Remove the [optical drive](#).
- 2 Remove the [base cover](#).

Procedure

- 1 Remove the screws that secure the battery to the palm rest and keyboard assembly.
- 2 Disconnect the battery cable from the system board.

3 Lift the battery off the palm rest and keyboard assembly.

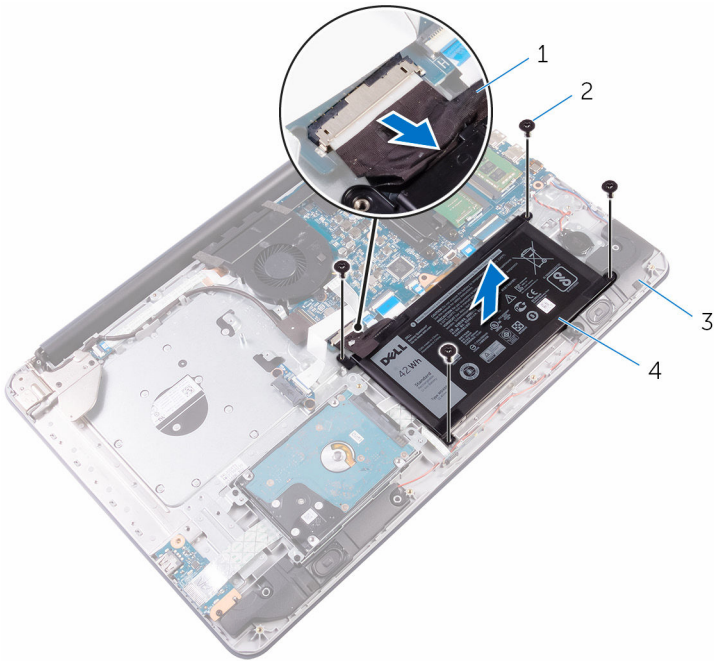

1 battery cable

2 M2x3 screws (4)

3 palm rest and keyboard assembly

4 battery

Replacing the battery



WARNING: Before working inside your computer, read the safety information that shipped with your computer and follow the steps in [Before working inside your computer](#). After working inside your computer, follow the instructions in [After working inside your computer](#). For more safety best practices, see the Regulatory Compliance home page at www.dell.com/regulatory_compliance.



Procedure

- 1 Align the screw holes on the battery with the screw holes on the palm rest and keyboard assembly.
- 2 Replace the screws that secure the battery to the palm rest and keyboard assembly.
- 3 Connect the battery cable to the system board.

Post-requisites

- 1 Replace the [base cover](#).
- 2 Replace the [optical drive](#).

Removing the hard drive

-  **WARNING:** Before working inside your computer, read the safety information that shipped with your computer and follow the steps in [Before working inside your computer](#). After working inside your computer, follow the instructions in [After working inside your computer](#). For more safety best practices, see the Regulatory Compliance home page at www.dell.com/regulatory_compliance.
-  **CAUTION:** Hard drives are fragile. Exercise care when handling the hard drive.
-  **CAUTION:** To avoid data loss, do not remove the hard drive while the computer is in sleep or on state.

Prerequisites

- 1 Remove the [optical drive](#).
- 2 Remove the [base cover](#).
- 3 Remove the [battery](#).

Procedure

- 1 Lift the latch and disconnect the hard-drive cable from the system board.
- 2 Remove the screws that secure the hard-drive assembly to the palm rest and keyboard assembly.

- 3** Lift the hard-drive assembly from the palm rest and keyboard assembly.

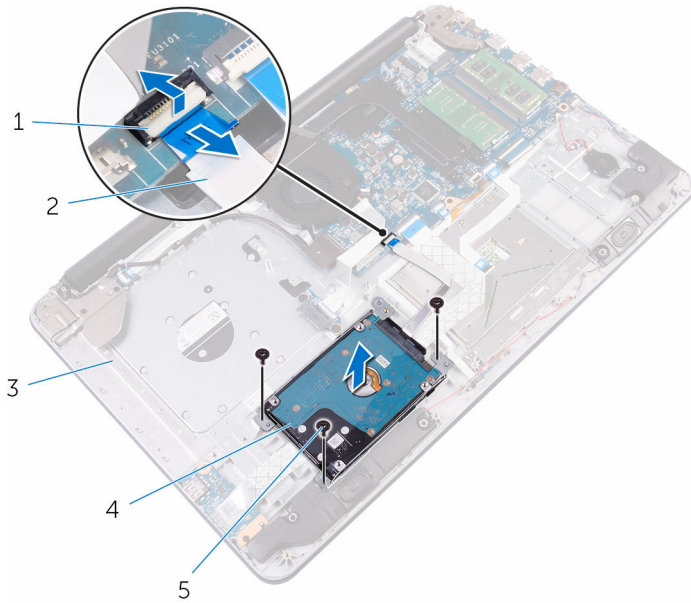

- | | | | |
|---|---------------------------------|---|---------------------|
| 1 | latch | 2 | hard-drive cable |
| 3 | palm rest and keyboard assembly | 4 | hard-drive assembly |
| 5 | M2.5x5 screws (3) | | |

- 4** Remove the screws that secure the hard-drive bracket to the hard drive.

5 Lift the hard drive from the hard-drive bracket.

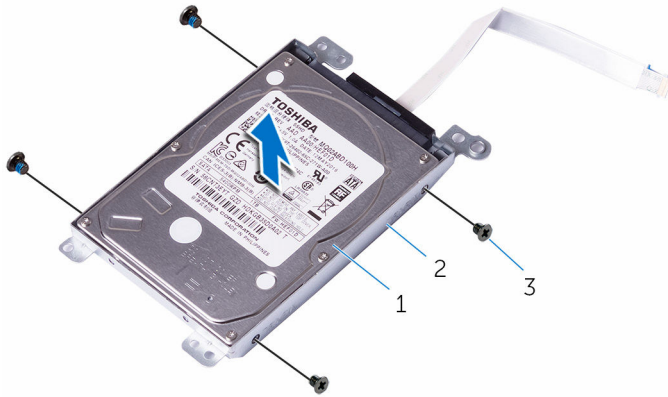

1 hard drive

2 hard-drive bracket

3 M3x3 screws (4)



6 Disconnect the interposer from the hard drive.



1 interposer

2 hard drive

Replacing the hard drive

-  **WARNING:** Before working inside your computer, read the safety information that shipped with your computer and follow the steps in [Before working inside your computer](#). After working inside your computer, follow the instructions in [After working inside your computer](#). For more safety best practices, see the Regulatory Compliance home page at www.dell.com/regulatory_compliance.
-  **CAUTION:** Hard drives are fragile. Exercise care when handling the hard drive.

Procedure

- 1 Connect the interposer to the hard drive.
- 2 Align the screw holes on the hard-drive bracket with the screw holes on the hard drive.
- 3 Replace the screws that secure the hard-drive bracket to the hard drive.
- 4 Place the hard-drive assembly on the palm rest and keyboard assembly and align the screw holes on the hard-drive assembly with the screw holes on the palm rest and keyboard assembly.
- 5 Replace the screws that secure the hard-drive assembly to the palm rest and keyboard assembly.
- 6 Slide the hard-drive cable into the connector on the system board and close the latch to secure the cable.

Post-requisites

- 1 Replace the [battery](#).
- 2 Replace the [base cover](#).
- 3 Replace the [optical drive](#).

Removing the memory modules

 **WARNING:** Before working inside your computer, read the safety information that shipped with your computer and follow the steps in [Before working inside your computer](#). After working inside your computer, follow the instructions in [After working inside your computer](#). For more safety best practices, see the Regulatory Compliance home page at www.dell.com/regulatory_compliance.

Prerequisites

- 1 Remove the [optical drive](#).
- 2 Remove the [base cover](#).
- 3 Remove the [battery](#).

Procedure

- 1 Use your fingertips to carefully spread apart the securing clips on each end of the memory-module slot until the memory module pops up.

2 Slide and remove the memory module from the memory-module slot.

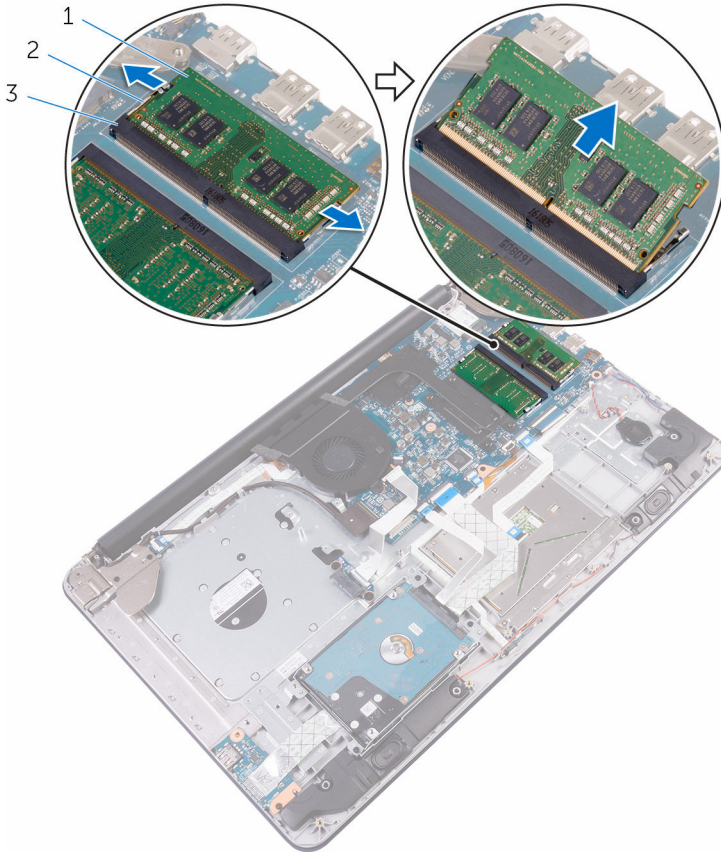

- 1 memory module
- 3 memory-module slot

- 2 securing clips (2)

Replacing the memory modules

 **WARNING:** Before working inside your computer, read the safety information that shipped with your computer and follow the steps in [Before working inside your computer](#). After working inside your computer, follow the instructions in [After working inside your computer](#). For more safety best practices, see the Regulatory Compliance home page at www.dell.com/regulatory_compliance.

Procedure

- 1 Align the notch on the memory module with the tab on the memory-module slot.

- Slide the memory module firmly into the slot at an angle and press the memory module down until it clicks into place.

 **NOTE:** If you do not hear the click, remove the memory module and reinstall it.

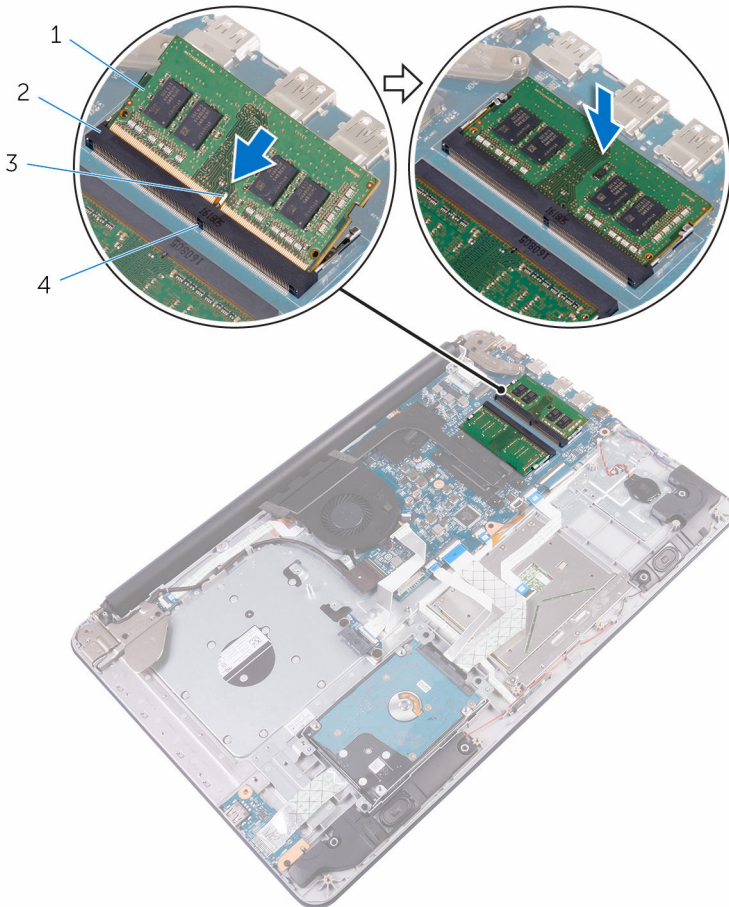

1 memory module
3 notch

2 memory-module slot
4 tab

Post-requisites

- Replace the [battery](#).

- 2 Replace the [base cover](#).
- 3 Replace the [optical drive](#).

Removing the wireless card



WARNING: Before working inside your computer, read the safety information that shipped with your computer and follow the steps in [Before working inside your computer](#). After working inside your computer, follow the instructions in [After working inside your computer](#). For more safety best practices, see the Regulatory Compliance home page at www.dell.com/regulatory_compliance.

Prerequisites

- 1 Remove the [optical drive](#).
- 2 Remove the [base cover](#).
- 3 Remove the [battery](#).

Procedure

- 1 Remove the screw that secures the wireless-card bracket and the wireless card to the system board.
- 2 Lift the wireless card at an angle.
- 3 Slide the wireless-card bracket out of the wireless card.
- 4 Disconnect the antenna cables from the wireless card.

- 5 Slide and remove the wireless card from the wireless-card slot on the system board.

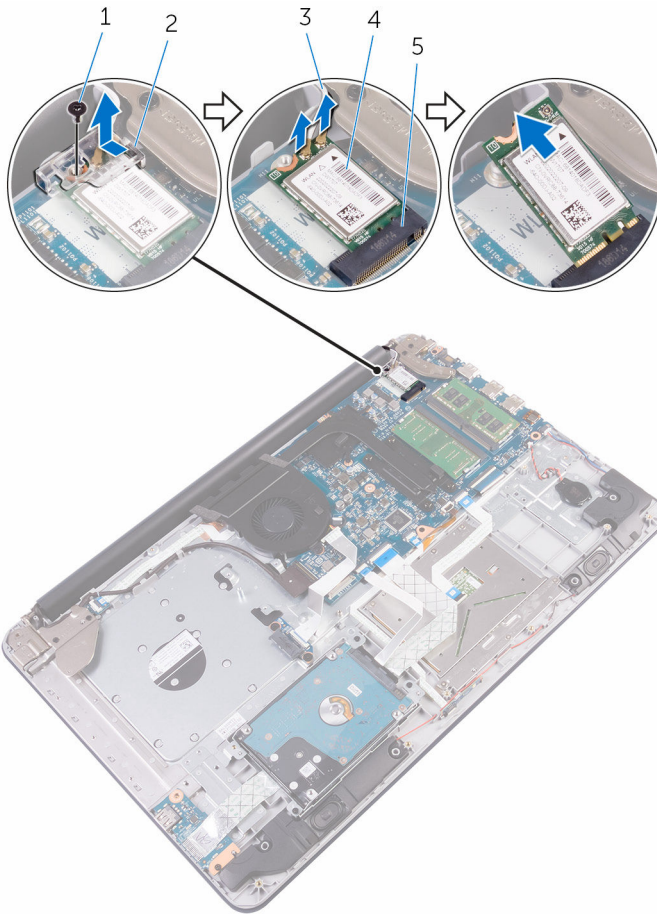

- | | | | |
|---|--------------------|---|-----------------------|
| 1 | M2x3 screw | 2 | wireless-card bracket |
| 3 | antenna cables (2) | 4 | wireless card |
| 5 | wireless-card slot | | |

Replacing the wireless card

 **WARNING:** Before working inside your computer, read the safety information that shipped with your computer and follow the steps in [Before working inside your computer](#). After working inside your computer, follow the instructions in [After working inside your computer](#). For more safety best practices, see the Regulatory Compliance home page at www.dell.com/regulatory_compliance.

Procedure

 **CAUTION:** To avoid damage to the wireless card, do not place any cables under it.

- 1 Align the notch on the wireless card with the tab on the wireless-card slot and slide the card into the slot.
- 2 Align the screw hole on the wireless card with the screw hole on the system board.
- 3 Connect the antenna cables to the wireless card.

The following table provides the antenna-cable color scheme for the wireless card supported by your computer.

Connectors on the wireless card	Antenna-cable color
Main (white triangle)	white
Auxiliary (black triangle)	black

- 4 Align the screw hole on the wireless-card bracket with the screw hole on the wireless card and the system board.

- 5 Replace the screw that secures the wireless-card bracket and the wireless card to the system board.

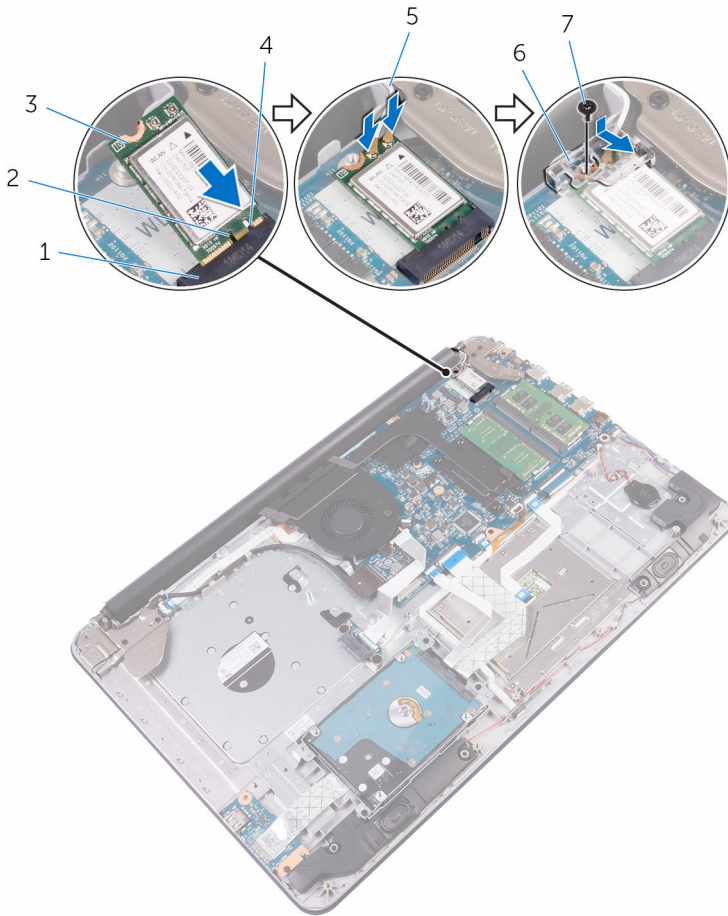



- | | | | |
|---|--------------------|---|-----------------------|
| 1 | wireless-card slot | 2 | notch |
| 3 | wireless card | 4 | tab |
| 5 | antenna cables | 6 | wireless-card bracket |
| 7 | M2x3 screw | | |

Post-requisites

- 1 Replace the [battery](#).
- 2 Replace the [base cover](#).

3 Replace the [optical drive](#).

Removing the coin-cell battery

-  **WARNING:** Before working inside your computer, read the safety information that shipped with your computer and follow the steps in [Before working inside your computer](#). After working inside your computer, follow the instructions in [After working inside your computer](#). For more safety best practices, see the Regulatory Compliance home page at www.dell.com/regulatory_compliance.
-  **CAUTION:** Removing the coin-cell battery resets the BIOS setup program's settings to default. It is recommended that you note the BIOS setup program's settings before removing the coin-cell battery.

Prerequisites

- 1 Remove the [optical drive](#).
- 2 Remove the [base cover](#).
- 3 Remove the [battery](#).

Procedure

- 1 Disconnect the coin-cell battery cable from the system board.

- 2 Peel off the coin-cell battery from the palm rest and keyboard assembly.

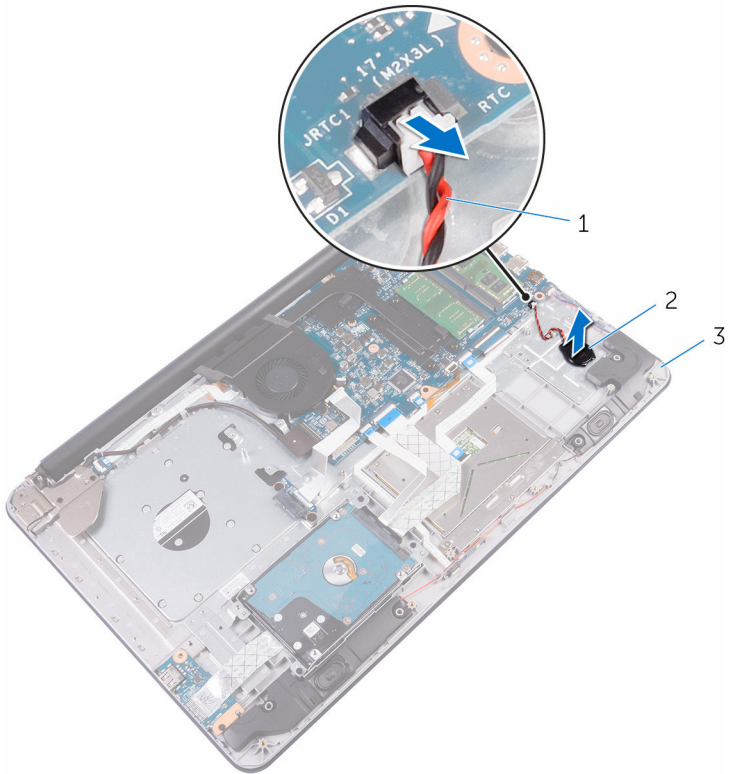

- 1 coin-cell battery cable
3 palm rest and keyboard assembly

- 2 coin-cell battery

Replacing the coin-cell battery



WARNING: Before working inside your computer, read the safety information that shipped with your computer and follow the steps in [Before working inside your computer](#). After working inside your computer, follow the instructions in [After working inside your computer](#). For more safety best practices, see the Regulatory Compliance home page at www.dell.com/regulatory_compliance.

Procedure

- 1 Adhere the coin-cell battery to the palm rest and keyboard assembly.
- 2 Connect the coin-cell battery cable to the system board.

Post-requisites

- 1 Replace the [battery](#).
- 2 Replace the [base cover](#).
- 3 Replace the [optical drive](#).

Removing the touch pad



WARNING: Before working inside your computer, read the safety information that shipped with your computer and follow the steps in [Before working inside your computer](#). After working inside your computer, follow the instructions in [After working inside your computer](#). For more safety best practices, see the Regulatory Compliance home page at www.dell.com/regulatory_compliance.

Prerequisites

- 1 Remove the [optical drive](#).
- 2 Remove the [base cover](#).
- 3 Remove the [battery](#).

Procedure

- 1 Open the latches and disconnect the hard-drive cable and I/O-board cable from the system board.

2 Open the latch and disconnect the touch-pad cable.

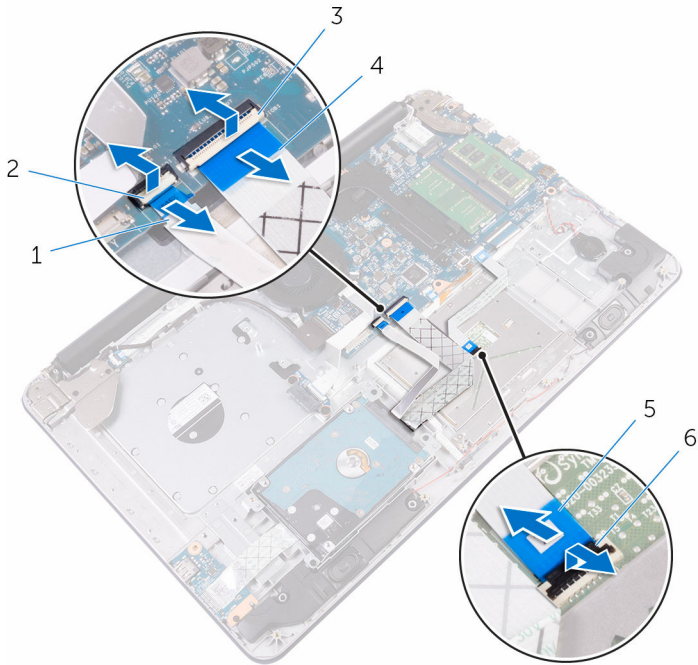

- 1 hard-drive cable
- 3 latch
- 5 touch-pad cable

- 2 latch
- 4 I/O-board cable
- 6 latch

- 3** Remove the screws that secure the touch-pad bracket to the palm rest and keyboard assembly.
- 4** Remove the screws that secure the touch pad to the palm rest and keyboard assembly.
- 5** Gently peel the tape, and lift the touch pad off the palm rest and keyboard assembly.

6

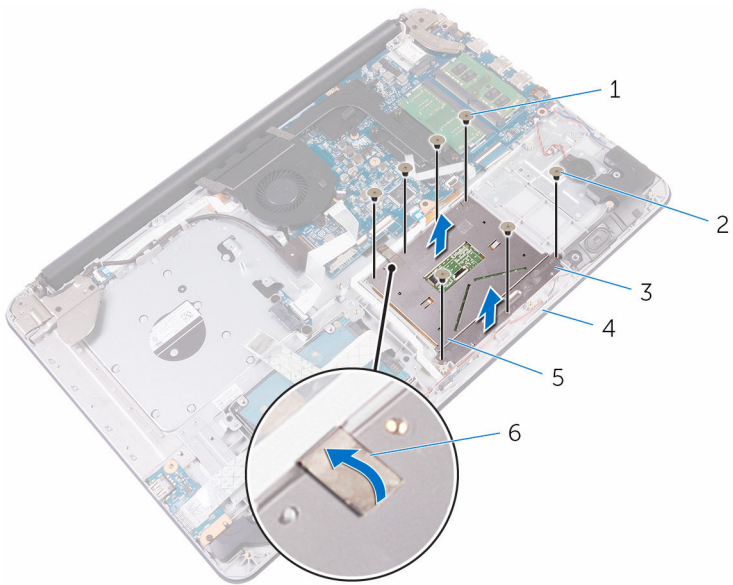

1 M2x2 screws (4)

3 touch-pad bracket

5 touch pad

2 M2x2 screws (3)

4 palm rest and keyboard assembly

6 tape

Replacing the touch pad



WARNING: Before working inside your computer, read the safety information that shipped with your computer and follow the steps in [Before working inside your computer](#). After working inside your computer, follow the instructions in [After working inside your computer](#). For more safety best practices, see the Regulatory Compliance home page at www.dell.com/regulatory_compliance.

Procedure

- 1 Adhere the tape that secures the touch pad to the palm rest and keyboard assembly.
- 2 Align the screw holes on the touch pad with the screw holes on the palm rest and keyboard assembly.
- 3 Replace the screws that secure the touch pad to the palm rest and keyboard assembly.
- 4 Align the screw holes on the touch-pad bracket with the screw holes on the palm rest and keyboard assembly.
- 5 Replace the screws that secure the touch-pad bracket to the palm rest and keyboard assembly.
- 6 Slide the touch-pad cable into the connector and close the latch to secure the cable.
- 7 Slide the hard-drive cable and I/O-board cable to their respective connectors on the system board and close the latches to secure the cables.

Post-requisites

- 1 Replace the [battery](#).
- 2 Replace the [base cover](#).
- 3 Replace the [optical drive](#).

Removing the speakers



WARNING: Before working inside your computer, read the safety information that shipped with your computer and follow the steps in [Before working inside your computer](#). After working inside your computer, follow the instructions in [After working inside your computer](#). For more safety best practices, see the Regulatory Compliance home page at www.dell.com/regulatory_compliance.

Prerequisites

- 1 Remove the [optical drive](#).
- 2 Remove the [base cover](#).
- 3 Remove the [battery](#).

Procedure

- 1 Disconnect the speaker cable from the system board.
- 2 Note the speaker-cable routing on the palm rest and keyboard assembly and release the cable from the routing guides.

- 3 Lift the speakers, along with the speaker cable, off the palm rest and keyboard assembly.

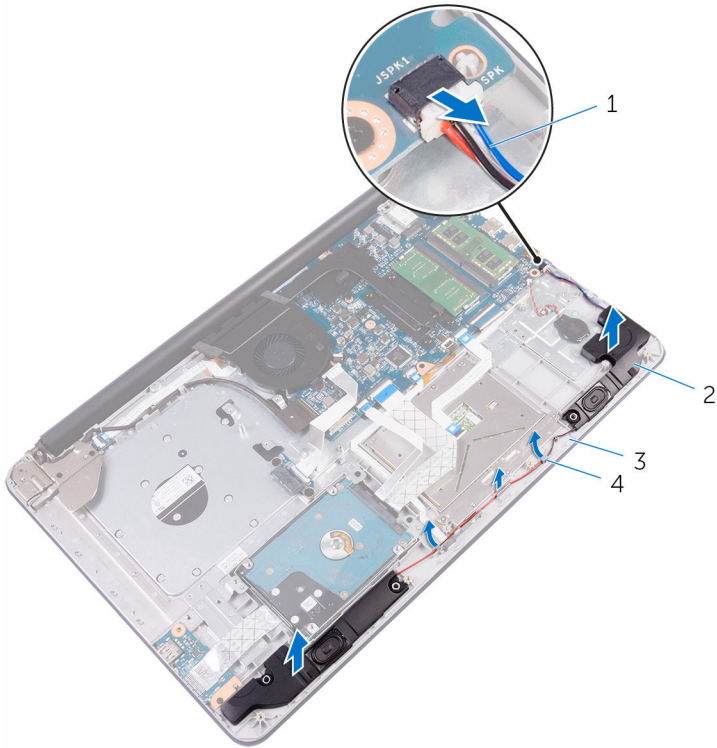

- | | | | |
|---|---------------------------------|---|----------------|
| 1 | speaker cable | 2 | speakers (2) |
| 3 | palm rest and keyboard assembly | 4 | routing guides |

Replacing the speakers



WARNING: Before working inside your computer, read the safety information that shipped with your computer and follow the steps in [Before working inside your computer](#). After working inside your computer, follow the instructions in [After working inside your computer](#). For more safety best practices, see the Regulatory Compliance home page at www.dell.com/regulatory_compliance.

Procedure

- 1 Using the alignment posts, align and place the speakers on the palm rest and keyboard assembly.
- 2 Route the speaker cable through the routing guides on the palm rest and keyboard assembly.
- 3 Connect the speaker cable to the system board.

Post-requisites

- 1 Replace the [battery](#).
- 2 Replace the [base cover](#).
- 3 Replace the [optical drive](#).

Removing the I/O board



WARNING: Before working inside your computer, read the safety information that shipped with your computer and follow the steps in [Before working inside your computer](#). After working inside your computer, follow the instructions in [After working inside your computer](#). For more safety best practices, see the Regulatory Compliance home page at www.dell.com/regulatory_compliance.

Prerequisites

- 1 Remove the [optical drive](#).
- 2 Remove the [base cover](#).
- 3 Remove the [battery](#).
- 4 Remove the [hard drive](#).

Procedure

- 1 Lift the latch and disconnect the I/O-board cable from the system board.
- 2 Peel the I/O-board cable from the palm rest and keyboard assembly.
- 3 Remove the screw that secures the I/O board to the palm rest and keyboard assembly.

- 4 Lift the I/O board off the palm rest and keyboard assembly.

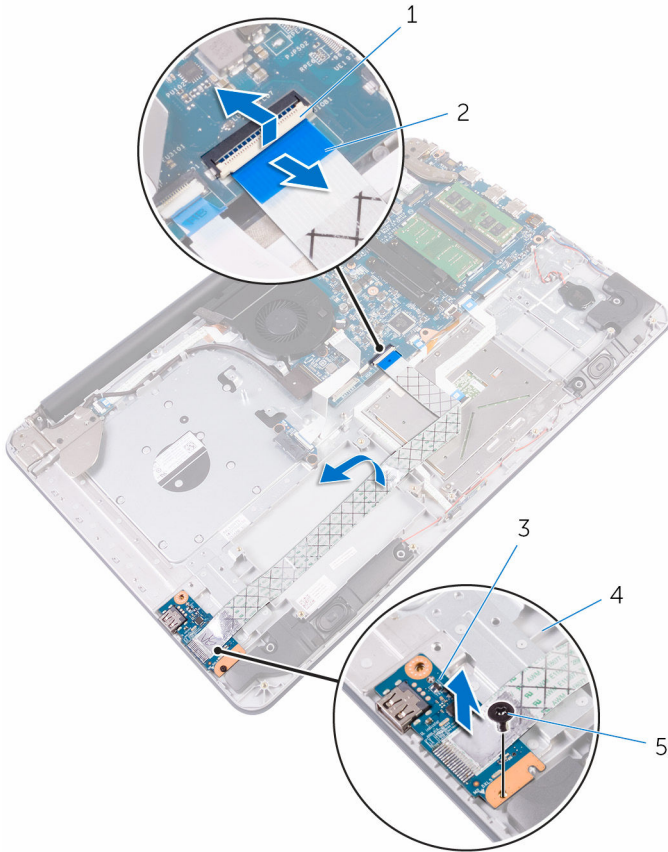

- | | | | |
|---|--------------|---|---------------------------------|
| 1 | latch | 2 | I/O-board cable |
| 3 | I/O board | 4 | palm rest and keyboard assembly |
| 5 | M2.5x5 screw | | |

Replacing the I/O board



WARNING: Before working inside your computer, read the safety information that shipped with your computer and follow the steps in [Before working inside your computer](#). After working inside your computer, follow the instructions in [After working inside your computer](#). For more safety best practices, see the Regulatory Compliance home page at www.dell.com/regulatory_compliance.

Procedure

- 1 Align the screw hole on the I/O board with the screw hole on the palm rest and keyboard assembly.
- 2 Replace the screw that secures the I/O board to the palm rest and keyboard assembly.
- 3 Adhere the I/O-board cable to the palm rest and keyboard assembly.
- 4 Connect the I/O-board cable to the I/O-board connector on the system board and press down the latch to secure the cable.

Post-requisites

- 1 Replace the [hard drive](#).
- 2 Replace the [battery](#).
- 3 Replace the [base cover](#).
- 4 Replace the [optical drive](#).

Removing the status-light board



WARNING: Before working inside your computer, read the safety information that shipped with your computer and follow the steps in [Before working inside your computer](#). After working inside your computer, follow the instructions in [After working inside your computer](#). For more safety best practices, see the Regulatory Compliance home page at www.dell.com/regulatory_compliance.

Prerequisites

- 1 Remove the [optical drive](#).
- 2 Remove the [base cover](#).
- 3 Remove the [battery](#).

Procedure

- 1 Open the latch and disconnect the hard-drive cable from the system board.
- 2 Open the latch and disconnect the I/O-board cable from the system board.
- 3 Disconnect the speaker cable from the system board.

- 4** Release the speaker cable from the routing guides and lift up the right speaker from the palm rest and keyboard assembly.

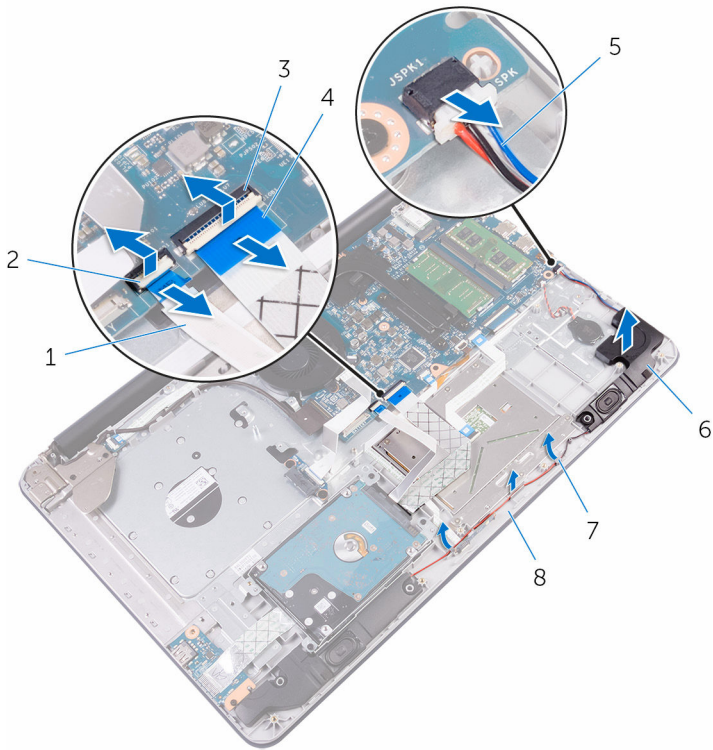

- | | | | |
|---|------------------|---|---------------------------------|
| 1 | hard-drive cable | 2 | latch |
| 3 | latch | 4 | I/O-board cable |
| 5 | speaker cable | 6 | speaker |
| 7 | routing guides | 8 | palm rest and keyboard assembly |

- 5** Open the latch and disconnect the status-light cable from the system board.
- 6** Peel off the status-light board cable from the palm rest and keyboard assembly.

- 7 Release the status-light board from the tab on the palm rest and keyboard assembly.

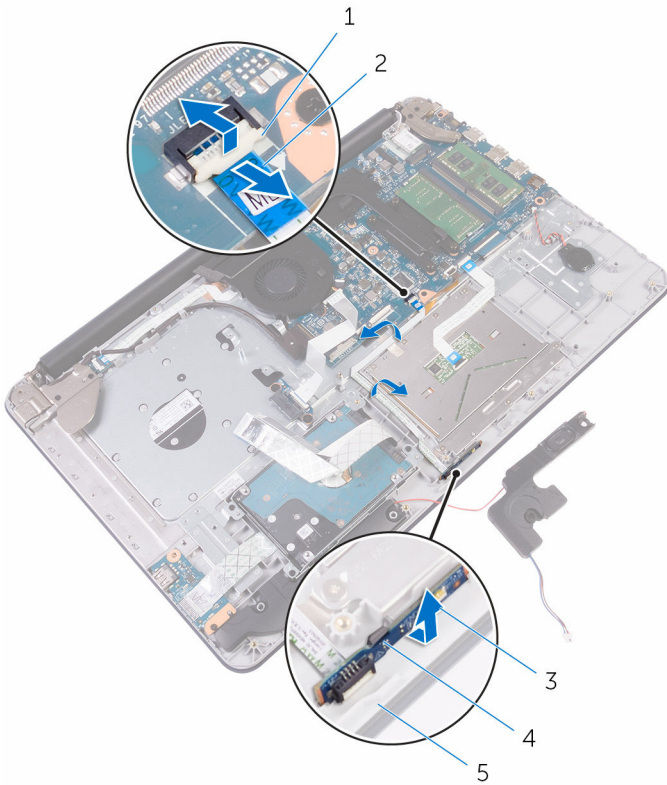

- | | | | |
|---|---------------------------------|---|--------------------------|
| 1 | latch | 2 | status-light board cable |
| 3 | status-light board | 4 | tab |
| 5 | palm rest and keyboard assembly | | |

Replacing the status-light board

 **WARNING:** Before working inside your computer, read the safety information that shipped with your computer and follow the steps in [Before working inside your computer](#). After working inside your computer, follow the instructions in [After working inside your computer](#). For more safety best practices, see the Regulatory Compliance home page at www.dell.com/regulatory_compliance.

Procedure

- 1 Place the status-light board in an angle on the palm rest and keyboard assembly and snap it in place.
- 2 Adhere the status-light board cable to the palm rest and keyboard assembly.
- 3 Slide the status-light board cable into the connector on the system board and close the latch to secure the cable.
- 4 Route the speaker cable through the routing guides and place the speaker on the palm rest and keyboard assembly.
- 5 Connect the speaker cable to the slot on the system board.
- 6 Slide the I/O-board cable into the connector on the system board and close the latch to secure the cable.
- 7 Slide the hard-drive cable into the connector on the system board and close the latch to secure the cable.

Post-requisites

- 1 Replace the [battery](#).
- 2 Replace the [base cover](#).
- 3 Replace the [optical drive](#).

Removing the optical-drive interposer



WARNING: Before working inside your computer, read the safety information that shipped with your computer and follow the steps in [Before working inside your computer](#). After working inside your computer, follow the instructions in [After working inside your computer](#). For more safety best practices, see the Regulatory Compliance home page at www.dell.com/regulatory_compliance.

Prerequisites

- 1 Remove the [optical drive](#).
- 2 Remove the [base cover](#).
- 3 Remove the [battery](#).

Procedure

- 1 Lift the latch and disconnect optical-drive connector board cable from the optical-drive board connector.
- 2 Remove the screws that secure the optical-drive connector board to the palm rest and keyboard assembly.

3 Lift the optical-drive connector board off the palm rest and keyboard assembly.

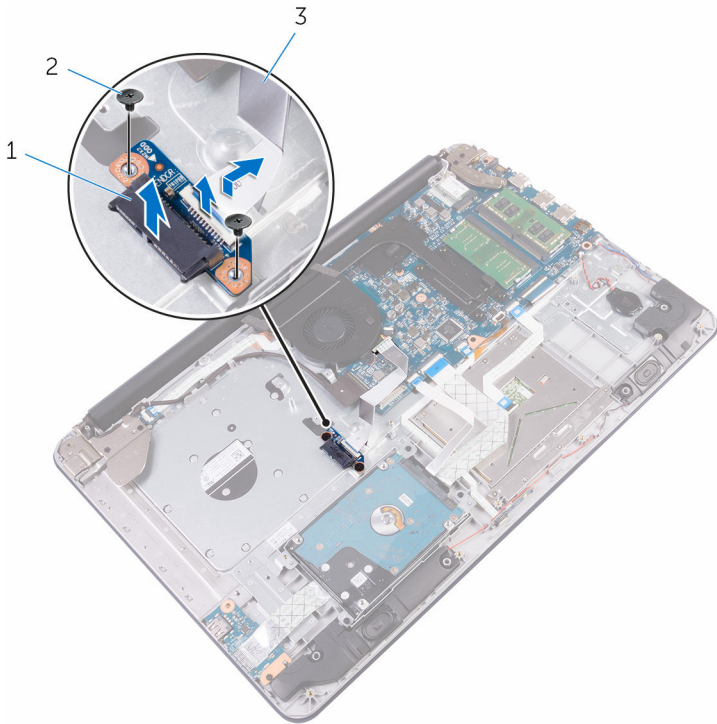

1 optical-drive connector board

2 M2x2 screws (2)

3 latch

4 optical-drive connector board cable

Replacing the optical-drive interposer

 **WARNING:** Before working inside your computer, read the safety information that shipped with your computer and follow the steps in [Before working inside your computer](#). After working inside your computer, follow the instructions in [After working inside your computer](#). For more safety best practices, see the Regulatory Compliance home page at www.dell.com/regulatory_compliance.



Procedure

- 1 Align the screw holes on the optical-drive connector board with the screw holes on the palm rest and keyboard assembly.
- 2 Replace the screws that secure the optical-drive connector board to the palm rest and keyboard assembly.
- 3 Press down on the latch to connect the optical-drive connector board cable to the optical-drive connector board.

Post-requisites

- 1 Replace the [battery](#).
- 2 Replace the [base cover](#).
- 3 Replace the [optical drive](#).

Removing the heat-sink assembly

-  **WARNING:** Before working inside your computer, read the safety information that shipped with your computer and follow the steps in [Before working inside your computer](#). After working inside your computer, follow the instructions in [After working inside your computer](#). For more safety best practices, see the Regulatory Compliance home page at www.dell.com/regulatory_compliance.
-  **WARNING:** The heat sink may become hot during normal operation. Allow sufficient time for the heat sink to cool before you touch it.
-  **CAUTION:** For maximum cooling of the processor, do not touch the heat transfer areas on the heat sink. The oils in your skin can reduce the heat transfer capability of the thermal grease.

Prerequisites

- 1 Remove the [optical drive](#).
- 2 Remove the [base cover](#).
- 3 Remove the [battery](#).

Procedure

- 1 Disconnect the fan cable from the system board.
- 2 In sequential order, as indicated on the heat-sink assembly, loosen the captive screws that secure the heat-sink assembly to the system board.
- 3 Remove the screws that secure the heat-sink assembly to the system board.

4 Lift the heat-sink assembly off the system board.

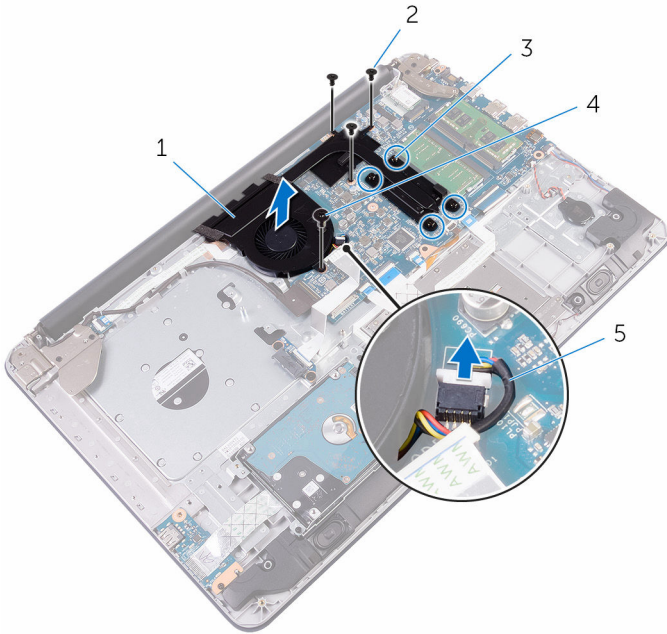



- 1 heat-sink assembly
- 3 captive screws (4)
- 5 fan cable

- 2 M2x3 screws (3)
- 4 M2.5x5 screw

Replacing the heat-sink assembly

 **WARNING:** Before working inside your computer, read the safety information that shipped with your computer and follow the steps in [Before working inside your computer](#). After working inside your computer, follow the instructions in [After working inside your computer](#). For more safety best practices, see the Regulatory Compliance home page at www.dell.com/regulatory_compliance.

 **CAUTION:** Incorrect alignment of the heat sink can damage the system board and processor.

 **NOTE:** The original thermal grease can be reused if the original system board and fan are reinstalled together. If either the system board or the fan is replaced, use the thermal pad provided in the kit to ensure that thermal conductivity is achieved.

Procedure

- 1 Align the screw holes on the heat-sink assembly with the screw holes on the system board.
- 2 Replace the screws that secure the heat-sink assembly to the system board.
- 3 In sequential order, as indicated on the heat-sink assembly, tighten the captive screws that secure the heat-sink assembly to the system board.
- 4 Connect the fan cable to the system board.

Post-requisites

- 1 Replace the [battery](#).
- 2 Replace the [base cover](#).
- 3 Replace the [optical drive](#).

Removing the display assembly



WARNING: Before working inside your computer, read the safety information that shipped with your computer and follow the steps in [Before working inside your computer](#). After working inside your computer, follow the instructions in [After working inside your computer](#). For more safety best practices, see the Regulatory Compliance home page at www.dell.com/regulatory_compliance.

Prerequisites

- 1 Remove the [optical drive](#).
- 2 Remove the [base cover](#).
- 3 Remove the [battery](#).
- 4 Remove the [wireless card](#).

Procedure

- 1 Lift the latch and disconnect the display cable from its connector.
- 2 Peel off the tape that secures the display cable to the palm rest and keyboard assembly.
- 3 Note the display cable routing and remove the cable from its routing guides.

- 4** Remove the screws that secure the display hinges to the palm-rest and keyboard assembly.

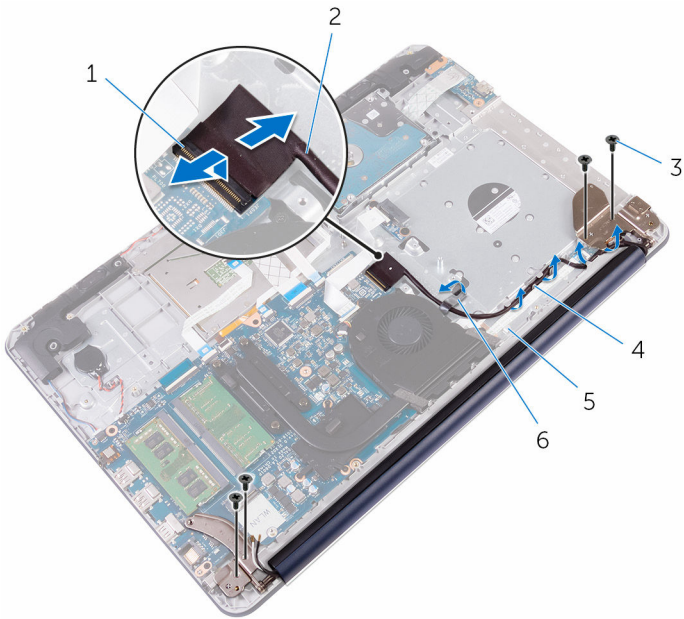

- | | | | |
|---|---------------------------------|---|---------------|
| 1 | latch | 2 | display cable |
| 3 | M2.5x5 screws (4) | 4 | routing guide |
| 5 | palm rest and keyboard assembly | 6 | tape |

- 5** Lift the display hinges from the palm rest and keyboard assembly.

6 Slide and lift the palm rest and keyboard assembly.



1 palm rest and keyboard assembly

2 display hinges (2)

Replacing the display assembly



WARNING: Before working inside your computer, read the safety information that shipped with your computer and follow the steps in [Before working inside your computer](#). After working inside your computer, follow the instructions in [After working inside your computer](#). For more safety best practices, see the Regulatory Compliance home page at www.dell.com/regulatory_compliance.

Procedure

- 1 Slide and place the palm rest and keyboard assembly on the display assembly.
- 2 Using the alignment posts, press the display hinges down on the palm rest and keyboard assembly.
- 3 Align the screw holes on the display hinges with the screw holes on the palm rest and keyboard assembly.
- 4 Replace the screws that secure the display hinges to the palm rest and keyboard assembly.
- 5 Route the display cable through the routing guides on the palm rest and keyboard assembly.
- 6 Adhere the tape that secures the display cable to the palm rest and keyboard assembly.
- 7 Slide the display cable to the connector on the system board and close the latch to secure the cable.

Post-requisites

- 1 Replace the [wireless card](#).
- 2 Replace the [battery](#).
- 3 Replace the [base cover](#).
- 4 Replace the [optical drive](#).

Removing the system board



WARNING: Before working inside your computer, read the safety information that shipped with your computer and follow the steps in [Before working inside your computer](#). After working inside your computer, follow the instructions in [After working inside your computer](#). For more safety best practices, see the Regulatory Compliance home page at www.dell.com/regulatory_compliance.



NOTE: Your computer's Service Tag is stored in the system board. You must enter the Service Tag in the BIOS setup program after you replace the system board.



NOTE: Replacing the system board removes any changes you have made to the BIOS using the BIOS setup program. You must make the appropriate changes again after you replace the system board.



NOTE: Before disconnecting the cables from the system board, note the location of the connectors so that you can reconnect the cables correctly after you replace the system board.

Prerequisites

- 1 Remove the [optical drive](#).
- 2 Remove the [base cover](#).
- 3 Remove the [battery](#).
- 4 Remove the [wireless card](#).
- 5 Remove the [memory modules](#).
- 6 Remove the [heat-sink assembly](#).
- 7 Remove the [display assembly](#).

Procedure

- 1 Lift the connector latches and disconnect the power-button board cable and the optical-drive connector board cable from the system board.

- 2 Lift the connector latches and disconnect the hard-drive cable and the I/O-board cable from the system board.

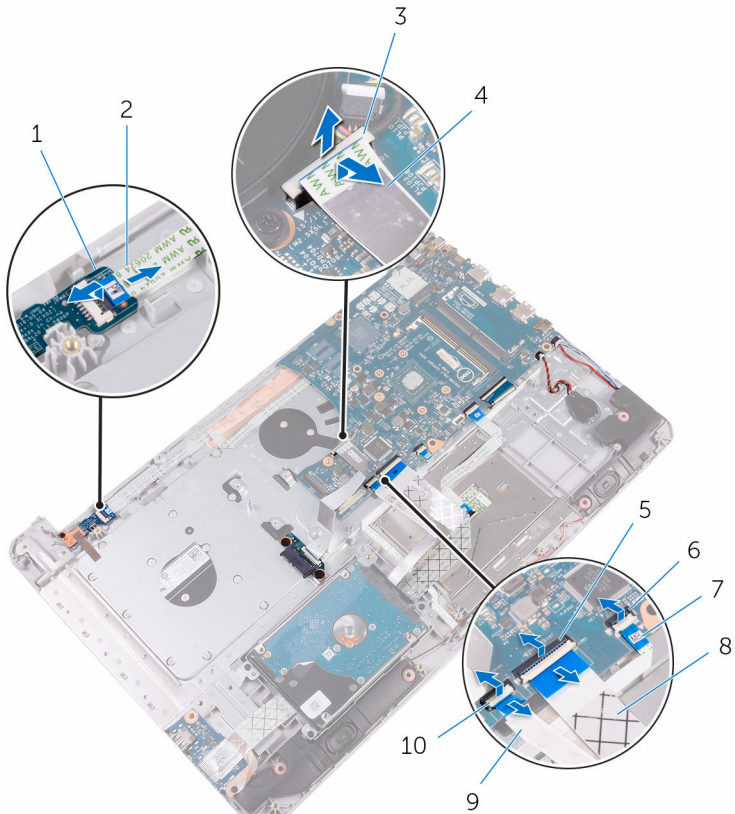

- | | | | |
|---|--------------------------|----|-------------------------------------|
| 1 | latch | 2 | power-button board cable |
| 3 | latch | 4 | optical drive connector-board cable |
| 5 | latch | 6 | latch |
| 7 | status-light board cable | 8 | I/O-board cable |
| 9 | hard-drive cable | 10 | latch |

- 3 Lift the connector latches and disconnect the keyboard-backlight cable and touchpad cable from the system board.
- 4 Lift the connector latch and disconnect the keyboard cable from the system board.

- 5** Disconnect the coin-cell battery cable and speaker cable from the system board.

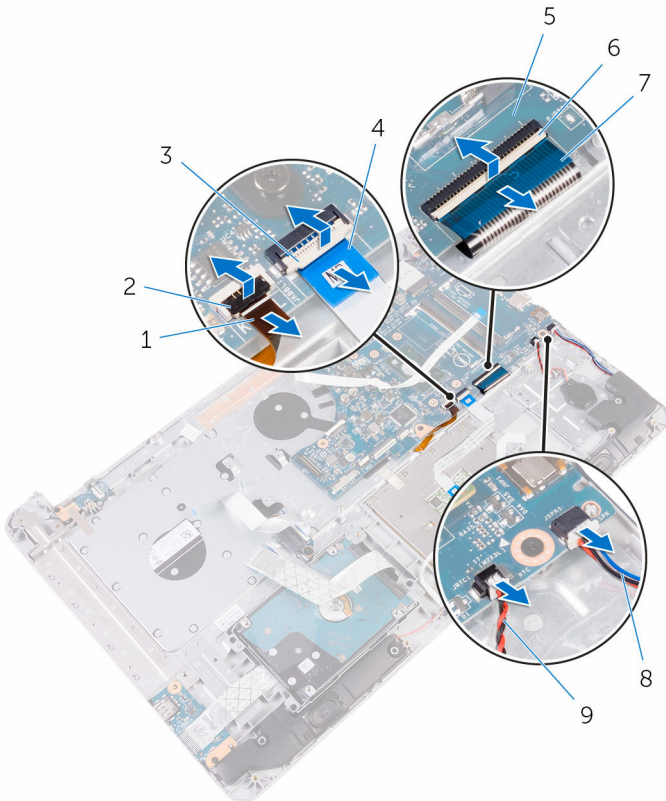

- | | | | |
|---|--------------------------|---|----------------|
| 1 | keyboard backlight cable | 2 | latch |
| 3 | latch | 4 | touchpad cable |
| 5 | system board | 6 | latch |
| 7 | keyboard cable | 8 | speaker cable |
| 9 | coin-cell battery cable | | |

- 6** Remove the screws that secure the system board to the palm rest and keyboard assembly.
- 7** Carefully lift the system board from the inner edge to release the system board from the palm rest and keyboard assembly.

8 Turn the system board over.

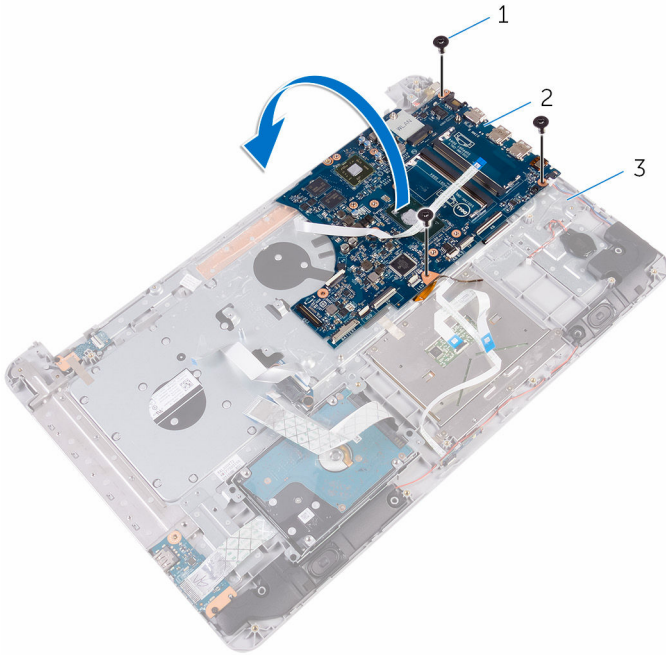

1 M2x3 screws (3)

2 system board

3 palm rest and keyboard
assembly

9 Lift the latch and disconnect the power-button cable from the system board.

10 Disconnect the power-adaptor port cable from the system board.

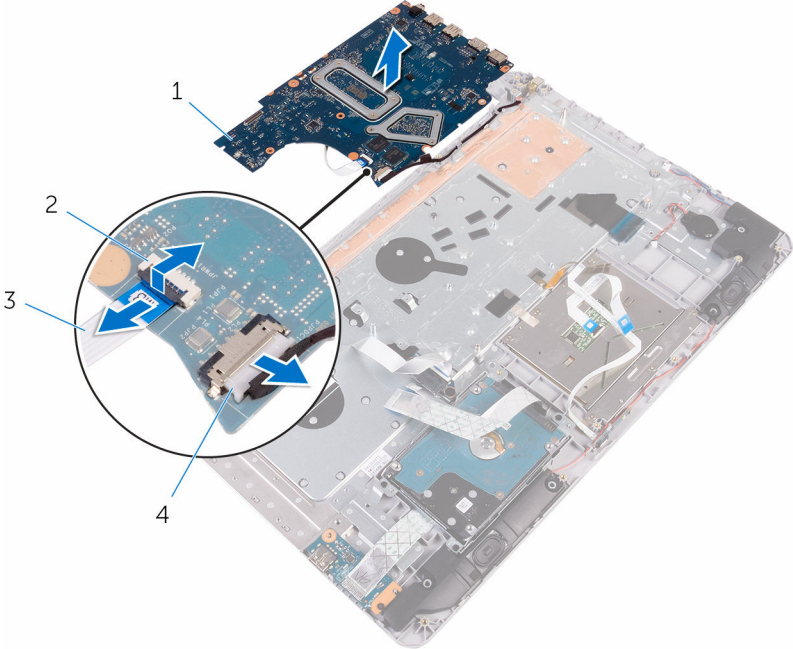

- 1 system board
- 2 latch
- 3 power-button cable
- 4 power-adaptor port cable

Replacing the system board

 **WARNING:** Before working inside your computer, read the safety information that shipped with your computer and follow the steps in [Before working inside your computer](#). After working inside your computer, follow the instructions in [After working inside your computer](#). For more safety best practices, see the Regulatory Compliance home page at www.dell.com/regulatory_compliance.

 **NOTE:** Your computer's Service Tag is stored in the system board. You must enter the Service Tag in the BIOS setup program after you replace the system board.

 **NOTE:** Replacing the system board removes any changes you have made to the BIOS using the BIOS setup program. You must make the appropriate changes again after you replace the system board.

Procedure

 **CAUTION:** To avoid damaging the system board, ensure that no cables are placed under it.

- 1 Connect the power-adaptor port cable to the system board.
- 2 Slide the power-button cable into the connector on system board and press down the latch to secure the cable.
- 3 Turn the system board over.
- 4 Slide the ports on the system board into the slots on the palm rest and keyboard assembly.
- 5 Align the screw hole on the system board with the screw hole on the palm rest and keyboard assembly.
- 6 Replace the screw that secures the system board to the palm rest and keyboard assembly.
- 7 Connect the coin-cell battery cable and speaker cable to the system board.
- 8 Slide the keyboard cable, touchpad cable, keyboard-backlight cable, hard-drive cable, I/O-board cable, power-button board cable and optical-drive connector board cable into the respective connectors and press down the latches to secure the cables.

Post-requisites

- 1 Replace the [display assembly](#).
- 2 Replace the [heat-sink assembly](#).
- 3 Replace the [memory modules](#).
- 4 Replace the [wireless card](#).
- 5 Replace the [battery](#).
- 6 Replace the [base cover](#).
- 7 Replace the [optical drive](#).

Removing the power-button board



WARNING: Before working inside your computer, read the safety information that shipped with your computer and follow the steps in [Before working inside your computer](#). After working inside your computer, follow the instructions in [After working inside your computer](#). For more safety best practices, see the Regulatory Compliance home page at www.dell.com/regulatory_compliance.

Prerequisites

- 1 Remove the [optical drive](#).
- 2 Remove the [base cover](#).
- 3 Remove the [battery](#).
- 4 Remove the [display assembly](#).

Procedure

- 1 Lift the latch and disconnect the power-button board cable from the palm rest and keyboard assembly.
- 2 Remove the screw that secures the power-button board to the palm rest and keyboard assembly.
- 3 Peel off the tape that secures the power-button board to the palm rest and keyboard assembly.

- 4 Lift the power-button board off the palm rest and keyboard assembly.

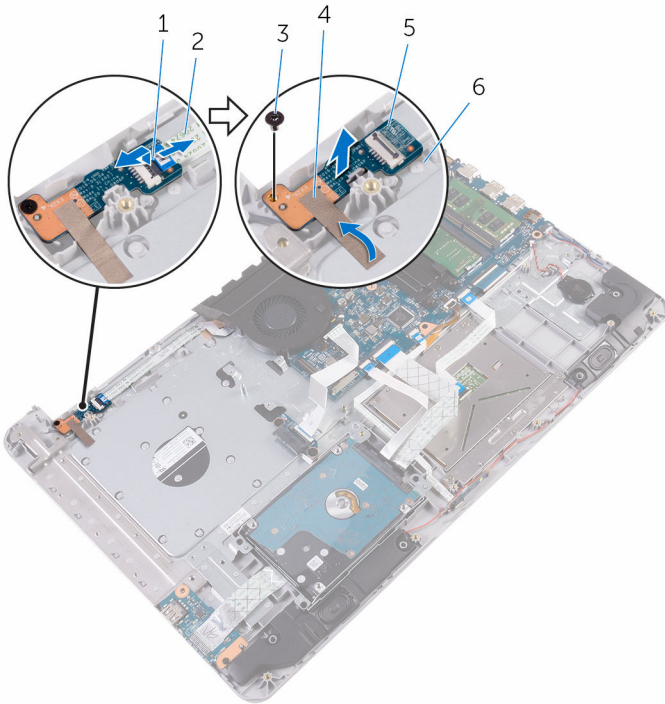

1 latch

3 M2x3 screw

5 power-button board

2 power-button board cable

4 tape

6 palm rest and keyboard assembly

Replacing the power-button board



WARNING: Before working inside your computer, read the safety information that shipped with your computer and follow the steps in [Before working inside your computer](#). After working inside your computer, follow the instructions in [After working inside your computer](#). For more safety best practices, see the Regulatory Compliance home page at www.dell.com/regulatory_compliance.

Procedure

- 1 Place the power-button board on the palm rest and keyboard assembly and align the screw hole on the power-button board with the screw hole on the palm rest and keyboard assembly.
- 2 Adhere the tape that secures the power-button board to the palm rest and keyboard assembly.
- 3 Replace the screw that secures the power-button board to the palm rest and keyboard assembly.
- 4 Slide the power-button cable to the power-button board and close the latch to secure the cable.

Post-requisites

- 1 Replace the [display assembly](#).
- 2 Replace the [battery](#).
- 3 Replace the [base cover](#).
- 4 Replace the [optical drive](#).

Removing the power-adapter port

 **WARNING:** Before working inside your computer, read the safety information that shipped with your computer and follow the steps in [Before working inside your computer](#). After working inside your computer, follow the instructions in [After working inside your computer](#). For more safety best practices, see the Regulatory Compliance home page at www.dell.com/regulatory_compliance.

Prerequisites

- 1 Remove the [optical drive](#).
- 2 Remove the [base cover](#).
- 3 Remove the [battery](#).
- 4 Remove the [wireless card](#).
- 5 Remove the [memory modules](#).
- 6 Remove the [heat-sink assembly](#).
- 7 Remove the [system board](#).

Procedure

- 1 Note the power-adapter port cable routing and remove it from the routing guides on the palm rest and keyboard assembly.
- 2 Remove the screw that secures the power-adapter port to the palm rest and keyboard assembly.

- 3** Lift the power-adapter port, along with its cable, off the palm rest and keyboard assembly.

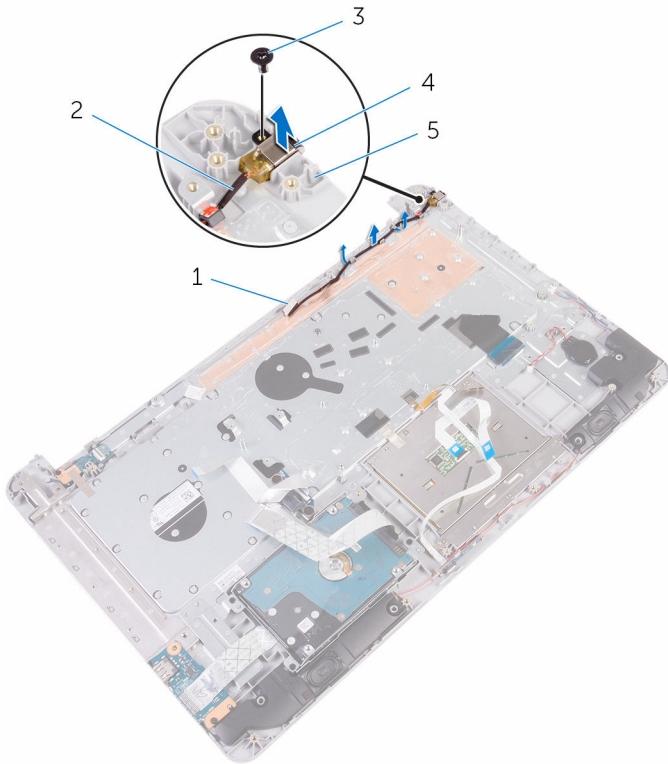

- | | | | |
|---|---------------------------------|---|--------------------------|
| 1 | routing guide | 2 | power-adapter port cable |
| 3 | M2x3 screw | 4 | power-adapter port |
| 5 | palm rest and keyboard assembly | | |

Replacing the power-adapter port

 **WARNING:** Before working inside your computer, read the safety information that shipped with your computer and follow the steps in [Before working inside your computer](#). After working inside your computer, follow the instructions in [After working inside your computer](#). For more safety best practices, see the Regulatory Compliance home page at www.dell.com/regulatory_compliance.

Procedure

- 1 Slide the power-adapter port into the slot on the palm rest and keyboard assembly.
- 2 Replace the screw that secures the power-adapter port to the palm rest and keyboard assembly.
- 3 Route the power-adapter-port cable through the routing guides on the palm rest and keyboard assembly.

Post-requisites

- 1 Replace the [system board](#).
- 2 Replace the [heat-sink assembly](#).
- 3 Replace the [memory modules](#).
- 4 Replace the [wireless card](#).
- 5 Replace the [battery](#).
- 6 Replace the [base cover](#).
- 7 Replace the [optical drive](#).

Removing the palm rest and keyboard assembly

 **WARNING:** Before working inside your computer, read the safety information that shipped with your computer and follow the steps in [Before working inside your computer](#). After working inside your computer, follow the instructions in [After working inside your computer](#). For more safety best practices, see the Regulatory Compliance home page at www.dell.com/regulatory_compliance.

Prerequisites

- 1 Remove the [optical drive](#).
- 2 Remove the [base cover](#).
- 3 Remove the [battery](#).
- 4 Remove the [wireless card](#).
- 5 Remove the [memory modules](#).
- 6 Remove the [hard drive](#).
- 7 Remove the [I/O board](#).
- 8 Remove the [heat-sink assembly](#).
- 9 Remove the [display assembly](#).
- 10 Remove the [power-adaptor port](#).
- 11 Remove the [power-button board](#).
- 12 Remove the [speakers](#).
- 13 Remove the [touch pad](#).
- 14 Remove the [coin-cell battery](#).
- 15 Remove the [system board](#).
- 16 Remove the [status-light board](#).
- 17 Remove the [optical-drive interposer](#).

Procedure

After performing all the prerequisites, we are left with the palm rest and keyboard assembly.

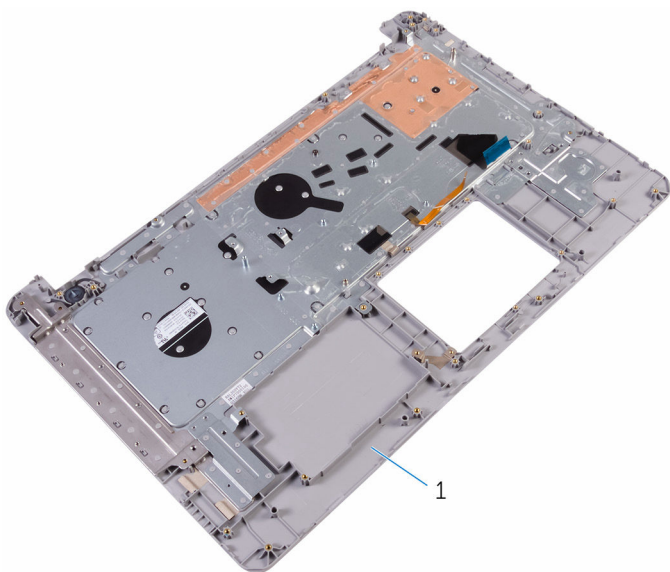

1 palm rest and keyboard assembly

Replacing the palm rest and keyboard assembly

 **WARNING:** Before working inside your computer, read the safety information that shipped with your computer and follow the steps in [Before working inside your computer](#). After working inside your computer, follow the instructions in [After working inside your computer](#). For more safety best practices, see the Regulatory Compliance home page at www.dell.com/regulatory_compliance.

Procedure

Place the palm rest and keyboard assembly on a flat surface.

Post-requisites

- 1 Replace the [optical-drive interposer](#).
- 2 Replace the [status-light board](#).
- 3 Replace the [system board](#).
- 4 Replace the [coin-cell battery](#).
- 5 Replace the [touch pad](#).
- 6 Replace the [speakers](#).
- 7 Replace the [power-button board](#).
- 8 Replace the [power-adaptor port](#).
- 9 Replace the [display assembly](#).
- 10 Replace the [heat-sink assembly](#).
- 11 Replace the [I/O board](#).
- 12 Replace the [hard drive](#).
- 13 Replace the [memory modules](#).
- 14 Replace the [wireless card](#).
- 15 Replace the [battery](#).
- 16 Replace the [base cover](#).
- 17 Replace the [optical drive](#).

Removing the display bezel



WARNING: Before working inside your computer, read the safety information that shipped with your computer and follow the steps in [Before working inside your computer](#). After working inside your computer, follow the instructions in [After working inside your computer](#). For more safety best practices, see the Regulatory Compliance home page at www.dell.com/regulatory_compliance.

Prerequisites



NOTE: These instructions are only applicable for laptop with non-touchscreen display.

- 1 Remove the [optical drive](#).
- 2 Remove the [base cover](#).
- 3 Remove the [battery](#).
- 4 Remove the [wireless card](#).
- 5 Remove the [display assembly](#).

Procedure

- 1 Using a plastic scribe, carefully pry up the display bezel.

2 Remove the display bezel off the display back-cover.

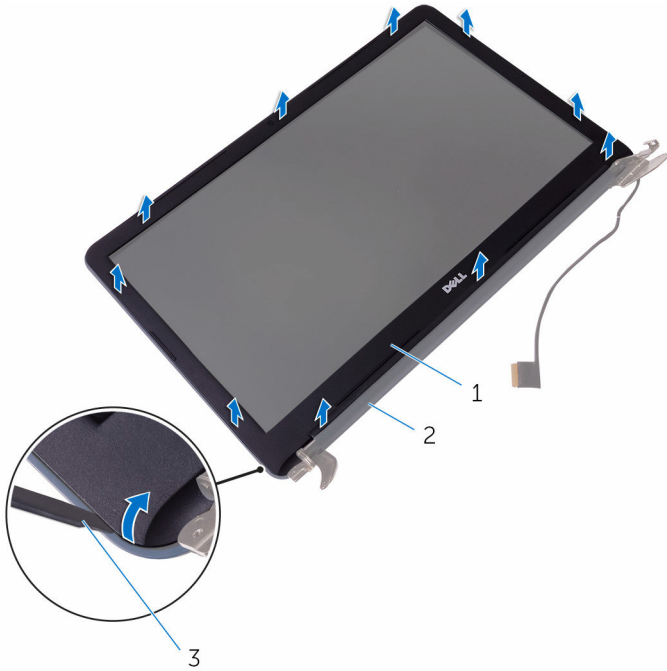

- 1 display bezel
- 3 plastic scribe

- 2 display back-cover

Replacing the display bezel



WARNING: Before working inside your computer, read the safety information that shipped with your computer and follow the steps in [Before working inside your computer](#). After working inside your computer, follow the instructions in [After working inside your computer](#). For more safety best practices, see the Regulatory Compliance home page at www.dell.com/regulatory_compliance.

Procedure



NOTE: These instructions are only applicable for laptops with non-touchscreen display.

Align the display bezel with the display back-cover and gently snap the display bezel into place.

Post-requisites

- 1 Replace the [display assembly](#).
- 2 Replace the [wireless card](#).
- 3 Replace the [battery](#).
- 4 Replace the [base cover](#).
- 5 Replace the [optical drive](#).

Removing the display panel



WARNING: Before working inside your computer, read the safety information that shipped with your computer and follow the steps in [Before working inside your computer](#). After working inside your computer, follow the instructions in [After working inside your computer](#). For more safety best practices, see the Regulatory Compliance home page at www.dell.com/regulatory_compliance.

Prerequisites



NOTE: These instructions are applicable only for laptops with a non-touch screen display.

- 1 Remove the [optical drive](#).
- 2 Remove the [base cover](#).
- 3 Remove the [battery](#).
- 4 Remove the [wireless card](#).
- 5 Remove the [display assembly](#).
- 6 Remove the [display bezel](#).

Procedure

- 1 Remove the screws that secure the display panel to the display back-cover.

- 2** Gently lift the display panel and turn it over.

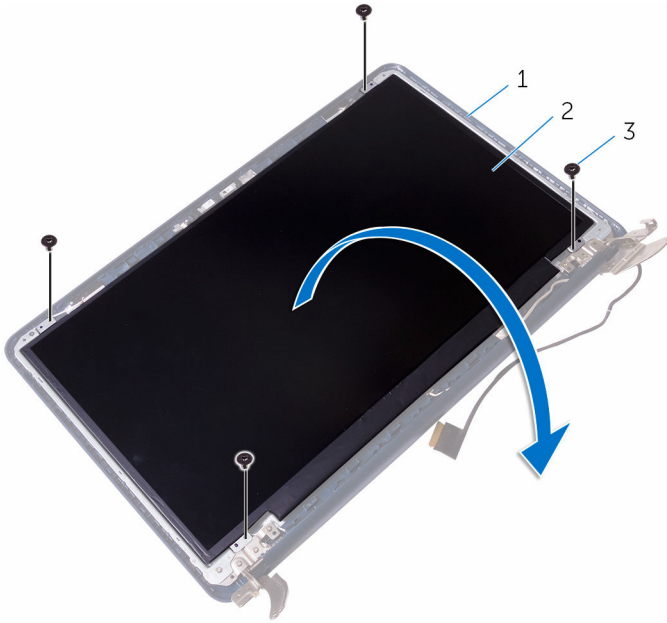

1 display back-cover

2 display panel

3 M2x3 screws (4)

- 3** Gently peel the tape, then lift the latch and disconnect the display cable from the display-cable connector.

4 Lift the display panel off the display back-cover.

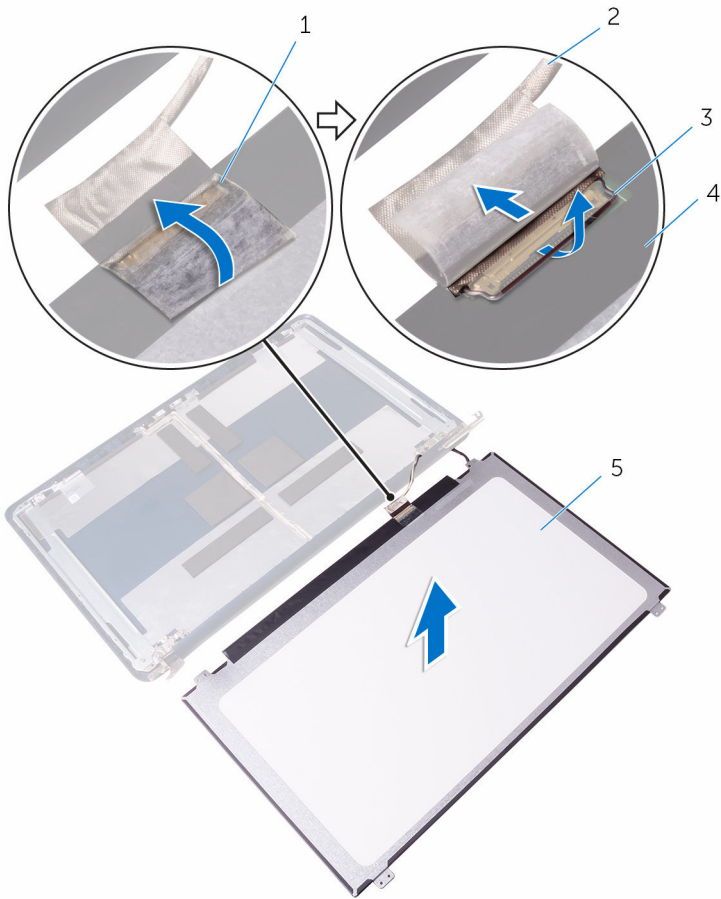

1 tape

3 latch

5 display panel

2 display cable

4 display back-cover

Replacing the display panel



WARNING: Before working inside your computer, read the safety information that shipped with your computer and follow the steps in [Before working inside your computer](#). After working inside your computer, follow the instructions in [After working inside your computer](#). For more safety best practices, see the Regulatory Compliance home page at www.dell.com/regulatory_compliance.

Procedure



NOTE: These instructions are only applicable for laptop with non-touchscreen display.

- 1 Slide the display cable into the display-panel cable connector and press down the latch to secure the cable.
- 2 Adhere the tape over the display-panel cable connector.
- 3 Gently place the display panel on the display back-cover and align the screw holes on the display panel with the screw holes on the display back-cover.
- 4 Replace the screws that secure the display panel to the display back-cover.

Post-requisites

- 1 Replace the [display bezel](#).
- 2 Replace the [display assembly](#).
- 3 Replace the [wireless card](#).
- 4 Replace the [battery](#).
- 5 Replace the [base cover](#).
- 6 Replace the [optical drive](#).

Removing the display hinges



WARNING: Before working inside your computer, read the safety information that shipped with your computer and follow the steps in [Before working inside your computer](#). After working inside your computer, follow the instructions in [After working inside your computer](#). For more safety best practices, see the Regulatory Compliance home page at www.dell.com/regulatory_compliance.

Prerequisites



NOTE: These instructions are applicable only for laptops with a non-touchscreen display.

- 1 Remove the [optical drive](#).
- 2 Remove the [base cover](#).
- 3 Remove the [battery](#).
- 4 Remove the [wireless card](#).
- 5 Remove the [display assembly](#).
- 6 Remove the [display bezel](#).
- 7 Remove the [display panel](#).

Procedure

- 1 Remove the screws that secure the display hinges to the display panel.

2 Lift the display hinges off the display panel.

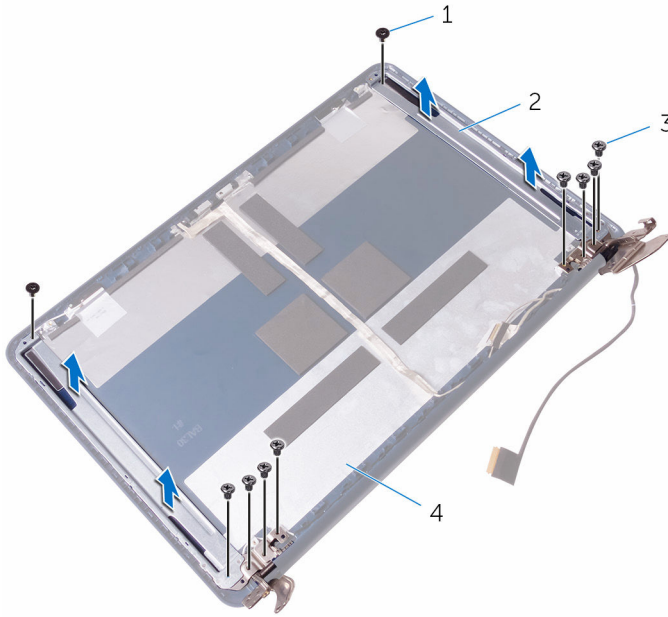

1 M2x3 screws (2)

2 display hinges (2)

3 M2.5x4 screws (8)

4 display panel

Replacing the display hinges



WARNING: Before working inside your computer, read the safety information that shipped with your computer and follow the steps in [Before working inside your computer](#). After working inside your computer, follow the instructions in [After working inside your computer](#). For more safety best practices, see the Regulatory Compliance home page at www.dell.com/regulatory_compliance.

Procedure



NOTE: These instructions are only applicable for laptop with non-touchscreen display.

- 1 Align the screw holes on the display hinges with the screw holes on the display panel.
- 2 Replace the screws that secure the display hinges to the display panel.

Post-requisites

- 1 Replace the [display panel](#).
- 2 Replace the [display bezel](#).
- 3 Replace the [display assembly](#).
- 4 Replace the [wireless card](#).
- 5 Replace the [battery](#).
- 6 Replace the [base cover](#).
- 7 Replace the [optical drive](#).

Removing the camera

 **WARNING:** Before working inside your computer, read the safety information that shipped with your computer and follow the steps in [Before working inside your computer](#). After working inside your computer, follow the instructions in [After working inside your computer](#). For more safety best practices, see the Regulatory Compliance home page at www.dell.com/regulatory_compliance.

Prerequisites

 **NOTE:** These instructions are applicable only for laptops with a non-touchscreen display.

- 1 Remove the [optical drive](#).
- 2 Remove the [base cover](#).
- 3 Remove the [battery](#).
- 4 Remove the [wireless card](#).
- 5 Remove the [display assembly](#).
- 6 Remove the [display bezel](#).

Procedure

- 1 Disconnect the camera cable from the camera module.

2 Using a plastic scribe, gently pry the camera off the display back-cover.

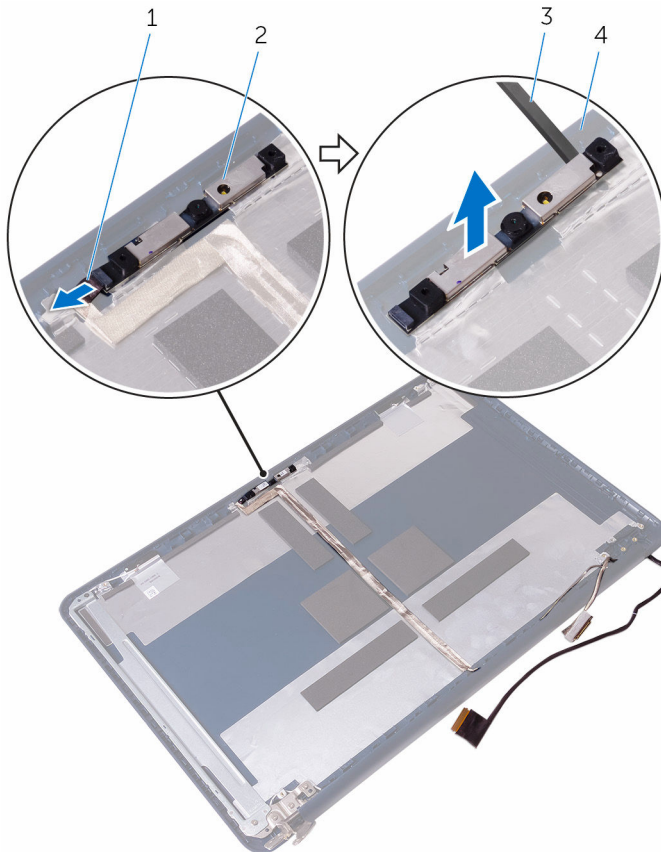

1 camera cable

2 camera

3 plastic scribe

4 display back-cover

Replacing the camera



WARNING: Before working inside your computer, read the safety information that shipped with your computer and follow the steps in [Before working inside your computer](#). After working inside your computer, follow the instructions in [After working inside your computer](#). For more safety best practices, see the Regulatory Compliance home page at www.dell.com/regulatory_compliance.

Procedure



NOTE: These instructions are only applicable for laptop with non-touchscreen display.

- 1 Using the alignment post, adhere the camera to the display back-cover.
- 2 Connect the camera cable to the camera connector.

Post-requisites

- 1 Replace the [display bezel](#).
- 2 Replace the [display assembly](#).
- 3 Replace the [wireless card](#).
- 4 Replace the [battery](#).
- 5 Replace the [base cover](#).
- 6 Replace the [optical drive](#).

Removing the display cable

 **WARNING:** Before working inside your computer, read the safety information that shipped with your computer and follow the steps in [Before working inside your computer](#). After working inside your computer, follow the instructions in [After working inside your computer](#). For more safety best practices, see the Regulatory Compliance home page at www.dell.com/regulatory_compliance.

Prerequisites

 **NOTE:** This chapter is applicable only for laptops with a non-touchscreen display.

- 1 Remove the [optical drive](#).
- 2 Remove the [base cover](#).
- 3 Remove the [battery](#).
- 4 Remove the [wireless card](#).
- 5 Remove the [display assembly](#).
- 6 Remove the [display bezel](#).
- 7 Remove the [display panel](#).

Procedure

- 1 Remove the screws that secure the right display hinges to the display panel.

- 2** Lift the display hinges off the display panel.

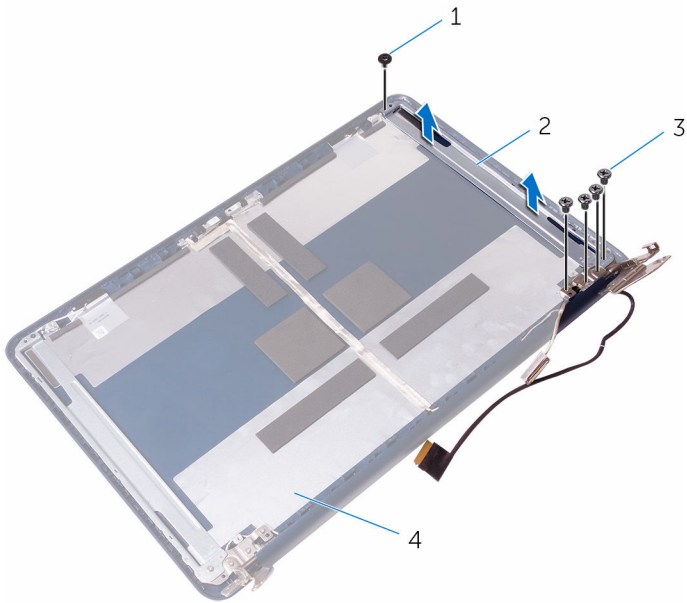

1 M2x3 screw

2 display hinge

3 M2.5x4 screws (4)

4 display back-cover

- 3** Disconnect the camera cable from the camera module.
4 Peel off the camera cable from the display back-cover.

- 5 Note the display cable routing and remove the display cable from the routing guides on the display back-cover.

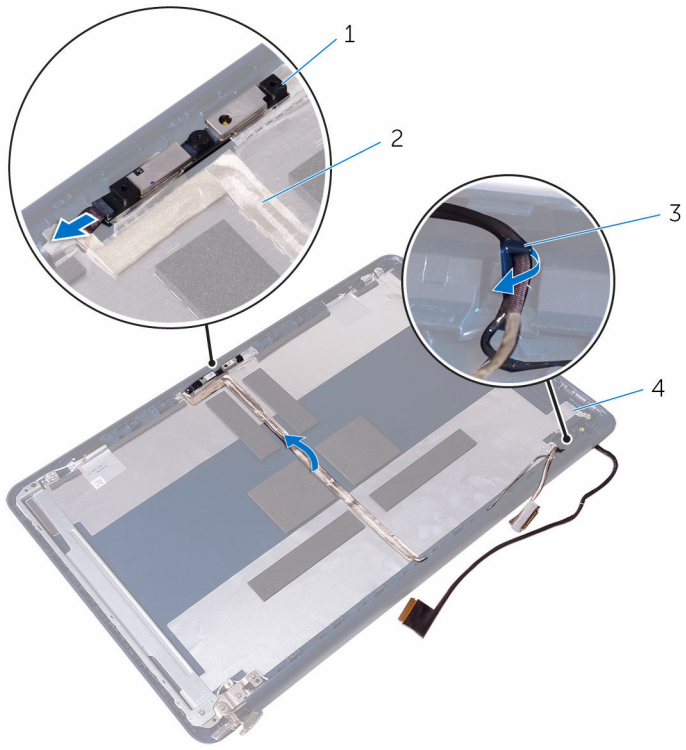

- | | | | |
|---|----------------|---|--------------------|
| 1 | camera | 2 | camera cable |
| 3 | routing guides | 4 | display back-cover |

Replacing the display cable



WARNING: Before working inside your computer, read the safety information that shipped with your computer and follow the steps in [Before working inside your computer](#). After working inside your computer, follow the instructions in [After working inside your computer](#). For more safety best practices, see the Regulatory Compliance home page at www.dell.com/regulatory_compliance.

Procedure

- 1 Route the display cable through the routing guides on the display back-cover.
- 2 Adhere the camera cable to the display back-cover.
- 3 Connect the camera cable to the camera module.
- 4 Align the screw holes on the right display hinges with the screw holes on the display panel.
- 5 Replace the screws that secure the display hinges to the display panel.

Post-requisites

- 1 Replace the [display panel](#).
- 2 Replace the [display bezel](#).
- 3 Replace the [display assembly](#).
- 4 Replace the [wireless card](#).
- 5 Replace the [battery](#).
- 6 Replace the [base cover](#).
- 7 Replace the [optical drive](#).

Removing the display back-cover and antenna assembly

 **WARNING:** Before working inside your computer, read the safety information that shipped with your computer and follow the steps in [Before working inside your computer](#). After working inside your computer, follow the instructions in [After working inside your computer](#). For more safety best practices, see the Regulatory Compliance home page at www.dell.com/regulatory_compliance.

Prerequisites

 **NOTE:** These instruction are applicable only for laptops with a non-touchscreen display.

- 1 Remove the [optical drive](#).
- 2 Remove the [base cover](#).
- 3 Remove the [battery](#).
- 4 Remove the [wireless card](#).
- 5 Remove the [display assembly](#).
- 6 Remove the [display bezel](#).
- 7 Remove the [display panel](#).
- 8 Remove the [display hinges](#).
- 9 Remove the [camera](#).
- 10 Remove the [display cable](#).

Procedure

After performing all the prerequisites, we are left with the display back-cover and antenna assembly.

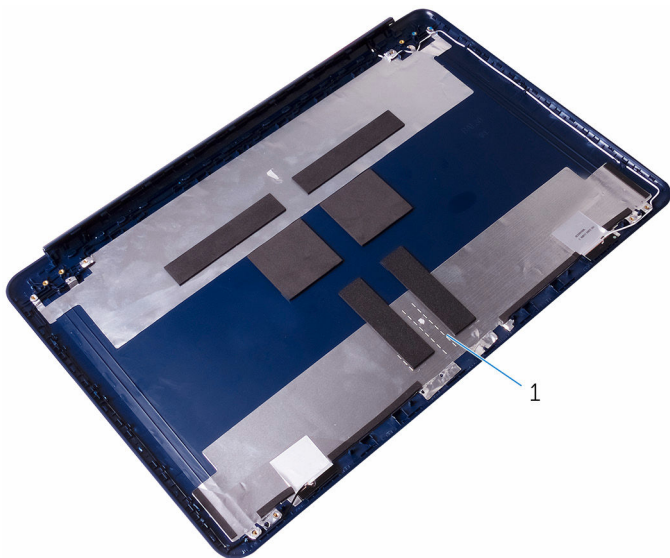

- 1 display back-cover and antenna assembly

Replacing the display back-cover and antenna assembly

 **WARNING:** Before working inside your computer, read the safety information that shipped with your computer and follow the steps in [Before working inside your computer](#). After working inside your computer, follow the instructions in [After working inside your computer](#). For more safety best practices, see the Regulatory Compliance home page at www.dell.com/regulatory_compliance.

Procedure

Place the display back-cover and antenna assembly on a flat surface.

Post-requisites

- 1 Replace the [display cable](#).
- 2 Replace the [camera](#).
- 3 Replace the [display hinges](#).
- 4 Replace the [display panel](#).
- 5 Replace the [display bezel](#).
- 6 Replace the [display assembly](#).
- 7 Replace the [wireless card](#).
- 8 Replace the [battery](#).
- 9 Replace the [base cover](#).
- 10 Replace the [optical drive](#).

Flashing the BIOS

You may need to flash (update) the BIOS when an update is available or when you replace the system board. To flash the BIOS:

- 1 Turn on your computer.
- 2 Go to www.dell.com/support.
- 3 Click **Product support**, enter the Service Tag of your computer, and then click **Submit**.



NOTE: If you do not have the Service Tag, use the auto-detect feature or manually browse for your computer model.

- 4 Click **Drivers & downloads** → **Find it myself**.
- 5 Select the operating system installed on your computer.
- 6 Scroll down the page and expand **BIOS**.
- 7 Click **Download** to download the latest version of the BIOS for your computer.
- 8 After the download is complete, navigate to the folder where you saved the BIOS update file.
- 9 Double-click the BIOS update file icon and follow the instructions on the screen.

System diagnostic lights

Power and battery-status light/ hard-drive activity light

Indicates the battery-charge status or the hard-drive activity.

 **NOTE:** Press Fn+H to toggle this light between power and battery-status light and hard-drive activity light.

Hard-drive activity light

Turns on when the computer reads from or writes to the hard drive.

Power and battery-status light

Indicates the power and battery-charge status.

Solid white – Power adapter is connected and the battery has more than 5 percent charge.

Amber – Computer is running on battery and the battery has less than 5 percent charge.

Off

- Power adapter is connected and the battery is fully charged.
- Computer is running on battery and the battery has more than 5 percent charge.
- Computer is in sleep state, hibernation, or turned off.

The power and battery-status light blinks amber along with beep codes indicating failures.

For example, the power and battery-status light blinks amber two times followed by a pause, and then blinks white three times followed by a pause. This 2,3 pattern continues until the computer is turned off indicating no memory or RAM is detected.

The following table shows the different power and battery-status light patterns, associated problems, and suggested solutions.

Light Pattern	Problem description	Suggested solution
2,1	CPU failure	Replace the system board.
2,2	System board: BIOS and ROM failure	Flash latest BIOS version. If problem persists, replace the system board.
2,3	No memory or RAM detected	Confirm that the memory module is installed properly. If

Light Pattern	Problem description	Suggested solution
		problem persists, replace the memory module.
2,4	Memory or RAM failure	Replace the memory module.
2,5	Invalid memory installed	Replace the memory module.
2,6	System board or chipset error	Replace the system board.
2,7	LCD failure	Replace the LCD.
3,1	CMOS battery failure	Replace the CMOS battery.
3,2	PCI or video card or chip failure	Replace the System board.
3,3	Recovery image not found	Reimage the system.
3,4	Recovery image found but invalid	Reimage the system.

The computer may emit a series of beeps during start-up if the errors or problems cannot be displayed. The repetitive beep codes help the user troubleshoot problems with the computer.

Camera status light-

Indicates whether the camera is in use.

- Solid white – Camera is in use.
- Off – Camera is not in use.

Caps Lock status light-

Indicates whether Caps Lock is enabled or disabled.

- Solid white – Caps Lock enabled.
- Off – Caps Lock disabled.

Getting help and contacting Dell

Self-help resources

You can get information and help on Dell products and services using these self-help resources:

Information about Dell products and services www.dell.com

Windows 8.1 and Windows 10

Dell Help & Support app



Windows 10

Get started app



Windows 8.1

Help + Tips app



Accessing help in Windows 8, Windows 8.1, and Windows 10

In Windows search, type **Help and Support**, and press Enter.

Accessing help in Windows 7

Click **Start** → **Help and Support**.

Online help for operating system

www.dell.com/support/windows

www.dell.com/support/linux

Troubleshooting information, user manuals, setup instructions, product specifications, technical help blogs, drivers, software updates, and so on.

www.dell.com/support

Learn about your operating system, setting up and using your computer, data backup, diagnostics, and so on.

See *Me and My Dell* at

www.dell.com/support/manuals.

Contacting Dell

To contact Dell for sales, technical support, or customer service issues, see www.dell.com/contactdell.



NOTE: Availability varies by country and product, and some services may not be available in your country.



NOTE: If you do not have an active internet connection, you can find contact information on your purchase invoice, packing slip, bill, or Dell product catalog.