

WASHING MACHINE

LAVABIANCHERIA

LAVE-LIGE

جهاز الغسالة

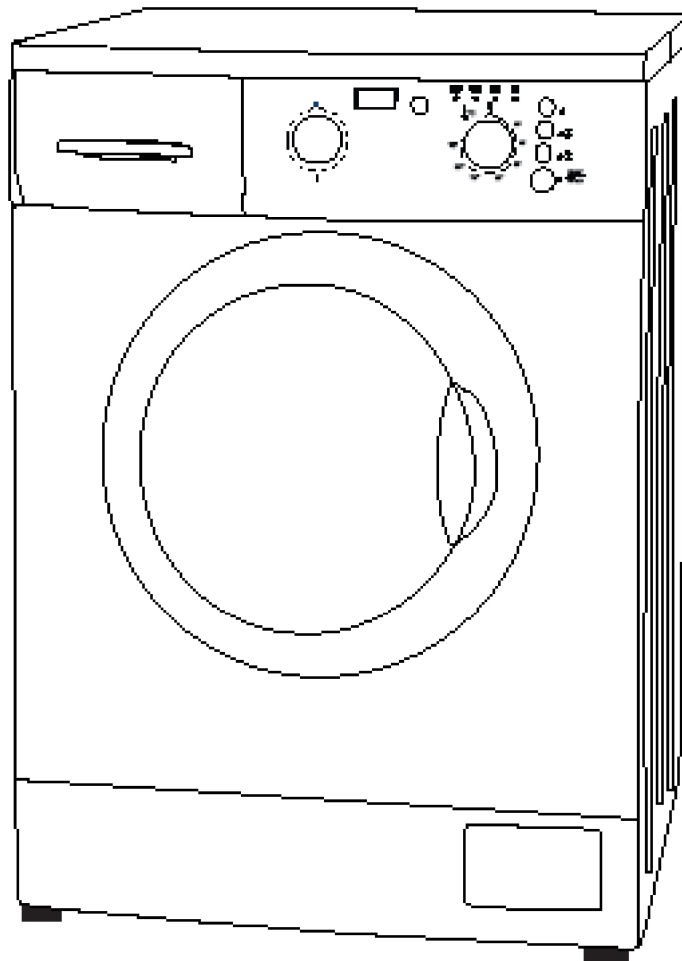

INSTRUCTION MANUAL

MANUALE D'USO

INSTRUCTION POUR L'UTILISATION

دليل الأستعمال و التركيب

Dear Customer,

Firstly, many thanks for your preference in the purchasing of an original Italian product. The product is made in ITALY with the finest materials, comply with RoHs and REACH regulations with a particular focus on human health and the environment.

Fundamental issues such as quality and safety are supported by strict controls on our products, which are certified according international standards - EN 60456:2011, EN 60335:2009, EN 62233:2010: EN 61770:2009 and, EN ISO3741: 2010 by excellent certifying institute VDE - IMQ.

EN

This manual contains instructions for use, maintenance and warranty.

Before using the machine, carefully read this manual. It contains important instructions for safety, use and maintenance of the washing machine. In this way self injury and damage to the machine is avoided.

YOUR CONTRIBUTION TO ENVIRONMENTAL PROTECTION

DISPOSAL OF PACKAGING

The packaging has the purpose to protect appliance from damage that might occur during the transportation. The materials used for packaging are recyclable, so selected on the basis of respect for the environment and ease of disposal with aim of material reintegration to the production cycles. This mechanism allows on one hand to reduce the volume of waste, while the other it makes possible for a more rational usage of nonrenewable resources.

Disposal of waste electrical and electronic equipment (WEEE)

In pursuant to the legislative Decree of July 25, 2005, No. 151 in implementation of Directives 2002/95/EC, 2002/96/EC and 2003/108/EC on the disposal of electrical and electronic waste: the crossed waste bin symbol indicates that the at end of the product life span, it must be disposed separately from other waste.



Users must dispose of the appliance in question at suitable recycling centres for electronic and electrical waste or take it to the dealer when buying a new equivalent appliance, on a one to one bases.

The adequate differential collection for the subsequent forwarding of recycling, treatment and environmentally compatible disposal helps to prevent negative impact on the environment and health. It promotes the recycling of materials from the appliance.

The manufacturer Ltd has always been careful to develop technologies and products which are environmentally friendly. It is also constantly engaged in investments in the field of ecology.

Improper disposal of the product by the user involves the application of administrative penalties provided by law.

INDEX

Index	5	Eco-design reference	17
Safety instructions and warnings	6	Fabric care symbols	17
Description of machine	8	Precautions and advice	18
Installation	9	Washing recommendations.....	18
General information.....	9	Selection of laundry.....	18
Removal of transportation locking screws.....	9	Door gasket.....	19
Positioning of washing.....	9	Door closure.....	19
Installation under a work plain.....	10	Detergent and softener dosage.....	19
Water supply connection.....	10	Liquid or powdered detergent partition plate.....	19
Water drainage.....	11	Detergent powder.....	20
Power supply connection.....	11	Liquid detergent.....	20
Control panel	13	Softener.....	21
Description of commands	13	Detergent doses.....	21
Programme selection knob.....	13	Starting washing programme.....	21
Temperature regulating knob.....	13	Starting washing.....	21
Spin reduction E3L MODEL.....	13	Pausing washing.....	21
Spin regulation E3D MODEL.....	13	Loading laundry into the drum.....	21
Extra rinse and rinse hold.....	13	Maintenance	22
Prewash and soak.....	14	Cabinet.....	22
Start/pause.....	14	Detergent drawer.....	22
Delayed start and child safety E3D model only.....	14	Cleaning drain pump filter.....	22
Door lock led.....	14	Emptying procedure.....	22
First use.....	14	Possible remedies	24
Washing programmes duration and options	15	Spare parts and service	26

EN

SAFETY INSTRUCTIONS AND WARNINGS

This washing machine complies with current safety standards. However, improper use can cause damage to persons and/or property.

Before using the machine for the first time, carefully read this manual. It contains important instructions for safety, usage and maintenance of the washing machine. In this way self injury and damage to the machine is avoided.

Keep the instruction manual and also pass it onto any other users.

INTENDED USE

Use the washing machine only for domestic purpose and only for washing clothes which the producer claimed on the label suitable for washing in water. Any other usage may be dangerous. The manufacturer Ltd is not liable for damage caused by misuse and/or incorrect setting of the appliance.

Those, whom for physical, sensorial or mental incapacity, and are inexperience and ignorance are not able to safely use the appliance independently can put it into operation only if supervised and taught by competent persons, who assume the responsibility.

IF THERE ARE CHILDREN

Check the children when they are close to the washing machine. Do not allow them to play with the appliance.

If washing is done at high temperatures, keep in mind that the glass door could become very hot, so keep children away from touching it.

TECHNICAL SAFETY

Before connecting the appliance to the electric power line compare technical data (voltage, frequency) on the rating plate with that of the mains. If in doubt, consult a qualified electrician.

The electric safety of washing machine is guaranteed only if the machine is connected to a legal standard protective (earthing system) power unit. It is a fundamental requirement for safety. Verify this condition and if in doubt have the power system checked by a qualified electrical.

NB: The manufacturer can not be held liable for damages due to lack or interruption of the protective power unit.

For safety reasons, never use electric cord extension (because of fire danger due to overheating).

Any repair on the appliance must be made only by an authorized Technical Services Department of the manufacturer, otherwise the manufacturer is not liable for damages that may result.

Repairs not performed in perfection can also expose user to serious dangers, for which the manufacturer is not answerable.

If the power cord is damaged, it must be entirely replaced by an authorized the manufacturer personal to avoid any danger.

In case of breakdowns or cleaning of the machine, keep in mind that the machine is disconnected from the mains only if:

- The power plug is unplugged, or if
- The electric power switch of the house is off, or if
- The fuse of the electrical system is completely screwed (the electric wiring disconnected).

- To connect the washing machine to the water supply using only new hoses. Do not use old water inlet hoses.

Changes to the washing machine cannot be made if not specifically authorized by the manufacturer.

CORRECT USE

Do not install the appliance in places exposed to frost. Freeze might rupture or burst. Furthermore, at temperatures below zero the electronics can not function properly.

Before switching on the washing machine for the first time, remove the safety transportation screws at the back (see installation chapter). The washing machine could be damaged if it spins with the safety transportation screws in place. The cabinet or adjacent components or the machine itself could be damaged.

In the event of prolonged absence (e.g. holidays), close the water tap, remove the power plug from the socket.

Flood hazard

Before hanging the drain hose onto a sink, make sure that water can drain quickly. Secure the drain hose so that it can not move because the force drained water could push it out of place from the sink.

Be careful not to wash, with the laundry, foreign bodies (e.g. nails, needles, coins, paper clips). These foreign bodies can damage the washing machine (e.g. the drum or tub) and in turn, the damaged parts can ruin laundries.

EN

Items that have been previously treated with solvents or products containing them must be well rinsed in clean water before being loaded into the washing machine.

Never use in washing machine detergents that contain solvents (eg petrol, trichlorethylene). These products could damage of the components of the machine and generate toxic fumes.

Danger of explosion and fire

Never use in washing machine detergents that contain solvents (e.g. petrol, trichlorethylene). They can damage the plastic surfaces.

N.B.

The manufacturer can not be held liable for damages resulting from failure to follow these instructions.

DESCRIPTION OF MACHINE

This appliance meets all modern requirements for effective treatment of laundry with reduced consumption of water, electricity and detergent. Its innovative system permits full use of detergent and reduces water consumption, resulting in energy savings.

This machine complies with ECC directives ECC:

- 2005/32/EC (Eco design);
- 2006/95/EC (low tension) and subsequent modifications;
- 2004/108/EC (electromagnetic compatibility) and subsequent modifications;
- 2002/96/EC (Disposal of electronic and electrical waste);

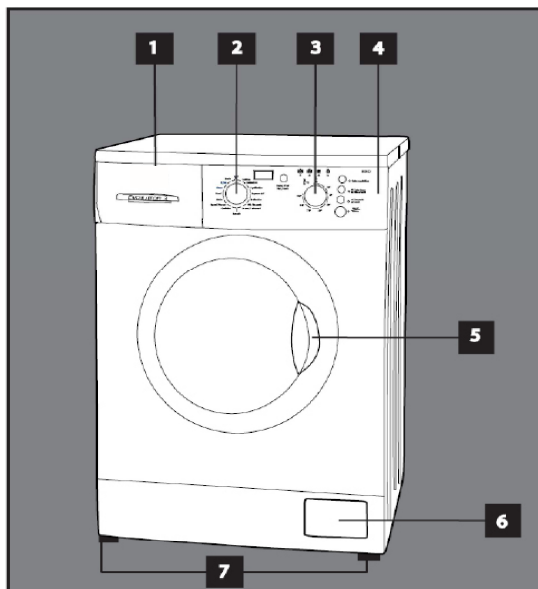

1 - DETERGENT DRAWER

2 - PROGRAMME SELECTION KNOB

3 - TEMPERATURE SELECTION KNOB

4 - CONTROL PANEL

5 - DOOR HANDLE

6 - FILTER PUMP

7 - ADJUSTABLE FEET

DETERGENT DRAWER

I Detergent compartment used with pre-washing or soaking function. The detergent to be used for the prewash and the soak is loaded at the beginning of the washing program.

II Compartment for powder or liquid detergent used for main wash. If use liquid detergent is used, pour just before starting the programme.

III Compartment for liquid additives (fabric softener, starching). Follow the manufacturer's recommendations regarding the amount of use and do not exceed the "MAX" mark on the detergent drawer. The softeners, starch or additives must be poured into the compartment before the start of the wash programme.

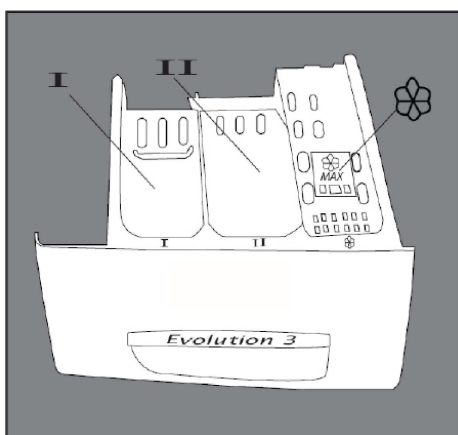

INSTALLATION

GENERAL INFORMATION

The washing machine can be installed in any place on condition that:

- is protected from the bad weather;
- the ambient temperature is not lower than 3 ° C;
- the cables and hoses at the back of the machine are not crushed;
- the power cord is accessible in case of any maintenance.

N.B. Should it prove necessary for electrical and/or hydraulic maintenance contact only a qualified technician.

REMOVAL OF TRANSPORTATION LOCKING SCREWS

N.B. Failure to remove the fixing screws will generate strong vibrations and abnormal movement of the machine during the washing with consequent damages.

The washing unit is locked out by four fixing screws (which protect it during transport) as show in figure 1.

Before operating the machine the screws must be removed. To unscrew them use a spanner.

Figure 1

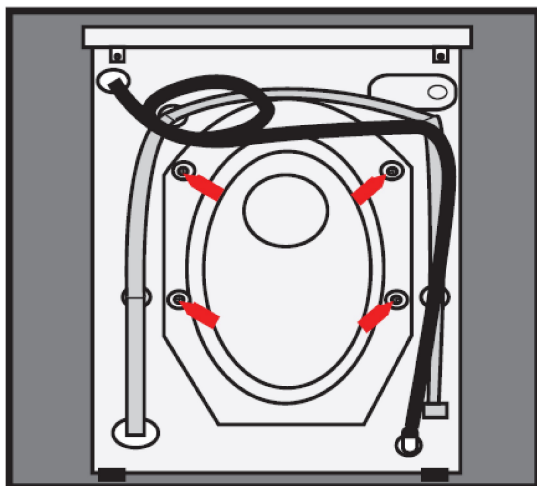

Once unscrewed the screws pull out the locking screws including a bushing and spacer as shown in Figure 2.

EN

Figure 2

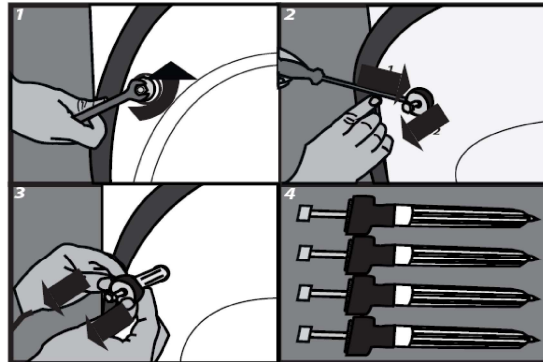

N.B. In case the spacers fall into the machine it will be necessary to open the rear panel, retrieve them and reposition the panel.

Close up the holes with the supplied caps as shown in Figure 3.

Figure 3

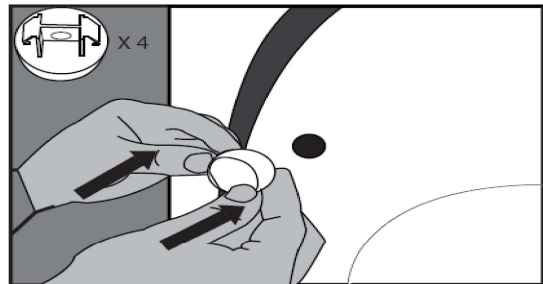

POSITIONING OF WASHING

To ensure stability to washing machine and avoid strong vibrations during washing and spinning, it is necessary that the appliance be placed on a smooth, hard, dry surface and not raised above floor level. To compensate for any unevenness in the floor it is possible to act on the height of the feet, by screwing or unscrewing them according to requirements. As shown in the figure in the next page.

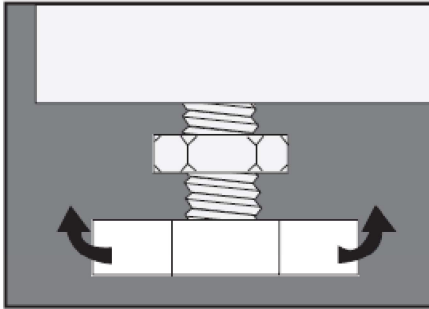

After adjustment, to avoid their modification by vibrations, they should tighten by the ring nut and/or nut on the foot until it locks as shown in the figure below.

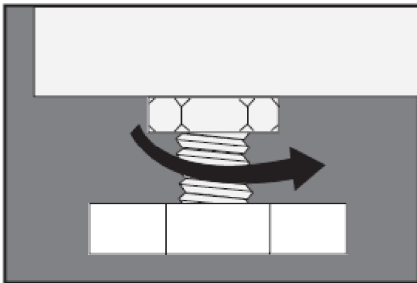

It is good to avoid, at any case, placing under or around to the machine cardboard, wood or similar materials, so as not to obstruct the passage of air.

INSTALLATION UNDER A WORK PLAIN

The positioning of the machine under a work plan, can only happen if the housing compartment has the following dimensions of width of 76cm and of height of 85cm. It should also be considered that the machine needs a approximately 5cm behind from the wall. An example of a typical installation is shown in the illustration below. The superior cover (TOP) of the machine must not be removed for reasons of electrical and mechanical safety.

Figure 4

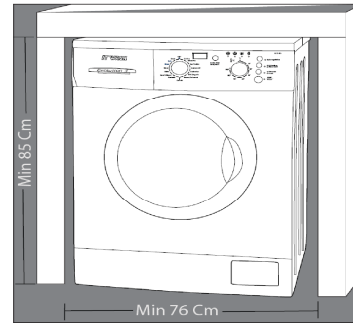

WATER SUPPLY CONNECTION

The water inlet hose must be connected to a tap of cold water with a 3/4" threaded mouth.

Use only the supplied water inlet hose, avoiding the use of old hoses, or hoses used previously.

N.B. the hose is already complete with rubber gasket, if this is missing, the tube must not be used.

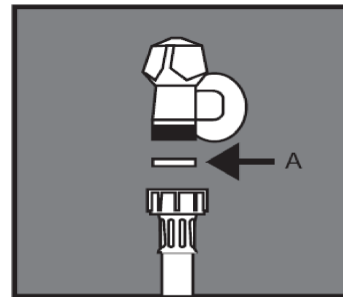

If the water supply system is new or has been inactive for too long, it will be necessary to allow the water run until the water appears clear before connecting the hose.

Figure 5

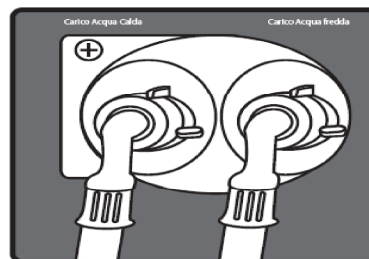

Figure 5b shows the connection to the hot water tap, this option is only available on request.

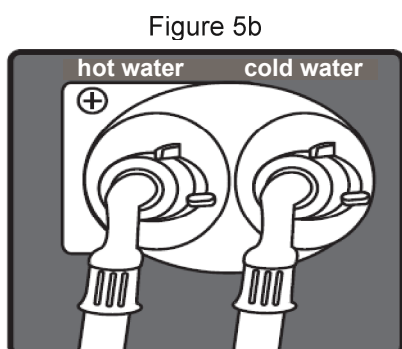

Figure 5b

Make sure that the domestic hot water supply temperature does not exceed 55°C to avoid damage to the laundry and washing machine. For the inlet hose only use the supplied.

WATER DRAINAGE

Drain hose can be installed in two different ways:

- **On the edge of sink using the plastic hose hanger commercially available.**

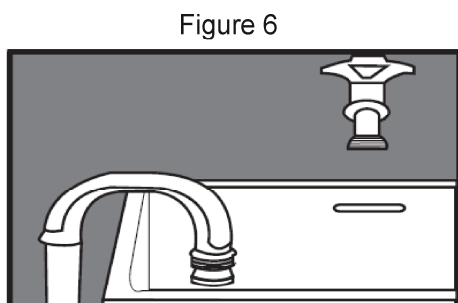

Figure 6

In this case make sure that the tube is secured to the sink.

- **In a drain pipe at a height of not less than 60 cm and not more than 90cm.**

The tube end must always be ventilated, i.e. the inside diameter of the drain pipe must be larger than the outer diameter of the drain hose of the washing machine. The drain hose must not be obstructed.

Example of installation

Figure 7

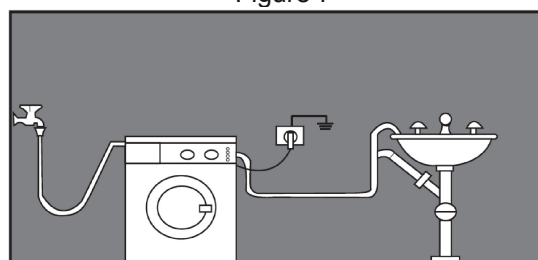

N.B. It is not recommend using extension on the drain hose.

EN

LIQUID DETERGENT BULKHEAD PAN

Inside the kit supplied, there is a bulkhead pan of blue colour which grants the use of liquid detergents in the washing machine.

To install a bulkhead it is necessary to:

- remove the detergent drawer from the washing machine
- apply the bulkhead as shown in photo

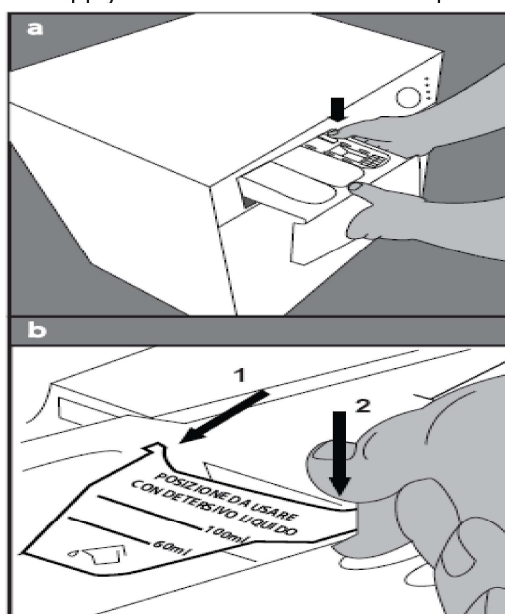

After installation, replace the drawer into the washing machine. There is no need to remove the bulkhead (see p. 19).

POWER SUPPLY CONNECTION

The machine is equipped with a connecting cable and earthed schuko plug for connection to AC 230 V ~ 50 Hz.

Make sure the schuko plug is always accessible to unplug the machine from the mains.

The electrical power system must be designed according to VDE 0100.

It is recommend to not connect in any case the machine with extension cords multiple power sockets, etc to avoid overheating which are sources of potential fire hazard.

To increase security VDE, in the directive DIN VDE 0100 in section 739, it is recommended to install a circuit breaker (RCD) with a tripping current of 30 mA (DIN VDE 0664).

If using a differential circuit breaker, make sure it is type A, according to DIN VDE 0664 and current sensitive buttons.

The rating plate provides information on rated current absorption and relating protection. Compare these data with the power supply.

IMPORTANT!

- AFTER HAVING INSTALLED THE APPLIANCE, THE POWER CORD MUST BE ACCESSIBLE
- IF THE POWER CORD IS DAMAGED, IT MUST BE SUBSTITUTED BY THE MANUFACTURE, ITS QUALIFIED TECHNICIAN WITH AIM OF AVOIDING DANGER

N.b. Do not use extension cords or adapters.

Figure 8

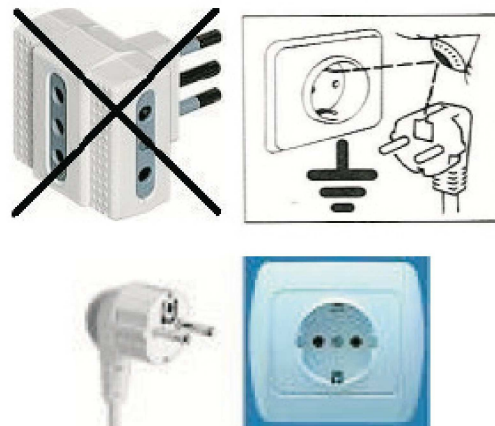

The manufacturer Ltd disclaims any liability for damage or injury caused by noncompliance with of safety rules

CONTROL PANEL

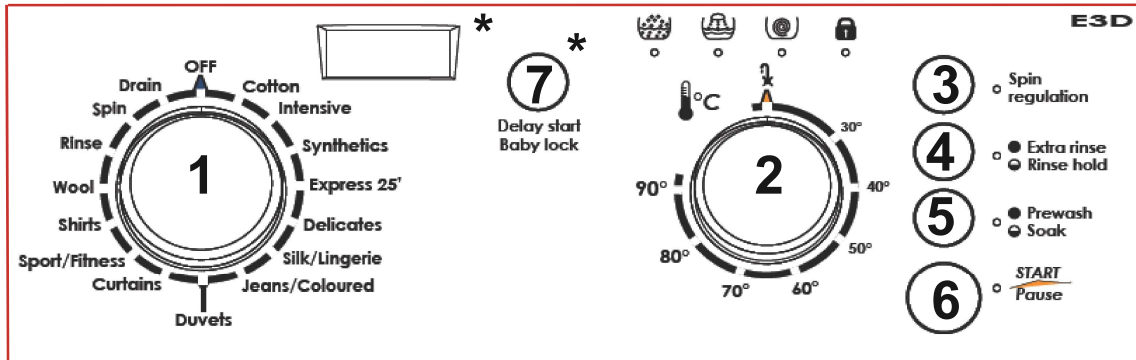

EN

*Available exclusively on the version of E3D model

DESCRIPTION OF COMMANDS

1. PROGRAMME SELECTION KNOB

The knob is used to select a desired programme and to turn the machine OFF. It can be rotated in clockwise and counterclockwise for a fast and easy selection of programme.

2. TEMPERATURE REGULATING KNOB

This knob allows for the adjustment of the temperature. To change setting rotate the knob to the desired temperature.

3. SPIN REDUCTION

E3L MODEL

This button is used for reduction or spin exclusion. Upon each press of the button the LED indicator changes state, there are three possible combinations which are:

- Led steadily on - maximum spin speed
- ◐ Led blinking - medium spin speed
- Led off - spin excluded

3. SPIN REGULATION

E3D MODEL

This button is used to adjustment the spin speed. To change setting, press the corresponding key repeatedly until the desired value is shown on the digit display.

4. EXTRA RINSE AND RINSE HOLD

This button allows for the select extra rinse or rinse hold function. Upon each press of the button the LED indicator changes state, there are three possible combinations which are:

- Led steadily on - extra rinse
- ◐ Led blinking - rinse hold
- Led off - exclusion of both

The extra rinse function adds an extra rinse to standards rinse cycle.

The anti-crease function, when activated the washing machine stops with water in the tank without having to drain and spin. To run the drain and spin, the **START/PAUSE** at the corresponding blinking LED must be pressed.

5. PREWASH AND SOAK

This key allows for the selection of prewash or soak function. Upon each press of the button the LED indicator changes state. There are three possible combinations which are:

- Led steadily on - prewash
- ◐ Led blinking - soak
- Led off - exclusion of both

The prewash function is used to make a low temperature washing before the main wash cycle to remove stains.

The soak function is used to soak laundry before main wash cycle.

6. START/PAUSE

The button activates and deactivates the selected washing programme.

7. DELAYED START AND CHILD SAFETY E3D MODEL ONLY

This button, when selecting a washing programme, it allows for the adjustment of the delay start function; while after starting the wash cycle it allows for the activation of the child safety locking feature.

To set the delayed start time the button is pressed repeatedly until the desired value shown on the digit display. The value can be chosen between 1 and 24 hours.

Pressing the Start/Pause button the countdown starts on until the expiration of the time on the digit display.

To set the child lock, after the starting of the wash cycle, press and hold the button P7 until the red LED of the "Door Lock" begins to flash.

To disable this feature, press and hold the button until the red LED stops flashing. "Locked Door" lamp becomes stable.

DOOR LOCK LED

This LED, red in colour, indicates the locking of the door which can be opened only after it turns itself off.

FIRST USE

Before the regular use it is necessary to make a wash cycle with detergent, no laundry and setting the temperature to 60°C with cotton programme.

Now the machine is ready for use, proceed as follows:

Load the laundry, taking care to select it.

Close the door, taking care not to leave laundry protruding from the seal, see figure page 11.

1) Selection of wash programme.

Customize the washing programme adjusting the spin, temperature and choosing any options for the programme selected.

Press the start button; the program starts when the LED red coloured is on. Any variations to be made to temperature, spin and special functions can also be performed during the execution of the programme, obviously before the beginning of the heating and spinning phases. Also after the beginning of the programme the soak, extra rinse or rinse hold can be enabled.

WASHING PROGRAMMES DURATION AND OPTIONS

The programme intensive 60 °C and 40 ° C are the program <cotton standard 60°C> and <cotton standard 40°C>, used for the evaluation of the product performance, is the most efficient programme in terms of combined energy and water consumption for the washing of cotton laundries

EN

The actual values may differ from those indicated depending on the water pressure, its hardness, temperature, ambient temperature, type and amount of laundry, fluctuation of the power voltage and of the additional functions selected.

Programme Consented temperatures Spin speed Laundry.	Loading capacity marked on control panel	Maximum load (kg)	Minimum load (kg)	Programme duration (*)		Washing option
				30°C	Max °C	
1-Cotton from to 90°C. 0 - Max rpm Sheets, pillow cases, table - cloths in cotton or linen	5 Kg	5	2,5	2 hours	2 hours 25 min	Prewash or Soak. Extra rinse or rinse hold
	6 Kg	6	3			
	7 Kg	7	3,5	2 hours 15 min	2 hours 40 min	
	8 Kg	8	4			
	9/10 Kg	9/10	4,5			
2-Intensive from to 90°C. 0 - Max rpm Sheets, pillow cases, table - cloths in cotton or linen	5 Kg	5	2,5	2 hours 27 min	2 hours 52 min	Prewash or Soak. Extra rinse or rinse hold
	6 Kg	6	3			
	7 Kg	7	3,5	2 hours 42 min	3 hours 07 min	
	8 Kg	8	4			
	9/10 Kg	9/10	4,5			
3-Synthetics from cold to 60°C. 0 - 800 rpm Synthetic fabrics (e.g., acrylic, polyester, micro- fiber).	5 Kg	2,5	1,5	1 hour 39 min	1 hour 59 min	Prewash or Soak. Extra rinse or rinse hold
	6 Kg	3	1,5			
	7 Kg	3,5	2	1 hour 54 min	2 hours 14 min	
	8 Kg	4	2			
	9/10 Kg	4,5	2,5			
4-Express From cold to 40°C. 0 - Max rpm Cotton and syn- thetic fabrics	5 Kg	2,5	1,5	35 min	40 min	Prewash Extra rinse
	6 Kg	3	1,5			
	7 Kg	3,5	2	40 min	45 min	
	8 Kg	4	2			
	9/10 Kg	4,5	2,5			
5-Delicates from cold to 40°C. 0 - 600 rpm. Synthetic fabrics and delicate cotton	5 Kg	2	1,5	1 hour 27 min	1 hours 33 min	Prewash or Soak. Extra rinse or rinse hold
	6 Kg	2,5	1,5			
	7 Kg	3	2	1 hour 35 min	1 hour 41 min	
	8 Kg	3,5	2			
	9/10 Kg	4	2,5			
6-Eco 20°C ** from cold to 20°C. 0 - Max. rpm. Silk and under wear.	5 Kg	0,5	-	1 hour 8 min		Soak. Extra rinse or rinse hold.
	6 Kg	0,5	-			
	7 Kg	1	-	1 hour 13 min		
	8 Kg	1,5	-			
	9/10 Kg	2	-			

** Max temperature for this program is 20°C. Possible settings 0°C or 20°C any different position greater than 20°C of knob is intende as setting 20°C.

Programme Consented temperatures Spin speed Laundry.	Loading capacity marked on control panel	Maximum load (kg)	Minimum load (kg)	Programme duration (*)		Washing option
				30°C	Max °C	
7-Jeans/Coloured from cold to 60°C. 0 - Max rpm. Cloured cotton and Jeans.	5 Kg	2	1,5	1 hour 40 min	1 hour 46 min	Prewash or soak. Extra rinse or Rinse hold.
	6 Kg	2,5	1,5			
	7 Kg	3	2			
	8 Kg	3,5	2	1 hour 48 min	1 hour 54 min	
	9/10 Kg	4	2,5			
8-Duvets from cold to 60°C. 0 - 800 rpm. Duvets, pillows and stuffed ani- mals in feather.	5 Kg	1,5	-	1 hour 30 min	1 hour 40 min	Prewash or soak. Extra rinse or Rinse hold.
	6 Kg	2	-			
	7 Kg	2,5	-			
	8 Kg	3	-	1 hour 35 min	1 hour 45 min	
	9/10 Kg	3,5	-			
9-Curtains from cold to 40°C. 0 - 600 rpm. Washable cur- tains.	5 Kg	0,5	-	1 hour	1 hour 6 min	Extra rinse or Rinse hold.
	6 Kg	0,5	-			
	7 Kg	1	-			
	8 Kg	1,5	-	1 hour 5 min	1 hour 11 min	
	9/10 Kg	2	-			
10-Sport/Fitness from cold 40°C. 0 - 600 rpm. Cotton sportwear, lycra or chenille etc.	5 Kg	1	-	1 hour 10 min	1 hour 16 min	Prewash or soak. Extra rinse or Rinse hold.
	6 Kg	1,5	-			
	7 Kg	2	-			
	8 Kg	2,5	-	1 hour 18 min	1 hour 24 min	
	9/10 Kg	3	-			
11-Shirts from cold to 60°C. 0 - 600 rpm. Polyester and cotton shirts.	5 Kg	1	-	1 hour 18 min	1 hour 30 min	Prewash or soak. Extra rinse or Rinse hold.
	6 Kg	1,5	-			
	7 Kg	2	-			
	8 Kg	2,5	-	1 hour 26 min	1 hour 38 min	
	9/10 Kg	3	-			
12-Wool from cold to 40°C. 0 - 1000 rpm. Washable wool or wool blend..	5 Kg	1	-	56 min		Extra rinse or Rinse hold.
	6 Kg	1,5	-			
	7 Kg	2	-			
	8 Kg	2,5	-	1 hour 1 min		
	9/10 Kg	3	-			

USE AS A REFERENCE FOR THE LAUNDRY, THE FOLLOWING WEIGHTS

Bathrobe	1200 g
Bedspread	700 g
Work apron	600 g
Pyjama	500 g
Tablecloth	250 g
Pillowcase and towel	200 g
Tablemats (serviette) and underwear	100 g















ECO-DESIGN REFERENCE

Model	Water supply pressure (kPa)	STANDBY (Watt)		TEMPO PROGRAMMES (Min.)			RESIDUAL HUMIDITY (%)			TOTAL ENERGY CONSUMPTION (kWh)			TOTAL WATER CONSUMPTION (lt)		
		ON	OFF	40 1/2	60 1/2	60	40 1/2	60 1/2	60	40 1/2	60 1/2	60	40 1/2	60 1/2	60
5kg washing machine	50 - 800	0,65	0,09	130	155	154	50	51	49	0,45	0,76	0,80	34	34	42
6kg washing machine	50 - 800	0,65	0,09	132	155	156	51	50	51	0,51	0,84	0,90	36	37	47
7kg washing machine	50 - 800	0,65	0,09	140	160	159	56	56	55	0,41	0,78	0,76	39	39	42
8kg washing machine	50 - 800	0,65	0,08	140	175	162	56	56	55	0,53	0,97	0,92	44	46	56
9kg washing machine	50 - 800	0,65	0,09	142	168	163	60	61	57	0,54	1,00	0,83	48	49	53
10kg washing machine	50 - 800	0,65	0,09	149	170	171	54	55	53	0,60	1,06	1,11	51	55	73

EN

* The following table refers to the intensive washing programme.

FABRIC CARE SYMBOLS

WASHING	LAUNDRY	IRONING	BLEACHING
The value inside the basin indicates the maximum temperature at which laundries are washed	The letter inside the tank indicates the maximum temperature at which laundry can be washed.	The dots represent the optimal temperature of the iron.	Type of bleaching for laundries
 Normal treatment	 Dry cleaning with petrol	 About 200°C	 Bleaching is possible with any bleach
 Delicate treatment	 Dry cleaning perchloride	 About 150°C	Use only oxygen bleaches
 Very delicate treatment	 Washing in water	 About 110°C	 Do not bleach
 Hand wash	 Do not dry clean	 No ironing	
 Not washable in water			

PRECAUTIONS AND ADVICE

WASHING RECOMMENDATIONS

- Do not allow children or disabled to use the washing machine without supervision.
- Do not allow children to play with the washing machine.
- Load the drum within the limits indicated in the initial pages.
- For each fabric it is important to follow the washing instructions on the label.
- Make sure that there are no coins, pins, etc in the pockets of clothes for washing.



- Refrain from the use of petrol, alcohol, trichlorethylene, etc on fabrics intended for machine washing.
- It is advisable to collect the laundry of small dimensions, such as socks, belts, etc in a canvas bag, so as to avoid them been stuck to the drum.
- Use fabric softener within the maximum allowable limit as an excessive amount could damage the laundry.
- When machine turned off, leave the door ajar for the better preservation of the seal and preventing musty odours.
- Before opening the door always check that the water has been drained.
- Always close the water tap when the machine is turned off.
- Remove the power plug when the machine is not used for long periods.

SELECTION OF LAUNDRY

For proper washing, laundry has to belong to only one of the following types:

- White
- Coloured
- Synthetics
- Delicate
- Wool

In particular it must be considered that:

- the white laundries lose their whiteness if they are washed with coloured fabrics;
- the new coloured clothes usually fade with the first washing. So they must not washed with other laundries.

It is also important to follow the suggestions for washing indicated on the labels of every individual fabric. Make sure in the laundries are no metal objects (such as clasps, pins, screws, coins, curtain hooks etc) left.

Before washing, it may be appropriate to treat very dirty spots with a special detergent or detergent paste.

Carpets, ruined clothes, hair, lint, fluff and dirt in general can clog the drainage. It is, however, recommend to avoid washing of these types of laundries.

DOOR GASKET

When washing some objects from over-folded clothes, or not removed from the laundry (paper clips, buttons, nails, pins) can break off and settle in the folds of the door gasket. It is a good habit to check the folds of the door gasket and remove any foreign objects which with time could cause serious problems to the washing machine.

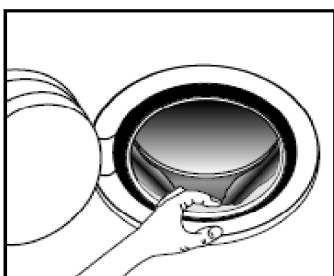

DOOR CLOSURE

Before closing the door make sure that there is no piece of laundry on of the door gasket. This could damage it. Close the porthole with a slight thrust.



DETERGENT AND SOFTENER DOSAGE

For each wash cycle the optimal amount of detergent must be determined by the degree of dirt, number of laundry and water hardness. In any type of washing, the detergent must be placed in the central compartment (**marked II**).

Where there will be prewash, detergent must be deposited in the compartment on the left side (**marked I**).

The basin on the right is used for fabric softener. The dose of the latter should not exceed the "**MAX**" mark.

EN

LIQUID OR POWDERED DETERGENT PARTITION PLATE

To change the use of the detergent from powder to liquid, put the partition plate present in its housing in the second compartment:

UP - position of the plate for the use of liquid detergent

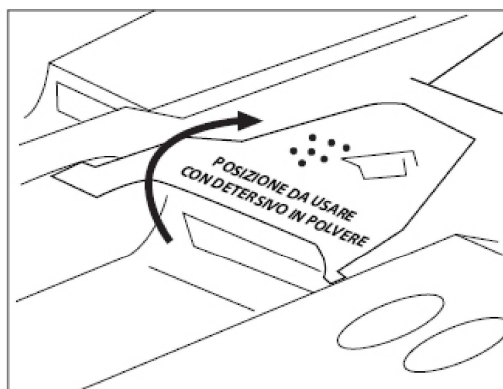

Pour the detergent powder in the main wash compartment **II**.

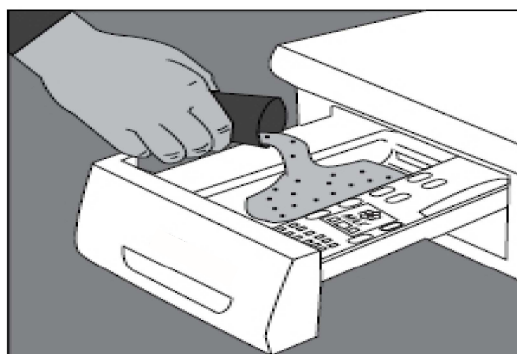

Remove the remaining powder from the plate.

For the amount of detergent, always check the specifications of the product on its package and make sure that the detergent can be poured into the basin.

DOWN - position of the plate for the use of powdered detergent.

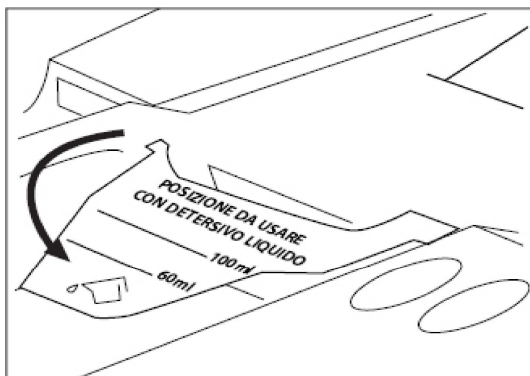

Pour liquid detergent into the main wash compartment **II**.

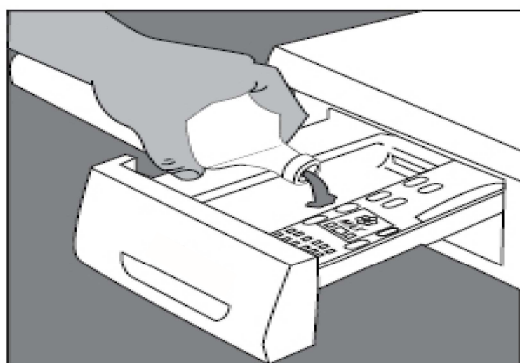

WARNING!

Do not use the plate in the “DOWN” position:

- With with gelatinous or dense detergent
- With powdered detergent
- With the prewash programme
- Do not use liquid detergent if the wash cycle does not start immediately.

In such cases use the plate in the “UP” position.

DETERGENT POWDER

Detergent powder is more aggressive than the liquid and undoubtedly less advanced in some respects. It is prepared usually with components rather strong; The manufactureres also through particular substances (enzymes) which destroys the dirt detaching from the laundry, but does exert any abrasion on the fabric. The laundry washed with detergent powder, when dry, is rather rough and dry because of these aggressive substances that harden the fabrics. This requires generally rinsed with fabric softener. Furthermore, the enzymes may cause allergies in some sensitive people. Not to mention that the powders less soluble in this type of detergent can be deposited in the tank and in the drainage system, causing the incrustation of the tubes with all the ensuing problems. On the other hand it is the only detergent that ensures to get a pure white due to sodium perborate, a strong and aggressive whitening agent, effective even at low temperatures (refer to the labeling and the degree of dirt).

Recommended temperature 30°C - 90°C

LIQUID DETERGENTS

The liquid detergent is undoubtedly the most modern and possesses superior cleaning features. Being less alkaline it preserves the quality of the fabrics Although it does not contain abrasive substances however it cleans nested dirt. Thus, in contrast to the detergent powder, it cleans without hardening the laundry fibres, thanks to the absence of an insoluble residue that drying becomes hard. The laundry is more soft and therefore require less fabric softener. Furthermore, the liquid detergent does not leave any type of solid residues inside the washing machine and in the drainage system, eliminating the long standing problem of incrustation and ruining of the tubes. The manufactureres well also in cold and is ideal for coloured clothes because it does not interact with the fabric colours, rather the colour is preserved and protected with time. It should be used within temperature range of 0°C and 90°C. The temperature depends on the fabric (refer to the labelling and by grade of dirt)

The whiteness efficiency is obtained instead only at temperatures above 50°C, as in the liquid detergent there is no sodium perborate, but the optical bleaching agent that works well only beyond a certain temperature.

Recommended temperature cold - 90°C

SOFTENER

The softener is very high concentrate, which is deposited on the laundry fibres and makes them soft. It should be used sparingly or diluted with water, 50% and more. It facilitates ironing of clothes washed.

The fragrances are due to different essences added to the detergent and do not in any way impair the ability of cleaning product.

DETERGENT DOSES

The doses vary depending on the type of water: with hard or averagely hard water it takes a greater amount of product compared to that soft water, as is typically printed on the label of the various products. In general, using quality products, very little quantity of detergent would be enough, and to always use 20% less than usual can not go wrong!

STARTING WASHING PROGRAMME

1. To start the washing program turn the programme selection knob onto the desired programme.

Evaluate the opportunity to customise the washing programme by adjusting the temperature with the knob No. 2, the spin (button 6) or selecting one or at most 2 of the special functions provided.

STARTING WASHING

After the steps above washing can be started by pressing the Start/Pause button.

PAUSING WASHING

It is possible to stop the wash cycle by pressing the Start/Pause button. The machine will go to standby mode. If there is a need to change the programme, the knob No. 1 must be turned to OFF position before selecting new programme. At the end of the wash cycle, the red LED turns off and the door can be opened only if the drum is not empty of water.

EN

LOADING LAUNDRY INTO THE DRUM

For proper washing, it is necessary to load the drum possibly with loose laundry one at a time. This is to prevent nodes. The washing efficiency is strongly influenced by the way and the amount laundry. In general, an excessive or less than half the rated capacity (see technical data table page 2), puts strain on the 'reliability of the washing machine and generates more noise in the machine.

In the case of excessive loads or below the nominal capacity and uneven, it is appropriate to minimize the spin speed to avoid strong vibrations during spinning.

MAINTENANCE

CABINET

To maintain the shininess washing machine cabinet unchanged over time it must be cleaned with warm water.

Cleaning is recommended with soft cloth without using any detergent.

DETERGENT DRAWER

To avoid deposits formation detergent it is necessary to rinsed well often the drawer with the water. It can be extracted from the housing by pressing on the area encircled in Figure 6.

Figure 6

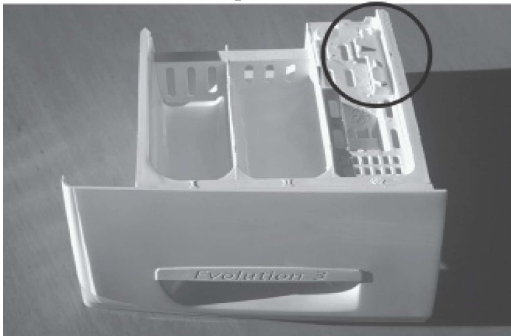

CLEANING DRAIN PUMP FILTER

To minimize the risk of clogging of the drainage system, it is advisable to do a monthly periodic cleaning of the drain pump filter. To clean the filter, proceed as follows:

- open the drain pump door in the event of a blocked drain and / or power outage.
- turn off the washing machine
- obtain a coin.

Insert a coin or others into the open slot flip side.

Figure 8

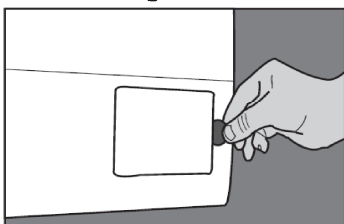

N.B If the drain pump is clogged, substantial quantity of water could be in the machine (max. 25l).



Attention! Burn hazard if washing at high temperature has made shortly.

Emptying procedure

- 1) Position a basin or other recipient between the cabinet and filter spill lip.

Figure 9

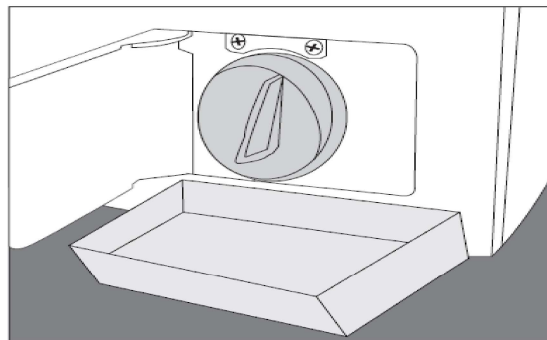

Do not unscrew all of the exhaust filter

- 2) Loosen the filter only just enough to drain the water.

Figure 10

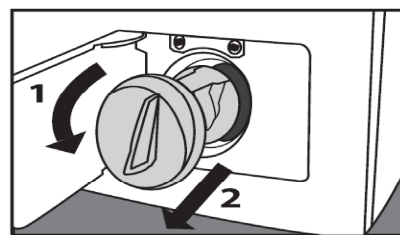

To stop the flow:

Tighten the drain filter.

When no more water comes out:

Unscrew the entire filter.

Clean the filter.

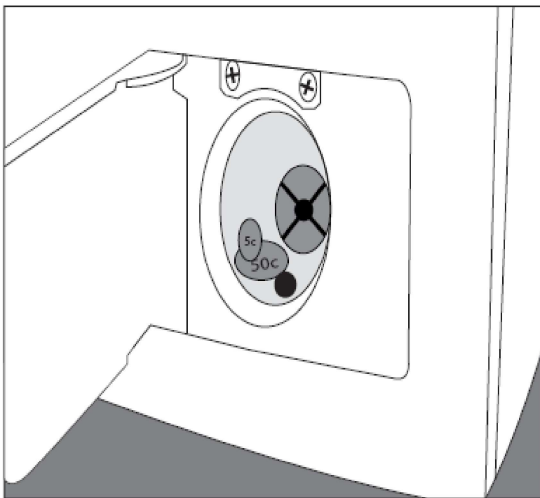

Verify that the drain propeller rotates easily. Remove any debris and clean the inside if there should be any.

Replace the drain pump filter and screw it firmly.



Warning! If the filter is not reinserted or screwed tightly, the water could spill from the machine.

DETERGENT DRAWER CLEANING

Having removed the detergent drawer, take away the vent steam plate as shown in photo below.

EN

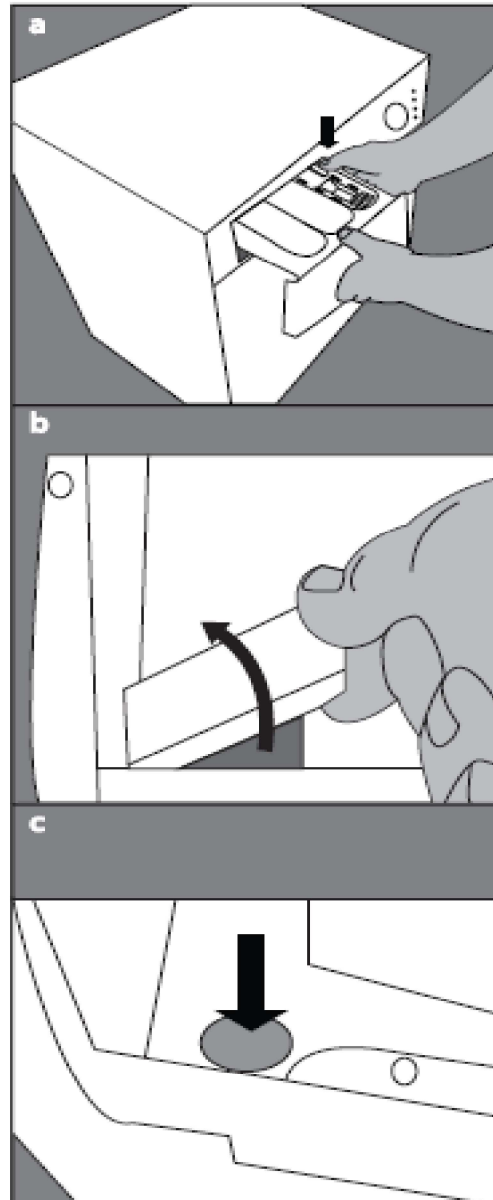

If it is clogged by foreign bodies or detergent, it is advisable to break it small fragments taking care not to push the lumps to the bottom to prevent clogging of the internal circuit. Note that the detergent is removed easily if treated with hot water.

POSSIBLE REMEDIES

The vast majority of failures and faults that occur in daily use of the machine can be eliminated personally. In many cases time and costs could be saved without necessarily having to contact The manufacturer srl authorized technical service centre.

The following table will aid to identify and possibly eliminate the causes of failure/malfunction. However, note that:



Repairs to electrical equipment can be carried out only by qualified and authorized. Repairs executed incorrectly can seriously threaten the safety of user.

Problem	LED Alarm	LCD Alarm	Possible Solution
The machine does not turn on or start			<ul style="list-style-type: none"> • Make sure that the power plug is inserted. • Make sure there is power in the socket. • Make sure that the selector switch, programme selector knob 1, is not in the OFF position.
The machine turns on but does not start and LEDs No. 1 and 2 flash (LED model) or F1 appears on display (LCD model) .	○ ○ ● ●	F1	<ul style="list-style-type: none"> • Make sure the door is well closed
The machine does not take water and LEDs. 1 and 3 flash (LED model) or F2 appears on display (LCD model) .	○ ● ○ ●	F2	<ul style="list-style-type: none"> • Make sure there is water supply. • Make sure the water tap is opened. • Make sure the water inlet hose is not squashed. • Make the water electro-valve filter is not clogged
Led number 2 and 3 flash (LED model) or F3 appears on monitor (Display model).	○ ● ● ○	F3	<ul style="list-style-type: none"> • Switch off and then switch on the washing machine. In the fault persist contact an authorised service centre.
The machine does not empty, does not spin and leds 1 and 4 flash (LED model) or F4 appears on display (LCD model)	● ○ ○ ●	F4	<ul style="list-style-type: none"> • Make sure the drain pump filter is not clogged. See page 22. • Make sure the rinse hold special function is enabled. • Make sure that the drain hose is not squashed and the internal diameter of the drainage is larger the that of the drain hose.

Problem	LED Alarm	LCD Alarm	Possible Solution
Leds number 2 and 4 flash (LED model) or F5 is displayed (Display model).	<ul style="list-style-type: none"> ● ○ ● ○ 	F5	<ul style="list-style-type: none"> • Switch off and then switch on the washing machine. In the fault persist contact an authorised service centre.
Leds number 1, 2 and 4 flash (LED model) or F6 is displayed (Display model).	<ul style="list-style-type: none"> ● ○ ● ● 	F6	<ul style="list-style-type: none"> • Switch off and then switch on the washing machine. In the fault persist contact an authorised service centre.
The door does not open			<ul style="list-style-type: none"> • Make sure the red pilot lamp turns off. • Make the special function SOAK or RINSE HOLD is not activated • Push the door from the door locking side or give a slight tap and at the same time pool it to open.
The is water on the floor			<ul style="list-style-type: none"> • Make both the water inlet hose and drain hose are whole and do not leak. • The washing detergent could not be ideal or could be excessive. • Reduce the detergent quantity.
The washing machine fetching in water even when it is off.			<ul style="list-style-type: none"> • Reduce the pressure of water supply or the water pressure pumping system (water autoclave). • Close tap at the end washing.
The machine vibrates noticeably.			<ul style="list-style-type: none"> • Ensure that the transportation screws have been removed during installation. • Make sure the drain pump filter is not clean. Ensure that the drain pump is squashed and that the machine drains effectively. • Ensure using the correct detergent for washing machine. • Make sure that the laundry is not amassed or knotted and that the spin speed is adequate for the laundry load. It so recommended that for excessive laundry load and less than half the nominal load capacity set the spin speed to low. • Ensure that the machine is properly levelled on the floor. It is recommended that for any eventual feet imbalance compensation the feet must regulated and lock them in place with the locking knob (see figure 3b on page 10).

SPARE PARTS AND SERVICE

REPAIR

For any repairs, contact authorised The manufacturer Ltd technical support service centre.

Always communicate model and serial number of the appliance printed on the rating label. The data plate is also visible on the door opening, in the upper part.

