

DAILY REFERENCE GUIDE



THANK YOU FOR PURCHASING AN HOTPOINT-ARISTON PRODUCT

To receive more comprehensive help and support, please register your product at www.hotpoint.eu/register



You can download the Safety Instructions and the Use and Care Guide by visiting our website docs.hotpoint.eu and following the instructions on the back of this booklet.



Before using the appliance carefully read the Health and Safety guide.

PRODUCT DESCRIPTION

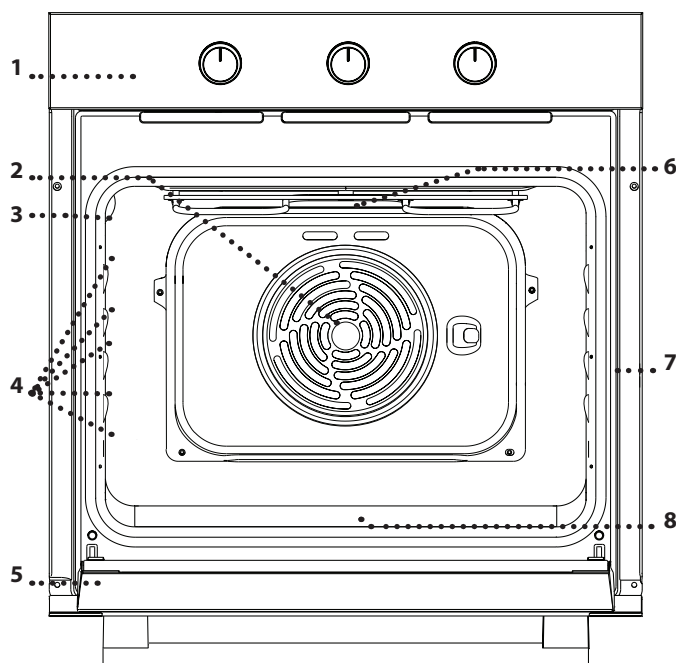

1. Control panel
2. Fan
3. Lamp
4. Runners for accessories
(the level is indicated on the wall of the cooking compartment)
5. Door
6. Upper heating element / grill
7. Identification plate
(do not remove)
8. Lower heating element
(not visible)

CONTROL PANEL

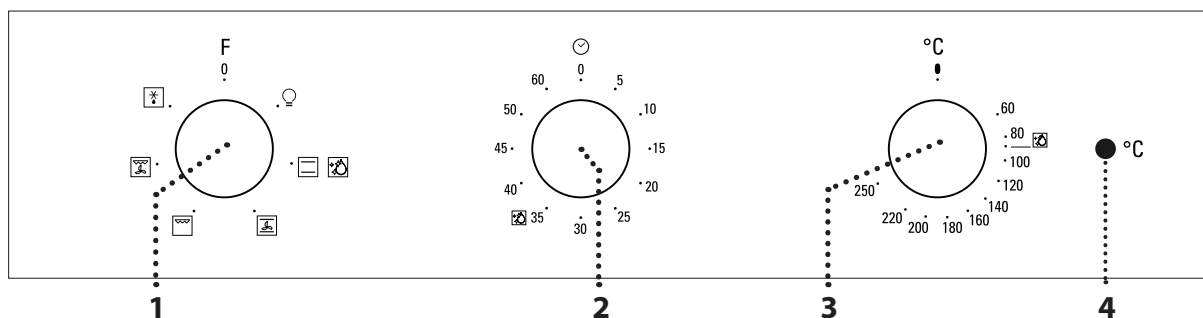

1. SELECTION KNOB

For switching the oven on by selecting a function. Turn to the 0 position to switch the oven off.

2. TIMER KNOB

Useful as a timer. Does not activate or interrupt cooking.

3. THERMOSTAT KNOB

Turn to select a desired temperature, activating the selected function.

4. LED THERMOSTAT / PREHEATING

Switches on during the heating process. Switches off once the desired temperature is reached.

WIRE SHELF

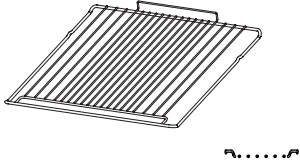

BAKING TRAY

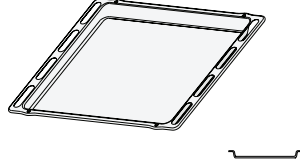

The number of accessories may vary depending on which model is purchased. Other accessories can be purchased separately from the After-sales Service.

INSERTING THE WIRE SHELF AND OTHER ACCESSORIES

. Insert the wire shelf onto the level you require by holding it tilted slightly upwards and resting the raised rear side (pointing upwards) down first. Afterwards, slide it horizontally along the runners as far as possible.

. The other accessories, such as the baking tray, are inserted horizontally by sliding them along the runners.

FUNCTIONS



OFF

For switching off the oven.



LIGHT

For switching on the light in the compartment.



CONVECTION

For cooking any kind of dish on one shelf only. It is best to use the 2nd shelf.



DIAMOND CLEAN

The action of the steam released during this special low-temperature cleaning cycle allows dirt and food residues to be removed with ease. Pour 200 ml of drinking water on the bottom of the oven and use the function for 35' at 90°C. Activate the function when the oven is cold and let it cool down for 15' once the cycle ends.



CONVECTION BAKE

For baking cakes with juicy fillings on a single shelf. This function can also be used for cooking on two shelves. Switch the position of the dishes to cook food more evenly.



GRILL

For grilling steaks, kebabs and sausages, cooking vegetables au gratin or toasting bread. When grilling meat, we recommend using a drip tray to collect the cooking juices: Position the tray on any of the levels below the wire shelf and add 200 ml of drinking water.



TURBO GRILL

For roasting large joints of meat (legs, roast beef, chicken). We recommend using a drip tray to collect the cooking juices: Position the tray on any of the levels below the wire shelf and add 500 ml of drinking water.



DEFROSTING

For defrosting food more quickly.

USING THE APPLIANCE FOR THE FIRST TIME

HEAT THE OVEN

A new oven may release odours that have been left behind during manufacturing: this is completely normal.

Before starting to cook food, we therefore recommend heating the oven with it empty in order to remove any possible odours.

Remove any protective cardboard or transparent film from the oven and remove any accessories from inside it.

Heat the oven to 250° C for about one hour, preferably using the “Convection bake” function. The oven must be empty during this time. Follow the instructions for setting the function correctly.

Notes: it is advisable to air the room after using the appliance for the first time.

DAILY USE

1. SELECT A FUNCTION

To select a function, turn the *selection knob* to the symbol for the function you require:..

2. ACTIVATE A FUNCTION

MANUAL

To start the function you have selected, turn the *thermostat knob* to set the temperature you require.

To interrupt the function at any time, switch off the oven, turn the *selection knob* and the *thermostat knob* to 0 and 0.

DIAMOND CLEAN

To activate the “Diamond Clean” cleaning function, pour 200 ml of drinking water into the bottom of the oven, then turn the *selection knob* and the *thermostat knob* to the  icon.

It is best to use the function for 35’.

3. PREHEATING

Once the function has been activated, the LED thermostat will switch on signalling that the preheating process has begun.

At the end of this process, the LED thermostat switches off indicating that the oven has reached the set temperature: at this point, place the food inside and proceed with cooking.

























































Please note: Placing the food in the oven before preheating has finished may have an adverse effect on the final cooking result.





. SETTING THE TIMER

















This option does not interrupt or activate cooking but allows you to use the display as a timer, both while a function is active and when the oven is off.

To activate the timer, turn the timer knob to the desired length of time: an acoustic signal will warn you when the count-down is finished.

COOKING TABLE

RECIPE	FUNCTION	PREHEAT	TEMPERATURE (°C)	DURATION (MIN)	LEVEL AND ACCESSORIES
Leavened cakes		Yes	150 - 170	30 - 90	2 
		Yes	150 - 170	30 - 90 ***	4  1 
Filled cake (cheesecake, strudel, fruit pie)		Yes	160 - 200	35 - 90	2 
		Yes	160 - 200	35 - 90 ***	4  2 
Biscuits / tartlets		Yes	160 - 180	15 - 35	2 / 3 
		Yes	150 - 170	20 - 40 ***	4  2 
Choux buns		Yes	180 - 200	40 - 60	2 
		Yes	170 - 190	35 - 50 ***	4  2 
Meringues		Yes	90	150 - 200	2 
		Yes	90	140 - 200 ***	4  2 
Pizza / bread		Yes	220 - 250	10 - 25	1 / 2 
		Yes	200 - 240	15 - 30 ***	4  2 
Sandwiches 80 g		Yes	180 - 200	30 - 45	2 
Bread loaf 500 g		Yes	180	50 - 70	1 / 2 
Bread		Yes	180 - 200	30 - 80 ***	4  2 
		Yes	250	10 - 20	2 
Frozen pizza		Yes	250	10 - 20 ***	4  2 
		Yes	180 - 200	30 - 45	2 
Salty cakes (vegetable pie, quiche)		Yes	170 - 200	40 - 60 ***	4  2 
		Yes	190 - 200	20 - 30	2 
Vol-au-vent / puff pastry crackers		Yes	180 - 190	15 - 40 ***	4  2 
		Yes	190 - 200	45 - 65	2 
Lamb / veal / beef / pork 1 kg		Yes	190 - 200	80 - 110	2 

ACCESSORIES	 Rack	 Baking dish or baking tray on the wire shelf	 Baking tray / oven tray on wire shelf	 Baking tray with 200 ml of water	 BAKING TRAY
-------------	--	--	---	--	---

RECIPE	FUNCTION	PREHEAT	TEMPERATURE (°C)	DURATION (MIN)	LEVEL AND ACCESSORIES
Roast pork with crackling 2 kg		Yes	180 - 190	110 - 150	2
Chicken / rabbit / duck 1 kg		Yes	200 - 230	50 - 100	2
Turkey / goose 3 kg		Yes	180 - 200	150 - 200	2
Baked fish / en papillote 0.5 kg (fillet, whole)		Yes	170 - 190	30 - 45	2
Stuffed vegetables (tomatoes, courgettes, aubergines)		Yes	180 - 200	50 - 70	2
Toasted bread		5'	250	2 - 6	5
Fish fillets / slices		5'	250	15 - 30 *	4 3
Sausages / kebabs / spare ribs / hamburgers		5'	250	15 - 30 *	5 4
Roast chicken 1-1.3 kg		-	200 - 220	60 - 80 **	3 1
Roast beef rare 1 kg		-	200	35 - 50 **	3
Leg of lamb / knuckle		-	200	60 - 90 **	3
Roast potatoes		-	200 - 220	35 - 55 **	3
Vegetable gratin		-	200 - 220	25 - 55	3
Lasagna and meat		Yes	200	50 - 100 ****	4 1
Meat and potatoes		Yes	190 - 200	45 - 100 ****	4 1
Fish and vegetables		Yes	180	30 - 50 ****	4 2

* Turn food halfway through cooking

** Turn food two thirds of the way through cooking (if necessary).

*** Switch levels halfway through cooking.

**** Estimated length of time: dishes can be removed from the oven at different times depending on personal preference. Switch shelves two-thirds of the way through cooking, if necessary.

Download the Use and Care Guide from docs.hotpoint.eu for the table of tested recipes, compiled for the certification authorities in accordance with the standard IEC 60350-1.

FUNCTIONS				
	Conventional	Grill	Turbo Grill	Convection Bake

HOW TO READ THE COOKING TABLE

The table lists the best function, accessories and level to use to cook different types of food. Cooking times start from the moment food is placed in the oven, excluding preheating (where required). Cooking temperatures and times are approximate and depend on the amount of food and the type of accessory used. Use the lowest recommended settings to begin with and, if the food is not cooked enough, then switch to higher settings. Use the accessories supplied and preferably dark-coloured metal cake tins and baking trays. You can also use Pyrex or stoneware

pans and accessories, but bear in mind that cooking times will be slightly longer.

COOKING DIFFERENT FOODS AT THE SAME TIME

Using the "Convection Bake" function, you can cook different foods simultaneously (for example: fish and vegetables), on different levels. Remove the food which requires a shorter cooking time and leave the food which requires a longer cooking time in the oven.

MAINTENANCE AND CLEANING

Do not use steam cleaning equipment.

Use protective gloves during all operations.

Carry out the required operations with the oven cold.

Disconnect the appliance from the power supply.

Do not use wire wool, abrasive scourers or abrasive/corrosive cleaning agents, as these could damage the surfaces of the appliance.

EXTERIOR SURFACES

- Clean the surfaces with a damp microfibre cloth. If they are very dirty, add a few drops of pH-neutral detergent. Finish off with a dry cloth.
- Do not use corrosive or abrasive detergents. If any of these products inadvertently comes into contact with the surfaces of the appliance, clean immediately with a damp microfibre cloth.

INTERIOR SURFACES

- After every use, leave the oven to cool and then clean it, preferably while it is still warm, to remove any deposits or stains caused by food residues. To dry any condensation that has formed as a result of cooking foods with a high water content, let the oven to cool completely and then wipe it with a cloth or sponge.

- Activate the "Diamond Clean" function for optimum cleaning of the internal surfaces.
- The door can be easily removed and refitted to facilitate cleaning of the glass.
- Clean the glass in the door with a suitable liquid detergent.
- The top heating element of the grill can be lowered to clean the upper panel of the oven.

ACCESSORIES

Soak the accessories in a washing-up liquid solution after use, handling them with oven gloves if they are still hot. Food residues can be removed using a washing-up brush or a sponge.

LOWERING THE UPPER HEATING ELEMENT

1. Extract the heating element from its seating, then lower it.

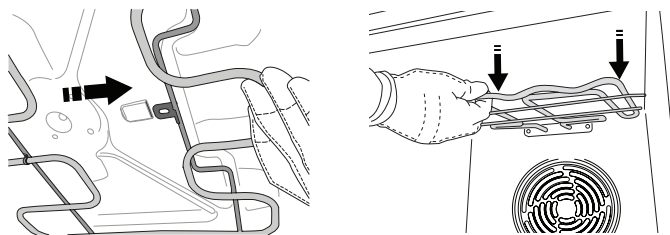

2. To return the heating element to its position, lift it up, pull it slightly towards you and make sure that the tab support is in its proper seating.

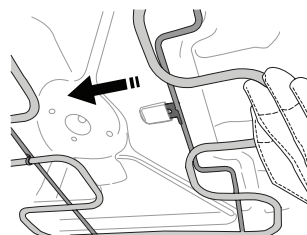

REMOVING AND REFITTING THE DOOR

1. To remove the door, open it fully and lower the catches until they are in the unlock position.

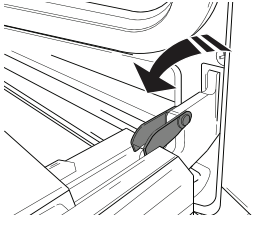

2. Close the door as much as you can. Take a firm hold of the door with both hands – do not hold it by the handle. Simply remove the door by continuing to close it while pulling it upwards (a) at the same time until it is released from its seating (b).

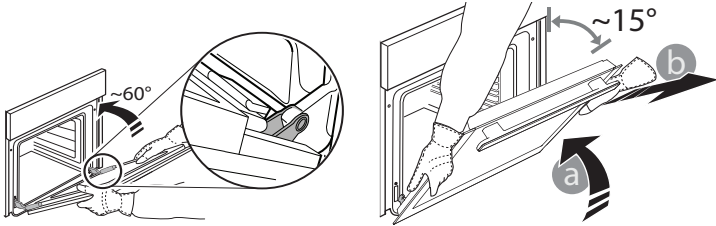

Put the door to one side, resting it on a soft surface.

3. Refit the door by moving it towards the oven, aligning the hooks of the hinges with their seating and securing the upper part onto its seating.

4. Lower the door and then open it fully. Lower the catches into their original position: Make sure that you lower them down completely.

5. Try closing the door and check to make sure that it lines up with the control panel. If it does not, repeat the steps above.

CLICK TO CLEAN - CLEANING THE GLASS

1. After removing the door and resting it on a soft surface with the handle downwards, simultaneously press the two retaining clips and remove the upper edge of the door by pulling it towards you.

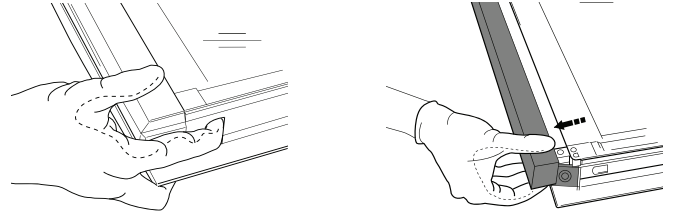

2. Lift and firmly hold the inner glass with both hands, remove it and place it on a soft surface before cleaning it.

3. To reposition the internal glass properly, be sure that the "R" can be seen in the left corner. First insert the long side of the glass indicated by "R" into the support seats, then lower it into position.

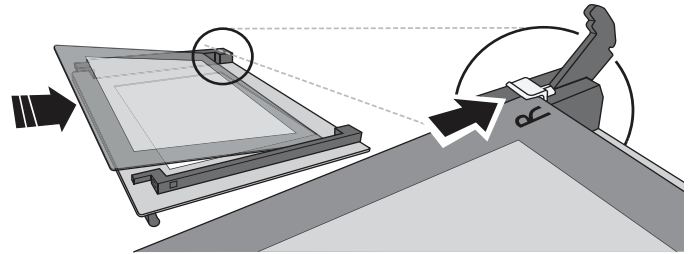

4. Refit the upper edge: A click will indicate correct positioning. Make sure the seal is secure before refitting the door.

Problem	Possible cause	Solution
The oven does not work	Power cut Disconnection from the mains	Check for the presence of mains electrical power and whether the oven is connected to the electricity supply. Switch off the oven and restart it to see if the fault persists

PRODUCT FICHE

The product fiche with energy data of this appliance can be downloaded from the website docs.hotpoint.eu

HOW TO OBTAIN THE USE AND CARE GUIDE

> Download the Use and Care Guide from our website docs.hotpoint.eu (you can use this QR Code), specifying the product's commercial code.



> Alternatively, contact our Client After-sales Service

CONTACTING OUR AFTER-SALES SERVICE

You can find our contact details in the warranty manual. When contacting our Client After-sales Service, please state the codes provided on your product's identification plate.

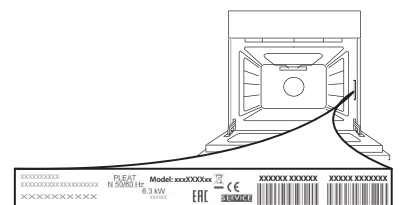

400010873636

Printed in Italy