

Data Projector

Operating Instructions

Before operating the unit, please read this manual and supplied Quick Reference Manual thoroughly and retain it for future reference.

VPL-EW578/EW575/EW455/EW435

VPL-EX575/EX570/EX455/EX450/EX435/EX430

Not all models are available in all countries and area. Please check with your local Sony Authorized Dealer.



Table of Contents

Overview

Location and Function of Controls	4
Main Unit	4
Terminal	5
Remote Commander and Control Panel Keys	7

Preparation

Connecting the Projector	9
Connecting a Computer	9
Connecting a Video equipment	11
Connecting a HDBaseT™ equipment	13
Connecting a microphone	15
Connecting a USB memory device	15
Connecting an External Monitor and Audio Equipment	15

Projecting/Adjusting an Image

Projecting an Image	16
Adjusting the Focus, Size, and Position of the Projected Image	17
Turning Off the Power	22

Adjustments and Settings Using a Menu

Using a MENU	23
The Picture Menu	24
The Screen Menu	25

The Function Menu	29
The Operation Menu	30
The Connection/Power Menu	31
The Installation Menu	34
The Information Menu	35

Network

Using Network Features	36
Displaying the Control Window of the Projector with a Web Browser	36
Confirming the Information regarding the Projector	37
Operating the Projector from a Computer	38
Using the e-mail report Function	38
Setting the LAN Network of the projector	39
Setting the WLAN Network of the projector	39
Setting the Custom Labels for the Input Terminals of the Projector	42
Setting the Control Protocol of the Projector	42

Presentation Function via Network

Using Presentation Function via Network	47
Installing Projector Station for Network Presentation	47
Starting Projector Station for Network Presentation	47

Projecting an Image	48
Connection Settings	49
Using the Controller	50
One-Click projecting function	50
Option format	51
Use Projector Station for Network Presentation without installing it to the computer.	52
Error code list of Projector Station for Projector Station for Network Presentation	53

Index	97
-------------	----

Playing Video and Audio using USB Connection

Playing Video and Audio using USB Connection	54
Starting USB Display	54
Playing Video and Audio	54
Using the Controller	54

USB Media Viewer

Using USB Media Viewer	56
Thumbnail Mode	57
Display Mode	58
Slideshow Mode	58

Others

Indicators	60
Messages List	62
Troubleshooting	63
Replacing the Lamp	66
Cleaning the Air Filter	68
Specifications	69
Projection Distance	76
Dimensions	88
END USER LICENSE AGREEMENT	93

Location and Function of Controls

Main Unit

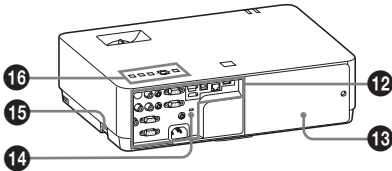
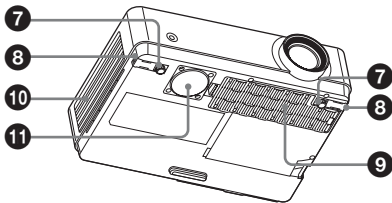
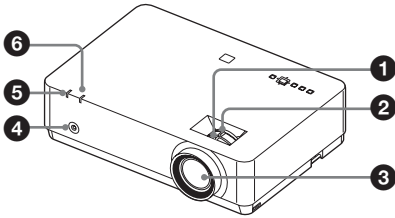

- 1 Focus ring (page 17)
- 2 Zoom ring (page 17)
- 3 Lens
- 4 Remote Control Receiver
- 5 ON/STANDBY indicator (page 60)
- 6 WARNING indicator (page 60)
- 7 Front feet (adjustable) (page 18)
- 8 Foot adjust button (page 18)
- 9 Air filter cover/Ventilation holes (intake) (page 68)

10 Ventilation holes (exhaust)

Caution

Do not place anything near the ventilation holes as this may cause internal heat buildup. Do not place your hand near the ventilation holes and the circumference as this may cause injury.

11 Speaker (VPL-EW578/EW575/ EW455/EW435/EX575/EX455/ EX435 only)

12 Terminal (page 5)

13 Lamp cover (page 66)

14 Security lock

Connects to an optional security cable manufactured by Kensington. For details, visit Kensington's web site. <http://www.kensington.com/>

15 Security bar

Connects to a commercially available security chain or wire.

16 Control panel keys (page 7)

Terminal

VPL-EW578

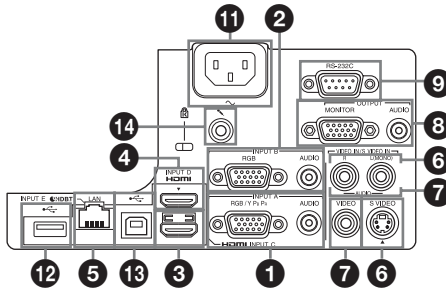

VPL-EW575/EW455/EW435/EX575/EX455/EX435

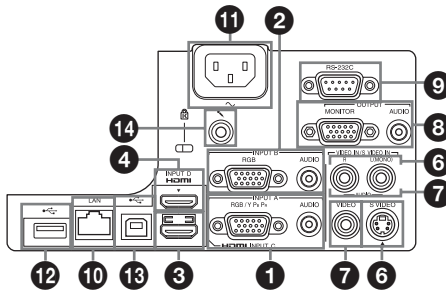

VPL-EX570/EX450/EX430

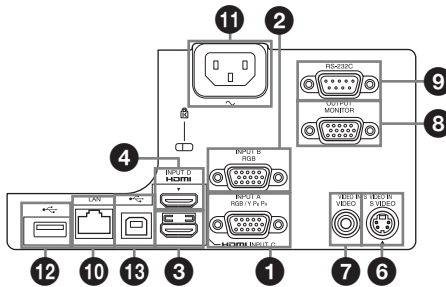

Input (pages 9, 11)

1 INPUT A

Video: RGB/YPbPr input terminal (RGB/YPbPr)
Audio: Audio input terminal (AUDIO)

2 INPUT B

Video: RGB input terminal (RGB)
Audio: Audio input terminal (AUDIO)

3 INPUT C

Video: HDMI input terminal (HDMI)
Audio: HDMI input terminal (HDMI)

4 INPUT D

Video: HDMI input terminal (HDMI)
Audio: HDMI input terminal (HDMI)

5 INPUT E

HDBaseT terminal/LAN terminal
(page 36)

Use a straight CAT5e or CAT6 shielded LAN cable (not supplied).

6 S VIDEO (S VIDEO IN)

Video: S video input terminal (S VIDEO IN)

Audio: Audio input terminal (L (MONO) AUDIO/R)

7 VIDEO (VIDEO IN)

Video: Video input terminal (VIDEO)

Audio: Audio input terminal (L (MONO) AUDIO/R)

Notes

- HDBaseT terminal is available only for VPL-EW578.
- The audio inputs of S VIDEO and VIDEO are shared.
- The audio input terminal and audio output from the HDMI terminal are available only on VPL-EW578/EW575/EW455/EW435/EX575/EX455/EX435.

Output (page 15)

8 OUTPUT

Video: Monitor output terminal (MONITOR)

Audio: Audio output terminal (AUDIO)

Notes

- This terminal outputs the projected image only when INPUT A or INPUT B is used.
- The audio output terminal is available only on VPL-EW578/EW575/EW455/EW435/EX575/EX455/EX435.

Others

9 RS-232C terminal (RS-232C)

RS-232C compatible control terminal. Connects the computer's RS-232C terminal and the RS-232C cross cables.

10 LAN terminal (page 36)

11 AC IN (-) socket

Connects the supplied AC power cord.

12 USB terminal (Type A) () (pages 15, 56)

13 USB terminal (Type B) () (page 54)

14 Microphone input ()

Note

Microphone input is available only on VPL-EW578/EW575/EW455/EW435/EX575/EX455/EX435.

Remote Commander and Control Panel Keys

Remote Commander

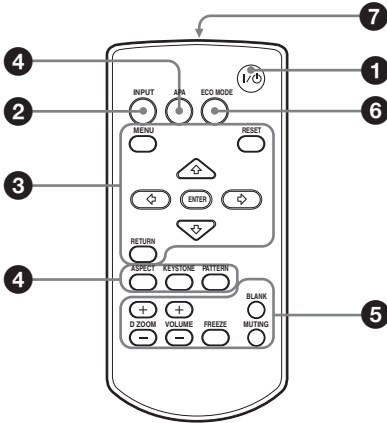

Control Panel Keys

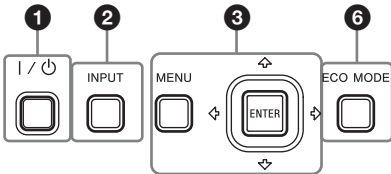

- 1 Turning on the power/Going to standby mode
I/⏻ (On/Standby) key

- 2 Selecting an input signal (page 16)
INPUT key

- 3 Operating a menu (page 23)
MENU key
RESET key
ENTER /▲/▼/◀/▶ (arrow) keys
RETURN key

- 4 Adjusting the image (page 17)
ASPECT key (page 25)
KEYSTONE key (page 19)
PATTERN key (page 21)
APA (Auto Pixel Alignment) key* (page 21)

Note

* Use this key when inputting a computer signal via the RGB input terminal (INPUT A or INPUT B).

- 5 Using various functions during projecting

D ZOOM (Digital Zoom) +/- key*¹
Enlarges a portion of the image while projecting.

1 Press the D ZOOM + key to display the digital zoom icon on the projected image.

2 Press the ▲/▼/◀/▶ keys to move the digital zoom icon to the point on the image you want to enlarge.

3 Press the D ZOOM + key or the D ZOOM - key repeatedly to change the enlargement ratio. The image can be enlarged up to 4 times.

Press the RESET key to restore the previous image.

BLANK key

Cuts off the projected image temporarily. Press again to restore the previous image. Picture muting helps reduce power consumption.

MUTING key*²

Mutes the audio output temporarily. Press again to restore the previous volume.

VOLUME +/- key*²

Adjusts the volume output.

FREEZE key*³

Pauses a projected image. Press again to restore the image.

Notes

- *1: Use this key when inputting a computer signal. But it may not be used depending on the resolution of the input signal.
- *2: VPL-EW578/EW575/EW455/EW435/EX575/EX455/EX435 only.
- *3: Use this key when inputting a computer signal. You cannot use this key when “Type A USB”, “Type B USB” or “Network” is selected as the input.

6 Setting the energy-saving mode easily

ECO MODE key

Energy-saving mode can be set easily. Energy-saving mode consists of “Lamp Mode,” “With No Input,” “With Static Signal” and “Standby Mode.”

- 1 Press the ECO MODE key to display the ECO Mode menu.

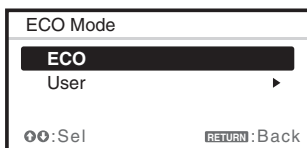

- 2 Press the \uparrow/\downarrow key or ECO MODE key to select “ECO” or “User” mode.
ECO: Sets each mode to the optimum energy-saving value.
Lamp Mode: Low
With No Input: Standby
With Static Signal: Lamp Dimming
Standby Mode: Low
User: Sets each item of the ECO Mode menu as you desire (go to step 3).
- 3 Select “User” then press the \rightarrow key. The setting items appear.

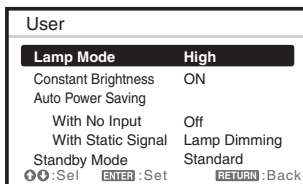

- 4 Press the \uparrow/\downarrow key to select the item then press the ENTER key.
- 5 Press the \uparrow/\downarrow key to select the setting value.
- 6 Press the ENTER key.

The screen returns to the User screen. For details on ECO Mode settings, see “Lamp Mode,” “With No Input,” “With Static Signal” and “Standby Mode” on the Connection/Power menu (page 31).

Note

If you set “ECO Mode” to “ECO,” or “Standby Mode”(in “User”) to “Low,” the network control function will be disabled in standby mode. If the external control is being performed by using the network or network control function, do not select “ECO,” or do not set “Standby Mode” (in “User”) to “Low.”

7 Infrared transmitter

About remote commander operation

- Direct the remote commander toward the Remote Control Receiver.
- The shorter the distance between the remote commander and the projector is, the wider the angle within which the remote commander can control the projector becomes.
- Make sure that nothing obstructs the infrared beam between the remote commander and the Remote Control Receiver on the projector.

Connecting the Projector

Notes

- Make sure all the equipment is powered off when connecting the projector.
- Use the proper cables for each connection.
- Insert the cable plugs firmly; Loose connections may reduce performance of picture signals or cause a malfunction. When pulling out a cable, be sure to grip it by the plug, not the cable itself.
- For more information, refer also to the instruction manuals of the equipment you are connecting.
- Use a no-resistance audio cable.

Connecting a Computer

Connection with a computer is explained for each input signal.

INPUT A/INPUT B

For connecting a computer with an RGB output terminal.

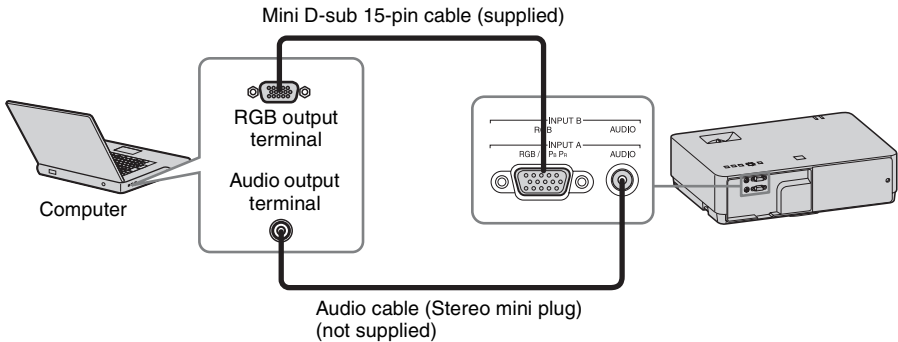

Notes

- The audio input terminal is available only on VPL-EW578/EW575/EW455/EW435/EX575/EX455/EX435.
- In screen setting of your computer, it is recommended that you set the resolution of an external monitor as below;
 - VPL-EW578/EW575/EW455/EW435: 1280 × 800 pixels
 - VPL-EX575/EX570/EX455/EX450/EX435/EX430: 1024 × 768 pixels

INPUT C/INPUT D

For connecting a computer with an HDMI output terminal.

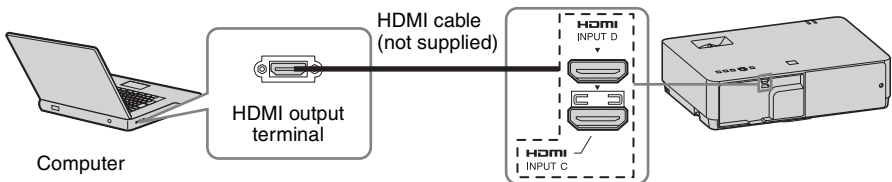

Notes

- Audio output from the HDMI terminal is available only on VPL-EW578/EW575/EW455/EW435/EX575/EX455/EX435.
- Use HDMI-compatible equipment which has the HDMI Logo.
- Use a high speed HDMI cable(s) on which the cable type logo is specified. (Sony products are recommended.)
- The HDMI terminal of this projector is not compatible with DSD (Direct Stream Digital) Signal or CEC (Consumer Electronics Control) Signal.

USB terminal (Type B) (🔌)

For connecting to a computer with a USB terminal (“Playing Video and Audio using USB Connection” (page 54)).

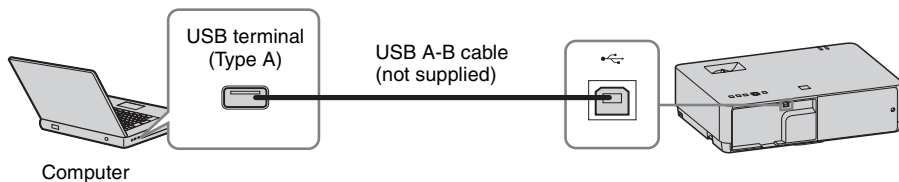

LAN terminal

For connecting to a computer via a hub or router (“Presentation Function via Network” (page 47)).

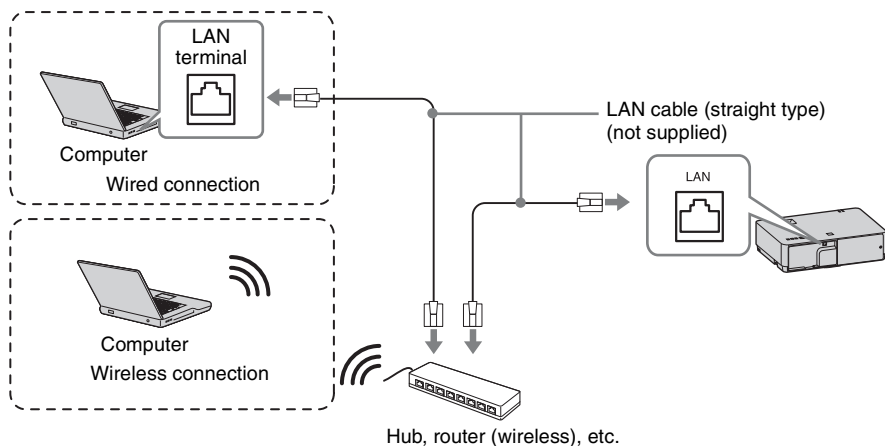

USB terminal (Type A) (🔌)

For connecting a USB wireless LAN module IFU-WLM3 (not supplied) (“Presentation Function via Network” (page 47)).

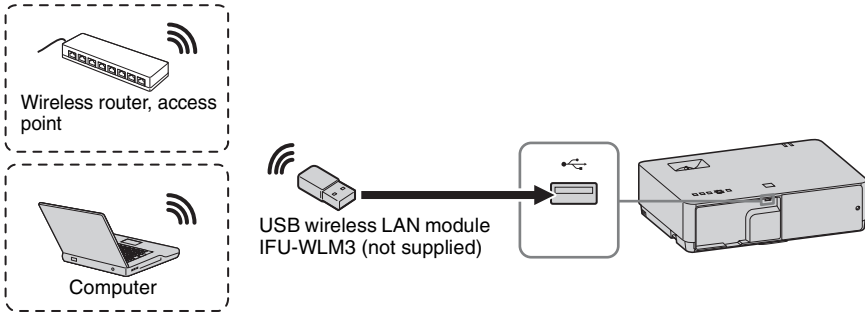

Notes

- Undesignated USB wireless LAN modules do not work.
- When connecting/disconnecting the USB wireless LAN module, make sure that the projector is in Standby mode (Standby Mode: “Low”), or the AC power cord is unplugged from the wall outlet.
- To connect to an access point, access the Web page, and input the settings for the access point to connect to. For details, see “Setting the WLAN Network of the projector” (page 39).

Connecting a Video equipment

Connections with a VHS video deck, DVD player, or BD player are explained for each input signal.

S VIDEO IN

For connecting video equipment with an S-video output terminal.

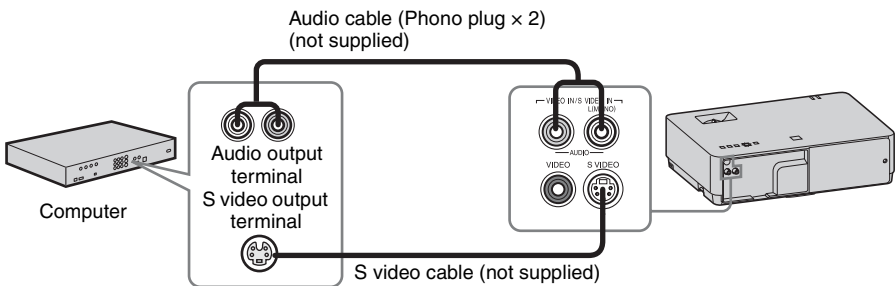

Note

The audio input terminal is available only on VPL-EW578/EW575/EW455/EW435/EX575/EX455/EX435.

VIDEO IN

For connecting video equipment with a video output terminal.

Audio cable (Phono plug x 2 – stereo mini plug) (not supplied)

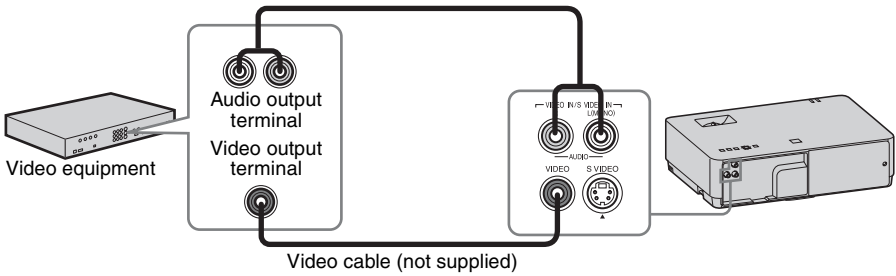

Note

The audio input terminal is available only on VPL-EW578/EW575/EW455/EW435/EX575/EX455/EX435.

INPUT A

For connecting video equipment with a YPbPr output terminal.

Component – Mini D-sub 15-pin cable (not supplied)

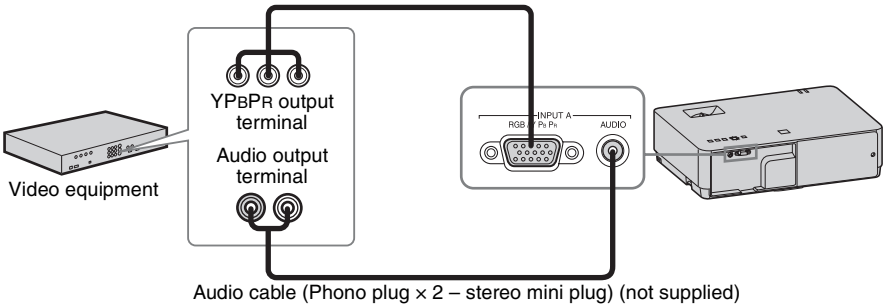

Note

The audio input terminal is available only on VPL-EW578/EW575/EW455/EW435/EX575/EX455/EX435.

INPUT C/INPUT D

For connecting video equipment with an HDMI output terminal.

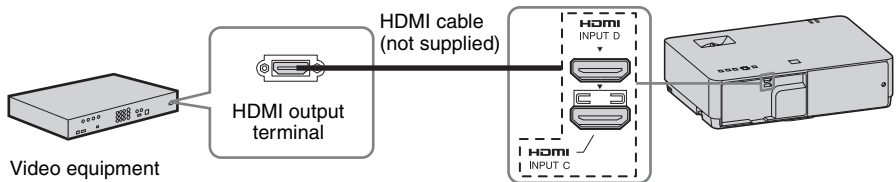

Notes

- Audio output from the HDMI terminal is available only on VPL-EW578/EW575/EW455/EW435/EX575/EX455/EX435.
- Use HDMI-compatible equipment which has the HDMI Logo.
- Use a high speed HDMI cable(s) on which the cable type logo is specified. (Sony products are recommended.)
- The HDMI terminal of this projector is not compatible with DSD (Direct Stream Digital) Signal or CEC (Consumer Electronics Control) Signal.

Connecting a HDBaseT™ equipment

For connecting the computer, video equipment, and network equipment via the HDBaseT transmitter.

Connecting to the computer

INPUT E

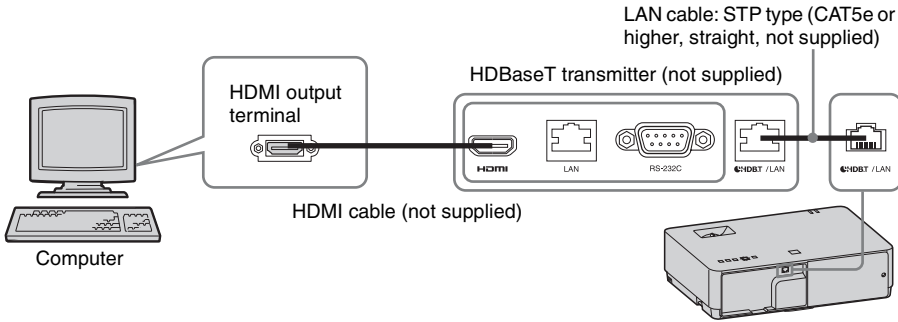

Connecting to the video equipment

INPUT E

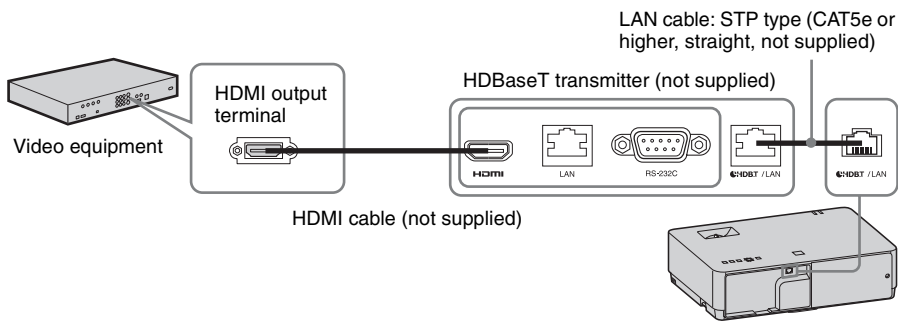

Notes for connecting this unit and the HDBaseT transmitter

- Ask a professional or Sony dealer to perform wiring. If wiring is not correct, the transmission characteristics of the cable will not be achieved, and image or sound may break up or you may experience unstable performance.
- Connect the cable directly to the HDBaseT transmitter without going through a hub or router.
- Use cables that meet the following conditions.
 - CAT5e or higher

- Shielded type (covering connectors)
- Straight wire connection
- Single wire
- When installing the cables, use a cable tester, cable analyzer, or similar device to check if the cables meet the CAT5e or higher requirement. If there is a transit connector between this unit and the HDBaseT transmitter, include it when measuring.
- To reduce the affect of noise, install and use the cable in a manner where it is not rolled up and it is as straight as possible.
- Install the cable away from the other cables (especially the power cable).
- When installing multiple cables, do not bind them and keep the running parallel distance as short as possible.
- The transmittable distance of the cable is 100 m (approx. 328 feet) maximum. If it exceeds 100 m (approx. 328 feet), it may cause the image or the sound to break up, or cause a multifunction in LAN communication. Do not use the HDBaseT transmitter beyond the transmittable distance.
- Inquire about operation or function problems caused by other manufacturer's devices with the relevant manufacturer.

Connecting to the network equipment

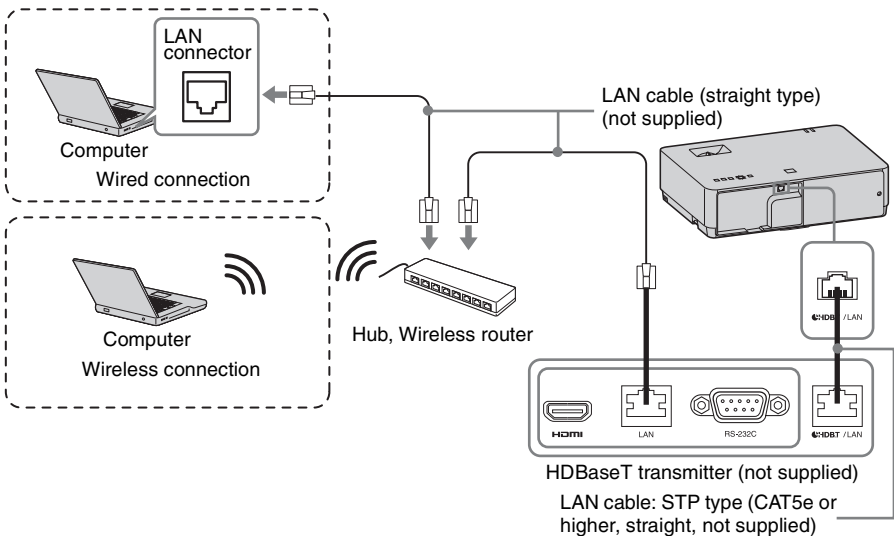

Notes

- HDBaseT is available only on VPL-EW578.
- If you are using a network, make sure “HDBaseT/LAN terminal” is set to “HDBaseT” (page 31).
- Connect this unit and the HDBaseT transmitter without a hub or router between them.

Connecting a microphone

Microphone (🎤)

For connecting a microphone.



Notes

- The microphone input is available only on VPL-EW578/EW575/EW455/EW435/EX575/EX455/EX435.
- Only dynamic microphones are supported.

Connecting a USB memory device

USB terminal (Type A) (🔌)

For connecting a USB memory device (“Using USB Media Viewer” (page 56)).

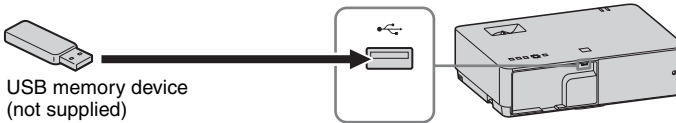

Connecting an External Monitor and Audio Equipment

OUTPUT

Projected images or input audio can be output to display equipment such as a monitor or audio equipment such as speakers with a built-in amplifier.

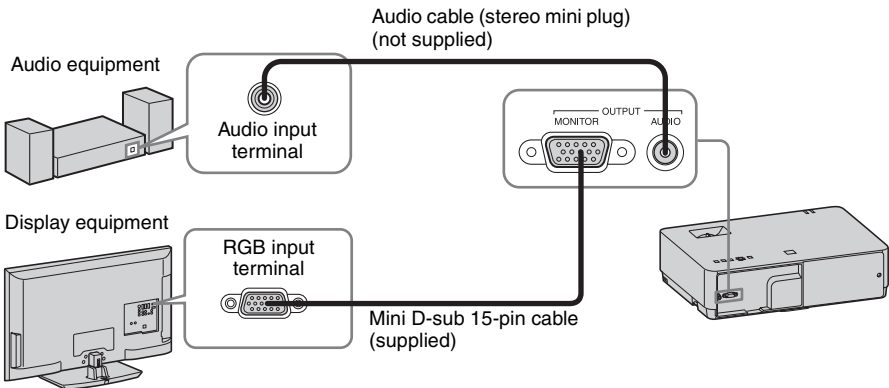

Notes

- The audio output terminal is available only on VPL-EW578/EW575/EW455/EW435/EX575/EX455/EX435.
- Projected images and audio can be output.
- Projected images can be output from INPUT A and INPUT B only.

Projecting an Image

The size of a projected image depends on the distance between the projector and screen. Install the projector so that the projected image fits the screen size. For details on projection distances and projected image sizes, see “Projection Distance” (page 76).

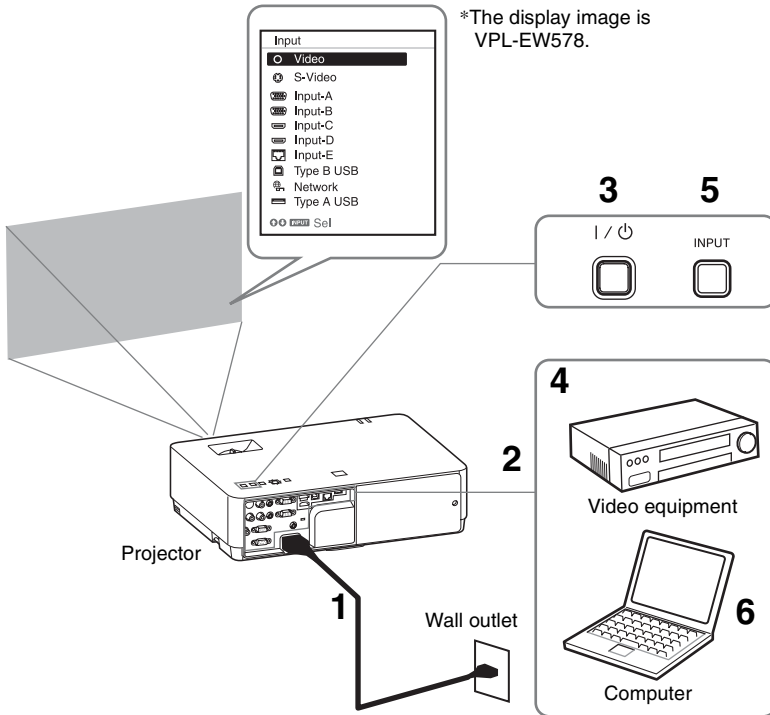

- 1** Plug the AC power cord into the wall outlet.
- 2** Connect all equipment to the projector (page 9).
- 3** Press the I/⏻ key to turn on the unit.
- 4** Turn on the connected equipment.
- 5** Select the input source.
Press the INPUT key on the projector to display the menu for switching input signal on the screen. Press the INPUT key repeatedly, or press the ▲/▼ key to select an image to be projected.

- 6** When projecting a computer image, switch your computer's output to external display.
The method to switch the output varies depending on the type of computer.



(Example)



To project image files stored in a USB memory device, see “USB Media Viewer” (page 56). To play video and audio using USB Connection, see “Playing Video and Audio using USB Connection” (page 54). To use Presentation Function via Network, see “Presentation Function via Network” (page 47).

- 7 Adjust the focus, size and position of the projected image (page 17).

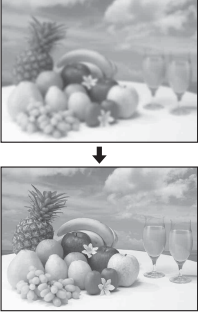
Adjusting the Focus, Size, and Position of the Projected Image

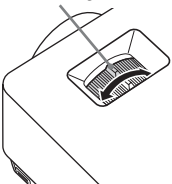
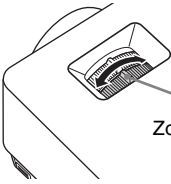
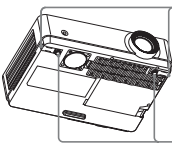
Focus	Size (Zoom)	Position
		
<p data-bbox="157 635 253 655">Focus ring</p> 	 <p data-bbox="591 770 684 791">Zoom ring</p>	 <p data-bbox="910 643 969 707">Foot adjust button</p> <p data-bbox="925 775 1003 818">Front feet (adjustable)</p>

Adjusting the tilt of the projector with the front feet (adjustable)

By changing the tilt of the projector with the foot adjust buttons/front feet (adjustable), you can adjust the position of the projected image.

How to adjust the angle

- 1 Press and hold the foot adjust buttons.
- 2 Lift up the front of the projector to adjust the angle.
- 3 Release the foot adjust buttons.
- 4 Turn the front feet (adjustable) to set the angle of the projector precisely.

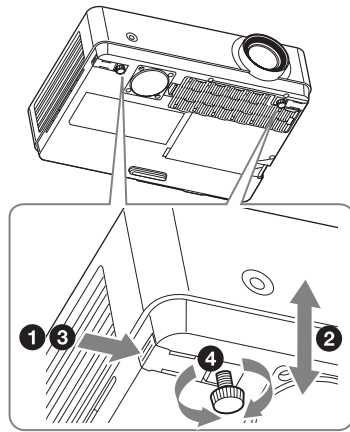

Notes

- Be careful not to let the projector down on your fingers.
- Do not push hard on the top of the projector with the front feet (adjustable) extended.

Changing the aspect ratio of the projected image

Press the ASPECT key on the remote commander to change the aspect ratio of the projected image. You can also change the setting in Aspect of the Screen menu (pages 25, 27).

Correcting trapezoidal distortion of the projected image (Keystone feature)

Normally the Keystone feature automatically adjusts the projected image. The Keystone feature may not work automatically if the screen is tilted. In this case, set Keystone manually.

- 1 Press the KEYSTONE key on the remote commander or select V Keystone in the Installation menu.
- 2 Use the \blacktriangle / \blacktriangledown / \blacktriangleleft / \blacktriangleright keys to set the value. The higher the value, narrower the top of the projected image. The lower the value, the narrower the bottom.

Note

Since the Keystone adjustment is an electronic correction, the image may be deteriorated.

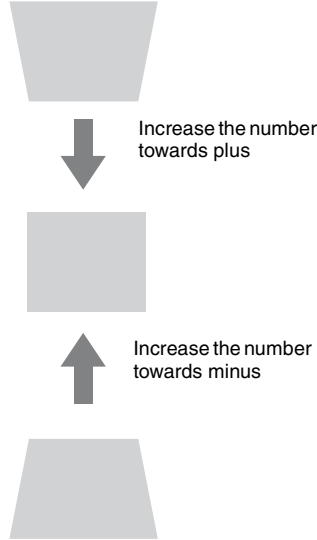

Fitting the projected image to the screen (Digital Shrink adjustment)

If the projected image exceeds the size of the screen, you can shrink and adjust the position of it.

- 1 Select “Rid. digitale” in the Installation menu.
- 2 Set the shrinking rate.
Press the $\uparrow/\downarrow/\leftarrow/\rightarrow$ key to adjust the value. The more the value increases towards the plus side, the smaller the projected image becomes.
- 3 Press the ENTER button to display the shift adjustment menu and adjust the display position of the projected image.
Press the $\uparrow/\downarrow/\leftarrow/\rightarrow$ key to adjust the display position.

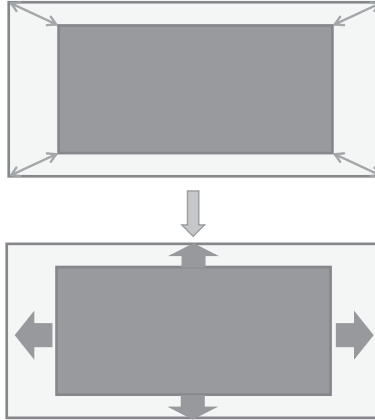

Note

If the shrinking rate is set to “0,” you cannot move the image. If the projector is projecting an image with a resolution that is different from the panel display resolution of this projector, it may not be possible to move the image.

Displaying a pattern

You can display a pattern for adjusting the projected image or a grid pattern with the PATTERN key on the remote commander. Press the PATTERN key again to restore the previous image. You can use a grid pattern as a guide to write text or to draw lines and shapes on the whiteboard or blackboard without using a computer.

Note

You cannot use this key when “Type A USB”, “Type B USB” or “Network” is selected as the input.

Automatically adjusts Phase, Pitch and Shift of projected image while a signal is input from a computer (APA (Auto Pixel Alignment))

Press the APA key on the remote commander. Press again to cancel adjusting during the setting. You can also set APA in the Screen Menu (page 26). If Smart APA in the Function menu is set to “On”, executes APA automatically when a signal is input (page 29).

Turning Off the Power

- 1 Press the **I/⏻** key on the unit or the remote commander.
The projector starts shutdown and turns off. If you press the **I/⏻** key within 10 seconds again, shutdown is cancelled.

Note

Do not turn off the projector soon after the lamp lights. It may cause a malfunction of the lamp (does not light ,etc.).

- 2 Unplug the AC power cord from the wall outlet.

Turning off without displaying the confirmation message

Press and hold the **I/⏻** key on the unit for a few seconds (page 62).

Note

If you turn off the unit soon after the lamp is turned on, the confirmation message will be displayed and may take a longer time for the unit to turn off.

ECO gauge

This gauge indicates the current effectiveness of the projector's ECO function. (For details on the ECO function, see "ECO MODE key" (page 8) and "ECO" (page 32).)

The leaf icons are displayed when the projector is shut down. The number of displayed icons varies according to how much energy is saved as a result of using the ECO function.

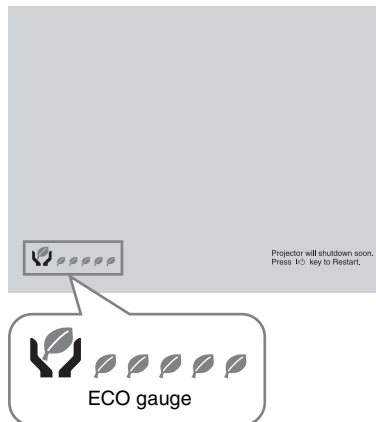

Using a MENU

Note

The menu displays used for the explanation below may be different depending on the model you are using.

- 1 Press the MENU key to display the menu.
- 2 Select the setting menu.
Use the $\blacktriangle/\blacktriangledown$ key to select the setting menu then press the \blacktriangleright key or ENTER key.

Setting menu

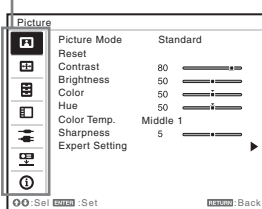

- 3 Select the setting item.
Use the $\blacktriangle/\blacktriangledown$ key to select the setting menu then press the \blacktriangleright key or ENTER key.
To return to the selection screen of the setting menu, press the \blacktriangleleft or RETURN key.

Setting items

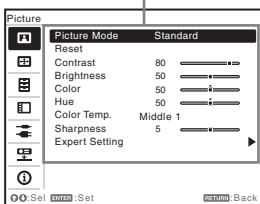

- 4 Make the setting or adjustment for the selected item.
The setting method varies, depending on the setting item.
If the next menu window is displayed, select the item according to the

operations in step 3 and then press the ENTER key to register the setting.
To return to the selection screen of the setting items, press the \blacktriangleleft or RETURN key. You can press the RESET key to reset an item to its factory setting value to aid setting.

Using a pop-up menu

Press the $\blacktriangle/\blacktriangledown/\blacktriangleleft/\blacktriangleright$ key to select an item. A selected item takes effect immediately, except "Language", which will take effect after you press the ENTER key.

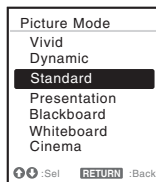

Using the setting menu

Press the $\blacktriangle/\blacktriangledown$ key to select the item. Press the ENTER key to register the setting and return to the previous screen.

Using the adjustment menu

To increase the value, press the $\blacktriangle/\blacktriangleright$ key and to decrease the number, press the $\blacktriangledown/\blacktriangleleft$ key. Press the ENTER key to register the setting and return to the previous screen.

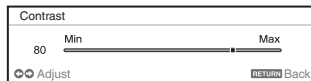

- 5 Press the MENU key to clear the menu.
The menu disappears automatically if no operation is performed.

The Picture Menu

The Picture is used to adjust the picture for each input signal.

Items	Item descriptions
Picture Mode	Vivid: Projects the image with a bright, explicit, and vivid picture. Dynamic: Emphasizes the contrast to produce a dynamic and vivid picture. Standard: Provides an image which is natural and well balanced. Presentation: Provides a bright image, suitable for presentations. Blackboard: Provides an image suitable for displaying on a blackboard. Whiteboard: Provides an image suitable for displaying on a whiteboard. Cinema: Provides an image suitable for viewing movies.
Reset ^{*1}	Resets the factory setting.
Contrast	The higher the value, the greater the contrast. The lower the value, the lower the contrast.
Brightness	The higher the value, the brighter the picture. The lower the value, the darker the picture.
Color ^{*2 *3}	The higher the value, the greater the intensity. The lower the value, the lower the intensity.
Hue ^{*2 *3 *4}	The higher the value, the more greenish the picture becomes. The lower the value, the more reddish the picture becomes.
Color Temp. ^{*5}	High/Middle 1/Middle 2/Low: The higher the value, the more bluish the picture. The lower the value, the more reddish the picture.
Sharpness ^{*6}	The higher the value, the sharper the picture. The lower the value, the softer the picture.
Expert Setting	
Gamma Mode ^{*7}	Graphics1: Gamma correction to make halftones brighter. This setting is suitable when projecting highly colorful images, such as photos, in a bright place. Graphics2: Gamma correction to improve the reproduction of halftones. Highly colorful images, such as photos, can be reproduced in natural tones. Graphics3: Selects gamma correction to emphasize bright parts. Projects images explicitly.

Notes

- *1: The settings in the Picture return to their factory defaults, except for Picture Mode.
- *2: When a video signal is input, this option is available.
- *3: When the signal without color burst signal is input after selecting “Video” or “S-Video”, this option is unavailable.
- *4: When an analog TV signal is input, this option may not available, depending on the color system.
- *5: When “Picture Mode” is set to the item other than “Presentation” or “Blackboard,” this option is available.
- *6: Not available if “Input” is set to “Type A USB.”
- *7: When “Picture Mode” is set to “Blackboard,” this option is unavailable.

The Screen Menu

The Screen menu is used to adjust the size, position and aspect ratio of the projected image for each input signal.

Items	Item descriptions
Aspect ^{*1}	Changes the aspect ratio of the projected image (page 27).
VPL-EW578/EW575/ EW455/EW435: When the computer signal is input	4:3: Displays the image to fit the maximum projected image size with an aspect ratio fixed to 4:3. 16:9: Displays the image to fit the maximum projected image size with an aspect ratio fixed to 16:9. Full 1: Displays the image to fit the maximum projected image size without changing the aspect ratio of the input signal. Full 2: Displays the image to fit the maximum projected image size changing the aspect ratio of the input signal. Full 3: Displays the image to fit the maximum width or height, up to 1280 × 720 pixels, without changing the aspect ratio of the input signal. Normal: Displays the image on the center position of the projected screen without changing the resolution of the input signal or enlarging the image.
VPL-EW578/EW575/ EW455/EW435: When the video signal is input	4:3: Displays the image to fit the maximum projected image size with an aspect ratio fixed to 4:3. 16:9: Displays the image to fit the maximum projected image size with an aspect ratio fixed to 16:9. Full: Displays the image to fit the maximum projected image size changing the aspect ratio of the input signal. Zoom: Zooms the center area of a projected image.
VPL-EX575/EX570/ EX455/EX450/ EX435/EX430: When the computer signal is input	4:3: Displays the image to fit the maximum projected image size with an aspect ratio fixed to 4:3. 16:9: Displays the image to fit the maximum projected image size with an aspect ratio fixed to 16:9. Full 1: Displays the image to fit the maximum projected image size without changing the aspect ratio of the input signal. Normal: Displays the image on the center position of the projected screen without changing the resolution of the input signal or enlarging the image.
VPL-EX575/EX570/ EX455/EX450/ EX435/EX430: When the video signal is input	4:3: Displays the image to fit the maximum projected image size with an aspect ratio fixed to 4:3. 16:9: Displays the image to fit the maximum projected image size with an aspect ratio fixed to 16:9. Zoom: Zooms the center area of a projected image.

Items	Item descriptions
Adjust Signal	Adjusts the image of computer signal. Use this item if the edge of the image is cut and reception is bad.
APA ^{*2} ^{*3}	Automatically adjusts the projected image to an optimum quality when you press the ENTER key (page 7).
Phase ^{*2}	Adjusts the dot phase of the display pixel and the input signal. Set to the value where looks clearest.
Pitch ^{*2} ^{*5}	The higher the value, the wider the horizontal image elements (pitch). The lower the value, the narrower the horizontal image elements (pitch).
Shift ^{*4}	H (Horizontal): The higher the value, the farther right the image is projected on the screen. The lower the value, the image farther left. V (Vertical): The higher the value, the farther up the image is projected on the screen. The lower the value, the image farther down.

Notes

- *1: • Note that if the projector is used for profit or for public viewing, modifying the original picture by switching to the aspect mode may constitute an infringement of the rights of authors or producers, which are legally protected.
- Depending on the input signal, setting items for aspect ratio or some other setting items cannot be set in some cases, or changing the aspect ratio setting may have no effect.
- A part of the image may be displayed in black, depending on the setting item.
- *2: Available when a computer signal is input from the RGB input terminal (INPUT A/INPUT B).
- *3: If the projected image includes large amount of black portion around it, the APA function will not work properly and a part of the image may not be displayed on the screen and also optimum image cannot be obtained, depending on the type of input signal. In this case, adjust the “Phase,” “Pitch,” and “Shift” items manually.
- *4: Available when a computer or a video signal is input from the RGB/YPbPr input terminal (INPUT A).
- *5: When “APA” (page 26) or “Smart APA” (page 29) is performed, the adjusted value for “Pitch” will return to its factory default. If you want to continue using the adjusted value, set “Smart APA” to “Off.”

Aspect

VPL-EW578/EW575/EW455/EW435

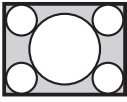
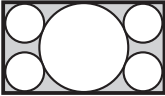
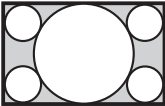
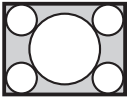
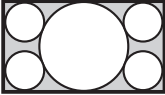
	Input signal	Recommended setting value and projected image
Computer signal	4:3	Full1 *1 *2 *3 
	16:9	Full1 *1 *2 *3 
	16:10	Full1 *3 
Video signal	4:3	4:3 *4 *5 
	16:9	16:9 

*1: If you select “Normal,” the image is projected in the same resolution as the input signal without changing the aspect ratio of the original image.



*2: If you select “Full2,” the image is projected to fit the projected image size, regardless of the aspect ratio of the image.

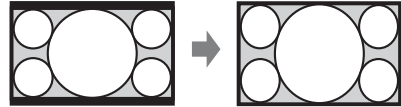

*3: If you adjust the projected image position using an image with 16:9 aspect ratio and then switch the input source to 4:3 image, the top and bottom edge of the image may be hidden. In this a case, select “Full3.”





*4: Depending on the input signal, the projected image may be projected as illustrated below. In this a case, select “16:9.”



*5: Depending on the input signal, the image may be projected as illustrated below. In this a case, select “Zoom.”

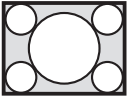
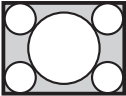
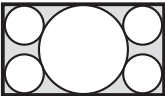
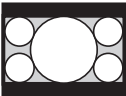
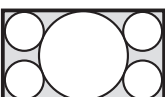
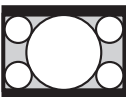
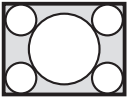
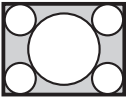

**VPL-EX575/EX570/EX455/EX450/
EX435/EX430**

	Input signal	Recommended setting value and projected image
Computer signal	4:3 	Full1 ^{*1} 
	16:9 	Full1 ^{*1 *2} 
	16:10 	Full1 ^{*1 *2} 
Video signal	4:3 	4:3 ^{*3} 
	16:9 	16:9 ^{*4} 

*1: If you select “Normal,” the image is projected in the same resolution as the input signal without changing the aspect ratio of the original image.



*2: If you select “4:3,” the image is projected to fit the projected image size, regardless of the aspect ratio of the image.



*3: Depending on the input signal, the projected image may be projected as illustrated below. In this a case, select “16:9.”



*4: Depending on the input signal, the projected image may be projected as illustrated below. In this a case, select “Zoom.”



The Function Menu

The Function menu is used for setting various functions of the projector.









Items	Item descriptions
Volume ^{*1}	The higher the value, the louder an audio volume and the lower the value, the lower the audio volume.
Mic Volume ^{*1}	Adjust the volume of the microphone. ^{*2}
Speaker ^{*1}	On/Off: When set to “On,” speaker outputs sound. To not output sound from the speaker, select “Off.”
Smart APA	On/Off: When set to “On,” APA functions automatically when a signal is input. ^{*3}
CC Display	CC1/CC2/CC3/CC4/Text1/Text2/Text3/Text4: Select the closed caption service (captions or text). Off: Closed caption does not appear.
Lamp Timer Reset	When replacing the lamp, resets the lamp timer (page 66).
Start Up Image	On/Off: When set to “On,” the Start Up Image is displayed on the screen when the projector is powered on.
All Reset	Resets all settings to their factory defaults.

Notes

- *1: VPL-EW578/EW575/EW455/EW435/EX575/EX455/EX435 only.
- *2: The maximum available mic volume is set by the value of “Volume.”
- *3: APA functions when a computer signal is input via the RGB input terminal (INPUT A/INPUT B).

The Operation Menu

The Operation menu is used for setting for the operations by using the menu or the remote commander.

Items	Item descriptions
Language	Selects the language used in the menu and messages.
Status	On: All on-screen statuses are enabled. Off: Turns off the on-screen displays, except for menus, warning messages and messages from the message list.
Security Lock ^{*1}	On/Off: This function enables restriction of the projector to authorized users by password. The setting procedures for security locking are as follows: 1 Select "On" and press the ENTER key to display the setting menu. 2 Input the password with the MENU,  ,  ,  ,  and ENTER keys. (The default setting password is "ENTER, ENTER, ENTER, ENTER.") 3 Input a new password with the MENU,  ,  ,  ,  and ENTER keys. 4 Enter the password again to confirm. Enter the password when you turn on the projector after disconnecting and reconnecting the AC power cord. When it is set to "Off," you can cancel the security lock. You are required to input the password again. If you fail to enter the correct password after three consecutive times, the projector cannot be used. In this case, press the I/⏻ key to go Standby mode then turn on the power again.
Control Key Lock	On/Off: When set to "On," locks all the control panel keys of the projector. However, you can operate the following when set to "On": <ul style="list-style-type: none">• Press and hold the I/⏻ key for approximately 10 seconds during Standby mode.<ul style="list-style-type: none">→ The projector turns on.• Press and hold the MENU key for approximately 10 seconds during power on.<ul style="list-style-type: none">→ "Control Key Lock" is set to "Off" and enables operation of all keys on the projector.

Note

*1: You will not be able to use the projector if you forget your password. If you call qualified Sony personnel because you have forgotten the password, you will be asked to verify the projector's serial number and your identity. (This process may differ in other countries/regions.) Once your identity has been confirmed, we will provide you with the password.

The Connection/Power Menu

The Connection/Power menu is used for setting for the connections and power.

Items	Item descriptions
LAN Settings	
IP Address Setup ^{*1}	Auto (DHCP): The IP address is assigned automatically from the DHCP server such as a router. Manual: To specify the IP Address manually.
WLAN Settings	
WLAN Connection ^{*2}	On/Off: Set the wireless output of the USB wireless LAN module (not supplied) to On/Off.
WLAN Network ^{*3}	Access Pt./Client^{*4}: Changes modes for WLAN. ^{*5}
HDBaseT setting	Sets the function of the HDBaseT/LAN terminal. (VPL-EW578 only)
HDBaseT/LAN terminal	HDBaseT: Connecting the HDBaseT transmitter and the LAN cable enables transmitting the signal of the Video, Audio, Ethernet, and RS-232C. LAN: Connecting the LAN cable for Ethernet directly enables connecting to the network. (Use when connecting the cable directly without the HDBaseT transmitter.)
RS-232C setting	Via HDBaseT: You can connect this unit to the RS-232C terminal via the HDBaseT transmitter. (Baud rate: 9600bps) RS-232C terminal: Use when connecting to the RS-232C terminal of this unit directly.
Network Presentation	
Connection CODE	On/Off: This is the presentation function via the network. It controls the connection using the displayed number (CODE) on the right bottom of the screen. During the image transmission, using the ENTER key on the remote commander makes Connection CODE display again.
Display Setting	
LAN Mode	Displays the LAN settings of the projector or the settings of the USB wireless LAN module that operates as a client at the bottom right of the screen. Wired: Displays the IP address of LAN preferentially. Wireless: Displays the IP address of the USB wireless LAN module preferentially.
AP Mode	Displays the SSID of the USB wireless LAN module that operates as an access point at the bottom right of the screen.
Dynamic Range ^{*6}	Sets the image input level of the INPUT C/D/E terminal. ^{*7} Auto: Distinguishes the image input level automatically. Limited: Set when the image input level is 16-235. Full: Set when the image input level is 0-255.

Items	Item descriptions
Input-A Signal Sel.	Auto/Computer/Video GBR/Component: When set to “Auto,” selects the type of video signal input automatically when “Input-A” is selected. *8
ECO	
Lamp Mode	High/Standard/Low/Auto *9 *10: When set to “High,” the image becomes brighter, and power consumption becomes higher. When set to “Low,” power consumption is minimized; however, the image will be darker. When set to “Auto,” brightness is adjusted automatically according to image content. Dark images are projected with brightness adjusted, leading to energy-saving. Bright images are projected brightly, without adjusting brightness.
Constant Brightness	On/Off: Available when the lamp mode is set to High . Outputs light at a certain brightness. *11
Auto Power Saving	
With No Input	Sleep: The lamp turns off automatically and power consumption is reduced if no signal is input for about 10 minutes. The lamp lights again when a signal is input or any key is pressed. In sleep mode, the ON/STANDBY indicator lights in orange (page 60). Even after the power cable is connected to the projector with no signals being input, the projector enters sleep mode.*12 Standby *13: If no signal is input to the unit for about 10 minutes, the power turns off automatically, and the unit enters standby mode. Off: You can deactivate the With No Input.
With Static Signal	Lamp Dimming *9 *10 *14: If an image does not change for about 10 seconds, lamp output is gradually reduced (approximately 10% to 15%*15) from that set in the Lamp Mode. Automatically the lamp slowly darkens to approximately 30% of its lamp output according to the selected time (with no change to input signal) “5,” “10,” “15,” “20” minutes or “ Demo. ,” While dimming the lamp, the message “Lamp Dimming” appears. If you select “Demo.,” the image will start to darken about 40 seconds later. When any change in signal is detected, or an operation (remote control or control panel) is performed, normal brightness is restored. Off: You can deactivate the With Static Signal.
Standby Mode*16	Standard/Low: When set to “Standard,” power consumption becomes higher in Standby mode. For details, see “Power consumption (networked standby mode)” in “Specifications” (page 72).
Direct Power On	On/Off: When set to “On,” you can turn the power on without going to Standby mode when the AC power cord is connected to a wall outlet. With the projector turned off, you can also unplug the AC power cord without going to Standby mode, regardless of the Direct Power On setting.*17

Notes

- *1: To set the IP address manually, select “Manual”, press “Apply”, then enter the IP address.
- *2: Reflecting changes in WLAN settings may take a few moments.
- *3: If the projector cannot connect wirelessly, click [Apply] once again to make sure the connection is established. For details, see “Setting the WLAN Network of the projector” (page 39).



- *4: To change the settings for “Access Pt.,” go to the Web page.
For details, see “Setting the WLAN Network of the projector” (page 39).
If “Access Pt.” is set, it is more convenient that you set “Display Setting” in “Network Presentation” of the projector to “AP Mode” (page 31) in advance when you use Presentation Function via the network (page 47).
- *5: To change the “Client” settings, use the Web page for change. For details, see “Setting the WLAN Network of the projector” (page 39).
- *6: If the image output settings of the HDMI device are not appropriate, the bright parts in the image may become too bright, or the dark ones may become too dark.
- *7: The INPUT E terminal is available on VPL-EW578 only.
- *8: This may not be optimum depending on the input signal. In this case set manually according to the connected equipment.
- *9: This mode does not work for about three minutes after the lamp lights. A change in signal may not be detected depending on the input image. The lamp may become brighter at intervals during lamp dimming. However, this is not a malfunction. If With No Input is set, it takes priority.
- *10: Does not function when “Type A USB”, “Type B USB” or “Network” is selected as the input. In this case, it becomes equivalent to “Standard.”
- *11: Constant Brightness mode will be enabled for about 2,000 hours after it is activated at early usage. After this period, it will be disabled automatically. Activated time and brightness may vary depending on the usage conditions.
- *12: Only when “Direct Power On” is set to “Off” and “Standby Mode” is set to “Standard” at the same time.
- *13: Select “Off” to avoid entering standby mode when there is no input signal.
- *14: As the lamp is dimmed gradually, you may not notice any change in brightness. You might only notice that the lamp has dimmed when its brightness is restored after there is a change in input signal.
- *15: This varies depending on the “Lamp Mode” setting.
- *16: When “Standby Mode” is set to “Low,” the network and network control function cannot be operated while the projector is in standby mode.
- *17: Do not turn off the projector soon after the lamp lights. It may cause a malfunction of the lamp (does not light ,etc.).



The Installation Menu

The Installation menu is used for installing the projector.

Items	Item descriptions
Image Flip	HV/H/V/Off: Flips the projected image horizontally or vertically according to the installation method.
Installation Attitude	Right Side Up/UpSide Down/Link to Image Flip: Change the cooling setting to suit to the installation attitude. When set to “Link to Image Flip,” the cooling setting changes based on the setting of “Image Flip.” Continuing to use the wrong setting may affect component reliability.
High Altitude Mode ^{*1}	On/Off: Set to “On” when using the projector at an altitude of 1,500 m or higher. Continuing to use the wrong setting may affect component reliability.
V Keystone ^{*2}	Auto/Manual^{*2}: The higher the value, the narrower the top of the projected image. The lower the value, the narrower the bottom.
Rid. digitale ^{*3*4}	Shrinks or adjusts the size of the projected image (Digital Shrink). Rid. digitale: Adjusts the size of the projected image. If you set the value to “0”, the image is set to the original size. The shrinking rate is 100% to 90%. Shift: Adjusts the position of the projected image. The adjustable range varies from the shrinking rate.

Notes

- *1: When “High Altitude Mode” is set to “On,” the speed of the fan increases, and the fan noise becomes slightly louder.
- *2: Since the Keystone adjustment is an electronic correction, the image may be deteriorated.
- *3: Since Digital Shrink uses electronic correction, the image may deteriorate.
- *4: If you press the ENTER button while adjusting with Digital Shrink, the projector switches to the shift adjustment.

The Information Menu

The Information menu is used to check projector status, such as total usage time of the lamp.

Items	Item descriptions
Model Name	Displays the model name.
Serial No.	Displays the serial number.
fH/fV ^{*1}	Displays the horizontal/vertical frequency of the current input signal.
Signal Type	Displays the type of the current input signal.
Lamp Timer	Indicates the total usage time of a lamp.

Note

*1: These items may not be displayed depending on the input signal.

Using Network Features

Connection to the network allows you to operate the following features:

- Checking the current status of the projector via a Web browser.
- Remotely controlling the projector via a Web browser.
- Receiving the e-mail report via the projector.
- Making the network settings for the projector.
- Displaying messages on the projected image using an application.
- Supports network monitoring, control protocol (Advertisement, ADCP, PJ Talk, PJ Link, AMX DDDP [Dynamic Device Discovery Protocol], Crestron RoomView).

Notes

- When connecting this projector with the network, consult with the network administrator. The network must be secured.
- The content communicated via a wireless LAN communication may be intercepted due to the use of radio waves. To protect the communication content, implement security measures properly according to the connection environment (page 39).
- When using this projector connected with the network, access the Control window via a Web browser and change the access limitation of the factory preset values (page 37). It is recommended to change the password regularly.
- When the setting on the Web browser is completed, close the Web browser to log out.
- The menu displays used for the explanation below may be different depending on the model you are using.
- Supported Web browsers are Internet Explorer 8/9/10/11.
- The menu displays only in English.
- If the browser of your computer is set to [Use a proxy server] when you access to the projector from your computer, click the check mark to set accessing without using a proxy server.
- To display messages, specific application Projector Station for Network Control (Version 1.1 or later) is necessary. For download or detailed method of using Projector Station for Network Control, please access the following URL.
<http://pro.sony.com/bbsc/ssr/cat-projectors/resource.downloads>
Contact your local Sony dealer for detailed information of Projector Station for Network Control.

Displaying the Control Window of the Projector with a Web Browser

- 1** Connect the LAN cable (page 10).
- 2** Set the network settings for the projector using “LAN Settings” on the Connection/Power menu (page 31).
- 3** Start a web browser on the computer, enter the following in the address field, then press the Enter key on your computer.
`http://xxx.xxx.xxx.xxx`
(xxx.xxx.xxx.xxx: IP address for the projector)

You can confirm the IP address of the projector in the “LAN Settings” on the Connection/Power menu (page 31).

The following window appears in the Web browser:

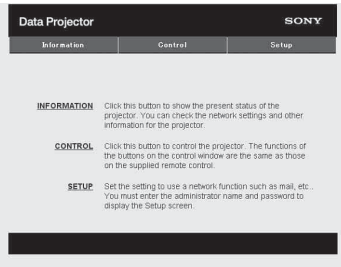

Once you make the network settings, you can open the Control window only by performing step 3 of this procedure.

How to operate the Control window

Switching the page

Click one of the Page Switching buttons to display the desired setting page.

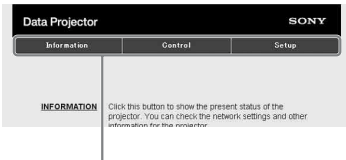

Page Switching buttons

Setting the access limitation

You can limit a user for accessing any particular page.

Administrator: Allowed access to all pages

User: Allowed access to all pages except the Setup page

Set the access limitation from [Password] of the Setup page.

When you access the Setup page for the first time, enter “root” in the Name box and enter “Projector” in the Password box of User.

When you log in for the first time, the window that prompts you to change the password is displayed. Follow the instructions on the screen to change the password.

The Name box of the Administrator is preset to “root.”

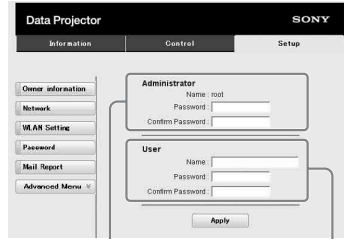
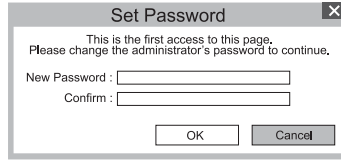

Entry area for [Administrator]

Entry area for [User]

When you change the password, input a new password after deleting the password (*****) that was set.

The password of the administrator and user should be 8 to 16 characters that includes both alphabet and numeric characters. Alphabet is case-sensitive.

The default password “Projector” cannot be set as a new password.

Note

If you forget your password, consult with qualified Sony personnel.

Confirming the Information regarding the Projector

You can confirm the current settings for the projector on the Information page.

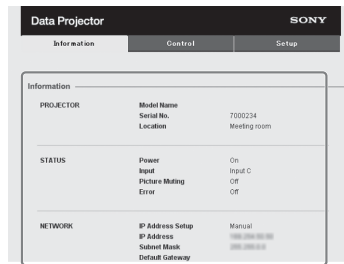

Information area

Operating the Projector from a Computer

You can control the projector from the computer on the Control page.

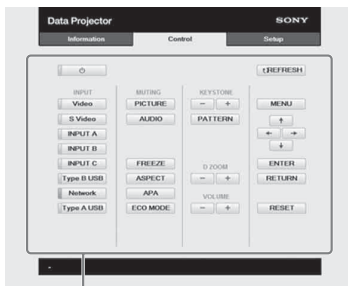

Operation area

The functions of the buttons shown in the operation area are the same as the keys on the remote commander.

Using the e-mail report function

Set the e-mail report function on the Setup page.

Entered values will not be applied unless you click on [Apply].

- 1 Click on [Owner information] to enter the owner information recorded in the e-mail report.

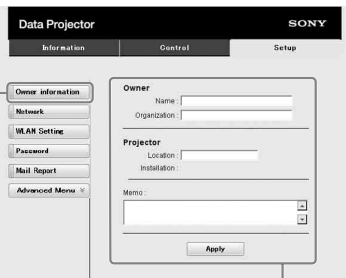

Owner information button

1

- 2 Set the timing of the e-mail report. Click on [Mail Report] to open the Mail Report page.

Lamp Reminder (Lamp1): Set the timing of the email report for lamp replacement. To reset Lamp Reminder, execute “Lamp Timer Reset” on the projector (page 29).

Maintenance Reminder: Set the timing of the email report for maintenance. To reset Maintenance Reminder, check the RESET check box and then click on [Apply].

Mail Report button

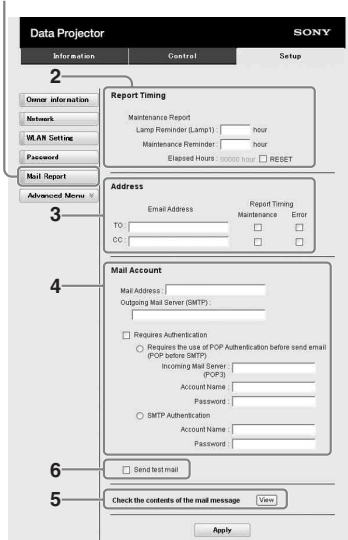

- 3 Enter the outgoing e-mail address in the Email Address box then check the Report Timing check box of the e-mail report to be sent.

- 4 Set the mail account for sending e-mail reports.

Mail Address: Enter the e-mail address.
Outgoing Mail Server (SMTP): Enter the address of outgoing mail server (SMTP).

Required Authentication: Check this check box if authentication is required for sending e-mail.

Requires the use of POP

Authentication before sending email (POP before SMTP): Check this check box to arrange for POP authentication to be performed before sending e-mail.

Incoming Mail Server (POP3): Enter the address of the incoming-mail server (POP3) to be used for POP authentication.

Account Name: Enter the mail account name.

Password: Enter the password.

SMTP Authentication: Check this check box to arrange for SMTP authentication to be performed before sending e-mail.

Account Name: Enter the mail account name.

Password: Enter the password.

5 Confirm the contents of the e-mail report.

When you click on [View], the contents of the e-mail report are displayed.

6 Send the test mail.

Check on the Send test mail check box then click on [Apply] to send your test mail to the e-mail address you set.

Notes

- The email report function will not work if the network uses Outbound Port25 blocking, which prevents access to the SMTP server.
- You cannot use the following characters to enter the characters in the text box: “'”, ““”, “\”, “&”, “<”, “>”

Setting the LAN Network of the projector

Set the LAN network function on the Setup page.

Entered values will not be applied unless you click on [Apply].

1 Click on [Network] to open the Network page.

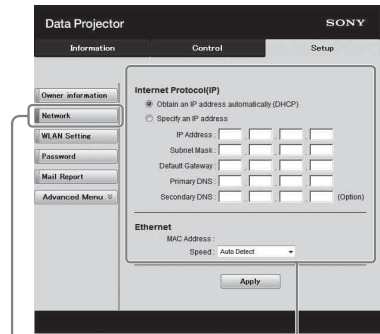

Network button

LAN Network setting area

2 Set the items for internet protocol.

Obtain an IP address automatically:

Automatically provides the network settings by a DHCP server function, such as the router. The IP Address, Subnet Mask, Default Gateway, Primary DNS, and Secondary DNS display the values provided by a DHCP server.

Specify an IP address: Set the network manually.

-IP Address: Input the IP address of the projector.

-Subnet Mask: Input the subnet mask of the projector.

-Default Gateway: Input the default gateway of the projector.

-Primary DNS: Input the primary DNS server of the projector.

-Secondary DNS: Input the secondary DNS server of the projector.

3 Set the items for Ethernet.

MAC Address: Displays the MAC address of the projector.

Speed: Select the network speed of the projector.

Setting the WLAN Network of the projector

Set the WLAN network function on the Setup page.

Entered values will not be applied unless you click on [Apply].

To use the wireless LAN network, a USB wireless LAN module IFU-WLM3 (not supplied) is necessary.

- 1 Click the [WLAN Setting] to open the WLAN Setting page.

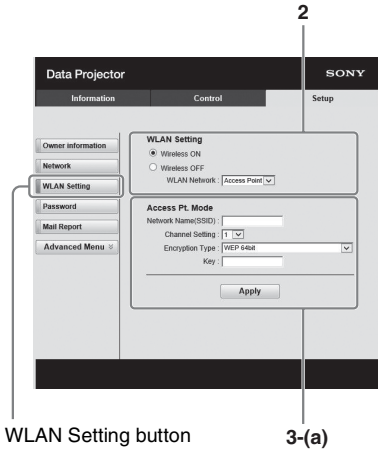

- 2 Enable or disable the radio wave output of USB wireless LAN module.
 - Wireless ON:** Enables radio wave output of USB wireless LAN module.
 - Wireless OFF:** Disables radio wave output of USB wireless LAN module.
 - WLAN Network:** Set the modes for USB wireless LAN module.

Items	Descriptions
Access Point	Activates USB wireless LAN module as an access point. Set the items for WLAN manually.
Client	Activates USB wireless LAN module as a client.

- 3 (a) **Input the settings for Access Point Mode.**
 When the USB wireless LAN module is activated as an access point, set the items for the access point.
 - Network Name (SSID):** Input the SSID of the access point if “WLAN Network” is set to “Access Point” (page 40).
 The factory setting is “VPL + the MAC address of the LAN.”

Channel Setting: Select the channel of the access point if “WLAN Network” is set to “Access Point” (page 40).
Encryption Type: Select the security method of the access point from the followings if “WLAN Network” is set to “Access Point” (page 40).

Encryption Type	Descriptions
Open	Sets the security method of the access point to open system authentication.
WEP 64bit	Sets the security method of the access point to WEP (64bit).
WEP 128bit	Sets the security method of the access point to WEP (128bit).
MIX (WPA-PSK/WPA2-PSK (TKIP/AES))	Sets the security method of the access point to MIX. (corresponding to both WPA-PSK (TKIP/AES) and WPA2-PSK (AES) security methods).
WPA2-PSK(AES)	Sets the security method of the access point to WPA2-PSK (AES).

Key: Input the password for security method of the access point according to the selected encryption type as below;

Encryption Type	Password
Open	The password cannot be input.
WEP 64bit	Input 5 ASCII characters for a password.
WEP 128bit	Input 13 ASCII characters for a password.
MIX (WPA-PSK/WPA2-PSK (TKIP/AES)) or WPA2-PSK (AES)	Input 8-63 ASCII characters for a password.

The factory setting of the security method and its password are set as follows.
 Security method: WEP 64bit
 Password: sonyl

(b) Input the settings for Client Mode.

When the USB wireless LAN module is activated as a client, set the items for the client (set the items for the access point the projector tries to connect to).

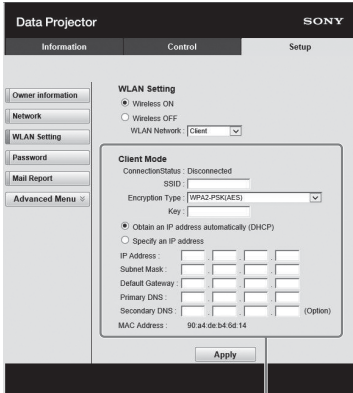

3-(b)

Connection Status: Displays the connecting status between the access point and projector.

SSID: Input the SSID of access point the projector tries to connect to.

Encryption Type: Select the security method of access point the projector tries to connect to from the following list.

Encryption Type	Descriptions
Open	Sets the security method of the access point to open system authentication.
WEP 64bit	Sets the security method of the access point to WEP (64bit).
WEP 128bit	Sets the security method of the access point to WEP (128bit).
MIX (WPA-PSK/WPA2-PSK (TKIP/AES))	Sets the security method of the access point to MIX. (corresponding to both WPA-PSK (TKIP/AES) and WPA2-PSK (AES) security methods).
WPA2-PSK (AES)	Sets the security method of the access point to WPA2-PSK (AES).

Key: Input the password for security method of the access point according to the selected encryption type as below;

Encryption Type	Password
Open	The password cannot be input.
WEP 64bit	Input 5 ASCII characters for a password.
WEP 128bit	Input 13 ASCII characters for a password.
MIX (WPA-PSK/WPA2-PSK (TKIP/AES)) or WPA2-PSK (AES)	Input 8-63 ASCII characters for a password.

Obtain an IP address automatically:

Automatically provides the network settings by a DHCP server function, such as the router. The IP Address, Subnet Mask, Default Gateway, Primary DNS, and Secondary DNS display the values provided by a DHCP server.

Specify an IP address: Set the network manually.

-IP Address: Input the IP address of the projector.

-Subnet Mask: Input the subnet mask of the projector.

-Default Gateway: Input the default gateway of the projector.

-Primary DNS: Input the primary DNS server of the projector.

-Secondary DNS: Input the secondary DNS server of the projector.

MAC Address: Displays the MAC address for USB wireless LAN module.

Setting the Custom Labels for the Input Terminals of the Projector

Change the label names for the input terminals that will be displayed on the projected screen on the Set up page. The entered label names will not be applied unless you click on [Apply].

1 Click on [Advanced Menu] to open the Setup page.

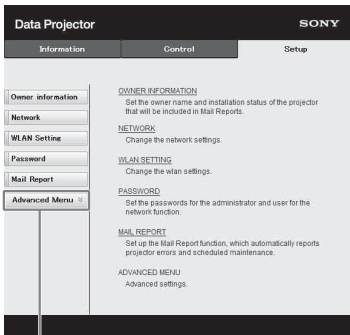

Advanced Menu button

2 Click on the [Input Label] and open the Input label setting window.

Clear the check box for the label that you want to change and input the label name. You can input up to 20 of the following letters.

Alphabets: "a" to "z", "A" to "Z"

Numbers: "0" to "9"

Characters: ".", "@", "_"

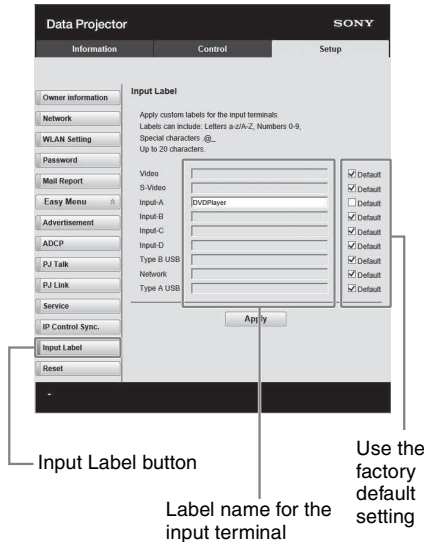

Input Label button

Label name for the input terminal

Use the factory default setting

3 Click the [Apply] button to apply the set label names.

The label name will be reflected on the screen when the input of the projector is changed.

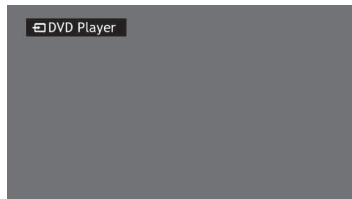

Input Terminal Label Display Screen

Setting the Control Protocol of the Projector

Change the settings for the control protocol on the Setup page. Entered values will not be applied unless you click on [Apply].

- 1 Click on [Advanced Menu] to display the buttons for more settings.

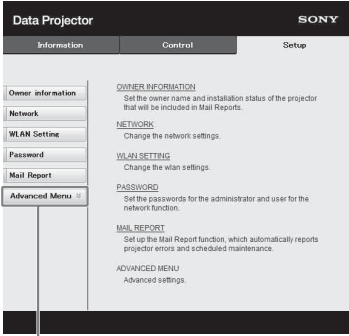

Advanced Menu button

- 2 (a) Set Advertisement.

Advertisement Service setting area

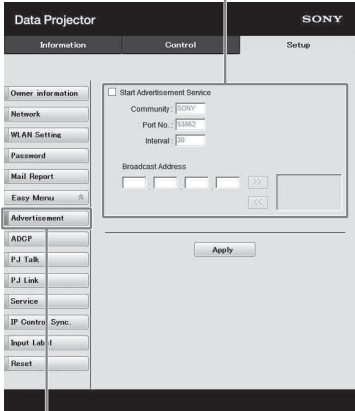

Advertisement button

Start Advertisement Service:

Set Advertisement to enabled or disabled. Items for Advertisement are enabled only when this function is enabled. The function is disabled at the factory default.

-Community:

Input the community name for Advertisement and PJ Talk. If the community name for Advertisement is changed, the one for PJ Talk will also be

changed. Only four alphanumeric characters can be input. The factory default setting is “SONY.” It is recommended that the community name be changed from the factory setting to avoid unnecessary access to the projector from other computers.

-Port No.:

Input the transmit port of Advertisement. The factory default setting is “53862.”

-Interval:

Input the transmission interval (seconds) of Advertisement. The factory default setting is “30.”

-Broadcast Address:

Input the destination of data via Advertisement. If nothing is input, the data will be broadcast in the same subnetwork.

- (b) Set ADCP.

ADCP Service setting area



ADCP button

Start ADCP Service:

Set ADCP to enabled or disabled. Items for ADCP are enabled only when this function is enabled. The function is enabled at the factory default.

-Requires Authentication:

Set the authentication for ADCP to enabled or disabled. The password is the same as that of the Web page administrator.

-Port No.:

Input the server port of ADCP. The factory default setting is “53595.”

-Timeout:

Input the time (seconds) until ADCP communication is terminated in case it is disconnected. The factory default setting is “60.”

-Host Address:

Input the IP address that the ADCP server is allowed to receive. If no IP address is input, receiving commands will be allowed from any IP address. From the moment the IP address is input, access will be allowed only from that input IP address. For security reasons, it is recommended to input an IP address to restrict access.

(c) Set PJ Talk.

PJ Talk Service setting area

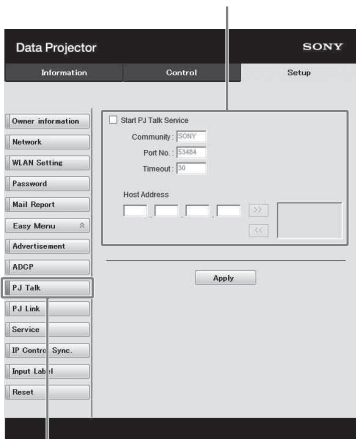

PJ Talk button

Start PJ Talk Service:

Set PJ Talk to enabled or disabled. Items for PJ Talk are enabled only when this function is enabled. The function is disabled at the factory default.

-Community:

Input the community name of Advertisement and PJ Talk. If the community name for PJ Talk is changed, the one for Advertisement will also be changed. Only four alphanumeric characters can be input. The factory

default setting is “SONY.” It is recommended that the community name be changed from the factory setting to avoid unnecessary access to the projector from other computers.

-Port No.:

Input the server port of PJ Talk. The factory default setting is “53484.”

-Timeout:

Input the time (seconds) until PJ Talk communication is terminated in the case that it is disconnected. The factory default setting is “30.”

-Host Address:

Input the IP address that the PJ Talk server is allowed to receive. If no IP address is input, receiving commands will be allowed from any IP address. From the moment the IP address is input, access will be allowed only from that input IP address. For security reasons, it is recommended to input an IP address to restrict access.

(d) Set PJ Link.

PJ Link Service setting area



PJ Link button

Start PJ Link Service:

Set PJ Link to enabled or disabled. Items for PJ Link are enabled only when this function is enabled. This function is disabled at the factory setting.

-Requires Authentication:

Set the authentication for PJ Link to enabled or disabled.

-Password:

Input the authentication password for PJ Link. For the factory default password, refer to the PJ Link specifications.

(e) Set the system service.

System service setting area



Service button

Start DDDP Service:

Set DDDP to enabled or disabled. For details, refer to the DDDP specifications in the reference from AMX Corporation. The function is disabled at the factory default.

Crestron Control:

For details, refer to the specifications in product catalogues, etc., from Crestron Corporation.

-IP Address:

Input the Crestron system server.

-IP ID:

Input the IP ID for the CIP protocol.

-Port No.:

Input the port number for the CIP protocol server.

(f) Set the IP Control Sync. function*1

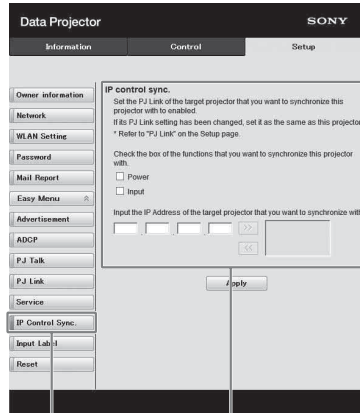

IP Control Sync. button

IP Control Sync. setting area

-Power:

Set to enabled to change the power status of the projector that the unit is trying to synchronize with to the same status on the unit when you turn/off the unit.

-Input:

Set to enabled to change the input connector of the projector that the unit is trying to synchronize with to the same one on the unit when you change the input connector on the unit.*2

-IP Address:

Input the IP address of the projector that the unit is trying to synchronize with.

*1: Enable the PJ Link function of the projector the unit will synchronize with, and then set the authentication and password of PJ Link in the same way as on the unit.

*2: The input connectors may not be changed depending on the projector the unit is trying to synchronize with.

(g) Reset the network settings.

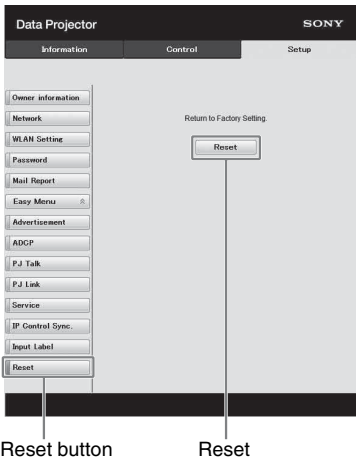

Reset:
Reset all Web browser settings to their factory defaults.

Using Presentation Function via Network

The Presentation Function via Network enables you to do the following:

- Connect a maximum of eight computers to the projector.
- Project images from a maximum of four computers simultaneously.
- Connecting a USB wireless LAN module (not supplied) to the projector as an access point, allows the projector to connect to up to seven computers simultaneously.

Presentation Function via Network requires installation of Projector Station for Network Presentation (supplied CD-ROM). For information on updates of Projector Station for Network Presentation, visit Sony's web site: <https://www.servicesplus.sel.sony.com/>
System requirements for using the application are as follows.

OS

Windows XP: Home/Professional

Windows Vista: Home Premium/Business/Ultimate/Enterprise

Windows 7: Home Premium/Professional (Recommended)/Ultimate/Enterprise

Windows 8/8.1

Mac OS X: 10.6.x/10.7.x/10.8.x/10.9.x/10.10.x

CPU

Pentium4 2.8GHz or faster

Notes

- To install the application, administrative rights are required.
- If you do not have administrative rights, the application may not run properly.
- If firewall or security software is installed, the application may not run properly.
- Depending on the type of network adapter, the application may not run properly.
- Images may not be projected properly depending on the operating environment or the application.

Installing Projector Station for Network Presentation

- 1 Close all running applications.
- 2 Insert the supplied CD-ROM into the CD-ROM drive of the computer.
- 3 Open the CD-ROM.
For Windows:
Double-click the .exe file. When the message "User Account Control" is displayed, click "Allow" or "Yes."
For Mac:
Double-click the .pkg file.
- 4 Follow the on-screen instructions to install the software.

Starting Projector Station for Network Presentation

- 1 Connect the projector to a network.
For a wired connection, connect the projector by a LAN cable, then make the network settings. For details, see "LAN Settings" (page 31) or "Setting the LAN Network of the projector" (page 39).
For a wireless connection, see "LAN terminal" (page 10) or "USB terminal (Type A) (↔)" (page 11). Also check "WLAN Settings" (page 31).
- 2 Turn on the projector.
Select "Network" as the input source (page 16).

3 Start Projector Station for Network Presentation.

For Windows:

Select [Start]-[All Programs]-[Projector Station for Network Presentation] on the computer.

For Mac:

Double-click [Projector Station for Network Presentation] in Applications folder.

Projecting an Image

When you start Projector Station for Network Presentation for the first time after installing to your computer, the connection guidance window will be displayed. This window gives you the information for the necessary settings for connection. Be sure to read it thoroughly. When starting the application after the first time, the connection method selection window will be displayed first. You can check the connection guidance window anytime from the connection method selection window.

For Windows

Connection guidance window



1 Select the connection method.

Refer to the network information on the projected screen of the projector and select “LAN Mode” or “AP Mode.”

LAN Mode: Select this mode if “Display Setting” in “Network Presentation” is set to “LAN Mode” on the projector’s menu. In this mode, the computer connects to the wired LAN of the projector or the USB wireless LAN module of the projector that operates as a client (“WLAN Network” page 31).

AP Mode: Select this mode if “Display Setting” in “Network Presentation” is set to “AP Mode” on the projector’s menu. In this mode, the computer connects to the USB wireless LAN module of the projector that operates as an access point (“WLAN Network” page 31).

For Windows:

Connection method selection window

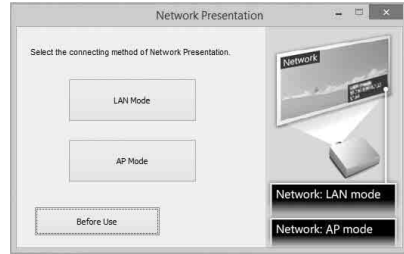

Note

The appearance of the application on the screen is subject to change without notice.

2 Set the projector an image will be projected to.

a) For LAN Mode

Refer to the network information on the projected screen of the projector that you want the computer connect to, and input the IP address and the Connection CODE. If “CODE” is “----”, “Connection CODE” (page 31) is set to “Off.” The computer can connect without inputting “CODE”.

b) For AP Mode

Refer to the network information on the projected screen of the projector that you want the computer connect to, and input the SSID and the Connection CODE. If “CODE” is “----”, “Connection CODE” is set to “Off.” The computer can connect without inputting “CODE”. If the wireless password is set for the SSID (“Setting the WLAN Network of the projector” on page 39), the wireless password input window will be displayed while the computer is trying to connect. Input the password to connect. To prevent information leaks, the wireless password is not displayed on the projected screen.

Network Presentation LAN mode

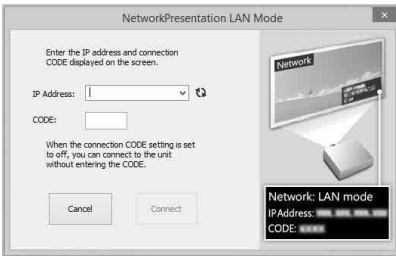

Network Presentation AP mode

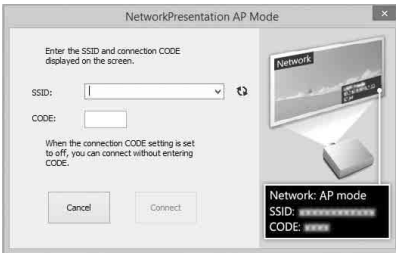

Wireless password input window



Notes

- When a projector is connected to a network via a wireless connection, if the “SSID” is changed from the factory default, it may not be found.
- When a projector is connected to a network via a wired connection, depending on the network environment, it may not be found.

3 Click “Connect”.

When you click the “Connect” button, a controller will be displayed on the screen of the computer and the computer starts projecting an image (page 50). If another user is projecting an image, click  to start projecting. If no users are projecting an image, the controller appears on the screen and starts projecting an image.

Notes

- Display related settings (such as your computer’s resolution) change when the image projection is started.
- If “Input” is set to other than “Network” (page 16), the image will not start being projected even after you press the “Connect” button. If you want to project the image, select “Network” to change the display status.

Connection Settings

Item	Item descriptions
IP Address	Input the IP Address. List the IP addresses of the projectors on the network and IP addresses of projectors connected so far, as candidates.
SSID	Input SSID. List the peripheral SSIDs and SSIDs of projectors connected to the computer so far, as candidates.
 Update button	Search the network again and update the candidate list of the projectors.

Item	Item descriptions
Wireless Password	Input the wireless password of the SSID. If open system authentication is used, input of the wireless password is unnecessary.
CODE	Input the Connection CODE displayed on the screen of the projector.
Connect	Connect to the projector that is set in the items above and start to project an image.

Using the Controller

For Windows:

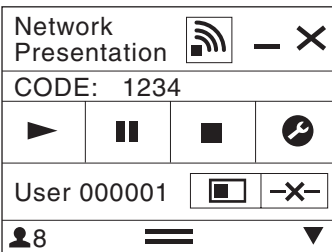

For Mac:

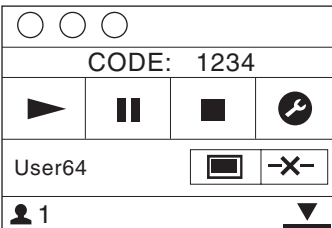

Items	Functions
	Start projecting an image.
	Pause projecting an image.
	Stop projecting an image (screen turns black).
	Change the application settings.
	Disconnect from the projector.
	Select a projection method then start projecting an image.

Items	Functions	
Projection method		Not projecting an image.
		Project in full screen.
		Project in the left half of the screen.
		Project in the right half of the screen.
		Project in the upper left quadrant of the screen.
		Project in the upper right quadrant of the screen.
		Project in the lower left quadrant of the screen.
		Project in the lower right quadrant of the screen.
	Display the strength of the wireless signal.	
CODE	Display the Connection CODE of the projector that is connected to the computer.	
	Display the number of users connected to the projector.	
	Display the users' status.	

One-Click projecting function

Projector Station for Network Presentation allows you to create a shortcut that registers the connection setting.

By starting the application with the shortcut, you can project the image to the registered projector.

1 Create a file.

For Windows

Create a shortcut to the NetworkPresentation.exe. Copy the shortcut to the Projector Station for Network Presentation, or right-click the NetworkPresentation.exe in the installed folder to select "Create shortcut" from the pop up menu.

For Mac

Create a text file with any name with a text editor. Set the format to "Plain Text."

2 Register the connection setting.

For Windows

Register the settings. Right-click the created shortcut and select “Properties” from the pop up menu.

Input the settings of the projector that you want the computer to connect to in “Target” from the “Shortcut” tab and save. For the format for the settings, refer to the command formats in the option format.

For Mac

Input the settings of the projector that you want the computer to connect to in the created text file and save.

Refer to the command format in the option format to input settings.

Right-click the created text file and select “Get Info” from the context menu. Change the extension of the filename that is displayed on “Name & Extension” to “.npr”.

Option format

Command format

For LAN Mode

- connect [IP address]:[CODE]:[Display Setting]

For AP Mode

- wifi [SSID]:[Wireless password]:
[CODE]:[Display Setting]

Item	Description
IP address	Assign the IP address of the projector that you want the computer to connect to.
SSID	Assign the SSID of the projector that you want the computer to connect to.
Wireless password	Assign the wireless password for the SSID. If the security method is open system authentication, input “open.” If the USB LAN wireless module setting is set to “Access Pt. (Auto),” input “auto.”*1

Item	Description
CODE	Assign the settings of the Connection CODE of the projector. on: Displays the dialogues for inputting the Connection CODE when the computer is trying to connect to the projector. off: Does not display the dialogues for inputting the Connection CODE when the computer is trying to connect to the projector. If “Connection CODE” of the projector is set to “On”, an authentication error occurs.
Display setting	Sets the status for when the projector starts projecting an image. 0: Does not display an image when the computer starts projecting an image. You need to start projecting an image with the controller. 1: Displays an image when the computer starts projecting an image.

*1: “Access Pt. (Auto)” can be selected on the compatible models only. This model is not compatible for the settings of “Access Pt. (Auto).”

Command Examples

Example 1)

If the settings of the projector that you want the computer to connect to are set as below and you want to display an image when the computer starts connecting to it

Network: LAN Mode
IP address: 192.168.1.187
Connection CODE: On

For Windows

```
C:\Program Files (x86)\Sony\Projector
Station for Network Presentation\Network
Presentation.exe -connect 192.168.1.187:on:1
```

For Mac

```
-connect 192.168.1.187:on:1
```

Example 2)

If the settings of the projector that you want the computer to connect to are set as below and you want to display an image when the computer starts connecting to it

Network: AP Mode
SSID: VPL012ABC
Wireless password: sony1
Connection CODE: Off

For Windows

```
C:\Program Files (x86)\Sony\Projector Station for Network Presentation\Network Presentation.exe -wifi VPL012ABC:sony1:off:1
```

For Mac

```
-wifi VPL012ABC:sony1:off:1
```

Use Projector Station for Network Presentation without installing it to the computer.

Projector Station for Network Presentation also has a portable version that can be used with external media, such as a USB mass storage device. Although some functions are limited, you can put and carry the Projector Station for Network Presentation in the external media, and use it on other computers.

1 Open the supplied CD-ROM.

For Windows

Double-click the “PJS_NetworkPresentationP_XXX.exe” file. If the User Account Control window is displayed, click “Allow” or “Yes.”

For Mac

Double-click the “PJS_NetworkPresentationP_XXX.pkg” file.

2 Follow the instructions in the wizards to install the application software.

3 Start the Projector Station for Network Presentation.

For Windows

Double-click the shortcut icon of Projector Station for Network Presentation that is created in the folder in which the application is installed.

For Mac

Double click “Projector Station for Network Presentation” in the folder in which the application is installed.

Notes

- You can use this application only on the OS that supports this application.
- Make sure Projector Station for Network Presentation is not operating before installing the application.
- Make sure the external media that the application will be installed to has access rights and all files in the external media are closed.

Error code list of Projector Station for Projector Station for Network Presentation

Error code	Meaning/Measure	Page
NPR-E1701	Failed while opening the WLAN device of the computer. Check that the WLAN function of the computer operates normally.	39
NPR-E1702	Failed while scanning the access point. Check that the WLAN function of the computer operates normally.	39
NPR-E1703	Failed while getting information of the access point. Check the WLAN function of the computer, and if multiple WLAN networks exist.	14, 39
NPR-E1704	Cannot find the access point. Check if devices are connected correctly, the input SSID is correct and the projector is turned on.	16, 51
NPR-E1705	Tried but failed while connecting using WEP64 bit or WEP128 bit. Check that the security setting of the WLAN function of the projector is correct.	51
NPR-E1706	Tried but failed while connecting using MIX (WPAPSK/WPA2-PSK (TKIP/AES)), WPA2-PSK (AES). Check that the security setting of the WLAN function of the projector is correct.	51
NPR-E1707	A security setting other than WEP 64bit, WEP 128bit, MIX (WPAPSK/WPA2-PSK (TKIP/AES)), WPA2-PSK (AES) is applied. Check that the input SSID and the security setting of the WLAN function of the projector are correct.	14, 51
NPR-E1708	Failed to acquire the network profile. Check if the WLAN function of the computer operates normally.	–
NPR-E1709	Succeeded in authenticating the access point, but failed while associating. Check if multiple WLAN networks exist, or if the status of the projector changed while the computer tried to connect to the projector.	–
NPR-E1802	Failed while getting the IP address after connecting to the access point. Check the input SSID, security password and the setting of the security software of the computer.	–
NPR-E1803	Succeed in connecting to the access point, but failed while getting the information. Check the setting of the security software of the computer.	–
NPR-E1804	Connected to a different SSID (access point) from the one you assigned. Start from the connection setting again.	49
NPR-E2101	Cannot receive a response from the projector. The response may be blocked or the network may have been disconnected from the projector while communicating. Check the setting of the security software of the computer, the power status and the network composition of the projector.	–

Playing Video and Audio using USB Connection

You can also play video and audio simply by connecting the projector and computer with a USB A-B cable (not supplied).

Playing video and audio using USB connection requires to start USB Display. System requirements for using the application are as follows.

OS

Windows XP: Home/Professional (recommended)

Windows Vista: Home Premium/Business/Ultimate/Enterprise

Windows 7: Home Premium/Professional (Recommended)/Ultimate/Enterprise

Windows 8/8.1

Mac OS X: 10.6.x/10.7.x/10.8.x/10.9.x/10.10.x

CPU

Pentium4 2.8GHz or faster

Starting USB Display

- 1 Connecting the projector and your computer with a USB A-B cable (not supplied) (page 10).
- 2 Turn on the projector.
Select “Type B USB” as the input source (page 16). After a short time, the projector is recognized as a CD-ROM drive in the computer.
- 3 Open “USB Display” in the CD-ROM drive.

Notes

- The resolution of your computer changes when the application is started.
- Depending of the computer’s setting, the application may start automatically.
- When you are finished using the projector, you can simply disconnect the USB cable without using the Safely Remove Hardware option.
- Images may not be projected properly depending on the operating environment or the application.
- If your OS is Windows Vista, Windows 7 or Windows 8, turning off the Windows Aero is recommended.

Playing Video and Audio

After starting USB Display, the controller appears on the screen, and projection playback starts automatically.





Using the Controller

For Windows:

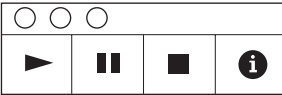

For Mac:



Items	Functions
	Start projecting audio/video.
	Pause projecting audio/video.
	Stop projecting audio/video (the screen turns black).
	Display information about USB Display.

Using USB Media Viewer

You can browse image files stored in a USB memory device inserted in the USB terminal of the projector, without using a computer.

Supported storage media and file format:

- Supported storage media: USB flash memory
- Supported format of storage media: FAT format
- Supported file format: JPEG (.jpg/.jpeg), Bitmap (.bmp), PNG (.png), GIF (.gif), TIFF (.tif/.tiff)

Notes

- exFAT, NTFS are not supported.
- TIFF files containing EXIF information are not supported.
- Image files in a USB memory device connected to the projector via a USB hub may not be displayed.
- Security protected USB memory may not function correctly.
- A USB memory card reader that is recognized as more than one drive may not function correctly.
- Display of image files that are larger than 4092 × 3072 pixels is not guaranteed. It may take a long time to display, or may not be displayed.
- A folder with a deep folder structure or with a very long folder name may not be displayed.
- An image may not be displayed, depending on its file type.
- Files or folders with names including non-alphanumeric characters may not be displayed.
- When displaying an image file, do not disconnect the USB memory device. It may cause a malfunction of the USB memory device or the projector. Disconnect the USB memory device when the USB Memory device selection screen is displayed.

- 1** Connect a USB Memory device to the projector (page 15).
- 2** Select “Type A USB” as the input source (page 16).
- 3** Select the USB Memory device.

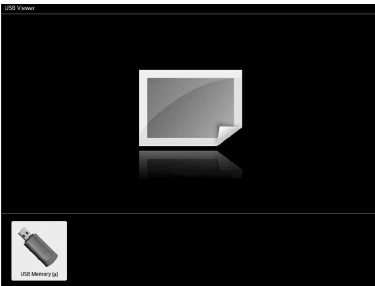

Press the ENTER key to display in the thumbnail mode.

USB Media Viewer has three display modes: “thumbnail mode,” “display mode” and “slideshow mode.”

Thumbnail Mode

The image files in the folder are displayed as a thumbnail list.











Option menu

Press the $\uparrow/\downarrow/\leftarrow/\rightarrow$ key on the remote commander to select an image, then press the ENTER key. The option menu appears in the lower part of the screen.

Option Menu

You can select the display order of thumbnails and display method of image files.

Items	Item descriptions
	Hide the option menu.
	Switch to the display mode, and display the selected image in full screen view. (page 58)
	Switch to the slideshow mode, and start the slideshow from the selected image. (page 58)
	Sort image files.
	Sort by name in alphabetical order.
	Sort by name in reverse alphabetical order.
	Sort by date in chronological order.
	Sort by date in reverse chronological order.

Notes

- Files without thumbnail data (including those created by an application) appear as blank icons.
- Cannot display more than 200 image files and folders in one folder.

Display Mode

In display mode, you can view a selected image in full screen view.



Option menu

Press the ENTER key on the remote commander. The option menu appears in the lower part of the screen.

Option Menu

Items	Item descriptions
	Hide the option menu.
	Return to the thumbnail mode (page 57).
	Rotate the image 90 degrees counter-clockwise.
	Rotate the image 90 degrees clockwise.
	Switch to the slideshow mode, and start the slideshow from the selected image. (page 58)
	Display the previous image.
	Display the next image.

Slideshow Mode

In slideshow mode, you can view images as a slideshow.



















Option menu

Press ENTER key on the remote commander. The slideshow pauses and the option menu appears in the lower part of the screen.



Option Menu

Items	Item descriptions
	Hide the option menu.
	Return to the thumbnail mode (page 57).
	Display the previous image.
	Display the next image.
	Press the ▲/▼ key to change the slideshow time interval.
	After 3 seconds, display the next image.
	After 5 seconds, display the next image.
	After 10 seconds, display the next image.
	Press the ▲/▼ key to change the slideshow effect.
	The next image appears with tile transition effect.
	The next image appears from the left side of the screen.
	The next image appears from the right side of the screen.
	The next image appears from the top of the screen.
	The next image appears from the bottom of the screen.
	Press the ▲/▼ key to change the slideshow repeat setting.
	After displaying the last image, the slideshow starts from the first image again.
	After displaying the last image, the slideshow ends and returns to the thumbnail mode.

Indicators

You can check the projector status or abnormality by checking the lighting/flashing status of the ON/STANDBY indicator and WARNING indicator on the front. If the indicators flash in red, address the problem in accordance with “Warning indicators and remedies” (page 61).

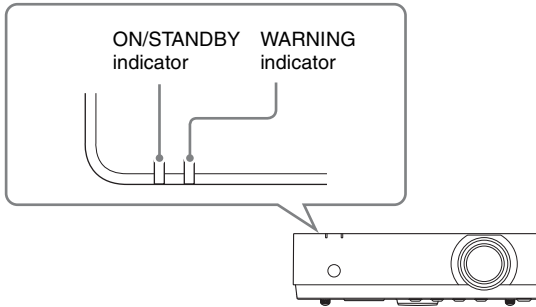

Operating status indication

Indicator status	Operating status	Meaning
<p>(Lights in red) (Off)</p>	Standby	The power is supplied to the projector and the projector is in a standby mode according to the setting.
<p>(Flashes in green) (Off)</p>	Warm-up/Cool-down	The projector is warming up after it is turned on, or cooling down after turned off.
<p>(Lights in green) (Off)</p>	Power on	The projector is ready for projection.
<p>(Lights in orange)(Off)</p>	Other standby status	The projector is in With No Input (Sleep).

Warning indicators and remedies

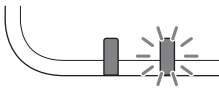
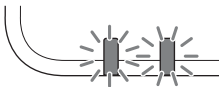
Indicator status	The number of flashes	Meaning	Remedies
 (Lights in red) (Flashes in red)	Twice	The lamp cover is not attached securely.	Check how the lamp cover is attached and install securely.
	Three times	The lamp does not light properly.	<p>The temperature of the lamp is unusually high. Turn off the projector and turn it on again after the lamp has cooled. If the same symptom occurs, turn off the projector again and remove the lamp (page 66), then check if the lamp is not broken.</p> <p>If the lamp is not broken, reattach the lamp and turn on the projector again.</p> <p>If the symptom occurs again, the lamp may be exhausted. In this case, replace the lamp with a new one (page 66).</p> <p>If the lamp is broken, do not exchange the lamp by yourself. Consult a qualified Sony consultant.</p>
 (Flashes in red) (Flashes in red) Both indicators flash	Twice	The temperature in the projector is abnormal.	<ul style="list-style-type: none"> • Check if the air filter is clogged, then clean or replace it (page 68). • Check if the ventilation holes (intake/exhaust) are not blocked by the wall or an object and secure a sufficient gap. • Check the ambient temperature and use the projector within the range of operating temperature.

If the indicators flash in a manner other than described above, unplug the AC power cord and make sure the ON/STANDBY indicator turns off, then plug the AC power cord into the wall outlet and turn on the projector.

If the problem still persists, consult with qualified Sony personnel.



Messages List

When any of the messages listed below appears on the projected image, address the problem in accordance with the table below.

Messages	Meaning/Remedy	Page
High temp.! Lamp off in 1 min.	Check the items below. <ul style="list-style-type: none"> • Check if nothing is blocking the ventilation holes. • Check if the air filter is not clogged. • Check if the Installation Attitude in the Installation menu is set correctly. 	4, 34, 68
Frequency is out of range!	Change the output setting of the connected equipment to one for signals supported by the projector.	75
Please check Input-A Signal Sel.	Set “Input-A Signal Sel.” to “Auto” or select the input signal type to suit to the input signal.	32
Please clean the filter.	Clean the air filter.	68
Please replace the Lamp and clean the Filter.	Replace the lamp with a new one and clean the air filter. The message appears whenever you turn on the power until you replace the lamp and reset the lamp timer.	66, 68
Projector temperature is high. High Altitude Mode should be “On” if Projector is being used at high altitude.	When not using the projector at an altitude of 1,500 m or higher, check the items below. <ul style="list-style-type: none"> • Check if nothing is blocking the ventilation holes. • Check if the air filter is not clogged. • Check if Installation Attitude in the Installation menu is set correctly. 	4, 34, 68
Not applicable!	Invalid key was pressed.	–
The control keys are locked!	“Control Key Lock” is set to “On.”	30
Projector lamp will cut off soon. Press I/⏻ key to restart.	The I/⏻ key was pressed and the projector lamp will be cut off soon. To cancel lamp cut off, press the I/⏻ key again (the projector will return to the on status). To cut off the lamp immediately, press and hold the I/⏻ key for several seconds.	22
Lamp Dimming	Reduces lamp output when “With Static Signal” is set. When any change in signal is detected, or an operation (remote control or control panel) is performed, normal brightness is restored.	32
Unsupported USB device.	Connect the designated USB device (USB wireless LAN module IFU-WLM3 (not supplied)).	11
Unsupported USB hub.	The projector does not support USB hubs. Connect the designated USB device (USB wireless LAN module IFU-WLM3 (not supplied)).	11
Please check HDBaseT Settings. (VPL-EW578 only)	Set “HDBaseT/LAN connector” depending on the HDBaseT/LAN connection.	31

Troubleshooting

Before asking to have the projector repaired, try to diagnose the problem, following the instructions below.

Symptoms	Remedy	Page
The power is not turned on.	Check if the AC power cord is firmly connected.	–
	When the “Control Key Lock” is set to “On,” you cannot turn on the projector using the I/⌂ key on the projector.	30
	If the lamp or lamp cover is not attached securely, the projector cannot be turned on.	66
No image.	Check if the connecting cable is connected to external equipment firmly.	9
	Check the computer signal is set for output to an external monitor only. If you set your computer to output to both the computer’s display and an external monitor, the external monitor image may not be displayed properly. Set your computer to output to only an external monitor.	16
	Check if the application “USB Display” or “Projector Station for Network Presentation” is running.	47, 54
	Check if the USB memory device connected to the projector is compatible with the projector.	56
	Check if the input source is correctly selected.	16
	Check if the picture is muted by pressing the BLANK key.	7
The application “USB Display” or “Projector Station for Network Presentation” does not start.	Check if the computer connected to the projector meets the system requirement for the applications.	47, 54
The computer cannot connect to the projector.	<ul style="list-style-type: none"> • Check “LAN Settings” of the projector. • Check the condition of the wireless connection. 	31
On-screen display does not appear.	The on-screen display does not appear when “Status” in the Operation menu is set to “Off.”	30
The aspect ratio of the display is not right/the image is displayed smaller /a portion of image does not appear.	The image may not display correctly because the input signal cannot be judged correctly. In this case, set “Aspect” manually.	7, 25, 27
The image is a trapezoid.	The images become trapezoidal because of the projection angle. In this case, you can correct the trapezoidal distortion, using a Keystone feature.	7, 19, 34
	When the “V Keystone” is set to “Manual,” the keystone feature does not work automatically. Set “V Keystone” to “Auto” or “Manual” to set manually.	7, 19, 34
	When the projector is installed on an uneven surface, the feature may not work properly. In this case, select “Manual” to set “V Keystone” manually.	7, 19, 34

Symptoms	Remedy	Page
The image is dark/too bright.	The settings for “Brightness,” “Contrast,” and “Lamp Mode” affect brightness of the image. Check if the value is appropriate.	24, 32
	The image will be dark when the lamp is burnt out. Check “Lamp Timer,” and replace the lamp with a new one if necessary.	35, 66
	“With Static Signal” is set to “On.”	32
	During picture muting, the lamp is dimmed to reduce power consumption.	32
	When video signal is not input, the lamp is dimmed to reduce power consumption.	–
The image becomes darker or brighter.	When the lamp is dimmed for a long time, brightness may increase temporarily, but this is not malfunction.	–
	When the “Lamp Mode” is set to “Auto,” the luminance of the lamp changes according to the input image.	31
The image is not clear.	Check if the projector is in focus.	17
	The picture will not be clear if condensation has accumulated on the lens. In this case, let the projector sit for about two hours with the power on.	–
The image is noisy.	Check if the connecting cable is connected to the external equipment properly.	9
No sound. (VPL-EW578/EW575/EW455/EW435/EX575/EX455/EX435 only)	Check that the connecting cables between the projector and external video or audio equipment are securely connected.	9
	Check if the external audio equipment is set properly.	–
	Audio is not output if “Speaker” is set to “Off.”	29
	Audio is not output if audio muting is activated.	7
	Check if the volume is not set to minimum.	7, 29
The remote commander does not work.	Check if the batteries are installed correctly.	–
	Check if the batteries are not exhausted.	–
The fan is noisy.	The sound from the fan is often greater than normal to cool the lamp, etc. in the following cases. <ul style="list-style-type: none"> • “Lamp Mode” is set to “High.” • The unit is used at a high altitude. “High Altitude Mode” is set to “On.” • The unit is used in the location where the temperature is high. 	32, 34
	If the ventilation holes are blocked, the internal temperature of the projector rises and the fan noise becomes larger. Check that the ventilation holes (intake/exhaust) are not blocked by a wall or an object and secure a sufficient gap.	4, 4
	Check that the air filter is clogged, then clean or replace it.	68
The image is distorted by the HDBaseT connection. (VPL-EW578 only)	Confirm whether the unit’s AC power cord is grounded. Use the STP (Shielded Twisted Pair) type LAN cable.	–

Symptoms	Remedy	Page
The image is not projected properly when the projector is connected via the HDBaseT terminal and the cables are inserted or removed from other terminals. (VPL-EW578 only)	Change the input terminal to project the image properly.	–
The sound of the fan can be heard in standby mode. (VPL-EW578 only)	If “Standby Mode” is set to “Standard”, some functions, such as the fan, may operate even in standby mode. However, this is not a malfunction.	–



Others

Replacing the Lamp

Replace the lamp with a new one if a message displayed on the projected image (page 75).

Use an LMP-E221 projector lamp (not supplied) for replacement.

Caution

- The lamp remains hot after the projector is turned off. **If you touch the lamp, you may burn your finger. When you replace the lamp, wait for at least an hour after turning off the projector for the lamp to cool sufficiently.**
- Do not allow any metallic or inflammable objects into the lamp replacement slot after removing the lamp, otherwise it may cause electrical shock or fire. Do not put your hands into the slot.

Notes

- **If the lamp breaks, contact qualified Sony personnel. Do not replace the lamp yourself.**
- When removing the lamp, be sure to pull it out straight, by holding the designated location. If you touch a part of the lamp other than the designated location, you may be burned or injured. If you pull out the lamp while the projector is tilted, the pieces may scatter if the lamp breaks any may cause injury.

- 1 Turn off the projector, and disconnect the AC power cord from a wall outlet.
- 2 When the lamp has cooled sufficiently, open the lamp cover by loosening 1 screw.

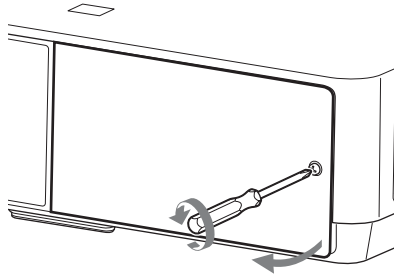

- 3 Loosen the 3 screws on the lamp (1) then pull out the lamp by its grab (2).

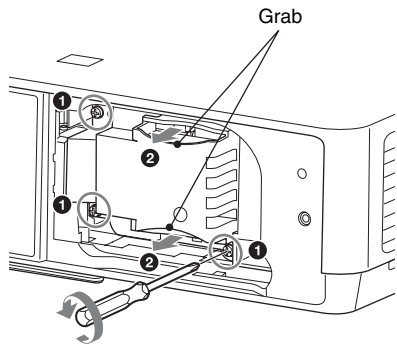

- 4 Insert the new lamp all the way in until it is securely in place (1). Tighten the 3 screws (2).

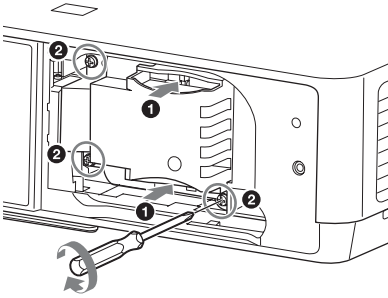

Note

The power will not turn on if the lamp is not secured properly.

- 5 Close the lamp cover and tighten the 1 screw.

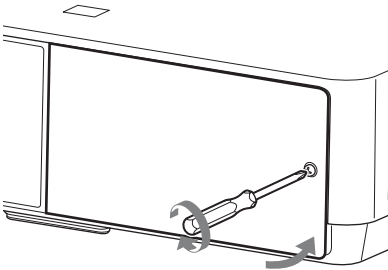

- 6 Connect the AC power cord to a wall outlet and turn on the projector.
- 7 Reset the lamp timer for notification of the next replacement time.
Select "Lamp Timer Reset" on the Function menu then press the ENTER key. When a message appears, select "Yes" to reset the lamp timer (page 29).

Caution

For the customers in the U.S.A. and Canada

(Hg) Lamp contains mercury. Dispose according to applicable local, state/province and federal laws. For additional information, see www.sony.com/mercury

Cleaning the Air Filter

When a message appears on the projected image indicating time for a filter cleaning, clean the air filter (pages 60, 62). If the dust cannot be removed from the air filter even after cleaning, replace the air filter with a new one. For details on a new air filter, consult with qualified Sony personnel.

Caution

If you continue to use the projector even after the message is displayed, dust may accumulate, clogging it. As a result, the temperature may rise inside the unit, leading to a possible malfunction or fire.

- 1 Turn off the projector, and disconnect the AC power cord from the AC outlet.
- 2 Slide out and remove the air filter cover from the unit.

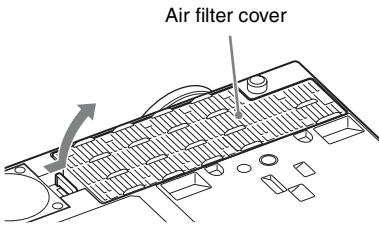

- 3 Clean the air filter with a vacuum cleaner.
Pull out and remove the air filter cover, and clean it with a vacuum cleaner.

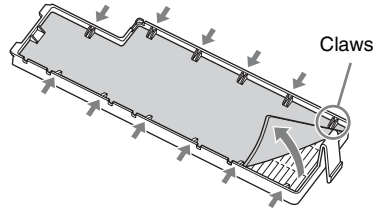

- 4 Reattach the air filter cover to the unit.

Note

Be sure to attach the air filter cover firmly, otherwise it may cause a malfunction.

Specifications

Items		Descriptions
Projection system		3 LCD system
Display device	Effective display size	VPL-EW578/EW575: 0.75 inch (19.0 mm), 3 plate panels, Aspect ratio 16:10 VPL-EW455/EW435: 0.59 inch (15.0 mm), 3 plate panels, Aspect ratio 16:10 VPL-EX575/EX570/EX455/EX450/EX435/EX430: 0.63 inch (16.0 mm), 3 plate panels, Aspect ratio 4:3
	Effective picture elements	VPL-EW578/EW575/EW455/EW435: 3,072,000 pixels (1,280 × 800 pixels, 3 plate panels) VPL-EX575/EX570/EX455/EX450/EX435/EX430: 2,359,296 pixels (1,024 × 768 pixels, 3 plate panels)
Projection lens	Zoom	VPL-EW578/EW575/EX575/EX570: Manual zoom 1.6 times VPL-EW455/EW435/EX455/EX450: Manual zoom: 1.3 times VPL-EX435/EX430: Manual zoom: 1.2 times
	Focus	Manual
Light source		High-pressure mercury lamp, 225 W type
Projected image size		30 inches to 300 inches (0.76 m to 7.62 m)
Luminous flux (Brightness)		VPL-EW578/EW575: 4,300 lm VPL-EX575/EX570: 4,200 lm VPL-EX455/EX450: 3,600 lm VPL-EW455: 3,500 lm VPL-EX435/EX430: 3,200 lm VPL-EW435: 3,100 lm (when “Lamp Mode” is set to “High”)
Speaker (VPL-EW578/EW575/ EW455/EW435/ EX575/EX455/ EX435 only)		16 W × 1 (monaural)
Applicable scanning frequency ^{*1}		Horizontal: 15 kHz to 92 kHz, Vertical: 48 Hz to 92 Hz
Resolution ^{*1}	When a computer signal is input	Maximum display resolution: 1,600 × 1,200 pixels (resize) Panel display resolution: VPL-EW578/EW575/EW455/EW435: 1,280 × 800 pixels VPL-EX575/EX570/EX455/EX450/EX435/EX430: 1,024 × 768 pixels
	When a video signal is input	NTSC, PAL, SECAM, 480/60i, 576/50i, 480/60p, 576/50p, 720/60p, 720/50p, 1080/60i, 1080/50i, 1080/60p, 1080/50p
Color system		NTSC ^{3.58} , PAL, SECAM, NTSC ^{4.43} , PAL-M, PAL-N, PAL60

Others

Items	Descriptions
INPUT OUTPUT (Computer/video)	<p>INPUT A</p> <p>RGB/YPbPr input terminal: Mini D-sub 15-pin female, G with sync/Y: 1 Vp-p ± 2 dB, sync negative, 75 ohms terminated, RGB/PbPr: 0.7 Vp-p ± 2 dB, 75 ohms terminated, Sync signal: TTL level high impedance, positive/negative</p> <p>Audio input terminal (VPL-EW578/EW575/EW455/EW435/EX575/EX455/EX435 only): Stereo mini jack, rated input 500 mVrms, input impedance more than 47 kohms</p>
	<p>INPUT B</p> <p>RGB input terminal: Mini D-sub 15-pin female, RGB: 0.7 Vp-p ± 2 dB, 75 ohms terminated, Sync signal: TTL level high impedance, positive/negative</p> <p>Audio input terminal (VPL-EW578/EW575/EW455/EW435/EX575/EX455/EX435 only): Stereo mini jack, rated input 500 mVrms, input impedance more than 47 kohms</p>
INPUT C/ INPUT D	<p>HDMI input terminal (Audio output is available only on VPL-EW578/EW575/EW455/EW435/EX575/EX455/EX435.): HDMI 19-pin, HDCP, HDMI audio support</p>
S VIDEO (SVIDEO IN)	<p>S video input terminal: Mini DIN 4-pin, Y: 1 Vp-p ± 2dB, sync negative, 75 ohms terminated, C: (burst signal) 0.286 (NTSC)/0.3 (PAL/SECAM) Vp-p ± 2 dB, 75 ohms terminated</p> <p>Audio input terminal (VPL-EW578/EW575/EW455/EW435/EX575/EX455/EX435 only): Phono jack × 2, rated input 500 mVrms, input impedance more than 47 kohms</p>
VIDEO (VIDEO IN)	<p>Video input terminal: Pin jack, 1 Vp-p ± 2 dB, sync negative, 75 ohms terminated</p> <p>Audio input terminal (VPL-EW578/EW575/EW455/EW435/EX575/EX455/EX435 only): Shared with S VIDEO</p>
OUTPUT	<p>MONITOR output terminal: Mini D-sub 15-pin female, G with sync/Y: 1 Vp-p ± 2 dB, sync negative, 75 ohms terminated, RGB/PbPr: 0.7 Vp-p ± 2 dB, 75 ohms terminated, Sync signal: HD, VD 4 V (open), 1 Vp-p (75 ohms), positive/negative</p> <p>Audio output terminal (VPL-EW578/EW575/EW455/EW435/EX575/EX455/EX435 only): Stereo mini jack, 1 Vrms (maximum volume, when inputting 500 mVrms), output impedance 5 kohms</p>

Items	Descriptions
Other terminals	<p>RS-232C terminal: D-Sub 9-pin male</p> <hr/> <p>LAN terminal: RJ45, 10BASE-T/100BASE-TX HDBaseT[®]4/LAN terminal: RJ45, HDBaseT/100BASE-TX HDBaseT transmittable signal: HDMI (Video, Audio), RS-232C, Ethernet HDBaseT LAN cable: STP type (CAT5e or higher, straight, not supplied), Maximum length: 100 m</p> <hr/> <p>USB terminal: Type A</p> <hr/> <p>USB terminal: Type B</p> <hr/> <p>Microphone input (VPL-EW578/EW575/EW455/EW435/EX575/EX455/EX435 only): Mini jack</p>
Operating temperature/ Operating humidity	0 °C to 40 °C (32 °F to 104 °F)/20% ~ 80% (no condensation)
Storage temperature/ Storage humidity	-10 °C to +60 °C (14 °F to 140 °F)/20% to 80% (no condensation)
Power requirements	<p>VPL-EW578: 100 V to 240 V AC, 3.5 A - 1.5 A, 50/60 Hz VPL-EW575/EW455/EX575/EX455/EX435: 100 V to 240 V AC, 3.4 A - 1.5 A, 50/60 Hz VPL-EW435: 100 V to 240 V AC, 3.2 A - 1.4 A, 50/60 Hz VPL-EX570/EX450/EX430: 100 V to 240 V AC, 3.1 A - 1.4 A, 50/60 Hz</p>
Power consumption	<p>VPL-EW578: 100V to 120V AC: 344 W 220V to 240V AC: 328 W VPL-EW575/EW455: 100V to 120V AC: 332 W 220V to 240V AC: 319 W VPL-EW435: 100V to 120V AC: 318 W 220V to 240V AC: 306 W VPL-EX575/EX455/EX435: 100V to 120V AC: 333 W 220V to 240V AC: 320 W VPL-EX570/EX450/EX430: 100V to 120V AC: 303 W 220V to 240V AC: 291 W</p>
Power consumption (standby mode)	<p>100 V to 120 V AC: 0.50 W (when “Standby Mode” is set to “Low”) 220 V to 240 V AC: 0.50 W (when “Standby Mode” is set to “Low”)</p>

Items	Descriptions
Power consumption (networked standby mode)	<p>VPL-EW578: 100 V to 120 V AC: 19.8 W (LAN) 14.3 W (optional WLAN module) 20.8 W (all terminals and networks connected) (when “Standby Mode” is set to “Standard”) 220 V to 240 V AC: 26.7 W (LAN) 19.1 W (optional WLAN module) 27.6 W (all terminals and networks connected) (when “Standby Mode” is set to “Standard”) VPL-EW575/EW455/EW435/EX575/EX570/EX455/EX450/EX435/EX430: 100 V to 120 V AC: 5.5 W (LAN) 6.0 W (optional WLAN module) 6.2 W (all terminals and networks connected) (when “Standby Mode” is set to “Standard”) 220 V to 240 V AC: 5.8 W (LAN) 6.3 W (optional WLAN module) 6.6 W (all terminals and networks connected) (when “Standby Mode” is set to “Standard”)</p>
Heat dissipation	<p>VPL-EW578: 100V to 120V AC: 1,174 BTU/h 220V to 240V AC: 1,119 BTU/h VPL-EW575/EW455: 100V to 120V AC: 1,133 BTU/h 220V to 240V AC: 1,088 BTU/h VPL-EW435: 100V to 120V AC: 1,085 BTU/h 220V to 240V AC: 1,044 BTU/h VPL-EX575/EX455/EX435: 100V to 120V AC: 1,136 BTU/h 220V to 240V AC: 1,092 BTU/h VPL-EX570/EX450/EX430: 100V to 120V AC: 1,034 BTU/h 220V to 240V AC: 993 BTU/h</p>
Standard dimensions (W/H/D)	<p>VPL-EW578/EW575: Approx. 365 × 105.3 × 267.7 mm (14 ³/₈ × 4 ⁵/₃₂ × 10 ¹⁷/₃₂ inches) Approx. 365 × 96.2 × 252 mm (14 ³/₈ × 3 ²⁵/₃₂ × 9 ²⁹/₃₂ inches) (without projecting parts) VPL-EX575/EX570: Approx. 365 × 105.3 × 259 mm (14 ³/₈ × 4 ⁵/₃₂ × 10 ³/₁₆ inches) Approx. 365 × 96.2 × 252 mm (14 ³/₈ × 3 ²⁵/₃₂ × 9 ²⁹/₃₂ inches) (without projecting parts) VPL-EW455/EW435/EX455/EX450/EX435/EX430: Approx. 365 × 105.3 × 252 mm (14 ³/₈ × 4 ⁵/₃₂ × 9 ²⁹/₃₂ inches) Approx. 365 × 96.2 × 252 mm (14 ³/₈ × 3 ²⁵/₃₂ × 9 ²⁹/₃₂ inches) (without projecting parts)</p>

Items	Descriptions
Mass	VPL-EW578/EW575: Approx. 4.1 kg (9 lb) VPL-EX575: Approx. 4 kg (8.8 lb) VPL-EW455/EW435/EX570/EX455/EX435: Approx. 3.9 kg (8.6 lb) VPL-EX450/EX430: Approx. 3.8 kg (8.4 lb)
Supplied accessories	See “Checking the Supplied Accessories” in the supplied Quick Reference Manual.
Optional accessories *2 *3	Projector Lamp LMP-E221 (for replacement) USB wireless LAN module IFU-WLM3

Notes

- *1: For details, refer to “Acceptable Input Signals” on page 75.
- *2: Information on accessories in this manual is current as of November 2016.
- *3: Not all optional accessories are available in all countries and area. Please check with your local Sony Authorized Dealer.
- *4: VPL-EW578 only.

Design and specifications of the unit, including the optional accessories, are subject to change without notice.



Others

Pin assignment

HDMI terminal (HDMI, female)

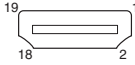

1	T.M.D.S. Data2+	11	T.M.D.S. Clock Shield
2	T.M.D.S. Data2 Shield	12	T.M.D.S. Clock -
3	T.M.D.S. Data2 -	13	N.C.
4	T.M.D.S. Data1+	14	RESERVED (N.C.)
5	T.M.D.S. Data1 Shield	15	SCL
6	T.M.D.S. Data1 -	16	SDA
7	T.M.D.S. Data0+	17	DDC GND
8	T.M.D.S. Data0 Shield	18	+5V Power
9	T.M.D.S. Data0 -	19	Hot Plug Detect
10	T.M.D.S. Clock+		

RGB input terminal (Mini D-sub 15-pin, female)

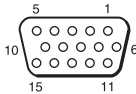

1	Video input (red) R	9	Power supply input for DDC
2	Video input (green) G	10	GND
3	Video input (blue) B	11	GND
4	GND	12	DDC/SDA
5	RESERVE	13	Horizontal sync signal

6	GND (R)	14	Vertical sync signal
7	GND (G)	15	DDC/SCL
8	GND (B)		

RS-232C terminal (D-Sub 9-pin, male)

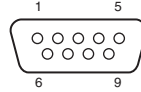

1	NC	6	NC
2	RXDA	7	RTS
3	TXDA	8	CTS
4	DTR	9	NC
5	GND		

USB terminal (Type A, female)

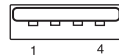

1	V _{BUS} (4.4 - 5.25 V)
2	Data-
3	Data+
4	Ground

USB terminal (Type B, female)



1	V _{CC} (+5 V)
2	Data-
3	Data+
4	Ground

Acceptable Input Signals*1

Computer signal

Resolution	fH[kHz]/ fV[Hz]	Input terminal		
		RGB/ YPbPr	HDMI	RGB
640 × 350	31.5/70	●		●
	37.9/85	●		●
640 × 400	31.5/70	●		●
	37.9/85	●		●
640 × 480	31.5/60	●	●	●
	35.0/67	●		●
	37.9/73	●		●
	37.5/75	●		●
	43.3/85	●		●
800 × 600	35.2/56	●		●
	37.9/60	●	●	●
	48.1/72	●		●
	46.9/75	●		●
	53.7/85	●		●
832 × 624	49.7/75	●		●
1024 × 768	48.4/60	●	●	●
	56.5/70	●		●
	60.0/75	●		●
	68.7/85	●		●
1152 × 864	64.0/70	●		●
	67.5/75	●		●
	77.5/85	●		●
1152 × 900	61.8/66	●		●
1280 × 960	60.0/60	●	●	●
1280 × 1024	64.0/60	●	●	●
	80.0/75	●		●
	91.1/85	●		●
1400 × 1050	65.3/60	●	●	●
1600 × 1200	75.0/60	●	●	●
1280 × 768	47.8/60		●	
1280 × 720	45.0/60	●	●*2	●
1920 × 1080	67.5/60		●*3	
1366 × 768	47.7/60	●	●	●
1440 × 900	55.9/60	●	●	●

Resolution	fH[kHz]/ fV[Hz]	Input terminal		
		RGB/ YPbPr	HDMI	RGB
1280 × 800	49.7/60	●	●	●

Digital TV signal*4

Signal	fV[Hz]	Input terminal	
		RGB/ YPbPr	HDMI
480i	60	●	●
576i	50	●	●
480p	60	●	●
576p	50	●	●
1080i	60	●	●
1080i	50	●	●
720p	60	●	●
720p	50	●	●
1080p	60		●
1080p	50		●

Analog TV signal

Signal	fV[Hz]	Input terminal
		VIDEO/S VIDEO
NTSC	60	●
PAL/SECAM	50	●

Notes

- *1: ● When a signal other than the signals listed in table is input, the picture may not be displayed properly.
- An input signal meant for screen resolution different from that of the panel will not be displayed in its original resolution. Text and lines may be uneven.
- *2: This is identified as a movie delivery signal of 720/60p.
- *3: This is identified as a movie delivery signal of 1080/60p.
- *4: Only G with sync/Y is supported.

Others

Projection Distance

The projection distance is the distance between the front of the lens and the surface of the projected image. The following describes the projection distance and height from the center of the lens to edge of screen by each projected screen size. Height H is the height from the bottom of the projected image (top for ceiling mount) to A (determined by drawing a perpendicular line from the center of the lens to projected image surface).

Floor Installation

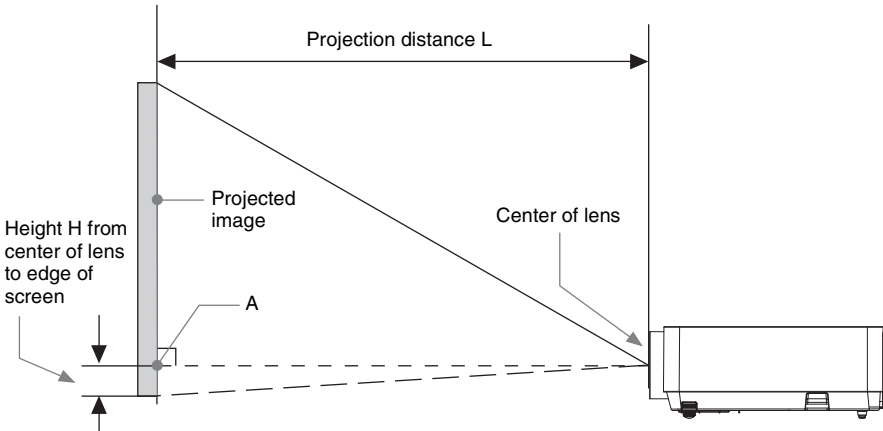

* The number will be minus when the bottom of the projected image is lower than A.

Projection distance table (VPL-EW578/EW575)

Unit: m (inches)

Projected image size		Projection Distance L	Height H from center of lens to edge of screen	
Diagonal D	Width × Height		Minimum Projection Distance L	Maximum Projection Distance L
80 inch (2.03m)	1.72 × 1.08 (68 × 42)	1.92-3.09 (76-121)	-0.20 (-8)	-0.20 (-8)
100 inch (2.54m)	2.15 × 1.35 (85 × 53)	2.41-3.87 (95-152)	-0.25 (-10)	-0.25 (-10)
120 inch (3.05m)	2.58 × 1.62 (102 × 64)	2.90-4.66 (114-183)	-0.29 (-12)	-0.29 (-12)
150 inch (3.81m)	3.23 × 2.02 (127 × 79)	3.63-5.83 (143-229)	-0.37 (-15)	-0.37 (-15)
200 inch (5.08m)	4.31 × 2.69 (170 × 106)	4.85-7.79 (191-306)	-0.49 (-19)	-0.49 (-19)

Others

Projection distance formula (VPL-EW578/EW575)

D: Projected image size (Diagonal)
 H: Height H from center of lens to edge of screen

Expression#1 (Projection distance L) Unit: m (inches)

Minimum Projection Distance L	Maximum Projection Distance L
$L=0.024366 \times D-0.0315$ ($L=0.959286 \times D-1.2399$)	$L=0.039132 \times D-0.0357$ ($L=1.540634 \times D-1.4060$)

Expression#2 (Height H from center of lens to edge of screen)

Height H from center of lens to edge of screen	
Minimum Projection Distance L	Maximum Projection Distance L
$H=-0.00246 \times D$ ($H=-0.09675 \times D$)	$H=-0.00246 \times D$ ($H=-0.09675 \times D$)

Projection distance table (VPL-EW455/EW435)

Unit: m (inches)

Projected image size		Projection Distance L	Height H from center of lens to edge of screen	
Diagonal D	Width × Height		Minimum Projection Distance L	Maximum Projection Distance L
80 inch (2.03m)	1.72 × 1.08 (68 × 42)	2.35-3.06 (93-120)	-0.11 (-4)	-0.11 (-4)
100 inch (2.54m)	2.15 × 1.35 (85 × 53)	2.94-3.83 (116-151)	-0.13 (-5)	-0.13 (-5)
120 inch (3.05m)	2.58 × 1.62 (102 × 64)	3.53-4.61 (139-181)	-0.16 (-6)	-0.16 (-6)
150 inch (3.81m)	3.23 × 2.02 (127 × 79)	4.42-5.77 (174-227)	-0.20 (-8)	-0.20 (-8)
200 inch (5.08m)	4.31 × 2.69 (170 × 106)	5.91-7.70 (233-303)	-0.27 (-11)	-0.27 (-11)

Projection distance formula (VPL-EW455/EW435)

D: Projected image size (Diagonal)

H: Height H from center of lens to edge of screen

Expression#1(Projection distance L)

Unit: m (inches)

Minimum Projection Distance L	Maximum Projection Distance L
$L=0.029654 \times D-0.0291$ ($L=1.167491 \times D-1.1464$)	$L=0.038671 \times D-0.0282$ ($L=1.522489 \times D-1.1109$)

Expression#2(Height H from center of lens to edge of screen)

Height H from center of lens to edge of screen	
Minimum Projection Distance L	Maximum Projection Distance L
$H=-0.00135 \times D$ ($H=-0.05300 \times D$)	$H=-0.00135 \times D$ ($H=-0.05300 \times D$)

Projection distance table (VPL-EX575/EX570)

Unit: m (inches)

Projected image size		Projection Distance L	Height H from center of lens to edge of screen	
Diagonal D	Width × Height		Minimum Projection Distance L	Maximum Projection Distance L
80 inch (2.03m)	1.63 × 1.22 (64 × 48)	2.29-3.68 (90-145)	-0.20 (-8)	-0.20 (-8)
100 inch (2.54m)	2.03 × 1.52 (80 × 60)	2.87-4.61 (113-181)	-0.25 (-10)	-0.25 (-10)
120 inch (3.05m)	2.44 × 1.83 (96 × 72)	3.45-5.54 (136-218)	-0.30 (-12)	-0.30 (-12)
150 inch (3.81m)	3.05 × 2.29 (120 × 90)	4.32-6.94 (170-273)	-0.38 (-15)	-0.38 (-15)
200 inch (5.08m)	4.06 × 3.05 (160 × 120)	5.77-9.26 (227-364)	-0.51 (-20)	-0.51 (-20)

Others

Projection distance formula (VPL-EX575/EX570)

D: Projected image size (Diagonal)
 H: Height H from center of lens to edge of screen

Expression#1(Projection distance L) Unit: m (inches)

Minimum Projection Distance L	Maximum Projection Distance L
$L=0.028965 \times D-0.0315$ ($L=1.140341 \times D-1.2418$)	$L=0.046521 \times D-0.0363$ ($L=1.831537 \times D-1.4310$)

Expression#2(Height H from center of lens to edge of screen)

Height H from center of lens to edge of screen	
Minimum Projection Distance L	Maximum Projection Distance L
$H=-0.00254 \times D$ ($H=-0.10000 \times D$)	$H=-0.00254 \times D$ ($H=-0.10000 \times D$)

Projection distance table (VPL-EX455/EX450)

Unit: m (inches)

Projected image size		Projection Distance L	Height H from center of lens to edge of screen	
Diagonal D	Width × Height		Minimum Projection Distance L	Maximum Projection Distance L
80 inch (2.03m)	1.63 × 1.22 (64 × 48)	2.24-2.92 (89-115)	-0.20 (-8)	-0.20 (-8)
100 inch (2.54m)	2.03 × 1.52 (80 × 60)	2.81-3.66 (111-144)	-0.25 (-10)	-0.25 (-10)
120 inch (3.05m)	2.44 × 1.83 (96 × 72)	3.38-4.40 (133-173)	-0.30 (-12)	-0.30 (-12)
150 inch (3.81m)	3.05 × 2.29 (120 × 90)	4.23-5.51 (167-217)	-0.38 (-15)	-0.38 (-15)
200 inch (5.08m)	4.06 × 3.05 (160 × 120)	5.65-7.36 (223-290)	-0.51 (-20)	-0.51 (-20)

Projection distance formula (VPL-EX455/EX450)

D: Projected image size (Diagonal)

H: Height H from center of lens to edge of screen

Expression#1(Projection distance L)

Unit: m (inches)

Minimum Projection Distance L	Maximum Projection Distance L
$L=0.028353 \times D-0.0294$ ($L=1.116279 \times D-1.1560$)	$L=0.036975 \times D-0.0282$ ($L=1.455727 \times D-1.1109$)

Expression#2(Height H from center of lens to edge of screen)

Height H from center of lens to edge of screen	
Minimum Projection Distance L	Maximum Projection Distance L
$H=-0.00254 \times D$ ($H=-0.10000 \times D$)	$H=-0.00254 \times D$ ($H=-0.10000 \times D$)

Projection distance table (VPL-EX435/EX430)

Unit: m (inches)

Projected image size		Projection Distance L	Height H from center of lens to edge of screen	
Diagonal D	Width × Height		Minimum Projection Distance L	Maximum Projection Distance L
80 inch (2.03m)	1.63 × 1.22 (64 × 48)	2.41-2.88 (95-113)	-0.20 (-8)	-0.20 (-8)
100 inch (2.54m)	2.03 × 1.52 (80 × 60)	3.02-3.60 (119-142)	-0.25 (-10)	-0.25 (-10)
120 inch (3.05m)	2.44 × 1.83 (96 × 72)	3.63-4.33 (143-170)	-0.30 (-12)	-0.30 (-12)
150 inch (3.81m)	3.05 × 2.29 (120 × 90)	4.54-5.42 (179-213)	-0.38 (-15)	-0.38 (-15)
200 inch (5.08m)	4.06 × 3.05 (160 × 120)	6.06-7.24 (239-285)	-0.51 (-20)	-0.51 (-20)

Others

Projection distance formula (VPL-EX435/EX430)

D: Projected image size (Diagonal)

H: Height H from center of lens to edge of screen

Expression#1(Projection distance L)

Unit: m (inches)

Minimum Projection Distance L	Maximum Projection Distance L
$L=0.030411 \times D-0.0233$ ($L=1.197284 \times D-0.9154$)	$L=0.036318 \times D-0.0234$ ($L=1.429835 \times D-0.9228$)

Expression#2(Height H from center of lens to edge of screen)

Height H from center of lens to edge of screen	
Minimum Projection Distance L	Maximum Projection Distance L
$H=-0.00254 \times D$ ($H=-0.10000 \times D$)	$H=-0.00254 \times D$ ($H=-0.10000 \times D$)

Ceiling Installation

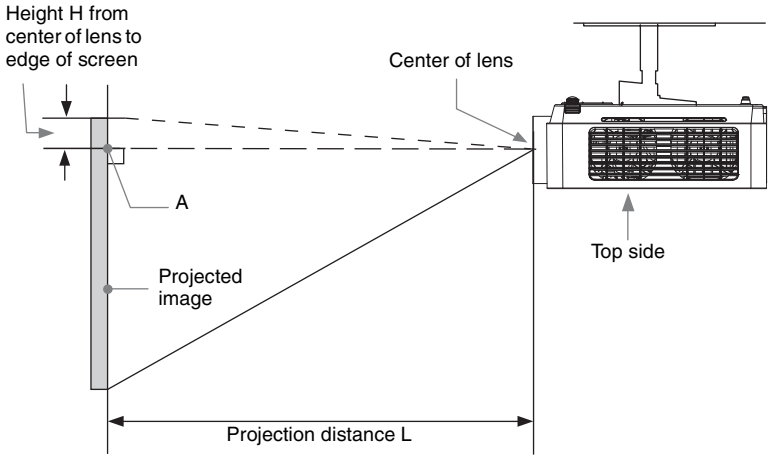

* The number will be minus when the top of the projected image is higher than A.

Projection distance table (VPL-EW578/EW575)

Unit: m (inches)

Projected image size		Projection Distance L	Height H from center of lens to edge of screen	
Diagonal D	Width × Height		Minimum Projection Distance L	Maximum Projection Distance L
80 inch (2.03m)	1.72 × 1.08 (68 × 42)	1.92-3.09 (76-121)	-0.20 (-8)	-0.20 (-8)
100 inch (2.54m)	2.15 × 1.35 (85 × 53)	2.41-3.87 (95-152)	-0.25 (-10)	-0.25 (-10)
120 inch (3.05m)	2.58 × 1.62 (102 × 64)	2.90-4.66 (114-183)	-0.29 (-12)	-0.29 (-12)
150 inch (3.81m)	3.23 × 2.02 (127 × 79)	3.63-5.83 (143-229)	-0.37 (-15)	-0.37 (-15)
200 inch (5.08m)	4.31 × 2.69 (170 × 106)	4.85-7.79 (191-306)	-0.49 (-19)	-0.49 (-19)

Others

Projection distance formula (VPL-EW578/EW575)

D: Projected image size (Diagonal)

H: Height H from center of lens to edge of screen

Expression#1(Projection distance L)

Unit: m (inches)

Minimum Projection Distance L	Maximum Projection Distance L
$L=0.024366 \times D-0.0315$ ($L=0.959286 \times D-1.2399$)	$L=0.039132 \times D-0.0357$ ($L=1.540634 \times D-1.4060$)

Expression#2(Height H from center of lens to edge of screen)

Height H from center of lens to edge of screen	
Minimum Projection Distance L	Maximum Projection Distance L
$H=-0.00246 \times D$ ($H=-0.09675 \times D$)	$H=-0.00246 \times D$ ($H=-0.09675 \times D$)

Note

For ceiling installation, consult with a ceiling mount manufacturer, and use a ceiling mount specified for use with this projector by the manufacturer.

Projection distance table (VPL-EW455/EW435)

Unit: m (inches)

Projected image size		Projection Distance L	Height H from center of lens to edge of screen	
Diagonal D	Width × Height		Minimum Projection Distance L	Maximum Projection Distance L
80 inch (2.03m)	1.72 × 1.08 (68 × 42)	2.35-3.06 (93-120)	-0.11 (-4)	-0.11 (-4)
100 inch (2.54m)	2.15 × 1.35 (85 × 53)	2.94-3.83 (116-151)	-0.13 (-5)	-0.13 (-5)
120 inch (3.05m)	2.58 × 1.62 (102 × 64)	3.53-4.61 (139-181)	-0.16 (-6)	-0.16 (-6)
150 inch (3.81m)	3.23 × 2.02 (127 × 79)	4.42-5.77 (174-227)	-0.20 (-8)	-0.20 (-8)
200 inch (5.08m)	4.31 × 2.69 (170 × 106)	5.91-7.70 (233-303)	-0.27 (-11)	-0.27 (-11)

Projection distance formula (VPL-EW455/EW435)

D: Projected image size (Diagonal)

H: Height H from center of lens to edge of screen

Expression#1(Projection distance L)

Unit: m (inches)

Minimum Projection Distance L	Maximum Projection Distance L
$L=0.029654 \times D-0.0291$ ($L=1.167491 \times D-1.1464$)	$L=0.038671 \times D-0.0282$ ($L=1.522489 \times D-1.1109$)

Expression#2(Height H from center of lens to edge of screen)

Height H from center of lens to edge of screen	
Minimum Projection Distance L	Maximum Projection Distance L
$H=-0.00135 \times D$ ($H=-0.05300 \times D$)	$H=-0.00135 \times D$ ($H=-0.05300 \times D$)

Note

For ceiling installation, consult with a ceiling mount manufacturer, and use a ceiling mount specified for use with this projector by the manufacturer.

Projection distance table (VPL-EX575/EX570)

Unit: m (inches)

Projected image size		Projection Distance L	Height H from center of lens to edge of screen	
Diagonal D	Width × Height		Minimum Projection Distance L	Maximum Projection Distance L
80 inch (2.03m)	1.63 × 1.22 (64 × 48)	2.29-3.68 (90-145)	-0.20 (-8)	-0.20 (-8)
100 inch (2.54m)	2.03 × 1.52 (80 × 60)	2.87-4.61 (113-181)	-0.25 (-10)	-0.25 (-10)
120 inch (3.05m)	2.44 × 1.83 (96 × 72)	3.45-5.54 (136-218)	-0.30 (-12)	-0.30 (-12)
150 inch (3.81m)	3.05 × 2.29 (120 × 90)	4.32-6.94 (170-273)	-0.38 (-15)	-0.38 (-15)
200 inch (5.08m)	4.06 × 3.05 (160 × 120)	5.77-9.26 (227-364)	-0.51 (-20)	-0.51 (-20)

Others

Projection distance formula (VPL-EX575/EX570)

D: Projected image size (Diagonal)
 H: Height H from center of lens to edge of screen

Expression#1(Projection distance L) Unit: m (inches)

Minimum Projection Distance L	Maximum Projection Distance L
$L=0.028965 \times D-0.0315$ ($L=1.140341 \times D-1.2418$)	$L=0.046521 \times D-0.0363$ ($L=1.831537 \times D-1.4310$)

Expression#2(Height H from center of lens to edge of screen)

Height H from center of lens to edge of screen	
Minimum Projection Distance L	Maximum Projection Distance L
$H=-0.00254 \times D$ ($H=-0.10000 \times D$)	$H=-0.00254 \times D$ ($H=-0.10000 \times D$)

Note

For ceiling installation, consult with a ceiling mount manufacturer, and use a ceiling mount specified for use with this projector by the manufacturer.

Projection distance table (VPL-EX455/EX450)

Unit: m (inches)

Projected image size		Projection Distance L	Height H from center of lens to edge of screen	
Diagonal D	Width × Height		Minimum Projection Distance L	Maximum Projection Distance L
80 inch (2.03m)	1.63 × 1.22 (64 × 48)	2.24-2.92 (89-115)	-0.20 (-8)	-0.20 (-8)
100 inch (2.54m)	2.03 × 1.52 (80 × 60)	2.81-3.66 (111-144)	-0.25 (-10)	-0.25 (-10)
120 inch (3.05m)	2.44 × 1.83 (96 × 72)	3.38-4.40 (133-173)	-0.30 (-12)	-0.30 (-12)
150 inch (3.81m)	3.05 × 2.29 (120 × 90)	4.23-5.51 (167-217)	-0.38 (-15)	-0.38 (-15)
200 inch (5.08m)	4.06 × 3.05 (160 × 120)	5.65-7.36 (223-290)	-0.51 (-20)	-0.51 (-20)

Projection distance formula (VPL-EX455/EX450)

D: Projected image size (Diagonal)

H: Height H from center of lens to edge of screen

Expression#1(Projection distance L)

Unit: m (inches)

Minimum Projection Distance L	Maximum Projection Distance L
$L=0.028353 \times D-0.0294$ ($L=1.116279 \times D-1.1560$)	$L=0.036975 \times D-0.0282$ ($L=1.455727 \times D-1.1109$)

Expression#2(Height H from center of lens to edge of screen)

Height H from center of lens to edge of screen	
Minimum Projection Distance L	Maximum Projection Distance L
$H=-0.00254 \times D$ ($H=-0.10000 \times D$)	$H=-0.00254 \times D$ ($H=-0.10000 \times D$)

Note

For ceiling installation, consult with a ceiling mount manufacturer, and use a ceiling mount specified for use with this projector by the manufacturer.

Projection distance table (VPL-EX435/EX430)

Unit: m (inches)

Projected image size		Projection Distance L	Height H from center of lens to edge of screen	
Diagonal D	Width × Height		Minimum Projection Distance L	Maximum Projection Distance L
80 inch (2.03m)	1.63 × 1.22 (64 × 48)	2.41-2.88 (95-113)	-0.20 (-8)	-0.20 (-8)
100 inch (2.54m)	2.03 × 1.52 (80 × 60)	3.02-3.60 (119-142)	-0.25 (-10)	-0.25 (-10)
120 inch (3.05m)	2.44 × 1.83 (96 × 72)	3.63-4.33 (143-170)	-0.30 (-12)	-0.30 (-12)
150 inch (3.81m)	3.05 × 2.29 (120 × 90)	4.54-5.42 (179-213)	-0.38 (-15)	-0.38 (-15)
200 inch (5.08m)	4.06 × 3.05 (160 × 120)	6.06-7.24 (239-285)	-0.51 (-20)	-0.51 (-20)

Others

Projection distance formula (VPL-EX435/EX430)

D: Projected image size (Diagonal)

H: Height H from center of lens to edge of screen

Expression#1(Projection distance L)

Unit: m (inches)

Minimum Projection Distance L	Maximum Projection Distance L
$L=0.030411 \times D-0.0233$ ($L=1.197284 \times D-0.9154$)	$L=0.036318 \times D-0.0234$ ($L=1.429835 \times D-0.9228$)

Expression#2(Height H from center of lens to edge of screen)

Height H from center of lens to edge of screen	
Minimum Projection Distance L	Maximum Projection Distance L
$H=-0.00254 \times D$ ($H=-0.10000 \times D$)	$H=-0.00254 \times D$ ($H=-0.10000 \times D$)

Note

For ceiling installation, consult with a ceiling mount manufacturer, and use a ceiling mount specified for use with this projector by the manufacturer.

Dimensions

Top (VPL-EW578/EW575)

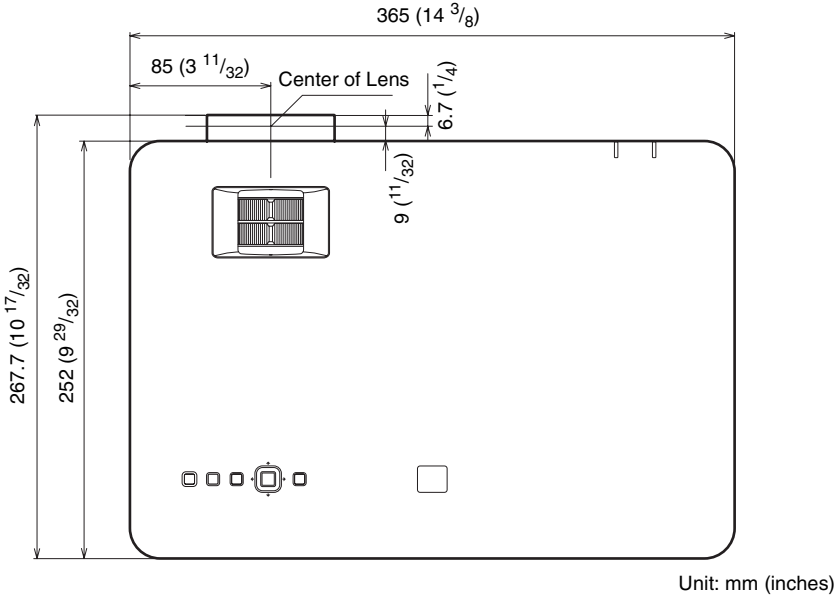

Top (VPL-EX575/EX570)

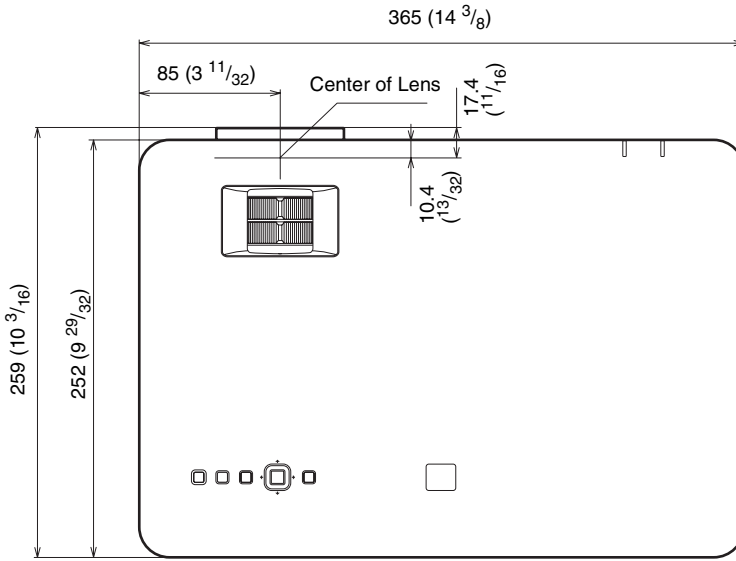

Top (VPL-EW455/EW435/EX455/EX450/EX435/EX430)

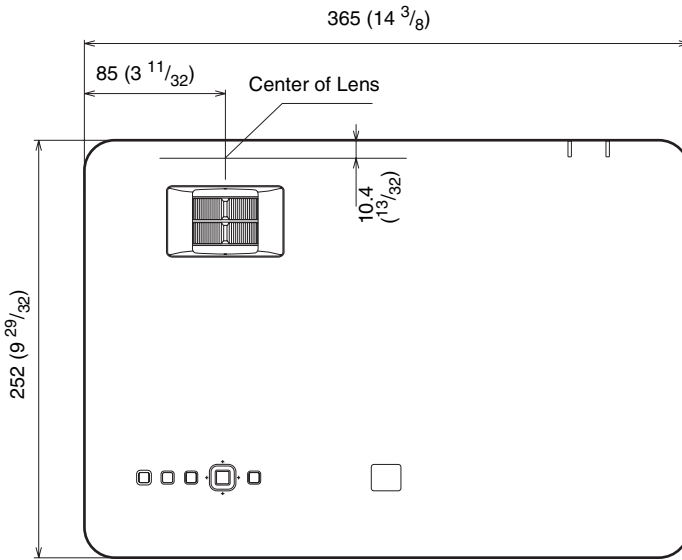

Others

Front

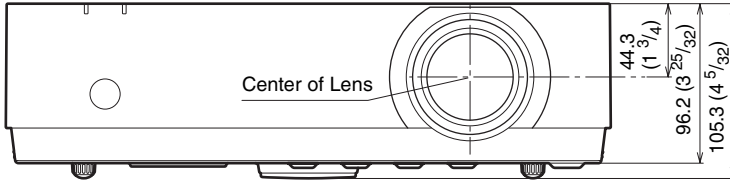

Center of Lens

44.3
(1 3/4)

96.2 (3 25/32)

105.3 (4 5/32)

Unit: mm (inches)

Bottom (VPL-EW578/EW575)

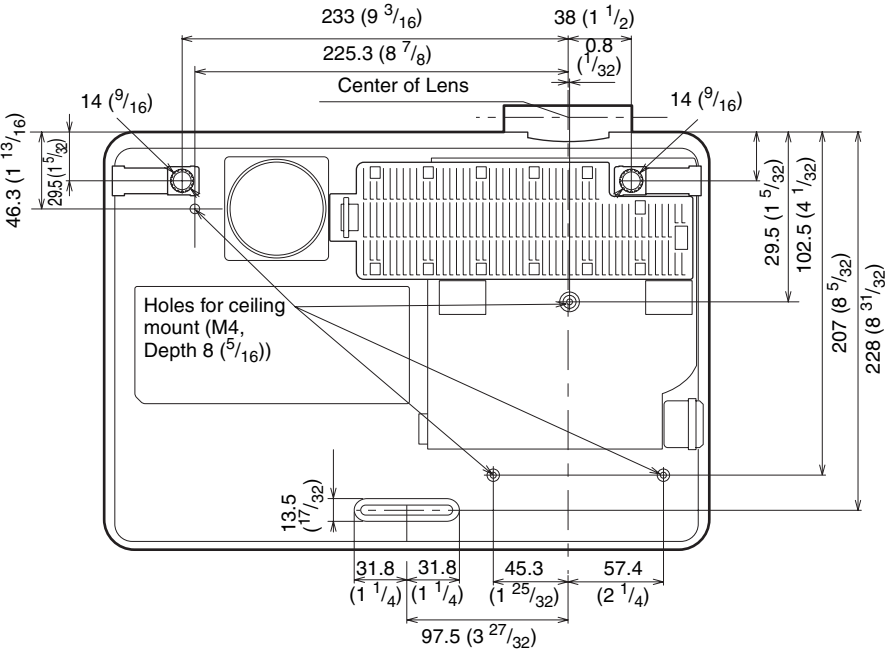

233 (9 3/16)

38 (1 1/2)

225.3 (8 7/8)

0.8
(1/32)

Center of Lens

14 (9/16)

14 (9/16)

46.3 (1 13/16)

29.5 (1 5/32)

29.5 (1 5/32)

102.5 (4 1/32)

Holes for ceiling
mount (M4,
Depth 8 (5/16))

207 (8 5/32)

228 (8 31/32)

13.5
(17/32)

31.8
(1 1/4)

31.8
(1 1/4)

45.3
(1 25/32)

57.4
(2 1/4)

97.5 (3 27/32)

Unit: mm (inches)

Bottom (VPL-EX575/EX570)

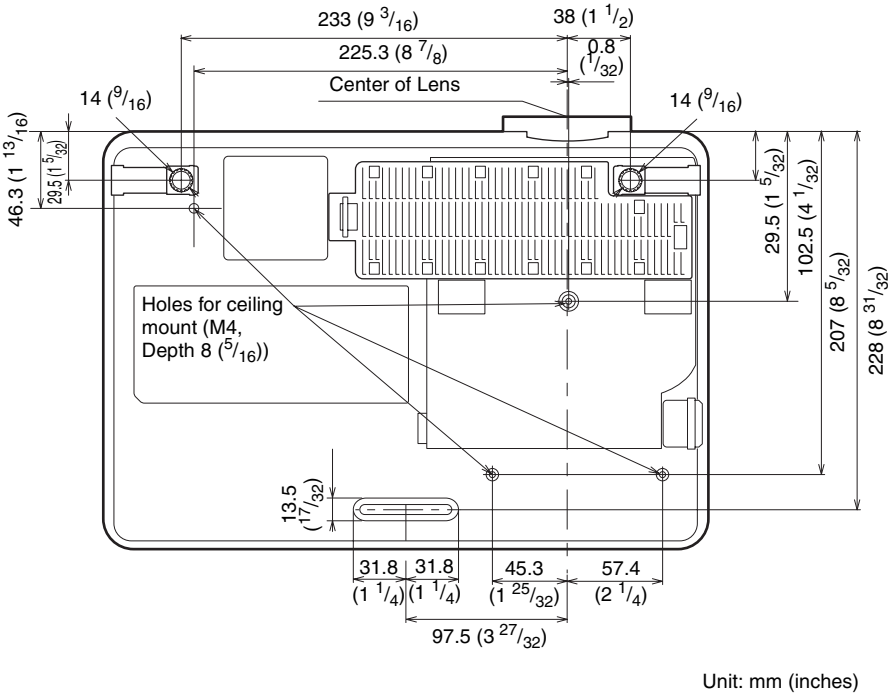

Others

Bottom (VPL-EW455/EW435/EX455/EX450/EX435/EX430)

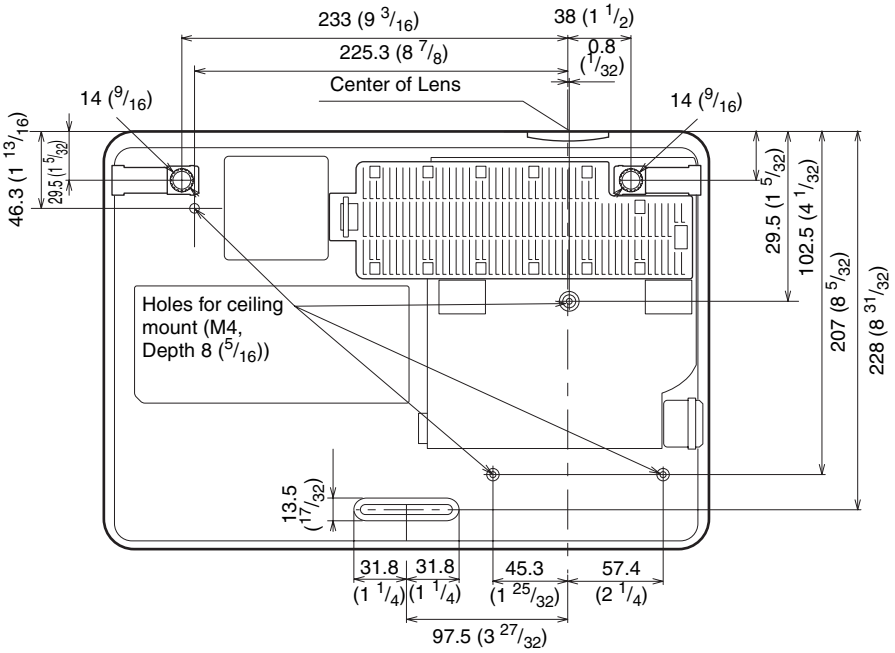

Unit: mm (inches)

END USER LICENSE AGREEMENT

IMPORTANT:

BEFORE USING THE SOFTWARE, PLEASE READ THIS END USER LICENSE AGREEMENT (“EULA”) CAREFULLY. BY USING THE SOFTWARE YOU ARE ACCEPTING THE TERMS OF THIS EULA. IF YOU DO NOT ACCEPT THE TERMS OF THIS EULA, YOU MAY NOT USE THE SOFTWARE.

This EULA is a legal agreement between you and Sony Corporation (“SONY”). This EULA governs your rights and obligations regarding the software of SONY and/or its third party licensors (including SONY’s affiliates) and their respective affiliates (collectively, the “THIRD-PARTY SUPPLIERS”), together with any updates/upgrades provided by SONY, any printed, on-line or other electronic documentation for such software, and any data files created by operation of such software (collectively, the “SOFTWARE”).

Notwithstanding the foregoing, any software in the SOFTWARE having a separate end user license agreement (including, but not limited to, GNU General Public license and Lesser/Library General Public License) shall be covered by such applicable separate end user license agreement in lieu of the terms of this EULA to the extent required by such separate end user license agreement (“EXCLUDED SOFTWARE”).

SOFTWARE LICENSE

The SOFTWARE is licensed, not sold. The SOFTWARE is protected by copyright and other intellectual property laws and international treaties.

COPYRIGHT

All right and title in and to the SOFTWARE (including, but not limited to, any images, photographs, animation, video, audio, music, text and “applets” incorporated into the SOFTWARE) is owned by SONY or one or more of the THIRD-PARTY SUPPLIERS.

GRANT OF LICENSE

SONY grants you a limited license to use the SOFTWARE solely in connection with your compatible device (“DEVICE”) and only for your individual, non-commercial use. SONY and the THIRD-PARTY SUPPLIERS expressly reserve all rights, title and interest (including, but not limited to, all intellectual property rights) in and to the SOFTWARE that this EULA does not specifically grant to you.

REQUIREMENTS AND LIMITATIONS

You may not copy, publish, adapt, redistribute, attempt to derive source code, modify, reverse engineer, decompile, or disassemble any of the SOFTWARE, whether in whole or in part, or create any derivative works from or of the SOFTWARE unless such derivative works are intentionally facilitated by the SOFTWARE. You may not modify or tamper with any digital rights management

functionality of the SOFTWARE. You may not bypass, modify, defeat or circumvent any of the functions or protections of the SOFTWARE or any mechanisms operatively linked to the SOFTWARE. You may not separate any individual component of the SOFTWARE for use on more than one DEVICE unless expressly authorized to do so by SONY. You may not remove, alter, cover or deface any trademarks or notices on the SOFTWARE. You may not share, distribute, rent, lease, sublicense, assign, transfer or sell the SOFTWARE. The software, network services or other products other than SOFTWARE upon which the SOFTWARE’S performance depends might be interrupted or discontinued at the discretion of the suppliers (software suppliers, service suppliers, or SONY). SONY and such suppliers do not warrant that the SOFTWARE, network services, contents or other products will continue to be available, or will operate without interruption or modification.

EXCLUDED SOFTWARE AND OPEN SOURCE COMPONENTS

Notwithstanding the foregoing limited license grant, you acknowledge that the SOFTWARE may include EXCLUDED SOFTWARE. Certain EXCLUDED SOFTWARE may be covered by open source software licenses (“Open Source Components”), which means any software licenses approved as open source licenses by the Open Source Initiative or any substantially similar licenses, including but not limited to any license that, as a condition of distribution of the software licensed under such license, requires that the distributor make the software available in source code format. If and to the extent disclosure is required, please visit <http://oss.sony.net/Products/Linux> or other SONY-designated web site for a list of applicable OPEN SOURCE COMPONENTS included in the SOFTWARE from time to time, and the applicable terms and conditions governing its use. Such terms and conditions may be changed by the applicable third party at any time without liability to you. To the extent required by the licenses covering EXCLUDED SOFTWARE, the terms of such licenses will apply in lieu of the terms of this EULA. To the extent the terms of the licenses applicable to EXCLUDED SOFTWARE prohibit any of the restrictions in this EULA with respect to such EXCLUDED SOFTWARE, such restrictions will not apply to such EXCLUDED SOFTWARE. To the extent the terms of the licenses applicable to Open Source Components require SONY to make an offer to provide source code in connection with the SOFTWARE, such offer is hereby made.

USE OF SOFTWARE WITH COPYRIGHTED MATERIALS

The SOFTWARE may be capable of being used by you to view, store, process and/or use content created by you and/or third parties. Such content may be protected by copyright, other intellectual property laws, and/or agreements. You agree to use the SOFTWARE only in compliance with all such laws and agreements that apply to such content. You acknowledge and agree that SONY may take appropriate measures to protect the copyright of content stored, processed or used by the SOFTWARE. Such measures include, but are not limited to, counting the frequency of your backup and restoration through certain SOFTWARE features,



Others

refusal to accept your request to enable restoration of data, and termination of this EULA in the event of your illegitimate use of the SOFTWARE.

CONTENT SERVICE

PLEASE ALSO NOTE THAT THE SOFTWARE MAY BE DESIGNED TO BE USED WITH CONTENT AVAILABLE THROUGH ONE OR MORE CONTENT SERVICES (“CONTENT SERVICE”). USE OF THE SERVICE AND THAT CONTENT IS SUBJECT TO THE TERMS OF SERVICE OF THAT CONTENT SERVICE. IF YOU DECLINE TO ACCEPT THOSE TERMS, YOUR USE OF THE SOFTWARE WILL BE LIMITED. You acknowledge and agree that certain content and services available through the SOFTWARE may be provided by third parties over which SONY has no control. USE OF THE CONTENT SERVICE REQUIRES AN INTERNET CONNECTION. THE CONTENT SERVICE MAY BE DISCONTINUED AT ANY TIME.

INTERNET CONNECTIVITY AND THIRD PARTY SERVICES

You acknowledge and agree that access to certain SOFTWARE features may require an Internet connection for which you are solely responsible. Further, you are solely responsible for payment of any third party fees associated with your Internet connection, including but not limited to Internet service provider or airtime charges. Operation of the SOFTWARE may be limited or restricted depending on the capabilities, bandwidth or technical limitations of your Internet connection and service. The provision, quality and security of such Internet connectivity are the sole responsibility of the third party providing such service.

EXPORT AND OTHER REGULATIONS

You agree to comply with all applicable export and re-export restrictions and regulations of the area or country in which you reside, and not to transfer, or authorize the transfer, of the SOFTWARE to a prohibited country or otherwise in violation of any such restrictions or regulations.

HIGH RISK ACTIVITIES

The SOFTWARE is not fault-tolerant and is not designed, manufactured or intended for use or resale as on-line control equipment in hazardous environments requiring fail-safe performance, such as in the operation of nuclear facilities, aircraft navigation or communication systems, air traffic control, direct life support machines, or weapons systems, in which the failure of the SOFTWARE could lead to death, personal injury, or severe physical or environmental damage (“HIGH RISK ACTIVITIES”). SONY, each of the THIRD-PARTY SUPPLIERS, and each of their respective affiliates specifically disclaim any express or implied warranty, duty or condition of fitness for HIGH RISK ACTIVITIES.

EXCLUSION OF WARRANTY ON SOFTWARE

You acknowledge and agree that use of the SOFTWARE is at your sole risk and that you are responsible for use of the SOFTWARE. The SOFTWARE is provided “AS IS,” without warranty, duty or condition of any kind.

SONY AND EACH OF THE THIRD-PARTY SUPPLIERS (for purposes of this Section, SONY and each of the THIRD-PARTY SUPPLIERS shall be collectively referred to as “SONY”) EXPRESSLY DISCLAIM ALL WARRANTIES, DUTIES OR CONDITIONS, EXPRESS OR IMPLIED, INCLUDING, BUT NOT LIMITED TO, THE IMPLIED WARRANTIES OF MERCHANTABILITY, NONINFRINGEMENT AND FITNESS FOR A PARTICULAR PURPOSE. SONY DOES NOT WARRANT OR MAKE ANY CONDITIONS OR REPRESENTATIONS (A) THAT THE FUNCTIONS CONTAINED IN ANY OF THE SOFTWARE WILL MEET YOUR REQUIREMENTS OR THAT THEY WILL BE UPDATED, (B) THAT THE OPERATION OF ANY OF THE SOFTWARE WILL BE CORRECT OR ERROR-FREE OR THAT ANY DEFECTS WILL BE CORRECTED, (C) THAT THE SOFTWARE WILL NOT DAMAGE ANY OTHER SOFTWARE, HARDWARE OR DATA, (D) THAT ANY SOFTWARE, NETWORK SERVICES (INCLUDING THE INTERNET) OR PRODUCTS (OTHER THAN THE SOFTWARE) UPON WHICH THE SOFTWARE’S PERFORMANCE DEPENDS WILL CONTINUE TO BE AVAILABLE, UNINTERRUPTED OR UNMODIFIED, AND (E) REGARDING THE USE OR THE RESULTS OF THE USE OF THE SOFTWARE IN TERMS OF ITS CORRECTNESS, ACCURACY, RELIABILITY, OR OTHERWISE.

NO ORAL OR WRITTEN INFORMATION OR ADVICE GIVEN BY SONY OR AN AUTHORIZED REPRESENTATIVE OF SONY SHALL CREATE A WARRANTY, DUTY OR CONDITION OR IN ANY WAY INCREASE THE SCOPE OF THIS WARRANTY. SHOULD THE SOFTWARE PROVE DEFECTIVE YOU ASSUME THE ENTIRE COST OF ALL NECESSARY SERVICING, REPAIR OR CORRECTION. SOME JURISDICTIONS DO NOT ALLOW THE EXCLUSION OF IMPLIED WARRANTIES, SO THESE EXCLUSIONS MAY NOT APPLY TO YOU.

LIMITATION OF LIABILITY

SONY AND EACH OF THE THIRD-PARTY SUPPLIERS (for purposes of this Section, SONY and each of the THIRD-PARTY SUPPLIERS shall be collectively referred to as “SONY”) SHALL NOT BE LIABLE FOR ANY INCIDENTAL OR CONSEQUENTIAL DAMAGES FOR BREACH OF ANY EXPRESS OR IMPLIED WARRANTY, BREACH OF CONTRACT, NEGLIGENCE, STRICT LIABILITY OR UNDER ANY OTHER LEGAL THEORY RELATED TO THE SOFTWARE, INCLUDING, BUT NOT LIMITED TO, ANY DAMAGES ARISING OUT OF LOSS OF PROFITS, LOSS OF REVENUE, LOSS OF DATA, LOSS OF USE OF THE SOFTWARE OR ANY ASSOCIATED HARDWARE, DOWNTIME AND USER’S TIME, EVEN IF ANY OF THEM HAVE BEEN ADVISED OF THE POSSIBILITY OF SUCH DAMAGES. IN ANY CASE, EACH AND ALL OF THEIR AGGREGATE LIABILITY UNDER ANY PROVISION OF THIS EULA SHALL BE LIMITED TO THE AMOUNT ACTUALLY PAID FOR THE PRODUCT. SOME JURISDICTIONS DO NOT ALLOW THE EXCLUSION OR LIMITATION OF INCIDENTAL

OR CONSEQUENTIAL DAMAGES, SO THE ABOVE EXCLUSION OR LIMITATION MAY NOT APPLY TO YOU.

CONSENT TO USE OF NON-PERSONAL INFORMATION, LOCATION DATA, DATA SECURITY

You acknowledge and agree that SONY and its affiliates, partners and agents may read, collect, transfer, process and store certain information collected from the SOFTWARE, including but not limited to information about (i) the SOFTWARE and (ii) the software applications, contents and peripheral devices that interact with your DEVICE and the SOFTWARE (“Information”). Information includes, but is not limited to: (1) unique identifiers relating to your DEVICE and its components; (2) performance of the DEVICE, the SOFTWARE and their components; (3) configurations of your DEVICE, the SOFTWARE and the software applications, contents and peripheral devices that interact with the DEVICE and the SOFTWARE; (4) use and frequency of use of the functions of (x) the SOFTWARE, and (y) the software applications, contents and peripheral devices that interact with the SOFTWARE; and (5) location data, as indicated below. SONY and its affiliates, partners and agents may use and disclose Information subject to applicable laws in order to improve its products and services or to provide products or services to you. Such uses include, but are not limited to: (a) administering the functionalities of the SOFTWARE; (b) to improve, service, update or upgrade the SOFTWARE; (c) improving, developing and enhancing the current and future products and services of SONY and other parties; (d) to provide you with information about the products and services offered by SONY and other parties; (e) complying with applicable laws or regulations; and (f) to the extent offered, providing you with location-based services of SONY and other parties, as indicated below. In addition, SONY retains the right to use Information to protect itself and third parties from illegal, criminal or harmful conduct.

Certain services available through the SOFTWARE may rely upon location information, including, but not limited to, the geographic location of the DEVICE. You acknowledge that for the purpose of providing such services, SONY, the THIRD-PARTY SUPPLIERS or their partners may collect, archive, process and use such location data, and that such services are governed by the privacy policies of SONY or such third party. By using any such services, you agree that you have reviewed the privacy policies applicable to such services and consent to such activities.

SONY, its affiliates, partners and agents will not intentionally use Information to personally identify the owner or user of the SOFTWARE without your knowledge or consent. Any use of Information will be in accordance with the privacy policies of SONY or such third party. Please contact applicable contact address of each area or country for SONY’s current privacy policy.

Please contact applicable third parties for privacy policies relating to personally identifiable and other information you provide when you use or access third party software or services.

Information may be processed, stored or transferred to SONY, its affiliates or agents which are located in countries outside of your country of residence. Data protection and information privacy laws in certain countries may not offer the same level of protection as your country of residence and you may have fewer legal rights in relation to Information processed and stored in, or transferred to, such countries. SONY will use reasonable efforts to take appropriate technical and organizational steps to prevent unauthorized access to or disclosure of Information, but does not warrant it will eliminate all risk of misuse of such Information.

AUTOMATIC UPDATE FEATURE

From time to time, SONY or the THIRD-PARTY SUPPLIERS may automatically update or otherwise modify the SOFTWARE, including, but not limited to, for purposes of enhancement of security functions, error correction and improvement of functions, at such time as you interact with SONY’s or third parties’ servers, or otherwise. Such updates or modifications may delete or change the nature of features or other aspects of the SOFTWARE, including, but not limited to, functions you may rely upon. You acknowledge and agree that such activities may occur at SONY’s sole discretion and that SONY may condition continued use of the SOFTWARE upon your complete installation or acceptance of such update or modifications. Any updates/modifications shall be deemed to be, and shall constitute part of, the SOFTWARE for purposes of this EULA. By acceptance of this EULA, you consent to such update/modification.

ENTIRE AGREEMENT, WAIVER, SEVERABILITY

This EULA and SONY’s privacy policy, each as amended and modified from time to time, together constitute the entire agreement between you and SONY with respect to the SOFTWARE. The failure of SONY to exercise or enforce any right or provision of this EULA shall not constitute a waiver of such right or provision. If any part of this EULA is held invalid, illegal, or unenforceable, that provision shall be enforced to the maximum extent permissible so as to maintain the intent of this EULA, and the other parts will remain in full force and effect.

GOVERNING LAW AND JURISDICTION

The United Nations Convention on Contracts for the International Sale of Goods shall not apply to this EULA. This EULA shall be governed by the laws of Japan, without regards to conflict of laws provisions. Any dispute arising out of this EULA shall be subject to the exclusive venue of the Tokyo District Court in Japan, and the parties hereby consent to the venue and jurisdiction of such courts.

EQUITABLE REMEDIES

Notwithstanding anything contained in this EULA to the contrary, you acknowledge and agree that any violation of or non-compliance with this EULA by you will cause irreparable harm to SONY, for which monetary damages would be inadequate, and you consent to SONY obtaining any injunctive or equitable relief that SONY deems necessary or appropriate in such circumstances. SONY may also take any legal and technical remedies to prevent violation of and/or to enforce this EULA, including, but not limited to, immediate termination of your use



Others

of the SOFTWARE, if SONY believes in its sole discretion that you are violating or intend to violate this EULA. These remedies are in addition to any other remedies SONY may have at law, in equity or under contract.

TERMINATION

Without prejudice to any of its other rights, SONY may terminate this EULA if you fail to comply with any of its terms. In case of such termination, you must: (i) cease all use, and destroy any copies, of the SOFTWARE; (ii) comply with the requirements in the section below entitled "Your Account Responsibilities".

AMENDMENT

SONY RESERVES THE RIGHT TO AMEND ANY OF THE TERMS OF THIS EULA AT ITS SOLE DISCRETION BY POSTING NOTICE ON A SONY DESIGNATED WEB SITE, BY EMAIL NOTIFICATION TO AN EMAIL ADDRESS PROVIDED BY YOU, BY PROVIDING NOTICE AS PART OF THE PROCESS IN WHICH YOU OBTAIN UPGRADES/UPDATES OR BY ANY OTHER LEGALLY RECOGNIZABLE FORM OF NOTICE. If you do not agree to the amendment, you should promptly contact SONY for instructions. Your continued use of the SOFTWARE after the effective date of any such notice shall be deemed your agreement to be bound by such amendment.

THIRD-PARTY BENEFICIARIES

Each THIRD-PARTY SUPPLIER is an express intended third-party beneficiary of, and shall have the right to enforce, each provision of this EULA with respect to the SOFTWARE of such party.

YOUR ACCOUNT RESPONSIBILITIES

Should you return your DEVICE to its place of purchase, sell or otherwise transfer your DEVICE, or if this EULA is terminated, you are responsible for and must uninstall the SOFTWARE from the DEVICE and delete any and all accounts you may have established on DEVICE or are accessible through the SOFTWARE. You are solely responsible for maintaining the confidentiality of any accounts you have with SONY OR third parties and any usernames and passwords associated with YOUR USE OF the DEVICE.

Should you have any questions concerning this EULA, you may contact SONY by writing to SONY at applicable contact address of each area or country.

Copyright © 2012 Sony Corporation.

Index

A

AC IN	6
Acceptable input signal	75
Adjust Signal	26
Air filter	68
Air filter cover/Ventilation holes (intake)	4
APA	7
Aspect	7, 25, 27

B

BLANK	7
Brightness	24

C

CC Display	29
Color	24
Color Temp.	24
Connecting a computer	9
Connecting a Video equipment	11
Connecting an external monitor and audio equipment	15
Constant Brightness	32
Contrast	24
Control Key Lock	30
Control Panel Keys	7
Correcting trapezoidal distortion of the projected image (Keystone feature)	7, 19

D

Digital Zoom	7
--------------------	---

E

ECO MODE (Energy-saving mode)	8
-------------------------------------	---

F

fH	35
Focus	17
Focus ring	4
Freeze	7
Front feet (adjustable)	18
fV	35

G

Gamma Mode	24
------------------	----

H

H (Horizontal)	26
HDBaseT connector	6
High Altitude Mode	34
Hue	24

I

Image Flip	34
Indicators	60
Information menu	35
Input	5
Installation Attitude	34
Installation menu	34

K

Keystone	7
----------------	---

L

Lamp cover	4
Lamp Timer	35
Lamp Timer Reset	29
LAN connector	6
LAN terminal	6
Language	30
Location and function of controls	4

M

Main unit	4
Messages list	62
Model Name	35
MUTING	7

N

Network Features	36
------------------------	----

O

Operation menu	30
Optional accessories	73
Output	6

P

Phase, Pitch, Shift	26
Picture menu	24
Picture mode	24
Pin assignment	74
Projecting an image	16
Projector Station for Network Presentation	47

R

Remote commander	7
Remote Control Receiver	4
Replacing the lamp	66
Reset	24
RS-232C	6

S

Security bar	4
Security Lock	4, 30
Selecting an input signal	7
Serial No.	35
Sharpness	24
Signal Type	35
Smart APA	29
Speaker	29
Specifications	69
Start Up Image	29
Status	30

T

Terminal	4, 5
The Connection/Power Menu	31
The Function menu	29
The Screen menu	25
Troubleshooting	63
Turn off	7, 22
Turn on	7, 16

U

USB Display	54
USB Media Viewer	56
Using a menu	23
Using the e-mail report Function	38

V

V Keystone	7, 19, 34
Ventilation holes	4
Volume	7

W

WARNING indicator	4, 60
With No Input	32
With Static Signal	32

Z

Zoom	17
------------	----

About Trademarks

- Adobe and Adobe Acrobat are trademarks or registered trademarks of Adobe Systems Incorporated in the United States and/or other countries.
- Kensington is a registered trademark of Kensington Technology Group.
- The terms HDMI and HDMI High-Definition Multimedia Interface, and the HDMI Logo are trademarks or registered trademarks of HDMI Licensing LLC in the United States and other countries.
- Internet Explore is registered trademarks of Microsoft Corporation in the United States and/or other countries.
- PJLink is a registered trademark of Japan Business Machine and Information System Industries Association.
- AMX is a trademark of AMX Corporation.
- Crestron RoomView is a trademark of Crestron Corporation.
- Mac and Mac OS are registered trademarks of Apple Inc. in the U.S. and other countries.
- HDBaseT™ and the HDBaseT Alliance logo are trademarks of the HDBaseT Alliance.
- All other trademarks and registered trademarks are trademarks or registered trademarks of their respective holders. In this manual, ™ and ® marks are not specified.

