



CX310 Series and CX317

User's Guide

March 2017

www.lexmark.com

Machine type(s):

7527

Model(s):

211, 231

Contents

- Safety information..... 6**
 - Conventions..... 6

- Learning about the printer..... 8**
 - Finding information about the printer.....8
 - Selecting a location for the printer.....9
 - Printer configurations..... 10
 - Understanding the basic functions of the scanner..... 11
 - Using the ADF and scanner glass.....12
 - Using the printer control panel..... 12
 - Understanding the colors of the Sleep button and indicator lights..... 13

- Additional printer setup..... 14**
 - Installing internal options..... 14
 - Installing hardware options..... 20
 - Attaching cables..... 22
 - Setting up the printer software..... 23
 - Networking..... 24
 - Verifying printer setup..... 28

- Loading paper and specialty media..... 29**
 - Setting the paper size and type..... 29
 - Configuring Universal paper settings..... 29
 - Loading the 250-sheet tray..... 29
 - Loading the manual feeder..... 32
 - Loading the 650-sheet duo tray..... 33
 - Loading the multipurpose feeder..... 34
 - Linking and unlinking trays..... 37

- Paper and specialty media guide..... 40**
 - Using specialty media..... 40
 - Paper guidelines..... 43
 - Supported paper sizes, types, and weights..... 46

Printing.....	50
Printing a document.....	50
Printing from a mobile device.....	51
Printing confidential and other held jobs.....	52
Printing information pages.....	54
Canceling a print job.....	54
Copying.....	55
Making copies.....	55
Copying photos.....	56
Copying on specialty media.....	56
Customizing copy settings.....	58
Placing information on copies.....	62
Canceling a copy job.....	63
Understanding the copying options.....	63
E-mailing.....	66
Setting up the printer to e-mail.....	66
Creating an e-mail shortcut.....	67
E-mailing a document.....	67
Canceling an e-mail.....	68
Scanning.....	69
Scanning to an FTP address.....	69
Scanning to a computer.....	71
Understanding the printer menus.....	73
Menus list.....	73
Supplies menu.....	74
Paper menu.....	74
Reports menu.....	84
Network/Ports.....	84
Security menu.....	92
Settings menu.....	95
Saving money and the environment.....	122
Saving paper and toner.....	122

Saving energy..... 122
Recycling..... 126

Securing the printer..... 127

Using the security lock feature..... 127
Statement of Volatility..... 127
Erasing volatile memory..... 128
Erasing non-volatile memory..... 128
Finding printer security information..... 128

Maintaining the printer..... 129

Storing supplies..... 129
Cleaning the printer..... 129
Checking the status of parts and supplies..... 131
Estimated number of remaining pages..... 131
Ordering supplies..... 132
Replacing supplies..... 134
Moving the printer..... 153

Managing the printer..... 155

Finding advanced networking and administrator information..... 155
Checking the virtual display..... 155
Setting up e-mail alerts..... 155
Viewing reports..... 156
Configuring supply notifications from the Embedded Web Server..... 156
Copying printer settings to other printers..... 157
Restoring factory default settings..... 157

Clearing jams..... 158

Avoiding jams..... 158
Identifying jam locations..... 159
Paper jam in the standard bin..... 161
Paper jam in the front door..... 162
Paper jam in trays..... 164
Paper jam in the manual feeder..... 165
Paper jam in the multipurpose feeder..... 165
Paper jam in the automatic document feeder..... 166

Troubleshooting.....	168
Understanding the printer messages.....	168
Solving printer problems.....	181
Solving print problems.....	187
Solving copy problems.....	214
Solving scanner problems.....	217
Embedded Web Server does not open.....	221
Contacting customer support.....	223
Notices.....	224
Product information.....	224
Edition notice.....	224
Power consumption.....	228
Index.....	235

Safety information

Conventions

Note: A *note* identifies information that could help you.

Warning: A *warning* identifies something that could damage the product hardware or software.

CAUTION: A *caution* indicates a potentially hazardous situation that could injure you.

Different types of caution statements include:



CAUTION—POTENTIAL INJURY: Indicates a risk of injury.



CAUTION—SHOCK HAZARD: Indicates a risk of electrical shock.



CAUTION—HOT SURFACE: Indicates a risk of burn if touched.



CAUTION—TIPPING HAZARD: Indicates a crush hazard.



CAUTION—PINCH HAZARD: Indicates a risk of being caught between moving parts.



CAUTION—POTENTIAL INJURY: To avoid the risk of fire or electrical shock, connect the power cord to an appropriately rated and properly grounded electrical outlet that is near the product and easily accessible.



CAUTION—POTENTIAL INJURY: Do not use this product with extension cords, multioutlet power strips, multioutlet extenders, or other types of surge or UPS devices. The power rating capacity of these types of accessories can be easily overloaded by a laser printer and may result in poor printer performance, property damage, or potential fire.

Do not place or use this product near water or wet locations.



CAUTION—POTENTIAL INJURY: This product uses a laser. Use of controls or adjustments or performance of procedures other than those specified herein may result in hazardous radiation exposure.

This product uses a printing process that heats the print media, and the heat may cause the media to release emissions. You must understand the section in your operating instructions that discusses the guidelines for selecting print media to avoid the possibility of harmful emissions.



CAUTION—HOT SURFACE: The inside of the printer might be hot. To reduce the risk of injury from a hot component, allow the surface to cool before touching.



CAUTION—POTENTIAL INJURY: The lithium battery in this product is not intended to be replaced. There is a danger of explosion if a lithium battery is incorrectly replaced. Do not recharge, disassemble, or incinerate a lithium battery. Discard used lithium batteries according to the manufacturer's instructions and local regulations.



CAUTION—POTENTIAL INJURY: The printer weight is greater than 18 kg (40 lb) and requires two or more trained personnel to lift it safely.





CAUTION—POTENTIAL INJURY: When moving the printer, follow these guidelines to avoid personal injury or printer damage:

- Make sure that all doors and trays are closed.

- Turn off the printer, and then unplug the power cord from the electrical outlet.
- Disconnect all cords and cables from the printer.
- If the printer has a caster base, then carefully roll it to the new location. Use caution when passing over thresholds and breaks in flooring.
- If the printer does not have a caster base but is configured with optional trays, then lift the printer off the trays. Do not try to lift the printer and the trays at the same time.
- Always use the handholds on the printer to lift it.
- Any cart used to move the printer must have a surface able to support the full footprint of the printer.
- Any cart used to move the hardware options must have a surface able to support the dimensions of the options.
- Keep the printer in an upright position.
- Avoid severe jarring movements.
- Make sure that your fingers are not under the printer when you set it down.
- Make sure that there is adequate clearance around the printer.

 **CAUTION—POTENTIAL INJURY:** To avoid the risk of fire or electrical shock, use only the power cord provided with this product or the manufacturer's authorized replacement.

 **CAUTION—SHOCK HAZARD:** If you are accessing the controller board or installing optional hardware or memory devices sometime after setting up the printer, then turn the printer off, and unplug the power cord from the electrical outlet before continuing. If you have any other devices attached to the printer, then turn them off as well, and unplug any cables going into the printer.

 **CAUTION—SHOCK HAZARD:** Make sure that all external connections (such as Ethernet and telephone system connections) are properly installed in their marked plug-in ports.

This product is designed, tested, and approved to meet strict global safety standards with the use of specific manufacturer's components. The safety features of some parts may not always be obvious. The manufacturer is not responsible for the use of other replacement parts.

 **CAUTION—POTENTIAL INJURY:** Do not cut, twist, bind, crush, or place heavy objects on the power cord. Do not subject the power cord to abrasion or stress. Do not pinch the power cord between objects such as furniture and walls. If any of these things happen, a risk of fire or electrical shock results. Inspect the power cord regularly for signs of such problems. Remove the power cord from the electrical outlet before inspecting it.

Refer service or repairs, other than those described in the user documentation, to a service representative.

 **CAUTION—SHOCK HAZARD:** To avoid the risk of electrical shock when cleaning the exterior of the printer, unplug the power cord from the electrical outlet and disconnect all cables from the printer before proceeding.

 **CAUTION—TIPPING HAZARD:** Floor-mounted configurations require additional furniture for stability. You must use either a printer stand or printer base if you are using multiple input options. If you purchased a multifunction printer (MFP) that scans, copies, and faxes, then you may need additional furniture. For more information, see www.lexmark.com/multifunctionprinters.

 **CAUTION—POTENTIAL INJURY:** To reduce the risk of equipment instability, load each tray separately. Keep all other trays closed until needed.

SAVE THESE INSTRUCTIONS.

Learning about the printer

Finding information about the printer

What are you looking for?	Find it here
Initial setup instructions: <ul style="list-style-type: none"> • Connecting the printer • Installing the printer software 	Setup documentation—The setup documentation came with the printer and is also available at http://support.lexmark.com .
Additional setup and instructions for using the printer: <ul style="list-style-type: none"> • Selecting and storing paper and specialty media • Loading paper • Configuring printer settings • Viewing and printing documents and photos • Setting up and using the printer software • Configuring the printer on a network • Caring for and maintaining the printer • Troubleshooting and solving problems 	<i>User's Guide</i> and <i>Quick Reference Guide</i> —The guides are available at http://support.lexmark.com . Note: These guides are also available in other languages.
Information on setting up and configuring the accessibility features of your printer	<i>Lexmark Accessibility Guide</i> —This guide is available at http://support.lexmark.com .
Help using the printer software	Windows or Mac Help—Open a printer software program or application, and then click Help . Click  to view context-sensitive information. Notes: <ul style="list-style-type: none"> • Help is automatically installed with the printer software. • The printer software is located in the printer program folder or on the desktop, depending on your operating system.

What are you looking for?	Find it here
<p>The latest supplemental information, updates, and customer support:</p> <ul style="list-style-type: none"> • Documentation • Driver downloads • Live chat support • E-mail support • Voice support 	<p>Lexmark support Web site— http://support.lexmark.com</p> <p>Note: Select your country or region, and then select your product to view the appropriate support site.</p> <p>Support telephone numbers and hours of operation for your country or region can be found on the support Web site or on the printed warranty that came with your printer.</p> <p>Record the following information (located on the store receipt and at the back of the printer), and have it ready when you contact customer support so that they may serve you faster:</p> <ul style="list-style-type: none"> • Machine Type number • Serial number • Date purchased • Store where purchased
<p>Warranty information</p>	<p>Warranty information varies by country or region:</p> <ul style="list-style-type: none"> • In the U.S.—See the Statement of Limited Warranty included with this printer, or go to http://support.lexmark.com. • In other countries and regions—See the printed warranty that came with this printer.

Selecting a location for the printer

 **CAUTION—POTENTIAL INJURY:** The printer weight is greater than 18 kg (40 lb) and requires two or more trained personnel to lift it safely.

When selecting a location for the printer, leave enough room to open trays, covers, and doors. If you plan to install any options, then leave enough room for them also. It is important to:

- Set up the printer near a properly grounded and easily accessible electrical outlet.
- Make sure airflow in the room meets the latest revision of the ASHRAE 62 standard or the CEN Technical Committee 156 standard.
- Provide a flat, sturdy, and stable surface.
- Keep the printer:
 - Clean, dry, and free of dust.
 - Away from stray staples and paper clips.
 - Away from the direct airflow of air conditioners, heaters, or ventilators.
 - Free from direct sunlight and humidity extremes.
- Observe the recommended temperatures and avoid fluctuations:

Ambient temperature	15.6 to 32.2°C (60 to 90°F)
Storage temperature	-40 to 43°C (-40 to 110°F)

- Allow the following recommended amount of space around the printer for proper ventilation:

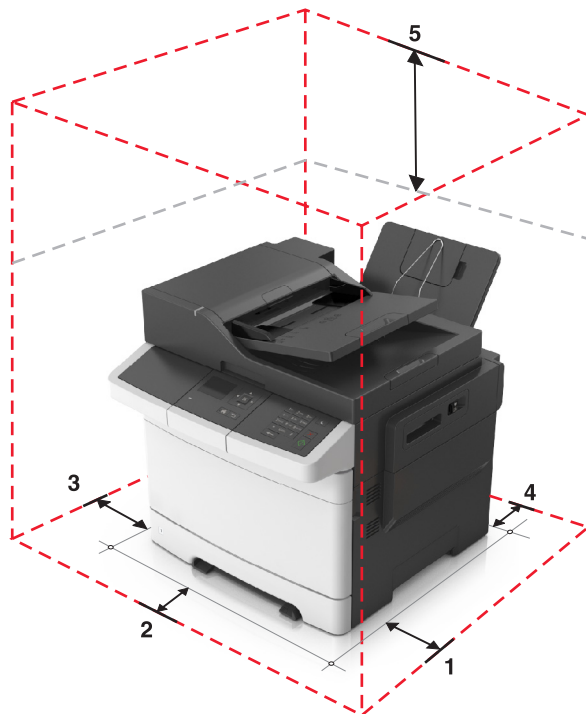

1	Right side	304.8 mm (12 in.)
2	Front	508 mm (20 in.)
3	Left side	76.2 (3 in.)
4	Rear	101.6 mm (4 in.)
5	Top	291.7 mm (11.5 in.)

Printer configurations

CAUTION—TIPPING HAZARD: Floor-mounted configurations require additional furniture for stability. You must use either a printer stand or printer base if you are using multiple input options. If you purchased a multifunction printer (MFP) that scans, copies, and faxes, then you may need additional furniture. For more information, see www.lexmark.com/multifunctionprinters.

Basic models

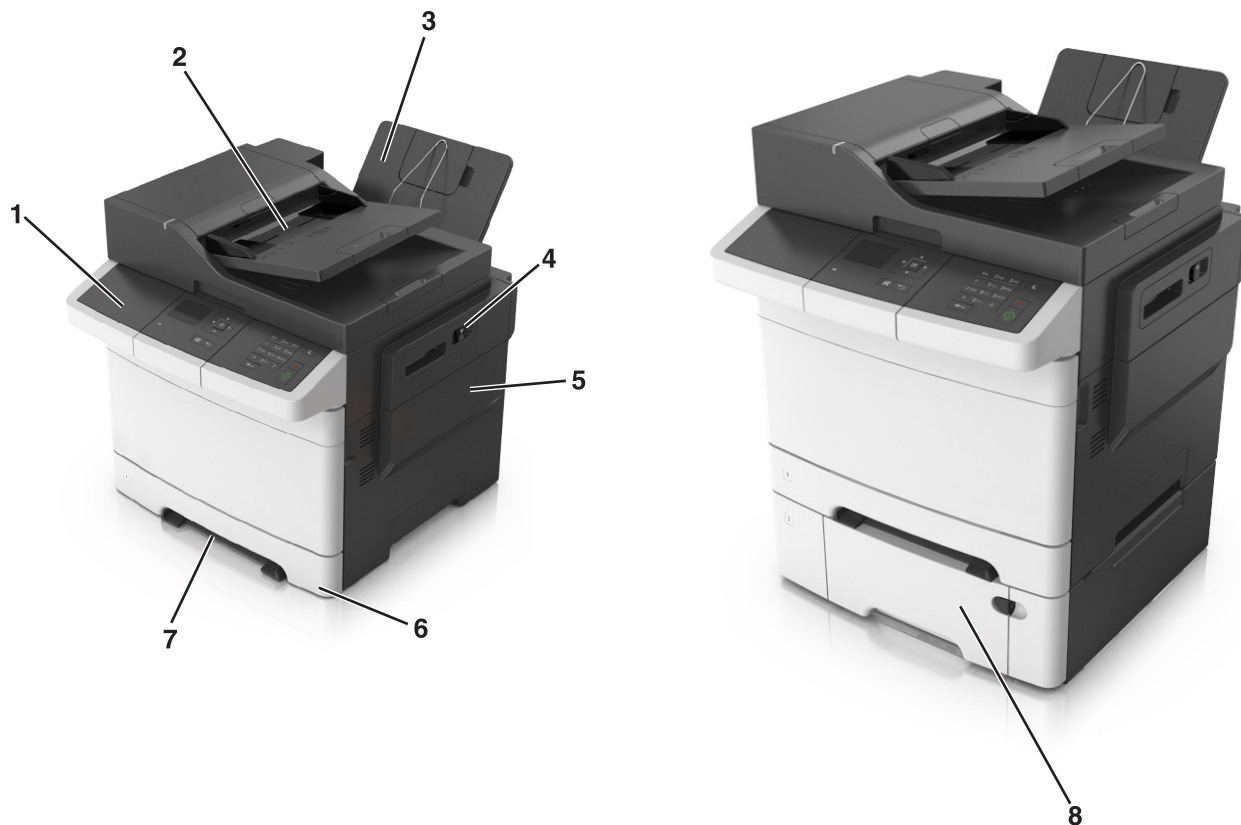



1	Printer control panel
2	Automatic document feeder (ADF)
3	Standard bin
4	Top door latch
5	Right side cover
6	Standard 250-sheet tray (Tray 1)
7	Manual feeder
8	Optional 650-sheet duo tray with integrated multipurpose feeder (Tray 2)

Understanding the basic functions of the scanner

- Make quick copies or set the printer to perform specific copy jobs.
- Scan documents and send them to your computer, an e-mail address, or an FTP destination.
- Scan documents and send them to another printer (PDF through an FTP).

Using the ADF and scanner glass

Automatic document feeder (ADF)	Scanner glass
 <p>Use the ADF for multiple-page documents.</p> <p>Note: The ADF scans only one side of the page.</p>	 <p>Use the scanner glass for single-page documents, book pages, small items (such as postcards or photos), transparencies, photo paper, or thin media (such as magazine clippings).</p>

Using the ADF

- Load the document into the ADF tray faceup, short edge first.
- Load up to 50 sheets of plain paper into the ADF tray.
- Scan sizes from 105 x 148 mm (4.1 x 5.8 inches) wide to 216 x 368 mm (8.5 x 14.5 inches) long.
- Scan media weights from 52 to 120 g/m² (14–32 lb).
- Do not load postcards, photos, small items, transparencies, photo paper, or thin media (such as magazine clippings) into the ADF tray. Place these items on the scanner glass.

Using the scanner glass

When using the scanner glass:

- Place the document facedown on the scanner glass in the corner with the green arrow.
- Scan or copy documents up to 216 x 296.9 mm (8.5 x 11.69 inches).
- Copy books up to 12.7 mm (0.5 inch) thick.

Using the printer control panel

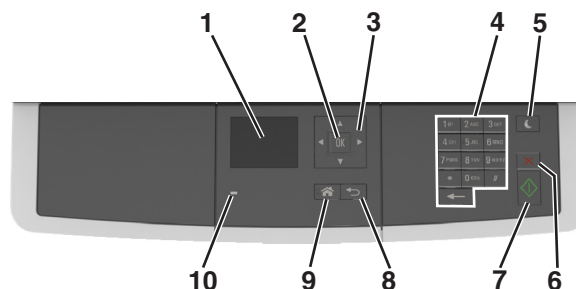

	Use the	To
1	Display	<ul style="list-style-type: none"> • View printing, copying, e-mailing, and scanning options. • View printer status and error messages.
2	Select button	<ul style="list-style-type: none"> • Select menu options. • Save settings.
3	Arrow buttons	Scroll through menus or settings on the display.
4	Keypad	Enter numbers, letters, or symbols.
5	Sleep button	Enable Sleep mode or Hibernate mode.
6	Cancel button	Stop all printer activity.
7	Start button	Start a job, depending on which mode is selected.
8	Back button	Return to the previous screen.
9	Home button	Go to the home screen.
10	Indicator light	Check the status of the printer.

Understanding the colors of the Sleep button and indicator lights

The colors of the Sleep button and indicator lights on the printer control panel signify a certain printer status or condition.

Indicator light	Printer status
Off	The printer is off or in Hibernate mode.
Blinking green	The printer is warming up, processing data, or printing.
Solid green	The printer is on, but idle.
Blinking red	The printer requires user intervention.
Sleep button light	Printer status
Off	The printer is off, idle or in Ready state.
Solid amber	The printer is in Sleep mode.
Blinking amber	The printer is entering or waking from Hibernate mode.
Blinking amber for 0.1 second, then goes completely off for 1.9 seconds in a slow, pulsing pattern	The printer is in Hibernate mode.

Additional printer setup

Installing internal options

 **CAUTION—SHOCK HAZARD:** If you are accessing the controller board or installing optional hardware or memory devices sometime after setting up the printer, then turn the printer off, and unplug the power cord from the electrical outlet before continuing. If you have any other devices attached to the printer, then turn them off as well, and unplug any cables going into the printer.

Warning—Potential Damage: Controller board electronic components are easily damaged by static electricity. Touch something metal on the printer before touching any controller board electronic components or connectors.

Available internal options

- Memory card
 - DDR3 DIMM
- Flash memory
 - Fonts
 - Firmware
 - Forms and Barcode
 - Prescribe
 - IPDS

Accessing the controller board

⚠ CAUTION—SHOCK HAZARD: If you are accessing the controller board or installing optional hardware or memory devices sometime after setting up the printer, then turn the printer off, and unplug the power cord from the electrical outlet before continuing. If you have any other devices attached to the printer, then turn them off as well, and unplug any cables going into the printer.

- 1 Access the controller board at the back of the printer.

Note: This task requires a flat-head screwdriver.

- 2 Turn the screws counterclockwise to remove them.

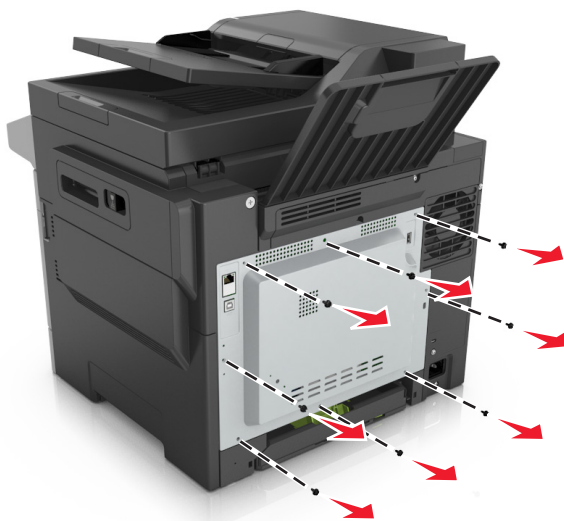

- 3 Slightly open the controller board access cover, and then shift to the right to remove it.

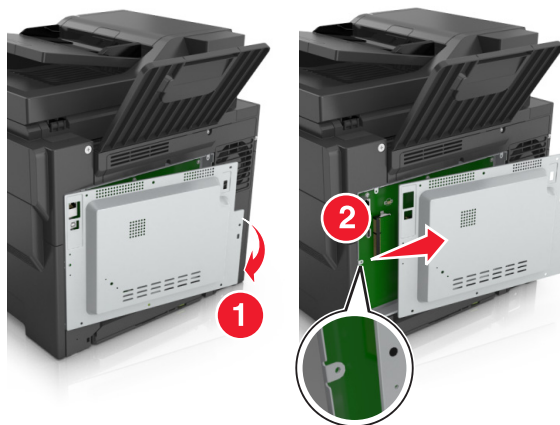

- 4 Locate the appropriate connector on the controller board.

Warning—Potential Damage: Controller board electronic components are easily damaged by static electricity. Touch something metal on the printer before touching any controller board electronic components or connectors.

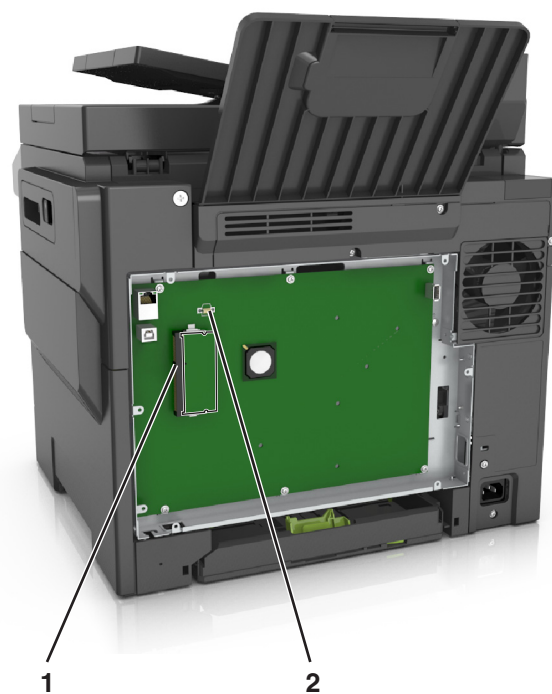

1	Memory card connector
2	Option card connector

5 Reattach the cover.

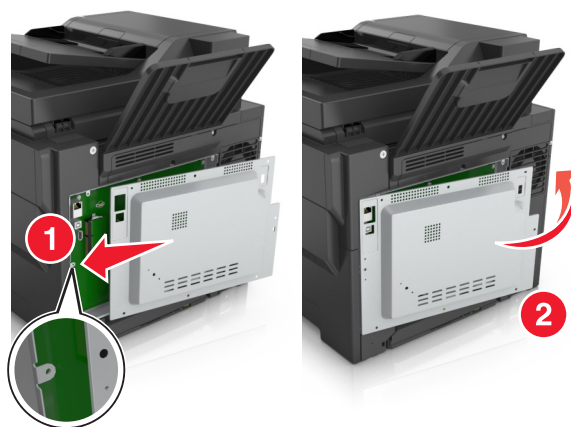

- 6 Turn the screws clockwise to lock the cover.

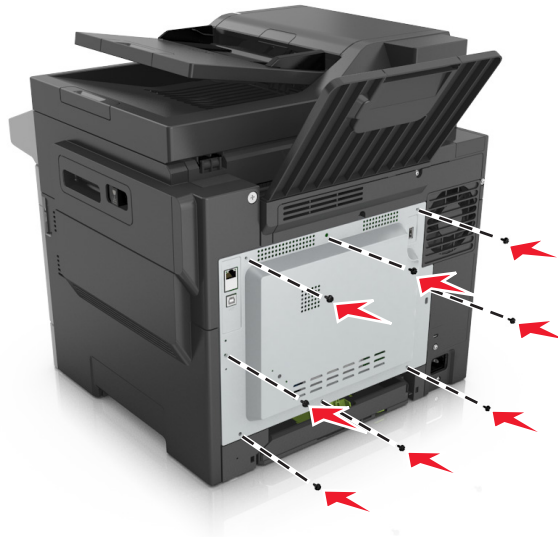

Installing a memory card

⚠ CAUTION—SHOCK HAZARD: If you are accessing the controller board or installing optional hardware or memory devices sometime after setting up the printer, then turn the printer off, and unplug the power cord from the electrical outlet before continuing. If you have any other devices attached to the printer, then turn them off as well, and unplug any cables going into the printer.

- 1 Access the controller board.

For more information, see [“Accessing the controller board” on page 15](#).

- 2 Unpack the memory card.

Warning—Potential Damage: Do not touch the connection points along the edge of the card. Doing so may cause damage.

- 3** Align the notch (1) on the memory card with the ridge (2) on the connector.

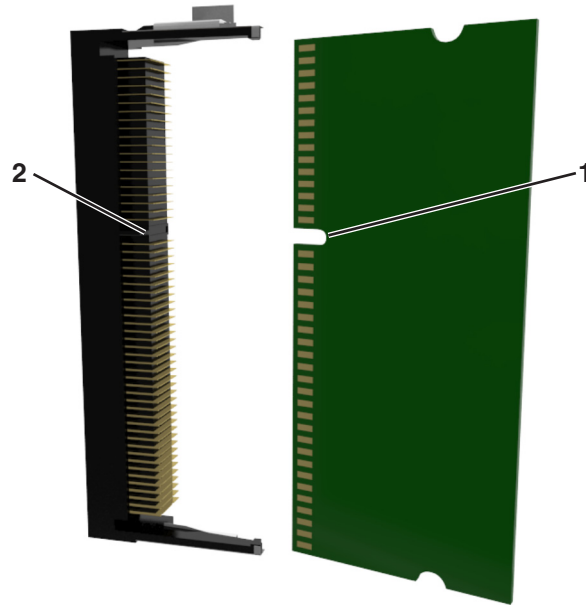

- 4** Push the memory card straight into the connector, and then push the card toward the controller board wall until it *clicks* into place.

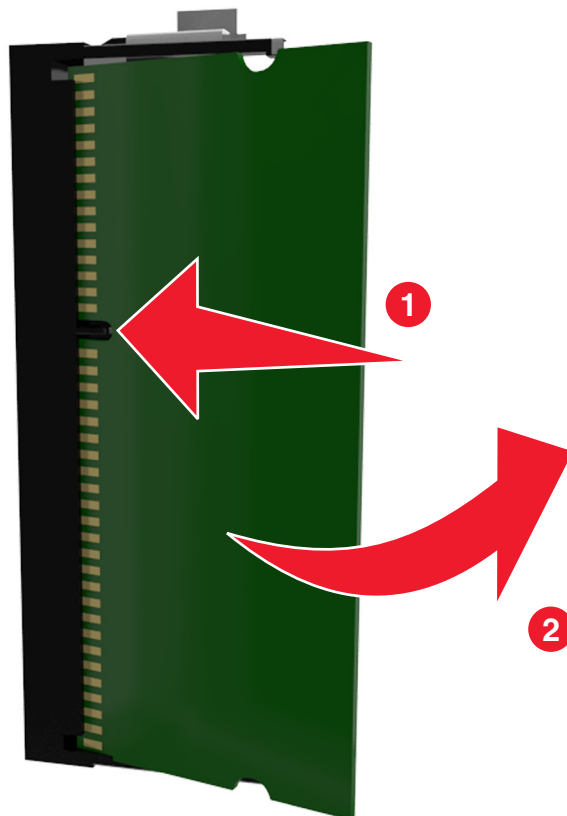

- 5** Close the controller board access cover.

Installing an optional card

⚠ CAUTION—SHOCK HAZARD: If you are accessing the controller board or installing optional hardware or memory devices sometime after setting up the printer, then turn the printer off, and unplug the power cord from the electrical outlet before continuing. If you have other devices attached to the printer, then turn them off as well, and unplug any cables going into the printer.

Warning—Potential Damage: Controller board electronic components are easily damaged by static electricity. Touch a metal surface on the printer before touching any controller board electronic components or connectors.

- 1 Access the controller board.

For more information, see [“Accessing the controller board” on page 15](#).

- 2 Unpack the optional card.

Warning—Potential Damage: Avoid touching the connection points along the edge of the card.

- 3 Holding the card by its sides, align the plastic pins (1) on the card with the holes (2) on the controller board.

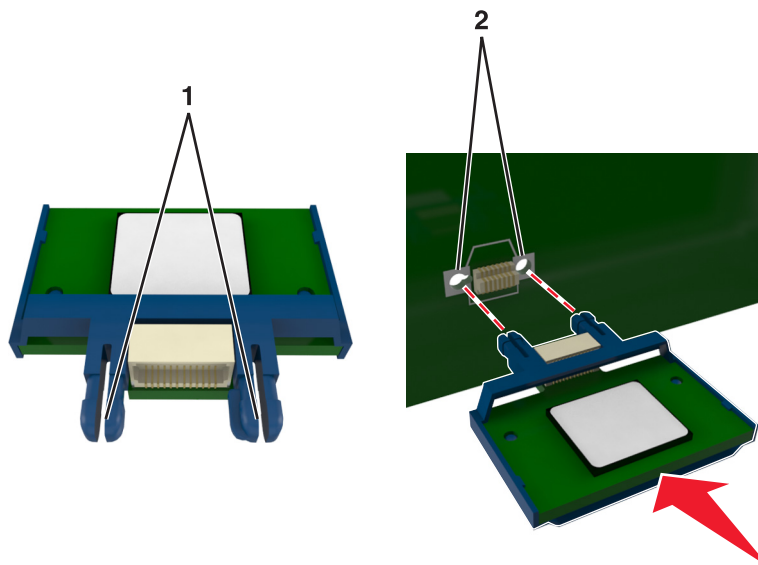

- 4 Push the card firmly into place as shown in the illustration.

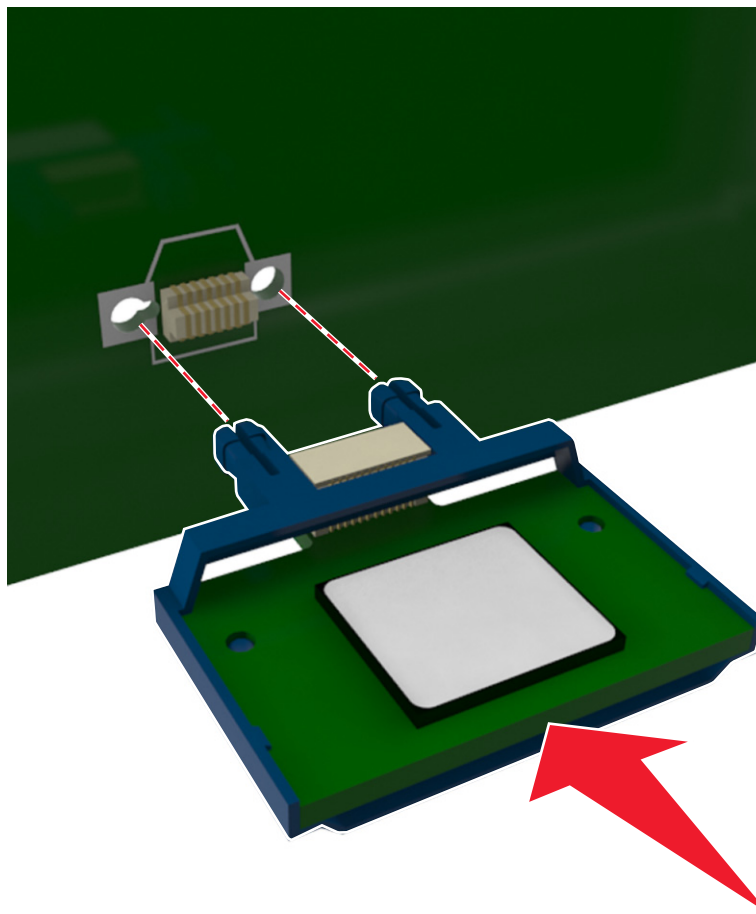

Warning—Potential Damage: Improper installation of the card may cause damage to the card and the controller board.

Note: The entire length of the connector on the card must touch and be flushed against the controller board.

- 5 Close the controller board access door.

Note: When the printer software and any hardware options are installed, it may be necessary to manually add the options in the printer driver to make them available for print jobs. For more information, see [“Adding available options in the print driver” on page 24.](#)

Installing hardware options

Order of installation

CAUTION—POTENTIAL INJURY: The printer weight is greater than 18 kg (40 lb) and requires two or more trained personnel to lift it safely.

⚠ CAUTION—SHOCK HAZARD: If you are accessing the controller board or installing optional hardware or memory devices sometime after setting up the printer, then turn the printer off, and unplug the power cord from the electrical outlet before continuing. If you have any other devices attached to the printer, then turn them off as well, and unplug any cables going into the printer.

Install the printer and any optional tray in the following order:

- Optional 650-sheet duo tray with integrated multipurpose feeder (Tray 2)
- Printer

Installing a 650-sheet duo tray

The printer supports an optional 650-sheet duo tray (Tray 2) with an integrated multipurpose feeder.

⚠ CAUTION—POTENTIAL INJURY: The printer weight is greater than 18 kg (40 lb) and requires two or more trained personnel to lift it safely.

⚠ CAUTION—SHOCK HAZARD: If you are accessing the controller board or installing optional hardware or memory devices sometime after setting up the printer, then turn the printer off, and unplug the power cord from the electrical outlet before continuing. If you have any other devices attached to the printer, then turn them off as well, and unplug any cables going into the printer.

- 1 Unpack the optional 650-sheet duo tray, and then remove all packing material and the dust cover.

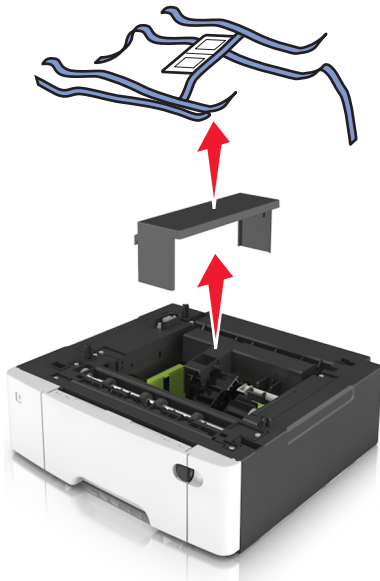

- 2 Place the tray in the location chosen for the printer.

- 3 Align the printer with the 650-sheet duo tray, and then lower the printer into place.



- 4 Install the dust cover.

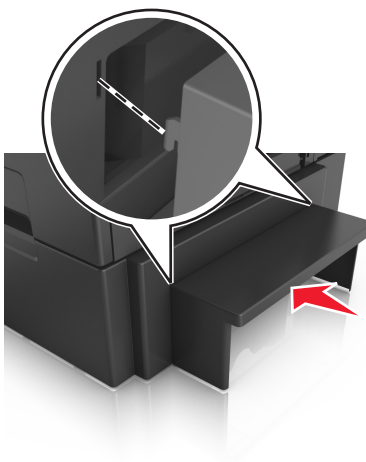

Note: When the printer software and any options are installed, it may be necessary to manually add the options in the printer driver to make them available for print jobs. For more information, see [“Adding available options in the print driver” on page 24](#).

Attaching cables

Connect the printer to the computer using a USB cable or to the network using an Ethernet cable.

Make sure to match the following:

- The USB symbol on the cable with the USB symbol on the printer
- The appropriate Ethernet cable to the Ethernet port

Warning—Potential Damage: Do not touch the USB cable, any network adapter, or the printer in the area shown while actively printing. Loss of data or a malfunction can occur.

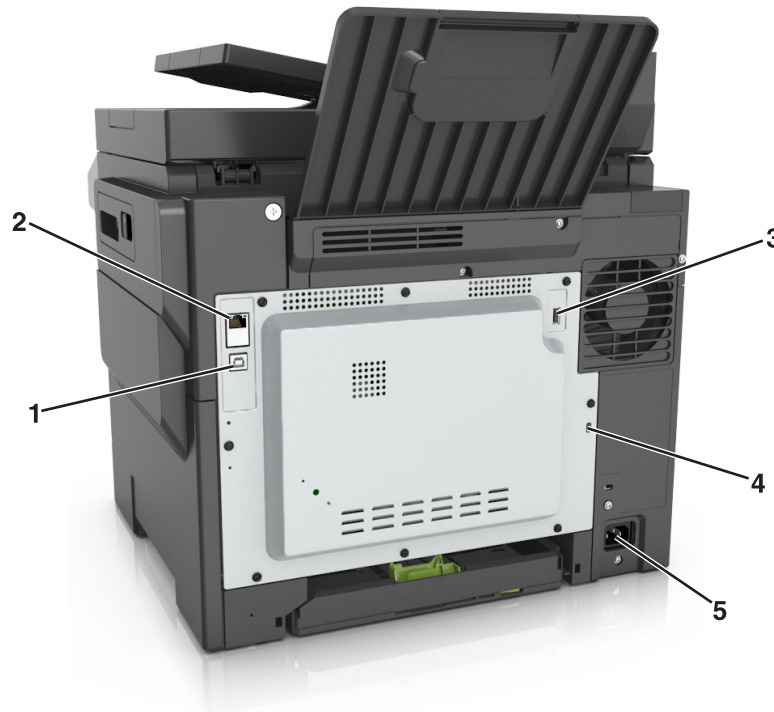

	Use the	To
1	USB printer port	Connect the printer to a computer.
2	Ethernet port	Connect the printer to an Ethernet network.
3	USB wireless port	Attach an optional wireless network adapter.
4	Security lock port	Lock the system controller board.
5	Printer power cord socket	Connect the printer to a properly grounded electrical outlet.

Setting up the printer software

Installing the printer software

- 1 Obtain a copy of the software installer package.
 - From the software CD that came with your printer.
 - Go to <http://support.lexmark.com>, and then select your printer and operating system.
- 2 Run the installer, and then follow the instructions on the computer screen.
- 3 For Macintosh users, add the printer.

Note: Obtain the printer IP address from the TCP/IP section in the Network/Ports menu.

Adding available options in the print driver

For Windows users

- 1 Open the printers folder.
- 2 Select the printer you want to update, and then do the following:
 - For Windows 7 or later, select **Printer properties**.
 - For earlier versions, select **Properties**.
- 3 Navigate to the Configuration tab, and then select **Update Now - Ask Printer**.
- 4 Apply the changes.

For Macintosh users

- 1 From System Preferences in the Apple menu, navigate to your printer, and then select **Options & Supplies**.
- 2 Navigate to the list of hardware options, and then add any installed options.
- 3 Apply the changes.

Networking

Notes:

- Purchase a MarkNet™ N8352 wireless network adapter before setting up the printer on a wireless network. For information on installing the wireless network adapter, see the instruction sheet that came with the adapter.
- A Service Set Identifier (SSID) is a name assigned to a wireless network. Wired Equivalent Privacy (WEP), Wi-Fi Protected Access (WPA), WPA2, and 802.1X - RADIUS are types of security used on a network.

Preparing to set up the printer on an Ethernet network

To configure your printer to connect to an Ethernet network, organize the following information before you begin:

Note: If your network automatically assigns IP addresses to computers and printers, continue on to installing the printer.

- A valid, unique IP address for the printer to use on the network
- The network gateway
- The network mask
- A nickname for the printer (optional)

Note: A printer nickname can make it easier for you to identify your printer on the network. You can choose to use the default printer nickname, or assign a name that is easier for you to remember.

You will need an Ethernet cable to connect the printer to the network and an available port where the printer can physically connect to the network. Use a new network cable when possible to avoid potential problems caused by a damaged cable.

Preparing to set up the printer on a wireless network

Notes:

- Make sure your wireless network adapter is installed in your printer and working properly. For more information, see the instruction sheet that came with the wireless network adapter.
- Make sure your access point (wireless router) is turned on and is working properly.

Make sure you have the following information before setting up the printer on a wireless network:

- **SSID**—The SSID is also referred to as the network name.
- **Wireless Mode (or Network Mode)**—The mode is either infrastructure or ad hoc.
- **Channel (for ad hoc networks)**—The channel defaults to automatic for infrastructure networks.

Some ad hoc networks will also require the automatic setting. Check with your system support person if you are not sure which channel to select.

- **Security Method**—There are four basic options for Security Method:

- WEP key

If your network uses more than one WEP key, then enter up to four in the provided spaces. Select the key currently in use on the network by selecting the default WEP transmit key.

- WPA or WPA2 preshared key or passphrase

WPA includes encryption as an additional layer of security. The choices are AES or TKIP. Encryption must be set for the same type on the router and on the printer, or the printer will not be able to communicate on the network.

- 802.1X–RADIUS

If you are installing the printer on an 802.1X network, then you may need the following:

- Authentication type
- Inner authentication type
- 802.1X user name and password
- Certificates

- No security

If your wireless network does not use any type of security, then you will not have any security information.

Note: We do not recommend using an unsecured wireless network.

Notes:

- If you do not know the SSID of the network that your computer is connected to, then launch the wireless utility of the computer network adapter, and then look for the network name. If you cannot find the SSID or the security information for your network, then see the documentation that came with the access point, or contact your system support person.
- To find the WPA/WPA2 preshared key or passphrase for the wireless network, see the documentation that came with the access point, see the Embedded Web Server associated with the access point, or consult your system support person.

Connecting the printer using the Wireless Setup Wizard

Before you begin, make sure that:

- A wireless network adapter is installed in the printer and is working properly. For more information, see the instruction sheet that came with the wireless network adapter.
- An Ethernet cable is disconnected from the printer.
- Active NIC is set to Auto. To set this to Auto, navigate to:

 > **Settings** >  > **Network/Ports** >  > **Active NIC** >  > **Auto** > 

Note: Make sure to turn off the printer, then wait for at least five seconds, and then turn the printer back on.

1 From the printer control panel, navigate to:

 > **Settings** >  > **Network/Ports** >  > **Network [x]** >  > **Network [x] Setup** >  > **Wireless** >  > **Wireless Connection Setup** > 

2 Select a wireless connection setup.

Use	To
Search for networks	Show available wireless connections. Note: This menu item shows all broadcast secured or unsecured SSIDs.
Enter a network name	Manually type the SSID. Note: Make sure to type the correct SSID.
Wi-Fi Protected Setup	Connect the printer to a wireless network using Wi-Fi Protected Setup.

3 Press , and then follow the instructions on the printer display.









Connecting the printer to a wireless network using Wi-Fi Protected Setup

Before you begin, make sure that:

- The access point (wireless router) is Wi-Fi Protected Setup (WPS) certified or WPS-compatible. For more information, see the documentation that came with your access point.
- A wireless network adapter is installed in the printer and is working properly. For more information, see the instruction sheet that came with the wireless network adapter.

Using the Push Button Configuration (PBC) method

1 From the printer control panel, navigate to:

 > **Settings** >  > **Network/Ports** >  > **Network [x]** >  > **Network [x] Setup** >  > **Wireless** >  > **Wireless Connection Setup** >  > **Wi-Fi Protected Setup** >  > **Start Push Button Method** > 

2 Follow the instructions on the printer display.

Using the Personal Identification Number (PIN) method

1 From the printer control panel, navigate to:

 > **Settings** >  > **Network/Ports** >  > **Network [x]** >  > **Network [x] Setup** >  > **Wireless** >  > **Wireless Connection Setup** >  > **Wi-Fi Protected Setup** >  > **Start PIN Method** > 

2 Copy the eight-digit WPS PIN.

3 Open a Web browser, and then type the IP address of your access point in the address bar.

Notes:

- The IP address appears as four sets of numbers separated by periods, such as 123.123.123.123.
- If you are using a proxy server, then temporarily disable it to load the Web page correctly.

4 Access the WPS settings. For more information, see the documentation that came with your access point.

5 Enter the eight-digit PIN, and then save the setting.

Connecting the printer to a wireless network using the Embedded Web Server

Before you begin, make sure that:

- Your printer is connected temporarily to an Ethernet network.
- A wireless network adapter is installed in your printer and working properly. For more information, see the instruction sheet that came with the wireless network adapter.

1 Open a Web browser, and then type the printer IP address in the address field.

Notes:

- View the printer IP address on the printer control panel. The IP address appears as four sets of numbers separated by periods, such as 123.123.123.123.
- If you are using a proxy server, then temporarily disable it to load the Web page correctly.

2 Click **Settings** > **Network/Ports** > **Wireless**.

3 Modify the settings to match the settings of your access point (wireless router).

Note: Make sure to enter the correct SSID, security method, preshared key or passphrase, network mode, and channel.

4 Click **Submit**.

5 Turn off the printer, and then disconnect the Ethernet cable. Then wait for at least five seconds, and then turn the printer back on.

6 To verify if your printer is connected to the network, print a network setup page. Then in the Network Card [x] section, see if the status is Connected.

Verifying printer setup

When all hardware and software options are installed and the printer is turned on, verify that the printer is set up correctly by printing the following:

- **Menu settings page**—Use this page to verify that all printer options are installed correctly. If an option you installed is not listed, then it is not installed correctly. Remove the option, and then install it again.
- **Network setup page**—If your printer has networking support, then use this page to verify that the network connection is working. This page also provides important information that aids network printing configuration.

Printing a menu settings page

Print a menu settings page to view the current menu settings and to verify if the printer options are installed correctly.

From the printer control panel, navigate to:

 > **Settings** > **Reports** >  > **Menu Settings Page** > 

Note: If you have not changed any menu settings, then the menu settings page lists all the factory default settings. Settings saved from the menus replace the factory default settings as *user default settings*. A user default setting remains in effect until you access the menu again, select another value, and save it.

Printing a network setup page

If the printer is attached to a network, then print a network setup page to verify the network connection. This page also provides important information that aids network printing configuration.

- 1 From the printer control panel, navigate to:

 > **Settings** > **Reports** >  > **Network Setup Page** > 

Note: If an optional internal print server is installed, then **Print Network [x] Setup Page** appears.

- 2 Check the first section of the network setup page, and confirm that the status is **Connected**.

If the status is **Not Connected**, then the LAN drop may not be active, or the network cable may be malfunctioning. Consult your system support person for a solution, and then print another network setup page.

Loading paper and specialty media

Proper selection and loading of media can improve how reliably documents print. For more information, see [“Avoiding jams” on page 158](#) and [“Storing paper” on page 45](#).

Setting the paper size and type

- 1 From the printer control panel, navigate to:

 > **Settings** >  > **Paper Menu** >  > **Paper Size/Type** > 

- 2 Press the up or down arrow button to select the tray or feeder, and then press .

- 3 Press the up or down arrow button to select the paper size, and then press .

- 4 Press the up or down arrow button to select the paper type, and then press  to change the settings.

Configuring Universal paper settings

The Universal paper size is a user-defined setting that lets you print on paper sizes that are not preset in the printer menus.

Notes:

- The smallest supported Universal size is 76 x 127 mm (3 x 5 inches) and is loaded only in the multipurpose feeder and manual feeder.
- The largest supported Universal size is 215.9 x 359.9 mm (8.5 x 14.17 inches) and is loaded only in the multipurpose feeder and manual feeder.

- 1 From the printer control panel, navigate to:

 > **Settings** >  > **Paper Menu** >  > **Universal Setup** > 

- 2 Press the up or down arrow buttons to scroll to **Units of Measure**, **Portrait Height**, or **Portrait width**, and then press .

- 3 Enter the preferred settings using the keypad, and then press .

- 4 Press .

Loading the 250-sheet tray

The printer has a 250-sheet tray (Tray 1) with an integrated manual feeder. The 250-sheet tray and the 650-sheet duo tray support the same paper sizes and types and are loaded in the same way.

 **CAUTION—POTENTIAL INJURY:** To reduce the risk of equipment instability, load each tray separately. Keep all other trays closed until needed.

- 1 Pull out the tray completely.

Note: Do not remove trays while a job is printing or while **Busy** appears on the display. Doing so may cause a jam.

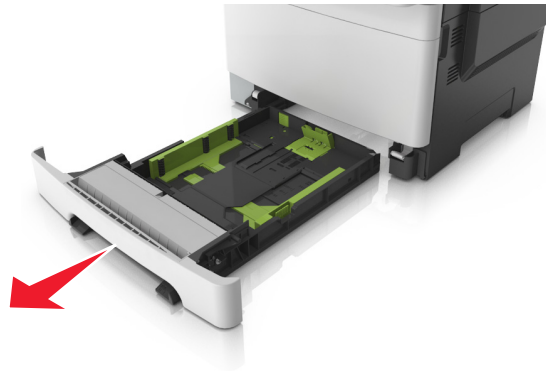

2 If the paper is longer than letter-size paper, then squeeze and then slide the length guide at the back of the tray to extend it.

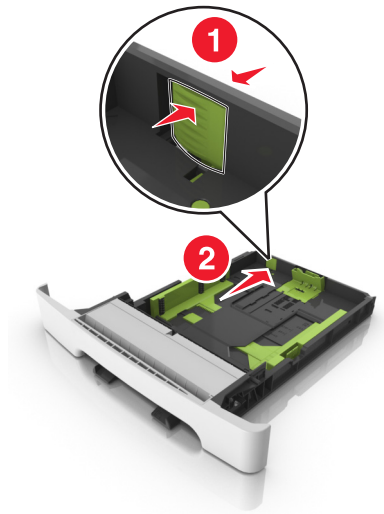

3 Squeeze, and then slide the length guide tab to the correct position for the size of the paper being loaded.

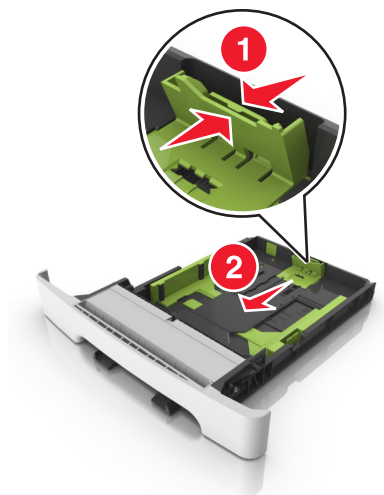

Note: Use the paper size indicators on the bottom of the tray to help position the guide.

- 4 Squeeze, and then slide the width guide tab to the correct position for the size of the paper being loaded.

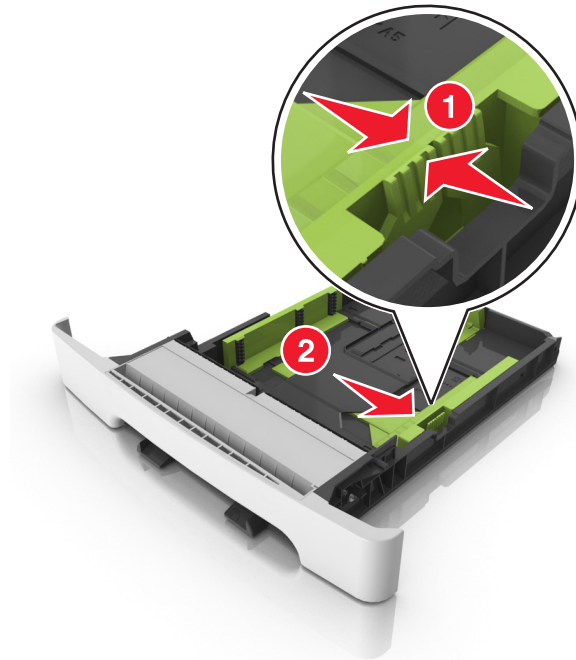

Note: Use the paper size indicators on the bottom of the tray to help position the guides.

- 5 Flex the sheets back and forth to loosen them, and then fan them. Do not fold or crease the paper. Straighten the edges on a level surface.

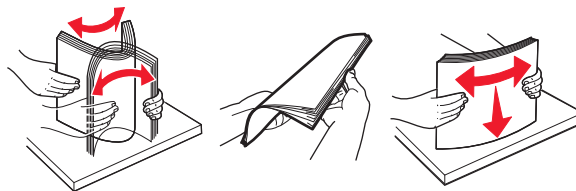

- 6 Load the paper stack with the recommended printable side faceup.

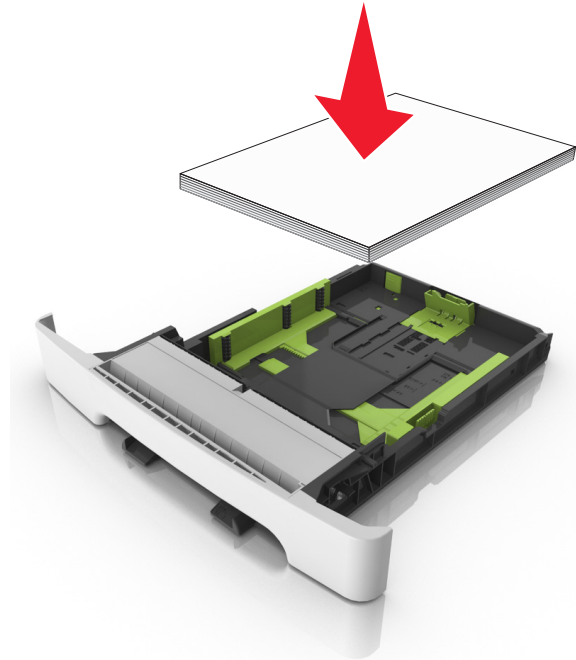

- 7 Place the paper guides securely against the edges of the paper.

- 8 Insert the tray.



- 9 From the printer control panel, set the paper size and paper type in the Paper menu to match the paper loaded in the tray.

Note: Mixing paper sizes or paper types in a tray may cause jams.

Loading the manual feeder

The standard 250-sheet tray has an integrated manual feeder that can be used to print on different types of paper one sheet at a time.

- 1 Load a sheet of paper into the manual feeder:
 - Printable side facedown for one-sided printing
 - Printable side faceup for two-sided (duplex) printing

Note: There are different ways for loading letterhead depending on the mode of printing.

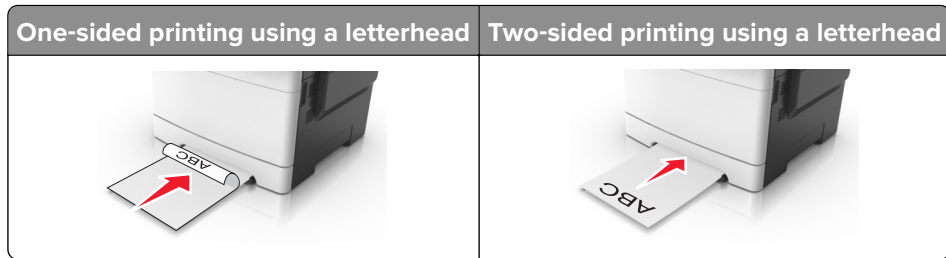

- Load envelope with the flap side up and against the right side of the paper guide.



- 2 Feed paper into the manual feeder only to the point where its leading edge can contact the paper guides.

Note: To achieve the best possible print quality, use only high-quality media designed for laser printers.

- 3 Adjust the paper guides to the width of the paper loaded.

Warning—Potential Damage: Do not force the paper into the feeder. Forcing the paper may cause jams.



Loading the 650-sheet duo tray

The 650-sheet duo tray (Tray 2) consists of a 550-sheet tray and an integrated 100-sheet multipurpose feeder. The tray is loaded in the same way as the 250-sheet tray and supports the same paper types and sizes. The only differences are the look of the guide tabs and the location of the paper size indicators.

⚠ CAUTION—POTENTIAL INJURY: To reduce the risk of equipment instability, load each tray separately. Keep all other trays closed until needed.

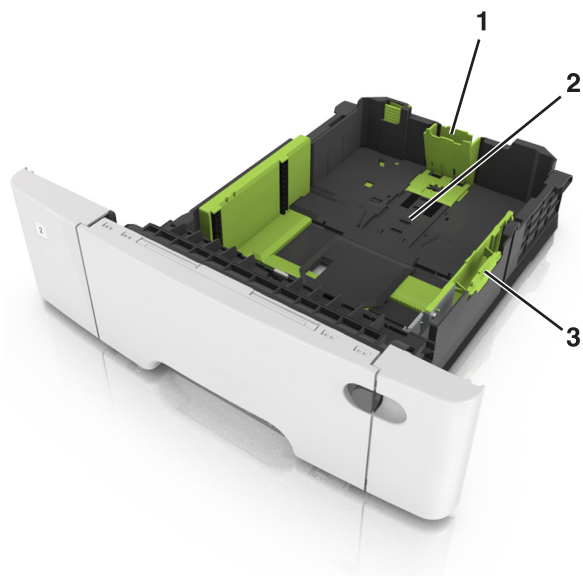

1	Length guide tab
2	Paper size indicator
3	Width guide tab

Loading the multipurpose feeder

- 1 Push the multipurpose feeder latch to the left.



2 Open the multipurpose feeder.



3 Pull the multipurpose feeder extender.

Note: Guide the extender gently so that the multipurpose feeder is fully extended and open.



4 Prepare the paper for loading.

- Flex the sheets of paper back and forth to loosen them, and then fan them. Do not fold or crease the paper. Straighten the edges on a level surface.

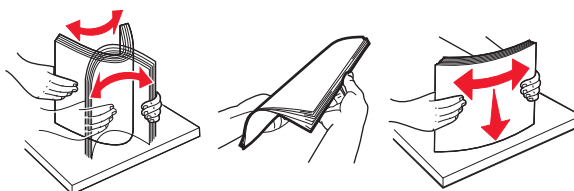

- Hold transparencies by the edges, and then fan them. Straighten the edges on a level surface.

Note: Avoid touching the printable side of transparencies. Be careful not to scratch them.

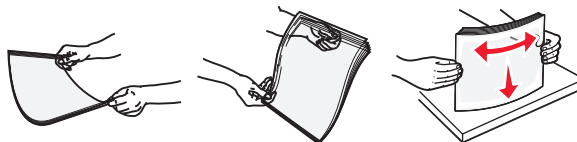

- Flex a stack of envelopes back and forth to loosen them, and then fan them. Straighten the edges on a level surface.

Warning—Potential Damage: Never use envelopes with stamps, clasps, snaps, windows, coated linings, or self-stick adhesives. These envelopes may severely damage the printer.



5 Locate the maximum paper fill indicator and tab.

Note: Make sure the paper or specialty media is below the maximum paper fill indicator located on the paper guides.

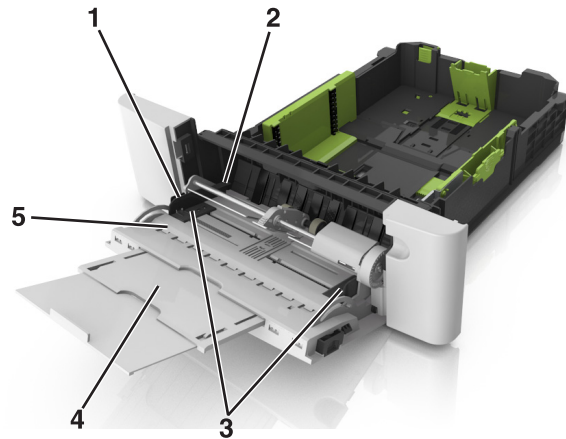

1	Width guide tab
2	Maximum paper fill indicator
3	Width guide
4	Feeder extender
5	Paper size indicator

6 Load the paper, and then adjust the width guide to lightly touch the edge of the paper stack.

- Load paper, card stock, and transparencies with the recommended printable side facedown and the top edge entering the printer first.

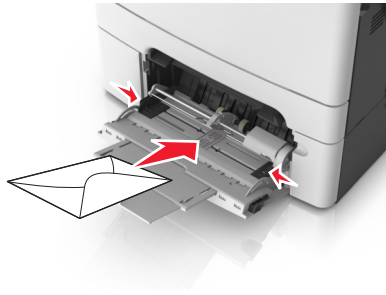

- Load envelopes with the flap side up and against the right side of the paper guide.

**Notes:**

- Do not load or close the multipurpose feeder while a job is printing.
- Load only one size and type of paper at a time.
- Paper should lie flat in the multipurpose feeder. Make sure the paper fits loosely in the multipurpose feeder and is not bent or wrinkled.

- 7 From the printer control panel, set the paper size and type in the Paper menu to match the paper loaded in the tray.

Linking and unlinking trays

The printer links trays when the specified paper size and type are the same. When a linked tray becomes empty, paper feeds from the next linked tray. To prevent trays from linking, assign a unique custom paper type name.

Linking and unlinking trays

Note: This feature applies only in network printers.

- 1 Open a Web browser, and then type the printer IP address in the address field.

Notes:

- View the printer IP address in the TCP/IP section in the Network/Ports menu. The IP address appears as four sets of numbers separated by periods, such as 123.123.123.123.
- If you are using a proxy server, then temporarily disable it to load the Web page correctly.

- 2 Click **Settings > Paper Menu**.

- 3 Change the tray settings to specify the paper size and type for the tray.

- To link trays, make sure the paper size and type for the tray match with that of the other tray.
- To unlink trays, make sure the paper size or type for the tray *does not* match with that of the other tray.

- 4 Click **Submit**.

Warning—Potential Damage: Paper loaded in the tray should match the paper type name assigned in the printer. The temperature of the fuser varies according to the specified paper type. Printing issues may occur if settings are not properly configured.

Creating a custom name for a paper type

Using the Embedded Web Server

- 1 Open a Web browser, and then type the printer IP address in the address field.

Notes:

- View the printer IP address in the TCP/IP section in the Network/Ports menu. The IP address appears as four sets of numbers separated by periods, such as 123.123.123.123.
- If you are using a proxy server, then temporarily disable it to load the Web page correctly.

- 2 Click **Settings > Paper Menu > Custom Names**.

- 3 Select a custom name, and then type a new custom paper type name.

- 4 Click **Submit**.

- 5 Click **Custom Types**, and then verify if the new custom paper type name has replaced the custom name.

Using the printer control panel

- 1 From the printer control panel, navigate to:

 > **Settings** >  > **Paper Menu** >  > **Custom Names**

- 2 Select a custom name, and then type a new custom paper type name.

- 3 Press .

- 4 Press **Custom Types**, and then verify if the new custom paper type name has replaced the custom name.

Assigning a custom paper type name

Using the Embedded Web Server

- 1 Open a Web browser, and then type the printer IP address in the address field.

Notes:

- View the printer IP address in the TCP/IP section in the Network/Ports menu. The IP address appears as four sets of numbers separated by periods, such as 123.123.123.123.
- If you are using a proxy server, then temporarily disable it to load the Web page correctly.

- 2 Click **Settings > Paper Menu > Custom Names**.

- 3 Type a name for the paper type, and then click **Submit**.

- 4 Select a custom type, and then verify that the correct paper type is associated with the custom name.

Note: Plain Paper is the factory default paper type for all user-defined custom names.

Using the printer control panel

1 From the printer control panel, navigate to:

 > **Settings** >  > **Paper Menu** >  > **Custom Names**

2 Type a name for the paper type, and then press .

Assigning a custom paper type

Using the Embedded Web Server

1 Open a Web browser, and then type the printer IP address in the address field.

Notes:

- View the printer IP address in the TCP/IP section in the Network/Ports menu. The IP address appears as four sets of numbers separated by periods, such as 123.123.123.123.
- If you are using a proxy server, then temporarily disable it to load the Web page correctly.

2 Click **Settings** > **Paper Menu** > **Custom Types**.

3 Select a custom paper type name, and then select a paper type.

Note: Paper is the factory default paper type for all user-defined custom names.

4 Click **Submit**.

Using the printer control panel

1 From the printer control panel, navigate to:

 > **Settings** >  > **Paper Menu** >  > **Custom Types**

2 Select a custom paper type name, and then select a paper type.

Note: Paper is the factory default paper type for all user-defined custom names.



3 Press .

Paper and specialty media guide



Using specialty media

Tips on using letterhead

- Use letterhead designed specifically for laser printers.
- Print a test page on the letterhead being considered for use before buying large quantities.
- Before loading letterhead, flex, fan, and straighten the stacks to prevent sheets from sticking together.
- Page orientation is important when printing on letterhead.

Source	Printing	Printable side	Paper orientation
Trays 	One-sided	Faceup	Load the sheet with the top edge entering the printer first.
Trays 	Two-sided	Facedown	Load the sheet with the bottom edge entering the printer first.
Manual feeder 	One-sided	Facedown	Load the sheet with the top edge entering the printer first.

Note: Check with the manufacturer or vendor to determine whether or not the preprinted letterhead is acceptable for laser printers.

Source	Printing	Printable side	Paper orientation
Manual feeder 	Two-sided	Faceup	Load the sheet with the bottom edge entering the printer first.
Multipurpose feeder 	One-sided	Facedown	Load the sheet with the top edge entering the printer first.
Multipurpose feeder 	Two-sided	Faceup	Load the sheet with the bottom edge entering the printer first.
Note: Check with the manufacturer or vendor to determine whether or not the preprinted letterhead is acceptable for laser printers.			

Tips on using transparencies

Print a test page on the transparencies being considered for use before buying large quantities.

- From the printer control panel, set the paper size, type, texture, and weight in the Paper menu to match the transparencies loaded in the tray.
- Print a test page on the transparencies being considered for use before buying large quantities.
- Feed transparencies from the 250-sheet tray, manual feeder, or multipurpose feeder.
- Use transparencies designed specifically for laser printers.
- Avoid getting fingerprints on the transparencies to prevent print quality problems.
- Before loading transparencies, flex, fan, and straighten the stacks to prevent sheets from sticking together.

Tips on using envelopes

- From the printer control panel, set the paper size, type, texture, and weight in the Paper menu to match the envelopes loaded in the tray.
- Print samples on the envelopes being considered for use before buying large quantities.
- Use envelopes designed specifically for laser printers.
- For best performance, use envelopes made from 90-g/m² (24-lb) paper or 25% cotton.
- Use only new envelopes from undamaged packages.
- To optimize performance and minimize jams, do not use envelopes that:
 - Have excessive curl or twist.
 - Are stuck together or damaged in any way.
 - Have windows, holes, perforations, cutouts, or embossing.
 - Have metal clasps, string ties, or folding bars.
 - Have an interlocking design.
 - Have postage stamps attached.
 - Have any exposed adhesive when the flap is in the sealed or closed position.
 - Have bent corners.
 - Have rough, cockle, or laid finishes.
- Adjust the width guides to fit the width of the envelopes.
- Before loading the envelopes on the tray, flex and fan the envelopes to loosen them. Straighten the edges on a level surface.

Note: A combination of high humidity (over 60%) and high printing temperature may wrinkle or seal envelopes.

Tips on using labels

- From the printer control panel, set the paper size, type, texture, and weight in the Paper menu to match the labels loaded in the tray.
- Print samples on labels being considered for use before buying large quantities.
- For more information on label printing, characteristics, and design, see the *Card Stock & Label Guide* at <http://support.lexmark.com>.
- Use labels designed specifically for laser printers.
- Do not use labels with slick backing material.
- Use full label sheets. Partial sheets may cause labels to peel off during printing, resulting in a jam. Partial sheets also contaminate the printer and the cartridge with adhesive, and could void the printer and toner cartridge warranties.
- Do not use labels with exposed adhesive.
- Before loading labels on the tray, flex and fan labels to loosen them. Straighten the edges on a level surface.

Tips on using card stock

Card stock is heavy, single-ply specialty media. Many of its variable characteristics, such as moisture content, thickness, and texture, can significantly affect print quality.

- From the printer control panel, set the paper size, type, texture, and weight in the Paper menu to match the card stock loaded in the tray.
- Print samples on the card stock being considered for use before buying large quantities.
- Specify the paper texture and weight from the tray settings to match the paper loaded in the tray.
- Preprinting, perforation, and creasing may significantly affect the print quality and cause jams or other paper feed problems.
- Before loading the card stock on the tray, flex and fan the card stock to loosen them. Straighten the edges on a level surface.

Paper guidelines

Select the correct paper or specialty media to reduce printing problems. For the best print quality, try a sample of the paper or specialty media before buying large quantities.

Paper characteristics

The following paper characteristics affect print quality and reliability. Consider these characteristics when evaluating new paper stock.

Weight

The printer trays can automatically feed paper weights up to 176-g/m² (47-lb) bond grain long paper. The multipurpose feeder can automatically feed paper weights up to 176-g/m² (47-lb) bond grain long paper. Paper lighter than 60 g/m² (16 lb) might not be stiff enough to feed properly, causing jams. For best performance, use 75-g/m² (20-lb) bond grain long paper. For paper smaller than 182 x 257 mm (7.2 x 10.1 inches), we recommend 90 g/m² (24 lb) or heavier paper.

Note: Duplex printing is supported from 60–105-g/m² (16–28-lb) bond grain long paper.

Curl

Curl is the tendency for paper to curl at its edges. Excessive curl can cause paper feeding problems. Curl can occur after the paper passes through the printer, where it is exposed to high temperatures. Storing paper unwrapped in hot, humid, cold, or dry conditions, even in the trays, can contribute to paper curling prior to printing and can cause feeding problems.

Smoothness

Paper smoothness directly affects print quality. If paper is too rough, then toner cannot fuse to it properly. If paper is too smooth, then it can cause paper feeding or print quality issues. Always use paper between 100 and 300 Sheffield points; smoothness between 150 and 250 Sheffield points produces the best print quality.

Moisture content

The amount of moisture in paper affects both print quality and the ability of the printer to feed the paper correctly. Leave paper in its original wrapper until it is time to use it. This limits the exposure of paper to moisture changes that can degrade its performance.

Store paper in its original wrapper in the same environment as the printer for 24 to 48 hours before printing. Extend the time to several days if the storage or transportation environment is very different from the printer environment. Thick paper may also require a longer conditioning period.

Grain direction

Grain refers to the alignment of the paper fibers in a sheet of paper. Grain is either *grain long*, running the length of the paper, or *grain short*, running the width of the paper.

For 60–90-g/m² (16–24-lb) bond paper, grain long paper is recommended.

Fiber content

Most high-quality xerographic paper is made from 100% chemically treated pulped wood. This content provides the paper with a high degree of stability resulting in fewer paper feeding problems and better print quality. Paper containing fibers such as cotton can negatively affect paper handling.

Unacceptable paper

The following paper types are not recommended for use with the printer:

- Chemically-treated papers used to make copies without carbon paper, also known as carbonless papers, carbonless copy paper (CCP), or no carbon required (NCR) paper
- Preprinted papers with chemicals that may contaminate the printer
- Preprinted papers that can be affected by the temperature in the printer fuser
- Preprinted papers that require a registration (the precise print location on the page) greater than ± 2.4 mm (± 0.9 inch), such as optical character recognition (OCR) forms

In some cases, registration can be adjusted with a software application to successfully print on these forms:

- Coated papers (erasable bond), synthetic papers, thermal papers
- Rough-edged, rough or heavily textured surface papers, or curled papers
- Recycled papers that fail EN12281:2002 (European)
- Paper weighing less than 60 g/m² (16 lb)
- Multiple-part forms or documents

Selecting paper

Using the appropriate paper prevents jams and helps ensure trouble-free printing.

To help avoid paper jams and poor print quality:

- *Always* use new, undamaged paper.
- Before loading paper, know the recommended printable side of the paper. This information is usually indicated on the paper package.
- *Do not* use paper that has been cut or trimmed by hand.

- *Do not* mix paper sizes, types, or weights in the same tray; mixing results in jams.
- *Do not* use coated papers unless they are specifically designed for electrophotographic printing.

Selecting preprinted forms and letterhead

Use these guidelines when selecting preprinted forms and letterhead:

- Use grain long for 60–90-g/m² (16–24-lb) paper.
- Use only forms and letterhead printed using an offset lithographic or engraved printing process.
- Avoid paper with rough or heavily textured surfaces.

Use inks that are not affected by the resin in toner. Inks that are oxidation-set or oil-based generally meet these requirements; latex inks might not.

When in doubt, contact your paper supplier.

Using recycled paper and other office papers

As an environmentally conscious company, Lexmark supports the use of recycled office paper produced specifically for use in laser (electrophotographic) printers. In 1998, Lexmark presented to the US government a study demonstrating that recycled paper produced by major mills in the US fed as well as non-recycled paper. However, no blanket statement can be made that *all* recycled paper will feed well.

Lexmark consistently tests its printers with recycled paper (20–100% post-consumer waste) and a variety of test paper from around the world, using chamber tests for different temperature and humidity conditions. Lexmark has found no reason to discourage the use of today's recycled office papers, but generally the following property guidelines apply to recycled paper.

- Low moisture content (4–5%)
- Suitable smoothness (100–200 Sheffield units, or 140–350 Bendtsen units, European)

Note: Some much smoother papers (such as premium 24 lb laser papers, 50–90 Sheffield units) and much rougher papers (such as premium cotton papers, 200–300 Sheffield units) have been engineered to work very well in laser printers, despite surface texture. Before using these types of paper, consult your paper supplier.

- Suitable sheet-to-sheet coefficient of friction (0.4–0.6)
- Sufficient bending resistance in the direction of feed

Recycled paper, paper of lower weight (<60 g/m² [16 lb bond]) and/or lower caliper (<3.8 mils [0.1 mm]), and paper that is cut grain-short for portrait (or short-edge) fed printers may have lower bending resistance than is required for reliable paper feeding. Before using these types of paper for laser (electrophotographic) printing, consult your paper supplier. Remember that these are general guidelines only and that paper meeting these guidelines may still cause paper feeding problems in any laser printer (for example, if the paper curls excessively under normal printing conditions).

Storing paper

Use these paper storage guidelines to help avoid jams and uneven print quality:

- For best results, store paper where the temperature is 21°C (70°F) and the relative humidity is 40 percent. Most label manufacturers recommend printing in a temperature range of 18–24°C (65–75°F) with relative humidity between 40 and 60 percent.
- Store paper in cartons, on a pallet or shelf, rather than on the floor.
- Store individual packages on a flat surface.

- Do not store anything on top of individual paper packages.
- Take paper out of the carton or wrapper only when you are ready to load it in the printer. The carton and wrapper help keep the paper clean, dry, and flat.

Supported paper sizes, types, and weights

The following tables provide information on standard and optional paper sources and the sizes, types, and weights of paper they support.

Note: For an unlisted paper size, select the closest *larger* listed size.

Supported paper sizes

Note: Your printer model may have a 650-sheet duo tray, which consists of a 550-sheet tray and an integrated 100-sheet multipurpose feeder. The integrated multipurpose feeder supports different paper sizes, types, and weights.

Paper size and dimension	Standard 250-sheet tray	Manual feeder	650-sheet duo tray		ADF	Scanner glass	Duplex mode
			550-sheet tray	Multipurpose feeder			
A4 210 x 297 mm (8.3 x 11.7 in.)	√ ¹	√	√ ¹	√ ¹	√	√	√
A5 148 x 210 mm (5.83 x 8.3 in.)	√ ¹	√	√ ²	√ ¹	√	√	X
A6 105 x 148 mm (4.1 x 5.8 in.)	X	√	X	√ ¹	X	√	X
JIS B5 182 x 257 mm (7.2 x 10.1 in.)	√ ¹	√	√ ¹	√ ¹	√	√	X
Letter 216 x 279 mm (8.5 x 11 in.)	√ ¹	√	√ ¹	√ ¹	√	√	√
Legal 216 x 356 mm (8.5 x 14 in.)	√ ¹	√	√ ¹	√ ¹	√	X	√

¹ The paper source supports paper size without *size sensing*.

² Universal is supported in the standard 250-sheet tray only if the paper size is from 148 x 215.9 mm (5.83 x 8.5 in.) to 215.9 x 355.6 mm (8.5 x 14 in.).

³ Universal is supported in the multipurpose feeder and manual feeder only if the paper size is from 76.2 x 127 mm (3 x 5 in.) to 215.9 x 359.9 mm (8.5 x 14.17 in.).

⁴ Universal is supported in duplex mode only if the width is from 210 mm (8.27 in.) to 215.9 mm (8.5 in.), and the length is from 279.4 mm (11 in.) to 355.6 mm (14 in.).

Paper size and dimension	Standard 250-sheet tray	Manual feeder	650-sheet duo tray		ADF	Scanner glass	Duplex mode
			550-sheet tray	Multipurpose feeder			
Executive 184 x 267 mm (7.3 x 10.5 in.)	√ ¹	√	√ ¹	√ ¹	√	√	X
Oficio (Mexico) 216 x 340 mm (8.5 x 13.4 in.)	√ ¹	√	√ ¹	√ ¹	√	X	√
Folio 216 x 330 mm (8.5 x 13 in.)	√ ¹	√	√ ¹	√ ¹	√	X	√
Statement 140 x 216 mm (5.5 x 8.5 in.)	X	√	X	√ ¹	√	√	X
Universal 76 x 127 mm (3 x 5 in.) to 216 x 356 mm (8.5 x 14 in.)	X	√ ^{1,3}	X	√ ^{1,3}	√	√	X
Universal 148 x 210 mm (5.8 x 8.3 in.) to 216 x 356 mm (8.5 x 14 in.)	√ ^{1,2}	√	√ ^{1,2}	√	X	X	√ ⁴
7 3/4 Envelope (Monarch) 98 x 191 mm (3.9 x 7.5 in.)	X	√	X	√ ¹	X	X	X
9 Envelope 98 x 225 mm (3.9 x 8.9 in.)	X	√	X	√ ¹	X	X	X
10 Envelope 105 x 241 mm (4.1 x 9.5 in.)	X	√	X	√ ¹	X	X	X
DL Envelope 110 x 220 mm (4.3 x 8.7 in.)	X	√	X	√ ¹	X	X	X

¹ The paper source supports paper size without *size sensing*.

² Universal is supported in the standard 250-sheet tray only if the paper size is from 148 x 215.9 mm (5.83 x 8.5 in.) to 215.9 x 355.6 mm (8.5 x 14 in.).

³ Universal is supported in the multipurpose feeder and manual feeder only if the paper size is from 76.2 x 127 mm (3 x 5 in.) to 215.9 x 359.9 mm (8.5 x 14.17 in.).

⁴ Universal is supported in duplex mode only if the width is from 210 mm (8.27 in.) to 215.9 mm (8.5 in.), and the length is from 279.4 mm (11 in.) to 355.6 mm (14 in.).

Paper size and dimension	Standard 250-sheet tray	Manual feeder	650-sheet duo tray		ADF	Scanner glass	Duplex mode
			550-sheet tray	Multipurpose feeder			
C5 Envelope 162 x 229 mm (6.4 x 9 in.)	X	✓	X	✓ ¹	X	X	X
B5 Envelope 176 x 250 mm (6.9 x 9.8 in.)	X	✓	X	✓ ¹	X	X	X
Other Envelope 98 x 162 mm (3.9 x 6.3 in.) up to 176 x 250 mm (6.9 x 9.8 in.)	X	✓	X	✓ ¹	X	X	X

¹ The paper source supports paper size without *size sensing*.

² Universal is supported in the standard 250-sheet tray only if the paper size is from 148 x 215.9 mm (5.83 x 8.5 in.) to 215.9 x 355.6 mm (8.5 x 14 in.).

³ Universal is supported in the multipurpose feeder and manual feeder only if the paper size is from 76.2 x 127 mm (3 x 5 in.) to 215.9 x 359.9 mm (8.5 x 14.17 in.).

⁴ Universal is supported in duplex mode only if the width is from 210 mm (8.27 in.) to 215.9 mm (8.5 in.), and the length is from 279.4 mm (11 in.) to 355.6 mm (14 in.).

Supported paper types and weights

Notes:

- Your printer model may have a 650-sheet duo tray, which consists of a 550-sheet tray and an integrated 100-sheet multipurpose feeder. The integrated multipurpose feeder supports different paper sizes, types, and weights.
- Labels, transparencies, envelopes, and card stock always print at reduced speed.

Paper type	250-sheet tray	Manual feeder	650-sheet duo tray		ADF	Scanner glass	Duplex mode
			550-sheet tray	Multipurpose feeder			
Paper <ul style="list-style-type: none"> • Plain • Recycled • Glossy • Bond • Letterhead • Preprinted • Colored • Light • Heavy • Rough/Cotton • Custom Type [x] 	✓	✓	✓	✓	✓	✓	✓
Card stock	✓	✓	✓	✓	✓	✓	X
Transparencies	✓	✓	X	✓	✓	✓	X
Labels <ul style="list-style-type: none"> • Paper 	✓	✓	✓	✓	✓	✓	X
Envelope	X	✓	X	✓	✓	✓	X

Printing

Printing a document

Printing from a computer

Note: For labels, card stock, and envelopes, set the paper size and type in the printer before sending the print job.

- 1 From the document that you are trying to print, open the Print dialog.
- 2 If necessary, adjust the settings.
- 3 Send the print job.

Printing in black and white

From the printer control panel, navigate to:

 > **Settings** >  > **Print Settings** >  > **Quality Menu** >  > **Print Mode** >  > **Black Only** > 

Adjusting toner darkness

Using the Embedded Web Server

- 1 Open a Web browser, and then type the IP address of the printer in the address field.

Notes:

- View the printer IP address in the TCP/IP section in the Network/Ports menu. The IP address appears as four sets of numbers separated by periods, such as 123.123.123.123.
- If you are using a proxy server, then temporarily disable it to load the Web page correctly.

- 2 Click **Settings** > **Print Settings** > **Quality Menu** > **Toner Darkness**.

- 3 Adjust the toner darkness, and then click **Submit**.

Using the printer control panel

- 1 From the printer control panel, navigate to:

 > **Settings** >  > **Print Settings** >  > **Quality Menu** >  > **Toner Darkness**

- 2 Adjust the toner darkness, and then press .

Using Max Speed and Max Yield

Max Speed and Max Yield let you choose between a faster print speed and a higher toner yield. Max Yield is the factory default setting.

- **Max Speed**—This lets you print in either black or color depending on the setting in the printer driver. The printer prints in color unless **Black Only** is selected in the printer driver.
- **Max Yield**—This lets you switch from black to color based on the color content found on each page.

Note: Frequent color mode switching can result to slower printing if the content of the pages is mixed.

Using the Embedded Web Server

- 1 Open a Web browser, and then type the printer IP address in the address field.

Notes:

- View the printer IP address in the TCP/IP section in the Network/Ports menu. The IP address appears as four sets of numbers separated by periods, such as 123.123.123.123.
- If you are using a proxy server, then temporarily disable it to load the Web page correctly.

- 2 Click **Settings > Print Settings > Setup Menu**.
- 3 From the Printer Usage list, select **Max Speed** or **Max Yield**.
- 4 Click **Submit**.

Using the printer control panel

- 1 From the printer control panel, navigate to:

 > **Settings** >  > **Settings** >  > **Print Settings** >  > **Setup Menu** >  > **Printer Usage** > 

- 2 Select **Max Speed** or **Max Yield**, and then press .

Printing from a mobile device

Note: Make sure that the printer and mobile device share the same wireless network. For information on configuring the wireless settings of your mobile device, see the documentation that came with the device.

Printing from a mobile device using Mopria Print Service

Mopria® Print Service is a mobile printing solution for mobile devices running on Android version 4.4 or later. It allows you to print directly to any Mopria-certified printer.

Note: Before printing, make sure that the Mopria Print Service is enabled.

- 1 From the home screen of your mobile device, launch a compatible application.
- 2 Tap **Print**, and then select the printer.
- 3 Send the print job.

Printing from a mobile device using Google Cloud Print

Google Cloud Print™ is a mobile printing service that allows enabled applications on mobile devices to print to any Google Cloud Print-ready printer.

- 1 From the home screen of your mobile device, launch an enabled application.
- 2 Tap **Print**, and then select the printer.
- 3 Send the print job.

Printing from a mobile device using AirPrint

AirPrint is a mobile printing solution that allows you to print directly from Apple devices to an AirPrint-certified printer.

Notes:

- This application is supported only in some Apple devices.
 - This application is supported only in some printer models.
- 1 From the home screen of your mobile device, launch a compatible application.
 - 2 Select an item to print, and then tap the share icon.
 - 3 Tap **Print**, and then select a printer.
 - 4 Print the document.

Printing from a mobile device using Lexmark Mobile Print

Lexmark™ Mobile Print allows you to send documents and images directly to a supported Lexmark printer.

- 1 Open the document, and then send or share the document to Lexmark Mobile Print.

Note: Some third-party applications may not support the send or share feature. For more information, see the documentation that came with the application.

- 2 Select a printer.
- 3 Print the document.

Printing confidential and other held jobs

Storing print jobs in the printer

- 1 From the printer control panel, navigate to:

 > **Settings** >  > **Security** >  > **Confidential Print** > select the print job type

Print job type	Description
Max Invalid PIN	Limits the number of times an invalid PIN can be entered. Note: When the limit is reached, the print jobs for that user name and PIN are deleted.
Confidential Job Expiration	Lets you hold print jobs in the computer until you enter the PIN from the printer control panel. Note: The PIN is set from the computer. It must be four digits, using the numbers 0–9.
Repeat Job Expiration	Lets you print <i>and</i> store print jobs in the printer memory for reprinting.
Verify Job Expiration	Lets you print one copy of a print job while the printer holds the remaining copies. It allows you to examine if the first copy is satisfactory. The print job is automatically deleted from the printer memory once all copies are printed.
Reserve Job Expiration	Lets you store print jobs for printing at a later time. The print jobs are held until deleted from the Held Jobs menu.
Notes: <ul style="list-style-type: none"> • Confidential, Verify, Reserve, and Repeat print jobs may be deleted if the printer requires extra memory to process additional held jobs. • You can set the printer to store print jobs in the printer memory until you start the print job from the printer control panel. • All print jobs that can be initiated by the user at the printer are called <i>held jobs</i>. 	

2 Press .

Printing held jobs

- 1 From the document that you are trying to print, open the Print dialog.
- 2 Select the printer, and then do either of the following:
 - For Windows users, click **Properties** or **Preferences**, and then click **Print and Hold**.
 - For Macintosh users, select **Print and Hold**.
- 3 Select the print job type.
- 4 If necessary, assign a user name.
- 5 Send the print job.
- 6 From the printer home screen, select **Held Jobs**.
- 7 Send the print job.

Modifying confidential print settings

- 1 Open a Web browser, and then type the printer IP address in the address field.

Notes:

- View the printer IP address on the printer home screen. The IP address appears as four sets of numbers separated by periods, such as 123.123.123.123.
- If you are using a proxy server, then temporarily disable it to load the Web page correctly.

2 Click **Settings** > **Security** > **Confidential Print Setup**.

3 Modify the settings:

- Set a maximum number of PIN entry attempts. When a user exceeds that number, all of the jobs for that user are deleted.
- Set an expiration time for confidential print jobs. When a user has not printed the jobs within that time, all of the jobs for that user are deleted.

4 Click **Submit** to save the modified settings.

Printing information pages

Printing a font sample list

1 From the printer control panel, navigate to:

 > **Settings** >  > **Reports** >  > **Print Fonts**

2 Press the up or down arrow button to select the font setting.

3 Press .

Note: The PPDS fonts appear only when the PPDS data stream is activated.

Canceling a print job

Canceling a print job from the printer control panel

1 From the printer control panel, press .

2 When a list of print jobs appears, select the job to cancel, and then press .

3 Press  to go back to the home screen.



Canceling a print job from the computer

1 Depending on the operating system, do either of the following:

- Open the printers folder, and then select your printer.
- From the System Preferences in the Apple menu, navigate to your printer.

2 Select the print job to cancel.

Copying

Automatic document feeder (ADF)	Scanner glass
 <p>Use the ADF for multiple-page documents.</p> <p>Note: The ADF scans only one-side of the page.</p>	 <p>Use the scanner glass for single-page documents, book pages, small items (such as postcards or photos), transparencies, photo paper, or thin media (such as magazine clippings).</p>

Making copies

Making a quick copy

- 1 Load an original document faceup, short edge first into the ADF tray or facedown on the scanner glass.

Notes:

- Do not load postcards, photos, small items, transparencies, photo paper, or thin media (such as magazine clippings) into the ADF tray. Place these items on the scanner glass.
- The ADF indicator light comes on when the paper is loaded properly.

- 2 If you are loading a document into the ADF tray, then adjust the paper guides.

Note: To avoid a cropped image, make sure the size of the original document and the size of the copy paper are the same.

- 3 From the printer control panel, press .

Copying using the ADF

- 1 Load an original document faceup, short edge first into the ADF tray.

Notes:

- Do not load postcards, photos, small items, transparencies, photo paper, or thin media (such as magazine clippings) into the ADF tray. Place these items on the scanner glass.

- The ADF indicator light comes on when the paper is loaded properly.

2 Adjust the paper guides.

3 From the printer control panel, use the keypad to enter the number of copies, and then press .

Copying using the scanner glass

1 Place an original document facedown on the scanner glass in the upper left corner.

2 From the printer control panel, use the keypad to enter the number of copies, and then press .

Note: If you want to scan another document, then place the next document on the scanner glass, press the left or right arrow button to scroll to **Scan the Next Page**, and then press .

3 Press the left or right arrow button to scroll to **Finish the Job**, and then press .

Copying photos

1 Place a photo facedown on the scanner glass in the upper left corner.

2 From the printer control panel, navigate to:

 > **Copy** >  > **Content Type** > **Photo**

3 From the Content Source menu, choose a setting that best describes the original photo you are copying, and then press .

Note: If you want to copy another photo, then place it on the scanner glass, press the left or right arrow button to scroll to **Scan the Next Page**, and then press .

4 Press the left or right arrow button to scroll to **Finish the Job**, and then press .

Copying on specialty media

Copying on transparencies

1 Load an original document faceup, short edge first into the ADF tray or facedown on the scanner glass.

Notes:



- Do not load postcards, photos, small items, transparencies, photo paper, or thin media (such as magazine clippings) into the ADF tray. Place these items on the scanner glass.
- The ADF indicator light comes on when the paper is loaded properly.

2 If you are loading a document into the ADF tray, then adjust the paper guides.

3 From the printer control panel, navigate to:





 > **Copy** >  > **Copy from** > select the size of the original document

4 Navigate to:

Copy to >  > select the tray containing the transparencies >  > select the number of copies or enter a number on the keypad > 

5 If there are no trays that contain transparencies, then do the following:

a Navigate to:

Copy to >  > **Manual Feeder** >  > select the size of the transparencies >  > **Transparency** > 

b Load transparencies into the multipurpose feeder, and then press .

Note: If you want to copy another document, then place it on the scanner glass, press the left or right arrow button to scroll to **Scan the Next Page**, and then press .

6 Press the left or right arrow button to scroll to **Finish the Job**, and then press .

Copying on letterhead

1 Load an original document faceup, short edge first into the ADF tray or facedown on the scanner glass.

Notes:



- Do not load postcards, photos, small items, transparencies, photo paper, or thin media (such as magazine clippings) into the ADF tray. Place these items on the scanner glass.
- The ADF indicator light comes on when the paper is loaded properly.

2 If you are loading a document into the ADF tray, then adjust the paper guides.

3 From the printer control panel, navigate to:

 > **Copy** >  > **Copy from** > select the size of the original document

4 Navigate to:

Copy to >  > select the tray containing the letterhead >  > select the number of copies or enter a number on the keypad > 

5 If there are no trays that contain letterhead, then do the following:

a Navigate to:

Copy to >  > **Manual Feeder** >  > select the size of the letterhead > **Letterhead**

b Place the letterhead faceup, top edge first into the multipurpose feeder, and then press .

Note: If you want to copy another document, then place it on the scanner glass, press the left or right arrow button to scroll to **Scan the Next Page**, and then press .

6 Press the left or right arrow button to scroll to **Finish the Job**, and then press .

Customizing copy settings

Copying to a different size

- 1 Load an original document faceup, short edge first into the ADF tray or facedown on the scanner glass.

Notes:



- Do not load postcards, photos, small items, transparencies, photo paper, or thin media (such as magazine clippings) into the ADF tray. Place these items on the scanner glass.
- The ADF indicator light comes on when the paper is loaded properly.

- 2 If you are loading a document into the ADF tray, then adjust the paper guides.

- 3 From the printer control panel, navigate to:

 > **Copy** >  > **Copy from** > select the size of the original document

- 4 Navigate to:

Copy to >  > select a new size for the copy > select the number of copies or enter a number on the keypad > 

Note: If you want to copy another document, then place it on the scanner glass, press the left or right arrow button to scroll to **Scan the Next Page**, and then press .

- 5 Press the left or right arrow button to scroll to **Finish the Job**, and then press .

Making copies using paper from a selected tray

- 1 Load an original document faceup, short edge first into the ADF tray or facedown on the scanner glass.

Notes:



- Do not load postcards, photos, small items, transparencies, photo paper, or thin media (such as magazine clippings) into the ADF tray. Place these items on the scanner glass.
- The ADF indicator light comes on when the paper is loaded properly.

- 2 If you are loading a document into the ADF tray, then adjust the paper guides.

- 3 From the printer control panel, navigate to:





 > **Copy** >  > **Copy from** > select the size of the original document

- 4 Navigate to:

Copy to >  > select the tray containing the paper size and type you want to use >  > select the number of copies or enter a number on the keypad > 

5 If there are no trays that contain the paper size and type you want to use, then do the following:

a Navigate to:

Copy to >  > **Manual Feeder** >  > select the paper size >  > select the paper type > 

b Load the size and type of paper into the multipurpose feeder, and then press .

Note: If you want to copy another document, then place it on the scanner glass, press the left or right arrow button to scroll to **Scan the Next Page**, and then press .

6 Press the left or right arrow button to scroll to **Finish the Job**, and then press .

Reducing or enlarging copies

Copies can be scaled from 25% to 400% of the original document size.



1 Load an original document faceup, short edge first into the ADF tray or facedown on the scanner glass.

Notes:

- Do not load postcards, photos, small items, transparencies, photo paper, or thin media (such as magazine clippings) into the ADF tray. Place these items on the scanner glass.
- The ADF indicator light comes on when the paper is loaded properly.

2 If you are loading a document into the ADF tray, then adjust the paper guides.

3 From the printer control panel, navigate to:

 > **Copy** >  > **Scale** > adjust the scale setting > select the number of copies or enter a number on the keypad > 

Note: If you want to copy another document, then place it on the scanner glass, press the left or right arrow button to scroll to **Scan the Next Page**, and then press .

4 Press the left or right arrow button to scroll to **Finish the Job**, and then press .

Making a copy lighter or darker



1 Load an original document faceup, short edge first into the ADF tray or facedown on the scanner glass in the upper left corner.

Notes:

- Do not load postcards, photos, small items, transparencies, photo paper, or thin media (such as magazine clippings) into the ADF tray. Place these items on the scanner glass.
- The ADF indicator light comes on when the paper is loaded properly.

2 If you are loading a document into the ADF tray, then adjust the paper guides.

3 From the printer control panel, navigate to:

 > **Copy** >  > **Darkness** > adjust the darkness setting > select the number of copies or enter a number on the keypad > 

Note: If you want to copy another document, then place it on the scanner glass, press the left or right arrow button to scroll to **Scan the Next Page**, and then press .

4 Press the left or right arrow button to scroll to **Finish the Job**, and then press .

Adjusting copy quality



1 Load an original document faceup, short edge first into the ADF tray or facedown on the scanner glass.

Notes:

- Do not load postcards, photos, small items, transparencies, photo paper, or thin media (such as magazine clippings) into the ADF tray. Place these items on the scanner glass.
- The ADF indicator light comes on when the paper is loaded properly.

2 If you are loading a document into the ADF tray, then adjust the paper guides.

3 From the printer control panel, navigate to:

 > **Copy** >  > **Content Type** > select the content type of the original document

4 Press the left or right arrow button to scroll to one of the following:

- **Text**—The content of the original document is mostly text or line art.
- **Text/Photo**—The original document is a mixture of text and graphics or photos.
- **Photo**—The original document is mostly a photo or an image.
- **Graphics**—The original document is mostly business-type graphics, such as pie charts, bar charts, and animations.

5 Press the up or down arrow button until **Content Source** appears, and then press the left or right arrow button to scroll to one of the following:

- **Color Laser**—The original document was printed using a color laser printer.
- **Inkjet**—The original document was printed using an inkjet printer.
- **Magazine**—The original document is from a magazine.
- **Press**—The original document is from an offset press.
- **Black/White Laser**—The original document was printed using a mono laser printer.
- **Photo/Film**—The original document is a photo from a film.
- **Newspaper**—The original document is from a newspaper.
- **Other**—The original document was printed using an alternate or unknown printer.



6 Select the number of copies or enter a number on the keypad, and then press .

Note: If you want to copy another document, then place it on the scanner glass, press the left or right arrow button to scroll to **Scan the Next Page**, and then press .

7 Press the left or right arrow button to scroll to **Finish the Job**, and then press .

Collating copies

If you print multiple copies of a document, then you can choose to print each copy as a set (collated) or to print the copies as groups of pages (not collated).

Collated	Not collated
	

To select a Collate setting:



1 Load an original document faceup, short edge first into the ADF tray or facedown on the scanner glass.

Notes:

- Do not load postcards, photos, small items, transparencies, photo paper, or thin media (such as magazine clippings) into the ADF tray. Place these items on the scanner glass.
- The ADF indicator light comes on when the paper is loaded properly.

2 If you are loading a document into the ADF tray, then adjust the paper guides.

3 From the printer control panel, navigate to:

 > **Copy** >  > **Collate** > select the collate setting you want > select the number of copies or enter a number on the keypad > 

Note: If you want to copy another document, then place it on the scanner glass, press the left or right arrow button to scroll to **Scan the Next Page**, and then press .

4 Press the left or right arrow button to scroll to **Finish the Job**, and then press .

Placing separator sheets between copies

1 Load an original document faceup, short edge first into the ADF tray or facedown on the scanner glass.

Notes:

- Do not load postcards, photos, small items, transparencies, photo paper, or thin media (such as magazine clippings) into the ADF tray. Place these items on the scanner glass.
- The ADF indicator light comes on when the paper is loaded properly.

2 If you are loading a document into the ADF tray, then adjust the paper guides.

3 From the printer control panel, navigate to:

 > **Copy** >  > **Separator Sheets**

4 Select **Between Copies**, **Between Jobs**, **Between Pages**, or **Off**.

5 Select the number of copies or enter a number on the keypad, and then press .

Note: If you want to copy another document, then place it on the scanner glass, press the left or right arrow button to scroll to **Scan the Next Page**, and then press .

6 Press the left or right arrow button to scroll to **Finish the Job**, and then press .

Copying multiple pages onto a single sheet

To save paper, you can copy either two or four consecutive pages of a multiple-page document onto a single sheet of paper.

Notes:

- Make sure the paper size is set to letter, legal, A4, or JIS B5.
- The copy size must be set to 100%.

1 Load an original document faceup, short edge first into the ADF tray or facedown on the scanner glass.

Notes:

- Do not load postcards, photos, small items, transparencies, photo paper, or thin media (such as magazine clippings) into the ADF tray. Place these items on the scanner glass.
- The ADF indicator light comes on when the paper is loaded properly.

2 If you are loading a document into the ADF tray, then adjust the paper guides.

3 From the printer control panel, navigate to:

 > **Copy** >  > **Paper Saver** > select the setting that you want

4 Select **Off**, **2-up Portrait**, **2-up Landscape**, **4-up Portrait**, or **4-up Landscape**.

5 Select the number of copies or enter a number on the keypad, and then press .

Note: If you want to copy another document, then place it on the scanner glass, press the left or right arrow button to scroll to **Scan the Next Page**, and then press .

6 Press the left or right arrow button to scroll to **Finish the Job**, and then press .

Placing information on copies

Placing an overlay message on each page

1 Load an original document faceup, short edge first into the ADF tray or facedown on the scanner glass.

Notes:

- Do not load postcards, photos, small items, transparencies, photo paper, or thin media (such as magazine clippings) into the ADF tray. Place these items on the scanner glass.
- The ADF indicator light comes on when the paper is loaded properly.

2 If you are loading a document into the ADF tray, then adjust the paper guides.

3 From the printer control panel, navigate to:

 > **Copy** >  > **Overlay** > select an overlay message you want

4 Select **Off**, **Confidential**, **Copy**, **Draft**, **Urgent**, or **Custom**.

5 Select the number of copies or enter a number on the keypad, and then press .

Note: If you want to copy another document, then place it on the scanner glass, press the left or right arrow button to scroll to **Scan the Next Page**, and then press .

6 Press the left or right arrow button to scroll to **Finish the Job**, and then press .

Canceling a copy job

Canceling a copy job from the printer control panel

1 From the printer control panel, press .

2 When a list of copy jobs appears, select the job to cancel, and then press .

3 Press  to go back to the home screen.



Understanding the copying options

Copies

This option lets you set the number of copies to be printed.

Copy from

This option opens a screen where you can select the paper size of the original document.

- To scroll to the paper size that matches the original document, press the left or right arrow button, and then press .
- To copy an original document that contains mixed paper sizes with the same width, press the left or right arrow button to scroll to **Mixed Sizes**, and then press .

Copy to

This option lets you select the paper size and type on which your copies will be printed.

- To scroll to the paper size and type that matches the paper loaded in the tray or feeder, press the left or right arrow button, and then press **OK**.
- If the settings for “Copy from” and “Copy to” are different, then the printer automatically adjusts the Scale setting to accommodate the difference.
- If the paper type or size you want to use is not loaded in one of the trays, then press the left or right arrow button to scroll to **Manual Feeder**, press **OK**, and then manually load the paper in the manual feeder or multipurpose feeder.
- To match each copy to the paper size of the original document, set “Copy to” to Auto Size Match. If a matching paper size is not in one of the trays, then **Paper size not found** appears and prompts to load a paper in a tray, manual feeder, or multipurpose feeder.

Scale

This option lets you scale the document from 25% to 400% of the original document size. You can also set automatic scaling.

- When copying to a different paper size, such as from legal-size to letter-size paper, set the “Copy from” and “Copy to” paper sizes automatically to scale the scan image to fit the size of the paper onto which you are copying.
- To decrease or increase the value by 1%, press the left or right arrow button on the printer control panel. To make a continuous decrease or increase in value, press and hold the button for two or more seconds.

Darkness

This option lets you adjust how light or dark the copies are in relation to the original document.

Collate

This option keeps the pages of a print job stacked in sequence when printing multiple copies of the document.

Content Type

This option lets you set the original document type.

Select from the following content types:

- **Graphics**—The original document is mostly business-type graphics, such as pie charts, bar charts, and animations.
- **Photo**—The original document is mostly a photo or an image.
- **Text**—The content of the original document is mostly text or line art.
- **Text/Photo**—The original document is a mixture of text, graphics, and photos.

Content Source

This option lets you set the original document source.

Select from the following content sources:

- **Color Laser**—The original document was printed using a color laser printer.
- **Black/White Laser**—The original document was printed using a mono laser printer.
- **Inkjet**—The original document was printed using an inkjet printer.
- **Photo/Film**—The original document is a photo from a film.
- **Magazine**—The original document is from a magazine.
- **Newspaper**—The original document is from a newspaper.
- **Press**—The original document was printed using a printing press.
- **Other**—The original document was printed using an alternate or unknown printer.

Color

This option lets you set the output to either color or monochrome for the scanned image.

Overlay

This option lets you create a watermark (or message) that overlays the content of your copy. You can choose from Confidential, Copy, Draft, Urgent, and Custom. You can type a custom message in the "Enter the Custom Text Overlay and press OK" field. The message will appear, faintly, in large print across each page.



Separator Sheets

This option lets you place a blank sheet of paper between copies, prints, pages, print jobs or copy jobs. The separator sheets can be drawn from a tray that contains a type or color of paper that is different from the paper your copies are printed on.

Paper Saver

This option lets you print two or more pages of an original document on the same page. Paper Saver is also called *N-up* printing where *N* stands for the number of pages. For example, 2-up would print two pages of your document on a single page, and 4-up would print four pages of your document on a single page.

E-mailing

Automatic document feeder (ADF)	Scanner glass
 <p>Use the ADF for multiple-page documents.</p> <p>Note: The ADF scans only one-side of the page.</p>	 <p>Use the scanner glass for single-page documents, book pages, small items (such as postcards or photos), transparencies, photo paper, or thin media (such as magazine clippings).</p>

You can use the printer to e-mail scanned documents to one or more recipients. You can type the e-mail address or use a shortcut number to send an e-mail from the printer.

Setting up the printer to e-mail

Setting up the e-mail function

- 1 Open a Web browser, and then type the printer IP address in the address field.

Notes:

- View the printer IP address in the TCP/IP section in the Network/Ports menu. The IP address appears as four sets of numbers separated by periods, such as 123.123.123.123.
- If you are using a proxy server, then temporarily disable it to load the Web page correctly.

- 2 Click **Settings > E-mail/FTP Settings > E-mail Settings**.

- 3 Enter the appropriate information, and then click **Submit**.

Configuring e-mail settings

- 1 Open a Web browser, and then type the printer IP address in the address field.

Notes:

- View the printer IP address in the TCP/IP section in the Network/Ports menu. The IP address appears as four sets of numbers separated by periods, such as 123.123.123.123.

- If you are using a proxy server, then temporarily disable it to load the Web page correctly.
- 2 Click **Settings** > **E-mail/FTP Settings** > **E-mail Settings**.
 - 3 Enter the appropriate information, and then click **Submit**.

Creating an e-mail shortcut

Creating an e-mail shortcut using the Embedded Web Server

- 1 Open a Web browser, and then type the printer IP address in the address field.

Notes:

- View the printer IP address in the TCP/IP section in the Network/Ports menu. The IP address appears as four sets of numbers separated by periods, such as 123.123.123.123.
- If you are using a proxy server, then temporarily disable it to load the Web page correctly.

- 2 Click **Settings** > **Manage Shortcuts** > **E-mail Shortcut Setup**.
- 3 Type a name for the shortcut, and then enter the e-mail address.

Note: If you are entering multiple addresses, then separate each address with a comma (,).

- 4 Adjust the scan settings, if necessary.
- 5 Enter a shortcut number, and then click **Add**.

If you enter a number that is already in use, then you are prompted to select another number.



E-mailing a document

Sending an e-mail using a shortcut number

- 1 Load an original document faceup, short edge first into the ADF tray or facedown on the scanner glass.

Notes:

- Do not load postcards, photos, small items, transparencies, photo paper, or thin media (such as magazine clippings) into the ADF tray. Place these items on the scanner glass.
- The ADF indicator light comes on when the paper is loaded properly.

- 2 If you are loading a document into the ADF tray, then adjust the paper guides.
- 3 Press #, then enter the shortcut number using the keypad, and then press .
- 4 Press .

Sending an e-mail using the printer control panel



- 1 Load an original document faceup, short edge first into the ADF tray or facedown on the scanner glass.

Notes:

- Do not load postcards, photos, small items, transparencies, photo paper, or thin media (such as magazine clippings) into the ADF tray. Place these items on the scanner glass.
- The ADF indicator light comes on when the paper is properly loaded.

2 If you are loading a document into the ADF tray, then adjust the paper guides.

3 From the printer control panel, press the up or down arrow button to scroll to **Shortcuts**, and then press .

4 Press **Email Shortcuts** >  > select the name of the recipient >  or .



Note: Shortcuts can be created only from the Embedded Web Server.

Canceling an e-mail

From the printer control panel, press .

Scanning

Scanning to an FTP address

Automatic document feeder (ADF)	Scanner glass
	
<p>Use the ADF for multiple-page documents.</p> <p>Note: The ADF scans only one side of the page.</p>	<p>Use the scanner glass for single-page documents, book pages, small items (such as postcards or photos), transparencies, photo paper, or thin media (such as magazine clippings).</p>

The scanner lets you scan documents directly to a File Transfer Protocol (FTP) server. Only one FTP address may be sent to the server at a time.

When an FTP destination has been configured by your system support person, the name of the destination becomes available as a shortcut number, or it is listed as a profile under the Held Jobs icon. An FTP destination could also be another PostScript printer.

Creating shortcuts

Instead of entering the entire FTP site address on the printer control panel each time you want to send a document to an FTP server, you can create a permanent FTP destination and assign a shortcut number. There are two methods for creating shortcut numbers: using the Embedded Web Server and using the printer control panel.

Creating an FTP shortcut using the Embedded Web Server

- 1 Open a Web browser, and then type the printer IP address in the address field.

Notes:

- View the printer IP address in the TCP/IP section in the Network/Ports menu. The IP address appears as four sets of numbers separated by periods, such as 123.123.123.123.
- If you are using a proxy server, then temporarily disable it to load the Web page correctly.

- 2 Navigate to:

Settings > Other Settings area > Manage Shortcuts > FTP Shortcut Setup

3 Enter the appropriate information.

Note: A password may be required. If you do not have an ID and password, then contact your system support person.

4 Enter a shortcut number.

If you enter a number that is already in use, then you are prompted to select another number.

5 Click **Add**.

Scanning to an FTP address

Scanning to an FTP address using a shortcut number

1 Load an original document faceup, short edge first into the ADF tray or facedown on the scanner glass.

Notes:

- Do not load postcards, photos, small items, transparencies, photo paper, or thin media (such as magazine clippings) into the ADF tray. Place these items on the scanner glass.
- The ADF indicator light comes on when the paper is loaded properly.

2 If you are loading a document into the ADF tray, then adjust the paper guides.

3 From the printer control panel, press #, and then enter the FTP shortcut number.

4 Press .

Scanning to an FTP address using the printer control panel



1 Load an original document faceup, short edge first into the ADF tray or facedown on the scanner glass.

Notes:

- Do not load postcards, photos, small items, transparencies, photo paper, or thin media (such as magazine clippings) into the ADF tray. Place these items on the scanner glass.
- The ADF indicator light comes on when the paper is properly loaded.



2 If you are loading a document into the ADF tray, then adjust the paper guides.

3 From the printer control panel, press the up or down arrow button to scroll to **Shortcuts**, and then press .

4 Press **FTP Shortcuts** >  > select the name of the recipient >  or .

Note: Shortcuts can be created only from the Embedded Web Server.

Scanning to a computer

Automatic document feeder (ADF)	Scanner glass
	
<p>Use the ADF for multiple-page documents.</p> <p>Note: The ADF scans only one-side of the page.</p>	<p>Use the scanner glass for single pages, small items (such as postcards or photos), transparencies, photo paper, or thin media (such as magazine clippings).</p>

The scanner lets you scan documents directly to a computer. The computer does not have to be directly connected to the printer for you to receive images when scanning. You can scan the document back to the computer over the network by creating a scan profile on the computer and then downloading the profile to the printer.

Scanning to a computer

- 1 Open a Web browser, and then type the printer IP address in the address field.

Notes:

- View the printer IP address in the TCP/IP section in the Network/Ports menu. The IP address appears as four sets of numbers separated by periods, such as 123.123.123.123.
- If you are using a proxy server, then temporarily disable it to load the Web page correctly.

- 2 Click **Scan Profile > Create Scan Profile**.

- 3 Select your scan settings, and then click **Next**.

- 4 Select a location on your computer where you want to save the scanned output file.

- 5 Type a scan name.

The scan name is the name that appears in the Scan Profile list on the display.

- 6 Click **Submit**.

- 7 Review the instructions on the Scan Profile screen.

A shortcut number is automatically assigned when you click **Submit**. You can use this shortcut number when you are ready to scan your documents.

- a Load an original document faceup, short edge first into the ADF tray or facedown on the scanner glass.

Notes:

- Do not load postcards, photos, small items, transparencies, photo paper, or thin media (such as magazine clippings) into the ADF tray. Place these items on the scanner glass.
- The ADF indicator light turns on when the paper is loaded properly.

b If you are loading a document into the ADF tray, then adjust the paper guides.

c From the printer control panel, press **#**, and then type the shortcut number using the keypad, or press the up or down arrow button to scroll to **Held Jobs**, and then press the up or down arrow button to scroll to **Profiles**.

After entering the shortcut number, the scanner scans and sends the document to the directory or program you specified. If you selected **Profiles** on the printer control panel, then locate your shortcut on the list.

8 View the file from the computer.

The output file is saved in the location or launched in the program you specified.

Understanding the printer menus

Menus list

Supplies Menu

Cyan Cartridge
Magenta Cartridge
Yellow Cartridge
Black Cartridge
Waste Toner Bottle
Imaging Kit
Maintenance Kit

Paper Menu

Default Source
Paper Size/Type
Substitute Size
Paper Texture
Paper Weight
Paper Loading
Custom Types
Custom Scan Sizes
Universal Setup

Reports

Menu Settings Page
Device Statistics
Network Setup Page
Network [x] Setup Page
Shortcut List
Copy Shortcuts
E-mail Shortcuts
FTP Shortcuts
Profiles List
Print Fonts
Print Directory
Print Demo
Asset Report
Event Log Summary

Network/Ports

Active NIC
Standard Network or
Network [x]
Standard USB
SMTP Setup

Security

Confidential Print
Security Audit Log
Set Date and Time

Settings

General Settings
Copy Settings
E-mail Settings
FTP Settings
Print Settings

Help

Print All Guides
Copy Guide
E-mail Guide
FTP Guide
Color Quality
Print Defects Guide
Information Guide
Supplies Guide

Option Card Menu

[index of each installed
DLE]

Supplies menu

Use	To
Cyan Cartridge	View the status of the toner cartridges, which can be any of the following: Early Warning Low Invalid Near End of Life Replace Missing Defective OK Unsupported
Magenta Cartridge	
Yellow Cartridge	
Black Cartridge	
Waste Toner Bottle Near Full Replace Missing OK	View the status of the waste toner bottle.
Imaging Kit OK Replace Black Imaging Kit Replace Color Imaging Kit	View the status of the imaging kit.
Maintenance Kit OK Replace	View the status of the maintenance kit.

Paper menu

Default Source menu

Use	To
Default Source Tray [x] MP Feeder Manual Paper Manual Envelope	Set a default paper source for all print jobs. Notes: <ul style="list-style-type: none"> • Tray 1 (standard tray) is the factory default setting. • From the Paper menu, set Configure MP to “Cassette” for MP Feeder to appear as a menu setting. • If the same size and type of paper are in two trays and the paper size and paper type settings match, then the trays are automatically linked. When one tray is empty, the print job continues using the linked tray.

Paper Size/Type menu

Use	To
<p>Tray [x] Size</p> <ul style="list-style-type: none"> A4 A5 JIS-B5 Letter Legal Executive Oficio (Mexico) Folio Universal 	<p>Specify the paper size loaded in each tray.</p> <p>Notes:</p> <ul style="list-style-type: none"> • Letter is the U.S. factory default setting. A4 is the international factory default setting. • If two trays contain paper of the same size and type, and the trays have the same settings, then the trays are automatically linked. When one tray is empty, the print job continues using the linked tray.
<p>Tray [x] Type</p> <ul style="list-style-type: none"> Plain Paper Card Stock Transparency Recycled Labels Glossy Bond Letterhead Preprinted Colored Paper Light Paper Heavy Paper Rough/Cotton Custom Type [x] 	<p>Specify the type of paper loaded in each tray.</p> <p>Notes:</p> <ul style="list-style-type: none"> • Plain Paper is the factory default setting for Tray 1. Custom Type [x] is the factory default setting for all other trays. • If available, a user-defined name appears instead of Custom Type [x]. • Use this menu to configure automatic tray linking. • Transparency is supported only in the 250-sheet tray.
<p>Note: Only installed trays and feeders are listed in this menu.</p>	

Use	To
<p>Multipurpose Feeder Size</p> <ul style="list-style-type: none"> A4 A5 A6 JIS B5 Letter Legal Executive Oficio (Mexico) Folio Statement Universal 7 3/4 Envelope 9 Envelope 10 Envelope DL Envelope C5 Envelope B5 Envelope Other Envelope 	<p>Specify the paper size loaded in the multipurpose feeder.</p> <p>Notes:</p> <ul style="list-style-type: none"> • Letter is the U.S. factory default setting. A4 is the international factory default setting. • The menu item applies only when the multipurpose feeder is installed. • The multipurpose feeder does not automatically detect paper size. The paper size value must be set.
<p>Multipurpose Feeder Type</p> <ul style="list-style-type: none"> Plain Paper Card Stock Transparency Recycled Glossy Labels Bond Envelope Letterhead Preprinted Colored Paper Light Paper Heavy Paper Rough/Cotton Custom Type [x] 	<p>Specify the paper type loaded in the multipurpose feeder.</p> <p>Note: Custom Type [x] is the factory default setting.</p>
<p>Note: Only installed trays and feeders are listed in this menu.</p>	

Use	To
<p>Manual Paper Size</p> <ul style="list-style-type: none"> A4 A5 A6 JIS B5 Letter Legal Executive Oficio (Mexico) Folio Statement Universal 	<p>Specify the size of the paper being manually loaded.</p> <p>Note: Letter is the U.S. factory default setting. A4 is the international factory default setting.</p>
<p>Manual Paper Type</p> <ul style="list-style-type: none"> Plain Paper Card Stock Transparency Recycled Glossy Labels Bond Letterhead Preprinted Colored Paper Light Paper Heavy Paper Rough/Cotton Custom Type [x] 	<p>Specify the paper type being manually loaded.</p> <p>Note: Plain Paper is the factory default setting.</p>
<p>Manual Envelope Size</p> <ul style="list-style-type: none"> 7 3/4 Envelope 9 Envelope 10 Envelope DL Envelope C5 Envelope B5 Envelope Other Envelope 	<p>Specify the envelope size being manually loaded.</p> <p>Note: 10 Envelope is the U.S. factory default setting. DL Envelope is the international factory default setting.</p>
<p>Manual Envelope Type</p> <ul style="list-style-type: none"> Envelope Custom Type [x] 	<p>Specify the envelope type being manually loaded.</p> <p>Note: Envelope is the factory default setting.</p>
<p>Note: Only installed trays and feeders are listed in this menu.</p>	

Substitute Size menu

Use	To
<p>Substitute Size Off Statement/A5 Letter/A4 All Listed</p>	<p>Substitute a specified paper size if the requested paper size is not available.</p> <p>Notes:</p> <ul style="list-style-type: none"> • All Listed is the factory default setting. All available substitutions are allowed. • Off indicates that no size substitutions are allowed. • Setting a size substitution lets the print job continue without Change Paper appearing.

Paper Texture menu

Use	To
<p>Plain Texture Smooth Normal Rough</p>	<p>Specify the relative texture of the plain paper loaded.</p> <p>Note: Normal is the factory default setting.</p>
<p>Card Stock Texture Smooth Normal Rough</p>	<p>Specify the relative texture of the card stock loaded.</p> <p>Notes:</p> <ul style="list-style-type: none"> • Normal is the factory default setting. • The options appear only if card stock is supported.
<p>Transparency Texture Smooth Normal Rough</p>	<p>Specify the relative texture of the transparencies loaded.</p> <p>Note: Normal is the factory default setting.</p>
<p>Recycled Texture Smooth Normal Rough</p>	<p>Specify the relative texture of the recycled paper loaded.</p> <p>Note: Normal is the factory default setting.</p>
<p>Glossy Texture Smooth Normal Rough</p>	<p>Specify the relative texture of the glossy paper loaded.</p> <p>Note: Normal is the factory default setting.</p>
<p>Labels Texture Smooth Normal Rough</p>	<p>Specify the relative texture of the labels loaded.</p> <p>Note: Normal is the factory default setting.</p>
<p>Bond Texture Smooth Normal Rough</p>	<p>Specify the relative texture of the bond paper loaded.</p> <p>Note: Rough is the factory default setting.</p>

Use	To
Envelope Texture Smooth Normal Rough	Specify the relative texture of the envelopes loaded. Note: Normal is the factory default setting.
Letterhead Texture Smooth Normal Rough	Specify the relative texture of the letterhead loaded. Note: Normal is the factory default setting.
Preprinted Texture Smooth Normal Rough	Specify the relative texture of the preprinted paper loaded. Note: Normal is the factory default setting.
Colored Texture Smooth Normal Rough	Specify the relative texture of the colored paper loaded. Note: Normal is the factory default setting.
Light Texture Smooth Normal Rough	Specify the relative texture of the light paper loaded. Note: Normal is the factory default setting.
Heavy Texture Smooth Normal Rough	Specify the relative texture of the heavy paper loaded. Note: Normal is the factory default setting.
Rough/Cotton Texture Rough	Specify the relative texture of the cotton paper loaded.
Custom [x] Texture Smooth Normal Rough	Specify the relative texture of the custom paper loaded. Notes: <ul style="list-style-type: none"> • Normal is the factory default setting. • The options appear only if custom type is supported.

Paper Weight menu

Use	To
Plain Weight Light Normal Heavy	Specify the relative weight of the plain paper loaded. Note: Normal is the factory default setting.

Use	To
Card Stock Weight Light Normal Heavy	Specify the relative weight of the card stock loaded. Note: Normal is the factory default setting.
Transparency Weight Light Normal Heavy	Specify the relative weight of the transparencies loaded. Note: Normal is the factory default setting.
Recycled Weight Light Normal Heavy	Specify the relative weight of the recycled paper loaded. Note: Normal is the factory default setting.
Glossy Weight Light Normal Heavy	Specify the relative weight of the glossy paper loaded. Note: Normal is the factory default setting.
Labels Weight Light Normal Heavy	Specify the relative weight of the labels loaded. Note: Normal is the factory default setting.
Bond Weight Light Normal Heavy	Specify the relative weight of the bond paper loaded. Note: Normal is the factory default setting.
Envelope Weight Light Normal Heavy	Specify the relative weight of the envelope loaded. Note: Normal is the factory default setting.
Letterhead Weight Light Normal Heavy	Specify the relative weight of the letterhead loaded. Note: Normal is the factory default setting.
Preprinted Weight Light Normal Heavy	Specify the relative weight of the preprinted paper loaded. Note: Normal is the factory default setting.
Colored Weight Light Normal Heavy	Specify the relative weight of the colored paper loaded. Note: Normal is the factory default setting.
Light Weight Light	Specify that the relative weight of the paper loaded is light.

Use	To
Heavy Weight Heavy	Specify that the relative weight of the paper loaded is heavy.
Rough/Cotton Weight Light Normal Heavy	Specify the relative weight of the rough or cotton paper loaded. Note: Normal is the factory default setting.
Custom [x] Weight Light Normal Heavy	Specify the relative weight of the custom paper loaded. Notes: <ul style="list-style-type: none"> • Normal is the factory default setting. • The options appear only when the custom type is supported.

Paper Loading menu

Use	To
Recycled Loading Duplex Off	Determine and set two-sided printing for all print jobs that specify Recycled as the paper type.
Glossy Loading Duplex Off	Determine and set two-sided printing for all print jobs that specify Glossy as the paper type.
Bond Loading Duplex Off	Determine and set two-sided printing for all print jobs that specify Bond as the paper type.
Letterhead Loading Duplex Off	Determine and set two-sided printing for all print jobs that specify Letterhead as the paper type.
Preprinted Loading Duplex Off	Determine and set two-sided printing for all print jobs that specify Preprinted as the paper type.
Colored Loading Duplex Off	Determine and set two-sided printing for all print jobs that specify Colored as the paper type.
Light Loading Duplex Off	Determine and set two-sided printing for all print jobs that specify Light as the paper type.
Notes: <ul style="list-style-type: none"> • Duplex sets the printer default to two-sided printing for every print job unless one-sided printing is selected from Printing Preferences or the Print dialog. • Off is the factory default setting for all the menus. 	

Use	To
Heavy Loading Duplex Off	Determine and set two-sided printing for all print jobs that specify Heavy as the paper type.
Custom [x] Loading Duplex Off	Determine and set two-sided printing for all print jobs that specify Custom [x] as the paper type. Note: Custom [x] Loading is available only when the custom type is supported.
Notes: <ul style="list-style-type: none"> • Duplex sets the printer default to two-sided printing for every print job unless one-sided printing is selected from Printing Preferences or the Print dialog. • Off is the factory default setting for all the menus. 	

Custom Types menu

Use	To
Custom Type [x] Paper Card Stock Transparency Glossy Rough/Cotton Labels Envelope	Associate a paper or specialty media type with a factory default Custom Type [x] name or a user-defined custom name created in the Embedded Web Server or MarkVision™ Professional. Notes: <ul style="list-style-type: none"> • Paper is the factory default setting for Custom Type [x]. • The custom media type must be supported in the selected tray or feeder in order to print from that source.
Recycled Paper Card Stock Transparency Glossy Rough/Cotton Labels Envelope	Specify a paper type when Recycled is selected. Notes: <ul style="list-style-type: none"> • Paper is the factory default setting. • The Recycled paper type must be supported in the selected tray or feeder in order to print from that source.

Custom Scan Sizes menu

Use	To
Custom Scan Size [x] Scan Size Name Width Height Orientation 2 scans per side Off On	Specify a custom scan size name, size, and page orientation. Notes: <ul style="list-style-type: none"> • 8.5 inches is the U.S. factory default setting for Width. 216 mm is the international factory default setting for Width. • 14 inches is the U.S. factory default setting for Height. 356 mm is the international factory default setting for Height. • Portrait is the factory default setting for Orientation. • Off is the factory default setting for 2 scans per side.

Universal Setup menu

Use	To
Units of Measure Inches Millimeters	Identify the units of measure. Notes: <ul style="list-style-type: none"> • Inches is the US factory default setting. • Millimeters is the international factory default setting.
Portrait Width 3–8.5 inches 76–216 mm	Set the portrait width. Notes: <ul style="list-style-type: none"> • If the width exceeds the maximum, then the printer uses the maximum width allowed. • 8.5 inches is the US factory default setting. You can increase the width in 0.01-inch increments. • 216 mm is the international factory default setting. You can increase the width in 1-mm increments.
Portrait Height 3–14.17 inches 76–360 mm	Set the portrait height. Notes: <ul style="list-style-type: none"> • If the height exceeds the maximum, then the printer uses the maximum height allowed. • 14 inches is the US factory default setting. You can increase the height in 0.01-inch increments. • 356 mm is the international factory default setting. You can increase the height in 1-mm increments.
Feed Direction Short Edge Long Edge	Specify the feed direction if the paper can be loaded in either direction. Notes: <ul style="list-style-type: none"> • Short Edge is the factory default setting. • Long Edge appears only when the longest edge is shorter than the maximum width supported in the tray.

Reports menu

Reports menu

Use	To
Menu Settings Page	Print a report on the current printer menu settings. The report also contains information about the status of the supplies and a list of hardware options that are successfully installed.
Device Statistics	Print a report containing printer statistics, such as supply information and number of printed pages.
Network Setup Page	Print a report containing information about the network settings of the printer. Note: This menu item appears only in printers connected to an Ethernet network or printers connected to print servers.
Network [x] Setup Page	Print a report containing information about the network settings of the printer. Note: This menu item appears only in printers connected to a wireless network or printers with a wireless network adapter installed.
Shortcut List	Print a report containing information about configured shortcuts.
E-mail Shortcuts	Print a report containing information about e-mail shortcuts.
FTP Shortcuts	Print a report containing information about FTP shortcuts.
Profiles List	Print a list of profiles stored in the printer.
Print Fonts	Print a report of all the fonts available for the printer language currently set in the printer.
Asset Report	Print a report containing asset information, including the printer serial number and model name. The report contains text and UPC bar codes that can be scanned into an asset database.
Event Log Summary	Print a summary of logged events.

Network/Ports

Active NIC menu

Use	To
Active NIC Auto [list of available network cards]	Allow the printer to connect to a network. Notes: <ul style="list-style-type: none"> • Auto is the factory default setting. • This menu item appears only if an optional network adapter is installed.

Standard Network or Network [x] menus

Note: Only active ports appear in this menu.

Use	To
Energy Efficient Ethernet Enable Disable	Set the printer Ethernet connection to a energy-saving mode. Note: Enable is the factory default setting.
PCL SmartSwitch On Off	Set the printer to automatically switch to PCL emulation when a print job requires it, regardless of the default printer language. Notes: <ul style="list-style-type: none"> • On is the factory default setting. • When Off is used, the printer does not examine incoming data. The printer uses PostScript emulation if PS SmartSwitch is set to On. It uses the default printer language specified in the Setup menu if PS SmartSwitch is set to Off.
PS SmartSwitch On Off	Set the printer to automatically switch to PS emulation when a print job requires it, regardless of the default printer language. Notes: <ul style="list-style-type: none"> • On is the factory default setting. • When Off is used, the printer does not examine incoming data. The printer uses PCL emulation if PCL SmartSwitch is set to On. It uses the default printer language specified in the Setup menu if PCL SmartSwitch is set to Off.
NPA Mode Off Auto	Set the printer to perform the special processing required for bidirectional communication following the conventions defined by the NPA protocol. Notes: <ul style="list-style-type: none"> • Auto is the factory default setting. • Changing this setting from the control panel, and then exiting the menus causes the printer to restart. The menu selection is then updated.
Network Buffer Auto 3KB to [maximum size allowed]	Set the size of the network input buffer. Notes: <ul style="list-style-type: none"> • Auto is the factory default setting. • The value can be changed in 1-KB increments. • The maximum size allowed depends on the amount of memory in the printer, the size of the other link buffers, and whether Resource Save is set to On or Off. • To increase the maximum size range for the Network Buffer, disable or reduce the size of the parallel, serial, and USB buffers. • Changing this setting from the control panel and then exiting the menus causes the printer to restart. The menu selection is then updated.

Use	To
Mac Binary PS On Off Auto	Set the printer to process Macintosh binary PostScript print jobs. Notes: <ul style="list-style-type: none"> • Auto is the factory default setting. • Off filters print jobs using the standard protocol. • On processes raw binary PostScript print jobs.
Standard Network Setup OR Network [x] Setup Reports Network Card TCP/IP IPv6 Wireless AppleTalk	Display and set the printer network settings. Note: The Wireless menu appears only when the printer is connected to a wireless network.

Reports menu

To access the menu, navigate to either of the following:

- **Network/Ports > Standard Network > Standard Network Setup > Reports**
- **Network/Ports > Network [x] > Network [x] Setup > Reports**

Use	To
Print Setup Page	Print a report containing information about the network printer settings, such as the TCP/IP address.

Network Card menu

To access the menu, navigate to either of the following:

- **Network/Ports > Standard Network > Standard Network Setup > Network Card**
- **Network/Ports > Network [x] > Network [x] Setup > Network Card**

Use	To
View Card Status Connected Disconnected	View the connection status of the wireless network adapter.
View Card Speed	View the speed of an active wireless network adapter.
Network Address UAA LAA	View the network addresses.

Use	To
Job Timeout 0, 10–225 seconds	Set the amount of time it takes for a network print job to be canceled. Notes: <ul style="list-style-type: none"> • “90 seconds” is the factory default setting. • A setting value of 0 disables the timeout. • If a value between 1 and 9 is selected, then Invalid appears on the display, and the value is not saved.
Banner Page Off On	Allow the printer to print a banner page. Note: Off is the factory default setting.

TCP/IP menu

To access the menu, navigate to either of the following:

- **Network/Ports > Standard Network > Standard Network Setup > TCP/IP**
- **Network/Ports > Network [x] > Network [x] Setup > TCP/IP**

Note: This menu is available only in network printers or printers attached to print servers.

Use	To
Set Hostname	Set the current TCP/IP host name. Note: This can be changed only from the Embedded Web Server.
IP Address	View or change the current TCP/IP address. Note: Manually setting the IP address sets the Enable DHCP and Enable Auto IP settings to Off. It also sets Enable BOOTP and Enable RARP to Off on systems that support BOOTP and RARP.
Netmask	View or change the current TCP/IP netmask.
Gateway	View or change the current TCP/IP gateway.
Enable DHCP On Off	Specify the DHCP address and parameter assignment. Note: On is the factory default setting.
Enable RARP On Off	Specify the RARP address assignment setting. Note: Off is the factory default setting.
Enable BOOTP On Off	Specify the BOOTP address assignment setting. Note: On is the factory default setting.
Enable AutoIP Yes No	Specify the Zero Configuration Networking setting. Note: Yes is the factory default setting.
Enable FTP/TFTP Yes No	Enable the built-in FTP server, which lets you send files to the printer using File Transfer Protocol. Note: Yes is the factory default setting.

Use	To
Enable HTTP Server Yes No	Enable the built-in Web server (Embedded Web Server). When enabled, the printer can be monitored and managed remotely using a Web browser. Note: Yes is the factory default setting.
WINS Server Address	View or change the current WINS server address.
Enable DDNS Yes No	View or change the current DDNS setting. Note: Yes is the factory default setting.
Enable mDNS Yes No	View or change the current mDNS setting. Note: Yes is the factory default setting.
DNS Server Address	View or change the current DNS server address.
Backup DNS Server Address	View or change the backup DNS server addresses.
Backup DNS Server Address 2	
Backup DNS Server Address 3	
Enable HTTPS Yes No	View or change the current HTTPS setting. Note: Yes is the factory default setting.

IPv6 menu

To access the menu, navigate to any of the following:

- **Network/Ports menu > Standard Network > Standard Network Setup > IPv6**
- **Network/Ports menu > Network [x] > Network [x] Setup > IPv6**

Note: This menu is available only in network printers or printers that are attached to print servers.

Use	To
Enable IPv6 On Off	Enable IPv6 in the printer. Note: On is the factory default setting.
Auto Configuration On Off	Specify whether or not the network adapter accepts the automatic IPv6 address configuration entries provided by a router. Note: On is the factory default setting.
Set Hostname	Set the host name.
View Address	Note: These settings can be changed only from the Embedded Web Server.
View Router Address	
Enable DHCPv6 On Off	Enable DHCPv6 in the printer. Note: On is the factory default setting.

Wireless menu

Note: This menu is available only in printers connected to a wireless network or printer models that have a wireless network adapter.

To access the menu, navigate to:

Network/Ports > Network [x] > Network [x] Setup > Wireless

Use	To
Wi-Fi Protected Setup Start Push Button Method Start PIN Method	Establish a wireless network and enable network security. Notes: <ul style="list-style-type: none"> Start Push Button Method connects the printer to a wireless network when buttons on both the printer and the access point (wireless router) are pressed within a given period of time. Start PIN Method connects the printer to a wireless network when a PIN on the printer is entered into the wireless settings of the access point.
Enable/Disable WPS Auto-detection Enable Disable	Automatically detect the connection method that an access point with WPS uses—Start Push Button Method or Start PIN Method. Note: Disable is the factory default setting.
Network Mode BSS Type Infrastructure Ad hoc	Specify the network mode. Notes: <ul style="list-style-type: none"> Infrastructure is the factory default setting. This lets the printer access a network using an access point. Ad hoc configures wireless connection directly between the printer and a computer.
Compatibility 802.11b/g 802.11b/g/n	Specify the wireless standard for the wireless network. Note: 802.11b/g/n is the factory default setting.
Choose Network	Select an available network for the printer to use.
View Signal Quality	View the quality of the wireless connection.
View Security Mode	View the encryption method for the wireless network.

AppleTalk menu

To access the menu, navigate to either of the following:

- **Network/Ports > Standard Network > Standard Network Setup > AppleTalk**
- **Network/Ports > Network [x] > Network [x] Setup > AppleTalk**

Use	To
Activate Yes No	Enable or disable AppleTalk support. Note: No is the factory default setting.

Use	To
View Name	Show the assigned AppleTalk name. Note: The AppleTalk name can be changed only from the Embedded Web Server.
View Address	Show the assigned AppleTalk address. Note: The AppleTalk address can be changed only from the Embedded Web Server.
Set Zone [list of zones available on the network]	Provide a list of AppleTalk zones available on the network. Note: The default zone for the network is the factory default setting.

Standard USB menu

Use	To
PCL SmartSwitch On Off	Set the printer to automatically switch to PCL emulation when a print job received through a USB port requires it, regardless of the default printer language. Notes: <ul style="list-style-type: none"> • On is the factory default setting. • When set to Off, the printer does not examine incoming data. The printer uses PostScript emulation if the PS SmartSwitch is set to On. It uses the default printer language specified in the Setup menu if the PS SmartSwitch is set to Off.
PS SmartSwitch On Off	Set the printer to automatically switch to PS emulation when a print job received through a USB port requires it, regardless of the default printer language. Notes: <ul style="list-style-type: none"> • On is the factory default setting. • When set to Off, the printer does not examine incoming data. The printer uses PCL emulation if the PCL SmartSwitch is set to On. It uses the default printer language specified in the Setup menu if the PCL SmartSwitch is set to Off.
NPA Mode On Off Auto	Set the printer to perform the special processing required for bidirectional communication following the conventions defined by the NPA protocol. Notes: <ul style="list-style-type: none"> • Auto is the factory default setting. Auto sets the printer to examine data, determine the format, and then process it appropriately. • The printer automatically restarts when changing the setting from the printer control panel. The menu selection is then updated.

Use	To
USB Buffer Disabled Auto 3K to [maximum size allowed]	Set the size of the USB input buffer. Notes: <ul style="list-style-type: none"> • Auto is the factory default setting. • Disabled turns off job buffering. • The USB buffer size value can be changed in 1-KB increments. • The maximum size allowed depends on the amount of memory in the printer, the size of the other link buffers, and whether Resource Save is set to On or Off. • To increase the maximum size range for USB Buffer, disable or reduce the size of the parallel, serial, and network buffers. • The printer automatically restarts when the setting is changed from the printer control panel. The menu selection is then updated.
Mac Binary PS On Off Auto	Set the printer to process Macintosh binary PostScript print jobs. Notes: <ul style="list-style-type: none"> • Auto is the factory default setting. • On processes raw binary PostScript print jobs. • Off filters print jobs using the standard protocol.
ENA Address yyy.yyy.yyy.yyy	Set the network address information for an external print server. Note: This menu is available only when the printer is attached to an external print server through the USB port.
ENA Netmask yyy.yyy.yyy.yyy	Set the netmask information for an external print server. Note: This menu is available only when the printer is attached to an external print server through the USB port.
ENA Gateway yyy.yyy.yyy.yyy	Set the gateway information for an external print server. Note: This menu is available only when the printer is attached to an external print server through the USB port.

SMTP Setup menu

Use	To
Primary SMTP Gateway	Specify SMTP server gateway and port information. Note: 25 is the default SMTP gateway port.
Primary SMTP Gateway Port	
Secondary SMTP Gateway	
Secondary SMTP Gateway Port	
SMTP Timeout 5–30	Specify the amount of time in seconds before the server stops trying to send an e-mail. Note: 30 seconds is the factory default setting.
Reply Address	Specify a reply address of up to 128 characters in the e-mail sent by the printer.

Use	To
Use SSL Disabled Negotiate Required	Set the printer to use SSL for increased security when connecting to the SMTP server. Notes: <ul style="list-style-type: none"> • Disabled is the factory default setting. • When the Negotiate setting is used, the SMTP server determines if SSL will be used.
SMTP Server Authentication No authentication required Login/Plain CRAM-MD5 Digest-MD5 NTLM Kerberos 5	Specify the type of user authentication required for scan to e-mail privileges. Note: “No authentication required” is the factory default setting.
Device-Initiated E-mail None Use Device SMTP Credentials	Specify what credentials will be used when communicating to the SMTP server. Notes: <ul style="list-style-type: none"> • None is the factory default setting for Device-Initiated E-mail. • Device Userid and Device Password are used to log in to the SMTP server when Use Device SMTP Credentials is selected.
Device Userid	
Device Password	

Security menu

Confidential Print menu

Use	To
Confidential Job Expiration Off 1 hour 4 hours 24 hours 1 week	Set a limit on how long the printer stores confidential print jobs in the printer memory. Notes: <ul style="list-style-type: none"> • If the Confidential Job Expiration setting is changed while confidential print jobs reside in the printer memory, then the expiration time for those print jobs does not change to the new default value. • If the printer is turned off, then all confidential jobs held in the printer memory are deleted.
Repeat Job Expiration Off 1 hour 4 hours 24 hours 1 week	Set a limit on how long the printer stores print jobs.
Note: Off is the factory default setting.	

Use	To
Verify Job Expiration Off 1 hour 4 hours 24 hours 1 week	Set a limit on how long the printer stores print jobs needing verification.
Reserve Job Expiration Off 1 hour 4 hours 24 hours 1 week	Set a limit on how long the printer stores print jobs for printing at a later time.
Note: Off is the factory default setting.	

Security Audit Log menu

Use	To
Export Log	Let an authorized user export the security audit log. Note: The log can be downloaded from the Embedded Web Server and saved on a computer.
Delete Log Yes No	Specify whether audit logs are deleted. Note: Yes is the factory default setting.
Configure Log Enable Audit Yes No Enable Remote Syslog No Yes Remote Syslog Facility 0–23 Severity of events to log 0–7	Specify how audit logs are configured. Notes: <ul style="list-style-type: none"> • Enable Audit determines if events are recorded in the secure audit log and remote syslog. No is the factory default setting. • Enable Remote Syslog determines if logs are sent to a remote server. No is the factory default setting. • Remote Syslog Facility determines the value used to send logs to the remote syslog server. 4 is the factory default setting. • If the security audit log is activated, then the severity value of each event is recorded. 4 is the factory default setting.

Set Date and Time menu

Use	To
Current Date and Time	View the current date and time settings for the printer.

Use	To
Manually Set Date and Time [input date/time]	Enter the date and time. Notes: <ul style="list-style-type: none"> Manually setting the date and time sets Enable NTP to No. The wizard lets you set the date and time in YYYY-MM-DD-HH:MM format.
Time Zone [list of time zones]	Select the time zone. Note: GMT is the factory default settings.
Automatically observe DST On Off	Set the printer to use the applicable daylight saving time (DST) start and end times associated with the printer Time Zone setting. Note: On is the factory default setting.
Enable NTP On Off	Enable Network Time Protocol, which synchronizes the clocks of devices on a network. Notes: <ul style="list-style-type: none"> On is the factory default setting. This setting is turned off if you manually set the date and time.

Settings menu

General Settings menu

Use	To
<p>Display Language</p> <ul style="list-style-type: none"> English Francais Deutsch Italiano Espanol Dansk Norsk Nederlands Svenska Portugues Suomi Russian Polski Greek Magyar Turkce Cesky Simplified Chinese Traditional Chinese Korean Japanese 	<p>Set the language of the text appearing on the display.</p> <p>Note: Not all languages are available for all models. You may need to install a special hardware for some languages.</p>
<p>Show Supply Estimates</p> <ul style="list-style-type: none"> Show estimates Do not show estimates 	<p>View the estimates of the supplies on the control panel, Embedded Web Server, menu settings, and device statistics reports.</p> <p>Note: Show estimates is the factory default setting.</p>
<p>Eco-Mode</p> <ul style="list-style-type: none"> Off Energy Energy/Paper Paper 	<p>Minimize the use of energy, paper, or specialty media.</p> <p>Notes:</p> <ul style="list-style-type: none"> • Off is the factory default setting. • When setting Eco-Mode to Energy or Paper, performance may be affected, but print quality is not.
<p>ADF Loaded Beep</p> <ul style="list-style-type: none"> Enabled Disabled 	<p>Specify whether the ADF sounds a beep when paper is loaded.</p> <p>Note: Enabled is the factory default setting.</p>
<p>Quiet Mode</p> <ul style="list-style-type: none"> Off On 	<p>Minimize the printer noise.</p> <p>Note: Off is the factory default setting.</p>

Use	To
<p>Run Initial Setup Yes No</p>	<p>Run the setup wizard.</p>
<p>Paper Sizes US Metric</p>	<p>Specify the unit of measurement for paper sizes.</p> <p>Notes:</p> <ul style="list-style-type: none"> • US is the factory default setting. • The initial setting is determined by your country or region selection in the initial setup wizard.
<p>Scan to PC Port Range [port range]</p>	<p>Specify a valid port range for printers behind a port blocking firewall.</p> <p>Note: 9751:12000 is the factory default setting.</p>
<p>Home screen customization Change Language Copy E-mail Shortcuts FTP Shortcuts Search Held Jobs Held Jobs Bookmarks Jobs by User</p>	<p>Change the icons that appear on the home screen.</p> <p>For each icon, select from the following options:</p> <ul style="list-style-type: none"> Display Do Not display
<p>One Page Copy Off On</p>	<p>Set copies from the scanner glass to only one page at a time.</p> <p>Note: Off is the factory default setting.</p>
<p>Allow Background Removal On Off</p>	<p>Specify whether image background removal is allowed.</p> <p>Note: On is the factory default setting.</p>
<p>Allow Custom Job Scans On Off</p>	<p>Scan multiple jobs to one file.</p> <p>Note: On is the factory default setting. If On is selected, then Allow Custom Job Scans can be enabled for specific jobs.</p>
<p>Scanner Jam Recovery Job Level Page Level</p>	<p>Specify how a scanned job should be reloaded if a paper jam occurs in the ADF.</p> <p>Note: Job level is the factory default setting.</p>
<p>Alarms Alarm Control Cartridge Alarm</p>	<p>Set an alarm when the printer requires user intervention.</p> <p>For each alarm type, select from the following options:</p> <ul style="list-style-type: none"> Off Single Continuous <p>Notes:</p> <ul style="list-style-type: none"> • Single is the factory default setting. This sounds three quick beeps. • Continuous repeats three beeps every 10 seconds.

Use	To
<p>Timeouts</p> <p>Sleep Mode</p> <p> Disabled</p> <p> 1–60</p>	<p>Set the amount of time in minutes the printer waits after a job is printed before it goes into a reduced power state.</p> <p>Notes:</p> <ul style="list-style-type: none"> • 20 is the factory default setting. • Lower settings conserve more energy, but may require longer warm-up times. • Select the lowest setting if the printer shares an electrical circuit with room lighting or you notice lights flickering in the room. • Select a high setting if the printer is in constant use. Under most circumstances, this keeps the printer ready to print with minimum warm-up time. • Disabled appears only if Energy Conserve is set to Off.
<p>Timeouts</p> <p>Print with Display Off</p> <p> Allow printing with display off</p> <p> Display on when printing</p>	<p>Print a job with the display turned off.</p> <p>Note: Display on when printing is the factory default setting.</p>
<p>Timeouts</p> <p>Hibernate Timeout</p> <p> Disabled</p> <p> 20 minutes</p> <p> 1–3 hours</p> <p> 6 hours</p> <p> 1–3 days</p> <p> 1–2 weeks</p> <p> 1 month</p>	<p>Set the amount of time the printer waits before it enters Hibernate mode.</p> <p>Note: 3 days is the factory default setting.</p>
<p>Hibernate Timeout on Connection</p> <p> Hibernate</p> <p> Do Not Hibernate</p>	<p>Set the printer to Hibernate mode even if there is an active Ethernet connection.</p> <p>Note: Do Not Hibernate is the factory default setting.</p>
<p>Timeouts</p> <p>Screen Timeout</p> <p> 15–300</p>	<p>Set the amount of time in seconds before returning the control panel to a Ready state.</p> <p>Note: 30 is the factory default setting.</p>
<p>Timeouts</p> <p>Print Timeout</p> <p> Disabled</p> <p> 1–255</p>	<p>Set the amount of time in seconds the printer waits to receive an end-of-job message before canceling the rest of the job.</p> <p>Notes:</p> <ul style="list-style-type: none"> • 90 is the factory default setting. • When the timer expires, any partially printed page still in the printer is printed, and then the printer checks to see if any new print jobs are waiting. • Print Timeout is available only when using PCL emulation.

Use	To
<p>Timeouts</p> <p>Wait Timeout</p> <p>Disabled</p> <p>15–65535</p>	<p>Set the amount of time in seconds the printer waits for additional data before canceling a print job.</p> <p>Notes:</p> <ul style="list-style-type: none"> • 40 is the factory default setting. • Wait Timeout is available only when the printer is using PostScript emulation.
<p>Error Recovery</p> <p>Auto Reboot</p> <p>Reboot when idle</p> <p>Reboot always</p> <p>Reboot never</p>	<p>Set the printer to restart when an error occurs.</p> <p>Note: Reboot always is the factory default setting.</p>
<p>Error Recovery</p> <p>Max Auto Reboots</p> <p>1–20</p>	<p>Determine the number of automatic reboots the printer can perform.</p> <p>Notes:</p> <ul style="list-style-type: none"> • 2 is the factory default setting. • If the printer reaches the maximum number of reboots within a certain amount of time, the printer does not continue to reboot, and the error message appears on the display.
<p>Print Recovery</p> <p>Auto Continue</p> <p>Disabled</p> <p>5–255</p>	<p>Let the printer automatically continue printing from certain offline situations when these are not resolved within the specified time period.</p> <p>Note: Disabled is the factory default setting.</p>
<p>Print Recovery</p> <p>Jam Recovery</p> <p>On</p> <p>Off</p> <p>Auto</p>	<p>Specify whether the printer reprints jammed pages.</p> <p>Notes:</p> <ul style="list-style-type: none"> • Auto is the factory default setting. The printer reprints jammed pages unless the memory required to hold the pages is needed for other printer tasks. • On sets the printer to always reprint jammed pages. • Off sets the printer to never reprint jammed pages.
<p>Print Recovery</p> <p>Page Protect</p> <p>Off</p> <p>On</p>	<p>Successfully print a page that may not have printed otherwise.</p> <p>Notes:</p> <ul style="list-style-type: none"> • Off is the factory default setting. This prints a partial page when there is not enough memory to print the whole page. • On sets the printer to print the entire page.
<p>Press Sleep Button</p> <p>Do Nothing</p> <p>Sleep</p> <p>Hibernate</p>	<p>Determine how the printer, while in idle state, reacts to a short press of the Sleep button.</p> <p>Note: Sleep is the factory default setting.</p>

Use	To
<p>Press and Hold Sleep Button</p> <ul style="list-style-type: none"> Do Nothing Sleep Hibernate 	<p>Determine how the printer, while in idle state, reacts to a long press of the Sleep button.</p> <p>Note: Do Nothing is the factory default setting.</p>
<p>Factory Defaults</p> <ul style="list-style-type: none"> Do Not Restore Restore Now 	<p>Use the printer factory default settings.</p> <p>Notes:</p> <ul style="list-style-type: none"> • Do Not Restore is the factory default setting. • Restore Now sets all printer settings to the factory default settings except for the Network/Ports menu settings. All downloads stored in the RAM are deleted. Downloads stored in the flash memory or on a hard disk are not affected.
<p>Custom Home Message</p> <ul style="list-style-type: none"> Off IP Address Hostname Contact Name Location Zero Configuration Name Custom Text [x] 	<p>Select a custom home message that appears as an alternating display of the printer status.</p>

Copy Settings menu

Use	To
<p>Content Type</p> <ul style="list-style-type: none"> Text Graphics Text/Photo Photo 	<p>Specify the content of the original document.</p> <p>Note: Text/Photo is the factory default setting.</p>
<p>Content Source</p> <ul style="list-style-type: none"> Black/White Laser Color Laser Inkjet Photo/Film Magazine Newspaper Press Other 	<p>Specify how the original document is produced.</p> <p>Note: Color Laser is the factory default setting.</p>
<p>Color</p> <ul style="list-style-type: none"> On Off 	<p>Specify whether copies are printed in color.</p> <p>Note: On is the factory default setting.</p>

Use	To
<p>Allow color copies</p> <p>On Off</p>	<p>Enable color in copies.</p> <p>Notes:</p> <ul style="list-style-type: none"> • On is the factory default setting. • Setting this to Off will hide all color-specific menus. • This setting overrides the Color setting.
<p>Sides (Duplex)</p> <p>1 sided to 1 sided 1 sided to 2 sided 2 sided to 1 sided 2 sided to 2 sided</p>	<p>Specify whether an original document is two-sided (duplex) or one-sided, and then specify whether the copy should be two-sided or one-sided.</p> <p>Notes:</p> <ul style="list-style-type: none"> • 1 sided to 1 sided—The original document has print on one side, and the copy will also have print on one side. • 1 sided to 2 sided—The original document has print on one side, while the copy will have print on both sides. • 2 sided to 1 sided—The original document has print on both sides, while the copy will have print on just one side. • 2 sided to 2 sided—The original document has print on both sides, and the copy will also have print on both sides.
<p>Paper Saver</p> <p>Off 2-up Portrait 4-up Portrait 2-up Landscape 4-up Landscape</p>	<p>Allow copying of two or four sheets of a document on one page.</p> <p>Note: Off is the factory default setting.</p>
<p>Print Page Borders</p> <p>On Off</p>	<p>Allow page borders in printed copies.</p> <p>Note: Off is the factory default setting.</p>
<p>Collate</p> <p>(1,1) (2,2) (1,2,3) (1,2,3)</p>	<p>Keep the pages of a print job stacked in sequence when printing multiple copies.</p> <p>Note: “(1,2,3) (1,2,3)” is the factory default setting.</p>

Use	To
<p>Original Size</p> <ul style="list-style-type: none"> Letter Legal Executive Folio Statement Oficio (Mexico) Universal Mixed Sizes A4 A5 A6 JIS B5 Custom Scan Size [x] Book Original Business Card 3 x 5 in. 4 x 6 in. ID Card 	<p>Specify the paper size of the original document.</p> <p>Notes:</p> <ul style="list-style-type: none"> • Letter is the U.S. factory default setting. A4 is the international factory default setting. • Legal, Folio, and Oficio (Mexico) paper sizes are supported only in the ADF.
<p>Copy To Source</p> <ul style="list-style-type: none"> Tray [x] MP Feeder Manual Feeder 	<p>Specify the paper source for copy jobs.</p> <p>Note: Tray 1 is the factory default setting.</p>
<p>Transparency Separators</p> <ul style="list-style-type: none"> On Off 	<p>Place a sheet of paper between transparencies.</p> <p>Note: On is the factory default setting.</p>
<p>Separator Sheets</p> <ul style="list-style-type: none"> Off Between Copies Between Jobs Between Pages 	<p>Place a sheet of paper between pages, copies, or jobs.</p> <p>Note: Off is the factory default setting.</p>
<p>Separator Sheet Source</p> <ul style="list-style-type: none"> Tray [x] MP Feeder 	<p>Specify the paper source for the separator sheet.</p> <p>Note: Tray 1 is the factory default setting.</p>
<p>Darkness</p> <ul style="list-style-type: none"> 1–9 	<p>Specify the level of darkness for the copy job.</p> <p>Note: 5 is the factory default setting.</p>
<p>Number of Copies</p> <ul style="list-style-type: none"> 1–999 	<p>Specify the number of copies for the copy job.</p> <p>Note: 1 is the factory default setting.</p>

Use	To
Overlay Confidential Copy Draft Urgent Custom Off	Specify the overlay text printed on each page of the copy job. Note: Off is the factory default setting.
Allow priority copies On Off	Allow interruption of a print job to copy a page or document. Note: On is the factory default setting.
Background Removal -4 to 4	Adjust the amount of background visible on a copy. Note: 0 is the factory default setting.
Auto Center Off On	Automatically center the content on the page. Note: Off is the factory default setting.
Color Dropout Color Dropout None Red Green Blue Default Red Threshold 0–255 Default Green Threshold 0–255 Default Blue Threshold 0–255	Specify which color to drop during scanning and to adjust the dropout setting for each color threshold. Notes: <ul style="list-style-type: none"> • None is the factory default setting for Color Dropout. • 128 is the factory default setting for each color threshold.
Contrast 0–5 Best for content	Specify the contrast used for the copy job. Note: “Best for content” is the factory default setting.
Mirror Image Off On	Create a mirror image of the original document. Note: Off is the factory default setting.
Negative Image Off On	Create a negative image of the original document. Note: Off is the factory default setting.
Shadow Detail -4 to 4	Adjust the amount of shadow detail visible on a copy. Note: 0 is the factory default setting.
Scan edge to edge Off On	Allow edge-to-edge scanning of the original document. Note: Off is the factory default setting.

Use	To
Sharpness 1–5	Adjust the amount of sharpness of a copy. Note: 3 is the factory default setting.
Temperature -4 to 4	Enable the user to specify “warm” or “cool” outputs. Note: “Cool” values generate a bluer output than the default, while “warm” values generate a redder output than the default.

E-mail Settings menu

Use	To
E-mail Server Setup Send me a copy Never appears On by default Off by default Always On	Send a copy of the e-mail to the sender. Note: Never appears is the factory default setting.
E-mail Server Setup Max E-mail size 0–65535 KB	Specify the maximum e-mail size. Note: E-mails greater than the specified maximum size are not sent.
Format PDF (.pdf) TIFF (.tif) JPEG (.jpg) XPS (.xps)	Specify the file format. Note: PDF (.pdf) is the factory default setting.
PDF Settings PDF Version 1.2–1.7 A–1a Secure PDF Off On	Configure the PDF settings. Notes: <ul style="list-style-type: none"> • 1.5 is the factory default setting for PDF Version. • Off is the factory default setting for Secure PDF. Secure PDF requires you to enter your password twice.
Content Type Text Graphics Text/Photo Photo	Specify the content of the original document. Note: Text/Photo is the factory default setting.

Use	To
Content Source Black/White Laser Color Laser Inkjet Photo/Film Magazine Newspaper Press Other	Specify how the original document was produced. Note: Color Laser is the factory default setting.
Color Off On	Specify whether the printer captures and transmits content in color. Note: On is the factory default setting.
Resolution 75 dpi 150 dpi 200 dpi 300 dpi 400 dpi 600 dpi	Specify the resolution of the scan in dots per inch. Note: 150 dpi is the factory default setting.
Darkness 1–9	Lighten or darken the output. Note: 5 is the factory default setting.
Orientation Portrait Landscape	Specify the orientation of the scanned image. Note: Portrait is the factory default setting.
Original Size Letter Legal Executive Folio Statement Oficio (Mexico) Universal Mixed Sizes A4 A5 A6 JIS B5 Custom Scan Size [x] Book Original Business Card 3 x 5 in. 4 x 6 in.	Specify the size of the original document. Notes: <ul style="list-style-type: none"> • Letter is the U.S. factory default setting. A4 is the international factory default setting. • Legal, Folio, and Oficio (Mexico) paper sizes are supported only in the ADF.

Use	To
Sides (Duplex) Off Long edge Short edge	Specify the orientation of the original documents loaded in the ADF for two-sided scanning. Note: Off is the factory default setting.
JPEG Quality Best for content 5–90	Set the quality of a JPEG photo image in relation to file size and quality of the image. Notes: <ul style="list-style-type: none"> • Best for content is the factory default setting. • 5 reduces the file size and quality of the image. • 90 provides the best image quality, but the file size is very large.
Text Default 5–90	Set the quality of a text image in relation to file size and quality of the image. Note: 75 is the factory default setting.
Text/Photo Default 5–90	Set the quality of a text or photo image in relation to file size and the quality of the image. Note: 75 is the factory default setting.
Photo Default 5–90	Set the quality of a photo image in relation to file size and the quality of the image. Note: 50 is the factory default setting.
E-mail images sent as Attachment Web Link	Specify how the images are sent. Note: Attachment is the factory default setting.
Use Multi-Page TIFF On Off	Provide a choice between single-page TIFF files and multiple-page TIFF files. For a multiple-page scan-to-e-mail job, either one TIFF file is created containing all the pages, or multiple TIFF files are created with one file for each page of the job. Note: On is the factory default setting.
Transmission Log Print log Do not print log Print only for error	Specify whether to print the transmission log. Note: Print log is the factory default setting.
Log Paper Source Tray [x] MP Feeder	Specify the paper source for printing e-mail logs. Note: Tray 1 is the factory default setting.
E-mail Bit Depth 1 bit 8 bit	Enable the Text/Photo mode to produce smaller file sizes by using 1-bit images when Color is set to Off. Note: 8 bit is the factory default setting.
Allow Save as Shortcut On Off	Save e-mail addresses as shortcuts. Notes: <ul style="list-style-type: none"> • On is the factory default setting. • When set to Off, the “Save as Shortcut” button does not appear on the e-mail destination screen.

Use	To
Background Removal -4 to 4	Adjust the amount of background visible on a scanned image. Note: 0 is the factory default setting.
Color Dropout Color Dropout None Red Green Blue Default Red Threshold 0–255 Default Green Threshold 0–255 Default Blue Threshold 0–255	Specify which color to drop and to adjust the dropout setting for each color threshold. Notes: <ul style="list-style-type: none"> • None is the factory default setting for Color Dropout. • 128 is the factory default setting for each color threshold.
Contrast 0–5 Best for content	Specify the contrast of the output. Note: Best for content is the factory default setting.
Mirror Image Off On	Create a mirror image of the original document. Note: Off is the factory default setting.
Negative Image Off On	Create a negative image of the original document. Note: Off is the factory default setting.
Shadow Detail -4 to 4	Adjust the amount of shadow detail visible on a scanned image. Note: 0 is the factory default setting.
Scan edge to edge Off On	Specify whether the original document is scanned edge-to-edge. Note: Off is the factory default setting.
Sharpness 1–5	Adjust the amount of sharpness on a scanned image. Note: 3 is the factory default setting.
Temperature -4 to 4	Specify warm or cool outputs. Cool values generate a bluer output than the default while warm values generate a redder output than the default. Note: 0 is the factory default setting.

FTP Settings menu

Use	To
Format PDF (.pdf) TIFF (.tif) JPEG (.jpg) XPS (.xps)	Specify the file format. Note: PDF (.pdf) is the factory default setting.
PDF Settings PDF Version 1.2–1.7 A–1a Secure PDF Off On	Configure the PDF settings. Notes: <ul style="list-style-type: none"> • 1.5 is the factory default setting for PDF Version. • Off is the factory default setting for Secure PDF. Secure PDF requires you to enter your password twice.
Content Type Text Graphics Text/Photo Photo	Specify the content of the original document. Note: Text/Photo is the factory default setting.
Content Source Black/White Laser Color Laser Inkjet Photo/Film Magazine Newspaper Press Other	Specify how the original document was produced. Note: Color Laser is the factory default setting.
Color Off On	Specify whether the printer captures and transmits content in color. Note: On is the factory default setting.
Resolution 75 dpi 150 dpi 200 dpi 300 dpi 400 dpi 600 dpi	Specify the quality of the scan in dots per inch (dpi). Note: 150 dpi is the factory default setting.
Darkness 1–9	Lighten or darken the output. Note: 5 is the factory default setting.
Orientation Portrait Landscape	Specify the orientation of the scanned image. Note: Portrait is the factory default setting.

Use	To
<p>Original Size</p> <ul style="list-style-type: none"> Letter Legal Executive Folio Statement Oficio (Mexico) Universal Mixed Sizes A4 A5 A6 JIS B5 Custom Scan Size [x] Book Original Business Card 3 x 5 in. 4 x 6 in. 	<p>Specify the size of the original document.</p> <p>Notes:</p> <ul style="list-style-type: none"> • Letter is the U.S. factory default setting. A4 is the international factory default setting. • Legal, Folio, and Oficio (Mexico) paper sizes are supported only in the ADF.
<p>Sides (Duplex)</p> <ul style="list-style-type: none"> Off Long edge Short edge 	<p>Specify the orientation of the original documents loaded in the ADF for two-sided scanning.</p> <p>Note: Off is the factory default setting.</p>
<p>JPEG Quality</p> <ul style="list-style-type: none"> Best for content 5–90 	<p>Set the quality of a JPEG photo image in relation to file size and quality of the image.</p> <p>Notes:</p> <ul style="list-style-type: none"> • Best for content is the factory default setting. • 5 reduces the image quality and the file size. • 90 produces the best image quality, but the file size is very large.
<p>Text Default</p> <ul style="list-style-type: none"> 5–90 	<p>Set the quality of the text in relation to the size and quality of the image.</p> <p>Note: 75 is the factory default setting.</p>
<p>Text/Photo Default</p> <ul style="list-style-type: none"> 5–90 	<p>Set the quality of a text or photo image in relation to the size and quality of the image.</p> <p>Note: 75 is the factory default setting.</p>
<p>Photo Default</p> <ul style="list-style-type: none"> 5–90 	<p>Set the quality of a photo image in relation to the size and quality of the image.</p> <p>Note: 50 is the factory default setting.</p>
<p>Use Multi-Page TIFF</p> <ul style="list-style-type: none"> On Off 	<p>Provide a choice between single-page TIFF files and multiple-page TIFF files. For a multiple-page scan-to-FTP job, either one TIFF file is created containing all the pages, or multiple TIFF files are created with one file for each page of the job.</p> <p>Note: On is the factory default setting.</p>

Use	To
Transmission Log Print log Do not print log Print only for error	Specify whether to print the transmission log. Note: Print log is the factory default setting.
Log Paper Source Tray [x] Manual Feeder	Specify a paper source when printing FTP logs. Note: Tray 1 is the factory default setting.
FTP bit Depth 8 bit 1 bit	Enable the Text/Photo mode to have smaller file sizes by using 1-bit images when Color is set to Off. Note: 8 bit is the factory default setting.
Allow Save as Shortcut On Off	Enable shortcut creation for FTP addresses. Note: On is the factory default setting.
Background Removal -4 to 4	Adjust the amount of background visible on a copy. Note: 0 is the factory default setting.
Color Dropout Color Dropout None Red Green Blue Default Red Threshold 0–255 Default Green Threshold 0–255 Default Blue Threshold 0–255	Specify which color to drop and to adjust the dropout setting for each color threshold. Notes: <ul style="list-style-type: none"> • None is the factory default setting for Color Dropout. • 128 is the factory default setting for each color threshold.
Contrast 0–5 Best for content	Specify the contrast of the output. Note: Best for content is the factory default setting.
Mirror Image Off On	Create a mirror image of the original document. Note: Off is the factory default setting.
Negative Image Off On	Create a negative image of the original document. Note: Off is the factory default setting.
Shadow Detail -4 to 4	Adjust the amount of shadow detail visible on a scanned image. Note: 0 is the factory default setting.
Scan edge to edge Off On	Specify whether the original document is scanned edge-to-edge. Note: Off is the factory default setting.

Use	To
Sharpness 1–5	Specify the amount of sharpness of the scanned image. Note: 3 is the factory default setting.

Print Settings

Setup menu

Use	To
Printer Language PCL Emulation PS Emulation	Set the default printer language. Notes: <ul style="list-style-type: none"> • PS Emulation is the factory default setting. PS Emulation uses a PS interpreter for processing print jobs. • PCL Emulation uses a PCL interpreter for processing print jobs. • Setting a printer language as the default does not prevent a software program from sending print jobs that use another printer language.
Print Area Normal Fit To Page Whole Page	Set the logical and physical printable area. Notes: <ul style="list-style-type: none"> • Normal is the factory default setting. When attempting to print data in the non-printable area defined by the Normal setting, the printer clips the image. • Fit To Page fits the page content into the selected paper size. • Whole Page allows the image to be moved into the non-printable area defined by the Normal setting, but the printer clips the image at the Normal setting boundary. This setting affects only pages printed using a PCL 5e interpreter and has no effect on pages printed using the PCL XL or PostScript interpreter.
Printer Usage Max Yield Max Speed	Set color toner use in printing. Note: Max Yield is the factory default setting.
Black Only Mode On Off	Set the printer to print text and graphics using only the black toner cartridge. Note: Off is the factory default setting.

Use	To
<p>Resource Save</p> <p>On</p> <p>Off</p>	<p>Specify how the printer handles temporary downloads, such as fonts and macros stored in the RAM, when the printer receives a job that requires more than the available memory.</p> <p>Notes:</p> <ul style="list-style-type: none"> • Off is the factory default setting. Off sets the printer to retain the downloads only until memory is needed. Downloads are deleted in order to process print jobs. • On sets the printer to retain downloads during language changes and printer resets. If the printer runs out of memory, then Memory full [38] appears, but downloads are not deleted.

Finishing menu

Use	To
<p>Sides (Duplex)</p> <p>1 sided</p> <p>2 sided</p>	<p>Specify whether two-sided (duplex) printing is set as the default for all print jobs.</p> <p>Notes:</p> <ul style="list-style-type: none"> • “1 sided” is the factory default setting. • You can set two-sided printing from the printer software. For Windows users: Click File > Print, and then click Properties, Preferences, Options, or Setup. For Macintosh users: Choose File > Print, and then adjust the settings from the Print dialog and pop-up menus.
<p>Duplex Binding</p> <p>Long Edge</p> <p>Short Edge</p>	<p>Define binding for duplexed pages in relation to page orientation.</p> <p>Notes:</p> <ul style="list-style-type: none"> • Long Edge is the factory default setting. This assumes binding along the long edge of the page (left edge for portrait and top edge for landscape). • Short Edge assumes binding along the short edge of the page (top edge for portrait and left edge for landscape).
<p>Copies</p> <p>1–999</p>	<p>Specify the default number of copies for each print job.</p> <p>Note: 1 is the factory default setting.</p>
<p>Blank Pages</p> <p>Do Not Print</p> <p>Print</p>	<p>Specify whether blank pages are inserted in a print job.</p> <p>Note: Do Not Print is the factory default setting.</p>
<p>Collate</p> <p>(1,1) (2,2)</p> <p>(1,2,3) (1,2,3)</p>	<p>Stack the pages of a print job in sequence when printing multiple copies.</p> <p>Note: “(1,2,3) (1,2,3)” is the factory default setting.</p>

Use	To
Separator Sheets Off Between Copies Between Jobs Between Pages	Specify whether blank separator sheets are inserted. Notes: <ul style="list-style-type: none"> • Off is the factory default setting. • Between Copies inserts a blank sheet between each copy of a print job if Collate is set to "(1,2,3) (1,2,3)." If Collate is set to "(1,1,1) (2,2,2)," then a blank page is inserted between each set of printed pages, such as after all page 1's and after all page 2's. • Between Jobs inserts a blank sheet between print jobs. • Between Pages inserts a blank sheet between each page of a print job. This setting is useful when printing transparencies or when inserting blank pages in a document.
Separator Source Tray [x] Multipurpose Feeder	Specify the paper source for the separator sheet. Note: Tray 1 (standard tray) is the factory default setting.
Paper Saver Off 2-Up 3-Up 4-Up 6-Up 9-Up 12-Up 16-Up	Print multiple pages on a single sheet of paper. Notes: <ul style="list-style-type: none"> • Off is the factory default setting. • When the number of pages per sheet is selected, each page is scaled so that the number of pages you want can be displayed on the sheet.
Paper Saver Ordering Horizontal Reverse Horizontal Reverse Vertical Vertical	Specify the order in which pages are printed on a single sheet when using Paper Saver. Notes: <ul style="list-style-type: none"> • Horizontal is the factory default setting. • Positioning depends on the number of page images and whether they are in portrait or in landscape orientation.
Paper Saver Orientation Auto Landscape Portrait	Specify the orientation in which pages are printed on a single sheet. Note: Auto is the factory default setting. The printer chooses between portrait and landscape.
Paper Saver Border None Solid	Print a border when using Paper Saver. Note: None is the factory default setting.

Quality menu

Use	To
Print Mode Color Black Only	Specify whether images are printed in black and white or in color. Notes: <ul style="list-style-type: none"> • Color is the factory default setting. • The printer driver is capable of overriding this setting.
Color Correction Auto Off Manual	Adjust the color output on the printed page. Notes: <ul style="list-style-type: none"> • Auto is the factory default setting. This applies different color conversion tables to each object on the printed page. • Off turns off color correction. • Manual allows customization of the color tables using the settings available from the Manual Color menu. • Due to the differences in additive and subtractive colors, certain colors that appear on computer monitors are impossible to duplicate on the printed page.
Print Resolution 1200 dpi 4800 CQ	Specify the printed output resolution in dots per inch or in color quality (CQ). Note: 4800 CQ is the factory default setting.
Toner Darkness 1–5	Lighten or darken the printed output. Notes: <ul style="list-style-type: none"> • 4 is the factory default setting. • Selecting a smaller number can help conserve toner.
Enhance Fine Lines On Off	Enable a print mode preferable for files such as architectural drawings, maps, electrical circuit diagrams, and flow charts. Notes: <ul style="list-style-type: none"> • Off is the factory default setting. • To set this option using the Embedded Web Server, type the network printer IP address in the Web browser address field. • You can set this option from the software program. For Windows users: Click File > Print, and then click Properties, Preferences, Options, or Setup. For Macintosh users: Choose File > Print, and then adjust the settings from the Print dialog and pop-up menus.
Color Saver On Off	Reduce the amount of toner used for graphics and images. The amount of toner used for text is not reduced. Notes: <ul style="list-style-type: none"> • Off is the factory default setting. • On overrides Toner Darkness settings.

Use	To
<p>RGB Brightness -6 to 6</p>	<p>Adjust the printed output either by lightening or darkening it. You can conserve toner by lightening the output. Note: 0 is the factory default setting.</p>
<p>RGB Contrast 0–5</p>	<p>Adjust the contrast of printed objects. Note: 0 is the factory default setting.</p>
<p>RGB Saturation 0–5</p>	<p>Adjust saturation in color outputs. Note: 0 is the factory default setting.</p>
<p>Color Balance Cyan -5 to 5 Magenta -5 to 5 Yellow -5 to 5 Black -5 to 5 Reset Defaults</p>	<p>Adjust color in printed output by increasing or decreasing the amount of toner being used for each color. Note: 0 is the factory default setting.</p>
<p>Color Samples sRGB Display sRGB Vivid Display—True Black Vivid Off—RGB US CMYK Euro CMYK Vivid CMYK Off—CMYK</p>	<p>Print sample pages for each of the RGB and CMYK color conversion tables used in the printer. Notes:</p> <ul style="list-style-type: none"> • Selecting any setting prints the sample. • Color samples consist of a series of colored boxes along with the RGB or CMYK combination that creates the color observed. These pages can be used to help decide which combinations to use to get the printed output you want. • To access a complete list of color sample pages using the Embedded Web Server, type the network printer IP address in the Web browser address field.

Use	To
<p>Manual Color</p> <ul style="list-style-type: none"> RGB Image RGB Text RGB Graphics 	<p>Customize the RGB color conversions.</p> <p>Select from the following options:</p> <ul style="list-style-type: none"> Vivid sRGB Display Display—True Black sRGB Vivid Off <p>Notes:</p> <ul style="list-style-type: none"> • sRGB Display is the factory default setting for RGB Image. This applies a color conversion table to an output that matches the colors displayed on a computer monitor. • sRGB Vivid is the factory default setting for RGB Text and RGB Graphics. This applies a color table that increases saturation. This is preferred for business graphics and text. • Vivid applies a color conversion table that produces brighter, more saturated colors. • “Display—True Black” applies a color conversion table that uses only black toner for neutral gray colors. • Off turns off color conversion.
<p>Manual Color (continued)</p> <ul style="list-style-type: none"> CMYK Image CMYK Text CMYK Graphics 	<p>Customize the CMYK color conversions.</p> <p>Select from the following options:</p> <ul style="list-style-type: none"> US CMYK Euro CMYK Vivid CMYK Off <p>Notes:</p> <ul style="list-style-type: none"> • US CMYK is the factory default setting. This applies a color conversion table that tries to produce output that matches SWOP color output. • Euro CMYK is the international factory default setting. This applies a color conversion table that tries to produce output that matches Euroscale color output. • Vivid CMYK increases color saturation for the US conversion table. • Off turns off color conversion.
<p>Spot Color Replacement</p>	<p>Assign specific CMYK values to named spot colors.</p> <p>Note: This menu is available only in the Embedded Web Server.</p>
<p>Color Adjust</p>	<p>Initiate a recalibration of color conversion tables and allow the printer to make adjustments for color variations in output.</p> <p>Notes:</p> <ul style="list-style-type: none"> • Adjusting color starts when the menu is selected. Adjusting color appears on the display until the process is finished. • Color variations in output sometimes result from changeable conditions such as room temperature and humidity. Color adjustments are made on printer algorithms. Color alignment is also recalibrated in this process.

Utilities menu

Use	To
Activate Hex Trace	Assist in isolating the source of a print job problem. Notes: <ul style="list-style-type: none"> • When activated, all data sent to the printer is printed in hexadecimal and character representation, and control codes are not executed. • To exit or deactivate Hex Trace, turn off or reset the printer.
Coverage Estimator Off On	Provide an estimate of the percentage coverage of toner on a page. The estimate is printed on a separate page at the end of each print job. Note: Off is the factory default setting.

XPS menu

Use	To
Print Error Pages Off On	Print a page containing information on errors, including XML markup errors. Note: Off is the factory default setting.

PDF menu

Use	To
Scale to Fit Yes No	Scale page content to fit the selected paper size. Note: No is the factory default setting.
Annotations Do Not Print Print	Print annotations in a PDF. Note: Do Not Print is the factory default setting.

PostScript menu

Use	To
Print PS Error On Off	Print a page containing the PostScript error. Note: Off is the factory default setting.
Lock PS Startup Mode On Off	Allow users to disable the SysStart file. Note: Off is the factory default setting.

Use	To
Image Smoothing On Off	Enhance the contrast and sharpness of low-resolution images and smoothen their color transitions. Notes: <ul style="list-style-type: none"> • Off is the factory default setting. • Image Smoothing has no effect on images that are 300 dpi or higher in resolution.

PCL Emul menu

Use	To
Font Source Resident Download All	Specify the set of fonts used in the Font Name menu. Notes: <ul style="list-style-type: none"> • “Resident” is the factory default setting. It shows the factory default set of fonts downloaded in the RAM. • “Download” shows all the fonts downloaded in the RAM. • “All” shows all fonts available to any option.
Font Name Courier 10	Identify a specific font and where it is stored. Note: Courier 10 is the factory default setting.
Symbol Set 10U PC-8 12U PC-850	Specify the symbol set for each font name. Notes: <ul style="list-style-type: none"> • 10U PC-8 is the U.S. factory default setting. 12U PC-850 is the international factory default setting. • A symbol set is a set of alphabetical and numeric characters, punctuation, and special symbols. Symbol sets support the different languages or specific programs, such as math symbols for scientific text. Only the supported symbol sets are shown.
PCL Emulation Settings Point Size 1.00–1008.00	Change the point size for scalable typographic fonts. Notes: <ul style="list-style-type: none"> • 12 is the factory default setting. • Point size refers to the height of the characters in the font. One point equals approximately 0.014 of an inch. This can be increased or decreased in 0.25-point increments.
PCL Emulation Settings Pitch 0.08–100.00	Specify the font pitch for scalable monospaced fonts. Notes: <ul style="list-style-type: none"> • 10 is the factory default setting. • Pitch refers to the number of fixed-space characters per inch (cpi). This can be increased or decreased in 0.01-cpi increments. • For non-scalable monospaced fonts, the pitch appears on the display but cannot be changed.

Use	To
<p>PCL Emulation Settings</p> <p>Orientation</p> <p>Portrait</p> <p>Landscape</p>	<p>Specify the orientation of text and graphics on a page.</p> <p>Notes:</p> <ul style="list-style-type: none"> • Portrait is the factory default setting. It prints text and graphics parallel to the short edge of the page. • Landscape prints text and graphics parallel to the long edge of the page.
<p>PCL Emulation Settings</p> <p>Lines per Page</p> <p>1–255</p>	<p>Specify the number of lines that print on each page.</p> <p>Notes:</p> <ul style="list-style-type: none"> • 60 is the U.S. factory default setting. 64 is the international default setting. • The printer sets the amount of space between each line based on the Lines per Page, Paper Size, and Orientation settings. Select the paper size and orientation before setting Lines per Page.
<p>PCL Emulation Settings</p> <p>A4 Width</p> <p>198 mm</p> <p>203 mm</p>	<p>Set the printer to print on A4-size paper.</p> <p>Notes:</p> <ul style="list-style-type: none"> • 198 mm is the factory default setting. • The 203-mm setting sets the width of the page to allow the printing of eighty 10-pitch characters.
<p>PCL Emulation Settings</p> <p>Auto CR after LF</p> <p>On</p> <p>Off</p>	<p>Specify whether the printer automatically performs a carriage return (CR) after a line feed (LF) control command.</p> <p>Note: Off is the factory default setting.</p>
<p>PCL Emulation Settings</p> <p>Auto LF after CR</p> <p>On</p> <p>Off</p>	<p>Specify whether the printer automatically performs a line feed (LF) after a carriage return (CR) control command.</p> <p>Note: Off is the factory default setting.</p>

Use	To
<p>Tray Renumber</p> <p>Assign Multipurpose Feeder</p> <ul style="list-style-type: none"> Off None 0–199 <p>Assign Tray [x]</p> <ul style="list-style-type: none"> Off None 0–199 <p>Assign Manual Paper</p> <ul style="list-style-type: none"> Off None 0–199 <p>Assign Manual Envelope</p> <ul style="list-style-type: none"> Off None 0–199 	<p>Configure the printer to work with printer software or programs that use different source assignments for trays and feeders.</p> <p>Notes:</p> <ul style="list-style-type: none"> • “Off” is the factory default setting. • “None” ignores the Select Paper Feed command. This option appears only when it is selected by the PCL 5e interpreter. • “0–199” allows a custom setting to be assigned.
<p>Tray Renumber</p> <p>View Factory Defaults</p> <ul style="list-style-type: none"> MPF Default = 8 T1 Default = 1 T2 Default = 4 T3 Default = 5 T4 Default = 20 T5 Default = 21 Env Default = 6 MPaper Default = 2 MEnv Default = 3 	<p>Show the factory default setting assigned to each tray or feeder.</p>
<p>Tray Renumber</p> <p>Restore Defaults</p> <ul style="list-style-type: none"> Yes No 	<p>Restore all tray and feeder assignments to the factory default settings.</p>

HTML menu

Use		To
Font Name Albertus MT Antique Olive Apple Chancery Arial MT Avant Garde Bodoni Bookman Chicago Clarendon Cooper Black Copperplate Coronet Courier Eurostile Garamond Geneva Gill Sans Goudy Helvetica Hoefler Text Intl CG Times Intl Courier Intl Univers	Joanna MT Letter Gothic Lubalin Graph Marigold MonaLisa Recut Monaco New CenturySbk New York Optima Oxford Palatino StempelGaramond Taffy Times TimesNewRoman Univers Zapf Chancery NewSansMTCS NewSansMTCT New SansMTJA NewSansMTKO	Set the default font for HTML documents. Note: The Times font is used in HTML documents that do not specify a font.

Use	To
Font Size 1–255 pt	Set the default font size for HTML documents. Notes: <ul style="list-style-type: none"> • 12 pt is the factory default setting. • Font size can be increased in 1-point increments.
Scale 1–400%	Scale the default font for HTML documents. Notes: <ul style="list-style-type: none"> • 100% is the factory default setting. • Scaling can be increased in 1% increments.
Orientation Portrait Landscape	Set the page orientation for HTML documents. Note: Portrait is the factory default setting.
Margin Size 8–255 mm	Set the page margin for HTML documents. Notes: <ul style="list-style-type: none"> • 19 mm is the factory default setting. • Margin size can be increased in 1-mm increments.

Use	To
Backgrounds Do Not Print Print	Specify whether to print backgrounds on HTML documents. Note: Print is the factory default setting.

Image menu

Use	To
Auto Fit On Off	Select the optimal paper size, scaling, and orientation. Note: On is the factory default setting. It overrides scaling and orientation settings for some images.
Invert On Off	Invert bitonal monochrome images. Notes: <ul style="list-style-type: none"> • Off is the factory default setting. • This setting does not apply to GIF or JPEG images.
Scaling Anchor Top Left Best Fit Anchor Center Fit Height/Width Fit Height Fit Width	Scale the image to fit the selected paper size. Notes: <ul style="list-style-type: none"> • Best Fit is the factory default setting. • When Auto Fit is set to On, Scaling is automatically set to Best Fit.
Orientation Portrait Landscape Reverse Portrait Reverse Landscape	Set the image orientation. Note: Portrait is the factory default setting.

Help menu

Menu item	Description
Print All Guides	Prints all the guides
Copy Guide	Provides information about making copies and changing settings
E-mail Guide	Provides information about sending e-mails and configuring the settings
FTP Guide	Provides information about scanning documents and configuring the settings
Color Quality	Provides information about solving color quality issues
Print Defects Guide	Provides help in resolving repeating defects in copies or prints
Information Guide	Provides help in locating additional information
Supplies Guide	Provides information about ordering supplies

Saving money and the environment

Lexmark is committed to environmental sustainability and is continually improving its printers to reduce their impact on the environment. We design with the environment in mind, engineer our packaging to reduce materials, and provide collection and recycling programs. For more information, see:

- The Notices chapter
- The Environmental Sustainability section of the Lexmark Web site at www.lexmark.com/environment
- The Lexmark recycling program at www.lexmark.com/recycle

By selecting certain printer settings or tasks, you may be able to reduce your printer's impact even further. This chapter outlines the settings and tasks that may yield a greater environmental benefit.

Saving paper and toner

Studies show that as much as 80% of the carbon footprint of a printer is related to paper usage. You can significantly reduce your carbon footprint by using recycled paper and the following printing suggestions, such as printing on both sides of the paper and printing multiple pages on one side of a single sheet of paper.

For information on how you can quickly save paper and energy using one printer setting, see [“Using Eco-Mode” on page 122](#).

Using recycled paper

As an environmentally conscious company, Lexmark supports the use of recycled office paper produced specifically for use in laser printers. For more information on recycled papers that work well with your printer, see [“Using recycled paper and other office papers” on page 45](#).

Conserving supplies

- Print on both sides of the paper.
Note: Two-sided printing is the default setting in the print driver.
- Print multiple pages on a single sheet of paper.
- Use the preview feature to see how the document looks like before printing it.
- Print one copy of the document to check its content and format for accuracy.

Saving energy

Using Eco-Mode

Use Eco-Mode to quickly select one or more ways to reduce your printer's environmental impact.

- 1 From the printer control panel, navigate to:

 > **Settings** >  > **Settings** >  > **General Settings** >  > **Eco-Mode** >  > select the setting you want

Use	To
Off	Use the factory default settings for all settings associated with Eco-Mode. This setting supports the performance specifications for your printer.
Energy	Reduce energy use, especially when the printer is idle. Notes: <ul style="list-style-type: none"> • Printer engine motors do not start until a job is ready to print. You may notice a short delay before the first page is printed. • The printer enters Sleep mode after one minute of inactivity.
Energy/Paper	Use all the settings associated with Energy and Paper modes.
Plain Paper	<ul style="list-style-type: none"> • Enable automatic two-sided (duplex) printing. • Turn off print log features.

2 Press .

Reducing printer noise

Enable Quiet mode to reduce the printer noise.

1 From the printer control panel, navigate to:

 > **Settings** >  > **Settings** >  > **General Settings** >  > **Quiet Mode** > 

2 Select a setting.

Use	To
On	Reduce printer noise. Notes: <ul style="list-style-type: none"> • Print jobs process at a reduced speed. • Printer engine motors do not start until a document is ready to print. There is a short delay before the first page is printed. • The alarm control and cartridge alarm sounds are turned off. • The printer ignores the Advance Start command.
Off	Use factory default settings. Note: This setting supports the performance specifications of the printer.

3 Press .

Adjusting Sleep mode

To save energy, decrease the number of minutes before the printer enters Sleep mode. Select from 1 to 120. The factory default setting is 30 minutes.

Note: The printer still accepts print jobs when in Sleep mode.

Using the Embedded Web Server

- 1 Open a Web browser, and then type the printer IP address in the address field.

Notes:

- View the printer IP address in the TCP/IP section in the Network/Ports menu. The IP address appears as four sets of numbers separated by periods, such as 123.123.123.123.
- If you are using a proxy server, then temporarily disable it to load the Web page correctly.

- 2 Navigate to:

Settings > General Settings > Timeouts

- 3 In the Sleep Mode field, enter the number of minutes you want the printer to wait before it enters Sleep mode.

- 4 Click **Submit**.

Using the printer control panel

- 1 From the printer control panel, navigate to:

 > **Settings** >  > **Settings** >  > **General Settings** >  > **Timeouts** >  > **Sleep Mode** > 

- 2 In the Sleep Mode field, select the number of minutes you want the printer to wait before it enters Sleep mode.

- 3 Press .

Using Hibernate mode

Hibernate is an ultra-low-power saving mode.

Notes:

- Three days is the default amount of time before the printer enters Hibernate mode.
- Make sure to wake the printer from Hibernate mode before sending a print job. A hard reset or a long press of the Sleep button wakes the printer from Hibernate mode.
- If the printer is in Hibernate mode, then the Embedded Web Server is disabled.

- 1 From the control panel, navigate to:

 > **Settings** >  > **Settings** >  > **General Settings** > 

- 2 Select **Press Sleep Button** or **Press and Hold Sleep Button**, and then press .

- 3 Press **Hibernate** > .

Setting Hibernate Timeout

Hibernate Timeout lets you set the amount of time the printer waits after a print job is processed before it goes into a reduced power state.

Using the Embedded Web Server

- 1 Open a Web browser, and then type the printer IP address in the address field.

Notes:

- View the printer IP address in the TCP/IP section in the Network/Ports menu. The IP address appears as four sets of numbers separated by periods, such as 123.123.123.123.
- If you are using a proxy server, then temporarily disable it to load the Web page correctly.

- 2 Click **Settings > General Settings > Timeouts**.

- 3 From the Hibernate Timeout menu, select the number of hours, days, weeks, or months you want for the printer to wait before it goes into a reduced power state.

- 4 Click **Submit**.

Using the printer control panel

- 1 From the printer control panel, navigate to:

 > **Settings** >  > **Settings** >  > **General Settings** >  > **Timeouts** >  > **Hibernate Timeout** > 

- 2 Select the amount of time the printer waits after a print job is processed before it enters Hibernate mode.

- 3 Press .

Using Schedule Power Modes

Schedule Power Modes lets you schedule when the printer goes into a reduced power state or into the Ready state.

Note: This feature is available only in network printers or printers connected to print servers.

- 1 Open a Web browser, and then type the printer IP address in the address field.

Notes:

- View the printer IP address in the TCP/IP section in the Network/Ports menu. The IP address appears as four sets of numbers separated by periods, such as 123.123.123.123.
- If you are using a proxy server, then temporarily disable it to load the Web page correctly.

- 2 Click **Settings > General Settings > Schedule Power Modes**.

- 3 From the Action menu, select the power mode.

- 4 From the Time menu, select the time.

- 5 From the Day(s) menu, select the day or days.

- 6 Click **Add**.

Recycling

Lexmark provides collection programs and environmentally progressive approaches to recycling. For more information, see:

- The Notices chapter
- The Environmental Sustainability section of the Lexmark Web site at www.lexmark.com/environment
- The Lexmark recycling program at www.lexmark.com/recycle

Recycling Lexmark products

To return Lexmark products for recycling:

- 1 Go to www.lexmark.com/recycle.
- 2 Find the product type you want to recycle, and then select your country or region from the list.
- 3 Follow the instructions on the computer screen.

Note: Printer supplies and hardware not listed in the Lexmark collection program may be recycled through your local recycling center. Contact your local recycling center to determine the items they accept.

Recycling Lexmark packaging

Lexmark continually strives to minimize packaging. Less packaging helps to ensure that Lexmark printers are transported in the most efficient and environmentally sensitive manner and that there is less packaging to dispose of. These efficiencies result in fewer greenhouse emissions, energy savings, and natural resource savings.

Lexmark cartons are 100% recyclable where corrugated recycling facilities exist. Facilities may not exist in your area.

The foam used in Lexmark packaging is recyclable where foam recycling facilities exist. Facilities may not exist in your area.

When you return a cartridge to Lexmark, you can reuse the box that the cartridge came in. Lexmark will recycle the box.

Returning Lexmark cartridges for reuse or recycling

The Lexmark Cartridge Collection Program allows you to return used cartridges for free to Lexmark for reuse or recycling. One hundred percent of the empty cartridges returned to Lexmark are either reused or demanufactured for recycling. The boxes used to return the cartridges are also recycled.

To return Lexmark cartridges for reuse or recycling, do the following:

- 1 Go to www.lexmark.com/recycle.
- 2 Select the product that you want to recycle.

Securing the printer

Using the security lock feature

The printer is equipped with a security lock feature. Attach a security lock compatible with most laptop computers in the location shown to secure the printer in place.



Statement of Volatility

Your printer contains various types of memory that can store device and network settings, and user data.

Type of memory	Description
Volatile memory	Your printer uses standard <i>random access memory</i> (RAM) to temporarily buffer user data during simple print jobs.
Non-volatile memory	Your printer may use two forms of non-volatile memory: EEPROM and NAND (flash memory). Both types are used to store operating system, device settings, and network information.

Erase the content of any installed printer memory in the following circumstances:

- The printer is being decommissioned.
- The printer is being moved to a different department or location.
- The printer is being serviced by someone from outside your organization.
- The printer is being removed from your premises for service.
- The printer is being sold to another organization.

Erasing volatile memory

The volatile memory (RAM) installed in your printer requires a power source to retain information. To erase the buffered data, simply turn off the printer.

Erasing non-volatile memory

Erase individual settings, device and network settings, security settings, and embedded solutions by following these steps:

- 1 Turn off the printer.
- 2 Hold down **2** and **6** on the keypad while turning the printer on. Release the buttons only when the screen with the progress bar appears.
The printer performs a power-on sequence, and then the Configuration menu appears. When the printer is fully turned on, a list of functions appears on the printer display.

- 3 Press the up or down arrow button until **Wipe All Settings** appears.

The printer will restart several times during this process.

Note: Wipe All Settings securely removes device settings, solutions, jobs, and passwords from the printer memory.

- 4 Navigate to:

Back > Exit Config Menu

The printer will perform a power-on reset, and then return to normal operating mode.

Finding printer security information

In high-security environments, it may be necessary to take additional steps to make sure that confidential data stored in the printer cannot be accessed by unauthorized persons. For more information, visit the [Lexmark security Web page](#).

You can also see the *Embedded Web Server — Security: Administrator's Guide* for additional information:

- 1 Go to www.lexmark.com, and then navigate to **Support & Downloads** > select your printer.
- 2 Click the **Manuals** tab, and then select *Embedded Web Server — Security: Administrator's Guide*.

Maintaining the printer

Warning—Potential Damage: Failure to maintain optimum printer performance, or to replace parts and supplies, may cause damage to your printer.

Storing supplies

Choose a cool, clean storage area for the printer supplies. Store supplies right side up in their original packing until you are ready to use them.

Do not expose supplies to:

- Direct sunlight
- Temperatures above 35°C (95°F)
- High humidity above 80%
- Salty air
- Corrosive gases
- Heavy dust

Cleaning the printer

Cleaning the printer

 **CAUTION—SHOCK HAZARD:** To avoid the risk of electrical shock when cleaning the exterior of the printer, unplug the power cord from the electrical outlet and disconnect all cables from the printer before proceeding.

Notes:

- Perform this task after every few months.
- Damage to the printer caused by improper handling is not covered by the printer warranty.

- 1** Turn off the printer, and then unplug the power cord from the electrical outlet.
- 2** Remove paper from the standard bin and multipurpose feeder.
- 3** Remove any dust, lint, and pieces of paper around the printer using a soft brush or vacuum.
- 4** Wipe the outside of the printer with a damp, soft, lint-free cloth.

Notes:

- Do not use household cleaners or detergents, as they may damage the finish of the printer.
- Make sure that all areas of the printer are dry after cleaning.

- 5** Connect the power cord, and then turn on the printer.

Cleaning the scanner glass

Clean the scanner glass if you encounter print quality problems, such as streaks on copied or scanned images.

- 1 Slightly dampen a soft, lint-free cloth or paper towel with water.
- 2 Open the scanner cover.



- 3 Clean all the areas shown, and then let them dry.



1	White underside of the ADF cover
2	White underside of the scanner cover
3	Scanner glass
4	ADF glass

- 4 Close the scanner cover.

Checking the status of parts and supplies

A message appears on the display when a replacement supply item is needed or when maintenance is required.

Checking the status of parts and supplies on the printer control panel

From the printer control panel, navigate to:

 > **Status/Supplies** >  **View Supplies** > 

Checking the status of parts and supplies from the Embedded Web Server

Note: Make sure the computer and printer are connected to the same network.

- 1 Open a Web browser, and then type the printer IP address in the address field.

Notes:

- View the printer IP address in the TCP/IP section in the Network/Ports menu. The IP address appears as four sets of numbers separated by periods, such as 123.123.123.123.
- If you are using a proxy server, then temporarily disable it to load the Web page correctly.

- 2 Click **Device Status** > **More Details**.

Estimated number of remaining pages

The estimated number of remaining pages is based on the recent printing history of the printer. Its accuracy may vary significantly and is dependent on many factors, such as actual document content, print quality settings, and other printer settings.

The accuracy of the estimated number of remaining pages may decrease when the actual printing consumption is different from the historical printing consumption. Consider the variable level of accuracy before purchasing or replacing supplies based on the estimate. Until an adequate print history is obtained on the printer, initial estimates assume future supplies consumption based on the International Organization for Standardization* test methods and page content.

* Average continuous black declared cartridge yield in accordance with ISO/IEC 19752.

Ordering supplies

To order supplies in the U.S., contact Lexmark at 1-800-539-6275 for information about Lexmark authorized supplies dealers in your area. In other countries or regions, go to the Lexmark Web site at www.lexmark.com or contact the place where you purchased the printer.

Note: All life estimates for printer supplies assume printing on letter- or A4-size plain paper.

Using genuine Lexmark parts and supplies

Your Lexmark printer is designed to function best with genuine Lexmark supplies and parts. Use of third-party supplies or parts may affect the performance, reliability, or life of the printer and its imaging components. Use of third-party supplies or parts can affect warranty coverage. Damage caused by the use of third-party supplies or parts is not covered by the warranty. All life indicators are designed to function with Lexmark supplies and parts, and may deliver unpredictable results if third-party supplies or parts are used. Imaging component usage beyond the intended life may damage your Lexmark printer or its associated components.

Ordering toner cartridges

Notes:

- The estimated cartridge yield is based on the ISO/IEC 19798 standard.
- Extremely low print coverage for extended periods of time may negatively affect actual yield and may cause cartridge parts to fail prior to exhaustion of toner.

CX310 Return program toner cartridges

Item	United States and Canada	Economic Area (EEA+)	Rest of Europe, Middle East, and Africa (RoEMEA)	Latin America Distribution (LAD)	Rest of Asia Pacific (RoAP)	Australia and New Zealand (ANZ)
Return program toner cartridges						
Black	80C10K0	80C20K0	80C80K0	80C80K0	80C80K0	80C80K0
Cyan	80C10C0	80C20C0	80C80C0	80C80C0	80C80C0	80C80C0
Magenta	80C10M0	80C20M0	80C80M0	80C80M0	80C80M0	80C80M0
Yellow	80C10Y0	80C20Y0	80C80Y0	80C80Y0	80C80Y0	80C80Y0
Standard yield return program toner cartridges						
Black	80C1SK0	80C2SK0	80C8SK0	80C8SK0	80C8SK0	80C8SK0
Cyan	80C1SC0	80C2SC0	80C8SC0	80C8SC0	80C8SC0	80C8SC0
Magenta	80C1SM0	80C2SM0	80C8SM0	80C8SM0	80C8SM0	80C8SM0
Yellow	80C1SY0	80C2SY0	80C8SY0	80C8SY0	80C8SY0	80C8SY0
For more information on countries located in a region, go to www.lexmark.com/regions .						

CX310 Regular cartridges

Item	Worldwide
Standard yield regular toner cartridges	
Black	80C0S10
Cyan	80C0S20
Magenta	80C0S30
Yellow	80C0S40
For more information on countries located in a region, go to www.lexmark.com/regions .	

CX317 Return Program toner cartridges

Item	United States and Canada	Economic Area (EEA+)	Rest of Europe, Middle East, and Africa (RoEMEA)	Latin America Distribution (LAD)	Rest of Asia Pacific (RoAP)	Australia and New Zealand (ANZ)
Return program toner cartridges						
Black	71B10K0	71B20K0	71B50K0	71B40K0	71B30K0	71B60K0
Cyan	71B10C0	71B20C0	71B50C0	71B40C0	71B30C0	71B60C0
Magenta	71B10M0	71B20M0	71B50M0	71B40M0	71B30M0	71B60M0
Yellow	71B10Y0	71B20Y0	71B50Y0	71B40Y0	71B30Y0	71B60Y0
For more information on countries located in a region, go to www.lexmark.com/regions .						

CX317 Regular cartridges

Item	Worldwide
Regular toner cartridges	
Black	71B0010
Cyan	71B0020
Magenta	71B0030
Yellow	71B0040
For more information on countries located in a region, go to www.lexmark.com/regions .	

Ordering imaging kits

Item	All countries and regions
Black imaging kit	700Z1
Color imaging kit	700Z5

Ordering a maintenance kit

Notes:

- Using certain types of paper may require more frequent replacement of the maintenance kit.
- The separator pad, fuser, and transfer module are included in the maintenance kit and can also be individually ordered and replaced, if necessary. The separator pad is a customer replaceable part.
- To replace the maintenance kit, contact customer support at <http://support.lexmark.com> or your service representative.

Part name	Type	Supply number
Maintenance kit	115 V	40X7615
	220 V	40X7616
	100 V	40X7617

Item	Supply number
Separator pad	40X6247

Ordering a waste toner bottle

Item	All countries and regions
Waste toner bottle	C540X75G

Replacing supplies

Replacing the waste toner bottle

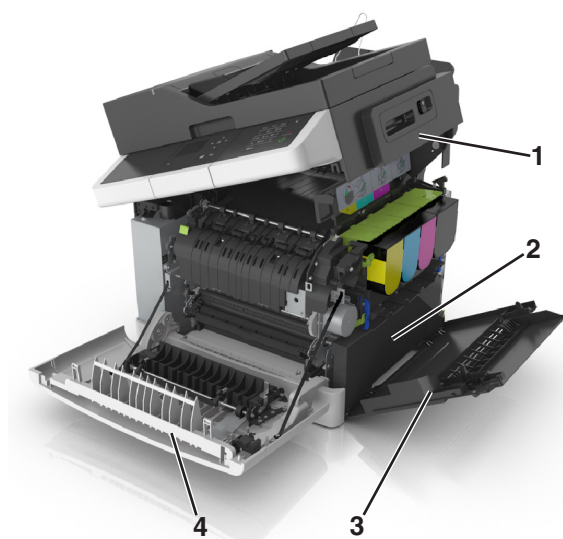

1	Top door
2	Waste toner bottle

3	Right side cover
4	Front door

1 Unpack the replacement waste toner bottle.

2 Open the front door.

 **CAUTION—HOT SURFACE:** The inside of the printer might be hot. To reduce the risk of injury from a hot component, allow the surface to cool before touching.

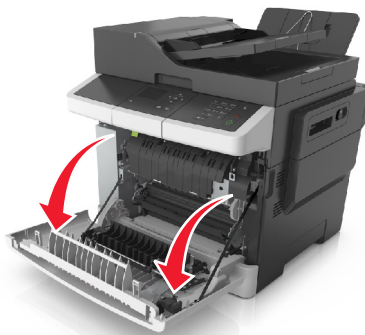

3 Open the top door.



- 4** Remove the right side cover.

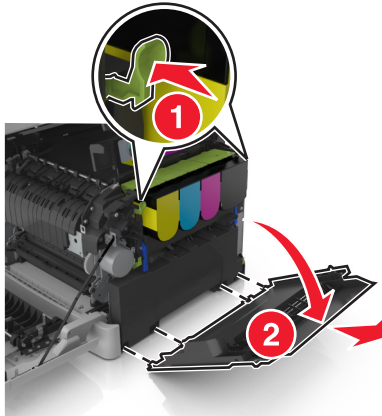

- 5** Press the green levers on each side of the waste toner bottle, and then remove the waste toner bottle.

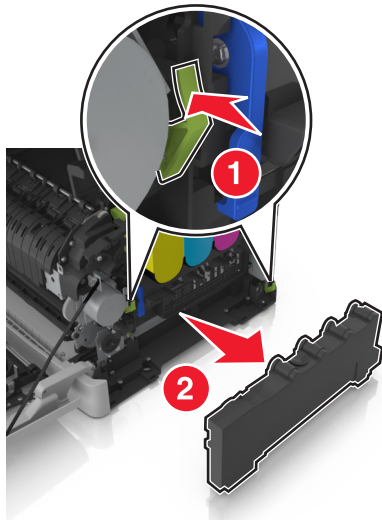

- 6** Seal the used waste toner bottle in the enclosed packaging.
For more information, see [“Recycling Lexmark products” on page 126](#).

7 Insert the replacement waste toner bottle.

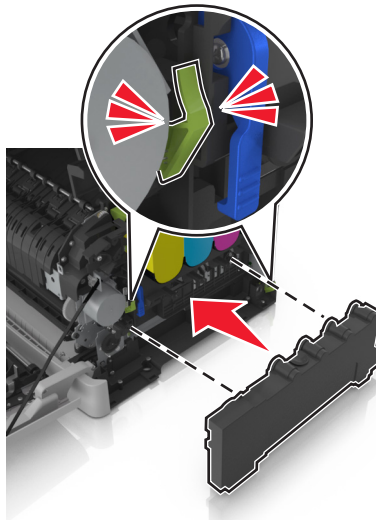

8 Insert the right side cover.

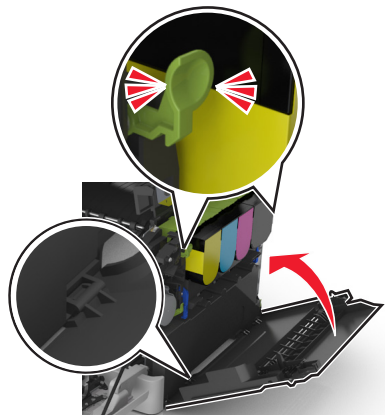

9 Slide and hold the release latch on the right side of the printer, and then slowly close the top door.

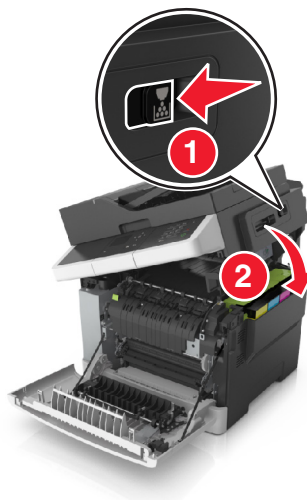

- 10 Close the front door.

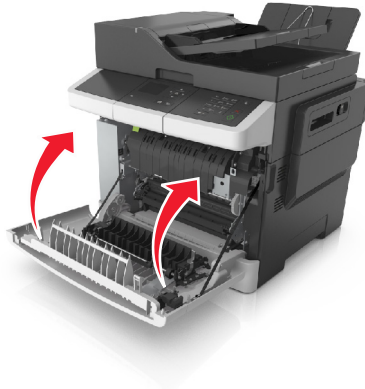

Replacing a black and color imaging kit

- 1 Open the front door.

 **CAUTION—HOT SURFACE:** The inside of the printer might be hot. To reduce the risk of injury from a hot component, allow the surface to cool before touching.

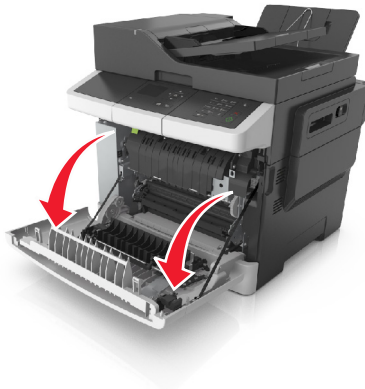

- 2 Open the top door.



3 Remove the toner cartridges by lifting the handles, and then gently pulling them away from the imaging kit.

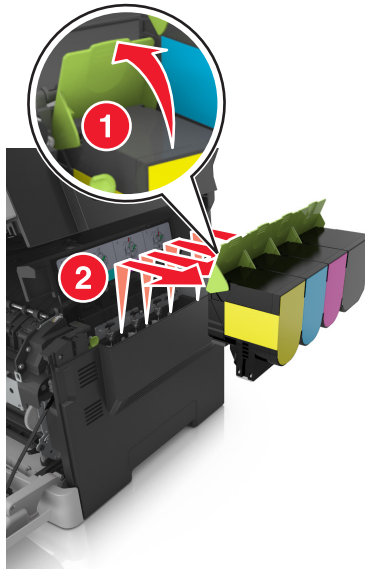

4 Remove the right side cover.

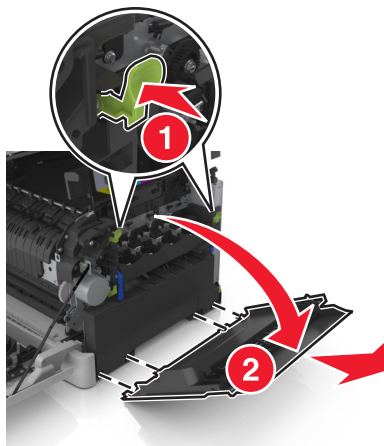

5 Press the green levers on each side of the waste toner bottle, and then remove the waste toner bottle.

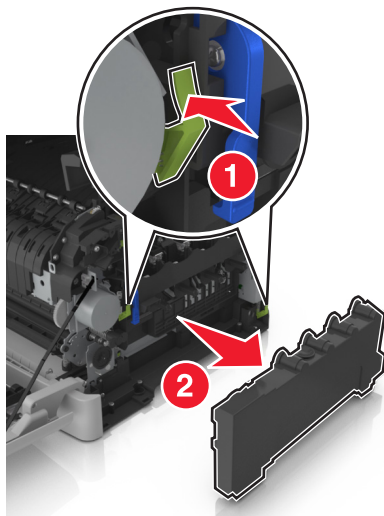

6 Lift the blue levers on the imaging kit, and then pull the imaging kit until it stops.

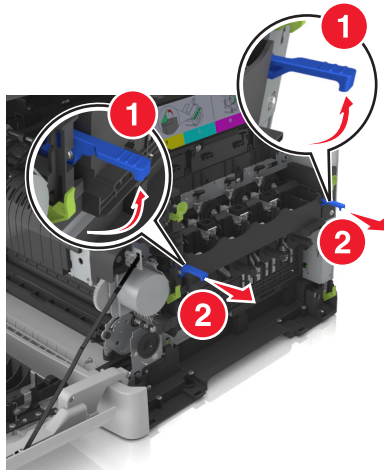

7 Press down the blue lever, and then grasp the green handles on the sides to pull out the imaging kit.

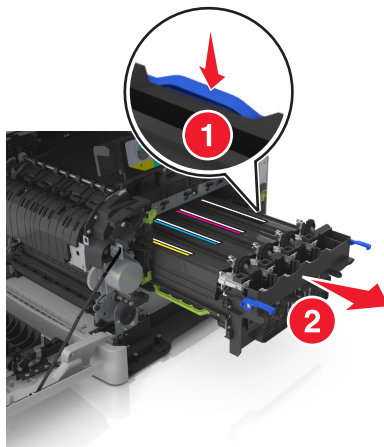

8 Unpack the replacement black and color imaging kit.

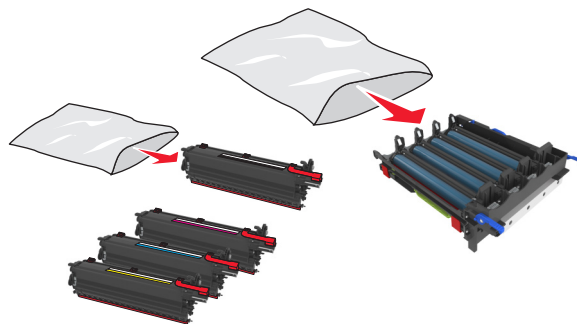

Notes:

- The color imaging kit includes the imaging kit and the cyan, magenta, yellow, and black developer units.
- The black imaging kit includes the imaging kit and the black developer unit.

9 Seal the used imaging kit in the bag that the replacement imaging kit came in.

For more information, see [“Recycling Lexmark products” on page 126](#).

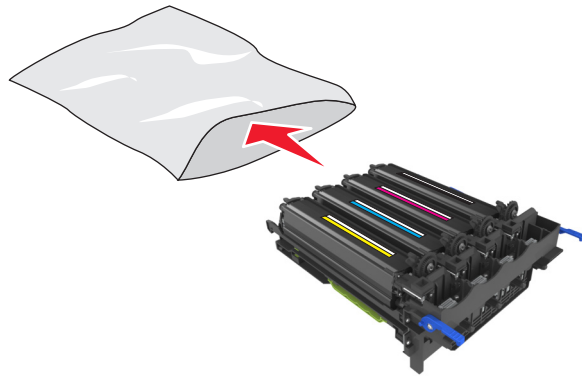

Note: When replacing the black imaging kit, save the cyan, magenta, and yellow developer units. Dispose only the black developer unit.

- 10** Gently shake the yellow, cyan, magenta, and black developer units side-to-side.

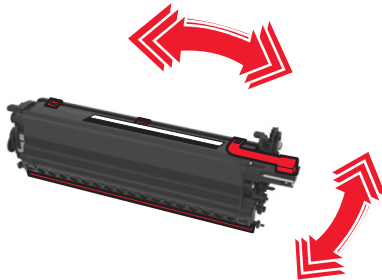

- 11** Remove the red packing strip and the attached fabric from the developer units.

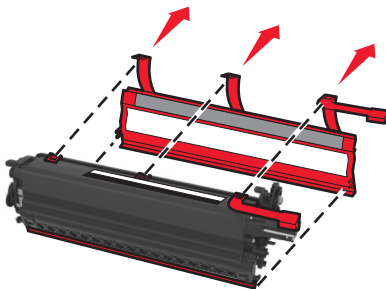

- 12** Gently insert the yellow, cyan, magenta, and black developer units.

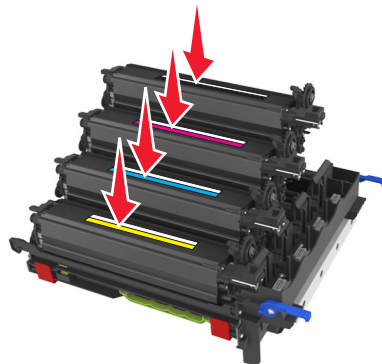

Note: Make sure each developer unit is inserted into the matching color slot.

- 13** Remove the red packing strip from the imaging kit.

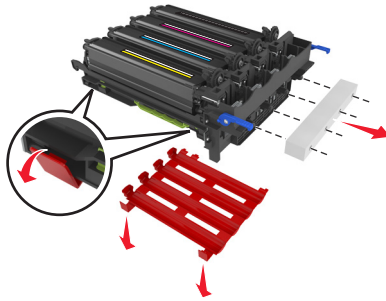

Warning—Potential Damage: Do not touch the shiny photoconductor drum under the imaging kit. Doing so may affect the quality of future print jobs.

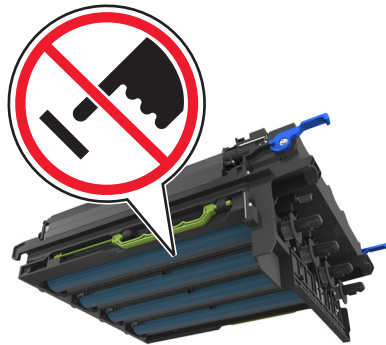

- 14** Align and then insert the imaging kit.

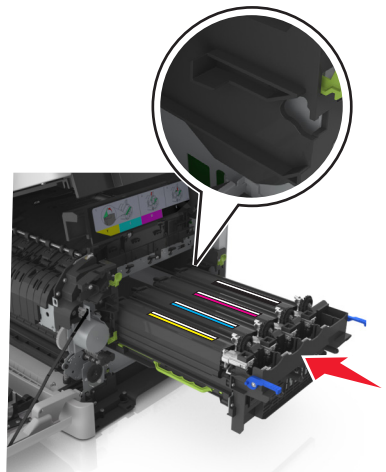

15 Gently but firmly push the blue levers down until the imaging kit fits into place.

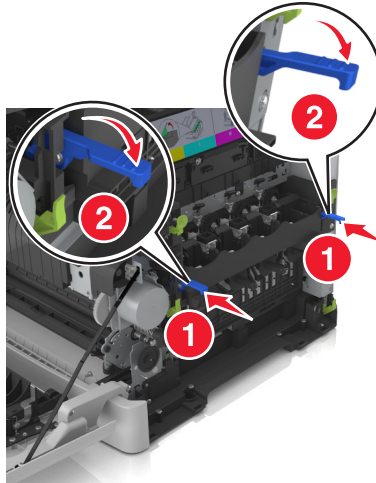

Note: Make sure that the imaging kit is fully seated.

16 Insert the waste toner bottle.

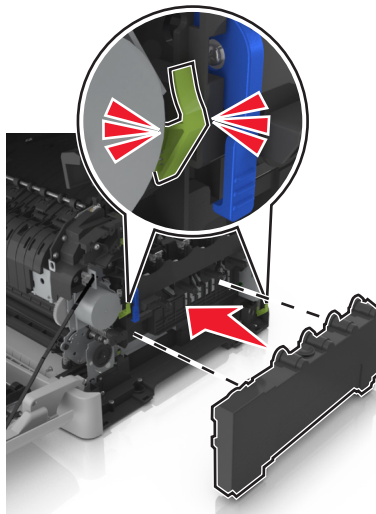

17 Insert the right side cover.

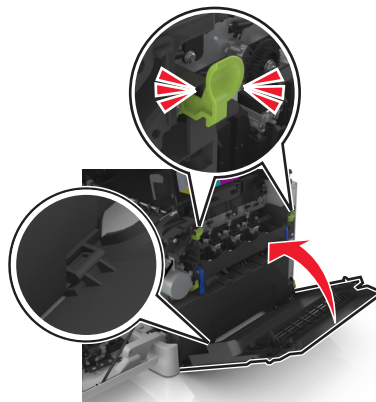

18 Insert the toner cartridges.

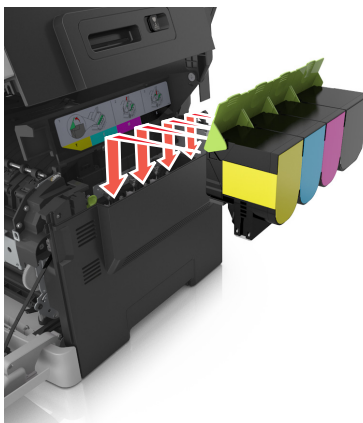

19 Slide and hold the release latch on the right side of the printer, and then slowly close the top door.

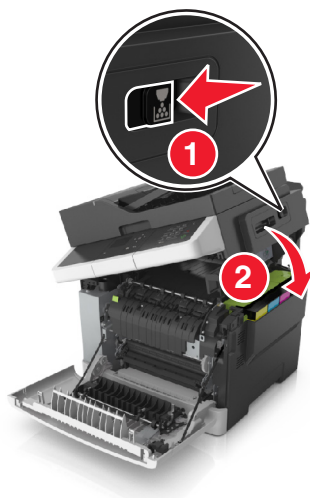

20 Close the front door.

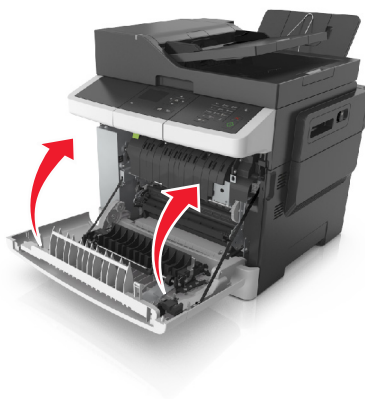

Replacing toner cartridges

Warning—Potential Damage: Damage caused by use of a non-Lexmark toner cartridge is not covered under warranty.

Note: A reduced print quality may result from using non-Lexmark toner cartridges.

- 1 Open the top door.



- 2 Remove the toner cartridge by lifting the handle, and then gently pulling it away from the imaging kit.

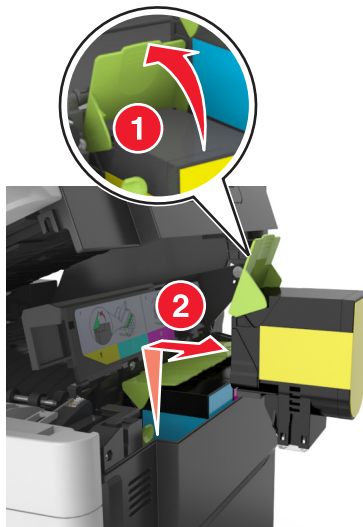

- 3** Unpack the new toner cartridge, and then remove its packaging.

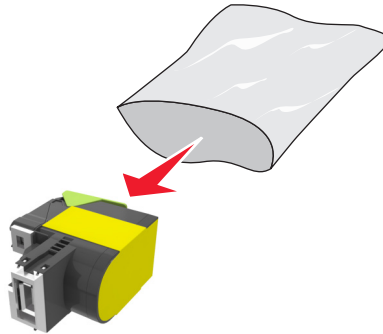

- 4** Align the new toner cartridge, and then press the cartridge down until it fits into place.

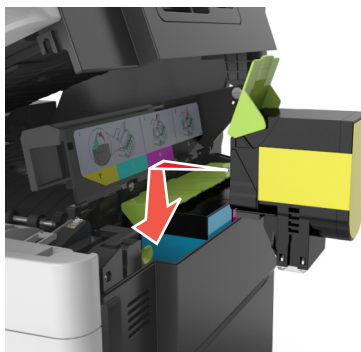

- 5** Slide and hold the release latch on the right side of the printer, and then slowly close the top door.



- 6** Seal the used toner cartridge in the bag that the replacement toner cartridge came in.
For more information, see [“Recycling Lexmark products” on page 126](#).

Replacing a developer unit

Replace the developer unit when a print quality defect occurs or when damage occurs to the printer.

- 1 Open the front door.

 **CAUTION—HOT SURFACE:** The inside of the printer might be hot. To reduce the risk of injury from a hot component, allow the surface to cool before touching.

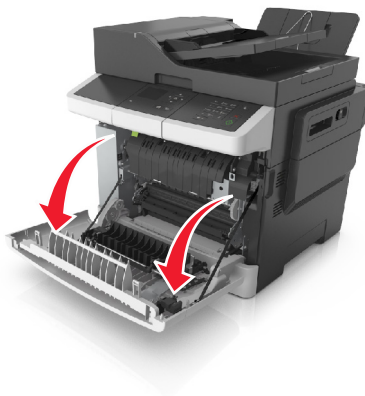

- 2 Open the top door.



3 Lift the toner cartridge handle, and then gently pull it from the imaging kit.

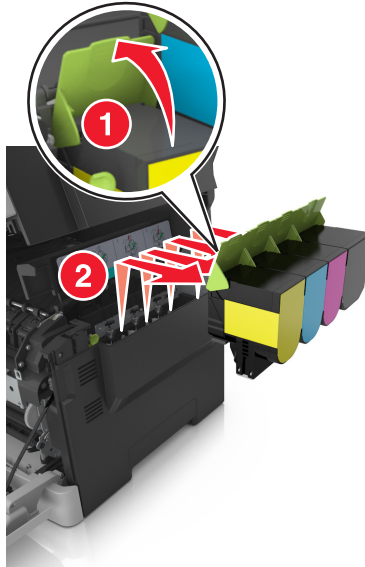

4 Remove the right side cover.

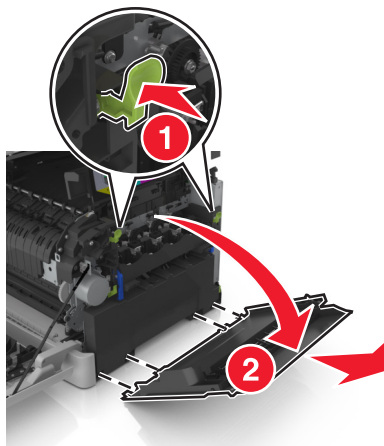

5 Press the green levers on each side of the waste toner bottle, and then remove the waste toner bottle.

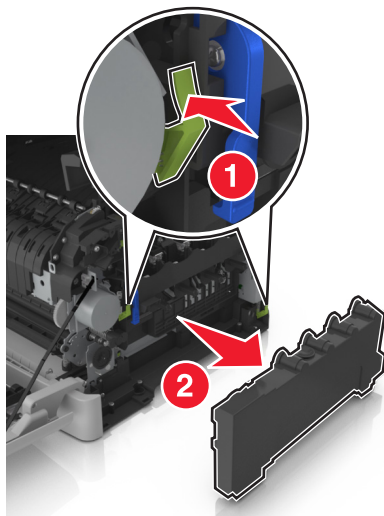

- 6 Lift the blue levers on the imaging kit, and then pull the imaging kit until it stops.

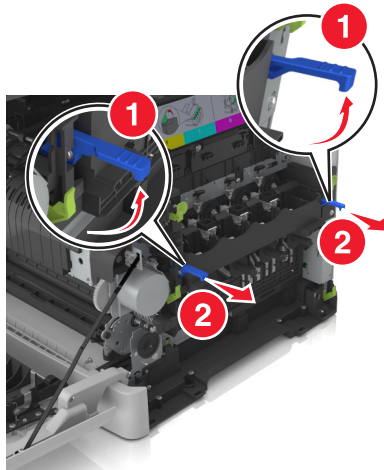

- 7 Press down the blue lever, and then grasp the green handles on the sides to pull out the imaging kit.

Warning—Potential Damage: Do not touch the underside of the imaging kit. Doing so could damage the imaging kit.

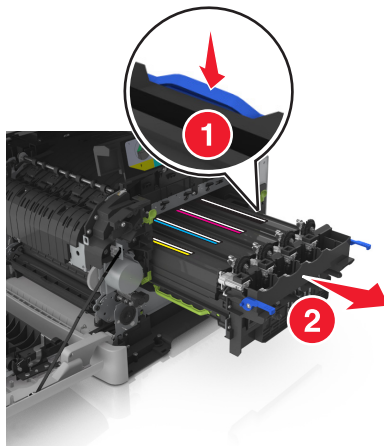

- 8 Remove the used developer unit.

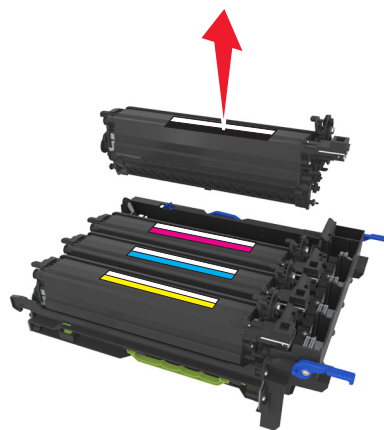

- 9** Gently shake the replacement developer unit side-to-side before removing it from its packaging.

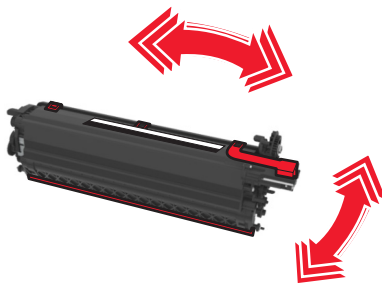

- 10** Remove the red shipping cover from the developer unit.

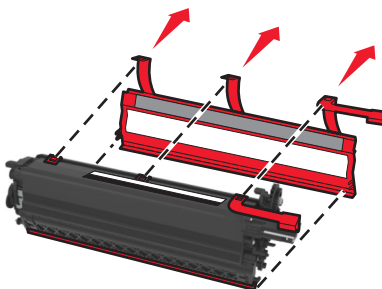

- 11** Insert the developer unit.

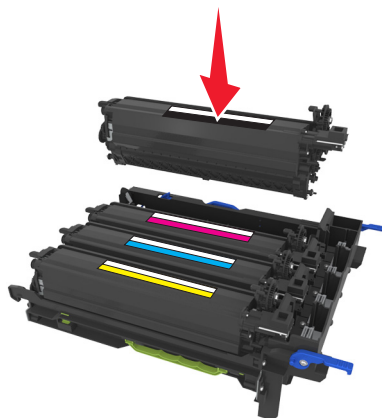

12 Align and then insert the imaging kit.

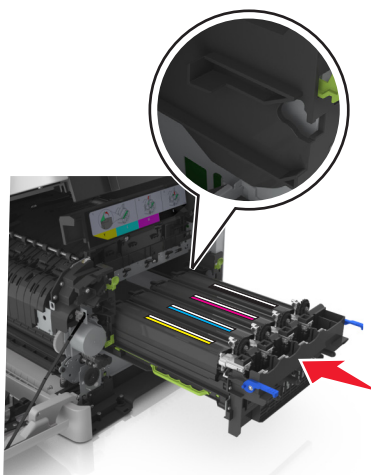

13 Gently but firmly push the blue levers down until the imaging kit fits into place.

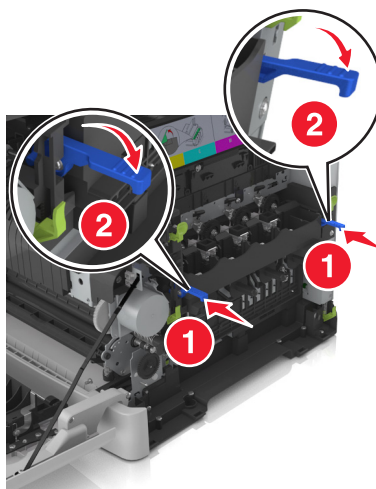

Note: Make sure that the imaging kit is fully seated.

14 Replace the waste toner bottle.

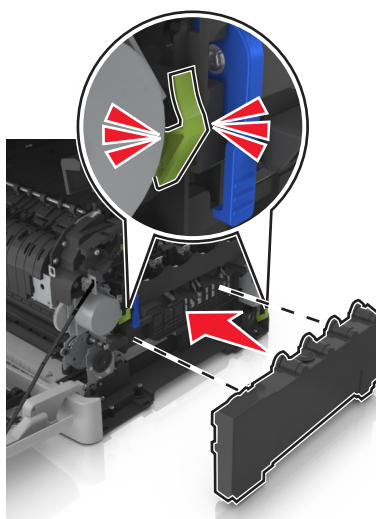

15 Insert the right side cover.

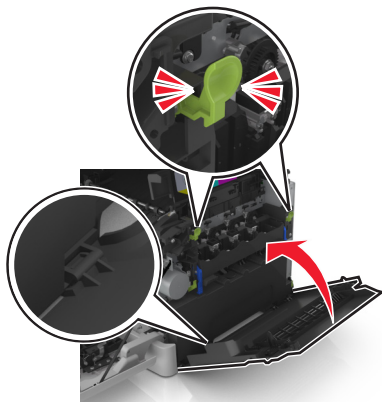

16 Insert the toner cartridges.

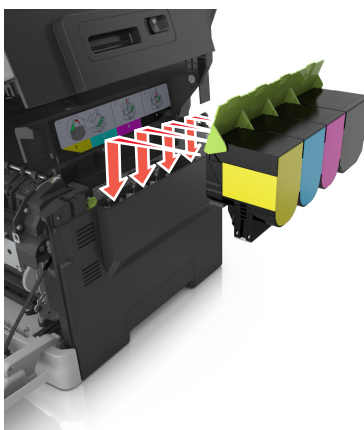

17 Slide and hold the release latch on the right side of the printer, and then slowly close the top door.

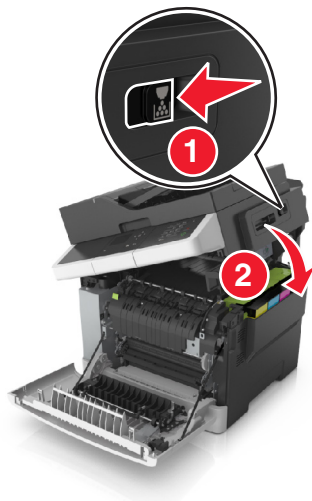

- 18 Close the front door.

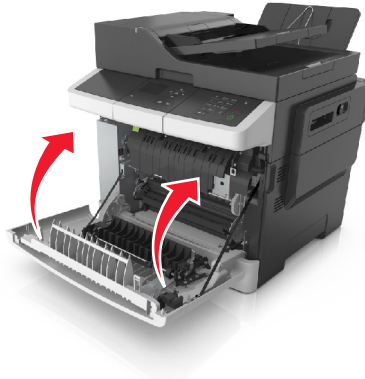

- 19 Seal the used developer unit in the bag that the replacement developer unit came in.
For more information, see [“Recycling Lexmark products” on page 126](#).

Moving the printer

Moving the printer to another location

- ⚠ CAUTION—POTENTIAL INJURY:** The printer weight is greater than 18 kg (40 lb) and requires two or more trained personnel to lift it safely.
- ⚠ CAUTION—POTENTIAL INJURY:** To avoid the risk of fire or electrical shock, use only the power cord provided with this product or the manufacturer's authorized replacement.
- ⚠ CAUTION—POTENTIAL INJURY:** When moving the printer, follow these guidelines to avoid personal injury or printer damage:
- Make sure that all doors and trays are closed.
 - Turn off the printer, and then unplug the power cord from the electrical outlet.
 - Disconnect all cords and cables from the printer.
 - If the printer has a caster base, then carefully roll it to the new location. Use caution when passing over thresholds and breaks in flooring.
 - If the printer does not have a caster base but is configured with optional trays, then lift the printer off the trays. Do not try to lift the printer and the trays at the same time.
 - Always use the handholds on the printer to lift it.
 - Any cart used to move the printer must have a surface able to support the full footprint of the printer.
 - Any cart used to move the hardware options must have a surface able to support the dimensions of the options.
 - Keep the printer in an upright position.
 - Avoid severe jarring movements.
 - Make sure that your fingers are not under the printer when you set it down.
 - Make sure that there is adequate clearance around the printer.

Note: Damage to the printer caused by improper moving is not covered by the printer warranty.

Shipping the printer

When shipping the printer, use the original packaging.

Managing the printer

Finding advanced networking and administrator information

This chapter covers basic administrative support tasks using the Embedded Web Server. For more advanced system support tasks, see the *Networking Guide* on the *Software and Documentation CD* or the *Embedded Web Server — Security: Administrator's Guide* on the Lexmark support Web site at <http://support.lexmark.com>.

Checking the virtual display

- 1 Open a Web browser, and then type the printer IP address in the address field.

Notes:

- View the printer IP address in the TCP/IP section in the Network/Ports menu. The IP address appears as four sets of numbers separated by periods, such as 123.123.123.123.
- If you are using a proxy server, then temporarily disable it to load the Web page correctly.

- 2 Check the virtual display that appears at the top left corner of the screen.

The virtual display works as an actual display would work on a printer control panel.

Setting up e-mail alerts

Configure the printer to send you e-mail alerts when the supplies are getting low, when the paper needs to be changed or added, or when there is a paper jam.

- 1 Open a Web browser, and then type the printer IP address in the address field.

Notes:

- View the printer IP address in the TCP/IP section in the Network/Ports menu. The IP address appears as four sets of numbers separated by periods, such as 123.123.123.123.
- If you are using a proxy server, then temporarily disable it to load the Web page correctly.

- 2 Click **Settings**.

- 3 From the Other Settings menu, click **E-mail Alert Setup**.

- 4 Select the items you want to be notified on, and then type the e-mail addresses.

- 5 Click **Submit**.

Note: For information on setting up the e-mail server, contact your system support person.

Viewing reports

You can view some reports from the Embedded Web Server. These reports are useful for assessing the status of the printer, network, and supplies.

- 1 Open a Web browser, and then type the printer IP address in the address field.

Notes:

- View the printer IP address in the TCP/IP section in the Network/Ports menu. The IP address appears as four sets of numbers separated by periods, such as 123.123.123.123.
- If you are using a proxy server, then temporarily disable it to load the Web page correctly.

- 2 Click **Reports**, and then click the type of report you want to view.

Configuring supply notifications from the Embedded Web Server

You can determine how you would like to be notified when supplies run nearly low, low, very low, or reach their end-of-life by setting the selectable alerts.

Notes:

- You can select alerts for toner cartridges, imaging kit, maintenance kit, and waste toner bottle.
- All alerts can be set for nearly low, low, and very low supply conditions. Not all alerts can be set for the end-of-life supply condition. E-mail alert is available for all supply conditions.
- The percentage of estimated remaining supply that prompts the alert can be set on some supplies for some supply conditions.

- 1 Open a Web browser, and then type the printer IP address in the address field.

Notes:

- View the printer IP address in the TCP/IP section in the Network/Ports menu. The IP address appears as four sets of numbers separated by periods, such as 123.123.123.123.
- If you are using a proxy server, then temporarily disable it to load the Web page correctly.

- 2 Click **Settings > Print Settings > Supply Notifications**.

- 3 From the drop-down menu for each supply, select one of the following notification options:

Notification	Description
Off	The normal printer behavior for all supplies occurs.
E-mail Only	The printer generates an e-mail when the supply condition is reached. The status of the supply appears on the menus page and status page.
Warning	The printer shows the warning message and generates an email about the status of the supply. The printer does not stop when the supply condition is reached.
Continuable Stop ¹	The printer stops processing jobs when the supply condition is reached. The user needs to press a button to continue printing.

¹ The printer generates an e-mail about the status of the supply when supply notification is enabled.

² The printer stops when some supplies become empty to prevent damage.

Notification	Description
Non Continuable Stop ^{1,2}	The printer stops when the supply condition is reached. The supply must be replaced to continue printing.
¹ The printer generates an e-mail about the status of the supply when supply notification is enabled. ² The printer stops when some supplies become empty to prevent damage.	

4 Click **Submit**.

Copying printer settings to other printers

Note: This feature is available only in network printers.

1 Open a Web browser, and then type the printer IP address in the address field.

Notes:

- View the printer IP address in the TCP/IP section in the Network/Ports menu. The IP address appears as four sets of numbers separated by periods, such as 123.123.123.123.
- If you are using a proxy server, then temporarily disable it to load the Web page correctly.

2 Click the **Copy Printer Settings**.

3 To change the language, select a language from the drop-down menu, and then click **Click here to submit language**.

4 Click **Printer Settings**.

5 Type the IP addresses of the source and target printers in their appropriate fields.

Note: If you want to add or remove a target printer, then click **Add Target IP** or **Remove Target IP**.

6 Click **Copy Printer Settings**.

Restoring factory default settings

If you want to keep a list of the current menu settings for reference, then print a menu settings page before restoring the factory default settings. For more information, see [“Printing a menu settings page” on page 28](#).

If you want a more comprehensive method of restoring the printer factory default settings, then perform the Wipe All Settings option. For more information, see [“Erasing non-volatile memory” on page 128](#).

Warning—Potential Damage: Restoring factory defaults returns most printer settings to the original factory default settings. Exceptions include the display language, custom sizes and messages, and network/port menu settings. All downloads stored in the RAM are deleted.

From the printer control panel, navigate to:

 > **Settings** >  > **Settings** >  > **General Settings** >  > **Factory Defaults** >  > **Restore Now**
 > 

Clearing jams

By carefully selecting paper and specialty media and loading it properly, you should be able to avoid most jams. If jams occur, then follow the steps outlined in this chapter.

Warning—Potential Damage: Never use any tool to remove a jam. Doing so could permanently damage the fuser.

Avoiding jams

Load paper properly

- Make sure that the paper lies flat in the tray.

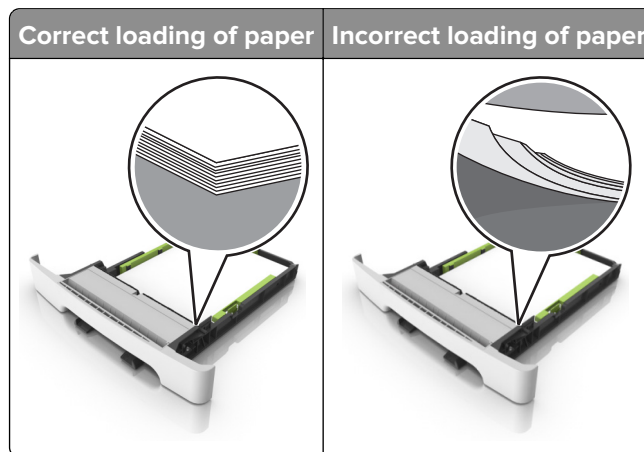

- Do not load or remove a tray while the printer is printing.
- Do not load too much paper. Make sure that the stack height is below the maximum paper fill indicator.

- Do not slide paper into the tray. Load paper as shown in the illustration.

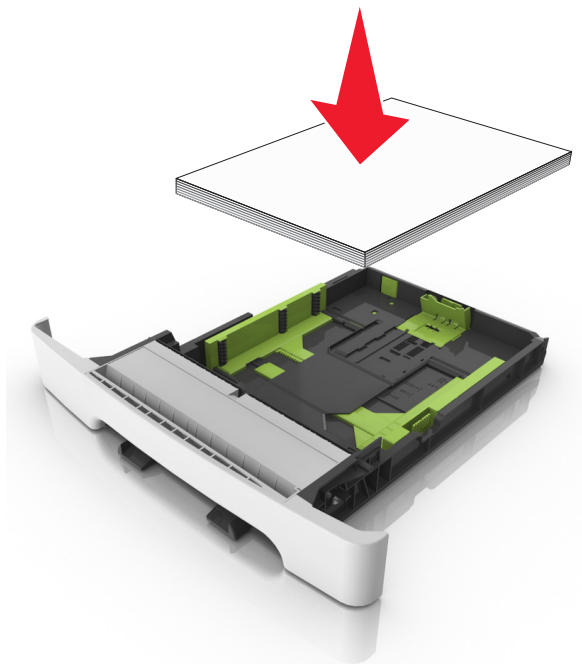

- Make sure that the paper guides are positioned correctly and are not pressing tightly against the paper or envelopes.
- Push the tray firmly into the printer after loading paper.

Use recommended paper

- Use only recommended paper or specialty media.
- Do not load paper that is wrinkled, creased, damp, bent, or curled.
- Flex, fan, and align the paper edges before loading.

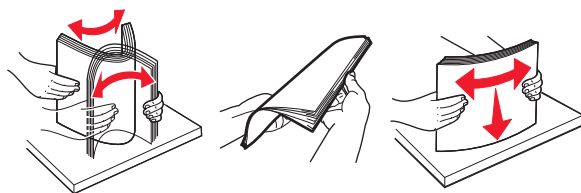

- Do not use paper that has been cut or trimmed by hand.
- Do not mix paper sizes, weights, or types in the same tray.
- Make sure that the paper size and type are set correctly on the computer or printer control panel.
- Store paper according to manufacturer recommendations.

Identifying jam locations

Notes:

- When Jam Assist is set to On, the printer flushes blank pages or pages with partial prints after a jammed page has been cleared. Check your printed output for blank pages.
- When Jam Recovery is set to On or Auto, the printer reprints jammed pages.

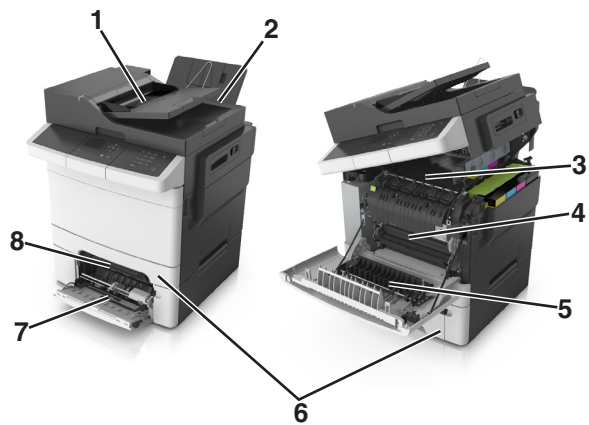

	Jam location
1	Automatic document feeder (ADF)
2	Standard bin
3	Fuser
4	Front door
5	Duplex area
6	Trays
7	Multipurpose feeder
8	Manual feeder

Paper jam in the standard bin

- 1 Open the top door.

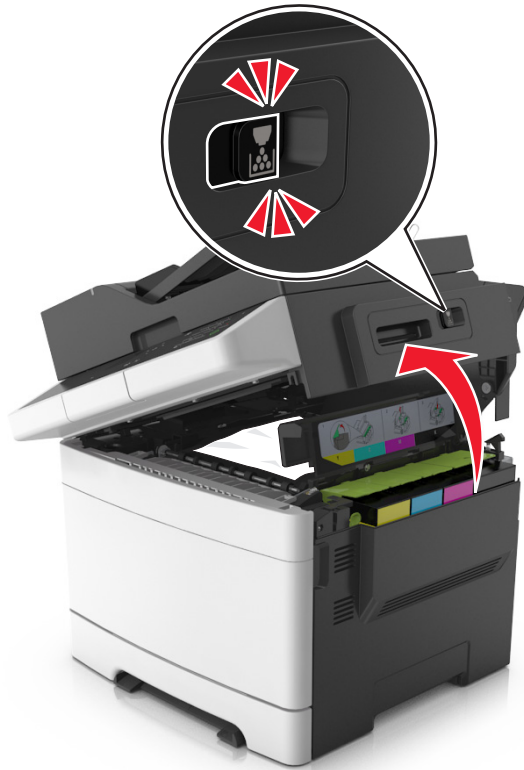

- 2 Remove the jammed paper.

Note: Make sure that all paper fragments are removed.



- 3 Close the top door.

Paper jam in the front door

Paper jam in the fuser

- 1 Open the front and top doors.

 **CAUTION—HOT SURFACE:** The inside of the printer might be hot. To reduce the risk of injury from a hot component, allow the surface to cool before touching.



- 2 Remove the jammed paper.

Note: Make sure that all paper fragments are removed.

- Below the fuser

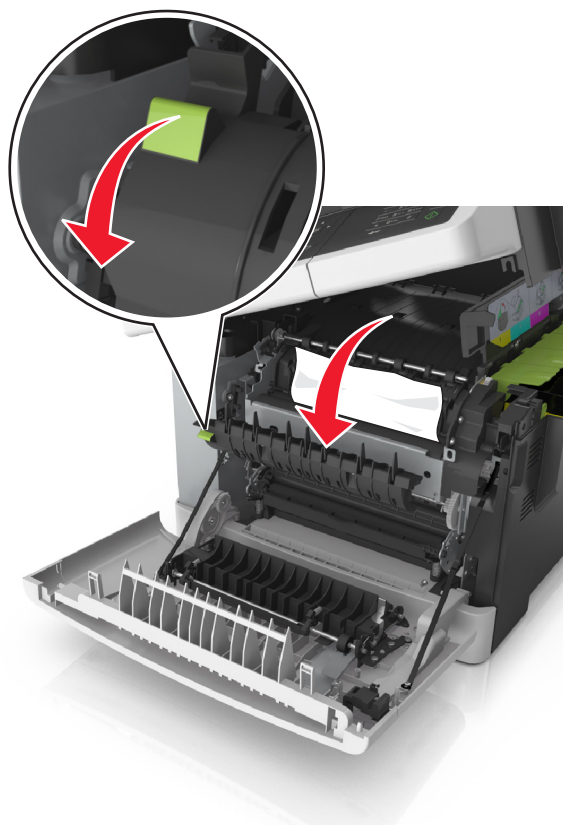

- In the fuser access door

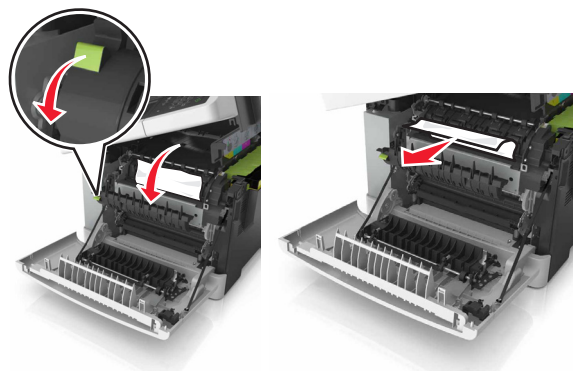

3 Close the top and front doors.

Paper jam in the duplex unit

- 1 Open the front door.

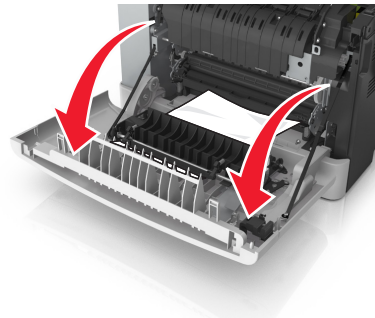

- 2 Remove the jammed paper.

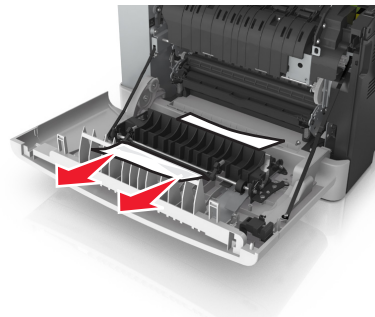

- 3 Close the front door.

Paper jam in trays

- 1 Pull out the tray.



- 2 Remove the jammed paper.

Note: Make sure that all paper fragments are removed.



- 3 Insert the tray.

Paper jam in the manual feeder

- 1 Remove the tray.

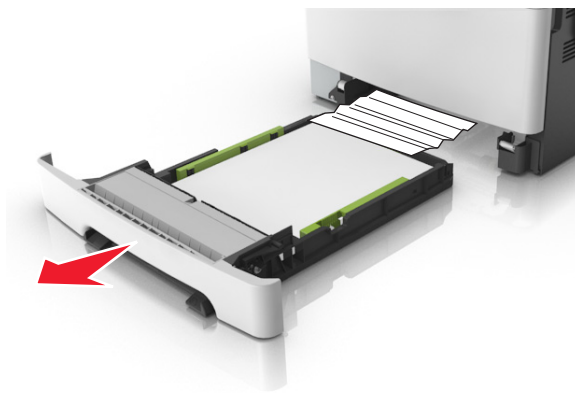

- 2 Remove the jammed paper.

Note: Make sure that all paper fragments are removed.

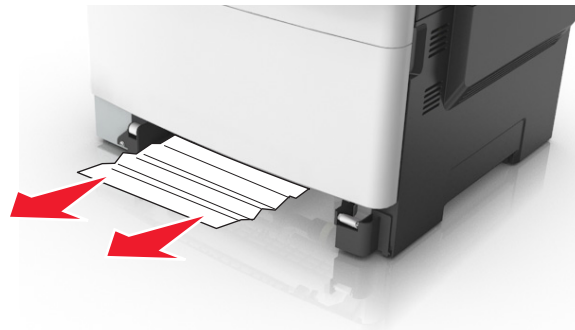

- 3 Insert the tray.

Paper jam in the multipurpose feeder

- 1 Remove paper from the multipurpose feeder.

- 2 Remove the jammed paper.

Note: Make sure that all paper fragments are removed.

- 3 Flex, fan, and align the paper edges before loading.

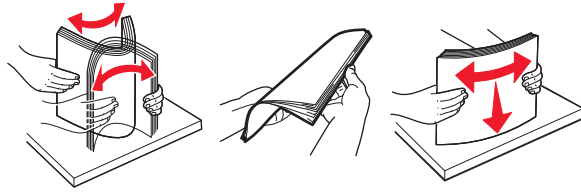

- 4 Reload paper.



Paper jam in the automatic document feeder

- 1 Remove all original documents from the ADF tray.
- 2 Open the ADF cover.

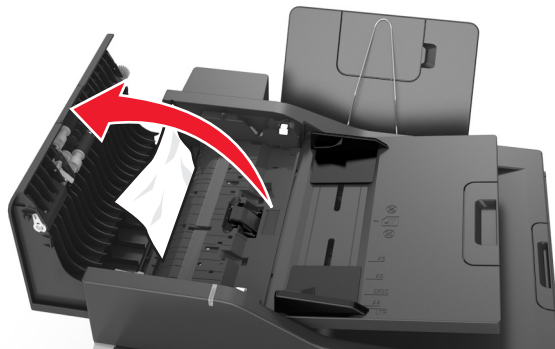

- 3 Remove the jammed paper.
Note: Make sure that all paper fragments are removed.

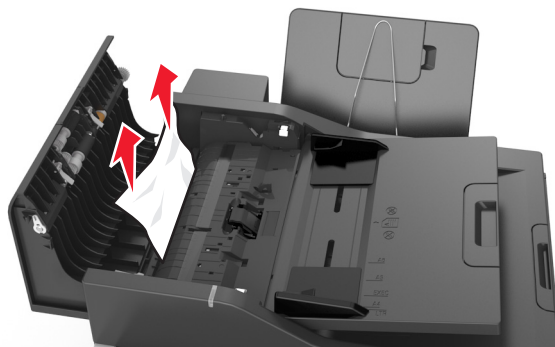

4 Close the ADF cover.

5 Flex, fan, and align the paper edges before loading.

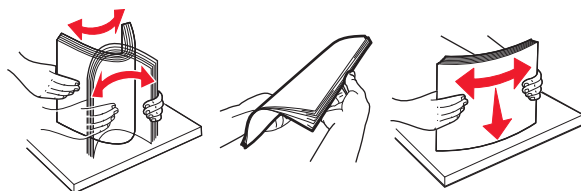

6 Reload the documents into the ADF.

Troubleshooting

Understanding the printer messages

Adjusting color

Wait for the process to complete.

Change [paper source] to [custom type name]

Try one or more of the following:

- Load the correct size and type of paper in the tray, and then select **Finished changing paper** on the printer control panel to clear the message and continue printing. For non-touch-screen printer models, press **OK** to confirm.

Note: Make sure the paper size and type are specified in the Paper menu on the printer control panel.

- Cancel the print job.

Change [paper source] to [custom string]

Try one or more of the following:

- Load the correct size and type of paper in the tray, and then select **Finished changing paper** on the printer control panel to clear the message and continue printing. For non-touch-screen printer models, press **OK** to confirm.

Note: Make sure the paper size and type are specified in the Paper menu on the printer control panel.

- Cancel the print job.

Change [paper source] to [paper type] [paper size]

Try one or more of the following:

- Load the correct size and type of paper in the tray, and then select **Finished changing paper** on the printer control panel to clear the message and continue printing. For non-touch-screen printer models, press **OK** to confirm.

Note: Make sure the paper size and type are specified in the Paper menu on the printer control panel.

- Cancel the print job.

Close door

Make sure the right side cover is installed, and then close the front and top doors to clear the message.

Close flatbed cover and load originals if restarting job [2yy.xx]

From the printer control panel, try one or more of the following:

- Select **Scan from automatic feeder**, and then press **OK** to continue scanning from the ADF immediately after the last successful scan job.
- Select **Scan from flatbed**, and then press **OK** to continue scanning from the scanner glass immediately after the last successful scan job.
- Select **Finish job without further scanning**, and then press **OK** to end the last successful scan job.
Note: This does not cancel the scan job. All successfully scanned pages will be processed further for copying or e-mailing.
- Select **Restart Job**, and then press **OK** to restart the scan job with the same settings from the previous scan job.
- Select **Cancel Job**, and then press **OK** to clear the message and cancel the scan job.

[Color] cartridge low [88.xy]

You may need to order a toner cartridge. If necessary, select **Continue** to clear the message and continue printing. For non-touch-screen printer models, press **OK** to confirm.

[Color] cartridge nearly low [88.xy]

If necessary, select **Continue** on the printer control panel to clear the message and continue printing. For non-touch-screen printer models, press **OK** to confirm.

[Color] cartridge very low, [x] estimated pages remain [88.xy]

You may need to replace the toner cartridge very soon. For more information, see the “Replacing supplies” section of the *User’s Guide*.

If necessary, select **Continue** on the printer control panel to clear the message and continue printing. For non-touch-screen printer models, press **OK** to confirm.

Complex page, some data may not have printed [39]

Try one or more of the following:

- From the printer control panel, select **Continue** to ignore the message and continue printing. For non-touch-screen printer models, press **OK** to confirm.
- Cancel the current print job. For non-touch-screen printer models, press **OK** to confirm.
- Install additional printer memory.

Configuration change, some held jobs were not restored [57]

Held jobs are invalidated because of any of the following possible changes in the printer:

- The printer firmware has been updated.
- The tray for the print job is removed.
- The print job is sent from a flash drive that is no longer attached to the USB port.
- The printer hard disk contains print jobs that were stored when the hard disk was installed in a different printer model.

Note: The printer hard disk and the flash drive are supported only in select printer models.

From the printer control panel, select **Continue** to clear the message. For non-touch-screen printer models, press  to confirm.

Defective flash detected [51]

Try one or more of the following:

- Replace the defective flash memory card.
- From the printer control panel, select **Continue** to ignore the message and continue printing. For non-touch-screen printer models, press  to confirm.
- Cancel the current print job.

Error reading USB drive. Remove USB.

An unsupported USB device is inserted. Remove the USB device, and then insert a supported one.

Error reading USB hub. Remove hub.

An unsupported USB hub has been inserted. Remove the USB hub, and then install a supported one.

Incompatible tray [x] [59]

Remove, and then reinstall the indicated tray to clear the message.

Incorrect paper size, open [paper source] [34]

Note: The paper source can be a tray or a feeder.

Try one or more of the following:

- Load the correct size of paper in the paper source.
- From the printer control panel, select **Continue** to clear the message and print using a different paper source. For non-touch-screen printer models, press  to confirm.
- Check the length and width guides of the paper source and make sure the paper is loaded properly.
- Make sure the correct paper size and type are specified in the Printing Preferences or in the Print dialog.
- Make sure the paper size and type are specified in the Paper menu on the printer control panel.

- Make sure that the paper size is correctly set. For example, if Multipurpose Feeder Size is set to Universal, then make sure the paper is large enough for the data being printed.
- Cancel the print job.

Insert Tray [x]

Insert the indicated tray into the printer.

Insufficient memory, some Held Jobs were deleted [37]

The printer deleted some held jobs in order to process current jobs.

Select **Continue** to clear the message. For non-touch-screen printer models, press  to confirm.

Insufficient memory to collate job [37]

Try one or more of the following:

- From the printer control panel, select **Continue** to print the part of the job already stored and begin collating the rest of the print job. For non-touch-screen printer models, press  to confirm.
- Cancel the current print job.

Insufficient memory to support Resource Save feature [35]

Install additional printer memory or select **Continue** on the printer control panel to disable Resource Save, clear the message, and continue printing. For non-touch-screen printer models, press  to confirm.

Insufficient memory, some held jobs will not be restored [37]

Try one or more of the following:

- From the printer control panel, select **Continue** to clear the message. For non-touch-screen printer models, press  to confirm.
- Delete other held jobs to free up additional printer memory.

Load [paper source] with [custom type name]

Try one or more of the following:

- Load the tray or feeder with the correct size and type of paper.
- To use the tray with the correct paper size or type, select **Finished loading paper** on the printer control panel. For non-touch-screen printer models, press  to confirm.

Note: If the printer detects a tray that has the correct paper type and size, then it feeds from that tray. If the printer cannot detect a tray that has the correct paper type and size, then it prints from the default paper source.

- Cancel the current job.

Load [paper source] with [custom string]

Try one or more of the following:

- Load the indicated tray or feeder with the correct size and type of paper.
- To use the tray with the correct paper size or type, select **Finished loading paper** on the printer control panel. For non-touch-screen printer models, press  to confirm.

Note: If the printer finds a tray that has the correct paper type and size, then it feeds from that tray. If the printer cannot find a tray with the correct paper type and size, then it prints from the default paper source.

- Cancel the current job.

Load [paper source] with [paper size]

Try one or more of the following:

- Load the tray or feeder with the correct size of paper.
- To use the tray or feeder with the correct paper size, select **Finished loading paper** on the printer control panel. For non-touch-screen printer models, press  to confirm.

Note: If the printer detects a tray that has the correct paper size, then it feeds from that tray. If the printer cannot detect a tray that has the correct paper size, then it prints from the default paper source.

- Cancel the current job.

Load [paper source] with [paper type] [paper size]

Try one or more of the following:

- Load the tray or feeder with the correct size and type of paper.
- To use the tray or feeder with the correct paper size and type, select **Finished loading paper** on the printer control panel. For non-touch-screen printer models, press  to confirm.

Note: If the printer detects a tray that has the correct paper size and type, then it feeds from that tray. If the printer cannot detect a tray that has the correct paper size and type, then it prints from the default paper source.

- Cancel the current job.

Load Manual Feeder with [custom string]

Try one or more of the following:

- Load the feeder with the correct size and type of paper.
- Depending on your printer model, touch **Prompt each page, paper loaded** or press  on the printer control panel to clear the message and continue printing.
- Cancel the current job.

Load Manual Feeder with [custom type name]

Try one or more of the following:

- Load the feeder with the correct size and type of paper.
- Depending on your printer model, touch **Prompt each page, paper loaded** or press  on the printer control panel to clear the message and continue printing.
- Cancel the current job.

Load Manual Feeder with [paper size]

Try one or more of the following:

- Load the feeder with the correct size of paper.
- Depending on your printer model, touch **Prompt each page, paper loaded** or press  on the printer control panel to clear the message and continue printing.
- Cancel the current job.

Load Manual Feeder with [paper type] [paper size]

Try one or more of the following:

- Load the feeder with the correct size and type of paper.
- Depending on your printer model, touch **Prompt each page, paper loaded** or press  on the printer control panel to clear the message and continue printing.
- Cancel the current job.

Maintenance kit low [80.xy]

You may need to order a maintenance kit. For more information, visit the Lexmark support Web site at <http://support.lexmark.com> or contact customer support, and then report the message.

If necessary, select **Continue** to clear the message and continue printing. For non-touch-screen printer models, press  to confirm.

Maintenance kit nearly low [80.xy]

For more information, visit the Lexmark support Web site at <http://support.lexmark.com> or contact customer support, and then report the message.

If necessary, select **Continue** to clear the message and continue printing. For non-touch-screen printer models, press  to confirm.

Maintenance kit very low [80.xy]

You may need to replace the maintenance kit very soon. For more information, go to <http://support.lexmark.com> or contact customer support.

If necessary, press  on the printer control panel to clear the message and continue printing.

Memory full [38]

Try one or more of the following:

- From the printer control panel, select **Cancel job** to clear the message. For non-touch-screen printer models, press  to confirm.
- Install additional printer memory.

Network [x] software error [54]

Try one or more of the following:

- From the printer control panel, select **Continue** to continue printing. For non-touch-screen printer models, press  to confirm.
- Turn off the printer, wait for about 10 seconds, and then turn the printer back on.
- Update the network firmware in the printer or print server. For more information, visit the Lexmark support Web site at <http://support.lexmark.com>.

Not enough free space in flash memory for resources [52]

Try one or more of the following:

- From the printer control panel, select **Continue** to clear the message and continue printing. For non-touch-screen printer models, press  to confirm.
- Delete fonts, macros, and other data stored in the flash memory.
- Upgrade to a larger capacity flash memory card.

Note: Downloaded fonts and macros that are not previously stored in the flash memory are deleted.

Non-Lexmark [supply type], see User's Guide [33.xy]



Note: The supply type can be a toner cartridge or the imaging kit.

The printer has detected a non-Lexmark supply or part installed in the printer.

Your Lexmark printer is designed to function best with genuine Lexmark supplies and parts. Use of third-party supplies or parts may affect the performance, reliability, or life of the printer and its imaging components. For more information, see [“Using genuine Lexmark parts and supplies” on page 132](#).

All life indicators are designed to function with Lexmark supplies and parts, and may deliver unpredictable results if third-party supplies or parts are used. Imaging component usage beyond the intended life may damage your Lexmark printer or its associated components.

Warning—Potential Damage: Use of third-party supplies or parts can affect warranty coverage. Damage caused by the use of third-party supplies or parts may not be covered by the warranty.

To accept any and all of these risks, and to proceed with the use of non-genuine supplies or parts in your printer, press  and  on the control panel simultaneously for 15 seconds to clear the message and continue printing.

If you do not want to accept these risks, then remove the third-party supply or part from your printer and install a genuine Lexmark supply or part.

Note: For the list of supported supplies, see the “Ordering supplies” section or go to www.lexmark.com.

Printer had to restart. Last job may be incomplete.

From the printer control panel, press  to clear the message and continue printing.

For more information, go to <http://support.lexmark.com> or contact customer support.

Reinstall missing or unresponsive [color] cartridge [31.xy]

Try one or more of the following:

- Check if the toner cartridge is missing. If missing, then install the toner cartridge.
For information on installing the toner cartridge, see the “Replacing supplies” section.
- If the toner cartridge is installed, then remove and reinstall the unresponsive toner cartridge.

Note: If the message appears after reinstalling the supply, then replace the toner cartridge. The cartridge may be defective or a non-genuine Lexmark supply. For more information, see [“Using genuine Lexmark parts and supplies” on page 132](#).

Reinstall missing or unresponsive black and color imaging kit and all cartridges [31.xy]

Try one or more of the following:

- Check if the imaging kit is missing. If missing, then install the imaging kit.
For information on installing the imaging kit, see the “Replacing supplies” section.
- If the imaging kit is installed, then remove and reinstall the unresponsive imaging kit.

Note: If the message appears after reinstalling the supply, then replace the imaging kit. The imaging kit may be defective or a non-genuine Lexmark supply. For more information, see [“Using genuine Lexmark parts and supplies” on page 132](#).

Reload printed pages in Tray [x]

Try any of the following:

- From the printer control panel, select **Continue** to clear the message and continue printing the second side of the sheet. For non-touch-screen printer models, press  to confirm.
- Cancel the print job.

Remove packaging material, [area name]

- 1 Remove any remaining packing material from the indicated location.
- 2 From the printer control panel, touch **Continue** to clear the message. For non-touch-screen printer models, press  to confirm.

Remove paper from standard output bin

Remove the paper stack from the standard bin.

Replace [type] imaging kit, 0 estimated pages remain [84.xy]



Note: The type can be a black imaging kit, or a black and color imaging kit.

Replace the indicated imaging kit to clear the message and continue printing. For more information, see the instruction sheet that came with the supply.



Note: If you do not have a replacement imaging kit, then see the “Ordering supplies” section of the *User’s Guide* or visit www.lexmark.com.

Replace all originals if restarting job.

From the printer control panel, try one or more of the following:



- Select **Scan from automatic feeder**, and then press  to continue scanning from the ADF immediately after the last successful scan job.
- Select **Scan from flatbed**, and then press  to continue scanning from the scanner glass immediately after the last successful scan job.
- Select **Finish job without further scanning**, and then press  to end the last successful scan job.



Note: This does not cancel the scan job. All successfully scanned pages will be processed further for copying or e-mailing.

- Select **Restart Job**, and then press  to restart the scan job with the same settings from the previous scan job.
- Select **Cancel Job**, and then press  to clear the message and cancel the scan job.

Replace jammed originals if restarting job.

From the printer control panel, try one or more of the following:

- Select **Scan from automatic feeder**, and then press  to continue scanning from the ADF immediately after the last successful scan job.
- Select **Scan from flatbed**, and then press  to continue scanning from the scanner glass immediately after the last successful scan job.

- Select **Finish job without further scanning**, and then press  to end the last successful scan job.
Note: This does not cancel the scan job. All successfully scanned pages will be processed further for copying or e-mailing.
- Select **Restart Job**, and then press  to restart the scan job with the same settings from the previous scan job.
- Select **Cancel Job**, and then press  to clear the message and cancel the scan job.

Replace maintenance kit [80.xy]

The printer is scheduled for maintenance. For more information, go to <http://support.lexmark.com> or contact your service representative, and then report the message.

Replace missing [type] imaging kit [31.xy]

Note: The type can be a black imaging kit, or a black and color imaging kit.

Install the indicated imaging kit to clear the message. For more information, see the “Replacing supplies” section of the *User’s Guide*.

Replace missing waste toner bottle [31.xyz]

Install the missing waste toner bottle to clear the message. For more information, see the instruction sheet that came with the supply.

Replace unsupported [color] cartridge [32.xy]

Remove the toner cartridge, and then install a supported one to clear the message and continue printing. For more information, see the instruction sheet that came with the supply.

The following error codes indicate that a non-genuine Lexmark toner cartridge is installed:

32.13
32.16
32.19
32.22
32.25
32.28
32.31
32.34
32.37

For more information, see [“Using genuine Lexmark parts and supplies” on page 132](#).

Note: If you do not have a replacement cartridge, then see the “Ordering supplies” section or go to www.lexmark.com.

Replace unsupported black and color imaging kit [32.xy]

Remove the indicated imaging kit, and then install a supported one to clear the message and continue printing. For more information, see the instruction sheet that came with the supply.

The following error codes indicate that a non-genuine Lexmark imaging unit is installed:

32.00
32.01
32.02
32.07
32.08
32.09
32.36
32.37
32.51
32.52
32.55
32.56
32.57
32.58
32.59

For more information, see [“Using genuine Lexmark parts and supplies” on page 132](#).

Note: If you do not have a replacement imaging kit, then see the “Ordering supplies” section or go to www.lexmark.com.

Replace waste toner bottle [82.xy]

Replace the waste toner bottle to clear the message.

Scanner automatic feeder cover open

Close the ADF cover.

Scanner disabled by admin [840.01]

Print without the scanner, or contact your system support person.

Scanner disabled. Contact system administrator if problem persists. [840.02]

From the printer control panel, try one or more of the following:

- Select **Continue with scanner disabled** to return to the home screen, and then contact your system support person.
- Select **Reboot and automatically enable scanner** to cancel the job.

Note: This attempts to enable the scanner.

- For non-touch-screen printer models, press **OK** to confirm.

Scanner jam, remove all originals from the scanner [2yy.xx]

Remove the jammed paper from the scanner.

Scanner jam, remove jammed originals from the scanner [2yy.xx]

Remove the jammed paper from the scanner.

SMTP server not set up. Contact system administrator.

From the printer control panel, press **OK** to clear the message.

Note: If the message appears again, then contact your system support person.

Standard network software error [54]

Try one or more of the following:

- From the printer control panel, select **Continue** to continue printing. For non-touch-screen printer models, press **OK** to confirm.
- Turn off the printer and then turn it back on.
- Update the network firmware in the printer or print server. For more information, visit the Lexmark support Web site at <http://support.lexmark.com>.

Standard USB port disabled [56]

From the printer control panel, select **Continue** to clear the message. For non-touch-screen printer models, press **OK** to confirm.

Notes:

- The printer discards any data received through the USB port.
- Make sure the USB Buffer menu is not set to Disabled.

Supply needed to complete job

Try one or more of the following:

- From the printer control panel, touch **Prompt for supplies** to view all error messages that indicate what supplies are needed to continue processing the current job. For non-touch-screen printer models, press **OK** to clear the message and continue printing.
 - 1 Order the missing supply immediately.
 - 2 Install the supply. For more information, see the instruction sheet that came with the supply.
- Cancel the print job, then install the missing supply, and then resend the print job.

Too many flash options installed [58]

- 1 Turn off the printer.
- 2 Unplug the power cord from the electrical outlet.
- 3 Remove the extra flash memory.
- 4 Connect the power cord to a properly grounded electrical outlet.
- 5 Turn the printer back on.

Too many trays attached [58]

- 1 Turn off the printer.
- 2 Unplug the power cord from the electrical outlet.
- 3 Remove the extra trays.
- 4 Connect the power cord to a properly grounded electrical outlet.
- 5 Turn the printer back on.

[Type] imaging kit low [84.xy]

Note: The type can be a black imaging kit, or a black and color imaging kit.

You may need to order an imaging kit. If necessary, select **Continue** on the printer control panel to clear the message and continue printing. For non-touch-screen printer models, press  to confirm.

[Type] imaging kit nearly low [84.xy]

Note: The type can be a black imaging kit, or a black and color imaging kit.

If necessary, select **Continue** on the printer control panel to clear the message and continue printing. For non-touch-screen printer models, press  to confirm.

[Type] imaging kit very low, [x] estimated pages remain [84.xy]

Note: The type can be a black imaging kit, or a black and color imaging kit.

You may need to replace the imaging kit very soon. For more information, see the “Replacing supplies” section of the *User’s Guide*.

If necessary, select **Continue** on the printer control panel to clear the message and continue printing. For non-touch-screen printer models, press  to confirm.

Unformatted flash detected [53]

Try one or more of the following:

- From the printer control, select **Continue** to stop the defragmentation and continue printing. For non-touch-screen printer models, press **OK** to confirm.
- Format the flash memory.

Note: If the error message remains, then the flash memory may be defective and need to be replaced.

Waste toner bottle nearly full [82.xy]

You may need to order a waste toner bottle. If necessary, select **Continue** on the printer control panel to clear the message and continue printing. For non-touch-screen printer models, press **OK** to confirm.

Weblink server not set up. Contact system administrator.

From the printer control panel, press **OK** to clear the message.

Note: If the message appears again, then contact your system support person.

Solving printer problems

Basic printer problems

The printer is not responding

Action	Yes	No
<p>Step 1 Make sure the printer is turned on.</p> <p>Is the printer turned on?</p>	Go to step 2.	Turn on the printer.
<p>Step 2 Check if the printer is in Sleep mode or Hibernate mode.</p> <p>Is the printer in Sleep mode or Hibernate mode?</p>	Press the Sleep button to wake the printer from Sleep mode or Hibernate mode.	Go to step 3.
<p>Step 3 Check if one end of the power cord is plugged into the printer and the other to a properly grounded electrical outlet.</p> <p>Is the power cord plugged into the printer and a properly grounded electrical outlet?</p>	Go to step 4.	Plug one end of the power cord into the printer and the other to a properly grounded electrical outlet.

Action	Yes	No
<p>Step 4 Check other electrical equipment plugged into the electrical outlet.</p> <p>Does other electrical equipment work?</p>	<p>Unplug the other electrical equipment, and then turn on the printer. If the printer does not work, then reconnect the other electrical equipment.</p>	<p>Go to step 5.</p>
<p>Step 5 Check if the cables connecting the printer and the computer are inserted in the correct ports.</p> <p>Are the cables inserted in the correct ports?</p>	<p>Go to step 6.</p>	<p>Make sure to match the following:</p> <ul style="list-style-type: none"> • The USB symbol on the cable with the USB symbol on the printer • The appropriate Ethernet cable with the Ethernet port
<p>Step 6 Make sure the electrical outlet is not turned off by a switch or breaker.</p> <p>Is the electrical outlet turned off by a switch or breaker?</p>	<p>Turn on the switch or reset the breaker.</p>	<p>Go to step 7.</p>
<p>Step 7 Check if the printer is plugged into any surge protectors, uninterruptible power supplies, or extension cords.</p> <p>Is the printer plugged into any surge protectors, uninterruptible power supplies, or extension cords?</p>	<p>Connect the printer power cord directly to a properly grounded electrical outlet.</p>	<p>Go to step 8.</p>
<p>Step 8 Check if one end of the printer cable is plugged into a port on the printer and the other to the computer, print server, option, or other network device.</p> <p>Is the printer cable securely attached to the printer and the computer, print server, option, or other network device?</p>	<p>Go to step 9.</p>	<p>Connect the printer cable securely to the printer and the computer, print server, option, or other network device.</p>
<p>Step 9 Make sure to install all hardware options properly and remove any packing material.</p> <p>Are all hardware options properly installed and all packing material removed?</p>	<p>Go to step 10.</p>	<p>Turn off the printer, remove all packing materials, then reinstall the hardware options, and then turn on the printer.</p>
<p>Step 10 Check if you have selected the correct port settings in the printer driver.</p> <p>Are the port settings correct?</p>	<p>Go to step 11.</p>	<p>Use correct printer driver settings.</p>

Action	Yes	No
<p>Step 11 Check the installed printer driver.</p> <p>Is the correct printer driver installed?</p>	Go to step 12.	Install the correct printer driver.
<p>Step 12 Turn off the printer, then wait for about 10 seconds, and then turn the printer back on.</p> <p>Is the printer working?</p>	The problem is solved.	Contact customer support .

Printer display is blank

Action	Yes	No
<p>Step 1 Press the Sleep button on the printer control panel.</p> <p>Does Ready appear on the printer display?</p>	The problem is solved.	Go to step 2.
<p>Step 2 Turn off the printer, then wait for about 10 seconds, and then turn the printer back on.</p> <p>Do Please wait and Ready appear on the printer display?</p>	The problem is solved.	Turn off the printer, and then contact customer support .

Option problems

Cannot detect internal option

Action	Yes	No
<p>Step 1 Turn off the printer, then wait for about 10 seconds, and then turn on the printer.</p> <p>Does the internal option operate correctly?</p>	The problem is solved.	Go to step 2.
<p>Step 2 Check if the internal option is properly installed in the controller board.</p> <ul style="list-style-type: none"> a Turn off the printer using the power switch, and then unplug the power cord from the electrical outlet. b Make sure the internal option is installed in the appropriate connector in the controller board. c Connect the power cord to the printer, then to a properly grounded electrical outlet, and then turn on the printer. <p>Is the internal option properly installed in the controller board?</p>	Go to step 3.	Connect the internal option to the controller board.

Action	Yes	No
<p>Step 3</p> <p>Print a menu settings page, and then check to see if the internal option is listed in the Installed Features list.</p> <p>Is the internal option listed in the menu settings page?</p>	Go to step 4.	Reinstall the internal option.
<p>Step 4</p> <p>a Check if the internal option is selected.</p> <p>It may be necessary to manually add the internal option in the printer driver to make it available for print jobs. For more information, see “Adding available options in the print driver” on page 24.</p> <p>b Resend the print job.</p> <p>Does the internal option operate correctly?</p>	The problem is solved.	Contact customer support.

Tray problems

Action	Yes	No
<p>Step 1</p> <p>a Pull out the tray, and then do one or more of the following:</p> <ul style="list-style-type: none"> • Check for paper jams or misfeeds. • Check if the paper size indicators on the paper guides are aligned with the paper size indicators on the tray. • If you are printing on custom-size paper, then make sure that the paper guides rest against the edges of the paper. • Make sure the paper is below the maximum paper fill indicator. • Make sure paper lies flat in the tray. <p>b Check if the tray closes properly.</p> <p>Is the tray working?</p>	The problem is solved.	Go to step 2.
<p>Step 2</p> <p>a Turn off the printer, then wait about 10 seconds, and then turn the printer back on.</p> <p>b Resend the print job.</p> <p>Is the tray working?</p>	The problem is solved.	Go to step 3.
<p>Step 3</p> <p>Check if the tray is installed and recognized by the printer.</p> <p>Print a menu settings page, and then check if the tray is listed in the Installed Features list.</p> <p>Is the tray listed in the menu settings page?</p>	Go to step 4.	Reinstall the tray. For more information, see the setup documentation that came with the tray.

Action	Yes	No
<p>Step 4 Check if the tray is available in the printer driver.</p> <p>Note: If necessary, manually add the tray in the printer driver to make it available for print jobs. For more information, see “Adding available options in the print driver” on page 24.</p> <p>Is the tray available in the printer driver?</p>	The problem is solved.	Contact customer support .

Paper feed problems

Jammed pages are not reprinted



Action	Yes	No
<p>a Turn on jam recovery.</p> <ol style="list-style-type: none"> From the printer control panel, navigate to: Settings > General Settings > Print Recovery > Jam Recovery Select On or Auto. Depending on your printer model, press  or touch Submit. <p>b Resend the pages that did not print.</p> <p>Were the jammed pages reprinted?</p>	The problem is solved.	Contact customer support .

Paper frequently jams

Action	Yes	No
<p>Step 1</p> <p>a Pull out the tray, and then do one or more of the following:</p> <ul style="list-style-type: none"> Make sure paper lies flat in the tray. Check if the paper size indicators on the paper guides are aligned with the paper size indicators on the tray. Check if the paper guides are aligned against the edges of the paper. Make sure the paper is below the maximum paper fill indicator. Check if you are printing on a recommended paper size and type. <p>b Insert the tray properly.</p> <p>If jam recovery is enabled, then the print jobs will reprint automatically.</p> <p>Do paper jams still occur frequently?</p>	Go to step 2.	The problem is solved.

Action	Yes	No
<p>Step 2</p> <p>a Load paper from a fresh package.</p> <p>Note: Paper absorbs moisture due to high humidity. Store paper in its original wrapper until you use it.</p> <p>b Resend the print job.</p> <p>Do paper jams still occur frequently?</p>	Go to step 3.	The problem is solved.
<p>Step 3</p> <p>a Review the tips on avoiding jams. For more information, see “Avoiding jams” on page 158.</p> <p>b Follow the recommendations, and then resend the print job.</p> <p>Do paper jams still occur frequently?</p>	Contact customer support .	The problem is solved.

Paper jam message remains after jam is cleared

Action	Yes	No
<p>a Do either of the following:</p> <ul style="list-style-type: none"> For touch-screen printer models, touch  or Done. For non-touch-screen printer models, select Next >  > <p>Clear the jam, press OK >  .</p> <p>b Follow the instructions on the printer display.</p> <p>Does the paper jam message remain?</p>	Contact customer support .	The problem is solved.

Solving print problems

Printing problems

Confidential and other held jobs do not print

Note: Confidential, Verify, Reserve, and Repeat print jobs may be deleted if the printer requires extra memory to process additional held jobs.

Action	Yes	No
<p>Step 1</p> <p>Open the held jobs folder on the printer display, and then verify that your print job is listed.</p> <p>Is your print job listed in the held jobs folder?</p>	Go to step 2.	Select one of the Print and Hold options, and then resend the print job. For more information, see “Printing held jobs” on page 53.
<p>Step 2</p> <p>The print job may contain a formatting error or invalid data.</p> <ul style="list-style-type: none"> • Delete the print job, and then send it again. • For PDF files, generate a new PDF, and then print it again. <p>If you are printing from the Internet, then the printer may be reading multiple job titles as duplicates and deleting all jobs except the first one.</p> <p>For Windows users</p> <ol style="list-style-type: none"> Open the Print Properties folder. From the Print and Hold dialog, select the “Keep duplicate documents” check box. Enter a PIN number. <p>For Macintosh users</p> <p>Save each print job, name each job differently, and then send the individual jobs to the printer.</p> <p>Does the job print?</p>	The problem is solved.	Go to step 3.
<p>Step 3</p> <p>Free up additional printer memory by deleting some of the held jobs.</p> <p>Does the job print?</p>	The problem is solved.	Add additional printer memory.

Incorrect characters print

Action	Yes	No
<p>Step 1 Make sure the printer is not in Hex Trace mode.</p> <p>Note: If Ready Hex appears on the printer display, then turn off the printer, and then turn it back on to deactivate Hex Trace mode.</p> <p>Is the printer in Hex Trace mode?</p>	Deactivate Hex Trace mode.	Go to step 2.
<p>Step 2</p> <p>a From the printer control panel, select Standard Network or Network [x], and then set SmartSwitch to On.</p> <p>b Resend the print job.</p> <p>Do incorrect characters print?</p>	Contact customer support .	The problem is solved.

Job prints from the wrong tray or on the wrong paper

Action	Yes	No
<p>Step 1</p> <p>a Check if you are printing on paper that is supported by the tray.</p> <p>b Resend the print job.</p> <p>Did the job print from the correct tray or on the correct paper?</p>	The problem is solved.	Go to step 2.
<p>Step 2</p> <p>a From the Paper menu on the printer control panel, set the paper size and type to match the paper loaded in the tray.</p> <p>b Resend the print job.</p> <p>Did the job print from the correct tray or on the correct paper?</p>	The problem is solved.	Go to step 3.
<p>Step 3</p> <p>a Depending on your operating system, open Printing Preferences or the Print dialog, and then specify the paper type.</p> <p>b Resend the print job.</p> <p>Did the job print from the correct tray or on the correct paper?</p>	The problem is solved.	Go to step 4.
<p>Step 4</p> <p>a Check if the trays are not linked.</p> <p>b Resend the print job.</p> <p>Did the job print from the correct tray or on the correct paper?</p>	The problem is solved.	Contact customer support .

Large jobs do not collate

Action	Yes	No
<p>Step 1</p> <p>a From the Finishing menu on the printer control panel, set Collate to (1,2,3) (1,2,3).</p> <p>b Resend the print job.</p> <p>Did the job print and collate correctly?</p>	The problem is solved.	Go to step 2.
<p>Step 2</p> <p>a From the printer software, set Collate to (1,2,3) (1,2,3).</p> <p>Note: Setting Collate to (1,1,1) (2,2,2) in the software overrides the setting in the Finishing menu.</p> <p>b Resend the print job.</p> <p>Did the job print and collate correctly?</p>	The problem is solved.	Go to step 3.
<p>Step 3</p> <p>Reduce the complexity of the print job by eliminating the number and size of fonts, the number and complexity of images, and the number of pages in the job.</p> <p>Did the job print and collate correctly?</p>	The problem is solved.	Contact customer support .

Multiple-language PDF files do not print

Action	Yes	No
<p>Step 1</p> <p>a Check if the print options for the PDF output are set to embed all fonts.</p> <p>For more information, see the documentation that came with Adobe Acrobat.</p> <p>b Generate a new PDF file, and then resend the print job.</p> <p>Do the files print?</p>	The problem is solved.	Go to step 2.
<p>Step 2</p> <p>a Open the document you want to print in Adobe Acrobat.</p> <p>b Click File > Print > Advanced > Print As Image > OK > OK.</p> <p>Do the files print?</p>	The problem is solved.	Contact customer support .

Print jobs do not print

Action	Yes	No
<p>Step 1</p> <p>a From the document you are trying to print, open the Print dialog and check if you have selected the correct printer.</p> <p>Note: If the printer is not the default printer, then you must select the printer for each document that you want to print.</p> <p>b Resend the print job.</p> <p>Do the jobs print?</p>	The problem is solved.	Go to step 2.
<p>Step 2</p> <p>a Check if the printer is plugged in and turned on, and if Ready appears on the printer display.</p> <p>b Resend the print job.</p> <p>Do the jobs print?</p>	The problem is solved.	Go to step 3.
<p>Step 3</p> <p>If an error message appears on the printer display, then clear the message.</p> <p>Note: The printer continues to print after clearing the message.</p> <p>Do the jobs print?</p>	The problem is solved.	Go to step 4.
<p>Step 4</p> <p>a Check if the ports (USB, serial, or Ethernet) are working and if the cables are securely connected to the computer and the printer.</p> <p>Note: For more information, see the setup documentation that came with the printer.</p> <p>b Resend the print job.</p> <p>Do the jobs print?</p>	The problem is solved.	Go to step 5.
<p>Step 5</p> <p>a Turn off the printer, then wait for about 10 seconds, and then turn the printer back on.</p> <p>b Resend the print job.</p> <p>Do the jobs print?</p>	The problem is solved.	Go to step 6.
<p>Step 6</p> <p>a Remove, and then reinstall the printer software. For more information, see “Installing the printer software” on page 23.</p> <p>Note: The printer software is available at http://support.lexmark.com.</p> <p>b Resend the print job.</p> <p>Do the jobs print?</p>	The problem is solved.	Contact customer support .

Print job takes longer than expected

Action	Yes	No
<p>Step 1 Change the environmental settings of the printer.</p> <p>a From the printer control panel, navigate to: Settings > General Settings</p> <p>b Select Eco-Mode or Quiet Mode, and then select Off.</p> <p>Note: Disabling Eco-Mode or Quiet Mode may increase the consumption of energy or supplies, or both.</p> <p>Did the job print?</p>	The problem is solved.	Go to step 2.
<p>Step 2 Reduce the number and size of fonts, the number and complexity of images, and the number of pages in the print job, and then resend the job</p> <p>Did the job print?</p>	The problem is solved.	Go to step 3.
<p>Step 3 a Remove held jobs stored in the printer memory. b Resend the print job.</p> <p>Did the job print?</p>	The problem is solved.	Go to step 4.
<p>Step 4 a Disable the Page Protect feature. From the printer control panel, navigate to: Settings > General Settings > Print Recovery > Page Protect > Off</p> <p>b Resend the print job.</p> <p>Did the job print?</p>	The problem is solved.	Go to step 5.
<p>Step 5 a Check if the cable connections to the printer and print server are secure. For more information, see the setup documentation that came with the printer. b Resend the print job.</p> <p>Did the job print?</p>	The problem is solved.	Go to step 6.
<p>Step 6 Install additional printer memory, and then resend the print job.</p> <p>Did the job print?</p>	The problem is solved.	Contact customer support .

Tray linking does not work

Notes:

- The trays can detect paper length.
- The multipurpose feeder does not automatically detect the paper size. You must set the size from the Paper Size/Type menu.

Action	Yes	No
<p>Step 1</p> <p>a Open the trays, and then check if they contain paper of the same size and type.</p> <ul style="list-style-type: none"> • Check if the paper guides are in the correct positions for the size of the paper loaded in each tray. • Check if the paper size indicators on the paper guides are aligned with the paper size indicators on the tray. <p>b Resend the print job.</p> <p>Do the trays link correctly?</p>	The problem is solved.	Go to step 2.
<p>Step 2</p> <p>a From the printer control panel, set the paper size and type in the Paper menu to match the paper loaded in the trays to be linked.</p> <p>Note: The paper size and type must match for trays to be linked.</p> <p>b Resend the print job.</p> <p>Do the trays link correctly?</p>	The problem is solved.	Contact customer support .

Unexpected page breaks occur

Action	Yes	No
<p>Step 1</p> <p>Adjust the print timeout settings.</p> <p>a From the printer control panel, navigate to: Settings > General Settings > Timeouts > Print Timeout</p> <p>b Select a higher setting and then, depending on your printer model, select  or Submit.</p> <p>c Resend the print job.</p> <p>Did the file print correctly?</p>	The problem is solved.	Go to step 2.
<p>Step 2</p> <p>a Check the original file for manual page breaks.</p> <p>b Resend the print job.</p> <p>Did the file print correctly?</p>	The problem is solved.	Contact customer support .

Print quality problems

Characters have jagged or uneven edges

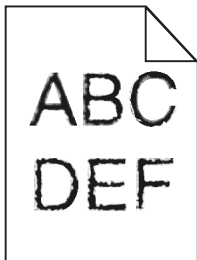

Action	Yes	No
<p>Step 1</p> <p>a Print a font sample list to check if the fonts you are using are supported by the printer.</p> <p>1 From the printer control panel, navigate to: Menus > Reports > Print Fonts</p> <p>2 Select PCL Fonts or PostScript Fonts.</p> <p>b Resend the print job.</p> <p>Are you using fonts that are supported by the printer?</p>	Go to step 2.	Select a font that is supported by the printer.
<p>Step 2</p> <p>Check if the fonts installed on the computer are supported by the printer.</p> <p>Are the fonts installed on the computer supported by the printer?</p>	The problem is solved.	Contact customer support .

Clipped pages or images

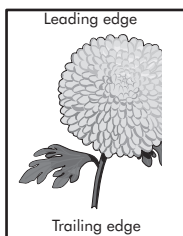
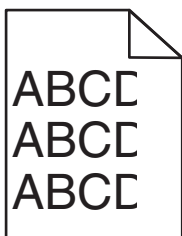

Action	Yes	No
<p>Step 1</p> <p>a Move the width and length guides in the tray to the correct positions for the paper loaded.</p> <p>b Resend the print job.</p> <p>Is the page or image clipped?</p>	Go to step 2.	The problem is solved.

Action	Yes	No
<p>Step 2</p> <p>From the printer control panel, set the paper size and type in the Paper menu to match the paper loaded in the tray.</p> <p>Does the paper size match the paper loaded in the tray?</p>	Go to step 3.	<p>Do one or more of the following:</p> <ul style="list-style-type: none"> From the printer control panel, change the paper size to match the paper loaded in the tray. From the printer control panel, change the paper type to match the paper loaded in the tray.
<p>Step 3</p> <p>a Depending on your operating system, specify the paper size from Printing Preferences or from the Print dialog.</p> <p>b Resend the print job.</p> <p>Is the page or image clipped?</p>	Go to step 4.	The problem is solved.
<p>Step 4</p> <p>a Remove, and then reinstall the imaging kit.</p> <p>Warning—Potential Damage: Do not expose the imaging kit to direct light for more than 10 minutes. Extended exposure to light may cause print quality problems.</p> <p>Warning—Potential Damage: Do not touch the underside of the imaging kit. This could damage the imaging kit.</p> <p>b Resend the print job.</p> <p>Is the page or image clipped?</p>	Contact customer support .	The problem is solved.

Gray background on prints

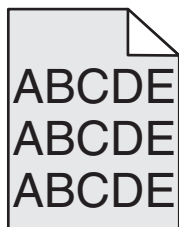

Action	Yes	No
<p>Step 1 Reduce the toner darkness.</p> <p>a From the Quality menu on the printer control panel, reduce the toner density.</p> <p>Note: 4 is the factory default setting.</p> <p>b Resend the print job.</p> <p>Did the gray background disappear?</p>	The problem is solved.	Go to step 2.
<p>Step 2</p> <p>a Remove, and then reinstall the imaging kit.</p> <p>Warning—Potential Damage: Do not expose the imaging kit to direct light for more than 10 minutes. Extended exposure to light may cause print quality problems.</p> <p>Warning—Potential Damage: Do not touch the underside of the imaging kit. This could damage the imaging kit.</p> <p>b Resend the print job.</p> <p>Did the gray background disappear?</p>	The problem is solved.	Contact customer support .

Horizontal voids appear on prints

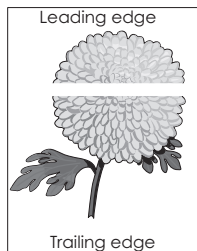

Action	Yes	No
<p>Step 1</p> <p>a Make sure your software program is using a correct fill pattern.</p> <p>b Resend the print job.</p> <p>Do horizontal voids appear on prints?</p>	Go to step 2.	The problem is solved.
<p>Step 2</p> <p>a Load the specified tray or feeder with a recommended type of paper.</p> <p>b Resend the print job.</p> <p>Do horizontal voids appear on prints?</p>	Go to step 3.	The problem is solved.

Action	Yes	No
<p>Step 3</p> <p>a Remove, and then reinstall the imaging kit.</p> <p>Warning—Potential Damage: Do not expose the imaging kit to direct light for more than 10 minutes. Extended exposure to light may cause print quality problems.</p> <p>Warning—Potential Damage: Do not touch the underside of the imaging kit. This could damage the imaging kit.</p> <p>b Resend the print job.</p> <p>Do horizontal voids appear on prints?</p>	Go to step 4.	The problem is solved.
<p>Step 4</p> <p>Replace the imaging kit, and then resend the print job.</p> <p>Do horizontal voids appear on prints?</p>	Contact customer support .	The problem is solved.

Incorrect margins on prints

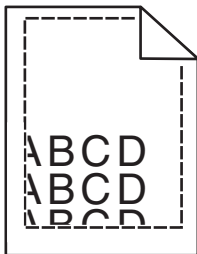

Action	Yes	No
<p>Step 1</p> <p>a Move the width and length guides in the tray to the correct positions for the paper size loaded.</p> <p>b Resend the print job.</p> <p>Are the margins correct?</p>	The problem is solved.	Go to step 2.
<p>Step 2</p> <p>From the printer control panel, set the paper size in the Paper menu to match the paper loaded in the tray.</p> <p>Does the paper size match the paper loaded in the tray?</p>	Go to step 3.	<p>Do one or more of the following:</p> <ul style="list-style-type: none"> Specify the paper size from the tray settings to match the paper loaded in the tray. Change the paper loaded in the tray to match the paper size specified in the tray settings.

Action	Yes	No
<p>Step 3</p> <p>a Depending on your operating system, specify the paper size from Printing Preferences or from the Print dialog.</p> <p>b Resend the print job.</p> <p>Are the margins correct?</p>	<p>The problem is solved.</p>	<p>Contact customer support.</p>

Paper curl

Action	Yes	No
<p>Step 1</p> <p>Move the width and length guides in the tray to the correct positions for the size of the paper loaded.</p> <p>Are the width and length guides positioned correctly?</p>	<p>Go to step 2.</p>	<p>Adjust the width and length guides.</p>
<p>Step 2</p> <p>From the printer control panel, set the paper type and weight in the Paper menu to match the paper loaded in the tray.</p> <p>Do the paper type and weight match the type and weight of the paper in the tray?</p>	<p>Go to step 3.</p>	<p>Specify the paper type and weight from the tray settings to match the paper loaded in the tray.</p>
<p>Step 3</p> <p>a Depending on your operating system, specify the paper type and weight from Printing Preferences or from the Print dialog.</p> <p>b Resend the print job.</p> <p>Is the paper still curled?</p>	<p>Go to step 4.</p>	<p>The problem is solved.</p>
<p>Step 4</p> <p>a Remove the paper from the tray, and then turn it over.</p> <p>b Resend the print job.</p> <p>Is the paper still curled?</p>	<p>Go to step 5.</p>	<p>The problem is solved.</p>
<p>Step 5</p> <p>a Load paper from a fresh package.</p> <p>Note: Paper absorbs moisture due to high humidity. Store paper in its original wrapper until you use it.</p> <p>b Resend the print job.</p> <p>Is the paper still curled?</p>	<p>Contact customer support.</p>	<p>The problem is solved.</p>

Print irregularities

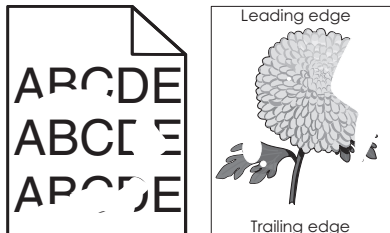

Action	Yes	No
<p>Step 1</p> <p>a Move the width and length guides in the tray to the correct positions for the size of the paper loaded in the tray.</p> <p>b Resend the print job.</p> <p>Do print irregularities still appear?</p>	Go to step 2.	The problem is solved.
<p>Step 2</p> <p>From the printer control panel, set the paper size and type in the Paper menu to match the paper loaded in the tray.</p> <p>Is the tray set to the size and type of the paper loaded in the tray?</p>	Go to step 3.	<p>Do one or more of the following:</p> <ul style="list-style-type: none"> Specify the paper size from the tray settings to match the paper loaded in the tray. Change the paper loaded in the tray to match the paper size specified in the tray settings.
<p>Step 3</p> <p>a Depending on your operating system, specify the paper type and weight from Printing Preferences or from the Print dialog.</p> <p>b Resend the print job.</p> <p>Do print irregularities still appear?</p>	Go to step 4.	The problem is solved.
<p>Step 4</p> <p>Check if the paper loaded in the tray has texture or rough finishes.</p> <p>Are you printing on textured or rough paper?</p>	From the printer control panel, set the paper texture in the Paper menu to match the paper loaded in the tray.	Go to step 5.

Action	Yes	No
<p>Step 5</p> <p>a Load paper from a fresh package.</p> <p>Note: Paper absorbs moisture due to high humidity. Store paper in its original wrapper until you use it.</p> <p>b Resend the print job.</p> <p>Do print irregularities still appear?</p>	Go to step 6.	The problem is solved.
<p>Step 6</p> <p>Replace the imaging kit, and then resend the print job.</p> <p>Do print irregularities still appear?</p>	Contact customer support .	The problem is solved.

Print is too dark

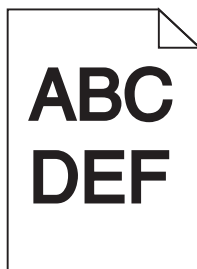

Action	Yes	No
<p>Step 1</p> <p>a From the Quality menu on the printer control panel, select Color Adjust.</p> <p>b Resend the print job.</p> <p>Is the print still too dark?</p>	Go to step 2.	The problem is solved.
<p>Step 2</p> <p>a From the Quality menu on the printer control panel, reduce the toner darkness.</p> <p>Note: 4 is the factory default setting.</p> <p>b Resend the print job.</p> <p>Is the print still too dark?</p>	Go to step 3.	The problem is solved.
<p>Step 3</p> <p>a From the printer control panel, set the paper type, texture, and weight in the Paper menu to match the paper loaded in the tray.</p> <p>b Resend the print job.</p> <p>Is the tray set to the type, texture, and weight of the paper loaded?</p>	Go to step 4.	Change the paper loaded in the tray to match the paper type, texture, and weight specified in the tray settings.

Action	Yes	No
<p>Step 4</p> <p>a Depending on your operating system, specify the paper type, texture and weight from Printing Preferences or from the Print dialog.</p> <p>b Resend the print job.</p> <p>Is the print still too dark?</p>	Go to step 5.	The problem is solved.
<p>Step 5</p> <p>Check if the paper loaded in the tray has texture or rough finishes.</p> <p>Are you printing on textured or rough paper?</p>	From the printer control panel, set the paper texture in the Paper menu to match the paper loaded on the tray.	Go to step 6.
<p>Step 6</p> <p>a Load paper from a fresh package.</p> <p>Note: Paper absorbs moisture due to high humidity. Store paper in its original wrapper until you use it.</p> <p>b Resend the print job.</p> <p>Is the print still too dark?</p>	Go to step 7.	The problem is solved.
<p>Step 7</p> <p>Replace the imaging kit, and then resend the print job.</p> <p>Is the print still too dark?</p>	Contact customer support .	The problem is solved.

Print is too light

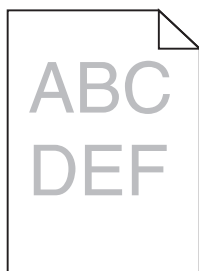

Action	Yes	No
<p>Step 1</p> <p>a From the Quality menu on the printer control panel, select Color Adjust.</p> <p>b Resend the print job.</p> <p>Is the print still too light?</p>	Go to step 2.	The problem is solved.

Action	Yes	No
<p>Step 2</p> <p>a From the Quality menu on the printer control panel, increase the toner darkness.</p> <p>Note: 4 is the factory default setting.</p> <p>b Resend the print job.</p> <p>Is the print still too light?</p>	Go to step 3.	The problem is solved.
<p>Step 3</p> <p>From the printer control panel, set the paper type, texture, and weight in the Paper menu to match the paper loaded in the tray.</p> <p>Is the tray set to the type, texture, and weight of the paper loaded?</p>	Go to step 4.	Specify the paper type, texture, and weight from the tray settings to match the paper loaded in the tray.
<p>Step 4</p> <p>a Depending on your operating system, specify the paper type, texture, and weight from Printing Preferences or from the Print dialog.</p> <p>b Resend the print job.</p> <p>Is the print still too light?</p>	Go to step 5.	The problem is solved.
<p>Step 5</p> <p>Make sure that the paper has no texture or rough finishes.</p> <p>Are you printing on textured or rough paper?</p>	From the printer control panel, set the paper texture in the Paper menu to match the paper loaded in the tray	Go to step 5.
<p>Step 6</p> <p>a Load paper from a fresh package.</p> <p>Note: Paper absorbs moisture due to high humidity. Store paper in its original wrapper until you use it.</p> <p>b Resend the print job.</p> <p>Is the print still too light?</p>	Go to step 7.	The problem is solved.
<p>Step 7</p> <p>Replace the imaging kit, and then resend the print job.</p> <p>Is the print still too light?</p>	Contact customer support .	The problem is solved.

Printer is printing blank pages

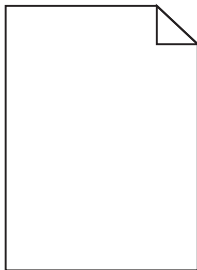

Action	Yes	No
<p>Step 1</p> <p>a Check if there is packing material left on the imaging kit.</p> <ol style="list-style-type: none"> 1 Remove the imaging kit. 2 Check if the packing material is properly removed from the imaging kit. <p>Warning—Potential Damage: Do not expose the imaging kit to direct light for more than 10 minutes. Extended exposure to light may cause print quality problems.</p> <p>Warning—Potential Damage: Do not touch the underside of the imaging kit. This could damage the imaging kit.</p> <ol style="list-style-type: none"> 3 Reinstall the imaging kit. <p>b Resend the print job.</p> <p>Is the printer still printing blank pages?</p>	<p>Go to step 2.</p>	<p>The problem is solved.</p>
<p>Step 2</p> <p>Replace the imaging kit, and then resend the print job.</p> <p>Is the printer still printing blank pages?</p>	<p>Contact customer support.</p>	<p>The problem is solved.</p>

Printer is printing solid black pages



Action	Yes	No
<p>Step 1</p> <p>a Remove, and then reinstall the imaging kit.</p> <p>Warning—Potential Damage: Do not expose the imaging kit to direct light for more than 10 minutes. Extended exposure to light may cause print quality problems.</p> <p>Warning—Potential Damage: Do not touch the underside of the imaging kit. This could damage the imaging kit.</p> <p>b Resend the print job.</p> <p>Is the printer printing solid black pages?</p>	Go to step 2.	The problem is solved.
<p>Step 2</p> <p>Replace the imaging kit, and then resend the print job.</p> <p>Is the printer printing solid black pages?</p>	Contact customer support .	The problem is solved.

Repeating defects appear on prints

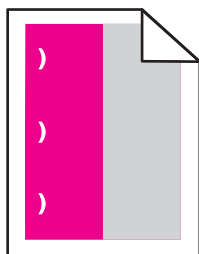

Action	Yes	No
<p>a Check if the distance between the defects is equal to one of the following:</p> <ul style="list-style-type: none"> • 25.1 mm (0.98 in.) • 29.8 mm (1.17 in.) • 43.9 mm (1.72 in.) • 45.5 mm (1.79 in.) • 94.2 mm (3.70 in.) <p>b If the distance between the defects equals 25.1 mm (0.98 in.), 29.8 mm (1.17 in.), or 94.2 mm (3.70 in.), then replace the photoconductor unit.</p> <p>c If the distance between the defects equals 43.9 mm (1.72 in.) or 45.5 mm (1.79 in.), then replace the developer unit.</p> <p>Do the repeating defects still appear?</p>	<p>1 Check if the distance between the defects is equal to one of the following:</p> <ul style="list-style-type: none"> • 37.7 mm (1.48 in.) • 78.5 mm (3.09 in.) • 95 mm (3.74 in.) <p>2 Take note of the distance, and then contact customer support or your service representative.</p>	The problem is solved.

Shadow images appear on prints

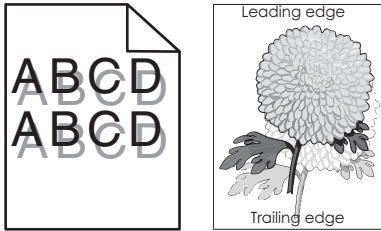

Action	Yes	No
<p>Step 1 Check if the paper loaded in the tray has the correct paper type and weight.</p> <p>Is paper with the correct paper type and weight loaded in the tray?</p>	Go to step 2.	Load paper with the correct paper type and weight in the tray.
<p>Step 2 From the printer control panel, set the paper type and weight in the Paper menu to match the paper loaded in the tray.</p> <p>Do the printer settings match the type and weight of the paper loaded?</p>	Go to step 3.	Change the paper type and weight to match the paper loaded in the tray.
<p>Step 3</p> <ul style="list-style-type: none"> a Depending on your operating system, specify the paper type and weight from Printing Preferences or from the Print dialog. b Resend the print job. <p>Do shadow images still appear on prints?</p>	Go to step 4.	The problem is solved.
<p>Step 4 Replace the imaging kit, and then resend the print job.</p> <p>Do shadow images still appear on prints?</p>	Contact customer support .	The problem is solved.

Skewed print

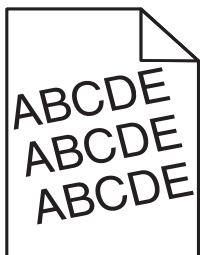

Action	Yes	No
<p>Step 1</p> <p>a Move the width and length guides in the tray to the correct positions for the size of the paper loaded.</p> <p>b Resend the print job.</p> <p>Is the print still skewed?</p>	Go to step 2.	The problem is solved.
<p>Step 2</p> <p>a Check if you are printing on a paper that is supported by the tray.</p> <p>b Resend the print job.</p> <p>Is the print still skewed?</p>	Contact customer support .	The problem is solved.

Streaked horizontal lines appear on prints

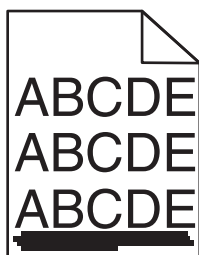

Action	Yes	No
<p>Step 1</p> <p>a Depending on your operating system, specify the tray or feeder from Printing Preferences or the Print dialog.</p> <p>b Resend the print job.</p> <p>Do streaked horizontal lines appear on prints?</p>	Go to step 2.	The problem is solved.
<p>Step 2</p> <p>From the printer control panel, set the paper type and weight in the Paper menu to match the paper loaded in the tray.</p> <p>Do the paper type and weight match the paper in the tray?</p>	Go to step 3.	<p>Do one or more of the following:</p> <ul style="list-style-type: none"> Specify the paper type and weight from the tray settings to match the paper loaded in the tray. Change the paper loaded in the tray to match the paper type and weight specified in the tray settings.

Action	Yes	No
<p>Step 3</p> <p>a Load paper from a fresh package.</p> <p>Note: Paper absorbs moisture due to high humidity. Store paper in its original wrapper until you use it.</p> <p>b Resend the print job.</p> <p>Do streaked horizontal lines appear on prints?</p>	Go to step 4.	The problem is solved.
<p>Step 4</p> <p>a Remove, and then reinstall the imaging kit.</p> <p>Warning—Potential Damage: Do not expose the imaging kit to direct light for more than 10 minutes. Extended exposure to light may cause print quality problems.</p> <p>Warning—Potential Damage: Do not touch the underside of the imaging kit. This could damage the imaging kit.</p> <p>b Resend the print job.</p> <p>Do streaked horizontal lines appear on prints?</p>	Go to step 5.	The problem is solved.
<p>Step 5</p> <p>Replace the imaging kit, and then resend the print job.</p> <p>Do streaked horizontal lines appear on prints?</p>	Contact customer support .	The problem is solved.

Streaked vertical lines appear on prints

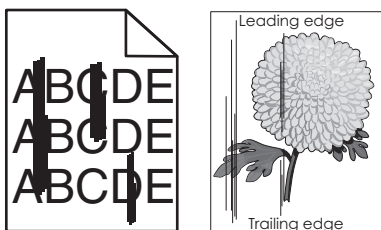

Action	Yes	No
<p>Step 1</p> <p>a Depending on your operating system, specify the paper type, texture, and weight from Printing Preferences or from the Print dialog.</p> <p>b Resend the print job.</p> <p>Do streaked vertical lines appear on prints?</p>	Go to step 2.	The problem is solved.

Action	Yes	No
<p>Step 2</p> <p>From the printer control panel, set the paper texture, type, and weight in the Paper menu to match the paper loaded in the tray.</p> <p>Do the paper texture, type, and weight match the paper in the tray?</p>	Go to step 3.	<p>Do one or more of the following:</p> <ul style="list-style-type: none"> Specify the paper texture, type, and weight from the tray settings to match the paper loaded in the tray. Change the paper loaded in the tray to match the paper size specified in the tray settings.
<p>Step 3</p> <p>a Load paper from a fresh package.</p> <p>Note: Paper absorbs moisture due to high humidity. Store paper in its original wrapper until you use it.</p> <p>b Resend the print job.</p> <p>Do streaked vertical lines appear on prints?</p>	Go to step 4.	The problem is solved.
<p>Step 4</p> <p>a Remove, and then reinstall the imaging kit.</p> <p>Warning—Potential Damage: Do not expose the imaging kit to direct light for more than 10 minutes. Extended exposure to light may cause print quality problems.</p> <p>Warning—Potential Damage: Do not touch the underside of the imaging kit. This could damage the imaging kit.</p> <p>b Resend the print job.</p> <p>Do streaked vertical lines appear on prints?</p>	Go to step 5.	The problem is solved.
<p>Step 5</p> <p>Replace the imaging kit, and then resend the print job.</p> <p>Do streaked vertical lines appear on prints?</p>	Contact customer support .	The problem is solved.

Toner fog or background shading appears on prints

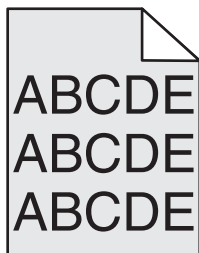

Action	Yes	No
<p>Step 1</p> <p>a Remove, and then reinstall the imaging kit.</p> <p>Warning—Potential Damage: Do not expose the imaging kit to direct light for more than 10 minutes. Extended exposure to light may cause print quality problems.</p> <p>Warning—Potential Damage: Do not touch the underside of the imaging kit. This could damage the imaging kit.</p> <p>b Resend the print job.</p> <p>Does fog or shading disappear from the prints?</p>	The problem is solved.	Go to step 2.
<p>Step 2</p> <p>Replace the imaging kit, and then resend the print job.</p> <p>Does fog or shading disappear from the prints?</p>	The problem is solved.	Contact customer support .

Toner rubs off

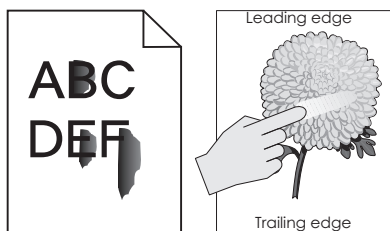

Action	Yes	No
<p>Step 1</p> <p>From the Paper menu on the printer control panel, check the paper type, texture, and weight.</p> <p>Do the paper type, texture, and weight match the paper loaded in the tray?</p>	Go to step 2.	Specify the paper type, texture, and weight from the tray settings to match the paper loaded in the tray.
<p>Step 2</p> <p>Resend the print job.</p> <p>Does the toner still rub off?</p>	Contact customer support .	The problem is solved.

Transparency print quality is poor

Action	Yes	No
<p>Step 1 From the printer control panel, set the paper type in the Paper menu to match the paper loaded in the tray.</p> <p>Is the paper type for the tray set to Transparency?</p>	Go to step 2.	Set the paper type to Transparency.
<p>Step 2 a Check if you are using a recommended type of transparency. b Resend the print job.</p> <p>Is the print quality still poor?</p>	Contact customer support .	The problem is solved.

Uneven print density

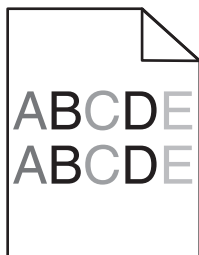

Action	Yes	No
<p>Replace the imaging kit, and then resend the print job.</p> <p>Is the print density uneven?</p>	Contact customer support .	The problem is solved.

Vertical voids appear on prints

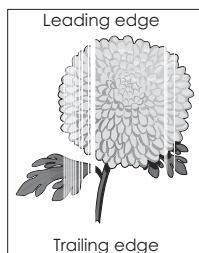

Action	Yes	No
<p>Step 1 a Check if your software program is using a correct fill pattern. b Resend the print job.</p> <p>Do vertical voids appear on prints?</p>	Go to step 2.	The problem is solved.

Action	Yes	No
<p>Step 2</p> <p>a From the Paper Menu on the printer control panel, check the paper type and paper weight.</p> <p>b Resend the print job.</p> <p>Do vertical voids appear on prints?</p>	Go to step 3.	The problem is solved.
<p>Step 3</p> <p>Check if you are using a recommended type of paper.</p> <p>a Load paper source with a recommended type of paper.</p> <p>b Resend the print job.</p> <p>Do vertical voids appear on prints?</p>	Go to step 4.	The problem is solved.
<p>Step 4</p> <p>a Remove, and then reinstall the imaging kit.</p> <p>Warning—Potential Damage: Do not expose the imaging kit to direct light for more than 10 minutes. Extended exposure to light may cause print quality problems.</p> <p>Warning—Potential Damage: Do not touch the underside of the imaging kit. This could damage the imaging kit.</p> <p>b Resend the print job.</p> <p>Do vertical voids appear on prints?</p>	Go to step 5.	The problem is solved.
<p>Step 5</p> <p>Replace the imaging kit, and then resend the print job.</p> <p>Do vertical voids appear on prints?</p>	Contact customer support .	The problem is solved.

Color quality problems

FAQ about color printing

What is RGB color?

Red, green, and blue light can be added together in various amounts to produce a large range of colors observed in nature. For example, red and green can be combined to create yellow. Televisions and computer monitors create colors in this manner. RGB color is a method of describing colors by indicating the amount of red, green, or blue needed to produce a certain color.

What is CMYK color?

Cyan, magenta, yellow, and black inks or toners can be printed in various amounts to produce a large range of colors observed in nature. For example, cyan and yellow can be combined to create green. Printing presses, inkjet printers, and color laser printers create colors in this manner. CMYK color is a method of describing colors by indicating the amount of cyan, magenta, yellow, and black needed to reproduce a particular color.

How is color specified in a document to be printed?

Software programs typically specify the document color using RGB or CMYK color combinations. Additionally, they let users modify the color of each object in a document. For more information, see the help information of your operating system.

How does the printer know what color to print?

When a user prints a document, information describing the type and color of each object is sent to the printer. The color information is passed through color conversion tables that translate the color into the appropriate amounts of cyan, magenta, yellow, and black toner needed to produce the color you want. The object information determines the application of color conversion tables. For example, it is possible to apply one type of color conversion table to text while applying a different color conversion table to photographic images.

What is manual color correction?

When manual color correction is enabled, the printer employs user-selected color conversion tables to process objects. However, Color Correction must be set to Manual, or no user-defined color conversion will be implemented. Manual color correction settings are specific to the type of object being printed (text, graphics, or images), and how the color of the object is specified in the software program (RGB or CMYK combinations).

Notes:

- Manual color correction is not useful if the software program does not specify colors with RGB or CMYK combinations. It is also not effective in situations in which the software program or the computer operating system controls the adjustment of colors.
- When **Auto Color Correction** is selected, the color conversion tables will generate preferred colors used for the majority of the documents.

To manually apply a different color conversion table, do the following:

- 1 From the Quality menu on the printer control panel, select **Color Correction**, and then select **Manual**.
- 2 From the Quality menu on the printer control panel, select **Manual Color**, and then select the appropriate color conversion table for the affected object type.

Object type	Color conversion tables
RGB Image RGB Text RGB Graphics	<ul style="list-style-type: none"> • Vivid—Produces brighter, more saturated colors and may be applied to all incoming color formats. • sRGB Display—Produces an output that approximates the colors displayed on a computer monitor. Note: Black toner usage is optimized for printing photographs. • Display—True Black—Produces an output that approximates the colors displayed on a computer monitor. This uses only black toner to create all levels of neutral gray. • sRGB Vivid—Provides an increased color saturation for the sRGB Display color correction. Note: Black toner usage is optimized for printing business graphics. • Off—No color correction is implemented.

Object type	Color conversion tables
CMYK Image CMYK Text CMYK Graphics	<ul style="list-style-type: none"> • US CMYK—Applies color correction to approximate the SWOP (Specifications for Web Offset Publishing) color output. • Euro CMYK—Applies color correction to approximate Euroscale color output. • Vivid CMYK—Increases the color saturation of the US CMYK color correction setting. • Off—No color correction is implemented.

How can I match a particular color (such as a corporate logo)?

Nine types of Color Samples sets are available from the Quality menu on the printer control panel. These are also available from the Color Samples page of the Embedded Web Server. Selecting any sample set generates a multiple-page printout consisting of hundreds of colored boxes. Either a CMYK or RGB combination is located on each box, depending on the table selected. The observed color of each box is obtained by passing the CMYK or RGB combination labeled on the box through the selected color conversion table.

By examining Color Samples sets, you can identify the box whose color is the closest to the color you want. The color combination labeled on the box can then be used for modifying the color of the object in a software program. For more information, see the help information of your operating system.

Note: Manual color correction may be necessary to utilize the selected color conversion table for the particular object.

Selecting which Color Samples set to use for a particular color-matching problem depends on the Color Correction setting being used, the type of object being printed, and how the color of the object is specified in the software program. When Color Correction is set to Off, the color is based on the print job information, and no color conversion is implemented.

Note: The Color Samples pages are not useful if the software program does not specify colors with RGB or CMYK combinations. Additionally, certain situations exist in which the software program or the computer operating system adjusts the RGB or CMYK combinations specified in the program through color management. The resulting printed color may not be an exact match of the Color Samples pages.

Prints on color transparencies appear dark when projected

Note: This problem occurs when projecting transparencies with reflective overhead projectors. To obtain the highest projected color quality, transmissive overhead projectors are recommended.

Action	Yes	No
<p>Step 1 From the printer control panel, make sure the paper type setting is set to Transparency.</p> <p>Is the paper type setting correct?</p>	<p>Go to step 2.</p>	<p>Set the paper type to Transparency.</p>
<p>Step 2 Reduce the toner darkness, and then resend the print job.</p> <p>Does the print on the color transparency look lighter?</p>	<p>The problem is solved.</p>	<p>Go to step 3.</p>

Action	Yes	No
<p>Step 3 Make sure you are using a recommended type of color transparency, and then resend the print job.</p> <p>Does the print on the color transparency look lighter?</p>	The problem is solved.	Contact customer support .

The color of the print does not match the color of the original file

Note: The color conversion tables used in Auto Color Correction mode generally approximate the colors of a standard computer monitor. However, because of technology differences that exist between printers and monitors, there are many colors that can also be affected by monitor variations and lighting conditions.

Action	Yes	No
<p>Step 1 a Set Color Correction to Off. Note: When the printer color correction is disabled, the color is based on the print job information, and no color conversion is implemented. b Resend the print job.</p> <p>Does the color of the print match the color of the file on the computer screen?</p>	The problem is solved.	Go to step 2.
<p>Step 2 From the Quality menu on the printer control panel, do the following: a Select Color Correction, and then select Manual. b Select Manual Color, and then select the appropriate color conversion table for the affected object type. c Resend the print job.</p> <p>Does the color of the print match the color of the file on the computer screen?</p>	The problem is solved.	Contact customer support .

The print appears tinted

Action	Yes	No
<p>Adjust the color balance. a From the Color Balance menu on the printer control panel, increase or decrease the values for cyan, magenta, yellow, and black. b Resend the print job.</p> <p>Does the print still appear tinted?</p>	The problem is solved.	Contact customer support .

Solving copy problems

- “Copier does not respond” on page 214
- “Scanner unit does not close” on page 214
- “Poor copy quality” on page 215
- “Partial document or photo copies” on page 216

Copier does not respond

Action	Yes	No
<p>Step 1 Check if an error or status message appears on the display.</p> <p>Does an error or status message appear?</p>	Clear the error or status message.	Go to step 2.
<p>Step 2 Check if the power cord is plugged into the printer and a properly grounded electrical outlet.</p> <p>Is the power cord plugged into the printer and a properly grounded electrical outlet?</p>	Go to step 3.	Connect the power cord to the printer and a properly grounded electrical outlet.
<p>Step 3 Turn off the printer, then wait for about 10 seconds, and then turn it back on.</p> <p>Did Performing Self Test and Ready appear?</p>	The problem is solved.	Contact customer support .

Scanner unit does not close

Action	Yes	No
<p>Check if there are no obstructions between the scanner unit and the printer.</p> <p>a Lift the scanner unit. b Remove any obstruction that keeps the scanner unit open. c Lower the scanner unit.</p> <p>Did the scanner unit close properly?</p>	The problem is solved.	Contact customer support .

Poor copy quality

Action	Yes	No
<p>Step 1 Check if an error or status message appears on the display.</p> <p>Does an error or status message appear?</p>	Clear the error or status message.	Go to step 2.
<p>Step 2 Check the quality of the original document.</p> <p>Is the quality of the original document satisfactory?</p>	Go to step 3.	Increase the scan resolution setting for a higher-quality output.
<p>Step 3 If dark marks appear on prints, then clean the scanner glass and the ADF glass using a clean, lint-free cloth dampened with water.</p> <p>Is the scanner glass clean?</p>	Go to step 4.	See “Cleaning the scanner glass” on page 130.
<p>Step 4 Send a print job, and then check for print quality problems.</p> <p>a From the General Settings menu, adjust the Eco-Mode settings. b From the Copy menu, adjust the Darkness setting. c If the print remains faded, then replace the toner cartridge.</p> <p>Is the print quality satisfactory?</p>	Go to step 5.	See “Print quality problems” on page 193.
<p>Step 5 Check the placement of the document or photo.</p> <p>Make sure the document or photo is loaded facedown on the scanner glass in the upper left corner.</p> <p>Is the document or photo loaded correctly?</p>	Go to step 6.	Place the document or photo facedown on the scanner glass in the upper left corner.
<p>Step 6 Check the copy settings.</p> <p>From the Copy screen, check if the Content Type and Content Source settings are correct for the document being scanned.</p> <p>Are the Content Type and Content Source settings correct for the document being scanned?</p>	Go to step 7.	Change the Content Type and Content Source settings to match the document being scanned.
<p>Step 7 Check for patterns on print.</p> <p>a From the printer control panel, navigate to: Copy > Sharpness > select a lower setting Note: Make sure no scaling is being selected. b Resend the copy job.</p> <p>Do patterns appear on prints?</p>	Go to step 8.	The problem is solved.

Action	Yes	No
<p>Step 8</p> <p>Check for missing or faded text on prints.</p> <p>a From the Copy screen, adjust the settings of the following:</p> <ul style="list-style-type: none"> • Sharpness—Increase the sharpness setting. • Contrast—Increase the contrast setting. <p>b Resend the copy job.</p> <p>Do prints have missing or faded text?</p>	Go to step 9.	The problem is solved.
<p>Step 9</p> <p>Check for washed-out or overexposed output.</p> <p>a From the Copy screen, adjust the settings of the following:</p> <ul style="list-style-type: none"> • Background Removal—Reduce the current setting. • Darkness—Increase the current setting. <p>b Resend the copy job.</p> <p>Do pages show washed-out or overexposed prints?</p>	Contact customer support .	The problem is solved.

Partial document or photo copies

Action	Yes	No
<p>Step 1</p> <p>Check the placement of the document or photo.</p> <p>Make sure the document or photo is loaded facedown on the scanner glass in the upper left corner.</p> <p>Is the document or photo loaded correctly?</p>	Go to step 2.	Place the document or photo facedown on the scanner glass in the upper left corner.
<p>Step 2</p> <p>Check if the paper size setting matches the size of the paper loaded in the tray.</p> <p>From the Paper menu on the printer control panel, check the Paper Size setting.</p> <p>Does the paper size setting match the size of the paper loaded in the tray.</p>	Go to step 3.	Change the paper size setting to match the paper loaded in the tray, or load the tray with paper that matches the paper size setting.
<p>Step 3</p> <p>a Specify the paper size. Depending on your operating system, specify the paper size in Printing Preferences or the Print dialog.</p> <p>b Resend the print job.</p> <p>Do copies print properly?</p>	The problem is solved.	Contact customer support .

Solving scanner problems

- “The scanner does not respond” on page 217
- “Scan job was not successful” on page 218
- “Scanner unit does not close” on page 219
- “Scanning takes too long or freezes the computer” on page 219
- “Poor scanned image quality” on page 219
- “Partial document or photo scans” on page 220
- “Cannot scan from a computer” on page 221

The scanner does not respond

Action	Yes	No
<p>Step 1 Check if the printer is turned on.</p> <p>Is the printer turned on?</p>	Go to step 2.	Turn on the printer.
<p>Step 2 Check if the printer cable is securely attached to the printer and the computer, print server, option, or other network device.</p> <p>Is the printer cable securely attached to the printer and the computer, print server, option, or other network device?</p>	Go to step 3.	Connect the printer cable securely to the printer and the computer, print server, option, or other network device.
<p>Step 3 Check if the power cord is plugged into the printer and a properly grounded electrical outlet.</p> <p>Is the power cord plugged into the printer and a properly grounded electrical outlet?</p>	Go to step 4.	Connect the power cord to the printer and a properly grounded electrical outlet.
<p>Step 4 Check if the electrical outlet is turned off by a switch or breaker.</p> <p>Is the electrical outlet turned off by a switch or breaker?</p>	Turn on the switch or reset the breaker.	Go to step 5.
<p>Step 5 Check if the printer is plugged into any surge protectors, uninterruptible power supplies, or extension cords.</p> <p>Is the printer plugged into any surge protectors, uninterruptible power supplies, or extension cords?</p>	Connect the printer power cord directly to a properly grounded electrical outlet.	Go to step 6.

Action	Yes	No
<p>Step 6 Check other electrical equipment plugged into the outlet.</p> <p>Are the other electrical equipment working?</p>	<p>Unplug the other electrical equipment and turn on the printer. If the printer does not work, then reconnect the other electrical equipment and then go to step 6.</p>	<p>Go to step 7.</p>
<p>Step 7 Turn off the printer, then wait for about 10 seconds, and then turn the printer back on.</p> <p>Are the printer and scanner working?</p>	<p>The problem is solved.</p>	<p>Contact customer support.</p>

Scan job was not successful

Action	Yes	No
<p>Step 1 Check the cable connections. Make sure the Ethernet or USB cable is securely connected to the computer and the printer.</p> <p>Are the cables securely connected?</p>	<p>Go to step 2.</p>	<p>Connect the cables properly.</p>
<p>Step 2 Check if the file name is already in use.</p> <p>Is the file name already in use?</p>	<p>Change the file name.</p>	<p>Go to step 3.</p>
<p>Step 3 Check if the document or photo you want to scan is open in another application or being used by another user.</p> <p>Is the file you want to scan open by another application or user?</p>	<p>Close the file you are scanning.</p>	<p>Go to step 4.</p>
<p>Step 4 Check if either the Append time stamp or the Overwrite existing file check box is selected in the destination configuration settings.</p> <p>Is the Append time stamp or Overwrite existing file check box selected in the destination configuration settings?</p>	<p>Contact customer support.</p>	<p>Select the Append time stamp or Overwrite existing file check box in the destination configuration settings.</p>

Scanner unit does not close

Action	Yes	No
<p>Check if there are obstructions in the scanner unit.</p> <ul style="list-style-type: none"> a Lift the scanner unit. b Remove any obstruction keeping the scanner unit open. c Lower the scanner unit. <p>Did the scanner unit close correctly?</p>	The problem is solved.	Contact customer support .

Scanning takes too long or freezes the computer

Action	Yes	No
<p>Step 1</p> <p>Check if other applications are interfering with the scan. Close all applications that are not being used.</p> <p>Does scanning still take too long or freeze the computer?</p>	Go to step 2.	The problem is solved.
<p>Step 2</p> <p>Select a lower scan resolution.</p> <p>Does scanning still take too long or freeze the computer?</p>	Contact customer support .	The problem is solved.

Poor scanned image quality

Action	Yes	No
<p>Step 1</p> <p>Check if an error message appears on the display.</p> <p>Is there an error message on the printer display?</p>	Clear the error message.	Go to step 2.
<p>Step 2</p> <p>Check the quality of the original document.</p> <p>Is the quality of the original document satisfactory?</p>	Go to step 3.	Increase the scan resolution settings for a higher-quality output.
<p>Step 3</p> <p>Clean the scanner glass and the ADF glass using a clean, lint-free cloth dampened with water.</p> <p>Is the scanner glass clean?</p>	Go to step 4.	See “Cleaning the scanner glass” on page 130 .

Action	Yes	No
<p>Step 4</p> <p>Check the placement of the document or photo.</p> <p>Make sure the document or photo is loaded facedown on the scanner glass in the upper left corner.</p> <p>Is the document or photo loaded correctly?</p>	Go to step 5.	Place the document or photo facedown on the scanner glass in the upper left corner.
<p>Step 5</p> <p>Send a print job, and then check for print quality problems.</p> <ul style="list-style-type: none"> • From the General Settings menu, adjust the Eco-Mode settings. • From the Copy menu, adjust the Darkness setting. • When the print becomes faded, replace the toner cartridge. <p>Is the print quality satisfactory?</p>	Go to step 6.	See “Print quality problems” on page 193.
<p>Step 6</p> <p>Check the scan settings.</p> <p>From the Scan screen, make sure the Content Type and Content Source settings are correct for the document being scanned.</p> <p>Are the Content Type and Content Source settings correct for the document being scanned?</p>	Go to step 7.	Change the Content Type and Content Source settings to match the document being scanned.
<p>Step 7</p> <p>Increase the scan resolution settings for a higher-quality output.</p> <p>Did the increased resolution produce a higher-quality output?</p>	Problem solved.	Contact customer support.

Partial document or photo scans

Action	Yes	No
<p>Check the placement of the document or photo.</p> <p>Make sure the document or photo is loaded facedown on the scanner glass in the upper left corner.</p> <p>Is the document or photo loaded correctly?</p>	Contact customer support.	Load the document or photo facedown on the scanner glass in the upper left corner.

Cannot scan from a computer

Action	Yes	No
<p>Step 1 Make sure the printer is turned on and that Ready appears on the printer display before scanning a job.</p> <p>Does Ready appear before scanning the job?</p>	Go to step 3.	Go to step 2.
<p>Step 2 Turn off the printer, then wait for about 10 seconds, and then turn the printer back on.</p> <p>Is there an error message on the printer display?</p>	Clear the error message.	Go to step 3.
<p>Step 3 Check the cable connections between the printer and the print server to make sure they are secure. For more information, see the setup documentation that came with the printer.</p> <p>Are the cable connections between the printer and the print server secure?</p>	Contact customer support .	Tighten the cable connections.

Embedded Web Server does not open

Action	Yes	No
<p>Step 1</p> <ul style="list-style-type: none"> a Turn on the printer. b Open a Web browser, and then type the printer IP address. c Press Enter. <p>Does the Embedded Web Server open?</p>	The problem is solved.	Go to step 2.

Action	Yes	No
<p>Step 2 Make sure the printer IP address is correct.</p> <p>a View the printer IP address:</p> <ul style="list-style-type: none"> • From the TCP/IP section in the Network/Ports menu • By printing a network setup page or menu settings page, and then finding the TCP/IP section <p>Note: An IP address appears as four sets of numbers separated by periods, such as 123.123.123.123.</p> <p>b Open a Web browser, and then type the IP address.</p> <p>Note: Depending on the network settings, you may need to type “https://” instead of “http://” before the printer IP address to access the Embedded Web Server.</p> <p>c Press Enter.</p> <p>Does the Embedded Web Server open?</p>	<p>The problem is solved.</p>	<p>Go to step 3.</p>
<p>Step 3 Check if the network is working.</p> <p>a Print a network setup page.</p> <p>b Check the first section of the network setup page and confirm that the status is Connected.</p> <p>Note: If the status is Not Connected, then the connection may be intermittent, or the network cable may be defective. Contact your system support person for a solution, and then print another network setup page.</p> <p>c Open a Web browser, and then type the printer IP address.</p> <p>d Press Enter.</p> <p>Does the Embedded Web Server open?</p>	<p>The problem is solved.</p>	<p>Go to step 4.</p>
<p>Step 4 Check if the cable connections to the printer and print server are secure.</p> <p>a Connect the cables properly. For more information, see the setup documentation that came with the printer.</p> <p>b Open a Web browser, and then type the printer IP address.</p> <p>c Press Enter.</p> <p>Does the Embedded Web Server open?</p>	<p>The problem is solved.</p>	<p>Go to step 5.</p>
<p>Step 5 Temporarily disable the Web proxy servers. Proxy servers may block or restrict you from accessing certain Web sites including the Embedded Web Server.</p> <p>Does the Embedded Web Server open?</p>	<p>The problem is solved.</p>	<p>Contact your system support person.</p>

Contacting customer support

Before contacting customer support, make sure to have the following information:

- Printer problem
- Error message
- Printer model type and serial number

Go to <http://support.lexmark.com> to receive e-mail or chat support, or browse through the library of manuals, support documentation, drivers, and other downloads.

Technical support via telephone is also available. In the U.S. or Canada, call 1-800-539-6275. For other countries or regions, go to <http://support.lexmark.com>.

Notices

Product information

Product name:

Lexmark CX310n, CX310dn, CX317dn

Machine type:

7527

Model(s):

211, 231

Edition notice

March 2017

The following paragraph does not apply to any country where such provisions are inconsistent with local law: LEXMARK INTERNATIONAL, INC., PROVIDES THIS PUBLICATION "AS IS" WITHOUT WARRANTY OF ANY KIND, EITHER EXPRESS OR IMPLIED, INCLUDING, BUT NOT LIMITED TO, THE IMPLIED WARRANTIES OF MERCHANTABILITY OR FITNESS FOR A PARTICULAR PURPOSE. Some states do not allow disclaimer of express or implied warranties in certain transactions; therefore, this statement may not apply to you.

This publication could include technical inaccuracies or typographical errors. Changes are periodically made to the information herein; these changes will be incorporated in later editions. Improvements or changes in the products or the programs described may be made at any time.

References in this publication to products, programs, or services do not imply that the manufacturer intends to make these available in all countries in which it operates. Any reference to a product, program, or service is not intended to state or imply that only that product, program, or service may be used. Any functionally equivalent product, program, or service that does not infringe any existing intellectual property right may be used instead. Evaluation and verification of operation in conjunction with other products, programs, or services, except those expressly designated by the manufacturer, are the user's responsibility.

For Lexmark technical support, visit <http://support.lexmark.com>.

For information on supplies and downloads, visit www.lexmark.com.

© 2017 Lexmark International, Inc.

All rights reserved.

GOVERNMENT END USERS

The Software Program and any related documentation are "Commercial Items," as that term is defined in 48 C.F.R. 2.101, "Computer Software" and "Commercial Computer Software Documentation," as such terms are used in 48 C.F.R. 12.212 or 48 C.F.R. 227.7202, as applicable. Consistent with 48 C.F.R. 12.212 or 48 C.F.R. 227.7202-1 through 227.7207-4, as applicable, the Commercial Computer Software and Commercial Software Documentation are licensed to the U.S. Government end users (a) only as Commercial Items and (b) with only those rights as are granted to all other end users pursuant to the terms and conditions herein.

Licensing notices

All licensing notices associated with this product can be viewed from the root directory of the installation software CD.

Trademarks

Lexmark, the Lexmark logo, MarkNet, AccuRead, and MarkVision are trademarks or registered trademarks of Lexmark International, Inc. in the United States and/or other countries.

Google Cloud Print is a trademark of Google Inc.

Mac and the Mac logo are trademarks of Apple Inc., registered in the U.S. and other countries.

Microsoft and Windows are either registered trademarks or trademarks of the Microsoft group of companies in the United States and other countries.

Mopria®, the Mopria® logo, and the Mopria® Alliance logo are registered trademarks and service marks of Mopria Alliance, Inc. in the United States and other countries. Unauthorized use is strictly prohibited.

PCL® is a registered trademark of the Hewlett-Packard Company. PCL is Hewlett-Packard Company’s designation of a set of printer commands (language) and functions included in its printer products. This printer is intended to be compatible with the PCL language. This means the printer recognizes PCL commands used in various application programs, and that the printer emulates the functions corresponding to the commands.

PostScript is a registered trademark of Adobe Systems Incorporated in the United States and/or other countries.

The following terms are trademarks or registered trademarks of these companies:

Albertus	The Monotype Corporation plc
Antique Olive	Monsieur Marcel OLIVE
Apple-Chancery	Apple Computer, Inc.
Arial	The Monotype Corporation plc
CG Times	Based on Times New Roman under license from The Monotype Corporation plc, is a product of Agfa Corporation
Chicago	Apple Computer, Inc.
Clarendon	Linotype-Hell AG and/or its subsidiaries
Eurostile	Nebiolo
Geneva	Apple Computer, Inc.
GillSans	The Monotype Corporation plc
Helvetica	Linotype-Hell AG and/or its subsidiaries
Hoefler	Jonathan Hoefler Type Foundry
ITC Avant Garde Gothic	International Typeface Corporation
ITC Bookman	International Typeface Corporation
ITC Mona Lisa	International Typeface Corporation
ITC Zapf Chancery	International Typeface Corporation
Joanna	The Monotype Corporation plc

Marigold	Arthur Baker
Monaco	Apple Computer, Inc.
New York	Apple Computer, Inc.
Oxford	Arthur Baker
Palatino	Linotype-Hell AG and/or its subsidiaries
Stempel Garamond	Linotype-Hell AG and/or its subsidiaries
Taffy	Agfa Corporation
Times New Roman	The Monotype Corporation plc
Univers	Linotype-Hell AG and/or its subsidiaries

All other trademarks are the property of their respective owners.

AirPrint and the AirPrint logo are trademarks of Apple, Inc.

Noise emission levels

The following measurements were made in accordance with ISO 7779 and reported in conformance with ISO 9296.

Note: Some modes may not apply to your product.

1-meter average sound pressure, dBA	
Printing	50
Scanning	49
Copying	48
Ready	16

Values are subject to change. See www.lexmark.com for current values.

Waste from Electrical and Electronic Equipment (WEEE) directive



The WEEE logo signifies specific recycling programs and procedures for electronic products in countries of the European Union. We encourage the recycling of our products.

If you have further questions about recycling options, visit the Lexmark Web site at www.lexmark.com for your local sales office phone number.

India E-Waste notice

This product complies with the India E-Waste (Management and Handling) Rules, 2011, which prohibit use of lead, mercury, hexavalent chromium, polybrominated biphenyls, or polybrominated diphenyl ethers in concentrations exceeding 0.1% by weight and 0.01% by weight for cadmium, except for the exemption set in Schedule II of the Rules.

Product disposal

Do not dispose of the printer or supplies in the same manner as normal household waste. Consult your local authorities for disposal and recycling options.

Static sensitivity notice



This symbol identifies static-sensitive parts. Do not touch the areas near these symbols without first touching a metal surface in an area away from the symbol.

ENERGY STAR

Any Lexmark product bearing the ENERGY STAR emblem on the product or on a start-up screen is certified to comply with Environmental Protection Agency (EPA) ENERGY STAR requirements as configured when shipped by Lexmark.



Temperature information

Ambient operating temperature	15.6 to 32.2°C (60 to 90°F)
Shipping temperature	-40 to 43.3°C (-40 to 110°F)
Storage temperature and relative humidity	1 to 35°C (34 to 95°F) 8 to 80% RH

Laser notice

The printer is certified in the U.S. to conform to the requirements of DHHS 21 CFR, Chapter I, Subchapter J for Class I (1) laser products, and elsewhere is certified as a Class I laser product conforming to the requirements of IEC 60825-1.

Class I laser products are not considered to be hazardous. The printer contains internally a Class IIIb (3b) laser that is nominally a 7 milliwatt gallium arsenide laser operating in the wavelength of 655-675 nanometers. The

laser system and printer are designed so there is never any human access to laser radiation above a Class I level during normal operation, user maintenance, or prescribed service condition.

Laser advisory label

A laser notice label may be affixed to this printer as shown:

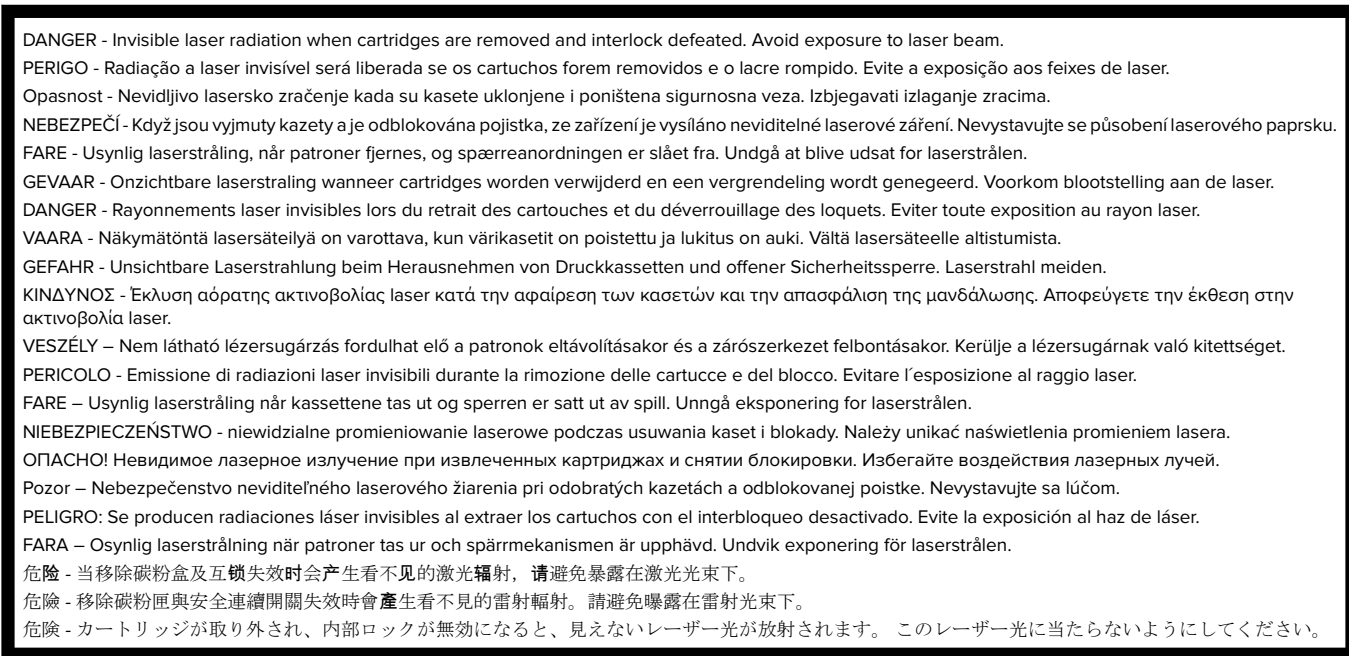

Power consumption

Product power consumption

The following table documents the power consumption characteristics of the product.

Note: Some modes may not apply to your product.

Mode	Description	Power consumption (Watts)
Printing	The product is generating hard-copy output from electronic inputs.	500
Copy	The product is generating hard-copy output from hard-copy original documents.	540
Scan	The product is scanning hard-copy documents.	40
Ready	The product is waiting for a print job.	30
Sleep Mode	The product is in a high-level energy-saving mode.	2.5
Hibernate	The product is in a low-level energy-saving mode.	0.5
Off	The product is plugged into an electrical outlet, but the power switch is turned off.	0

The power consumption levels listed in the previous table represent time-averaged measurements. Instantaneous power draws may be substantially higher than the average.

Values are subject to change. See www.lexmark.com for current values.

Sleep Mode

This product is designed with an energy-saving mode called *Sleep Mode*. The Sleep Mode saves energy by lowering power consumption during extended periods of inactivity. The Sleep Mode is automatically engaged after this product is not used for a specified period of time, called the *Sleep Mode Timeout*.

Factory default Sleep Mode Timeout for this product (in minutes):	20
---	----

By using the configuration menus, the Sleep Mode Timeout can be modified between 1 minute and 120 minutes. Setting the Sleep Mode Timeout to a low value reduces energy consumption, but may increase the response time of the product. Setting the Sleep Mode Timeout to a high value maintains a fast response, but uses more energy.

Hibernate Mode

This product is designed with an ultra-low power operating mode called *Hibernate mode*. When operating in Hibernate Mode, all other systems and devices are powered down safely.

The Hibernate mode can be entered in any of the following methods:

- Using the Hibernate Timeout
- Using the Schedule Power modes
- Using the Sleep/Hibernate button

Factory default Hibernate Timeout for this product in all countries or regions	3 days
--	--------

The amount of time the printer waits after a job is printed before it enters Hibernate mode can be modified between one hour and one month.

Off mode

If this product has an off mode which still consumes a small amount of power, then to completely stop product power consumption, disconnect the power supply cord from the electrical outlet.

Total energy usage

It is sometimes helpful to calculate the total product energy usage. Since power consumption claims are provided in power units of Watts, the power consumption should be multiplied by the time the product spends in each mode in order to calculate energy usage. The total product energy usage is the sum of each mode's energy usage.

Regulatory notices for electromagnetic compatibility

This section contains regulatory information pertaining to electromagnetic compatibility.

Federal Communications Commission (FCC) compliance information statement

This product has been tested and found to comply with the limits for a Class B digital device, pursuant to Part 15 of the FCC Rules. Operation is subject to the following two conditions: (1) this device may not cause harmful interference, and (2) this device must accept any interference received, including interference that may cause undesired operation.

The FCC Class B limits are designed to provide reasonable protection against harmful interference when the equipment is operated in a residential installation. This equipment generates, uses, and can radiate radio frequency energy and, if not installed and used in accordance with the instructions, may cause harmful interference to radio communications. However, there is no guarantee that interference will not occur in a particular installation. If this equipment does cause harmful interference to radio or television reception, which can be determined by turning the equipment off and on, the user is encouraged to try to correct the interference by one or more of the following measures:

- Reorient or relocate the receiving antenna.
- Increase the separation between the equipment and receiver.
- Connect the equipment into an outlet on a circuit different from that to which the receiver is connected.
- Consult your point of purchase or service representative for additional suggestions.

The manufacturer is not responsible for radio or television interference caused by using other than recommended cables or by unauthorized changes or modifications to this equipment. Unauthorized changes or modifications could void the user's authority to operate this equipment.

Note: To assure compliance with FCC regulations on electromagnetic interference for a Class B computing device, use a properly shielded and grounded cable such as Lexmark part number 1021231 for parallel attach or 1021294 for USB attach. Use of a substitute cable not properly shielded and grounded may result in a violation of FCC regulations.

Any questions regarding this compliance information statement should be directed to:

Director of Lexmark Technology & Services
Lexmark International, Inc.
740 West New Circle Road
Lexington, KY 40550
(859) 232-3000

Industry Canada compliance statement

This Class B digital apparatus meets all requirements of the Canadian Interference-Causing Equipment Standard ICES-003.

Avis de conformité aux normes de l'industrie du Canada

Cet appareil numérique de classe B est conforme aux exigences de la norme canadienne relative aux équipements pouvant causer des interférences NMB-003.

日本の VCCI 規定

製品にこのマークが表示されている場合、次の要件を満たしています。



この装置は、クラス B 情報技術装置です。この装置は、家庭環境で使用することを目的としていますが、この装置がラジオやテレビジョン受信機に近接して使用されると、受信障害を引き起こすことがあります。

取扱説明書に従って正しい取り扱いをしてください。

VCCI-B

European Community (EC) directives conformity

This product is in conformity with the protection requirements of EC Council directives 2014/30/EU, 2014/35/EU, 2009/125/EC, and 2011/65/EU on the approximation and harmonization of the laws of the Member States relating to electromagnetic compatibility, safety of electrical equipment designed for use within certain voltage limits, the ecodesign of energy-related products, and on the restrictions of use of certain hazardous substances in electrical and electronic equipment.

The manufacturer of this product is: Lexmark International, Inc., 740 West New Circle Road, Lexington, KY, 40550 USA. The authorized representative is: Lexmark International Technology Hungária Kft., 8 Lechner Ödön fasor, Millennium Tower III, 1095 Budapest HUNGARY. A declaration of conformity to the requirements of the Directives is available upon request from the Authorized Representative or may be obtained at www.lexmark.com/en_us/about/regulatory-compliance/european-union-declaration-of-conformity.html.

This product satisfies the Class B limits of EN 55022 and EN55032 and safety requirements of EN 60950-1 or EN 62368-1.

STATEMENT OF LIMITED WARRANTY FOR LEXMARK LASER PRINTERS, LEXMARK LED PRINTERS, AND LEXMARK MULTIFUNCTION LASER PRINTERS

Lexmark International, Inc., Lexington, KY

This limited warranty applies to the United States and Canada. For customers outside the U.S., refer to the country-specific warranty information that came with your product.

This limited warranty applies to this product only if it was originally purchased for your use, and not for resale, from Lexmark or a Lexmark Remarketer, referred to in this statement as “Remarketer.”

Limited warranty

Lexmark warrants that this product:

- Is manufactured from new parts, or new and serviceable used parts, which perform like new parts
- Is, during normal use, free from defects in material and workmanship

If this product does not function as warranted during the warranty period, contact a Remarketer or Lexmark for repair or replacement (at Lexmark's option).

If this product is a feature or option, this statement applies only when that feature or option is used with the product for which it was intended. To obtain warranty service, you may be required to present the feature or option with the product.

If you transfer this product to another user, warranty service under the terms of this statement is available to that user for the remainder of the warranty period. You should transfer proof of original purchase and this statement to that user.

Limited warranty service

The warranty period starts on the date of original purchase as shown on the purchase receipt and ends 12 months later provided that the warranty period for any supplies and for any maintenance items included with the printer shall end earlier if it, or its original contents, are substantially used up, depleted, or consumed. Fuser

Units, Transfer/Transport Units, Paper Feed items, if any, and any other items for which a Maintenance Kit is available are substantially consumed when the printer displays a “Life Warning” or “Scheduled Maintenance” message for such item.

To obtain warranty service you may be required to present proof of original purchase. You may be required to deliver your product to the Remarketer or Lexmark, or ship it prepaid and suitably packaged to a Lexmark designated location. You are responsible for loss of, or damage to, a product in transit to the Remarketer or the Lexmark designated location.

When warranty service involves the exchange of a product or part, the item replaced becomes the property of the Remarketer or Lexmark. The replacement may be a new or repaired item.

The replacement item assumes the remaining warranty period of the original product.

Replacement is not available to you if the product you present for exchange is defaced, altered, in need of a repair not included in warranty service, damaged beyond repair, or if the product is not free of all legal obligations, restrictions, liens, and encumbrances.

As part of your warranty service and/or replacement, Lexmark may update the firmware in your printer to the latest version. Firmware updates may modify printer settings and cause counterfeit and/or unauthorized products, supplies, parts, materials (such as toners and inks), software, or interfaces to stop working. Authorized use of genuine Lexmark products will not be impacted.

Before you present this product for warranty service, remove all print cartridges, programs, data, and removable storage media (unless directed otherwise by Lexmark).

For further explanation of your warranty alternatives and the nearest Lexmark authorized servicer in your area contact Lexmark on the World Wide Web.

Remote technical support is provided for this product throughout its warranty period. For products no longer covered by a Lexmark warranty, technical support may not be available or only be available for a fee.

Extent of limited warranty

Lexmark does not warrant uninterrupted or error-free operation of any product or the durability or longevity of prints produced by any product.

Warranty service does not include repair of failures caused by:

- Modification or unauthorized attachments
- Accidents, misuse, abuse or use inconsistent with Lexmark user’s guides, manuals, instructions or guidance
- Unsuitable physical or operating environment
- Maintenance by anyone other than Lexmark or a Lexmark authorized servicer
- Operation of a product beyond the limit of its duty cycle
- Use of printing media outside of Lexmark specifications
- Refurbishment, repair, refilling or remanufacture by a third party of products, supplies or parts
- Products, supplies, parts, materials (such as toners and inks), software, or interfaces not furnished by Lexmark

TO THE EXTENT PERMITTED BY APPLICABLE LAW, NEITHER LEXMARK NOR ITS THIRD PARTY SUPPLIERS OR REMARKETERS MAKE ANY OTHER WARRANTY OR CONDITION OF ANY KIND, WHETHER EXPRESS OR IMPLIED, WITH RESPECT TO THIS PRODUCT, AND SPECIFICALLY DISCLAIM THE IMPLIED WARRANTIES OR CONDITIONS OF MERCHANTABILITY, FITNESS FOR A PARTICULAR PURPOSE, AND SATISFACTORY QUALITY. ANY WARRANTIES THAT MAY NOT BE DISCLAIMED UNDER APPLICABLE LAW ARE LIMITED IN DURATION TO THE WARRANTY PERIOD. NO WARRANTIES, EXPRESS OR IMPLIED, WILL

APPLY AFTER THIS PERIOD. ALL INFORMATION, SPECIFICATIONS, PRICES, AND SERVICES ARE SUBJECT TO CHANGE AT ANY TIME WITHOUT NOTICE.

Limitation of liability

Your sole remedy under this limited warranty is set forth in this document. For any claim concerning performance or nonperformance of Lexmark or a Remarketer for this product under this limited warranty, you may recover actual damages up to the limit set forth in the following paragraph.

Lexmark's liability for actual damages from any cause whatsoever will be limited to the amount you paid for the product that caused the damages. This limitation of liability will not apply to claims by you for bodily injury or damage to real property or tangible personal property for which Lexmark is legally liable. **IN NO EVENT WILL LEXMARK BE LIABLE FOR ANY LOST PROFITS, LOST SAVINGS, INCIDENTAL DAMAGE, OR OTHER ECONOMIC OR CONSEQUENTIAL DAMAGES.** This is true even if you advise Lexmark or a Remarketer of the possibility of such damages. Lexmark is not liable for any claim by you based on a third party claim.

This limitation of remedies also applies to claims against any Suppliers and Remarketers of Lexmark. Lexmark's and its Suppliers' and Remarketers' limitations of remedies are not cumulative. Such Suppliers and Remarketers are intended beneficiaries of this limitation.

Additional rights

Some states do not allow limitations on how long an implied warranty lasts, or do not allow the exclusion or limitation of incidental or consequential damages, so the limitations or exclusions contained above may not apply to you.

This limited warranty gives you specific legal rights. You may also have other rights that vary from state to state.

DEVICE PATENT LICENSE

Lexmark reserves the right to discontinue selling these toner cartridges any time after it discontinues service support for this printer.

IMPORTANT: PLEASE READ BEFORE OPENING: Opening this package, installing the printing device software, or using the products inside confirms your acceptance of the following licenses/agreements:

License: The patented printer inside is licensed for, and designed to work with only genuine Lexmark toner cartridges and developer components for the life of the patented printer. You agree to: (1) use only genuine Lexmark toner cartridges and developer components with this printer except as otherwise provided below, and (2) pass this license/agreement to any subsequent user of this printer. The patented Lexmark toner cartridges and developer components inside are licensed subject to a restriction that they may be used only once. Following their initial use, you agree to return them only to Lexmark for recycling. Lexmark toner cartridges are designed to stop working after delivering a fixed amount of toner. A variable amount of toner may remain in them when replacement is required. **If you do not accept these terms, return the unopened package to your point of purchase.** Replacement toner cartridge(s) sold without these terms are available through www.lexmark.com, may be refilled by you, or a third party, as the only cartridge alternative to be used with the licensed printer.

Patent acknowledgment

The use of this product or service is subject to the reasonable, non-discriminatory terms in the Intellectual Property Rights (IPR) Disclosure of Certicom Corp. at the IETF for Elliptic Curve Cryptography (ECC) Cipher Suites for Transport Layer Security (TLS) implemented in the product or service.

The use of this product or service is subject to the reasonable, non-discriminatory terms in the Intellectual Property Rights (IPR) Disclosure of Certicom Corp. at the IETF for TLS Elliptic Curve Cipher Suites with SHA-256/382 and AES Galois Counter Mode (GCM) implemented in the product or service.

The use of this product or service is subject to the reasonable, non-discriminatory terms in the Intellectual Property Rights (IPR) Disclosure of Certicom Corp. at the IETF for TLS Suite B Profile for Transport Layer Security (TLS) implemented in the product or service.

The use of this product or service is subject to the reasonable, non-discriminatory terms in the Intellectual Property Rights (IPR) Disclosure of Certicom Corp. at the IETF for Addition of the Camellia Cipher Suites to Transport Layer Security (TLS) implemented in the product or service.

The use of certain patents in this product or service is subject to the reasonable, non-discriminatory terms in the Intellectual Property Rights (IPR) Disclosure of Certicom Corp. at the IETF for AES-CCM ECC Cipher Suites for TLS implemented in the product or service.

The use of this product or service is subject to the reasonable, non-discriminatory terms in the Intellectual Property Rights (IPR) Disclosure of Certicom Corp. at the IETF for IKE and IKEv2 Authentication Using the Elliptic Curve Digital Signature Algorithm (ECDSA) implemented in the product or service.

The use of this product or service is subject to the reasonable, non-discriminatory terms in the Intellectual Property Rights (IPR) Disclosure of Certicom Corp. at the IETF for Suite B Cryptographic Suites for IPsec implemented in the product or service.

The use of this product or service is subject to the reasonable, non-discriminatory terms in the Intellectual Property Rights (IPR) Disclosure of Certicom Corp. at the IETF for Algorithms for Internet Key Exchange version 1 (IKEv1) implemented in the product or service.

Index

Numerics

- 250-sheet tray
 - loading 29
- 650-sheet duo tray
 - installing 21
 - loading 29, 33

Symbols

- [Color] cartridge low [88.xy] 169
- [Color] cartridge nearly low [88.xy] 169
- [Color] cartridge very low, [x] estimated pages remain [88.xy] 169
- [Type] imaging kit low [84.xy] 180
- [Type] imaging kit nearly low [84.xy] 180
- [Type] imaging kit very low, [x] estimated pages remain [84.xy] 180

A

- Active NIC menu 84
- adding hardware options
 - print driver 24
- adding internal options
 - print driver 24
- ADF
 - copying using 55
- Adjusting color 168
- adjusting Sleep mode 124
- adjusting toner darkness 50
- administrator settings
 - Embedded Web Server 155
- AirPrint
 - using 52
- AppleTalk menu 89
- arrow buttons
 - printer control panel 12
- attaching cables 22
- available internal options 14
- avoiding jams 45
- avoiding paper jams 158

B

- back button
 - printer control panel 12

- black-and-white printing 50
- buttons, printer control panel 12

C

- cables
 - Ethernet 22
 - USB 22
- cancel button
 - printer control panel 12
- canceling a copy job from the printer control panel 63
- canceling a print job
 - from the computer 54
 - from the printer control panel 54
- canceling an e-mail 68
- cannot open Embedded Web Server 221
- card stock
 - loading 34
 - tips 43
- Change [paper source] to [custom string] 168
- Change [paper source] to [custom type name] 168
- Change [paper source] to [paper type] [paper size] 168
- checking an unresponsive printer 181
- checking status of parts and supplies 131
- checking the status of parts and supplies 131
- checking the virtual display using the Embedded Web Server 155
- cleaning
 - exterior of the printer 129
 - interior of the printer 129
 - scanner glass 130
- cleaning the printer 129
- Close door 168
- Close flatbed cover and load originals if restarting job [2yy.xx] 169
- collate
 - copy options 64
- collating copies 61
- color quality troubleshooting
 - color of print and color on computer screen do not match 213
 - prints on color transparencies appear dark when projected 212
- color quality, troubleshooting
 - print appears tinted 213
- Complex page, some data may not have printed [39] 169
- confidential data
 - information on securing 128
- confidential jobs
 - modifying print settings 53
- confidential print jobs 52
- Confidential Print menu 92
- Configuration change, some held jobs were not restored [57] 170
- configuration information
 - wireless network 25
- configurations
 - printer 10
- configuring
 - multiple printers 157
 - supply notifications, imaging kit 156
 - supply notifications, maintenance kit 156
 - supply notifications, toner cartridge 156
 - supply notifications, waste toner bottle 156
- configuring e-mail settings 66
- configuring supply notifications from the Embedded Web Server 156
- configuring the Universal paper size settings 29
- connecting to a wireless network using PBC, Push Button Configuration method 26
 - using PIN, Personal Identification Number method 26
 - using the Embedded Web Server 27
 - using wireless setup wizard 26

- conservation settings
 - Eco-Mode 122
 - Hibernate mode 124
 - Hibernate Timeout 125
 - Quiet mode 123
 - Schedule Power Modes 125
 - Sleep mode 124
 - conserving supplies 122
 - contacting customer support 223
 - control panel, printer
 - indicator light 13
 - Sleep button light 13
 - controller board
 - accessing 15
 - copies
 - copy options 63
 - copy from
 - copy options 63
 - copy job
 - canceling 63
 - copy options
 - collate 64
 - copies 63
 - copy from 63
 - copy to 64
 - darkness 64
 - overlay 65
 - paper saver 65
 - scale 64
 - separator sheets 65
 - copy quality
 - adjusting 60
 - copy screen
 - content source 64
 - content type 64
 - options 65
 - Copy Settings menu 99
 - copy to
 - copy options 64
 - copy troubleshooting
 - copier does not respond 214
 - partial document or photo
 - copies 216
 - poor copy quality 215
 - poor scanned image
 - quality 219
 - scanner unit does not
 - close 214, 219
 - copying
 - adding an overlay message 62
 - adjusting quality 60
 - canceling a copy job from the printer control panel 63
 - collating copies 61
 - enlarging 59
 - making a copy lighter or darker 59
 - multiple pages on one sheet 62
 - on letterhead 57
 - on transparencies 56
 - photos 56
 - placing separator sheets
 - between copies 61
 - quick copy 55
 - reducing 59
 - selecting a tray 58
 - to a different size 58
 - using the ADF 55
 - using the scanner glass 56
- creating an FTP shortcut using the Embedded Web Server 69
- custom paper type
 - assigning 39
 - custom paper type name
 - creating 38
 - custom paper type names
 - assigning 38
 - Custom Scan Sizes menu 83
 - Custom Type [x]
 - assigning a paper type 39
 - Custom Type [x] name
 - creating 38
 - Custom Types menu 82
 - customer support
 - contacting 223
- ## D
- darkness
 - copy options 64
 - Default Source menu 74
 - Defective flash detected [51] 170
 - developer unit
 - replacing 138, 147
 - device and network settings
 - erasing 128
 - display troubleshooting
 - printer display is blank 183
 - display, printer control panel 12
 - documents, printing
 - from a computer 50
 - from a mobile device 52
- ## E
- Eco-Mode
 - using 122
 - embedded solutions
 - erasing 128
 - Embedded Web Server 156
 - administrator settings 155
 - checking the status of parts 131
 - checking the status of supplies 131
 - copying settings to other printers 157
 - creating an FTP shortcut 69
 - creating e-mail shortcuts 67
 - modifying confidential print settings 53
 - networking settings 155
 - problem accessing 221
 - setting up e-mail alerts 155
 - Embedded Web Server — Security: Administrator's Guide
 - where to find 155
 - Embedded Web Server — Security: Administrator's Guide
 - where to find 128
 - emission notices 226, 229, 230
 - enlarging a copy 59
 - envelopes
 - loading 32, 34
 - tips on using 42
 - environmental settings
 - Eco-Mode 122
 - Hibernate mode 124
 - Hibernate Timeout 125
 - Quiet mode 123
 - Schedule Power Modes 125
 - Sleep mode 124
 - erasing non-volatile memory 128
 - erasing volatile memory 128
 - Error reading USB drive. Remove USB. 170
 - Error reading USB hub. Remove hub. 170
 - Ethernet network
 - preparing to set up for Ethernet printing 24
 - Ethernet port 22
 - Ethernet setup
 - preparing for an 24
 - exterior of the printer
 - cleaning 129

- e-mail
 - canceling 68
- e-mail alerts
 - low supply levels 155
 - paper jam 155
 - setting up 155
- e-mail function
 - setting up 66
- E-mail Settings menu 103
- e-mail shortcuts, creating
 - using the Embedded Web Server 67
- e-mail, sending
 - using a shortcut number 67
 - using the printer control panel 67
- e-mailing
 - configuring e-mail settings 66
 - creating shortcuts using the Embedded Web Server 67
 - setting up e-mail function 66
 - using a shortcut number 67
 - using the printer control panel 67

F

- factory defaults, restoring 157
- FAQ about color printing 210
- FCC notices 229
- finding more information about the printer 8
- Finishing menu 111
- firmware cards 14
- font sample list
 - printing 54
- fonts card 14
- FTP address, scanning to
 - using a shortcut 70
- FTP Settings menu 107

G

- General Settings menu 95
- Google Cloud Print
 - using 52
- green settings
 - Eco-Mode 122
 - Hibernate mode 124
 - Hibernate Timeout 125
 - Quiet mode 123
 - Schedule Power Modes 125

H

- hardware options, adding
 - print driver 24
- held jobs 52
 - printing from a Macintosh computer 53
 - printing from Windows 53
- held print jobs
 - printing from a Macintosh computer 53
 - printing from Windows 53
- Help menu 121
- Hibernate mode
 - using 124
- Hibernate Timeout
 - setting 125
- home button
 - printer control panel 12
- HTML menu 120

I

- Image menu 121
- imaging kit
 - replacing 138
- imaging kits
 - ordering 133
- Incompatible tray [x] [59] 170
- Incorrect paper size, open [paper source] [34] 170
- indicator light
 - printer control panel 12
- individual settings
 - erasing 128
- Insert Tray [x] 171
- installing an optional card 19
- installing options
 - order of installation 20
- installing the printer software 23
- Insufficient memory to collate job [37] 171
- Insufficient memory to support Resource Save feature [35] 171
- Insufficient memory, some Held Jobs were deleted [37] 171
- Insufficient memory, some held jobs will not be restored [37] 171
- interior of the printer
 - cleaning 129
- internal options 14
- internal options, adding
 - print driver 24

- IPv6 menu 88

J

- jams
 - avoiding 158
 - locating jam areas 159
 - locations 159
- jams, clearing
 - below the fuser 162
 - in the automatic document feeder 166
 - in the duplex unit 162
 - in the front door 162
 - in the manual feeder 165
 - in the multipurpose feeder 165
 - in the standard bin 161
 - in trays 164

K

- keypad
 - printer control panel 12

L

- labels, paper
 - tips 42
- letterhead
 - copying on 57
 - loading, multipurpose feeder 40
 - loading, trays 40
- Lexmark Mobile Print
 - using 52
- linking trays 37
 - assigning custom paper type names 38
- Load [paper source] with [custom string] 172
- Load [paper source] with [custom type name] 171
- Load [paper source] with [paper size] 172
- Load [paper source] with [paper type] [paper size] 172
- Load Manual Feeder with [custom string] 172
- Load Manual Feeder with [custom type name] 173
- Load Manual Feeder with [paper size] 173
- Load Manual Feeder with [paper type] [paper size] 173

- loading
 - 250-sheet tray 29
 - 650-sheet duo tray 29, 33
 - card stock 34
 - envelopes 32, 34
 - manual feeder 32
 - multipurpose feeder 34
 - transparencies 34
- loading letterhead
 - paper orientation 40
- lock, security 127

M

- maintenance kit
 - ordering 134
- Maintenance kit low [80.xy] 173
- Maintenance kit nearly low [80.xy] 173
- Maintenance kit very low [80.xy] 173
- manual feeder
 - loading 32
- Max Speed and Max Yield
 - using 51
- memory
 - types installed on printer 127
- memory card 14
 - installing 17
- Memory full [38] 174
- menu settings
 - loading on multiple printers 157
- menu settings page
 - printing 28
- menus
 - Active NIC 84
 - AppleTalk 89
 - Confidential Print 92
 - Copy Settings 99
 - Custom Scan Sizes 83
 - Custom Types 82
 - Default Source 74
 - E-mail Settings 103
 - Finishing 111
 - FTP Settings 107
 - General Settings 95
 - Help 121
 - HTML 120
 - Image 121
 - IPv6 88
 - list of 73
 - Network [x] 85
 - Network Card 86

- Network Reports 86
- Paper Loading 81
- Paper Size/Type 75
- Paper Texture 78
- Paper Weight 79
- PCL Emul 117
- PDF 116
- PostScript 116
- Quality 113
- Reports 84
- Security Audit Log 93
- Set Date and Time 93
- Setup 110
- SMTP Setup menu 91
- Standard Network 85
- Standard USB 90
- Substitute Size 78
- Supplies 74
- TCP/IP 87
- Universal Setup 83
- Utilities 116
- Wireless 89
- XPS 116
- menus list 73
- mobile device
 - printing from 51, 52
- Mopria Print Service
 - using 51
- moving the printer 9, 153
- multiple pages on one sheet 62
- multipurpose feeder
 - loading 34

N

- Network [x] menu 85
- Network [x] software error [54] 174
- Network Card menu 86
- Network Reports menu 86
- network settings
 - Embedded Web Server 155
- network setup page
 - printing 28
- Networking Guide
 - where to find 155
- noise emission levels 226
- noise, printer
 - reducing 123
- Non-Lexmark [supply type], see User's Guide [33.xy] 174
- non-volatile memory 127
 - erasing 128

- Not enough free space in flash memory for resources [52] 174
- notices 226, 227, 228, 229, 230
- number of remaining pages
 - estimate 131

O

- optional card
 - installing 19
- options
 - 650-sheet duo tray 21
 - firmware cards 14
 - fonts card 14
 - memory card 14, 17
- options, touch-screen
 - copy 65
- ordering
 - imaging kits 133
 - maintenance kit 134
 - toner cartridges 132
 - waste toner bottle 134
- overlay
 - copy options 65
- overlay message, adding
 - copying 62

P

- paper
 - characteristics 43
 - letterhead 45
 - preprinted forms 45
 - recycled 45, 122
 - selecting 44
 - setting size 29
 - setting type 29
 - storing 45
 - unacceptable 44
 - Universal size setting 29
- paper feed troubleshooting
 - message remains after jam is cleared 186
- paper jams
 - avoiding 158
- paper jams, clearing
 - below the fuser 162
 - in the automatic document feeder 166
 - in the duplex unit 162
 - in the front door 162
 - in the manual feeder 165
 - in the multipurpose feeder 165

- in the standard bin 161
- in trays 164
- Paper Loading menu 81
- paper saver
 - copy options 65
- Paper Size/Type menu 75
- paper sizes
 - supported by the printer 46
- Paper Texture menu 78
- paper types
 - supported by printer 48
 - where to load 48
- Paper Weight menu 79
- paper weights
 - supported by printer 48
- parts
 - checking status 131
 - checking, using the Embedded Web Server 131
 - using genuine Lexmark 132
- parts and supplies, status of
 - checking, on printer control panel 131
- PCL Emul menu 117
- PDF menu 116
- Personal Identification Number method
 - using 26
- photos
 - copying 56
- placing separator sheets
 - between copies 61
- PostScript menu 116
- power cord socket 22
- preparing to set up the printer on an Ethernet network 24
- print driver
 - hardware options, adding 24
- print irregularities 198
- print job
 - canceling from the computer 54
 - canceling from the printer control panel 54
- print quality
 - cleaning the scanner glass 130
 - replacing a developer unit 147
 - replacing imaging kit 138
 - replacing the waste toner bottle 134
- print quality troubleshooting
 - blank pages 202
 - characters have jagged edges 193
 - clipped pages or images 193
 - gray background on prints 194
 - horizontal voids appear on prints 195
 - print irregularities 198
 - print is too dark 199
 - print is too light 200
 - printer is printing solid black pages 202
 - repeating print defects 203
 - shadow images appear on prints 204
 - skewed print 204
 - streaked horizontal lines appear on prints 205
 - streaked vertical lines appear on prints 206
 - toner fog or background shading appears on prints 207
 - toner rubs off 208
 - transparency print quality is poor 209
 - uneven print density 209
 - vertical voids appear on prints 209
- print troubleshooting
 - held jobs do not print 187
 - incorrect characters print 188
 - incorrect margins on prints 196
 - jammed pages are not reprinted 185
 - job prints from wrong tray 188
 - job prints on wrong paper 188
 - jobs do not print 190
 - Large jobs do not collate 189
 - multiple-language PDF files do not print 189
 - paper curl 197
 - paper frequently jams 185
 - print job takes longer than expected 191
 - tray linking does not work 192
 - unexpected page breaks occur 192
- printer
 - configurations 10
 - minimum clearances 9
 - models 10
 - moving 9, 153
 - selecting a location 9
 - shipping 154
- printer control panel
 - factory defaults, restoring 157
 - indicator light 13
 - parts 12
 - Sleep button light 13
 - using 12
- printer control panel, virtual display
 - using the Embedded Web Server 155
- Printer had to restart. Last job may be incomplete. 175
- printer information
 - where to find 8
- printer is printing blank pages 202
- printer messages
 - [Color] cartridge low [88.xy] 169
 - [Color] cartridge nearly low [88.xy] 169
 - [Color] cartridge very low, [x] estimated pages remain [88.xy] 169
 - [Type] imaging kit low [84.xy] 180
 - [Type] imaging kit nearly low [84.xy] 180
 - [Type] imaging kit very low, [x] estimated pages remain [84.xy] 180
- Adjusting color 168
- Change [paper source] to [custom string] 168
- Change [paper source] to [custom type name] 168
- Change [paper source] to [paper type] [paper size] 168
- Close door 168
- Close flatbed cover and load originals if restarting job [2yy.xx] 169
- Complex page, some data may not have printed [39] 169
- Configuration change, some held jobs were not restored [57] 170
- Defective flash detected [51] 170
- Error reading USB drive. Remove USB. 170

- Error reading USB hub. Remove hub. 170
 - Incompatible tray [x] [59] 170
 - Incorrect paper size, open [paper source] [34] 170
 - Insert Tray [x] 171
 - Insufficient memory to collate job [37] 171
 - Insufficient memory to support Resource Save feature [35] 171
 - Insufficient memory, some Held Jobs were deleted [37] 171
 - Insufficient memory, some held jobs will not be restored [37] 171
 - Load [paper source] with [custom string] 172
 - Load [paper source] with [custom type name] 171
 - Load [paper source] with [paper size] 172
 - Load [paper source] with [paper type] [paper size] 172
 - Load Manual Feeder with [custom string] 172
 - Load Manual Feeder with [custom type name] 173
 - Load Manual Feeder with [paper size] 173
 - Load Manual Feeder with [paper type] [paper size] 173
 - Maintenance kit low [80.xy] 173
 - Maintenance kit nearly low [80.xy] 173
 - Maintenance kit very low [80.xy] 173
 - Memory full [38] 174
 - Network [x] software error [54] 174
 - Non-Lexmark [supply type], see User's Guide [33.xy] 174
 - Not enough free space in flash memory for resources [52] 174
 - Printer had to restart. Last job may be incomplete. 175
 - Reinstall missing or unresponsive [color] cartridge [31.xy] 175
 - Reload printed pages in Tray [x] 175
 - Remove packaging material, [area name] 176
 - Remove paper from standard output bin 176
 - Replace [type] imaging kit, 0 estimated pages remain [84.xy] 176
 - Replace all originals if restarting job. 176
 - Replace jammed originals if restarting job. 176
 - Replace maintenance kit [80.xy] 177
 - Replace missing [type] imaging kit [31.xy] 177
 - Replace missing or unresponsive black and color imaging kit and all cartridges [31.xy] 175
 - Replace missing waste toner bottle [31.xyz] 177
 - Replace unsupported [color] cartridge [32.xy] 177
 - Replace unsupported black and color imaging kit [32.xy] 178
 - Replace waste toner bottle [82.xy] 178
 - Scanner automatic feeder cover open 178
 - Scanner disabled by admin [840.01] 178
 - Scanner disabled. Contact system administrator if problem persists. [840.02] 178
 - Scanner jam, remove all originals from the scanner [2yy.xx] 179
 - Scanner jam, remove jammed originals from the scanner [2yy.xx] 179
 - SMTP server not set up. Contact system administrator. 179
 - Standard network software error [54] 179
 - Standard USB port disabled [56] 179
 - Supply needed to complete job 179
 - Too many flash options installed [58] 180
 - Too many trays attached [58] 180
 - Unformatted flash detected [53] 181
 - Unsupported USB hub, please remove 170
 - Waste toner bottle nearly full [82.xy] 181
 - Weblink server not set up. Contact system administrator. 181
 - printer options troubleshooting
 - internal option is not detected 183
 - tray problems 184
 - printer problems, solving
 - basic 181
 - printer security
 - information on 128
 - printer software, installing 23
 - printing
 - black-and-white 50
 - faster speed vs. higher yield 51
 - font sample list 54
 - from a computer 50
 - from a mobile device 51, 52
 - Max Speed and Max Yield 51
 - menu settings page 28
 - network setup page 28
 - printing a network setup page 28
 - printing held jobs
 - from a Macintosh computer 53
 - from Windows 53
 - printing in black and white 50
 - publications
 - where to find 8
 - Push Button Configuration method
 - using 26
- Q**
- Quality menu 113
 - Quiet mode 123
- R**
- recycled paper
 - using 45, 122
 - recycling
 - Lexmark packaging 126
 - Lexmark products 126
 - toner cartridges 126
 - reducing a copy 59
 - reducing noise 123

- Reinstall missing or unresponsive [color] cartridge [31.xy] 175
- Reload printed pages in Tray [x] 175
- Remove packaging material, [area name] 176
- Remove paper from standard output bin 176
- repeat print jobs 52
- repeating print defects 203
- Replace [type] imaging kit, 0 estimated pages remain [84.xy] 176
- Replace all originals if restarting job. 176
- Replace jammed originals if restarting job. 176
- Replace maintenance kit [80.xy] 177
- Replace missing [type] imaging kit [31.xy] 177
- Replace missing or unresponsive black and color imaging kit and all cartridges [31.xy] 175
- Replace missing waste toner bottle [31.xyz] 177
- Replace unsupported [color] cartridge [32.xy] 177
- Replace unsupported black and color imaging kit [32.xy] 178
- Replace waste toner bottle [82.xy] 178
- reports
 - viewing 156
- Reports menu 84
- reserve print jobs 52
 - printing from Windows 53
- S**
- safety information 6, 7
- scale
 - copy options 64
- scan troubleshooting
 - cannot scan from a computer 221
 - partial document or photo scans 220
 - scan job was not successful 218
 - scanner unit does not close 214, 219
 - scanning takes too long or freezes the computer 219
- scanner
 - Automatic document feeder (ADF) 12
 - functions 11
 - scanner glass 12
- Scanner automatic feeder cover open 178
- Scanner disabled by admin [840.01] 178
- Scanner disabled. Contact system administrator if problem persists. [840.02] 178
- scanner glass
 - cleaning 130
 - copying using 56
- Scanner jam, remove all originals from the scanner [2yy.xx] 179
- Scanner jam, remove jammed originals from the scanner [2yy.xx] 179
- scanning
 - quick copy 55
 - to a computer 71
 - scanning to a computer 71
 - scanning to an FTP address
 - creating shortcuts using the computer 69
 - using a shortcut 70
 - using the printer control panel 70
 - scanning, FTP address
 - using the printer control panel 70
- Schedule Power Modes using 125
- security
 - modifying confidential print settings 53
- Security Audit Log menu 93
- security lock 127
- security lock port 22
- security settings
 - erasing 128
- security Web page
 - where to find 128
- select button
 - printer control panel 12
- selecting a location for the printer 9
- selecting paper 44
- separator sheets
 - copy options 65
- Set Date and Time menu 93
- setting
 - paper size 29
 - paper type 29
 - TCP/IP address 87
- setting Hibernate Timeout 125
- setting up e-mail alerts 155
- Setup menu 110
- shipping the printer 154
- shortcuts, creating
 - e-mail 67
 - FTP destination 69
- sleep button
 - printer control panel 12
- Sleep mode
 - adjusting 124
- SMTP server not set up. Contact system administrator. 179
- SMTP Setup menu 91
- Standard Network menu 85
- Standard network software error [54] 179
- standard tray
 - loading 29
- Standard USB menu 90
- Standard USB port disabled [56] 179
- statement of volatility 127
- status of parts and supplies
 - checking 131
- storing
 - paper 45
 - supplies 129
- storing print jobs 52
- streaked horizontal lines appear on prints 205
- streaked vertical lines appear on prints 206
- Substitute Size menu 78
- supplies
 - checking status 131
 - checking, using the Embedded Web Server 131
 - conserving 122
 - storing 129
 - using genuine Lexmark 132
 - using recycled paper 122
- Supplies menu 74
- supplies, ordering
 - imaging kits 133

- maintenance kit 134
- toner cartridges 132
- waste toner bottle 134
- Supply needed to complete job 179
- supply notifications
 - configuring 156

T

- TCP/IP menu 87
- the scanner does not respond 217
- tips
 - card stock 43
 - labels, paper 42
 - on using envelopes 42
 - on using letterhead 40
 - transparencies 41
- tips on using envelopes 42
- tips on using letterhead 40
- toner cartridges
 - ordering 132
 - recycling 126
 - replacing 145
- toner darkness
 - adjusting 50
- Too many flash options installed [58] 180
- Too many trays attached [58] 180
- transparencies
 - copying on 56
 - loading 34
 - tips on using 41
- trays
 - linking 37
 - unlinking 37
- troubleshooting
 - cannot open Embedded Web Server 221
 - checking an unresponsive printer 181
 - FAQ about color printing 210
 - solving basic printer problems 181
 - the scanner does not respond 217
- troubleshooting, color quality
 - color of print and color on computer screen do not match 213
 - print appears tinted 213

- prints on color transparencies
 - appear dark when projected 212
- troubleshooting, copy
 - copier does not respond 214
 - partial document or photo copies 216
 - poor copy quality 215
 - poor scanned image quality 219
 - scanner unit does not close 214, 219
- troubleshooting, display
 - printer display is blank 183
- troubleshooting, paper feed
 - message remains after jam is cleared 186
- troubleshooting, print
 - held jobs do not print 187
 - incorrect characters print 188
 - incorrect margins on prints 196
 - jammed pages are not reprinted 185
 - job prints from wrong tray 188
 - job prints on wrong paper 188
 - jobs do not print 190
 - Large jobs do not collate 189
 - multiple-language PDF files do not print 189
 - paper curl 197
 - paper frequently jams 185
 - print job takes longer than expected 191
 - tray linking does not work 192
 - unexpected page breaks occur 192
- troubleshooting, print quality
 - blank pages 202
 - characters have jagged edges 193
 - clipped pages or images 193
 - gray background on prints 194
 - horizontal voids appear on prints 195
 - print irregularities 198
 - print is too dark 199
 - print is too light 200
 - printer is printing solid black pages 202
 - repeating print defects 203
 - shadow images appear on prints 204

- skewed print 204
- streaked horizontal lines appear on prints 205
- streaked vertical lines appear on prints 206
- toner fog or background shading appears on prints 207
- toner rubs off 208
- transparency print quality is poor 209
- uneven print density 209
- vertical voids appear on prints 209
- troubleshooting, printer options
 - internal option is not detected 183
 - tray problems 184
- troubleshooting, scan
 - cannot scan from a computer 221
 - partial document or photo scans 220
 - scan job was not successful 218
 - scanner unit does not close 214, 219
 - scanning takes too long or freezes the computer 219

U

- unacceptable paper 44
- uneven print density 209
- Unformatted flash detected [53] 181
- Universal paper size settings
 - configuring 29
- Universal Setup menu 83
- unlinking trays 37
- Unsupported USB hub, please remove 170
- USB port 22
- using Hibernate mode 124
- using Max Speed and Max Yield 51
- using Schedule Power Modes 125
- using the printer control panel 12
- Utilities menu 116

V

- verify print jobs 52
- vertical voids appear on prints 209
- viewing
 - reports 156
- virtual display
 - checking, using Embedded Web Server 155
- volatile memory 127
 - erasing 128
- volatility
 - statement of 127

W

- waste toner bottle
 - ordering 134
 - replacing 134
- Waste toner bottle nearly full [82.xy] 181
- Weblink server not set up. Contact system administrator. 181
- Wireless menu 89
- wireless network
 - configuration information 25
- wireless network setup
 - using the Embedded Web Server 27
- wireless setup wizard
 - using 26

X

- XPS menu 116