



Integrator's Complete Guide to

RoboSHOT 12 HDBT and RoboSHOT 30 HDBT

High-Performance PTZ Cameras

Document 411-0003-30 Rev. C

February 2017

Contents

Overview	1
What's in this Guide	1
Camera Features	1
Unpacking the Camera	2
A Quick Look at the Camera	5
Front of the Camera	5
Back of the Camera	6
Switch Settings	6
Video Resolution	6
Camera Settings	7
Installation	8
Before You Install the Camera	8
Don't Void Your Warranty!	8
Cabling Notes	9
Installing the Wall Mount	10
About Ceiling-Mounted Cameras	10
Basic Connection Diagram	11
Options for Power and Other Connections	11
Installing the Camera	12
Powering Up the Camera	13
Vaddio IR Remote Commander	14
IR Remote Cheat Sheet	14
IR Remote Details	15
Storing a Preset Using the IR Remote Commander	15
Clearing a Preset Using the IR Remote Commander	15
Getting the Camera's IP Address	15
Web Interface	16
Compatible Web Browsers	16
User Access	17
Administrative Access	18
Web Interface Cheat Sheet	19
Web Tasks for All Users: Controlling the Camera	20
Switching the Camera Off or On	21
Moving the Camera	21
Zooming In or Out	21
Changing the Focus	22
Moving the Camera to a Preset Position	23
Selecting the Appropriate Color Settings	24
Storing a Camera Preset	25
Changing the Speed of Camera Movements	26

Setting Pan Direction	27
Setting Tilt Direction	27
Web Tasks for Administrators: Setting a Custom Home Position	28
Web Tasks for Administrators: Managing Access and Passwords	29
Web Tasks for Administrators: Adding Room Information to the Web Interface	29
Web Tasks for Administrators: Configuring Network Settings	30
Specifying Time Zone and NTP Server	31
Web Tasks for Administrators: Configuring Streaming Settings	32
Enabling or Disabling Streaming	32
Editing IP Streaming Settings	33
Advanced IP Streaming Settings	34
Web Tasks for Administrators: Setting Camera Behaviors and Adjustments	35
Setting Up Custom Color and Lighting Settings	36
Renaming a Custom CCU Scene	36
Setting Pan, Tilt, and Zoom Speeds	36
Web Tasks for Administrators: Rebooting, Updating, and Resetting	37
Rebooting the Camera	37
Saving (Exporting) or Restoring (Importing) a Configuration	37
Starting a Firmware Update	38
Restoring Factory Settings	38
Reading the Camera's Back Panel Switches	39
Setting the LED Color Scheme	39
Web Tasks for Administrators: Contacting Vaddio Technical Support	40
Web Tasks for Administrators: Viewing Diagnostic Logs	41
Telnet Serial Command API	42
camera home	43
camera pan	43
camera tilt	44
camera zoom	44
camera focus	45
camera preset	46
camera ccu get	47
camera ccu set	48
camera ccu scene	49
camera standby	49
streaming settings get	50
network settings get	50
network ping	51
system reboot	51
system factory-reset	52
sleep	52

history	53
version	53
help	54
exit	54
RS-232 Serial Communication	55
RS-232 Command List	56
Command Setting Values	63
Exposure Compensation	63
Shutter Speed Values	64
Iris Position Values	65
Iris Gain Values	66
Iris Gain Limit Values	66
RS-232 Inquiry Command List	67
Specifications	71
Troubleshooting and Care	72
Operation, Storage, and Care	73
Compliance Statements and Declarations of Conformity	74
FCC Part 15 Compliance	74
ICES-003 Compliance	74
European Compliance	75
Warranty Information	76
Index	77

Overview

This guide covers the RoboSHOT™ 12 and 30 HDBT PTZ cameras:

- RoboSHOT 12 HDBT (silver), North America – 999-9960-000
- RoboSHOT 12 HDBT (silver), Europe and UK – 999-9960-001
- RoboSHOT 12 HDBT (silver), Australia and New Zealand – 999-9960-009
- RoboSHOT 30 HDBT (black), North America – 999-9963-000
- RoboSHOT 30 HDBT (black), Europe and UK – 999-9963-001
- RoboSHOT 30 HDBT (black), Australia and New Zealand – 999-9963-009
- RoboSHOT 30 HDBT (white), North America – 999-9963-000W
- RoboSHOT 30 HDBT (white), Europe and UK – 999-9963-001W
- RoboSHOT 30 HDBT (white), Australia and New Zealand – 999-9963-009W



What's in this Guide

This guide covers:

- Unpacking and installation
- The camera's physical features
- Controlling the camera using the IR remote or web interface
- Controlling the camera using Telnet or RS-232 commands
- Specifications
- Troubleshooting and maintenance
- Warranty and compliance/conformity information

For your convenience, this information is also available in smaller, limited-purpose manuals:

- **Installation Guide for RoboSHOT HDBT High-Performance PTZ Cameras** (unpacking, physical features, switch settings, installation, initial power-up)
- **Configuration and Administration Guide for RoboSHOT HDBT High-Performance PTZ Cameras** (physical features, controlling the camera, troubleshooting, and specifications)

Download manuals, dimensional drawings, and other information from www.vaddio.com/support.

Camera Features

- RoboSHOT 12 HDBT: Exmor® 1/2.8 type, high-speed, low-noise image sensor; 12X optical zoom; 73° horizontal field of view in wide mode – perfect for small to medium rooms
- RoboSHOT 30 HDBT: Exmor R™ back-lit 1/2.8 type, high-speed, low-noise image sensor; 30X optical zoom; 65° horizontal field of view for medium to large venues – houses of worship, lecture theaters, IMAG systems
- 2.38 megapixels total, full HD (native 1080p/60)
- Improved color mapping for true, vivid color
- IP H.264 streaming – view real-time video from the camera using any standards-based media viewer
- Tri-Synchronous Motion™ simultaneous 3-axis pan/tilt/zoom movement between presets
- Smooth, silent direct-drive motors – ultra-accurate positioning, from 120° per second down to 0.35° per second
- Designed for use with the Vaddio OneLINK™ HDMI extension module for HDBaseT Cameras
- Web interface for remote administration and operation, integration-ready Telnet or RS-232 control, presenter-friendly IR remote control

Unpacking the Camera

Make sure you received all the items you expected. Here are the packing lists for the RoboSHOT HDBT cameras.



Caution

Always support the camera's base when picking it up. Lifting the camera by its head or mounting arm will damage it.

RoboSHOT 12 HDBT, North America – 999-9960-000

- RoboSHOT 12 HDBT Camera (998-9960-000)
- Thin Profile Wall Mount with Mounting Hardware (535-2000-240)
- Vaddio IR Remote Commander (998-2100-000)
- 12 VDC, 3.0 Amp Switching Power Supply
- AC Cord Set for North America
- Quick-Start Guide (342-1219)



RoboSHOT 12 HDBT, Europe and UK – 999-9960-001

- RoboSHOT 12 HDBT Camera (998-9960-000)
- Thin Profile Wall Mount with Mounting Hardware (535-2000-240)
- Vaddio IR Remote Commander (998-2100-000)
- 12 VDC, 3.0 Amp Switching Power Supply
- Euro Power Cord
- UK Power Cord
- Quick-Start Guide (342-1219)



RoboSHOT 12 HDBT, Australia and New Zealand – 999-9960-009

- RoboSHOT 12 HDBT Camera (998-9960-000)
- Thin Profile Wall Mount with Mounting Hardware (535-2000-240)
- Vaddio IR Remote Commander (998-2100-000)
- 12 VDC, 3.0 Amp Switching Power Supply
- Power Cord for Australia and New Zealand
- Quick-Start Guide (342-1219)



RoboSHOT 30 HDBT, North America, black – 999-9963-000

RoboSHOT 30 HDBT, North America, white – 999-9963-000W

- RoboSHOT 30 HDBT Camera (998-9963-000 or 998-9963-000W)
- Thin Profile Wall Mount with Mounting Hardware, black or white depending on camera color (535-2000-240 or 535-2000-240W)
- Vaddio IR Remote Commander (998-2100-000)
- 12 VDC, 3.0 Amp Switching Power Supply
- AC Cord Set for North America
- Quick-Start Guide (342-1219)



OR



RoboSHOT 30 HDBT, Europe and UK, black – 999-9963-001

RoboSHOT 30 HDBT, Europe and UK, white – 999-9963-001W

- RoboSHOT 30 HDBT Camera
- Thin Profile Wall Mount with Mounting Hardware, black or white depending on camera color (535-2000-240 or 535-2000-240W)
- Vaddio IR Remote Commander (998-2100-000)
- 12 VDC, 3.0 Amp Switching Power Supply
- Euro Power Cord
- UK Power Cord
- Quick-Start Guide (342-1219)



OR



RoboSHOT 30 HDBT, Australia and New Zealand, black – 999-9963-009

RoboSHOT 30 HDBT, Australia and New Zealand, white – 999-9963-009W

- RoboSHOT 30 HDBT Camera
- Thin Profile Wall Mount with Mounting Hardware, black or white depending on camera color (535-2000-240 or 535-2000-240W)
- Vaddio IR Remote Commander (998-2100-000)
- 12 VDC, 3.0 Amp Switching Power Supply
- Power Cord for Australia and New Zealand
- Quick-Start Guide (342-1219)



OR



Download manuals, dimensional drawings, and other information from www.vaddio.com/support.

A Quick Look at the Camera

The RoboSHOT 12 and 30 models are similar. The RoboSHOT 12 is the camera on the left in the photo.

Front of the Camera



- **Camera and Zoom Lens:** The 12 and 30 models use different optical components.
 - RoboSHOT 12 HDBT: 12X optical zoom lens (12X in Super-Wide mode and 10X in normal mode), Exmor 1/2.8-type, high-speed, low noise image sensor
 - RoboSHOT 30 HDBT: 30X optical zoom lens, Exmor-R 1/2.8 type, backlit, high-speed, low-noise, image sensor
- **IR Sensors:** Sensors in the front of the camera base receive signals from the remote. Make sure there's nothing directly in front of the camera base, and point the remote at the camera.
- **Status indicator:** The multicolored LED indicates the camera's current state.
 - **Blue:** Normal operation (blinks off momentarily when the camera receives a command from the remote)
 - **Purple:** In standby mode or booting
 - **Yellow:** Firmware update in progress
 - **Flashing purple:** Error
 - **Red:** On-air tally

Caution

Do not remove power or reset the camera while the indicator is yellow, showing a firmware update in progress. Interrupting a firmware update can make the camera unusable.

Back of the Camera

Rear panel connections are identical for both models.

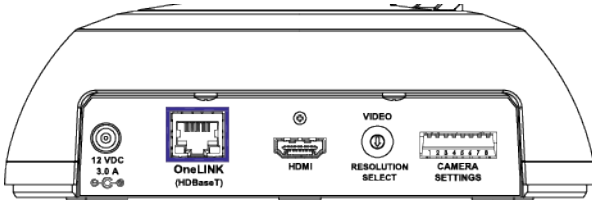

From left to right:

- **Power connector:** If not using a OneLINK HDMI extension module, use the 12 VDC, 3.0 A power supply shipped with the camera.
- **OneLINK HDBaseT/Network RJ-45 connector:** If not using a OneLINK HDMI extension module, connect to the network.
- **HDMI connector:** HDMI video output; connect to a display if not using a OneLINK HDMI extension module.
- **Video Resolution Select switch:** Select the video output resolution.
- **Camera Settings DIP switches:** Settings for IR remote frequency, baud rate and image flip.

Switch Settings

RoboSHOT cameras use a rotary switch to set the video resolution and a set of DIP switches that determine certain camera functions. A label on the bottom of the camera provides a quick reference for setting the switches.

Note

Set the switches appropriately before mounting the camera.

Video Resolution

Set the desired output resolution for the camera with the rotary switch. Switch positions 9 through D are not used.

Switch position	Resolution
0	720p/59.94
1	1080i/59.94
2	1080p/59.94
3	720p/60
4	1080i/60
5	1080p/60
6	720p/50
7	1080i/50
8	1080p/50
9 – D	Not used
E	1080p/30
F	1080p/25

Camera Settings

Use the DIP switches to set camera behaviors.

Note

When the camera is right side up, switches are in their default positions when they are up.

IR Frequency Selection: The IR Remote Commander can control up to three cameras in the same room independently, if they are configured with different IR frequencies. Use **switches 1 and 2** to select the frequency to identify the camera as camera 1, 2, or 3; then use the Camera Select buttons at the top of the remote to select the camera you want to control.

IR: Leave **switch 3** in the default UP position if the IR remote will be used.

Image Flip: If mounting the camera upside-down, set **switch 4** to the DOWN position: IMAGE FLIP ON.

Super Wide Mode (RoboSHOT 12 HDBT only): To use Super-wide mode, set **switch 5** to the DOWN position. This gives 12X zoom with a 73° horizontal angle of view. Normal mode provides 10X zoom with a 67.2° horizontal field of view (HFOV).

Baud Rate: Set the baud rate for RS-232 communication using **switch 6**. Most applications use 9600 bps (switch 6 UP), which is recommended when using long cable runs. Use the 38,400 bps setting (switch 6 DOWN) for short control lines only.

Leave **Switch 7** in the default UP position unless sRGB color output is needed.

Switch 8 is not currently used.

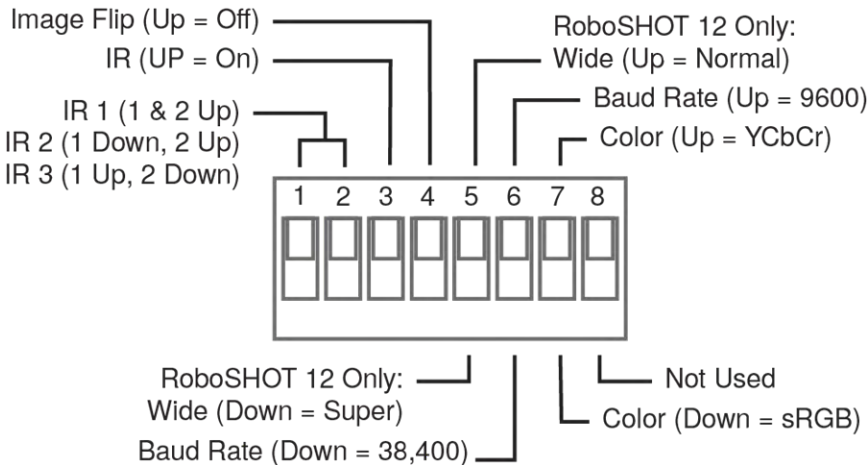

Pro Tip

Double-check switch settings before you mount the camera.

Installation

This section covers

- Siting the camera
- Installing the mount
- Connecting the camera
- Installing the camera

Before You Install the Camera

- Choose a camera mounting location that will optimize camera performance. Consider camera viewing angles, lighting conditions, line-of-sight obstructions, and in-wall obstructions where the camera is to be mounted.
- If the IR Remote Commander will be used, ensure that nothing blocks the IR lens in the camera's base.
- Ensure that the camera body can move freely and point away from the ceiling and lights.
- Follow the installation instructions included with the camera mount.

Don't Void Your Warranty!

Caution

This product is for indoor use. Do not install it outdoors or in a humid environment without the appropriate protective enclosure. Do not allow it to come into contact with any liquid.

Use only the power supply included with this product. Using a different one will void the warranty, and could create unsafe operating conditions or damage the product.

Do not install or operate this product if it has been dropped, damaged, or exposed to liquids. If any of these things happen, return it to Vaddio for safety and functional testing.

DomeVIEW enclosures are available to allow outdoor installation of RoboSHOT cameras. Learn more at www.vaddio.com/products.

Cabling Notes

Use Cat-5e or better cable and standard RJ-45 connectors (568B termination). We recommend using high-quality connectors and a high-quality crimping tool.

Caution

Check Cat-5 cables for continuity before using them. Using the wrong pin-out may damage the camera system and void the warranty.

Note

Use standard RJ-45 connectors and a good crimping tool. Do not use pass-through RJ-45 connectors. Poorly crimped connectors can damage the connectors on the product, cause intermittent connections, and degrade signal quality. Test cable pin-outs and continuity before connecting them.



Intact – Contact fingers will make reliable contact with the cable connector



Damaged – Some contact fingers are bent and will NOT make reliable contact with the cable connector



Pro Tip

To prevent tragic mishaps, label both ends of every cable.

Installing the Wall Mount

All RoboSHOT cameras include a Thin Profile Wall Mount. Other mounting options are available as well. Contact us if you don't have the camera mount you need.

You can install the camera wall mount to a 2-gang wall box or directly to the drywall.

- If you mount it to drywall, use the wall anchors provided with the wall mount.
- If you mount it to a wall box, use the cover plate screws supplied with the wall box.

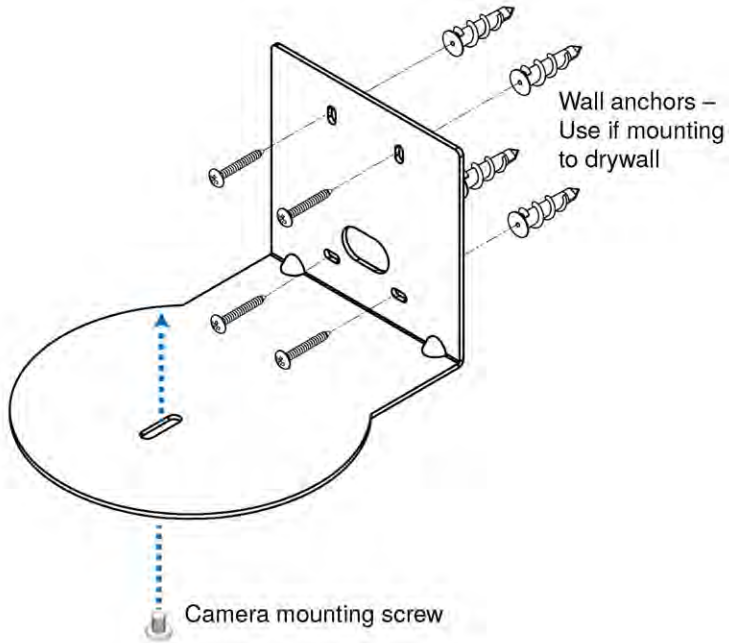

About Ceiling-Mounted Cameras

If you use an inverted mount, set the camera's Image Flip DIP switch ON for inverted operation.

See [Camera Settings](#) for more information.

Basic Connection Diagram

The Quick-Start Guide for RoboSHOT HDBT Cameras provides additional information.

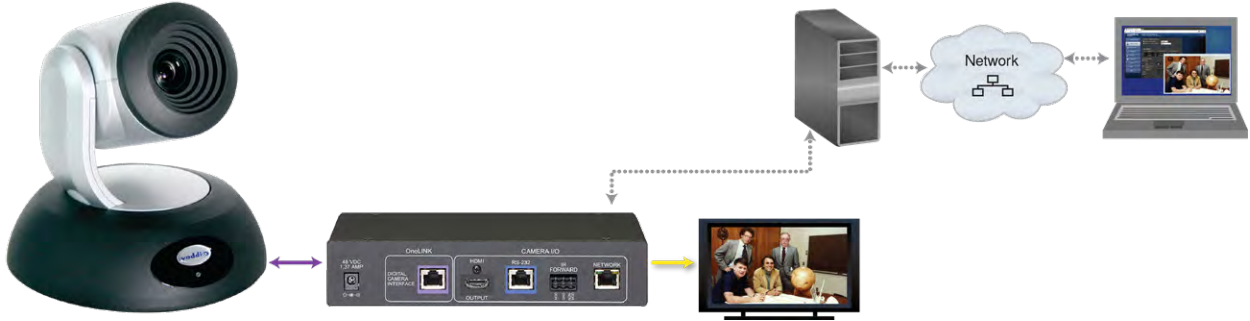

Note

The OneLINK™ HDMI extension module is not required; the camera can be connected directly to the network.

Options for Power and Other Connections

Connect the camera to a OneLINK HDMI camera extension module – a single Cat-5e (or better) cable provides power to the camera, along with HDBaseT network and video connectivity. Network, HDMI output, and RS-232 control are connected at the OneLINK module. Do not use the camera's 12 VDC power supply in this configuration.

Use the provided 12 VDC power supply – use the camera's OneLINK port to connect to the network, and connect the HDMI video output to a display.

Use a PoE+ power injector – Connect to the network through a PoE+ power injector, and connect the HDMI video output to a display. Do not use the camera's 12 VDC power supply in this configuration.

Installing the Camera

Caution

Before you start, be sure you can identify all cables correctly. Connecting a cable to the wrong port can result in equipment damage.

Caution

Check Cat-5 cables for continuity before using them. Using the wrong pin-out may damage the camera system and void the warranty.

1. Route the cables to the camera location.
2. Route the cables through the mount, and install the mount on the wall or attach it to the wall box. Leave the screws loose enough to adjust the position of the mount.
3. Level the mount and tighten the mounting screws.
4. Check the level again.
5. Connect the cables to the camera.

Caution

If using local power rather than connecting to a OneLINK extension module or using PoE+, use the power supply shipped with the camera. Using a different power supply may create an unsafe operating condition or damage the camera, and will void the warranty.

6. Ensure that the video resolution switch and the DIP switches are set appropriately. See [Switch Settings](#).
7. Place the camera on the mount.
8. Attach the camera to the mount using the 1/4"-20 x .375 mounting screw supplied with the camera.

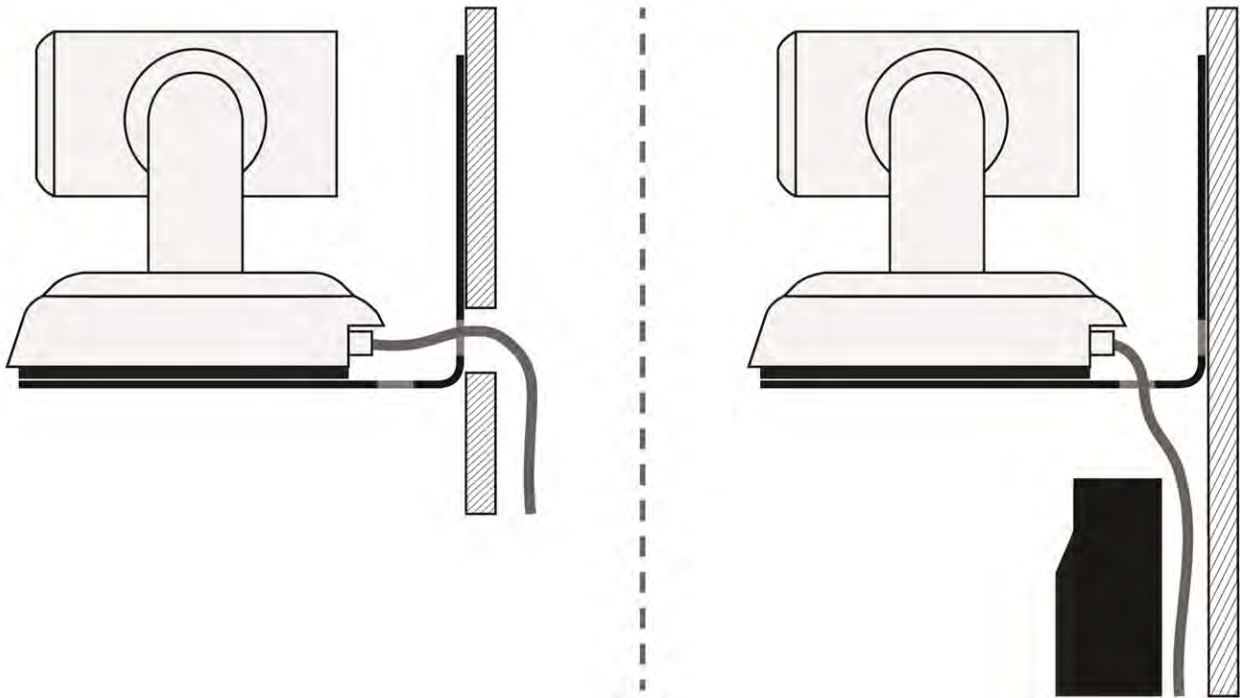

Image for illustration only; not to scale. Camera and mount details may differ.

Powering Up the Camera

Connect camera power.

The camera will wake up and initialize. This will take a few seconds. When the camera is initialized and ready, its front indicator is blue. At this point, it is ready to accept control information.

Note

Wait until the camera finishes initializing before trying to control it using the IR remote or other command input.

Vaddio IR Remote Commander

The IR remote provides basic camera control for end users.

IR Remote Cheat Sheet

What do you need to do?	Button(s)
Power on or standby	Power (green button at top right)
Select the camera to control (if this remote controls more than one)	Camera Select buttons 1 through 3 (second row on the remote)
Discover the camera's IP address	Data Screen button (top left) – press and hold for 3 seconds.
Move the camera	Arrow buttons and Home button (dark red)
Move the camera to a preset position	Position Preset buttons 1 through 6 (bottom two rows) <i>You can access additional presets from the camera's web interface.</i>
Focus the camera	Auto Focus button (near arrow buttons) Manual Focus buttons Near and Far (below Zoom Speed buttons)
Control zoom speed	Zoom Speed buttons - Slow T and W , Fast T and W for telephoto and wide-angle modes (light gray)
Adjust for excess light behind the camera's subject	Back Light button (top center)

IR Remote Details

The Vaddio remote provides the following functions:

Power – Switch the selected camera on or off.

Power indicator – Shows power on, IR transmission, and battery level.

Back Light – Use or turn off Back Light Compensation.

Data Screen – Display the camera's IP address and MAC address. Press this button again to dismiss the display.

Camera Select – In multi-camera installations, selects the camera to be controlled. See [Camera Settings](#) for information on configuring the camera as camera 1, 2, or 3.

Pan/Tilt (arrow button) controls and Home button – Control the camera's position.

Rev. Pan and Std. Pan – Control how the camera responds to the arrow buttons. Helpful for ceiling-mounted cameras and for presenters who are controlling the camera.

Pan/Tilt Reset – Not used.

Auto Focus – Switch the camera to Auto-Focus mode.

Zoom Speed – Select Slow or Fast movements for telephoto and wide-angle shots.

- **T** (slow and fast) – Telephoto
- **W** (slow and fast) – Wide-angle

Manual Focus – Switch the camera to Manual Focus mode.

Near (-) adjustment – Moves the focus nearer when in manual focus mode.

Far (+) adjustment – Moves the focus farther when in manual focus mode.

Position Presets 1 through 6 – Move the camera to a predefined position.

Preset – Save the camera's current position as one of the numbered presets.

Reset – Clear the saved position presets.

The web interface offers greater control over camera movements to presets (such as setting the speed for Tri-Synchronous Motion), and provides additional presets.



Storing a Preset Using the IR Remote Commander

Position the camera. Then hold down the Preset button and press one of the numbered preset buttons.

Clearing a Preset Using the IR Remote Commander

Press and hold the Reset button while pressing the preset number you want to clear.

Getting the Camera's IP Address

1. Press the Data Screen button on the remote. The room display presents the camera's IP address and MAC address.
2. Press the Data Screen button again to dismiss the information.

You can access the camera's web interface by entering the camera's IP address in the address bar of your browser.

Web Interface

The camera provides a web interface to allow control via an Ethernet network connection, using a browser. The web interface gives the user more control over the camera than the IR remote offers.

The web interface allows user-level camera control and password-protected administrative access to tasks such as setting passwords, changing the IP address, viewing diagnostics, and installing firmware updates.

- Administrative access – The default password is `password`. The admin has access to all pages of the web interface.
- User access – The default password is `password`. Only the camera control page is available with user-level access.

If the LAN has a DHCP server, the camera will get its IP address, gateway and routing information automatically and you will be able to browse to it. In the absence of a DHCP server, the camera's default IP address is 169.254.1.1 and its subnet mask is 255.255.255.0.

You can configure the camera's static IP address either through the network or from a computer connected directly to its Ethernet port. You may need a crossover cable.

Note

If the camera is used with a OneLINK device, the two devices have separate IP addresses and each has its own web interface.

Compatible Web Browsers

We have tested this product with these web browsers:

- Chrome®
- Microsoft® Internet Explorer®
- Safari®
- Firefox®

We test using the browser version available from the vendor at that time. Older versions of these browsers are likely to work, and other browsers may also work.

User Access

If the admin sets up automatic guest access, no login is needed – the system starts at the Camera Control page, rather than the login page. The administrative login dialog is accessible from the Camera Control page, to allow access to administrative tasks.

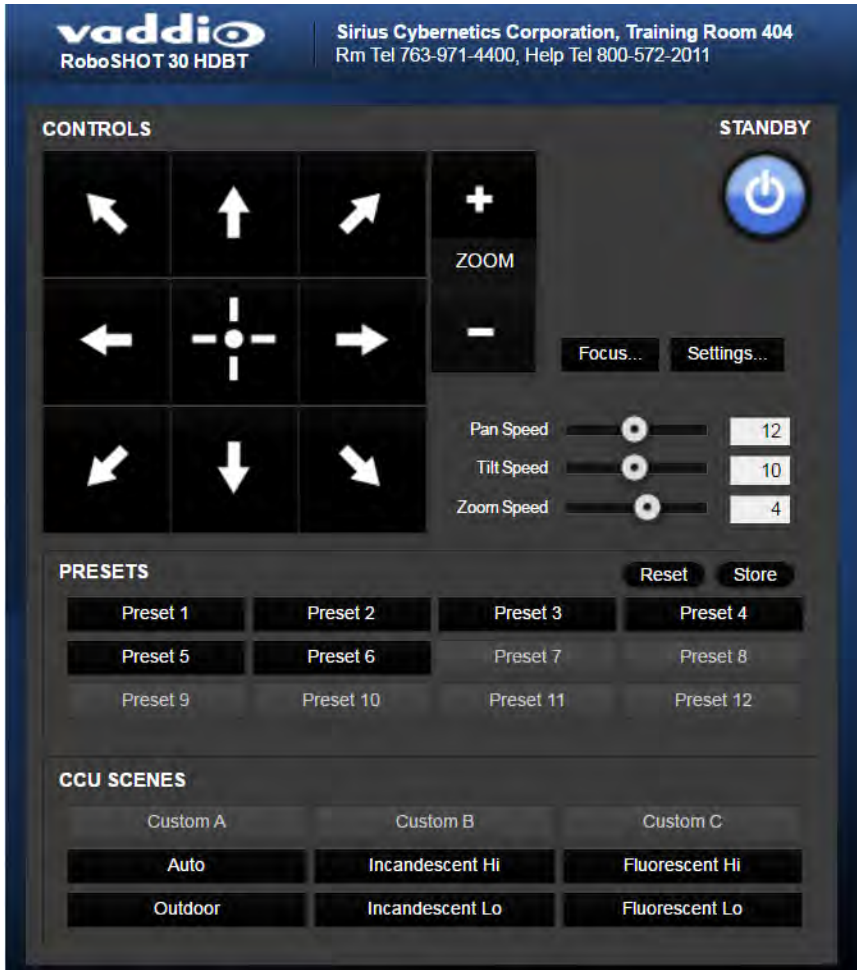

Administrative Access

If you are on the Camera Control screen and no other screens are available, you're logged in at the user level, or guest access is enabled and you're not logged on at all. Use the Admin button to open the login screen.

When you log in as Admin, all the admin menu buttons appear on the left side of the screen. In addition to Camera Controls, you also have access to:

- Camera Settings – Additional control over camera behavior related to camera movement and color management.
- Streaming – Set up IP (H.264) streaming.
- Room Labels – Add helpful information the web interface screens, such as conference room name and the in-house number for AV assistance.
- Networking – Ethernet configuration.
- Security – Set passwords and manage guest access.
- Diagnostics – Access to logs for troubleshooting.
- System – Reboot, restore defaults, view switch settings, and run updates.
- Help – Tech support contact information.

Web Interface Cheat Sheet

Where to find the camera controls you need right now.

What do you need?	Go to this screen
Camera operation <ul style="list-style-type: none"> ■ Move or zoom the camera ■ Set the speed for pan, tilt, or zoom motions ■ Focus the camera (Focus button reveals the focus control) ■ Move to a camera preset ■ Put the camera into or bring it out of standby mode 	Camera Controls
Camera behavior <ul style="list-style-type: none"> ■ Set motors for inverted operation (Settings button reveals the control) ■ Set or clear camera presets ■ Select the appropriate lighting adjustments (CCU Scenes section) 	Camera Controls
Camera behavior <ul style="list-style-type: none"> ■ Define custom lighting adjustments (CCU scenes) ■ Specify whether to use automated adjustments (auto-iris, auto white balance, backlight compensation) 	Camera Settings
Camera adjustments <ul style="list-style-type: none"> ■ Color settings (Iris, iris gain, red gain, blue gain, detail, chroma, gamma) ■ Store and label custom color settings as CCU scenes ■ Specify global speed settings for camera movements that do not use Tri-Synchronous Motion 	Camera Settings
Access management <ul style="list-style-type: none"> ■ Guest access ■ Account passwords 	Security
IP streaming settings <ul style="list-style-type: none"> ■ Quality ■ Resolution ■ Frame rate ■ Streaming URL and path 	Streaming
IP settings <ul style="list-style-type: none"> ■ Hostname ■ DHCP or static addressing ■ Static: IP address, subnet mask, gateway 	Networking
Information about the camera's current hardware switch settings	System
Time zone and NTP server (source for system time/date)	Networking
Diagnostic logs	Diagnostics
Information about the camera location	Room Labels
Helpdesk phone number for end users	Room Labels
Vaddio Technical Support contact information	Help

Web Tasks for All Users: Controlling the Camera

CAMERA CONTROLS PAGE

The Camera Controls page provides most of the same controls as the IR Remote Commander, along with some that are not available from the remote:

- Pan, tilt, zoom, or return to "home" position
- Put the camera in standby or bring it back to the ready state
- Set speeds for camera movements
- Focus manually or set auto-focus
- Set or move to camera presets
- Select one of the stored lighting adjustments
- Set the way the camera responds to the arrow buttons on the remote

Since the web interface is specific to the camera you are working with, it does not offer camera selection.

Note

Administrators can also customize the camera's home position from this page.

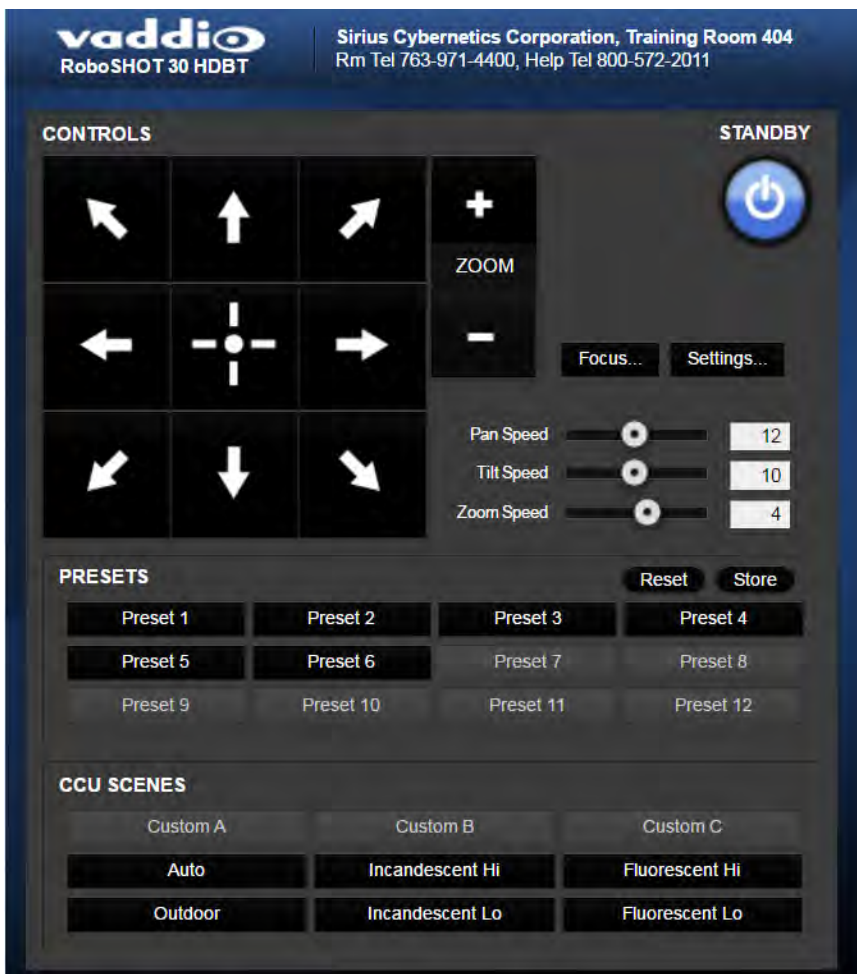

Switching the Camera Off or On

Use the Standby button to switch between low-power (standby) and ready states.

On entering standby mode, the camera moves to its standby position.

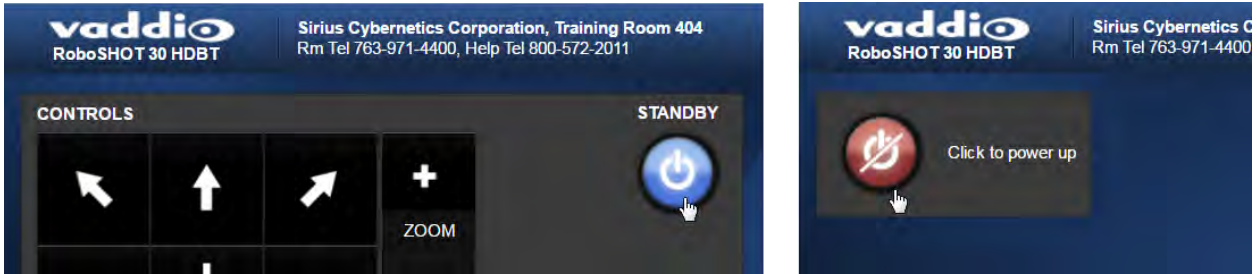

Moving the Camera

Use the arrow buttons for camera pan and tilt. The center button moves the camera to the home position.

Zooming In or Out

Use the Zoom + button to zoom in and the Zoom - button to zoom out.



Changing the Focus

Open the Focus control to select Auto-focus, or set manual focus with the + (near) and – (far) buttons. I know you get this, but I'm going to say it anyway: The + and – buttons don't work when the Auto Focus box is checked.



Moving the Camera to a Preset Position

Use the numbered Preset buttons to move the camera to any of its programmed positions. If you select a preset that has not yet been programmed, nothing happens.

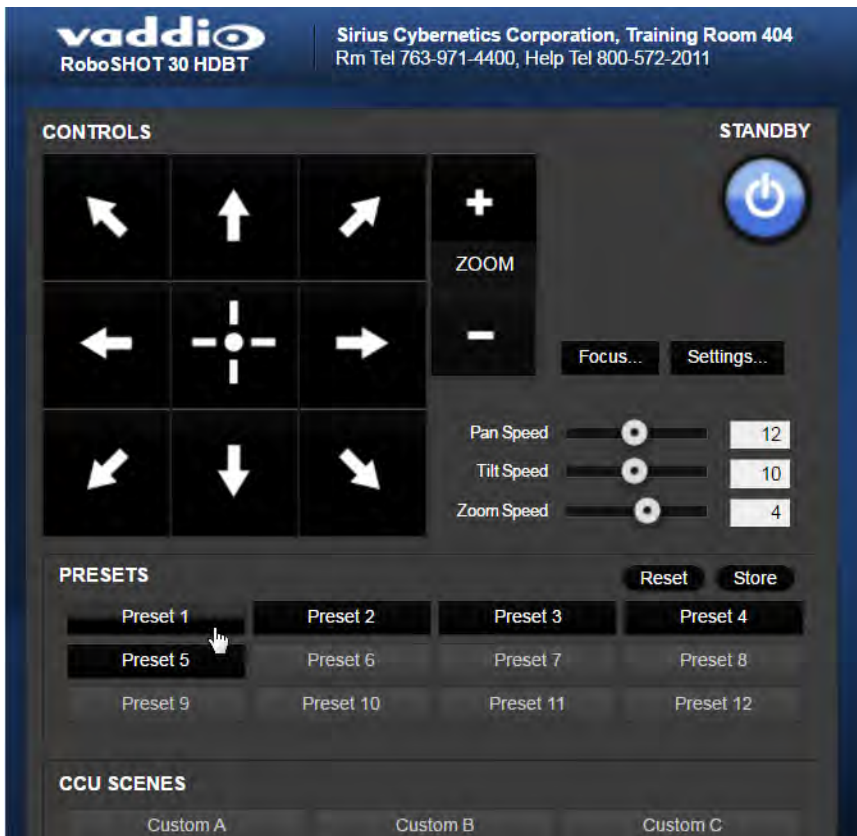

Selecting the Appropriate Color Settings

Adjust the camera for the lighting in use by selecting the CCU scene that best fits your environment. The technical folks at Vaddio (Scott, to be specific) have already set up presets for common lighting scenarios – Incandescent Hi, Incandescent Lo, Fluorescent Hi, Fluorescent Lo and Outdoor. The Auto setting allows the camera to determine the appropriate adjustments.

The first three settings in this area of the web interface (initially labeled Custom A through Custom C) can be set and renamed from the Camera Settings page, accessible to admin users.

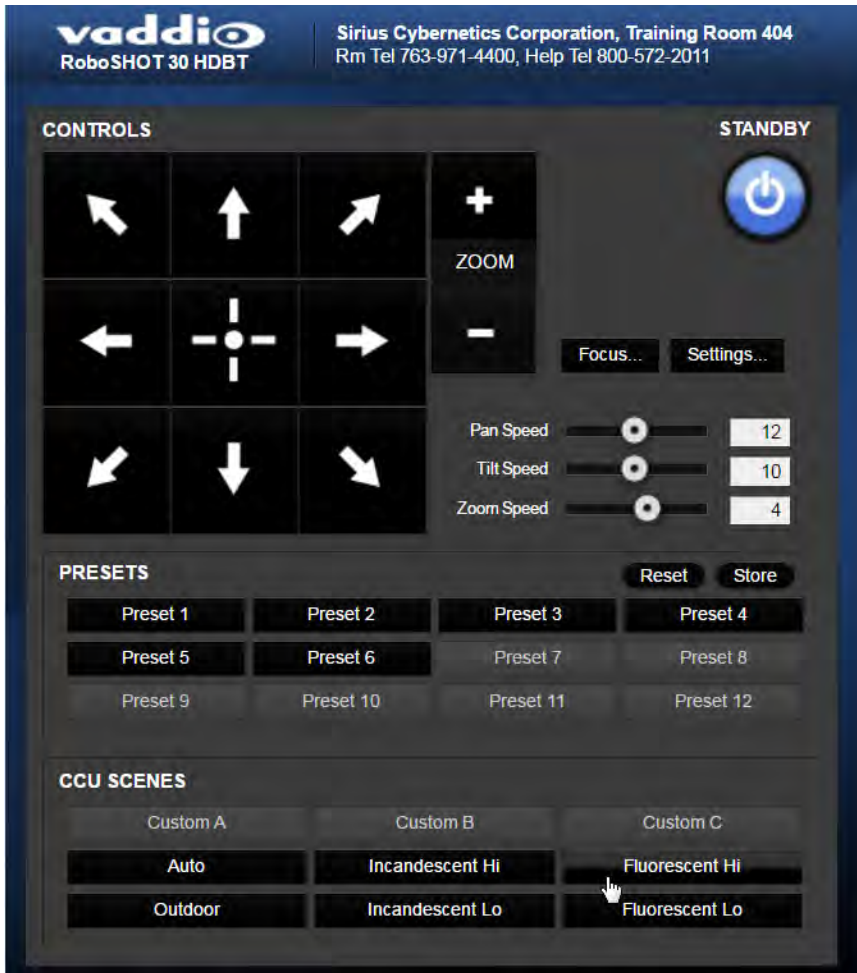

Storing a Camera Preset

1. Set up the camera shot, then use the Store button to open the Store Preset box.
2. Click one of the numbered preset buttons.
3. Check Save with Tri-Sync to allow the pan, tilt, and zoom motors to move simultaneously.
4. If necessary, use the speed slider to set Tri-Sync speed. For tight shots, slower is better.
5. To save the current color settings along with the camera position, check Save with current color settings.
6. Save the preset.

Note:

The Tri-Synchronous Motion algorithm works best for on-air shots requiring significant movement in more than one axis. It is not useful when moving the camera less than 10° or when the camera is not on the air. You may need to experiment with the Tri-Sync setting.

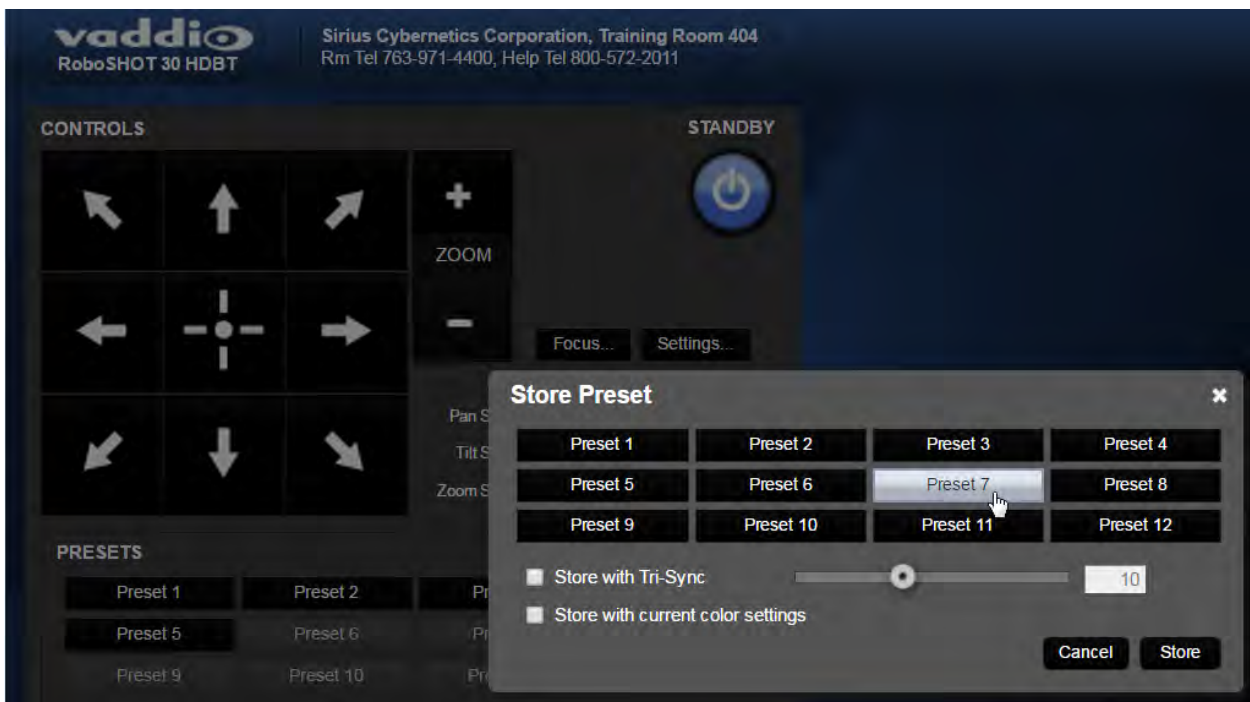

Changing the Speed of Camera Movements

Use the speed sliders to adjust the speed of movements that you control with the buttons for pan, tilt and zoom. For tight shots, slower is usually better.

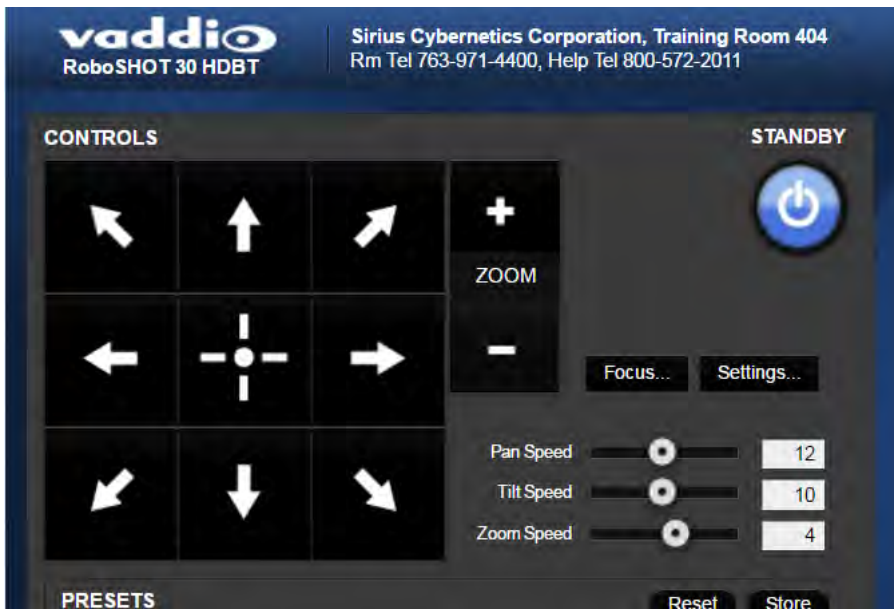

Setting Pan Direction

By default, the arrow buttons move the camera in the direction that viewers at the far end would see. If you face the camera and use the left arrow button, the camera pans to your right.

To switch the camera pan direction to the near end point of view, use the Settings button to open the pan and tilt direction box. Then set Pan Direction to Inverted.

Setting Tilt Direction

Tilt direction can also be normal or inverted. Set it according to what will be the most intuitive for the people most likely to be controlling the camera.

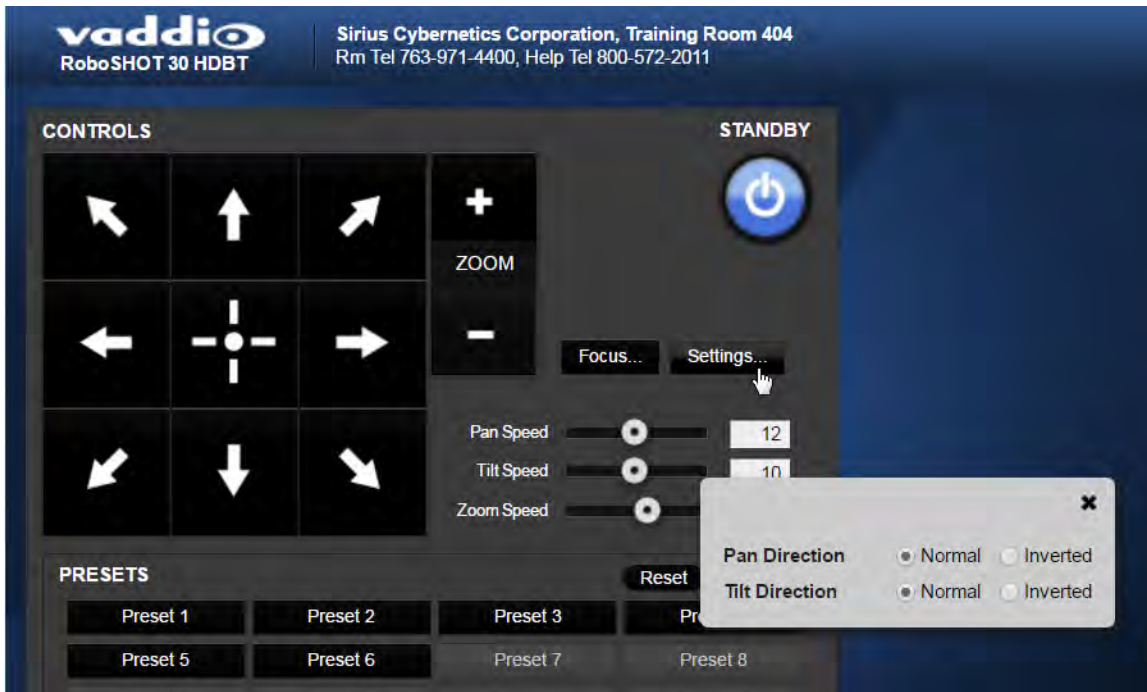

Web Tasks for Administrators: Setting a Custom Home Position

CAMERA SETTINGS PAGE

If you are logged in as admin, you can set a custom Home preset in place of the camera's default home position (0° pan and 0° tilt). The Home preset is not available in the Store Preset box if you are not logged in as admin.

Set up the shot and store the custom Home position as you would for any other preset. Like other presets, the custom Home preset can include color, speed, and Tri-Synchronous Motion settings.

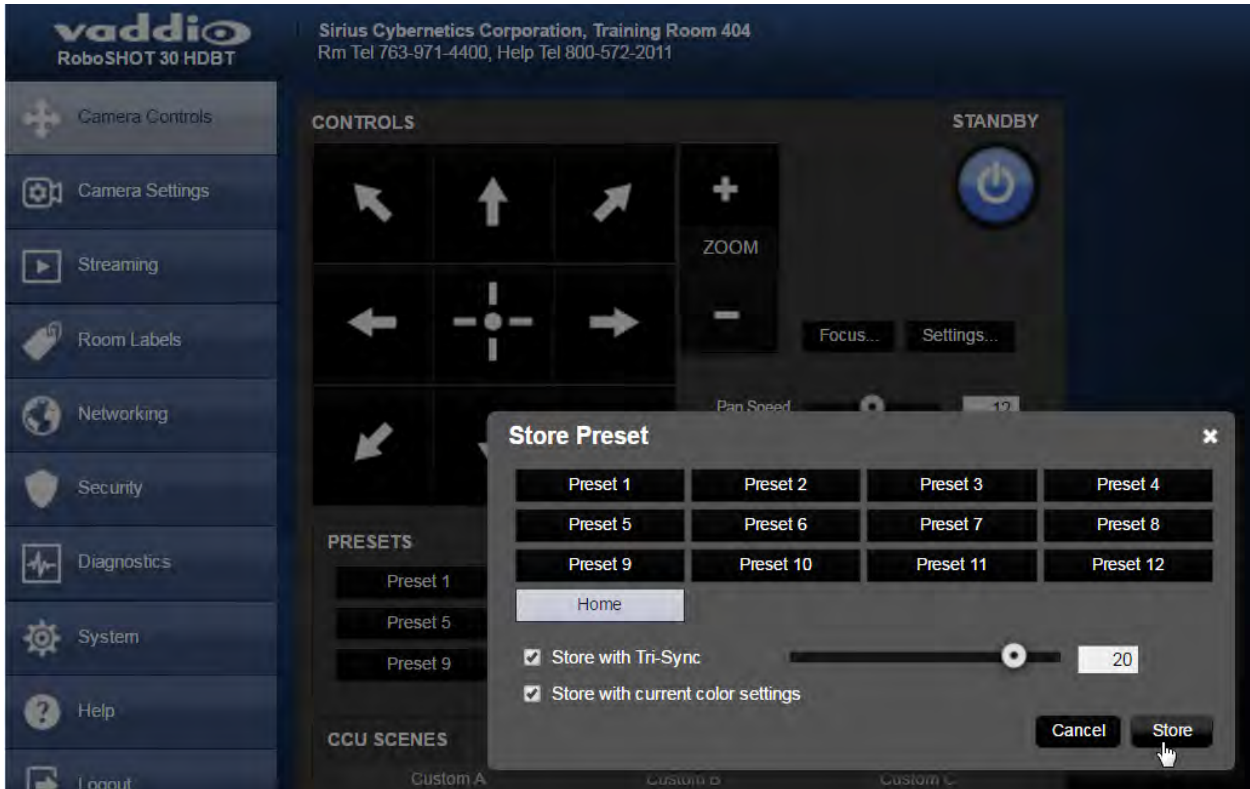

Web Tasks for Administrators: Managing Access and Passwords

SECURITY PAGE

Things you can do on this page:

- Allow people to access the Camera Control screen without logging on (Allow Guest Access)
- Set whether inactive sessions log off automatically or not (Automatically Expire Idle Sessions)
- Change the password for the admin account
- Change the password for the user account

Note

For best security, Vaddio strongly recommends changing the user and admin passwords from the default. Using the default passwords leaves the product vulnerable to tampering.



Web Tasks for Administrators: Adding Room Information to the Web Interface

ROOM LABELS PAGE

To display your company name, conference room name and phone number, and the number for meeting hosts to call for in-house A/V support, enter this information on the Room Labels page.



Web Tasks for Administrators: Configuring Network Settings

NETWORKING PAGE

Things you can do on this page:

- Specify time zone and NTP server
- Assign the camera's hostname
- Specify DHCP or static IP address
- Set up other networking information

DHCP is the default setting, but the camera will use the default address of 169.254.1.1 if no DHCP server is available.

You will only be able to enter the IP address, subnet mask, and gateway if you set IP Address to Static.

Caution

Do not change DHCP/Static addressing, IP address, subnet mask, or gateway unless you are very familiar with the characteristics and configuration of the network where you install the camera. Errors in network configuration can make the camera and its IP stream inaccessible from the network.

The screenshot displays the web interface for a Vaddio RoboSHOT 30 HDBT camera. The top header shows the Vaddio logo and the device name. Below the header is a navigation menu with options: Camera Controls, Camera Settings, Streaming, Room Labels, Networking (selected), Security, Diagnostics, System, Help, and Logout. The main content area is divided into two sections: DATE & TIME SETTINGS and NETWORK CONFIGURATION.

DATE & TIME SETTINGS

Device System Time	Sat Nov 19 17:15 UTC 2016	Refresh
Automatic NTP Updating	<input checked="" type="checkbox"/> Enabled	
Time Zone	Universal	
NTP Server	pool.ntp.org	

Buttons: Cancel, Save

NETWORK CONFIGURATION

Hostname: vaddio-roboshot-hdbt-D8-80-39-A4-CB-20

NETWORK INTERFACES

Ethernet Port (eth0:WAN)

IP Address: DHCP Static

MAC Address	D8:80:39:A4:CB:20
IP Address	10.1.2.140
Subnet Mask	255.255.0.0
Gateway	10.1.255.254

Buttons: Cancel, Save

Specifying Time Zone and NTP Server

1. To make the time zone and NTP server editable, enable Automatic NTP Updating.
2. Select the desired time zone from the list.
3. If desired, specify the NTP server to use. Otherwise, use the default.

You may need to refresh the system time display.

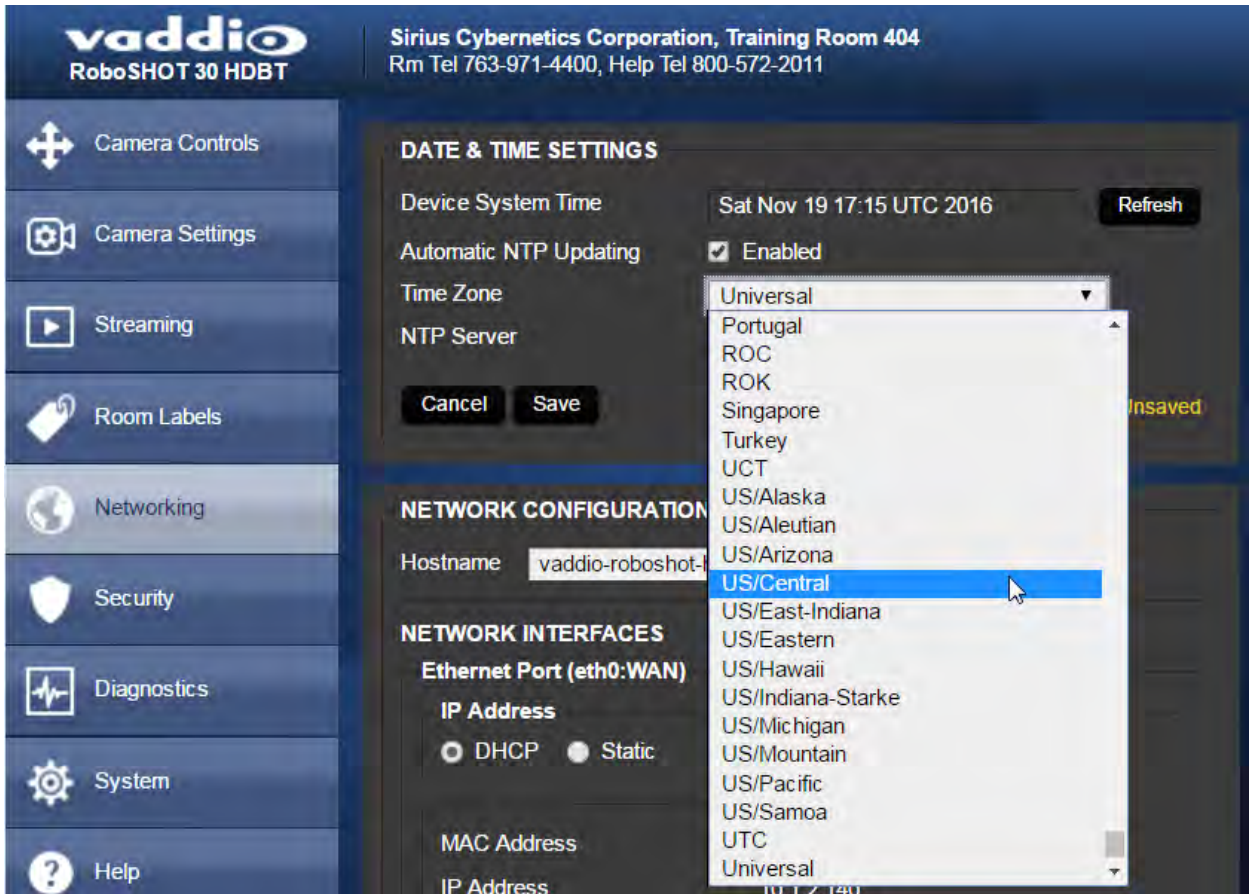

Web Tasks for Administrators: Configuring Streaming Settings

STREAMING PAGE

Things you can do on this page:

- Enable or disable IP streaming
- Set the resolution, video quality, and frame rate for IP streaming
- Specify the IP streaming port and path/URL

The camera uses the RTSP protocol for H.264 streaming. Resolutions range from 1080p down to CIF; frame rates are 30/25/15 for 1080p and 60/30/25/15 for all other resolutions.

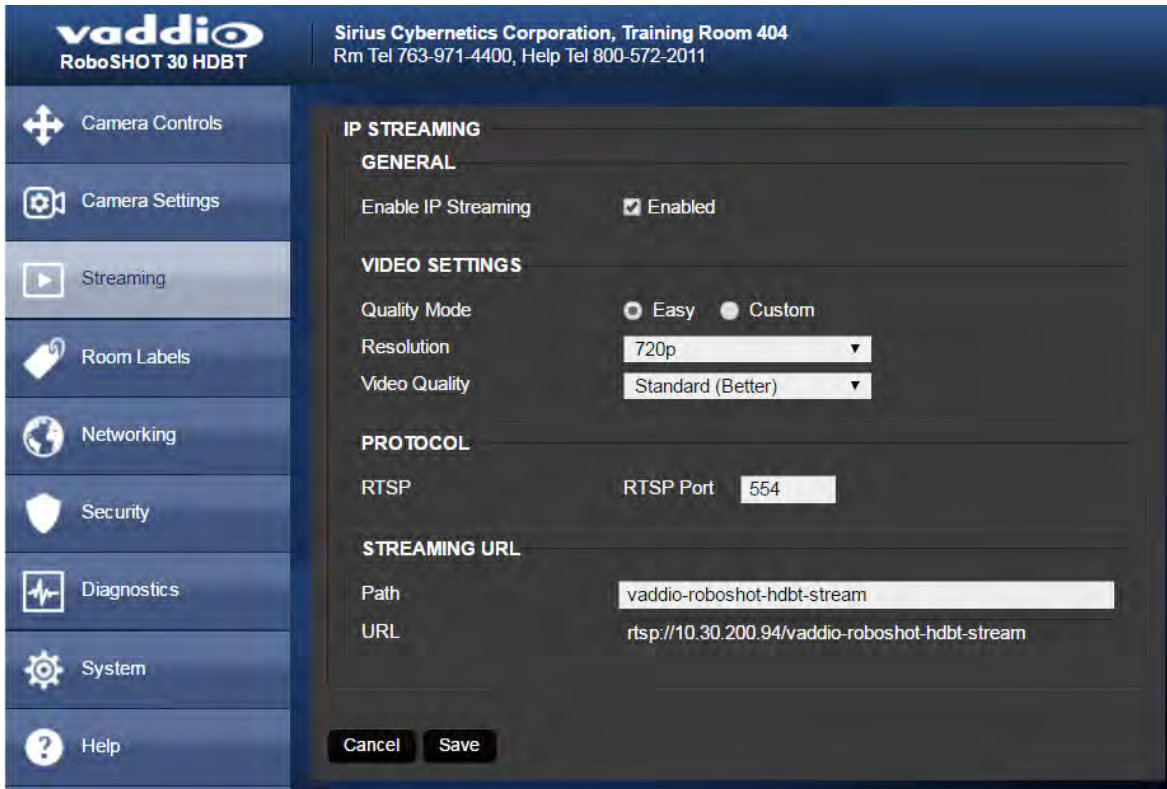

Enabling or Disabling Streaming

IP streaming is enabled by default. Use the Enable IP Streaming checkbox to change this. Save the change before you leave this page of the web interface.

Editing IP Streaming Settings

Note

The web interface presents all the possible streaming resolutions values, but the IP stream cannot be higher than the value set with the video resolution switch on the back of the camera. (See [Video Resolution](#) for information on setting the switch.) If the selected value is out of range, the camera will automatically adjust the streaming resolution.

If you are not sure about these settings, start with the defaults.

1. Select the video Quality Mode: Easy or Custom. Easy automatically sets the recommended frame rate; Custom provides additional control.
2. Select the desired IP streaming resolution.
3. Easy quality mode only: Select Video Quality.
4. Custom quality mode only: Select the desired IP streaming frame rate.
5. Custom quality mode only: Select Constant or Variable bit rate.
6. Custom quality mode, Variable bit rate only: Set the Quality (Quantization) slider.
7. Save your changes.

The image displays three sequential screenshots of the video settings interface, illustrating different configurations for the video streaming settings.

Screenshot 1 (Top): Shows the 'VIDEO SETTINGS' section with 'Quality Mode' set to 'Easy' (selected). 'Resolution' is set to '720p' and 'Video Quality' is set to 'Standard (Better)'. The 'PROTOCOL' section shows 'RTSP Port' set to '554'.

Screenshot 2 (Middle): Shows the 'VIDEO SETTINGS' section with 'Quality Mode' set to 'Custom' (selected). 'Resolution' is set to '1080p', 'Frame Rate' is set to '15' fps, and 'Bit Rate' is set to 'Variable'. 'Max Bandwidth' is set to '7 Mbps'. The 'PROTOCOL' section shows 'RTSP Port' set to '554'.

Screenshot 3 (Bottom): Shows the 'VIDEO SETTINGS' section with 'Quality Mode' set to 'Custom' (selected). 'Resolution' is set to '1080p', 'Frame Rate' is set to '15' fps, and 'Bit Rate' is set to 'Variable'. The 'Quality (Quantization)' slider is set to 'Good' (value 25). The 'PROTOCOL' section shows 'RTSP Port' set to '554'.

Advanced IP Streaming Settings

RTSP port: Vaddio strongly recommends using the default RTSP port number unless you need to change it.

Streaming URL: If necessary, edit the path to change the portion of the streaming URL that appears after the IP address.

Save your changes.

Web Tasks for Administrators: Setting Camera Behaviors and Adjustments

CAMERA SETTINGS PAGE

Things you can do on this page:

- Set up and name custom color and lighting settings.
- Set the pan, tilt, and zoom speeds that will be used for movements other than recalling presets saved with Tri-Synchronous Motion.

vaddio
RoboSHOT 30 HDBT

Sirius Cybernetics Corporation, Training Room 404
Rm Tel 763-971-4400, Help Tel 800-572-2011

Camera Controls

Camera Settings

Streaming

Room Labels

Networking

Security

Diagnostics

System

Help

Logout

CCU SCENES

Custom A	Custom B	Custom C
Auto	Incandescent Hi	Fluorescent Hi
Outdoor	Incandescent Lo	Fluorescent Lo

COLOR SETTINGS

Auto Iris

Backlight Compensation

Auto White Balance

Detail (Sharpness) 8

Chroma (Saturation) 3

Gamma 10

Store CCU Scene

CUSTOM CCU SCENE LABELS

Custom A

Custom B

Custom C

GLOBAL PRESET NON-TRI-SYNC SPEEDS

Global Pan Speed 20

Global Tilt Speed 17

Global Zoom Speed 7

Setting Up Custom Color and Lighting Settings

You can customize the camera's color and lighting settings as a one-time adjustment, or save the adjustments as one of the three custom CCU scenes.

1. Click any of the CCU scene buttons to load one of the CCU scenes into the camera, then fine-tune it as needed using the Color Settings controls.
2. To allow the camera to compensate automatically for the light level, check the Auto Iris box. Leave it unchecked to adjust iris and gain manually.
3. Auto Iris adjustments – these adjust contrast between the brightest and darkest areas of the image.
 - If there is bright light behind the main subject of the shot, check the box for Back Light Compensation.
 - To increase contrast between the brightest and darkest areas, check the box for Wide Dynamic Range.

Note

Because Backlight Compensation reduces the contrast between extremes and Wide Dynamic Range increases it, they cannot be used together.

4. To allow the camera to adjust the white balance automatically, check the Auto White Balance box. Leave it unchecked to adjust red gain and blue gain manually.
5. Detail – adjust the slider as required for the right image sharpness.

Note

If the video looks grainy or “noisy,” try a lower Detail setting. As in conversation, too much detail is bad.

6. Chroma – adjust the slider as needed for the right level of color intensity.
 7. Gamma – adjust the slider as needed for the desired range between bright areas and shadows.
 8. When the scene looks the way you want it to, click Store CCU Scene.
 9. In the Store CCU Scene dialog box, select which custom scene to store (Custom A, B, or C) and optionally give it a descriptive name. You can rename it later if necessary.
 10. Name and save your custom scene.
- If you make a change that you don't like, start over by selecting and then deselecting Auto White Balance.

Renaming a Custom CCU Scene

In the Custom CCU Scene Labels section, edit the text for the desired CCU scene label.

Setting Pan, Tilt, and Zoom Speeds

In the Global Preset Non-Tri-Sync Speeds section, set the speeds for movements to presets that do not use Tri-Synchronous Motion.

Web Tasks for Administrators: Rebooting, Updating, and Resetting

SYSTEM PAGE

Things you can do on this page:

- Reboot the camera
- Back up or restore the camera configuration
- Run a firmware update
- Set the camera back to its original factory settings
- Read (but not change) the current settings of the switches on the back of the camera
- Set the camera's soft DIP switch to specify the LED color scheme

The screenshot shows the web interface for a vaddio RoboSHOT 30 HDBT camera. The header includes the vaddio logo and contact information for Sirius Cybernetics Corporation. A left sidebar contains navigation links for Camera Controls, Camera Settings, Streaming, Room Labels, Networking, Security, Diagnostics, System, and Help. The main content area is divided into two tabs: Firmware and Dip Switches. The Firmware tab is active, displaying system information and a firmware update section.

SYSTEM INFORMATION	
System Version	RoboSHOT HDBT 1.0.1
Commit	b92edddb9cc260339abd9a13ed1c336d73c17a08
Pan Motor Version	0.2.4772
Tilt Motor Version	0.2.4772
Sensor Version	07.00
HDLink	TX4.6.1*0.03
PSoC Version	1.1

FIRMWARE UPDATE

Firmware File: No file chosen

SYSTEM UTILITIES

Rebooting the Camera

This can help if the camera stops responding as you expect. In the System Utilities section, click Reboot.

Saving (Exporting) or Restoring (Importing) a Configuration

If you need to configure several cameras the same way, you can configure the first one, export its configuration (Export Data button), and then import the configuration to the other cameras (Import Data button in each camera's web interface). The export downloads to your computer as a `.dat` file. The filename is the camera's hostname.

Certain information is not included in the configuration, such as hostname and passwords.

Note

The camera cannot import a .dat file that was exported from a camera using a different version of software.

Starting a Firmware Update

If you prefer more detail than this procedure, please refer to the Release Notes for step-by-step instructions with screen shots.

1. Locate and download the firmware and its release notes.
2. Select Choose File, then browse to the firmware that you downloaded and select it. The filename ends with .p7m.
3. Click Begin Firmware Update.
4. READ the information in the Confirm dialog box and be sure you understand it. It may seem boring, but it could save you some time and aggravation.
5. When you are ready to start the update, click Continue. A progress message box opens and the indicator light on the front of the camera turns yellow to show the firmware update is in progress. If the update process presents warnings or error messages, read them carefully.

The process may take a few minutes.

Caution

Ensure that the camera stays powered on and connected to the network during the update. Interrupting the update could make the camera unusable.

The camera reboots when the update is complete.

Restoring Factory Settings

Sometimes it's easiest to just start over. To restore the original factory settings...click Restore Factory Settings. This will overwrite anything you have customized, such as custom CCU scenes and presets.

Reading the Camera's Back Panel Switches

Open the DIP Switches tab to see the camera's current switch settings.

Note:

Sorry, you have to physically move the switches on the back of the camera if you need to change the hardware settings.

Setting the LED Color Scheme

DIP SWITCHES TAB

Use the camera's soft DIP switch to set the LED color scheme (Pro A/V or UCC). At this time, they are functionally identical on this camera.

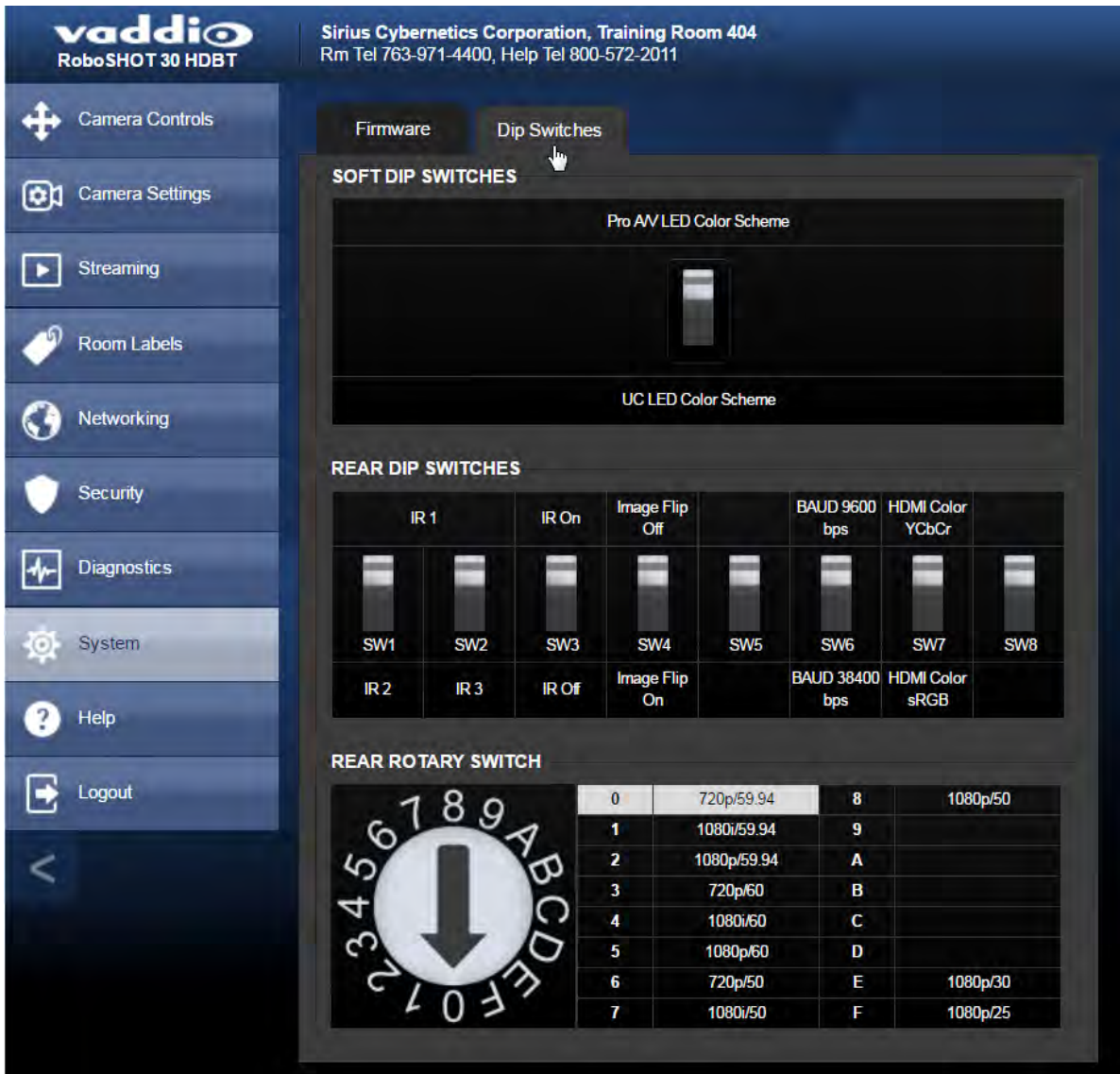

Web Tasks for Administrators: Contacting Vaddio Technical Support

HELP PAGE

If you can't resolve an issue using your troubleshooting skills (or the [Troubleshooting](#) table in this manual), we are here to help.

You'll find information for contacting Vaddio Technical Support on the Help page.

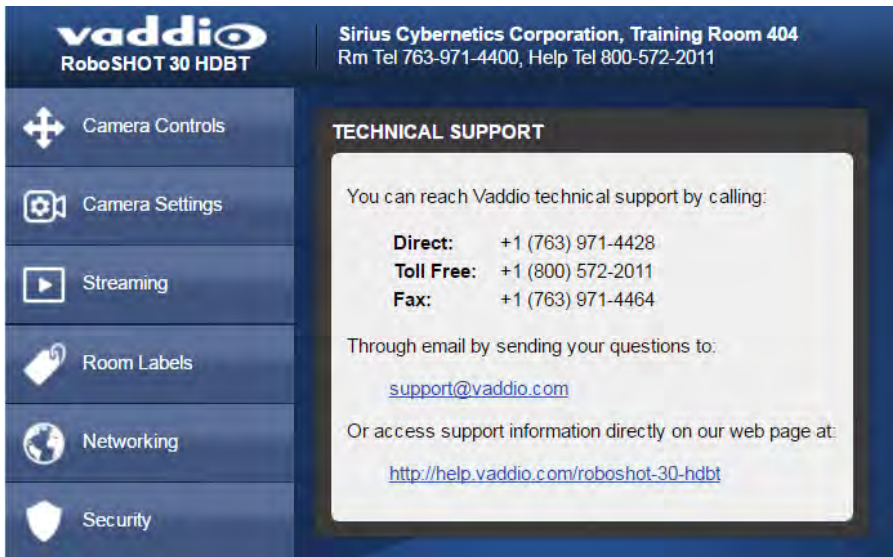

The screenshot displays the Vaddio web interface for the RoboSHOT 30 HDBT camera. The top left features the Vaddio logo and the model name. The top right provides the company name, Sirius Cybernetics Corporation, and contact information for Training Room 404, including room and help telephone numbers. A left-hand navigation menu lists various camera functions: Camera Controls, Camera Settings, Streaming, Room Labels, Networking, and Security. The main content area is titled 'TECHNICAL SUPPORT' and contains the following information:

You can reach Vaddio technical support by calling:

- Direct:** +1 (763) 971-4428
- Toll Free:** +1 (800) 572-2011
- Fax:** +1 (763) 971-4464

Through email by sending your questions to:
support@vaddio.com

Or access support information directly on our web page at:
<http://help.vaddio.com/roboshot-30-hdbt>

Web Tasks for Administrators: Viewing Diagnostic Logs

DIAGNOSTICS PAGE

If you encounter a problem that you can't solve, your Vaddio technical support representative may ask you to download and email the log file available from the Diagnostics page.

vaddio
RoboSHOT 30 HDBT

Sirius Cybernetics Corporation, Training Room 404
Rm Tel 763-971-4400, Help Tel 800-572-2011

Logout

DIAGNOSTICS

```
Jan 18 17:36:01 vaddio-roboshot-hdbt-D8-80-39-A4-F7-98 [ 0.000014] sched_clock: 64 bits at 333MHz, resolution 3ns, wraps every
Jan 18 17:36:01 vaddio-roboshot-hdbt-D8-80-39-A4-F7-98 [ 0.000286] ps7-ttc #0 at d8804000, irq=43
Jan 18 17:36:01 vaddio-roboshot-hdbt-D8-80-39-A4-F7-98 [ 0.000690] Calibrating delay loop... 1332.01 BogoMIPS (lpj=6660096)
Jan 18 17:36:01 vaddio-roboshot-hdbt-D8-80-39-A4-F7-98 [ 0.090233] pid_max: default: 32768 minimum: 301
Jan 18 17:36:01 vaddio-roboshot-hdbt-D8-80-39-A4-F7-98 [ 0.090431] Mount-cache hash table entries: 1024 (order: 0, 4096 bytes)
Jan 18 17:36:01 vaddio-roboshot-hdbt-D8-80-39-A4-F7-98 [ 0.090448] Mountpoint-cache hash table entries: 1024 (order: 0, 4096 byt
Jan 18 17:36:01 vaddio-roboshot-hdbt-D8-80-39-A4-F7-98 [ 0.091222] CPU: Testing write buffer coherency: ok
Jan 18 17:36:01 vaddio-roboshot-hdbt-D8-80-39-A4-F7-98 [ 0.091533] missing device node for CPU 0
Jan 18 17:36:01 vaddio-roboshot-hdbt-D8-80-39-A4-F7-98 [ 0.091561] missing device node for CPU 1
Jan 18 17:36:01 vaddio-roboshot-hdbt-D8-80-39-A4-F7-98 [ 0.091576] CPU0: thread -1, cpu 0, socket 0, mpidr 80000000
Jan 18 17:36:01 vaddio-roboshot-hdbt-D8-80-39-A4-F7-98 [ 0.091623] Setting up static identity map for 0x345a28 - 0x345a5c
Jan 18 17:36:01 vaddio-roboshot-hdbt-D8-80-39-A4-F7-98 [ 0.091856] L310 cache controller enabled
Jan 18 17:36:01 vaddio-roboshot-hdbt-D8-80-39-A4-F7-98 [ 0.091874] l2x0: 8 ways, CACHE_ID 0x410000c8, AUX_CTRL 0x72760
Jan 18 17:36:01 vaddio-roboshot-hdbt-D8-80-39-A4-F7-98 [ 0.150222] Brought up 1 CPUs
Jan 18 17:36:01 vaddio-roboshot-hdbt-D8-80-39-A4-F7-98 [ 0.150232] SMP: Total of 1 processors activated.
Jan 18 17:36:01 vaddio-roboshot-hdbt-D8-80-39-A4-F7-98 [ 0.150241] CPU: All CPU(s) started in SVC mode.
Jan 18 17:36:01 vaddio-roboshot-hdbt-D8-80-39-A4-F7-98 [ 0.150780] devtmpfs: initialized
Jan 18 17:36:01 vaddio-roboshot-hdbt-D8-80-39-A4-F7-98 [ 0.152785] VFP support v0.3: implementor 41 architecture 3 part 30 varie
Jan 18 17:36:01 vaddio-roboshot-hdbt-D8-80-39-A4-F7-98 [ 0.153755] regulator-dummy: no parameters
Jan 18 17:36:01 vaddio-roboshot-hdbt-D8-80-39-A4-F7-98 [ 0.154358] NET: Registered protocol family 16
Jan 18 17:36:01 vaddio-roboshot-hdbt-D8-80-39-A4-F7-98 [ 0.155366] DMA: preallocated 256 KiB pool for atomic coherent allocator
Jan 18 17:36:01 vaddio-roboshot-hdbt-D8-80-39-A4-F7-98 [ 0.165103] syscon f8000000.ps7-slcr: regmap [mem 0xf8000000-0xf800
Jan 18 17:36:01 vaddio-roboshot-hdbt-D8-80-39-A4-F7-98 [ 0.173546] hw-breakpoint: found 5 (+1 reserved) breakpoint and 1 watch
Jan 18 17:36:01 vaddio-roboshot-hdbt-D8-80-39-A4-F7-98 [ 0.173561] hw-breakpoint: maximum watchpoint size is 4 bytes.
Jan 18 17:36:01 vaddio-roboshot-hdbt-D8-80-39-A4-F7-98 [ 0.173683] zynq-ocm f800c000.ps7-ocmc: ZYNQ OCM pool: 256 KiB @
Jan 18 17:36:01 vaddio-roboshot-hdbt-D8-80-39-A4-F7-98 [ 0.183865] bio: create slab <bio-0> at 0
Jan 18 17:36:01 vaddio-roboshot-hdbt-D8-80-39-A4-F7-98 [ 0.187765] Switched to clocksource arm_global_timer
Jan 18 17:36:01 vaddio-roboshot-hdbt-D8-80-39-A4-F7-98 [ 0.190982] NET: Registered protocol family 2
Jan 18 17:36:01 vaddio-roboshot-hdbt-D8-80-39-A4-F7-98 [ 0.191543] TCP established hash table entries: 4096 (order: 2, 16384 byt
Jan 18 17:36:01 vaddio-roboshot-hdbt-D8-80-39-A4-F7-98 [ 0.191599] TCP bind hash table entries: 4096 (order: 3, 32768 bytes)
Jan 18 17:36:01 vaddio-roboshot-hdbt-D8-80-39-A4-F7-98 [ 0.191677] TCP: Hash tables configured (established 4096 bind 4096)
Jan 18 17:36:01 vaddio-roboshot-hdbt-D8-80-39-A4-F7-98 [ 0.191724] TCP: reno registered
Jan 18 17:36:01 vaddio-roboshot-hdbt-D8-80-39-A4-F7-98 [ 0.191728] UDP: v6: [mem 0xf8000000-0xf8000000] 0 ports registered
```

Download Refresh Clear Restore

Telnet Serial Command API

The Vaddio serial command protocol is a high-level, text-based command line interface supported via Telnet session on the camera. The API is accessed by a telnet client on the Ethernet port; the default Telnet port is 23. Telnet sessions require the administrator account login.

The command application protocol interface is intended to allow external device such as AMX or Crestron to control the camera. The protocol is based upon ASCII format following the VT100 terminal emulation standard and uses an intuitive text command nomenclature for ease of use.

General format usage follows a get/set structure. Usage examples for each type are:

Set Example

COMMAND: > **camera pan right**

RESPONSE: > OK

Get Example

COMMAND: > **camera ccu get iris**

RESPONSE: > iris 11

Syntax Error Example

COMMAND: > **camera right pan**

RESPONSE: > ERROR

Using a question mark as a command parameter will bring up a list of available commands for the menu you are in.

Things to know about control via Telnet session:

- Command lines are terminated with a carriage return.
- All ASCII characters (including carriage returns) are echoed to the terminal program and appended with the VT100 string ESC[J (hex 1B 5B 4A), which most terminal programs automatically strip.
- CTRL-5 Clears the current serial buffer on the device.

Typographical conventions:

- {x | y | z} – Choose x, y, or z.
- <variable> – Substitute the desired value here.
- < x - y > – Valid range of values is from x through y.
- [optional] – Parameter is not required.

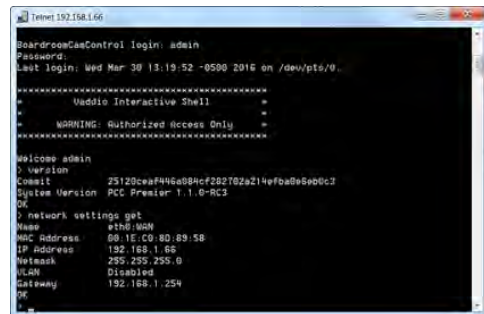

```

telnet 192.168.1.66
BoardroomCamControl login: admin
Password:
Last login: Wed Mar 30 13:19:52 -0500 2016 on /dev/pts/0
*****
*      Vaddio Interactive Shell      *
*          WARNING: Authorized Access Only          *
*****

micomp admin
: version
Commit      25120c9af446a884cf282702a214efba8e96bc7
System Version PCC Premier 1.1.0-RC3
OK
: network settings get
Name        eth0:W0N
MAC Address 98:1E:CD:8D:89:5B
IP Address  192.168.1.66
Netmask     255.255.255.0
DNS         Disabled
Gateway     192.168.1.254
OK

```

camera home

Moves the camera to its home position.

Synopsis	camera home
Example	<pre>>camera home OK ></pre>

camera pan

Moves the camera horizontally.

Synopsis	camera pan { left [<speed>] right [<speed>] stop }	
Options	left	Moves the camera left.
	right	Moves the camera right.
	speed <1 - 24>	Optional: Specifies the pan speed as an integer (1 to 24). Default speed is 12.
	stop	Stops the camera's horizontal movement.
Examples	<pre>>camera pan left OK ></pre> <p>Pans the camera left at the default speed.</p> <pre>>camera pan right 20 OK ></pre> <p>Pans the camera right using a speed of 20.</p> <pre>>camera pan stop OK ></pre> <p>Stops the camera's horizontal motion.</p>	

camera tilt

Moves the camera vertically.

Synopsis	camera tilt{ up [<speed>] down [<speed>] stop }	
Options	up	Moves the camera up.
	down	Moves the camera down.
	speed <1 - 20>	Optional: Specifies the tilt speed as an integer (1 to 20). Default speed is 10.
	stop	Stops the camera's vertical movement.
Examples	<pre>>camera tilt up OK > Tilts the camera up at the default speed. >camera tilt down 20 OK > Tilts the camera down using a speed of 20. >camera tilt stop OK > Stops the camera's vertical motion,</pre>	

camera zoom

Moves the camera in toward the subject or out away from the subject.

Synopsis	camera zoom { in [<speed>] out [<speed>] stop }	
Options	in	Moves the camera in.
	out	Moves the camera out.
	speed [1 - 7]	Optional: Specifies the zoom speed as an integer (1 to 7). Default speed is 3.
	stop	Stops the camera's zoom movement.
Examples	<pre>>camera zoom in OK > Zooms the camera in at the default speed. >camera zoom out 7 OK > Zooms the camera out using a speed of 7. >camera zoom stop OK > Stops the camera's zoom motion.</pre>	

camera focus

Changes the camera focus.

Synopsis	<code>camera focus { near [<speed>] far [<speed> stop mode {get auto manual}}</code>	
Options	<code>near</code>	Brings the focus nearer to the camera. Can only be used when camera is in manual mode.
	<code>far</code>	Moves the focus farther from the camera. Can only be used when camera is in manual mode.
	<code>speed <1 - 8></code>	Optional: integer (1 to 8) specifies the focus speed.
	<code>mode {get auto manual}</code>	Returns the current focus mode, or specifies automatic or manual focus.
	<code>stop</code>	Stops the camera's focus movement.
Examples	<pre>camera focus near OK ></pre> <p>Brings the focus near at the default speed.</p> <pre>camera focus far 7 OK ></pre> <p>Moves the focus farther from the camera at a speed of 7.</p> <pre>camera focus mode get auto_focus: on OK ></pre> <p>Returns the current focus mode.</p>	



camera preset

Moves the camera to the specified preset, or stores the current camera position and optionally CCU information, either with or without specifying that Tri-Synchronous Motion is to be used when moving to this position.

Note

This command corresponds to the CAM_Memory commands in the RS-232 command set.

Synopsis	camera preset { recall store} <1 - 16> [tri-sync <1 - 24>] [save-ccu]	
Options	recall <1 - 16>	Moves the camera to the specified preset, using Tri-Synchronous Motion if this was saved with the preset. If CCU information was saved with the preset, the camera switches to the CCU setting associated with the preset.
	store <1 - 16>	Stores the current camera position as the specified preset.
	tri-sync <1 - 24>	Optional: Specifies that the camera uses Tri-Synchronous Motion to move to this position, using the specified speed.
	save-ccu	Optional: Saves the current CCU settings as part of the preset. If not specified, the last color settings are used when recalled.
Examples	<pre>>camera preset recall 3 OK ></pre> <p>Moves the camera to preset 3.</p> <pre>>camera preset store 1 OK ></pre> <p>Saves the camera's current position as preset 1.</p> <pre>>camera preset store 4 tri-sync 15 OK ></pre> <p>Stores the camera's current position as preset 4. The camera will use Tri-Synchronous Motion at speed 15 when it is recalled to this preset.</p> <pre>>camera preset store 2 tri-sync 10 save-ccu OK ></pre> <p>Stores the camera's current position as preset 2. The camera apply the current CCU settings and use Tri-Synchronous Motion at speed 15 when it is recalled to this preset.</p>	

camera ccu get

Returns or sets CCU (lighting) information.

Synopsis	<code>camera ccu get <param></code>	
Options 	<code>auto_white_balance</code>	Returns the current state of the auto white balance setting (on or off).
	<code>red_gain</code>	Returns the red gain value as an integer (0 to 255).
	<code>blue_gain</code>	Returns the blue gain value as an integer (0 to 255).
	<code>backlight_compensation</code>	Returns the current state of the backlight compensation setting (on or off).
	<code>iris</code>	Returns the iris value as an integer (0 to 11).
	<code>auto_iris</code>	Returns the current auto-iris state (on or off).
	<code>gain</code>	Returns the gain value as an integer (0 to 11).
	<code>detail</code>	Returns the detail value as an integer (0 to 15).
	<code>chroma</code>	Returns the chroma value as an integer (0 to 14).
	<code>wide_dynamic_range</code>	Returns the current state for Wide Dynamic Range (on or off).
	<code>all</code>	Returns all current CCU settings.
Examples	<pre>>camera ccu get iris iris 6 OK > Returns the current iris value. >camera ccu get red_gain red_gain 201 OK > Returns the current red gain value. >camera ccu get all auto_iris on auto_white_balance on backlight_compensation off blue_gain 193 chroma 2 detail 8 gain 3 iris 11 red_gain 201 wide_dynamic_range off OK > Returns all current CCU settings.</pre>	

camera ccu set

Sets the specified CCU (lighting) information.

Synopsis	camera ccu set <param> <value>	
Options 	auto_white_balance {on off}	Sets the current state of the auto white balance setting (on or off). Auto white balance overrides red gain and blue gain manual settings.
	red_gain <0 - 255>	Sets the red gain value as an integer (0 to 255). Can only be used when auto white balance is off.
	blue_gain <0 - 255>	Sets the blue gain value as an integer (0 to 255). Can only be used when auto white balance is off.
	backlight_compensation {on off}	Sets the current state of the backlight compensation setting (on or off). Can only be used when wide dynamic range mode is off.
	iris <0 - 11>	Sets the iris value as an integer (0 to 11). Can only be used when auto-iris is off.
	auto_iris {on off}	Sets the auto-iris state (on or off). Auto-iris disables manual iris and gain when it is on.
	gain <0 - 11>	Sets gain value as an integer (0 to 11). Can only be used when auto-iris is off.
	detail <0 - 15>	Sets the detail value as an integer (0 to 15).
	chroma <0 - 14>	Sets the chroma value as an integer (0 to 14).
	wide_dynamic_range {on off}	Sets Wide Dynamic Range mode on or off. Can only be used when backlight compensation is off.
Examples	<pre>>camera ccu set auto_iris off OK > Turns off auto-iris mode, returning the camera to manual iris control. >camera ccu set red_gain 10 OK > Sets the red gain value to 10.</pre>	

camera ccu scene

Stores the current CCU scene or recalls the specified ccu scene.

Synopsis	camera ccu scene {recall {factory <1 - 6> custom <1 - 3>} store custom <1 - 3>}	
Options	recall factory <1 - 6> recall custom <1 - 3>	Recalls the camera to the specified scene (factory 1 - 6 or custom 1 - 3) .
	store custom <1 - 3>	Saves the current scene as the specified custom scene.
Examples	<pre>>camera ccu scene recall factory 2 OK ></pre> <p>Sets the camera to use factory CCU scene 2.</p> <pre>>camera ccu scene store custom 1 OK ></pre> <p>Saves the current CCU scene as custom CCU scene 1.</p>	

camera standby

Set or change camera standby status.

Synopsis	camera standby { off on toggle }	
Parameters	off	Brings the camera out of standby (sleep) mode.
	on	Stops video and puts the camera in standby mode.
	toggle	Changes the camera's standby state - if it was not in standby mode, it enters standby; if it was in standby mode, it "wakes up."
	get	Returns the camera's current standby state (on or off).
Examples	<pre>camera standby off</pre> <p>Brings the camera out of standby mode.</p>	
	<pre>camera standby on</pre> <p>Puts the camera in standby mode.</p>	

streaming settings get

Retrieves IP streaming settings. These are configured in the web interface.

Synopsis	streaming settings get	
Parameters	IP Custom_Frame_Rate	Frame rate selected in Custom quality mode.
	IP Custom_Resolution	Resolution selected in Custom quality mode.
	IP Enabled	True if IP streaming is enabled, False if it is not.
	IP Port	The RTSP port number used for IP streaming. Default is 554.
	IP Preset_Quality	Video quality selected in Easy video quality mode.
	IP Preset_Resolution	Resolution selected in Easy video quality mode.
	IP Protocol	The IP streaming protocol in use.
	IP URL	The URL where the stream is available.
	IP Video_Mode	Video quality mode selected (preset or custom)
Example	<pre>>streaming settings get IP Custom_Frame_Rate 30 IP Custom_Resolution 1080p IP Enabled true IP Port 554 IP Preset_Quality Standard (Better) IP Preset_Resolution 720p IP Protocol RTSP IP URL vaddio-roboshot-hdbt-stream IP Video_Mode preset</pre> <p>Returns the current streaming settings.</p>	

network settings get

Returns the current network settings for MAC address, IP address, subnet mask, and gateway.

Synopsis	network settings get	
Example	<pre>> network settings get Name eth0:WAN MAC Address 00:1E:C0:F6:CA:7B IP Address 192.168.1.67 Netmask 255.255.255.0 VLAN Disabled Gateway 192.168.1.254 OK ></pre>	

network ping

Sends an ICMP ECHO_REQUEST to the specified IP address or hostname.

Synopsis	<code>network ping [count <count>] [size <size>] <destination-ip></code>	
Options	<code><count></code>	The number of ECHO_REQUEST packets to send. Default is five packets.
	<code><size></code>	The size of each ECHO_REQUEST packet. Default is 56 bytes.
	<code><destination-ip></code>	The IP address where the ECHO_REQUEST packets will be sent.
Examples	<pre>>network ping 192.168.1.66 PING 192.168.1.66 (192.168.1.66): 56 data bytes 64 bytes from 192.168.1.66: seq=0 ttl=64 time=0.476 ms 64 bytes from 192.168.1.66: seq=1 ttl=64 time=0.416 ms 64 bytes from 192.168.1.66: seq=2 ttl=64 time=0.410 ms 64 bytes from 192.168.1.66: seq=3 ttl=64 time=0.410 ms 64 bytes from 192.168.1.66: seq=4 ttl=64 time=3.112 ms --- 192.168.1.66 ping statistics --- 5 packets transmitted, 5 packets received, 0% packet loss round-trip min/avg/max = 0.410/0.964/3.112 ms ></pre> <p>Sends five ECHO_REQUEST packets of 56 bytes each to the host at 192.168.1.66.</p>	
	<pre>>network ping count 10 size 100 192.168.1.1</pre> <p>Sends 10 ECHO_REQUEST packets of 100 bytes each to the host at 192.168.1.1. The command returns data in the same form as above.</p>	

system reboot

Reboots the system either immediately or after the specified delay. Note that a reboot is required when resetting the system to factory defaults (system factory-reset).

Synopsis	<code>system reboot [<seconds>]</code>	
Options	<code><seconds></code>	The number of seconds to delay the reboot.
Examples	<pre>>system reboot OK ></pre> <p>The system is going down for reboot NOW! roboshot-hdabt-D8-80-39-62-A7-C5</p> <p>Reboots the system immediately.</p>	
	<pre>>system reboot 30</pre> <p>Reboots the system in 30 seconds. The response is in the same form; the system message appears at the end of the delay.</p>	

system factory-reset

Gets or sets the factory reset status. When the factory reset status is on, the system resets to factory defaults on reboot.

Synopsis	system factory-reset { get on off }	
Options	get	Returns the camera's current factory reset status.
	on	Enables factory reset on reboot.
	off	Disables factory reset on reboot.
Examples 	<pre>>system factory-reset get factory-reset (software): off factory-reset (hardware): off OK ></pre> <p>Returns the factory reset status.</p> <p>This evaluates the most recent <code>system factory-reset on</code> or <code>off</code> command, if one has been received, then reads the rear panel DIP switches and returns the status <code>on</code> if they are all in the down position.</p> <pre>>system factory-reset on factory-reset (software): on factory-reset (hardware): off OK ></pre> <p>Enables factory reset upon reboot.</p> <p>Note <i>This command does not initiate a factory reset. The factory reset takes place on the next reboot.</i></p>	

sleep

Pauses for the specified number of milliseconds before evaluating and executing the next command.

Synopsis	sleep <milliseconds>	
Options	<milliseconds>	The number of milliseconds (1 to 10000) to pause.
Example	<pre>>sleep 7000 OK ></pre> <p>Pause for 7 seconds (7000 milliseconds) before returning.</p>	

history

Returns the most recently issued commands from the current Telnet session. Since many of the programs read user input a line at a time, the command history is used to keep track of these lines and recall historic information.

Synopsis	history <limit>	
Options	<limit>	Integer value specifying the maximum number of commands to return.
Examples	<p>history Displays the current command buffer.</p> <p>history 5 Sets the history command buffer to remember the last 5 unique entries.</p>	
Additional information	<p>You can navigate the command history using the up and down arrow keys.</p> <p>This command supports the expansion functionality from which previous commands can be recalled from within a single session. History expansion is performed immediately after a complete line is read.</p> <p>Examples of history expansion:</p> <ul style="list-style-type: none"> * !! Substitute the last command line. * !4 Substitute the 4th command line (absolute as per 'history' command) * !-3 Substitute the command line entered 3 lines before (relative) 	



version

Returns the current firmware version.

Synopsis	version
Example	<pre>> version Commit: d033ddb2378357a871011eb820706dcaa64ec0e2 HDLink: TX4.6.1x0.03 PSoC Version: 1.1 Pan Motor Version: 0.2.4772 Sensor Version: 06.00 System Version: RoboSHOT HDBT 1.0.0 Tilt Motor Version: 0.2.4772 OK Returns current firmware version information.</pre>

help

Displays an overview of the CLI syntax.

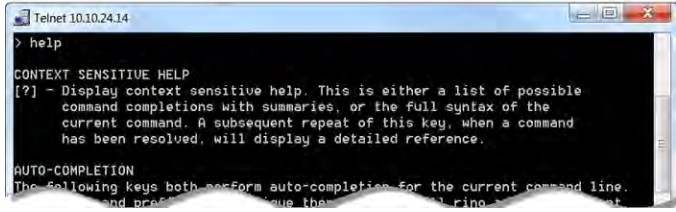
Synopsis	help
Example	<p>help</p>  <pre> Telnet 10.10.24.14 > help CONTEXT SENSITIVE HELP [?] - Display context sensitive help. This is either a list of possible command completions with summaries, or the full syntax of the current command. A subsequent repeat of this key, when a command has been resolved, will display a detailed reference. AUTO-COMPLETION The following keys both perform auto-completion for the current command line. and press the key to view the full command line. </pre>

exit

Ends the command session and then does one of these two things:

- Telnet: Closes the socket.
- RS-232 serial: Automatically starts a new session.

Synopsis	exit
Example	exit

RS-232 Serial Communication

The RS-232 serial port (color-coded blue) near the center of the camera's back panel provides another means of controlling the camera.

Specification	Value
Communication Speed	9600 bps (default)
Number of start bits	1
Number of stop bits	1
Number of data bits	8
Parity	None
Flow control	None

Connector pin-out:

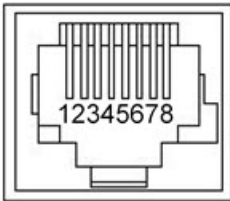

Caution

Check Cat-5 cables for continuity before using them. Using the wrong pin-out may damage the camera system and void the warranty.

The Vaddio RoboSHOT Control Protocol is similar to the Sony® VISCA command set in order to be compatible with several popular control devices. Not all VISCA commands are supported and there are Vaddio-specific commands in the following command and inquiry lists.

RS-232 Command List

Most of these commands are common to all RoboSHOT series cameras. Some have different value ranges depending on the camera.

Command Set	Command	Command Packet	Comments
AddressSet	Broadcast	88 30 01 FF	Sets address for all daisy-chained cameras
IF_Clear	Broadcast	88 01 00 01 FF	I/F Clear
CommandCancel		8x 2p FF	p= Socket No.(1-2)
CAM_Power	On	8x 01 04 00 02 FF	Power on
	Off	8x 01 04 00 03 FF	Power off
CAM_Zoom	Stop	8x 01 04 07 00 FF	
	Tele(std)	8x 01 04 07 02 FF	
	Wide(std)	8x 01 04 07 03 FF	
	Tele(variable)	8x 01 04 07 2p FF	p= speed 0:low to 7:high
	Wide(variable)	8x 01 04 07 3p FF	p= speed 0:low to 7:high
	Direct	8x 01 04 47 0p 0q 0r 0s FF	pqrs=Zoom Position (0h-4000h)
CAM_Focus	Stop	8x 01 04 08 00 FF	
	Far (std)	8x 01 04 08 02 FF	
	Near (std)	8x 01 04 08 03 FF	
	Far (variable)	8x 01 04 08 2p FF	p= speed 0:low to 7:high
	Near (variable)	8x 01 04 08 3p FF	p= speed 0:low to 7:high
	Direct	8x 01 04 48 0p 0q 0r 0s FF	pqrs=Focus Position (1000h – F000h)
	Auto Focus	8x 01 04 38 02 FF	
	Manual Focus	8x 01 04 38 03 FF	
	Auto/Manual	8x 01 04 08 10 FF	
	One Push Trigger	8x 01 04 18 01 FF	One push AF Trigger
	Near Limit	8x 01 04 28 0p 0q 0r 0s FF	pqrs=Near focus Limit****
CAM_AFSensitivity	Normal	8x 01 04 58 02 FF	AF Sensitivity High / Low
	Low	8x 01 04 58 03 FF	
CAM_AFMode	Normal AF	8x 01 04 57 00 FF	AF movement mode
	Internal AF	8x 01 04 57 01 FF	
	Zoom Trigger AF	8x 01 04 57 02 FF	
	Activate/Internal Time	8x 01 04 27 0p 0q 0r 0s FF	pqrs=movement time, rs=Interval

Command Set	Command	Command Packet	Comments
CAM_IRCorrection	Standard	8x 01 04 11 00 FF	Focus IR compensation data switching
	IR light	8x 01 04 11 01 FF	
CAM_ZoomFocus	Direct	8x 01 04 47 0p 0q 0r 0s 0t 0u 0v 0w FF	pqrs=Zoom Position RoboSHOT 12 and RoboSHOT 20 UHD: (0h – 4000h) RoboSHOT 30: (0h - 7AC0h) tuvw=Focus Position (1000h – F000h)
CAM_WB	Auto	8x 01 04 35 00 FF	Normal Auto
	Indoor	8x 01 04 35 01 FF	Indoor mode
	Outdoor	8x 01 04 35 02 FF	Outdoor mode
	One Push WB	8x 01 04 35 03 FF	One Push WB mode
	ATW	8x 01 04 35 04 FF	Auto Tracing White Balance
	Manual	8x 01 04 35 05 FF	Manual Control mode
	One Push Trigger	8x 01 04 10 05 FF	One Push WB Trigger
	Outdoor Auto	8x 01 04 35 06 FF	Outdoor auto
	Sodium Lamp Auto	8x 01 04 35 07 FF	Auto including sodium lamp source
	Sodium Lamp	8x 01 04 35 08 FF	Sodium lamp source fixed mode
	Sodium Lamp Outdoor Auto	8x 01 04 35 09 FF	Outdoor auto including sodium lamp source
CAM_RGain	Reset	8x 01 04 03 00 FF	Manual control of red gain
	Up	8x 01 04 03 02 FF	
	Down	8x 01 04 03 03 FF	
	Direct	8x 01 04 43 00 00 0p 0q FF	pq=Red gain (00h – FFh)
CAM_BGain	Reset	8x 01 04 04 00 FF	Manual control of blue gain
	Up	8x 01 04 04 02 FF	
	Down	8x 01 04 04 03 FF	
	Direct	8x 01 04 44 00 00 0p 0q FF	pq=Blue gain (00h – FFh)
CAM_AE	Full Auto	8x 01 04 39 00 FF	Auto Exposure mode
	Manual	8x 01 04 39 03 FF	Manual Control mode
	Shutter Priority	8x 01 04 39 0A FF	Shutter Priority Auto Exposure mode
	Iris Priority	8x 01 04 39 0B FF	Iris Priority Auto Exposure Mode
	Bright	8x 01 04 39 0D FF	Bright Mode (modified AE mode)

Command Set	Command	Command Packet	Comments
CAM_ExpComp	On	8x 01 04 3E 02 FF	Exposure Compensation On
	Off	8x 01 04 3E 03 FF	Exposure Compensation Off
	Reset	8x 01 04 0E 00 FF	
	Up	8x 01 04 0E 02 FF	
	Down	8x 01 04 0E 03 FF	
	Direct	8x 01 04 4E 00 00 0p 0q FF	pq=ExpComp Position(0h-0Eh)
CAM_Shutter	Reset	8x 01 04 0A 00 FF	Shutter Setting
	Up	8x 01 04 0A 02 FF	
	Down	8x 01 04 0A 03 FF	
	Direct	8x 01 04 4A 00 00 0p 0q FF	pq=Shutter Position (00h – 15h) See Shutter Speed Settings for setting values.
CAM_Iris	Reset	8x 01 04 0B 00 FF	Iris Setting
	Up	8x 01 04 0B 02 FF	
	Down	8x 01 04 0B 03 FF	
	Direct	8x 01 04 4B 00 00 0p 0q FF	pq=Iris Position RoboSHOT 12: (0h, 07h-11h) RoboSHOT 30 and RoboSHOT 20 UHD: (0h, 05h-11h)
CAM_Gain	Reset	8x 01 04 0C 00 FF	Iris Gain Setting
	Up	8x 01 04 0C 02 FF	pq=Gain Position (01h – 0Fh)
	Down	8x 01 04 0C 03 FF	
	Direct	8x 01 04 4C 00 00 0p 0q FF	
	+Gain Limit	8x 01 04 2C 0p FF	
CAM_BackLight	On	8x 01 04 33 02 FF	Backlight Compensation On/Off
	Off	8x 01 04 33 03 FF	
CAM_Tally	On	8x 01 7E 01 0A 00 02 FF	
	Off	8x 01 7E 01 0A 00 03 FF	

Command Set	Command	Command Packet	Comments
CAM_WD	On	8x 01 04 3D 02 FF	WD On
	Off	8x 01 04 3D 03 FF	WD Off
	VE On	8x 01 04 3D 06 FF	VE On
	Set Parameter	8x 01 04 2D 00 0q 0r 0s 00 00 00 00 FF	q=Display brightness (0 Dark – 6 Bright) r=Brightness compensation (0: Very dark, 1: Dark, 2: std, 3: bright) s=Compensation level (0: Low, 1: Mid, 2: High)
CAM_Aperture	Reset	8x 01 04 02 00 FF	Aperture Setting
	Up	8x 01 04 02 01 FF	
	Down	8x 01 04 02 02 FF	
	Direct	8x 01 04 42 00 00 0p 0q FF	pq=Aperture Position (0h-0fh)
CAM_HR	On	8x 01 04 52 02 FF	High Resolution Mode On/Off
	Off	8x 01 04 52 03 FF	
CAM_NR	--	8x 01 04 53 0p FF	p= Noise Reduction level(0:Off, 1-5)
CAM_Gamma	--	8x 01 04 5B 0p FF	p= Gamma setting (0:std, 1:Straight)
CAM_LR_Reverse	On	8x 01 04 61 02 FF	LR Reverse On/Off (mirror)
	Off	8x 01 04 61 03 FF	
CAM_Freeze	On	8x 01 04 62 02 FF	Freeze On/Off
	Off	8x 01 04 62 03 FF	
CAM_PictureEffect	Off	8x 01 04 63 00 FF	Picture Effect Setting
	Neg.Art	8x 01 04 63 02 FF	
	Black & White	8x 01 04 63 04 FF	
CAM_PictureFlip	On	8x 01 04 66 02 FF	Image-Flip On/Off
	Off	8x 01 04 66 03 FF	
CAM_ICR	On	8x 01 04 01 02 FF	ICR Mode On/Off - adds an IR cut filter to the image for low light images
	Off	8x 01 04 01 03 FF	
CAM_IDWrite		8x 01 04 22 0p 0q 0r 0s FF	pqrs=Camera ID (0h-ffffh)
Cam_Display	On	8x 01 04 15 02 FF	Display On/Off
	Off	8x 01 04 15 03 FF	
	On/Off	8x 01 04 15 10 FF	

Command Set	Command	Command Packet	Comments
Cam_Mute	On	8x 01 04 75 02 FF	Mute On/Off
	Off	8x 01 04 75 03 FF	
	On/Off	8x 01 04 75 10 FF	
CAM_ColorEnhance	Parameter Set	8x 01 04 20 mm 00 pp qq rr ss tt uu FF	mm: Threshold level pp: Y fixed color for high-intensity qq: Cr fixed color for high-intensity rr: Cb fixed color for high-intensity ss: Y fixed color for low-intensity tt: Cr fixed color for low-intensity uu: Cb fixed color for low-intensity Each parameter setting 00h to 7Fh
	On	8x 01 04 50 02 FF	Color Enhancement On/Off
	Off	8x 01 04 50 03 FF	
CAM_ChromaSuppress		8x 01 04 5F pp FF	pp: Chroma Suppress level 00: Off 01h to 03h: On (3 levels; larger number = larger effect)
CAM_ColorGain	Direct	8x 01 04 49 00 00 00 0p FF	p: Color Gain Setting 0h to 4h
CAM_ColorHue	Direct	8x 01 04 4F 00 00 00 0p FF	p: Color Hue Setting 0h (-14 degrees) to Eh (+14 degrees)
CAM_GammaOffset	Direct	8x 01 04 1E 00 00 00 0s 0t 0u FF	s: Polarity offset (0 is plus, 1 is minus) tu: RoboSHOT 12 – Offset s=0 (00h to 10h) RoboSHOT 30 – Offset s=1 (00h to 40h)

Command Set	Command	Command Packet	Comments
Pan-TiltDrive	Up	8x 01 06 01 vv ww 03 01 FF	vv= Pan speed (01h-18h) ww=Tilt speed (01h-14h)
	Down	8x 01 06 01 vv ww 03 02 FF	
	Left	8x 01 06 01 vv ww 01 03 FF	
	Right	8x 01 06 01 vv ww 02 03 FF	
	UpLeft	8x 01 06 01 vv ww 01 01 FF	
	UpRight	8x 01 06 01 vv ww 02 01 FF	
	DownLeft	8x 01 06 01 vv ww 01 02 FF	
	DownRight	8x 01 06 01 vv ww 02 02 FF	
	Stop	8x 01 06 01 vv ww 03 03 FF	
	Absolute Position	8x 01 06 02 vv ww 0Y 0Y 0Y 0Y 0Z 0Z 0Z 0Z FF	0Y0Y0Y0Y = Pan position (90E2h-6BD8h) 0Z0Z0Z0Z = Tilt position (EB99h-3D59h)
Home	8x 01 06 04 FF	Returns the camera to its default position	
Pan-Tilt-ZoomDrive	Up	8x 01 06 0A vv ww rr 03 01 03 FF	vv= Pan speed (01h-18h) ww=Tilt speed (01h-14h) rr=Zoom speed (00h-07h)
	Down	8x 01 06 0A vv ww rr 03 02 03 FF	
	Left	8x 01 06 0A vv ww rr 01 03 03 FF	
	Right	8x 01 06 0A vv ww rr 02 03 03 FF	
	In	8x 01 06 0A vv ww rr 03 03 01 FF	

Command Set	Command	Command Packet	Comments
	Out	8x 01 06 0A vv ww rr 03 03 02 FF	
	Stop	8x 01 06 0A vv ww rr 03 03 03 FF	
	Absolute Position	8x 01 06 0B vv ww 0Y 0Y 0Y 0Y 0Z 0Z 0Z 0Z 0R 0R 0R 0R FF	0Y0Y0Y0Y = Pan position (90E2h-6BD8h) 0Z0Z0Z0Z = Tilt position (EB99h-3D59h) 0R0R0R0R = Zoom position RoboSHOT 12: 0000h-4000h RoboSHOT 30 and RoboSHOT 20 UHD: 0000h-7AC0h
	Home	8x 01 06 0C FF	Returns the camera to the default position and zoom
CAM_PTZ_ PresetSpeed		8x 01 7e 01 0b pp qq rr FF	pp:pan speed (01h-18h), qq:tilt speed (01h-14h), rr:zoom speed (0h-07h) Applies only if Tri-Synchronous Motion is not used.

Command Setting Values

Valid settings for these commands:

- CAM_ExpComp
- CAM_Shutter
- CAM_Iris
- CAM_Gain

Exposure Compensation

Command: CAM_ExpComp

Value	Iris	Gain
0x0E	+7	+10.5 dB
0x0D	+6	+9 dB
0x0C	+5	+7.5 dB
0x0B	+4	+6 dB
0x0A	+3	+4.5 dB
0x09	+2	+3 dB
0x08	+1	+1.5 dB
0x07	0	0 dB
0x06	-1	-1.5 dB
0x05	-2	-3 dB
0x04	-3	-4.5 dB
0x03	-4	-6 dB
0x02	-5	-7.5 dB
0x01	-6	-9 dB
0x00	-7	-10.5 dB

Shutter Speed Values

Command: CAM_Shutter

Value	60/59.94/30/29.97	50/25
0x15	1/10000	1/10000
0x14	1/6000	1/6000
0x13	1/4000	1/3500
0x12	1/3000	1/2500
0x11	1/2000	1/1750
0x10	1/1500	1/1250
0x0F	1/1000	1/1000
0x0E	1/725	1/600
0x0D	1/500	1/425
0x0C	1/350	1/300
0x0B	1/250	1/215
0x0A	1/180	1/150
0x09	1/125	1/120
0x08	1/100	1/100
0x07	1/90	1/75
0x06	1/60	1/50
0x05	1/30	1/25
0x04	1/15	1/12
0x03	1/8	1/6
0x02	1/4	1/3
0x01	1/2	1/2
0x00	1/1	1/1

Iris Position Values

Command: CAM_Iris

Value	RoboSHOT 20 UHD
0x11	F1.8
0x10	F2
0x0F	F2.4
0x0E	F2.8
0x0D	F3.4
0x0C	F4
0x0B	F4.8
0x0A	F5.6
0x09	F6.8
0x08	F8
0x07	F9.6
0x06	F11
0x05	F14
0x00	CLOSE

Iris Gain Values

Command: CAM_Gain

Value	Gain
0x10	45 dB
0x0F	42 dB
0x0E	39 dB
0x0D	36 dB
0x0C	33 dB
0x0B	30 dB
0x0A	27 dB
0x09	24 dB
0x08	21 dB
0x07	18 dB
0x06	15 dB
0x05	12 dB
0x04	9 dB
0x03	6 dB
0x02	3 dB
0x01	0 dB

Note

Values 0D to 10 can be set only when the high-sensitivity mode is ON. By default, it is off at power-up/reboot.

Iris Gain Limit Values

Command: CAM_Gain

Value	High Sensitivity Off	High Sensitivity On
0x0C	33 dB	45 dB
0x0B	30 dB	42 dB
0x0A	27 dB	39 dB
0x09	24 dB	36 dB
0x08	21 dB	33 dB
0x07	18 dB	30 dB
0x06	15 dB	27 dB
0x05	12 dB	24 dB
0x04	9 dB	21 dB

RS-232 Inquiry Command List

Inquiry Command	Command	Response Packet	Comments
CAM_PowerInq	8x 09 04 00 FF	y0 50 02 FF	On
		y0 50 03 FF	Off (Standby)
CAM_ZoomPosInq	8x 09 04 47 FF	y0 50 0p 0q 0r 0s FF	pqrs: Zoom Position
CAM_FocusModelInq	8x 09 04 38 FF	y0 50 02 FF	Auto Focus
		y0 50 03 FF	Manual Focus
CAM_FocusPosInq	8x 09 04 48 FF	y0 50 0p 0q 0r 0s FF	pqrs: Focus Position
CAM_FocusNearLimitInq	8x 09 04 28 FF	y0 50 0p 0q 0r 0s FF	pqrs: Focus Near Limit Position
CAM_AFSensitivityInq	8x 09 04 58 FF	y0 50 02 FF	AF Sensitivity Normal
		y0 50 03 FF	AF Sensitivity Low
CAM_AFModelInq	8x 09 04 57 FF	y0 50 00 FF	Normal AF
		y0 50 01 FF	Interval AF
		y0 50 02 FF	Zoom Trigger AF
CAM_AFTimeSettingInq	8x 09 04 27 FF	y0 50 0p 0q 0r 0s FF	pq: Movement Time, rs: Interval
CAM_IRCorrectionInq	8x 09 04 11 FF	y0 50 00 FF	Standard
		y0 50 01 FF	IR Light
CAM_WBModelInq	8x 09 04 35 FF	y0 50 00 FF	Auto
		y0 50 01 FF	Indoor
		y0 50 02 FF	Outdoor
		y0 50 03 FF	One Push WB
		y0 50 04 FF	ATW
		y0 50 05 FF	Manual
		y0 50 06 FF	Outdoor Auto
		y0 50 07 FF	Sodium Lamp Auto
		y0 50 08 FF	Sodium Lamp
y0 50 09 FF	Sodium Lamp Outdoor Auto		
CAM_RGainInq	8x 09 04 43 FF	y0 50 00 00 0p 0q FF	pq: R Gain
CAM_BGainInq	8x 09 04 44 FF	y0 50 00 00 0p 0q FF	pq: B Gain
CAM_AEModelInq	8x 09 04 39 FF	y0 50 00 FF	Full Auto
		y0 50 03 FF	Manual
		y0 50 0A FF	Shutter Priority
		y0 50 0B FF	Iris Priority
		y0 50 0D FF	Bright

Inquiry Command	Command	Response Packet	Comments
CAM_ShutterPosInq	8x 09 04 4A FF	y0 50 00 00 0p 0q FF	pq: Shutter Position
CAM_IrisPosInq	8x 09 04 4B FF	y0 50 00 00 0p 0q FF	pq: Iris Position
CAM_GainPosInq	8x 09 04 4C FF	y0 50 00 00 0p 0q FF	pq: Gain Position
CAM_GainLimitInq	8x 09 04 2C FF	y0 50 0q FF	p: Gain Limit
CAM_ExpCompModelInq	8x 09 04 3E FF	y0 50 02 FF	On
		y0 50 03 FF	Off
CAM_ExpCompPosInq	8x 09 04 4E FF	y0 50 00 00 0p 0q FF	pq: ExpComp Position
CAM_BackLightModelInq	8x 09 04 33 FF	y0 50 02 FF	On
		y0 50 03 FF	Off
CAM_TallyInq	8x 09 7E 01 0A FF	y0 50 02 FF	On
		y0 50 03 FF	Off
CAM_SpotAEModelInq	8x 09 04 59 FF	y0 50 02 FF	On
		y0 50 03 FF	Off
CAM_SpotAEPosInq	8x 09 04 29 FF	y0 50 0p 0q 0r 0s FF	pq: X Position, rs: Y Position
CAM_WDModelInq	8x 09 04 3D FF	y0 50 02 FF	On
		y0 50 03 FF	Off
		y0 50 06 FF	VE On
CAM_WDParameterInq	8x 09 04 2D FF	y0 50 00 0q 0r 0s 0t 0u 00 00 FF	q: Display brightness level (0: Dark to 6: Bright) r: Brightness compensation selection (0: Very dark, 1: Dark, 2: Standard, 3: Bright) s: Compensation level (00h: Low, 01h: Mid, 02h: High) tu: Always 0
CAM_ApertureInq	8x 09 04 42 FF	y0 50 00 00 0p 0q FF	pq: Aperture Gain
CAM_HRModelInq	8x 09 04 52 FF	y0 50 02 FF	On
		y0 50 03 FF	Off
CAM_NRInq	8x 09 04 53 FF	y0 50 0p FF	Noise Reduction p: 00h to 05h
CAM_GammaInq	8x 09 04 5B FF	y0 50 0p FF	Gamma p: 00h , 01h
CAM_LR_ReverseModelInq	8x 09 04 61 FF	y0 50 02 FF	On (mirror)
		y0 50 03 FF	Off
CAM_FreezeModelInq	8x 09 04 62 FF	y0 50 02 FF	On
		y0 50 03 FF	Off

Inquiry Command	Command	Response Packet	Comments
CAM_PictureEffectModelInq	8x 09 04 63 FF	y0 50 00 FF	Off
		y0 50 02 FF	Neg. Art
		y0 50 04 FF	Black & White
CAM_PictureFlipModelInq	8x 09 04 66 FF	y0 50 02 FF	On
		y0 50 03 FF	Off
CAM_ICRModelInq	8x 09 04 01 FF	y0 50 02 FF	On
		y0 50 03 FF	Off
CAM_MemoryInq	8x 09 04 3F FF	y0 50 pp FF	pp: Memory number recalled last
CAM_MemoryStatusInq	8x 09 04 3F 0p FF	y0 50 0p 0q 0r 0s FF	p: Memory number q: mode (00-std, 10-std /w ccu, 01-trisync, 11-trisync /w ccu) rs: speed (0x1-0x18) 1 - 24
CAM_MemSaveInq	8x 09 04 23 0X FF	y0 50 0p 0q 0r 0s FF	X: 00h to 07h (Address) pqrs: 0000h to FFFFh (Data)
CAM_DisplayModelInq	8x 09 04 15 FF (8x 09 06 06 FF)	y0 50 02 FF	On
		y0 50 03 FF	Off
CAM_MuteModelInq	8x 09 04 75 FF	y0 50 02 FF	On
		y0 50 03 FF	Off
CAM_IDInq	8x 09 04 22 FF	y0 50 0p 0q 0r 0s FF	pqrs: Camera ID
CAM_VersionInq	8x 09 00 02 FF	y0 50 00 10 mn pq 0E 0E 02 FF	mnpq: Model Code
Vaddio_ModelInq	8x 09 08 0e FF	y0 50 05 00 00 00 00 FF	RoboSHOT 12
		y0 50 05 01 00 00 00 FF	RoboSHOT 30
		y0 50 05 02 00 00 00 FF	RoboSHOT 12 USB
		y0 50 05 04 00 00 00 FF	RoboSHOT 12 HDMI
		y0 50 05 05 00 00 00 FF	RoboSHOT 30 HDMI
		y0 50 05 06 00 00 00 FF	RoboSHOT 12 HD-SDI
		y0 50 05 07 00 00 00 FF	RoboSHOT 30 HD-SDI
		y0 50 06 01 00 00 00 FF	RoboSHOT 20 UHD
CAM_RegisterValueInq	8x 09 04 24 mm FF	y0 50 0p 0p FF	mm: Register No. (=00h to 7Fh) pp: Register Value (=00h to FFh)
CAM_ColorEnhanceInq	8x 09 04 20 FF	y0 50 mm 00 pp qq rr ss tt uu FF	mm: Threshold level pp: Y fixed color for high-intensity qq: Cr fixed color for high-intensity rr: Cb fixed color for high-intensity ss: Y fixed color for low-intensity tt: Cr fixed color for low-intensity

Inquiry Command	Command	Response Packet	Comments
			uu: Cb fixed color for low-intensity
	8x 09 04 50 FF	y0 50 02 FF	On
		y0 50 03 FF	Off
CAM_ChromaSuppressInq	8x 09 04 5F FF	y0 50 pp FF	pp: Chroma Suppress setting level
CAM_ColorGainInq	8x 09 04 49 FF	y0 50 00 00 00 0p FF	p: Color Gain Setting 0h to 4h
CAM_ColorHueInq	8x 09 04 4F FF	y0 50 00 00 00 0p FF	p: Color Hue Setting 0h (- 14 degrees) to Eh (+ 14 degrees)
CAM_TempInq	8x 09 04 68 FF	Y0 50 00 00 0p 0q FF	pq: Lens Temperature
CAM_GammaOffsetInq	8x 09 04 1E FF	y0 50 00 00 00 0s 0t 0u FF	s: Polarity offset (0 is plus, 1 is minus) tu: Offset s=0 (00h to 40h) Offset s=1 (00h to 10h)
Pan-tiltPosInq	8x 09 06 12 FF	y0 50 0w 0w 0w 0w 0z 0z 0z 0z FF	www= Pan position zzzz=Tilt Position

Specifications

Camera and image

Image device	RoboSHOT 12 HDBT: 1/2.8-Type Exmor [®] CMOS sensor RoboSHOT 30 HDBT: 1/2.8-Type Exmor R [™] backlit CMOS sensor		
Pixels	2.14 million (effective), 2.38 million (total)		
Pan and tilt	Pan $\pm 160^\circ$, tilt $+90^\circ -30^\circ$; pan and tilt speed 0.35°/sec to 120°/sec		
Lens and horizontal FOV	RoboSHOT 12 HDBT Normal (default): 10X optical zoom, 67.3° (wide) to 7.6° (tele), f=3.8mm to 38.0mm, F1.8 to F3.4 Super Wide: 12X optical zoom, 73.0° (wide) to 6.6° (tele), f=3.91mm to 47.0mm, F1.8 to F3.4 RoboSHOT 30 HDBT 30X optical zoom, 65° (wide) to 2.3° (tele), F1.6 to F4.7		
Min. working distance	RoboSHOT 12 HDBT: 10mm (wide), 0.8m (tele) RoboSHOT 30 HDBT: 10mm (wide), 1.2m (tele)		
Min. illumination	Recommended: 100+ lux	Gain	Auto / Manual (28 steps)
Backlight compensation	On/off	Aperture/detail	16 steps
Focusing system	Auto Focus / Manual Focus Mode / One Push Trigger Mode / Infinity Mode / Near Limit Mode		
White balance	Auto, ATW, Indoor, Outdoor, One-push, Manual		
Sync system	Internal	S/N ratio	More than 50 dB
Noise reduction	On/Off, 6 Steps	Power	12 VDC, 3.0 A or PoE+
Remote management	IR Remote Commander, web interface, Telnet and RS-232 command APIs		

Physical and Environmental

Height	6.9 in. (176 mm)	Weight	4.85 lbs.(2.2 kg)
Width	7.1 in. (179 mm)	Operating/storage temperature	0°C to +40°C (32°F to 104°F)
Depth	6.8 in. (172 mm)	Operating/storage humidity	20% to 80% RH, non-condensing

Specifications are subject to change without notice.

Troubleshooting and Care

When the camera doesn't behave as you expect, check the color of the indicator light on the front before you do anything else.

- **Blue:** Normal operation (blinks off momentarily when the camera receives a command from the remote)
- **Purple:** In standby mode or booting
- **Yellow:** Firmware update in progress
- **Flashing purple:** Error
- **Red:** On-air tally

Stuff happens – we get it. Use this table to determine whether it's time to call Vaddio Technical Support.

What is it doing?	Possible causes	Check and correct
<p>Nothing. The light on the front is off.</p> 	If a OneLINK extension module is used: The camera is not connected to the OneLINK module.	Plug the OneLINK module into the camera.
	If a OneLINK extension module is used: The OneLINK power supply is not connected.	Plug the OneLINK module's power supply into a wall outlet.
	If a OneLINK extension module is used: The OneLINK module is not working properly.	Test by connecting the camera directly to the 12VDC power pack that was shipped with it. Caution <i>Do not connect the camera to the 48 VDC OneLINK power pack. This will damage the camera and void its warranty.</i> If the camera works when it is connected to its 12 VDC power supply, but not when connected to the the OneLINK module, the OneLINK is bad. Contact your reseller or Vaddio Technical Support.
	Insufficient power using a PoE injector.	Use a PoE+ power injector – PoE does not deliver enough power.
	At least one of the cables is bad.	Check using known good cables.
	The camera or its power supply is bad.	Contact your reseller or Vaddio Technical Support.
	The wall outlet is not active. (Check by finding out if it powers something else, such as a laptop or phone charger.)	Use a different outlet.
	The camera never finishes initializing and the light is purple.	Insufficient power using a PoE injector.

What is it doing?	Possible causes	Check and correct
The camera is not responding to the remote and the light is yellow.	A firmware update is in progress.	Wait a few minutes, and try again when the light turns blue.
The camera does not respond to the remote, but the web interface is available	The remote is not using the same IR channel as the camera.	Push the Camera Select 1 button on the remote. Try the other Camera Select buttons if necessary.
	IR is switched off (DIP switch 3 down)	Turn IR on (DIP switch 3 up) - see Camera Settings for more information.
	The batteries in the remote are dead.	Put new batteries in the remote.
The camera responds to the remote but the web interface is not available.	The camera is not using the IP address you browsed to.	Press the Data Screen button on the remote to see camera information.
	The web interface has stopped responding.	Reboot the camera.
The camera's web UI is available but the camera does not respond to commands via RS-232 connection.	The RS-232 cable is not connected, or is bad.	Connect a known good cable.
	The camera's RS-232 settings don't match the settings on the controlling device.	Check the settings at both ends to be sure they match. The camera's current settings can be viewed on the System page in the web UI. Correct the settings where it's more convenient to do so.
The camera loses all its settings when power is cycled.	All the DIP switches are in the ON (down) position.	Set the DIP switches to their proper positions. Default is all OFF (up). See Switch Settings for more information.
No H.264 video stream.	Streaming is not enabled.	Enable streaming: Streaming page in the web interface.

Operation, Storage, and Care

For smears or smudges on the product, wipe with a clean, soft cloth. Use a lens cleaner on the lens. Do not use any abrasive chemicals.

Keep this device away from food and liquids.

Do not operate or store the device under any of the following conditions:

- Temperatures above 40°C (104°F) or below 0°C (32°F)
- High humidity, condensing or wet environments
- Inclement weather
- Severe vibration
- Between converging tectonic plates
- Dry environments with an excess of static discharge

Do not attempt to take this product apart. There are no user-serviceable components inside.

Compliance Statements and Declarations of Conformity

Compliance testing was performed to the following regulations:

FCC Part 15 (15.107, 15.109), Subpart B	Class A
ICES-003, Issue 54: 2012	Class A
EMC Directive 2004/108/EC	Class A
EN 55022: December 2010	Class A
EN 55024: November 2010	Class A
KN22 2008 (CISPR 22: 2006)	Class A
KN24 2008 (CISPR 24: 1997 + A1: 2000 + A2: 2002)	Class A
IEC 60950-1:2005 (2nd Edition); Am 1: 2009 + Am 2: 2013	Safety
EN 60950-1: 2006 + A11: 2009 + A1: 2010 + A12: 2011 + A2: 2013	Safety

FCC Part 15 Compliance

This equipment has been tested and found to comply with the limits for a Class A digital device, pursuant to Part 15, Subpart B, of the FCC Rules. These limits are designed to provide reasonable protection against harmful interference when the equipment is operated in a commercial environment. This equipment generates, uses, and can radiate radio frequency energy and, if not installed and used in accordance with the instruction manual, may cause harmful interference to radio communications. Operation of this equipment in a residential area is likely to cause harmful interference in which case the user will be required to correct the interference at his/her own expense.

Operation is subject to the following two conditions: (1) This device may not cause interference, and (2) This device must accept any interference including interference that may cause undesired operation of the device.

Changes or modifications not expressly approved by Vaddio can affect emission compliance and could void the user's authority to operate this equipment.



ICES-003 Compliance

This digital apparatus does not exceed the Class A limits for radio noise emissions from digital apparatus set out in the Radio Interference Regulations of the Canadian Department of Communications.

Le présent appareil numérique n'émet pas de bruits radioélectriques dépassant les limites applicables aux appareils numériques de la classe A prescrites dans le Règlement sur le brouillage radioélectrique édicté par le ministère des Communications du Canada.

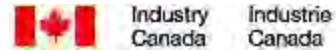

European Compliance

This product has been evaluated for electromagnetic compatibility under the EMC Directive for Emissions and Immunity and meets the requirements for a Class A digital device. In a domestic environment this product may cause radio interference in which case the user may be required to take adequate measures.

Standard(s) To Which Conformity Is Declared:



EMC Directive 2004/108/EC

EN 55022: December 2010

EN 55024: November 2010

EN 61000-4-2: 1995 + Amendments A1: 1998 + A2: 2001

EN 61000-4-3: 2006 + A1: 2008

EN 61000-4-4: 2004 + Corrigendum 2006

EN 61000-4-5: 2006

EN 61000-4-6: 2009

EN 61000-4-8: 2010

EN 61000-4-11: 2004

KN22 2008 (CISPR 22: 2006)

KN24 2008 (CISPR 24: 1997 + A1: 2000 + A2: 2002)

EN 61000-4-2

EN 61000-4-3

EN 61000-4-4

EN 61000-4-5

EN 61000-4-6

EN 61000-4-8

EN 61000-4-11

IEC 60950-1: 2005 (2nd Edition); Am 1: 2009 + Am 2: 2013

EN 60950-1: 2006 + A11: 2009 + A1: 2010 + A12: 2011 + A2: 2013

Conducted and Radiated Emissions

Immunity

Electrostatic Discharge

Radiated Immunity

Electrical Fast Transients

Surge Immunity

Conducted Immunity

Power Frequency Magnetic Field

Voltage Dips, Interrupts and Fluctuations

Conducted and Radiated Emissions

IT Immunity Characteristics

Electrostatic Discharge

Radiated Immunity

Electrical Fast Transients

Surge Immunity

Conducted Immunity

Power Frequency Magnetic Field

Voltage Dips, Interrupts and Fluctuations

Safety

Safety

Warranty Information

See Vaddio Warranty, Service and Return Policies posted on support.vaddio.com for complete details.

Hardware* warranty: Two (2) year limited warranty on all parts and labor for Vaddio manufactured products. Vaddio warrants its manufactured products against defects in materials and workmanship for a period of two years from the day of purchase, to the original purchaser, if Vaddio receives notice of such defects during the warranty. Vaddio, at its option, will repair or replace products that prove to be defective. Vaddio manufactures its hardware products from parts and components that are new or equivalent to new in accordance with industry standard practices.

Exclusions: The above warranty shall not apply to defects resulting from improper or inadequate maintenance by the customer, customers applied software or interfacing, unauthorized modifications or misuse, mishandling, operation outside the normal environmental specifications for the product, use of the incorrect power supply, modified power supply or improper site operation and maintenance. OEM and special order products manufactured by other companies are excluded and are covered by the manufacturer's warranty.

Vaddio Customer Service: Vaddio will test, repair, or replace the product or products without charge if the unit is under warranty. If the product is out of warranty, Vaddio will test then repair the product or products. The cost of parts and labor charge will be estimated by a technician and confirmed by the customer prior to repair. All components must be returned for testing as a complete unit. Vaddio will not accept responsibility for shipment after it has left the premises.

Vaddio Technical Support: Vaddio technicians will determine and discuss with the customer the criteria for repair costs and/or replacement. Vaddio Technical Support can be contacted by email at support@vaddio.com or by phone at one of the phone numbers listed on support.vaddio.com.

Return Material Authorization (RMA) number: Before returning a product for repair or replacement request an RMA from Vaddio's technical support. Provide the technician with a return phone number, e-mail address, shipping address, product serial numbers and original purchase order number. Describe the reason for repairs or returns as well as the date of purchase. See the General RMA Terms and Procedures section for more information. RMAs are valid for 30 days and will be issued to Vaddio dealers only. End users must return products through Vaddio dealers. Include the assigned RMA number in all correspondence with Vaddio. Write the assigned RMA number clearly on the shipping label of the box when returning the product. All products returned for credit are subject to a restocking charge without exception. Special order product are not returnable.

Voided warranty: The warranty does not apply if the original serial number has been removed or if the product has been disassembled or damaged through misuse, accident, modifications, use of incorrect power supply, use of a modified power supply or unauthorized repair.

Shipping and handling: Vaddio will not pay for inbound shipping transportation or insurance charges or accept any responsibility for laws and ordinances from inbound transit. Vaddio will pay for outbound shipping, transportation, and insurance charges for all items under warranty but will not assume responsibility for loss and/or damage by the outbound freight carrier. If the return shipment appears damaged, retain the original boxes and packing material for inspection by the carrier. Contact your carrier immediately.

Products not under warranty: Payment arrangements are required before outbound shipment for all out of warranty products.

Index

A

- admin login 16-17, 29
 - changing 29
 - default 16
- anatomy of the camera 5
- API 42, 54
 - syntax help 54
- auto focus 22, 45
- auto iris 36, 47-48
- auto white balance 36, 47-48
- automatic NTP updating 31

B

- backing up a configuration 37
- backlight compensation 36, 47-48
- baud rate setting 7
- behavior on power-up 13, 28
- blue gain 36, 47-48
- browser compatibility 16

C

- cable connectors 9
- Camera Control page (web) 20
- camera ID setting (DIP switch) 7
- camera mount, installing 10
- camera power 11
- camera select 14-15, See also camera ID setting (DIP switch)
- Camera Settings page (web) 35
- camera specifications 71
- camera standby position 21
- CCU scenes 24, 28, 36, 49
 - custom 24, 36, 49
 - recalling 49
- CCU settings 46-48
- ceiling-mounted cameras 10
- cheat sheet 14, 19
 - Vaddio IR Remote Commander 14
 - web interface 19
- chroma setting 36, 47-48
- cleaning 73
- color settings 24, 36, 47-48
- color space setting 7
- colors of the status light 5, 72
- command history 53

- compatibility, browsers 16
- configuration, saving or restoring 37
- connection example 11
- connector identification 6
- connector pin-out, RS-232 55
- custom CCU scenes 36
- custom home position, setting 28

D

- damage, preventing 8-9, 55
- default IP address 16
- default settings, restoring 38, 52
- detail setting 36, 47-48
- DHCP 30
- diagnostic logs 41
- Diagnostics page (web) 41
- DIP switch settings 7, 39
 - reading from web interface 39
- directional controls 14-15, 21

F

- factory defaults, restoring 38, 52
- fault isolation 72
- firmware update 37-38
- firmware version 37, 53
- focus 14-15, 22, 45

G

- gain 36, 47
 - blue 36
 - red 36
- getting help 40
- guest access 17, 29
 - allowing 29

H

- Help page (web) 40
- home position 21, 28, 43
 - custom 28
- hostname 30

I

- image flip setting (DIP switch) 7
- importing a configuration 37
- inactive sessions (web interface) 29
- indicator light 72
- information, conference room 29
- installation, typical 11
- inverted installation 10

- IP address 14-16, 30
 - default 16, 30
- IP streaming 32-34, 50
 - enabling or disabling 32
 - resolutions and frame rates 32
 - settings 33-34, 50
- IR on/off (DIP switch) 7
- IR remote 14-15
- iris settings 36, 47-48

- L**
- labels, room 29
- lighting settings 24, 36, 47-49
- locations of connectors 6
- log files 41
- login 16-17
 - admin 16-17
 - user 16
- low-power state 21, 49

- M**
- manual focus 14-15, 22, 45
- mounting cameras 8, 10, 12

- N**
- network configuration 16, 30, 50
 - default 16, 30
- Networking page (web) 30
- NTP server 31

- O**
- OneLINK 11, 72
- OneLINK system 11
- operating environment 73

- P**
- packing lists 2
- page 20, 29-30, 32, 35, 37, 40-41
 - Camera Control 20
 - Camera Settings 35
 - Diagnostics 41
 - Help 40
 - Networking 30
 - Room Labels 29
 - Security 29
 - Streaming 32
 - System 37
- pan 27, 43
 - direction 27
 - pan/tilt/zoom 14-15, 36
 - pan/tilt/zoom controls 21
- passwords 29
- performance specifications 71
- physical and environmental specifications 71
- pin-out, RS-232 connector 55
- ping command 51
- PoE+ power 11
- power-up settings 28
- power on/power off 13-15
- power options 11
- presets 14-15, 23, 25, 46
 - clearing 15
 - moving to 23, 46
 - setting 15, 25, 46
- product returns and repairs 76

- Q**
- quick reference 14, 19
 - Vaddio IR Remote Commander 14
 - web interface 19

- R**
- ready state 21, 49
- rebooting the camera 37, 51
- red gain 36, 47-48
- remote control 14-15
- resolution 6, 32
 - IP streaming 32
 - switch setting 6
- restoring a configuration 37
- restoring default settings 38, 52
- RJ-45 connectors 9
- room information 29
- Room Labels page (web) 29
- RS-232 commands 56, 67
- RS-232 serial connection 55

- S**
- saving a configuration 37
- scenes, CCU 24, 36
 - naming 36
 - storing 36
- Scott 24
- Security page (web) 29
- session time-out 29
- settings, default, restoring 38, 52
- shelf-mounted cameras 12
- shelf, camera mount 10

- soft DIP switches 39
- solving problems 72
- specifications 71
- speed 26, 35-36, 43-45
 - focus 45
 - pan/tilt/zoom 26, 36, 43-44
- standby state 21, 49
- start-up behavior, setting 28
- static IP address 30
- status light, meanings of colors 5, 72
- storage environment 73
- storing a configuration 37
- Streaming page (web) 32
- streaming settings 32, 50
- super-wide mode setting (DIP switch) 7
- supported web browsers 16
- switch settings 7, 10, 37
 - baud rate (DIP switch) 7
 - camera ID (DIP switch) 7
 - color space (DIP switch) 7
 - image flip (DIP switch) 7, 10
 - IR 7
 - reading from web interface 37
 - super wide mode (DIP switch) 7
- switch, video resolution 6
- System page (web) 37
- system time 31

T

- technical specifications 71
- technical support 40
- Telnet command help 54
- Telnet session 42, 53-54
 - ending 54
 - history 53
- temperature, operating and storage 73
- tilt 27, 44
 - direction 27
- time zone 31
- Tri-Synchronous Motion (Tri-Sync) 25, 36, 46
- troubleshooting 72
- typical installation 12

U

- update 38
- user login 16, 29
 - changing 29
 - default 16

V

- Vaddio IR Remote Commander 14-15
- version, firmware 53
- video resolution setting 6

W

- wall-mounted cameras 12
- wall mount 10
- warranty 8, 76
- web browsers supported 16
- web interface 20, 29-30, 32, 35, 37, 40-41
 - Camera Control page 20
 - Camera Settings page 35
 - Diagnostics page 41
 - Help page 40
 - Networking page 30
 - Room Labels page 29
 - Security page 29
 - Streaming page 32
 - System page 37
- wide dynamic range setting 36, 47-48

Z

- zoom 21, 44
- zoom speed 14-15, 26, 44

Vaddio is a brand of Milestone AV Technologies · www.vaddio.com · Phone 800.572.2011 / +1.763.971.4400 · Fax +1.763.971.4464 · Email info@vaddio.com

Visit us at support.vaddio.com for firmware updates, specifications, drawings, manuals, technical support information, and more. Vaddio, RoboSHOT, and OneLINK are trademarks or registered trademarks of Milestone AV Technologies. HDBaseT™ and the HDBaseT Alliance logo are trademarks of the HDBaseT Alliance. Exmor® is a trademark of Sony Corporation. All other brand names or marks are used for identification purposes and are trademarks of their respective owners. In British Columbia, Milestone AV Technologies ULC carries on business as MAVT Milestone AV Technologies ULC.

©2017 Milestone AV Technologies

The logo for Vaddio, featuring the word "vaddio" in a bold, blue, sans-serif font. The letter "o" at the end is stylized as a circle with a smaller circle inside, resembling an eye or a camera lens.