



# User Manual

## Wireless AC Day/Night Camera with Color Night Vision

DCS-2136L

---

# Manual Overview

D-Link reserves the right to revise this publication and to make changes in the content hereof without obligation to notify any person or organization of such revisions or changes. Information in this document may become obsolete as our services and websites develop and change. Please refer to the [www.mydlink.com](http://www.mydlink.com) website for the most current information.

## Manual Revisions

Revision	Date	Description
1.0	August 15, 2013	DCS-2136L Revision A1 with firmware version 1.00

## Trademarks

D-Link and the D-Link logo are trademarks or registered trademarks of D-Link Corporation or its subsidiaries in the United States or other countries. All other company or product names mentioned herein are trademarks or registered trademarks of their respective companies.

Copyright © 2013 D-Link Corporation.

All rights reserved. This publication may not be reproduced, in whole or in part, without prior expressed written permission from D-Link Corporation.

---

# Table of Contents

<b>Product Overview</b> .....	5	Image Setup .....	37
Package Contents .....	5	Audio and Video .....	39
Introduction .....	7	Preset .....	41
Features .....	8	Motion Detection .....	43
Hardware Overview .....	9	Time and Date .....	44
Front .....	9	Event Setup .....	45
Rear .....	10	SD Card .....	53
Sides .....	11	Advanced .....	54
Zero Configuration Setup .....	13	Digital Input/Output .....	54
Camera Setup Wizard .....	17	ICR and White LED Light .....	55
Windows Users .....	17	HTTPS .....	56
Mac Users .....	18	Access List .....	57
Manual Hardware Installation .....	19	Maintenance .....	58
<b>Installation</b> .....	20	Device Management .....	58
Wireless Installation Considerations .....	20	System .....	59
WPS - Push Button Setup .....	21	Firmware Upgrade .....	60
<b>mydlink</b> .....	22	Status .....	61
<b>Configuration</b> .....	23	Device Info .....	61
Configuration Utility .....	23	Logs .....	62
Live Video .....	24	Help .....	63
Setup .....	26	<b>DI/DO Specifications</b> .....	64
Setup Wizard .....	26	<b>Technical Specifications</b> .....	65
Network Setup .....	32	<b>Safety Statements</b> .....	68
Wireless Setup .....	35		
Dynamic DNS .....	36		

# Product Overview

## Package Contents



DCS-2136L Wireless AC Day/Night Camera with Color Night Vision



CAT5 Ethernet cable



Power adapter



CD-ROM with User Manual and software



Quick Installation Guide

If any of the above items are missing, please contact your reseller.

**Note:** Using a power supply with a different voltage than the one included with your product will cause damage and void the warranty for this product.

# System Requirements

<b>Network Requirements</b>	<ul style="list-style-type: none"><li>• 10/100 Ethernet network or an 802.11ac/n/g/b wireless network</li></ul>
<b>CD Setup Wizard Requirements</b>	<p><b>Computer with the following:</b></p> <ul style="list-style-type: none"><li>• A PC with a wired connection to your router</li><li>• Windows® 8 (32/64bit), Windows® 7 (32/64bit), XP (32/64bit), Vista® (32/64bit), Mac OS®X 10.5 or above</li><li>• An Internet connection</li><li>• A router connected to your broadband modem</li></ul>
<b>Web-based Configuration Utility Requirements</b>	<p><b>Browser Requirements:</b></p> <ul style="list-style-type: none"><li>• Internet Explorer 7 or higher</li><li>• Firefox 12 or higher</li><li>• Safari 4 or higher</li><li>• Chrome 20 or higher</li></ul> <p><b>Note:</b> Make sure you have the latest version of Java installed. Visit <a href="http://www.java.com">www.java.com</a> to download the latest version.</p>
<b>mydlink Website Requirements</b>	<ul style="list-style-type: none"><li>• Broadband Internet connection</li><li>• Computer with:<ul style="list-style-type: none"><li>• Internet Explorer 7 or higher (ActiveX)</li><li>• Firefox 12 or higher</li><li>• Safari 4 or higher</li><li>• Chrome 20 or higher</li></ul></li></ul>

## Introduction

Congratulations on your purchase of the DCS-2136L Wireless AC Day/Night Camera with Color Night Vision. The DCS-2136L is a versatile and unique solution for your small office or home. Unlike a standard webcam, the DCS-2136L is a complete system with a built-in CPU and web server that transmits high quality video images for security and surveillance. The DCS-2136L can be accessed remotely, and controlled from any PC/Notebook over your local network or through the Internet via a web browser. The simple installation and intuitive web-based interface offer easy integration with your Ethernet/Fast Ethernet or 802.11ac/n/g wireless network. The DCS-2136L also comes with remote monitoring and motion detection features for a complete and cost-effective home security solution.

## Features

### **Simple to Use**

The DCS-2136L is a stand-alone system with a built-in CPU, requiring no special hardware or software. The DCS-2136L supports both ActiveX mode for Internet Explorer and Java mode for other browsers such as Chrome®, Firefox®, and Safari®.

### **Supports a Variety of Platforms**

Supports TCP/IP networking, HTTP, and other Internet related protocols. The DCS-2136L can also be integrated easily into other Internet/Intranet applications because of its standards-based features.

### **Web Configuration**

Using a standard Web browser, administrators can configure and manage the DCS-2136L directly from its own Web page via Intranet or Internet. This means you can access your DCS-2136L anytime, anywhere in the world.

### **All-Day Surveillance with low light color image capability**

A built-in white light LED lets you monitor an area 24 hours a day with full color images, even in areas with low light or complete darkness. Combined with the passive IR sensor which can be used to trigger the white light LED, the DCS-2136L is a versatile surveillance and security monitoring device.

### **Broad Range of Applications**

With today's high-speed Internet services, the DCS-2136L can provide the ideal solution for delivering live video images over the Intranet and Internet for remote monitoring. The DCS-2136L allows remote access using a Web browser for live image viewing, and allows the administrator to manage and control the DCS-2136L anytime, anywhere in the world. Many applications exist, including industrial and public monitoring of homes, offices, banks, hospitals, child-care centers, and amusement parks.

### **802.11ac Wireless or Ethernet/Fast Ethernet Support**

The DCS-2136L offers wireless 802.11ac and Ethernet/Fast Ethernet connectivity, making the DCS-2136L easy to integrate into your existing network environment. The DCS-2136L works with 10/100/1000Mbps Ethernet based networks for traditional wired environments, and works with 802.11ac routers or access points for added flexibility. The Site Survey feature also allows you to view and connect to any available wireless networks.

### **Remote Monitoring Utility**

The D-ViewCam application adds enhanced features and functionality for the DCS-2136L and allows administrators to configure and access the DCS-2136L from a remote site via Intranet or Internet. Other features include image monitoring, recording images to a hard drive, viewing up to 32 cameras on one screen, and taking snapshots.

# Hardware Overview

## Front

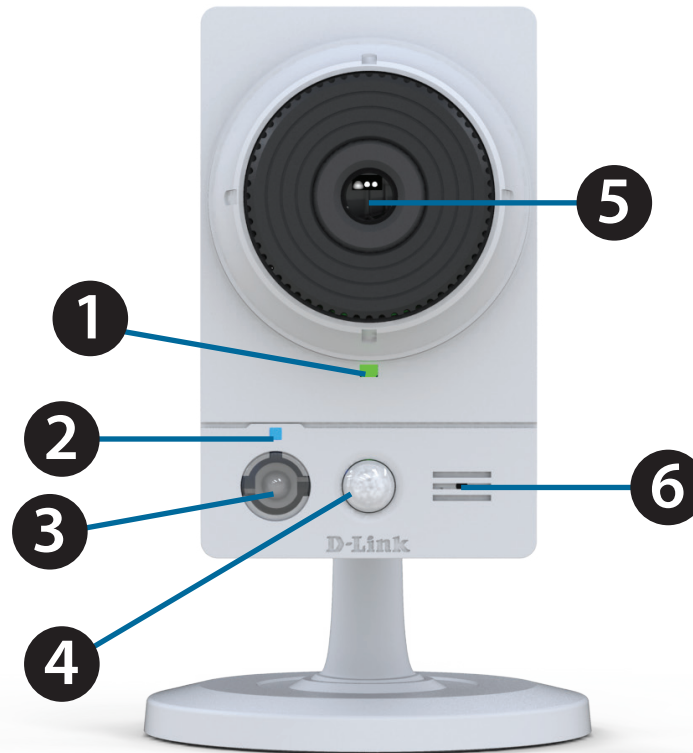

1	<b>Power/Link LED</b>	Indicates the camera's current status
2	<b>WPS Status LED</b>	Indicates the WPS connection status of the camera
3	<b>White Light LED</b>	Used to illuminate the camera's field of view at night
4	<b>PIR Sensor</b>	Passive Infrared sensor for motion detection
5	<b>Camera Lens</b>	Records video of the surrounding area
6	<b>Microphone</b>	Records audio from the surrounding area



## Rear

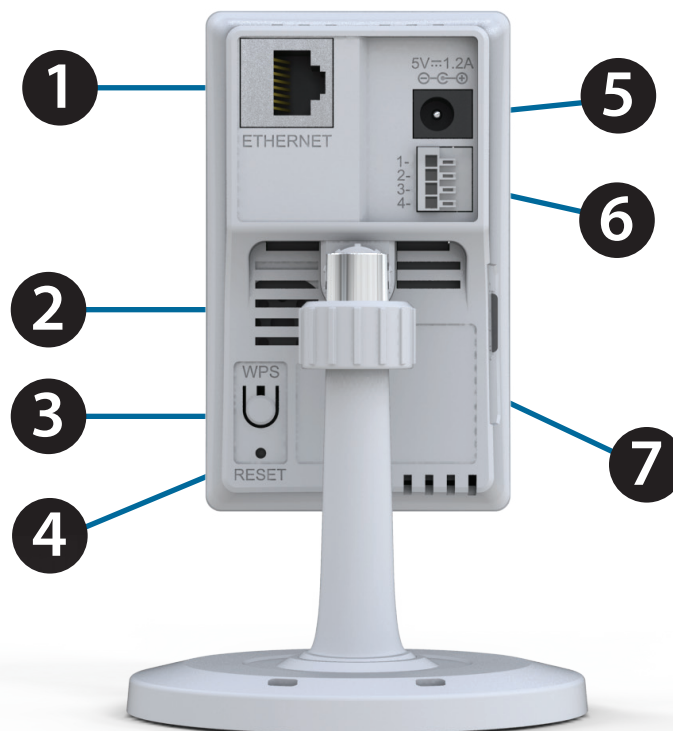

1	<b>Ethernet Port</b>	RJ45 connector for Ethernet
2	<b>Speaker</b>	Audio output
3	<b>WPS Button</b>	Press this button, then press the WPS button for 5 seconds on your router to set up a wireless connection automatically
4	<b>Reset Button</b>	Press and hold this button for 10 seconds to reset the camera
5	<b>Power Connector</b>	Connects to the included DC 5 V power adapter
6	<b>DI/DO Connector</b>	I/O connectors for external devices
7	<b>Adjustment Ring</b>	Tighten or loosen the adjustment ring to adjust the camera's position

## Sides



1	<b>Micro SD Card Slot</b>	Insert a MicroSD card for Local storage for storing recorded image and video
---	---------------------------	--

# Software Installation

There are three ways to set up your camera:

**Zero Configuration Setup:** If you have a mydlink-enabled router, this is the easiest way to set up your camera. Refer to page 12.

**Camera Setup Wizard:** If you do not have a mydlink-enabled router, use the Camera Installation Wizard to guide you through setup and initial configuration of your camera. Refer to page 16.

**Manual Hardware Installation:** This section shows you how to manually set up your camera, though in order to use the mydlink features of your camera, you will still need to run the Camera Installation Wizard. Refer to page 18.

## Zero Configuration Setup

If you have a D-Link Cloud Router, you can take advantage of Zero Configuration. Zero Configuration automatically configures your camera's settings for you, and adds it to your mydlink account automatically. This type of setup allows you to set up your camera by simply plugging it in and connecting it to your router.

Connect your camera to your mydlink enabled cloud router and Zero Configuration will automatically configure your DCS-2136L and automatically add the camera to your mydlink account. You can now remotely access your camera from the mydlink.com website to manage and monitor your DCS-2136L.

### Connect the Ethernet Cable

If using an Ethernet connection: Connect the included Ethernet cable to the Ethernet port located on the back of the DCS-2136L and connect it to your router.

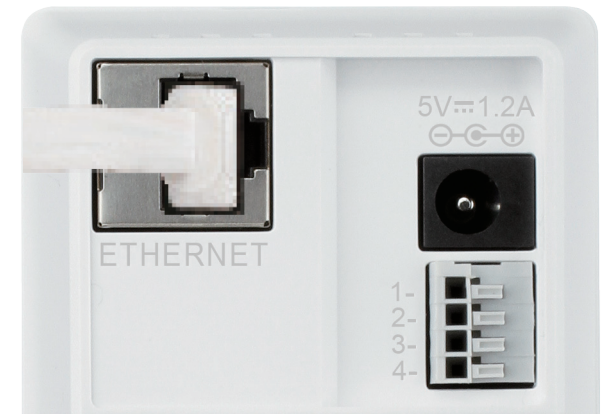

### Attach the External Power Supply

Attach the external power supply to the DC Power receptor located on the rear panel of the DCS-2136L and connect it to your wall outlet or power strip.

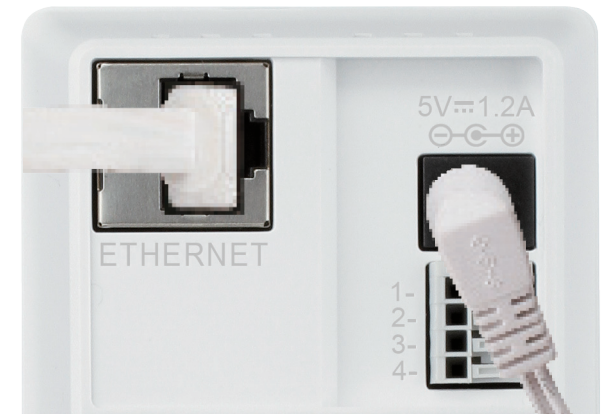

## Optional: WPS Wireless Connection

Alternatively, if your router supports WPS, you can use the WPS button on the camera to easily create a secure wireless connection to your network.

### To create a WPS connection:

#### Step 1

Press and hold the WPS button for approximately 5-6 seconds. The blue WPS status LED above the button will blink.

#### Step 2

Within 60 seconds press the WPS button on your router. On some routers, you may need to log in to the web interface and click on an on-screen button to activate the WPS feature. If you are not sure where the WPS button is on your router, please refer to your router's User Manual.

The DCS-2136L will automatically create a wireless connection to your router. While connecting, the status LED will flash. When the connection process is complete, the status LED will turn solid.

**Note:** If your router does not support WPS, you can still use the wired connection method on the previous page. After Zero Configuration setup is complete, your router's wireless settings will be automatically transferred to the camera.

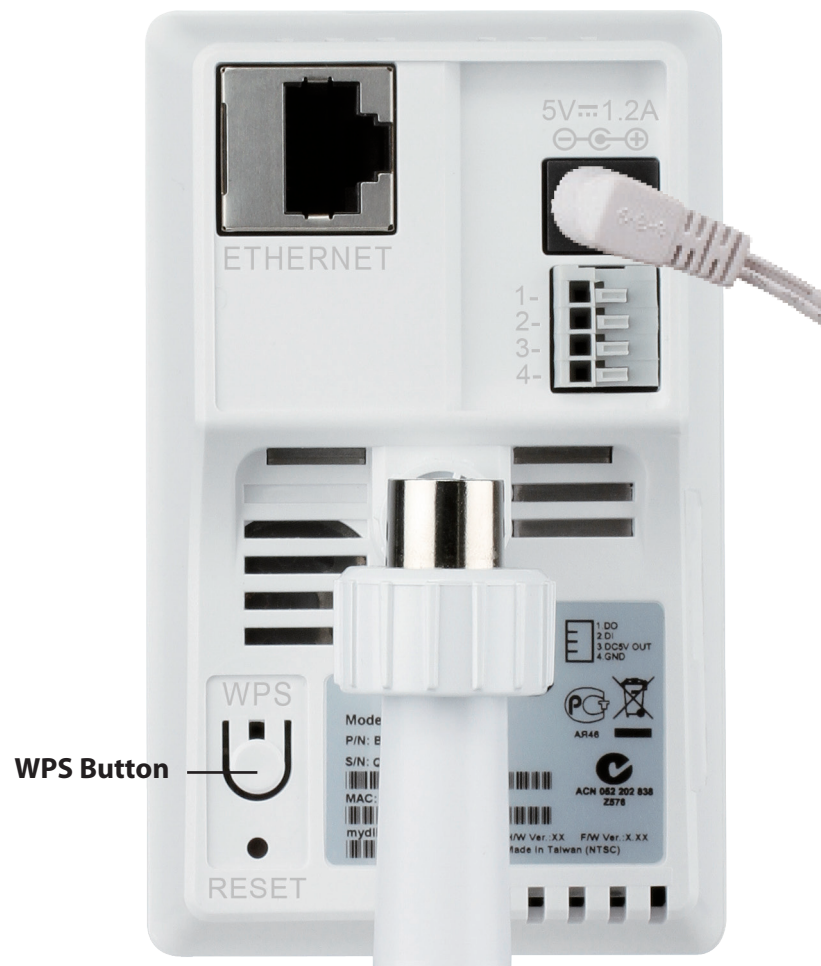

## Check Your mydlink Account

From any computer, open a web browser, go to <http://www.mydlink.com> and log into your account. Once mydlink detects your camera, a **New Device Found!** notice will appear in the bottom-left corner. Click on the device name to continue.

mydlink  
Welcome, Mehta P

My Devices Shared Devices My Services My Profile

DIR-605L  
20019962

Router Status Settings

Model Name DIR-605L Reboot

Network Name(SSID) Taonet

Internet IP 192.168.1.103

LAN IP 192.168.0.1

Connected Devices 5 device(s)

0000.3kB

0008.4kB

Connection List

Device	Device Name	IP Address	MAC Address	Block
	CardboardBox	192.168.0.110	00:26:2D:02:FE:FA	<input type="checkbox"/>
	--	192.168.0.120	04:54:53:50:53:18	<input type="checkbox"/>
	HeiGuy	192.168.0.100	00:1A:92:E2:4D:C9	<input type="checkbox"/>
	--	192.168.0.121	28:E0:2C:DC:0A:BE	<input type="checkbox"/>
	--	192.168.0.101	F0:A2:25:AA:8C:C3	<input type="checkbox"/>

Suspect List

Device	Device Name	Time	MAC Address	Block
--------	-------------	------	-------------	-------

New Device Found!

DCS-2136L

A summary and confirmation notification will appear with the automatically configured details. Make a note of the details and click **OK** to add the camera to your account.

Confirming New Device

Do you want to add this new device to your mydlink account?

**Device Name: DCS-2136L**  
**mydlink Number: 44441252**  
**Network name (SSID): dddddd**  
**Admin Password: oic953XZ**

You can change these default settings by going to **Advanced Settings** after add it to your device list.

Not now Yes

## Section 2: Installation

Zero Configuration is now complete and your camera has been added to your mydlink account. You can now view your camera on the mydlink Live View tab.

If you wish to connect your camera to your router wirelessly, you can simply disconnect the Ethernet cable and move the camera to its intended location; your router's wireless settings have been automatically transferred to the camera, and no further configuration is required.

Your camera is now set up, and you can skip to "mydlink" on page 21 to learn more about the mydlink features of this camera, or to "Configuration" on page 22 for advanced configuration of your camera.

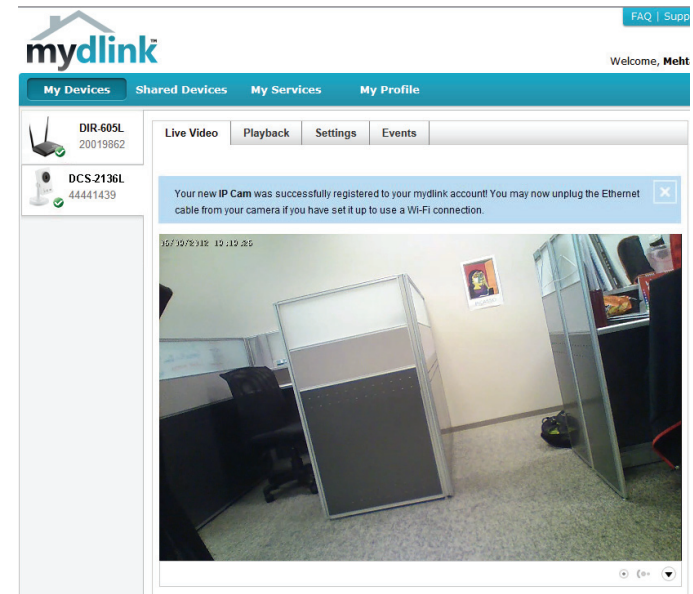

# Camera Setup Wizard

If you do not have a mydlink-enabled Cloud Router, you can use the Camera Setup Wizard to guide you through the process of adding your camera to the mydlink service.

## Windows Users

Insert the Installation CD-ROM into your computer's optical drive to start the autorun program. If the autorun program does not open, go to My Computer, browse to your CD drive, and double-click on the autorun.exe file. Once the wizard has started simply click **Set up your Cloud Camera** to go through the Setup Wizard, which will guide you step-by-step through the installation process from connecting your hardware to configuring your camera and registering it with your mydlink account.





## Mac Users

Insert the Installation CD-ROM into your computer's optical drive. On the desktop, open your CD drive and double-click on the **SetupWizard** file.



SetupWizard

After about 20-30 seconds, the Setup Wizard will open, which will guide you step-by-step through the installation process from connecting your hardware to configuring your camera and registering it with your mydlink account.



## Manual Hardware Installation

If you wish to set up your camera without using the Camera Setup Wizard, please follow these steps.

**Note:** In order to use the mydlink features of this product, you will need to go through the Camera Setup Wizard.

### Attach the External Power Supply

Attach the external power supply to the DC Power receptor located on the rear panel of the DCS-2136L and connect it to your wall outlet or power strip.

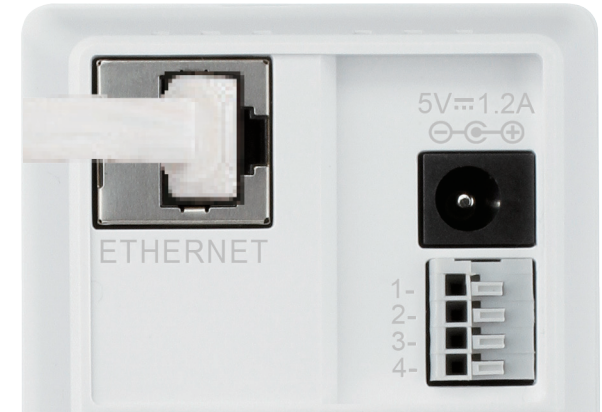

### Connect the Ethernet Cable

Connect the included Ethernet cable to the network cable connector located on the panel at the rear of the DCS-2136L and attach it to the network.

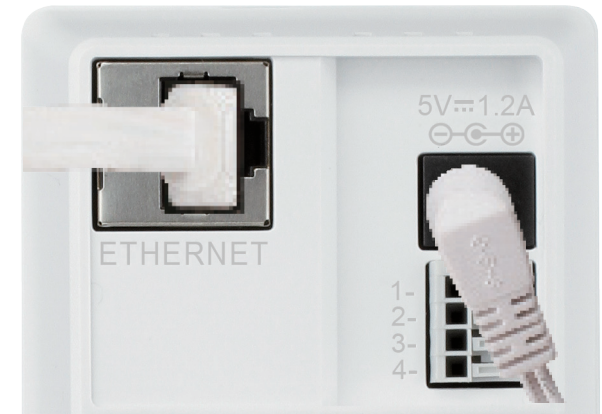

# Installation

## Wireless Installation Considerations

This D-Link device can connect to your wireless network from anywhere within the operating range of your wireless network. However, the number, thickness and location of walls, ceilings, or other objects that the wireless signals must pass through, may limit the range. Typical ranges vary depending on the types of materials and background RF (radio frequency) noise in your home or business. The key to maximizing wireless range is to follow these basic guidelines:

1. Minimize the number of walls and ceilings between your adapter and other network devices (such as your DCS-2136L) - each wall or ceiling can reduce your adapter's range from 3-90 feet (1-30 meters).
2. Be aware of the direct line between network devices. A wall that is 1.5 feet thick (.5 meters), at a 45-degree angle appears to be almost 3 feet (1 meter) thick. At a 2-degree angle, it looks over 42 feet (14 meters) thick. Position your devices so that the signal will travel straight through a wall or ceiling (instead of at an angle) for better reception.
3. Building Materials make a difference. A solid metal door or aluminum studs may weaken the wireless signal. Try to position your access points, wireless routers, and other networking devices where the signal passes through drywall or open doorways. Materials and objects such as glass, steel, metal, walls with insulation, water (fish tanks), mirrors, file cabinets, brick, and concrete will degrade your wireless signal.
4. Keep your product at least 3-6 feet or 1-2 meters away from electrical devices or appliances that generate RF noise.
5. If you are using 2.4GHz cordless phones or other radio frequency sources (such as microwave ovens), your wireless connection may degrade dramatically or drop completely. Make sure your 2.4GHz phone base is as far away from your wireless devices as possible. The base transmits a signal even if the phone is not in use.

## WPS - Push Button Setup

If your router supports WPS, you can use the WPS button on the camera to easily create a secure wireless connection to your network.

### To create a WPS connection:

#### Step 1

Press and hold the WPS button for approximately 5-6 seconds. The blue WPS status LED above the button will blink.

#### Step 2

Within 60 seconds press the WPS button on your router. On some routers, you may need to log in to the web interface and click on an on-screen button to activate the WPS feature. If you are not sure where the WPS button is on your router, please refer to your router's User Manual.

The DCS-2136L will automatically create a wireless connection to your router. While connecting, the status LED will flash. When the connection process is complete, the status LED will turn solid.

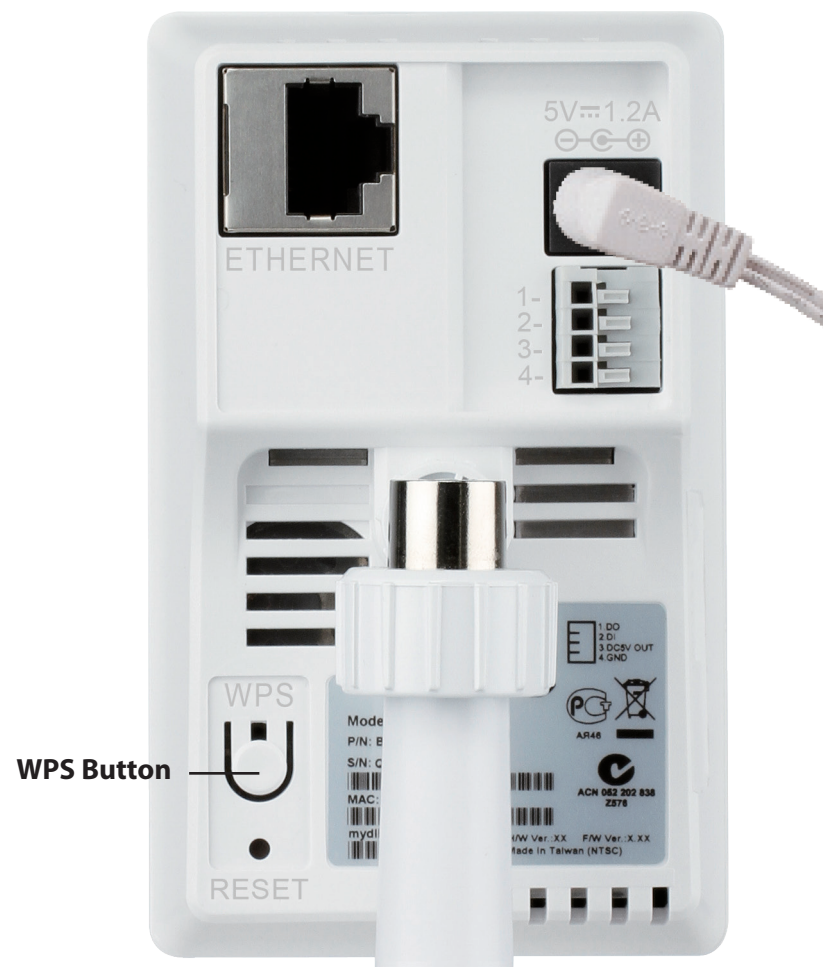

# mydlink

After registering your DCS-2136L camera with a **mydlink** account in the Camera Setup Wizard. You will be able to remotely access your camera from the [www.mydlink.com](http://www.mydlink.com) website. After signing in to your **mydlink** account, you will see a screen similar to the following:

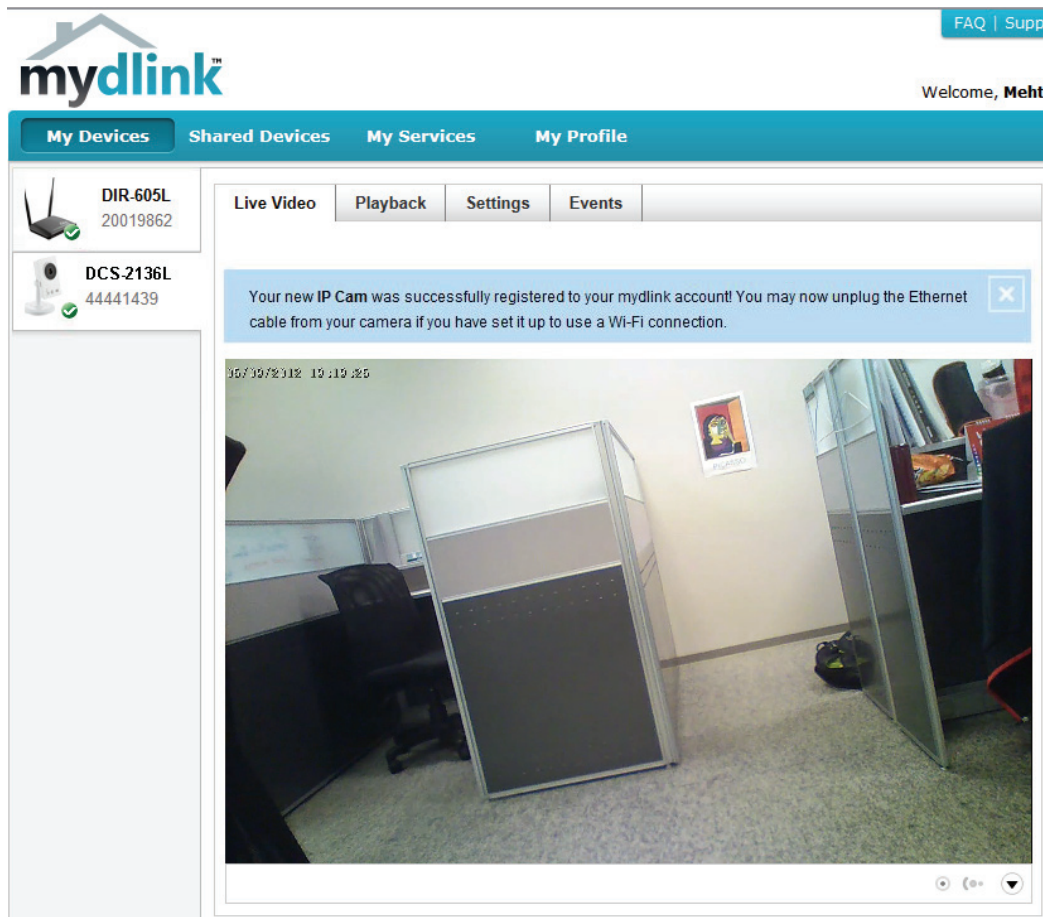

For more details on using your camera with mydlink, go to the **Support** section of the mydlink website and check the **User Manual** section for your product to find the latest instruction guide for your camera's mydlink features.

# Configuration Configuration Utility

After completing the Camera Installation Wizard, you are ready to use your camera. The camera's built-in Web configuration interface is designed to allow you to easily access and configure your DCS-2136L. At the end of the wizard, enter the IP address of your camera into a web browser, such as Internet Explorer®. To log in, use the User name **admin** and the password you created in the Installation Wizard. If you did not create a password, the default password is blank. After entering your password, click **OK**.

**Note:** If you are directly connecting your PC to the camera, or if you are using the camera on a closed network, the default IP is 192.168.0.20.

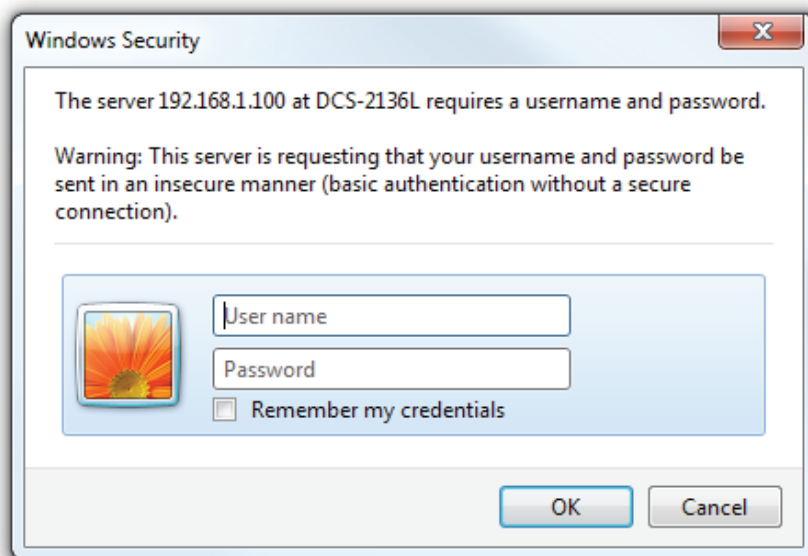

## Live Video







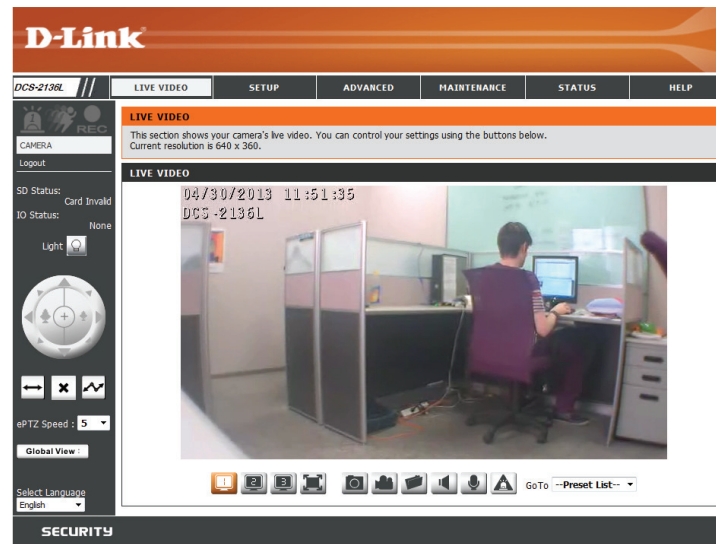

This section shows your camera's live video. You may select any of the available icons listed below to operate the camera. You may also select your language using the drop-down menu on the left side of the screen.

You can zoom in and out on the live video image using your mouse. Right-click to zoom out or left-click to zoom in on the image.

**SD Status:** This option displays the status of the SD card. If no SD card has been inserted, this screen will display the message "Card Invalid."

**IO Status:** This option displays the status of your I/O device if a device has been connected.



	<b>Digital Input Indicator</b>	This indicator will change color when a digital input signal is detected.
	<b>Motion Trigger Indicator</b>	This indicator will change color when a trigger event occurs. <b>Note:</b> The video motion feature for your camera must be enabled.
	<b>Recording Indicator</b>	When a recording is in progress, this indicator will change color.
	<b>White Light LED</b>	This button will enable or disable the white light LED. This may change depending on the setting configured in "White LED Light" on page 54
	<b>Control Pad</b>	This control pad can be used to electronically pan, tilt, and zoom (ePTZ) within the camera's predefined view area, if one has been defined.
	<b>Auto Pan</b>	Starts the automatic panning function. The ROI will pan from back and forth within the FOV
	<b>Stop</b>	Stops automatic panning.
	<b>Preset Path</b>	Starts the camera's motion along the predefined path.

## Section 4: Configuration





**ePTZ Speed:** You may select a value between 0 and 64. 0 is the slowest and 64 is the fastest.



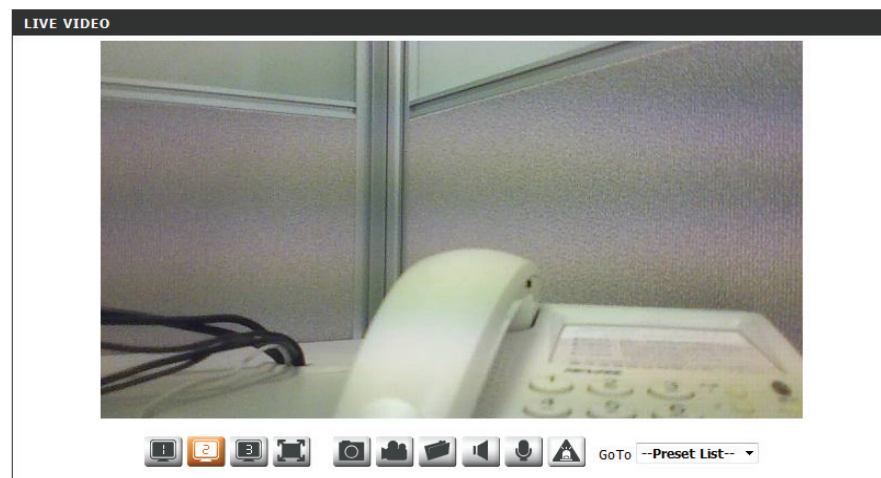

**Global View:** This window indicates the total field of view (FOV) of the camera. The red box indicates the visible region of interest (ROI).

**Language:** You may select the interface language using this menu.

**Go To:** If any presets have been defined, selecting a preset (Preset List) from this list will display it.



-  Video Profile 1
-  Video Profile 2
-  Video Profile 3
-  Full screen mode
-  Taking a Snapshot

-  Record a Video Clip
-  Set a Storage Folder
-  Listen/Stop Audio In (from microphone)
-  Start/Stop Audio Out (to speaker)
-  Start/Stop Digital Output



# Setup

## Setup Wizard

This section allows you to begin setup wizards which will guide you through the process of getting your camera's various functions configured. If you comfortable with adjusting the settings manually, you may skip the wizards and adjust the necessary as needed.

**Internet Connection Setup Wizard:** You may choose to configure your network by using the Internet Connection Setup Wizard that includes step-by-step instructions. Please refer to page "Internet Connection Setup Wizard" on page 26 for more details.

**Manual Internet Connection Setup:** If you would rather manually setup the camera internet connection, you can refer to page "Network Setup" on page 31 which provides more details on the information required.

**Motion Detection Setup Wizard:** You may choose to configure motion detection by using the Motion Detection Setup Wizard that includes step-by-step instructions. Please refer to page "Motion Detection Setup Wizard" on page 29 for more details.

**Manual Motion Detection Setup:** If you would rather manually setup the camera's motion detection features, you can refer to page "Motion Detection" on page 42 which provides more details on the information required.

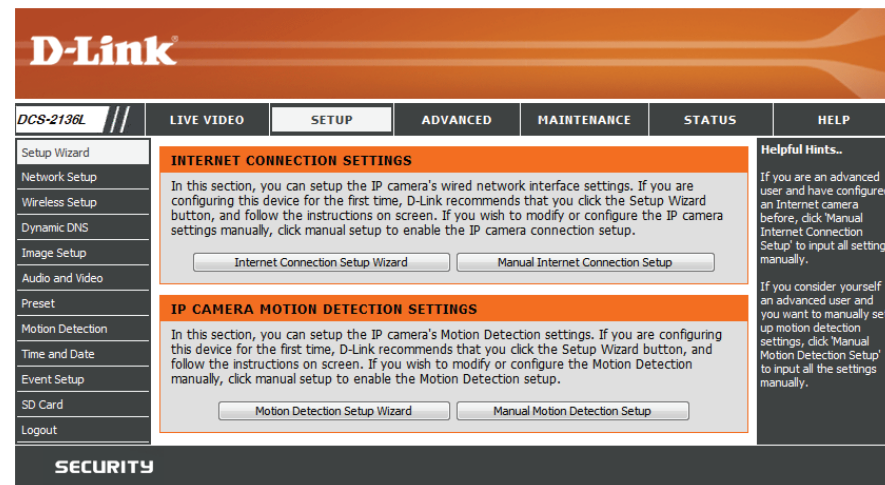

## Internet Connection Setup Wizard

This wizard will guide you through a step-by-step process to configure your new D-Link Camera and connect the camera to the Internet. **Note that this wizard will not register your camera with mydlink.com.**

Click **Next** to continue.

Select **Automatic IP Address** if you want your DHCP server (usually enabled on your router) to assign the camera its IP settings. If you want to manually assign the IP settings, select **Static IP Address** and enter the following details:

**IP Address:** Enter an IP address for your camera.

**Subnet Mask:** Enter the subnet mask of your network.

**Default Gateway:** Enter the default gateway address. This is usually the IP address of your router.

**Primary DNS:** Enter the primary DNS server's IP address. This is usually the IP address of your router.

**Secondary DNS:** Enter the secondary DNS server's IP address. This is optional.

If you are required to connect using PPPoE, select **Enabled** and enter the Username and Password for your PPPoE connection. Only select this option if your camera is directly connected to your broadband modem. If it is on a network with a router or gateway, do not select this option.

Click **Next** to continue.

### welcome to d-link setup wizard - internet connection setup

This wizard will guide you through a step-by-step process to configure your new D-Link IP camera and connect the IP camera to the internet. To set-up your camera motion detection settings, please click Back button to close this wizard and re-open the motion detection setup wizard.

- Step 1: Setup LAN Settings
- Step 2: Setup DDNS Settings
- Step 3: IP camera Name Settings
- Step 4: Setup Time Zone

Back Next Cancel

### Step 1: Setup LAN Settings

Please select whether your IP camera will connect to the Internet with a DHCP connection or Static IP address. If your IP camera is connected to a router, or you are unsure which settings to pick, D-Link recommends that you keep the default selection of DHCP connection. Otherwise, click on Static IP address to manually assign and IP address before clicking on the Next button. Please enter your ISP Username and Password in the case that your ISP is using PPPoE and then click on the Next button. Please contact your ISP if you do not know your Username and Password.

DHCP  
 Static IP Client

IP address   
 Subnet mask   
 Default router   
 Primary DNS   
 Secondary DNS

Enable PPPoE  
 User Name   
 Password  (e.g. 654321@hinet.net)

Back Next Cancel

## Section 4: Configuration

A Dynamic DNS account allows you to access your camera over the Internet when you have an IP address that changes each time you connect to the Internet. If you have a Dynamic DNS account, click **Enable** and enter the following details:

**Enable:** Click to enable the DDNS function.

**DDNS:** (Dynamic Domain Name Server) will hold a DNS host name and synchronize the public IP address of the modem when it has been modified. The username and password are required when using the DDNS service.

**Server Address:** Select your Dynamic DNS Server from the drop down menu.

**Host Name:** Enter the host name of the DDNS server.

**User Name:** Enter your username or e-mail address used to connect to the DDNS.

**Password:** Enter your password used to connect to the DDNS server.

**Timeout:** You can setup how often the camera notifies the DDNS server of its current global IP address by entering a whole number in hours.

Click **Next** to continue.

### Step 2: Setup DDNS Settings

If you have a Dynamic DNS account and would like the IP camera to update your IP address automatically, enable DDNS and enter in your host information below. Please click on the Next button to continue.

Enable DDNS	<input type="checkbox"/>
Server Address	www.dlinkddns.com << www.dlinkddns.com ▾
Host Name	<input type="text"/>
User Name	<input type="text"/>
Password	<input type="text"/>
Verify Password	<input type="text"/>
Timeout	24 (hours)
<input type="button" value="Back"/> <input type="button" value="Next"/> <input type="button" value="Cancel"/>	

## Section 4: Configuration

Create a unique name for your camera. Click **Next** to continue.

Select the time zone that the camera is geographically located in so that scheduled events occur at the correct time. If your time zone observes daylight saving, check the **Enable Daylight Saving** box and select **Auto Daylight Saving** to have DST set automatically or select **Set date and time manually** to enable the drop-down menu so that you can set the start and end time of daylight saving yourself.

Click **Next** to continue.

A summary of the options you selected is displayed for confirmation. If you are happy with the selected configuration, click **Apply** otherwise click **Back** to make the required changes.

### Step 3: IP camera Name Settings

D-Link recommends that you rename your IP camera for easy accessibility. You can then identify and connect to your IP camera via this name. Please assign a name of your choice before clicking on the Next button.

IP camera Name DCS-2136L

Back Next Cancel

### Step 4: Setup Time Zone

Please configure the correct time to ensure that all events are triggered, captured and scheduled at the correct time and day and then click on the Next button.

Time Zone (UTC+08:00) Taipei

Enable Daylight Saving

Back Next Cancel

### Step 5: Setup complete

Below is a summary of your IP camera settings. Click on the Back button to review or modify settings or click on the Apply button if all settings are correct. It is recommended to note down these settings in order to access your IP camera on the network or via your web browser.

IP Address	DHCP
IP camera Name	DCS-2136L
Time Zone	(UTC+08:00) Taipei
DDNS	Disable
PPPoE	Disable

Back Apply Cancel

## Motion Detection Setup Wizard

This wizard will guide you through a step-by-step process to configure your camera's motion detection functions.

Click **Next** to continue.

### Step 1

This step will allow you to enable or disable motion detection, specify the detection sensitivity, and adjust the camera's ability to detect movement.

You may specify whether the camera should capture a snapshot or a video clip when motion is detected.

Please see the **Motion Detection** section on "Motion Detection" on page 42 for information about how to configure motion detection.

### Step 2

This step allows you to enable motion detection based on a customized schedule. Specify the day and hours. You may also choose to always record whenever motion is detected.

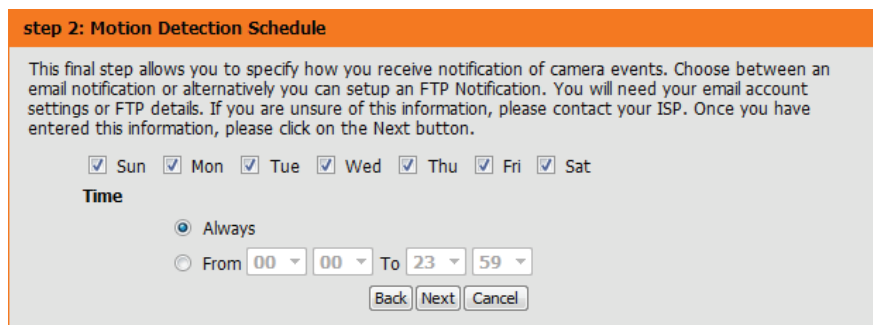
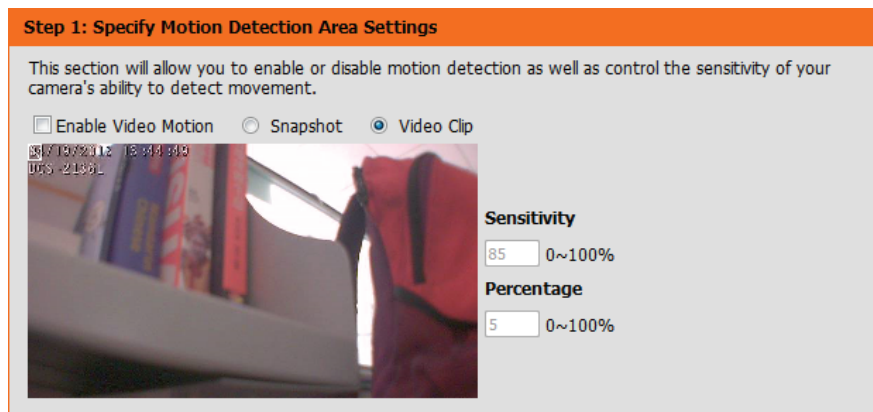
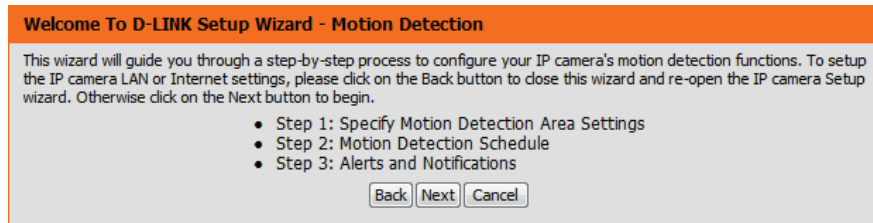

## Section 4: Configuration

### Step 3

This step allows you to specify how you will receive event notifications from your camera. You may choose not to receive notifications, or to receive notifications via e-mail or FTP.

Please enter the relevant information for your e-mail or FTP account.

Click **Next** to continue.

**Step 3: Alerts and Notification**

This final step allows you to specify how you receive notification of camera events. Choose between an email notification or alternatively you can setup an FTP Notification. You will need your email account settings or FTP details. If you are unsure of this information, please contact your ISP. Once you have entered this information, please click on the Next button.

Do not notify me

Email

Sender email address

Recipient email address

Server address

User name

Password

Port

FTP

Server address

Port

User name

Password

Remote folder name

### Step 4

You have completed the Motion Detection Wizard.

Please verify your settings and click **Apply** to save them.

**Step 4: Setup Complete**

You have completed your IP camera setup. Please click the Back button if you want to review or modify your settings or click on the Apply button to save and apply your settings.

Motion Detection : Disable

EVENT : Video Clip

Schedule Day : Sun ,Mon ,Tue ,Wed ,Thu ,Fri ,Sat ,

Schedule Time : Always

Alerts and Notification : Do not notify me

Please wait a few moments while the camera saves your settings and restarts.

## Network Setup

Use this section to configure the network connections for your camera. All relevant information must be entered accurately. After making any changes, click the **Save Settings** button to save your changes.

**LAN Settings:** This section lets you configure settings for your local area network.

**DHCP:** Select this connection if you have a DHCP server running on your network and would like your camera to obtain an IP address automatically.

**Static IP Address:** You may obtain a static or fixed IP address and other network information from your network administrator for your camera.

**IP Address:** Enter the fixed IP address in this field.

**Subnet Mask:** This number is used to determine if the destination is in the same subnet. The default value is 255.255.255.0.

**Default Gateway:** The gateway used to forward data to.

**Primary DNS:** The primary domain name server translates names to IP addresses.

**Secondary DNS:** The secondary DNS acts as a backup to the primary.

**Enable UPnP Presentation:** Enabling this setting allows your camera to be configured as a UPnP device on your network.

**Enable UPnP Port Forwarding:** Enabling this setting allows the camera to add port forwarding entries into the router automatically on a UPnP capable network.

The screenshot shows the D-Link web interface for the DCS-2136L camera. The 'NETWORK SETUP' page is active, displaying the following configuration options:

- LAN SETTINGS:**
  - DHCP
  - Static IP Client
    - IP address: 192.168.1.100
    - Subnet mask: 255.255.255.0
    - Default router: 192.168.1.1
    - Primary DNS: 192.168.1.1
    - Secondary DNS: 0.0.0.0
- Enable UPnP presentation
- Enable UPnP port forwarding
  - Forwarding Port: 1024
  - Forwarding Status: UPnP forwarding is inactive

Buttons for 'Save Settings' and 'Don't Save Settings' are visible at the top of the configuration area. A 'Helpful Hints' sidebar on the right provides additional information about DHCP, UPnP, and PPPoE settings.

**Enable PPPoE:** Enable this setting if your network uses PPPoE.

**User Name / Password:** Enter the username and password for your PPPoE account. Re-enter your password in the Confirm Password field. You may obtain this information from your ISP.

**HTTP Port:** The default port number is 80.

**Access Name for Stream 1~3:** The default name is video#.mjpg, where # is the number of the stream.

**HTTPS Port:** You may use a PC with a secure browser to connect to the HTTPS port of the camera. The default port number is 443.

**RTSP Port:** The port number that you use for RTSP streaming to mobile devices, such as mobile phones or PDAs. The default port number is 554. You may specify the address of a particular stream. For instance, live1.sdp can be accessed at rtsp://x.x.x.x/video1.sdp where the x.x.x.x represents the ip address of your camera.

**Enable CoS:** Enabling the Class of Service setting implements a best-effort policy without making any bandwidth reservations.

**Enable QoS:** Enabling QoS allows you to specify a traffic priority policy to ensure a consistent Quality of Service during busy periods. If the DCS-2136L is connected to a router that itself implements QoS, the router's settings will override the QoS settings of the camera.

The screenshot displays the configuration web interface for the camera, organized into several sections:

- PPPOE SETTINGS:** Features radio buttons for 'Enable' and 'Disable' (selected). Below are input fields for 'User Name', 'Password', and 'Confirm password'. The 'PPPoE Status' is shown as 'PPPoE is inactive'.
- HTTP:** Includes an 'HTTP port' field set to '80' and three 'Access name for stream' fields (stream1, stream2, stream3) all containing 'video#.mjpg'.
- HTTPS:** Features an 'HTTPS port' field set to '443'.
- RTSP:** Includes an 'Authentication' dropdown set to 'Disable', an 'RTSP port' field set to '554', and three 'Access name for stream' fields (stream1, stream2, stream3) containing 'live#.sdp'.
- CoS SETTINGS:** Starts with an 'Enable CoS' checkbox. Below are fields for 'VLAN ID' (set to '1'), and dropdowns for 'Live video', 'Live audio', 'Event/Alarm', and 'Management', all set to '0'. A red note indicates the VLAN ID range is [0~4095].
- QoS SETTINGS:** Starts with an 'Enable QoS' checkbox. Below are dropdowns for 'Live video', 'Live audio', 'Event/Alarm', and 'Management', all set to '0'.

On the right side of the interface, there are several informational notes:

- HTTP:** HTTP Port is the port you allocate in order to connect to the IP camera via a standard web browser.
- HTTPS:** HTTPS Port in a IP camera connects it with a PC via a secure web browser.
- RTSP:** RTSP Port is the port you allocate in order to connect to a IP camera by using streaming mobile device(s), such as a mobile phone or PDA.
- CoS (Class of Service):** Coarsely-grained traffic control based on the L2 protocol. Class of Service technologies do not guarantee a level of service in terms of bandwidth and delivery time, they offer a "best-effort".
- QoS (Quality of Service):** Finely-grained traffic control, a resource reservation control mechanism. Quality of service guarantees are important if the network capacity is insufficient, especially for real-time streaming multimedia applications.
- Enable IPv6:** Select this option and click Save to enable IPv6 setting. Please note that this only works if your network environment and hardware equipment support IPv6. The browser should be Microsoft® Internet Explorer 6.5, Mozilla Firefox 3.0 or above. When IPv6 is enabled, by default, the Network Camera will listen to router advertisements and be assigned a link-local IPv6 address accordingly.
- IPv6 Information:** Click this button to obtain the IPv6 information. If your IPv6 setting are successful, the IPv6 address list will be listed in the pop-up window.



**Enable IPv6:** Enable the IPV6 setting to use the IPV6 protocol. Enabling the option allows you to manually set up the address, specify an optional IP address, specify an optional router and an optional primary DNS.

**Enable Multicast for stream** The DCS-2136L allows you to multicast each of the available streams via group address and specify the TTL value for each stream. Enter the port and TTL settings you wish to use if you do not want to use the defaults.

Please verify your settings and click **Save Settings** to commit them.

The screenshot displays the configuration interface for the DCS-2136L, divided into two main sections: IPv6 and MULTICAST.

**IPv6 Section:**

- Enable IPv6
- IPv6 Information** (button)
- Manually setup the IP address
  - Optional IP address / Prefix length: [ ] / [ 64 ]
  - Optional default router: [ ]
  - Optional primary DNS: [ ]

**MULTICAST Section:**

- Enable multicast for stream 1
  - Multicast group address: 239.1.1.1
  - Multicast video port: 6550
  - Multicast RTPC video port: 6551
  - Multicast audio port: 6552
  - Multicast RTPC audio port: 6553
  - Multicast TTL [1~255]: 64
- Enable multicast for stream 2
  - Multicast group address: 239.1.1.2
  - Multicast video port: 6554
  - Multicast RTPC video port: 6555
  - Multicast audio port: 6556
  - Multicast RTPC audio port: 6557
  - Multicast TTL [1~255]: 64
- Enable multicast for stream 3
  - Multicast group address: 239.1.1.3
  - Multicast video port: 6558
  - Multicast RTPC video port: 6559
  - Multicast audio port: 6560
  - Multicast RTPC audio port: 6561
  - Multicast TTL [1~255]: 64

At the bottom of the configuration area, there are two buttons: **Save Settings** and **Don't Save Settings**.

**Annotations on the right side of the screenshot:**

- IPv6:** In the pop-up window, please follow the steps below to link to an IPv6 address:
  - 1) Open your web browser.
  - 2) Enter the link-global or link-local IPv6 address in the address bar of your web browser.
  - 3) Press Enter on the keyboard or click Refresh button to refresh the webpage.
- Manually setup the IP address:** Select this option to manually configure IPv6 setting if your network environment does not have DHCPv6 server and advertisements-enabled routers.
- Multicast:** Click the items to display the detailed configuration information. Select the Always multicast option to enable multicast for stream 1 ~ 3. Unicast video transmission delivers a stream through point-to-point transmission; multicast, on the other hand, sends a stream to the multicast group address and allows multiple clients to acquire the stream at the same time by requesting a copy from the multicast group address. Therefore, enabling multicast can effectively save network bandwidth.
- Multicast RTP video, audio port/Multicast RTPC video, audio port:** The ports can be changed to values between 1024 and 65534. The multicast RTP port must be an even number and the multicast RTPC port number is the multicast RTP port number plus one, and this is always odd. When

## Wireless Setup

This section allows you to set up and configure the wireless settings on your camera. After making any changes, click the **Save Settings** button to save your changes.

**Site Survey:** Click the **Rescan** button to scan for available wireless networks. After scanning, you can use the drop-down box to select an available wireless network. The related information (SSID, Wireless Mode, Channel, Authentication, Encryption) will be automatically filled in for you.

**SSID:** Enter the SSID of the wireless access point you wish to use.

**Wireless Mode:** Use the drop-down box to select the mode of the wireless network you wish to connect to. Infrastructure is normally used to connect to an access point or router. Ad-Hoc is usually used to connect directly to another computer.

**Channel:** If you are using Ad Hoc mode, select the channel of the wireless network you wish to connect to, or select Auto.

**Authentication:** Select the authentication you use on your wireless network - Open, Shared, WPA-PSK, or WPA2-PSK.

**Encryption:** If you use WPA-PSK or WPA2-PSK authentication, you will need to specify whether your wireless network uses TKIP or AES encryption. If you use Open or Shared authentication, WEP encryption should be the setting.

**Key:** If you use WEP, WPA-PSK, or WPA2-PSK authentication, enter the Key (also known as password) used for your wireless network.

The screenshot shows the D-Link web interface for the DCS-2136L camera. The top navigation bar includes 'LIVE VIDEO', 'SETUP', 'ADVANCED', 'MAINTENANCE', 'STATUS', and 'HELP'. The 'SETUP' menu is expanded, showing options like 'Setup Wizard', 'Network Setup', 'Wireless Setup', 'Dynamic DNS', 'Image Setup', 'Audio and Video', 'Preset', 'Motion Detection', 'Time and Date', 'Event Setup', 'SD Card', and 'Logout'. The 'Wireless Setup' page is active, displaying the 'WIRELESS CONFIGURATION' section. The settings are as follows:

- Enable Wireless:
- Site Survey:
- SSID:
- Wireless Mode:
- Channel:
- Authentication:
- Encryption:
- Default Key:
- Key 1:
- Key 2:
- Key 3:
- Key 4:

Below the keys, there is a note: "(5 or 13 ASCII, 10 or 26 HEX characters)". At the bottom of the configuration section, there are 'Save Settings' and 'Don't Save Settings' buttons. On the right side, there is a 'Helpful Hints...' section with text explaining SSID, Authentication (Open, Shared), and WPA-PSK/WPA2-PSK settings.

## Dynamic DNS

DDNS (Dynamic Domain Name Server) will hold a DNS host name and synchronize the public IP address of the modem when it has been modified. A user name and password are required when using the DDNS service. After making any changes, click the **Save Settings** button to save your changes.

**Enable DDNS:** Select this checkbox to enable the DDNS function.

**Server Address:** Select your Dynamic DNS provider from the pull down menu or enter the server address manually.

**Host Name:** Enter the host name of the DDNS server.

**User Name:** Enter the user name or e-mail used to connect to your DDNS account.

**Password:** Enter the password used to connect to your DDNS server account.

**Timeout:** Enter the DNS timeout values you wish to use.

**Status:** Indicates the connection status, which is automatically determined by the system.

The screenshot shows the D-Link web interface for the DCS-2136L device. The main content area is titled "DYNAMIC DNS" and contains the following text:

The Dynamic DNS feature allows you to use a domain name that you have purchased (www.yourdomain.com) to access your IP camera with a dynamically assigned IP address. Most broadband Internet service providers assign dynamic (changing) IP addresses. By using a DDNS service, you can enter your domain name to connect to your IP camera no matter what your IP address is.

Sign up for D-Link's Free DDNS service at [www.DLinkDDNS.com](http://www.DLinkDDNS.com).

Buttons: Save Settings, Don't Save Settings

The "DYNAMIC DNS SETTING" section includes the following fields:

- Enable DDNS:
- Server Address:  <<
- Host Name:
- User Name:
- Password:
- Verify Password:
- Timeout:  (hours)
- Status: Inactive

Buttons: Save Settings, Don't Save Settings

The sidebar on the right contains "Helpful Hints..":

Dynamic DNS is useful if you have a DSL or Cable service provider that changes your modem IP address periodically. This will allow you to assign a website domain name to your IP camera instead of connecting through an IP address.

The bottom of the page shows a "SECURITY" tab.

## Image Setup

In this section, you may configure the video image settings for your camera. A preview of the image will be shown in Live Video.

**Enable Privacy Mask** The Privacy Mask setting allows you to specify up to 3 rectangular areas on the camera's image to be blocked/excluded from recordings and snapshots.

You may click and drag the mouse cursor over the camera image to draw a mask area. Right clicking on the camera image brings up the following menu options:

**Disable All:** Disables all mask areas

**Enable All:** Enables all mask areas

**Reset All:** Clears all mask areas.

**Mirror:** This will mirror the image horizontally.

**Flip:** This will flip the image vertically. When turning Flip on, you may want to consider turning Mirror on as well.

**Power Line:** Select the frequency used by your power lines to avoid interference or distortion.

**White Balance:** Use the drop-down box to change white balance settings to help balance colors for different environments. You can choose from Auto, Outdoor, Indoor, Fluorescent, and Push Hold.

**D-Link**

DCS-2136L // LIVE VIDEO SETUP ADVANCED MAINTENANCE STATUS HELP

**IMAGE SETUP**  
Changes to your IP camera settings are made immediately.

**LIVE VIDEO**

Enable Privacy Mask Setting

04/10/2011 11:04:37  
DCS-2136L

**IMAGE SETTINGS**

Mirror  On  Off

Flip  On  Off

Power Line  60 Hz  50 Hz

White Balance

Exposure Mode  Max Gain  dB

Denoise

Brightness

Contrast

Saturation

Sharpness

WDR Level

3D filter

**Helpful Hints...**

**Privacy Mask:** Click the attached box to activate this function. Now use your mouse to draw a rectangle covering the area you want hidden. Click the box again to deactivate the function.

**Mirror:** This function horizontally reverses your images 180 degrees.

**Flip:** This function vertically reverses your images 180 degrees.

**Power Line:** This setting is used to remove 50/60 Hz flicker.

**White Balance:** White Balance - Is the process of removing unrealistic color casts so that objects which appear white in person are rendered white in your photo.

**Exposure Mode:** Exposure is the total amount of light allowed to fall on the image sensor during the process of capturing an image. You may choose different scene modes to produce the better images.

**Max Gain:** It can always be enabled automatically. But you have an option - you can change Max Gain either automatically or manually.

**Denoise:** It is the process of removing noise from a signal.

**Brightness:** It is used to

**Exposure Mode:** Changes the exposure mode. Use the drop-down box to set the camera for Indoor, Outdoor, or Night environments, or to Moving to capture moving objects. The Low Noise option will focus on creating a high-quality picture without noise. You can also create 3 different custom exposure modes. The Max Gain setting will allow you to control the maximum amount of gain to apply to brighten the picture.

**Denoise:** This setting controls the amount of noise reduction that will be applied to the picture.

**Brightness:** Adjust this setting to compensate for backlit subjects.

**Contrast:** Adjust this setting to alter the color intensity/strength.

**Saturation:** This setting controls the amount of coloration, from grayscale to fully saturated.

**Sharpness:** Specify a value from 0 to 8 to specify how much sharpening to apply to the image.

**WDR Level:** The WDR function is especially effective in environment with extreme contrast such as lobby entrances, parking lots, ATMs, and loading areas. A higher WDR setting will help in reducing areas with high contrast.

**3D filter:** Setting this option to **Low**, **Medium**, or **High** will help to reduce image artifacts, and result in images with less blur when viewing the camera during the night or in areas where there are low levels of light.

**Reset Default:** Click this button to reset the image to factory default settings.

**D-Link**

DCS-2136L // LIVE VIDEO SETUP ADVANCED MAINTENANCE STATUS HELP

Setup Wizard  
Network Setup  
Wireless Setup  
Dynamic DNS  
Image Setup  
Audio and Video  
Preset  
Motion Detection  
Time and Date  
Event Setup  
SD Card  
Logout

**IMAGE SETUP**  
Changes to your IP camera settings are made immediately.

**LIVE VIDEO**  
 Enable Privacy Mask Setting  
08/19/2011 11:09:37  
DCS-2136L

**IMAGE SETTINGS**

Mirror  On  Off  
Flip  On  Off  
Power Line  60 Hz  50 Hz  
White Balance **Auto**  
Exposure Mode **Indoor** Max Gain **36** dB  
Denoise **0**  
Brightness **128**  
Contrast **128**  
Saturation **128**  
Sharpness **128**  
WDR Level **WDR** **5**  
3D filter **None**

**Helpful Hints..**  
**Privacy Mask:** Click the attached box to activate this function. Now use your mouse to draw a rectangle covering the area you want hidden. Click the box again to deactivate the function.  
**Mirror:** This function horizontally reverses your images 180 degrees.  
**Flip:** This function vertically reverses your images 180 degrees.  
**Power Line:** This setting is used to remove 50/60 Hz flicker.  
**White Balance:** White Balance - Is the process of removing unrealistic color casts, so that objects which appear white in person are rendered white in your photo.  
**Exposure Mode:** Exposure is the total amount of light allowed to fall on the image sensor during the process of capturing an image. You may choose different scene modes to produce the better images.  
**Max Gain:** It can always be enabled automatically. But you have an option - you can change Max Gain either automatically or manually.  
**Denoise:** It is the process of removing noise from a signal.  
**Brightness:** It is used to

## Audio and Video

You may configure up to 3 video profiles with different settings for your camera. Hence, you may set up different profiles for your computer and mobile display. In addition, you may also configure the two-way audio settings for your camera. After making any changes, click the **Save Settings** button to save your changes.

**Number of active profiles:** You can use the drop-down box to set up to 2 active profiles.

**Aspect ratio:** Set the aspect ratio of the video to 4:3 standard or 16:9 widescreen.

**Mode:** Set the video codec to be used to JPEG, MPEG-4, or H.264.

**Frame size / View window area:** Frame size determines the total capture resolution, and View window area determines the Live Video viewing window size. If the Frame size is larger than the Live Video size, you can use the ePTZ controls to look around.

**16:9** 1280 x 720, 800 x 450, 640 x 360, 480 x 270, 320 x 176, 176 x 144

**4:3** 1024 x 768, 800 x 600, 640 x 480, 480 x 360, 320 x 240, 176 x 144

**Note:** If your View window area is the same as your Frame size, you will not be able to use the ePTZ function.

**D-Link**

DCS-2136L // LIVE VIDEO SETUP ADVANCED MAINTENANCE STATUS HELP

**Setup Wizard**  
 Network Setup  
 Wireless Setup  
 Dynamic DNS  
 Image Setup  
**Audio and Video**  
 Preset  
 Motion Detection  
 Time and Date  
 Event Setup  
 SD Card  
 Logout

**AUDIO AND VIDEO**  
 This section allows you to configure the sound and video of your camera. You can configure different settings depending on whether you are viewing content from a PC or a Mobile Phone / PDA.  
 Save Settings Don't Save Settings

**VIDEO SETTINGS**  
 Aspect ratio: 16:9 **Warning: Change the aspect ratio will clear the settings of privacy mask and preset and motion detection.**  
 Save Default

**VIDEO PROFILE 1**  
 Mode: H.264  
 Frame size: 640x360  
 View window area: 640x360  
 Maximum frame rate: 30  
 Video quality: Excellent  
 Constant bit rate: 1M  
 Fixed quality: Excellent

**VIDEO PROFILE 2**  
 Mode: JPEG  
 Frame size: 640x360  
 View window area: 640x360  
 Maximum frame rate: 30  
 Video quality: Excellent

**VIDEO PROFILE 3**  
 Mode: H.264  
 Frame size: 320x176  
 View window area: 320x176  
 Maximum frame rate: 30  
 Video quality: Excellent  
 Constant bit rate: 512K  
 Fixed quality: Excellent

**AUDIO SETTINGS**  
 Encoding: 6.711  
 Audio in off:   
 Audio in gain level: 20dB  
 Audio out off:   
 Audio out volume level: 10  
 Save Settings Don't Save Settings

**Helpful Hints...**  
 Higher frame size, frame rate and bit rate gives better video quality. At the same time, it requires more network bandwidth.  
 For best viewing results on a mobile phone, we suggest setting the Frame Rate to 5fps and the Bit Rate to 64 kbps.  
**Aspect Ratio:** An aspect ratio is the ratio between the width and height of an image.  
**Mode:** It can be H.264, JPEG, or MPEG4. In JPEG mode, the video frames are independent; MPEG4 consumes much less network bandwidth than JPEG, and H.264 can use less bandwidth but better image quality.  
**Frame Size:** 6 options exist for the sizes of the video display. It is recommended using 176x144 for mobile viewing and 1280x720 for computer viewing.  
**View window area:** The viewing region of the current video stream.  
**Max frame rate:** The maximum number of frames that is displayed in 1 second. 30fps is the highest video quality for this camera. In general, any frame rate above 15 fps is imperceptible to the human eye.  
**Video Quality:** This limits the maximal refresh frame rate, which can be combined with the "Fixed quality" to optimize the bandwidth utilization and video quality. If the User wants to fix the bandwidth utilization regardless of the video quality, choose "Constant bit rate" and select the desired bandwidth.  
**Audio Settings:** You can use the option to switch the external microphone on/off or adjust the volume.

**SECURITY**

**Maximum frame rate:** A higher frame rate provides smoother motion for videos, and requires more bandwidth. Lower frame rates will result in stuttering motion, and requires less bandwidth.

**Video Quality:** This limits the maximum frame rate, which can be combined with the "Fixed quality" option to optimize the bandwidth utilization and video quality. If fixed bandwidth utilization is desired regardless of the video quality, choose "Constant bit rate" and select the desired bandwidth.

**Constant bit rate:** The bps will affect the bit rate of the video recorded by the camera. Higher bit rates result in higher video quality.

**Fixed quality:** Select the image quality level for the camera to try to maintain. High quality levels will result in increased bit rates.

**Audio in off:** Selecting this checkbox will mute incoming audio.

**Audio in gain level:** This setting controls the amount of gain applied to incoming audio to increase its volume.

**Audio out off:** Selecting this checkbox will mute outgoing audio.

**Audio out volume level:** This setting controls the amount of gain applied to outgoing audio to increase its volume.

The screenshot shows the D-Link DCS-2136L web interface. The top navigation bar includes 'LIVE VIDEO', 'SETUP', 'ADVANCED', 'MAINTENANCE', 'STATUS', and 'HELP'. The left sidebar lists various setup options: Setup Wizard, Network Setup, Wireless Setup, Dynamic DNS, Image Setup, Audio and Video (selected), Preset, Motion Detection, Time and Date, Event Setup, SD Card, and Logout.

The main content area is titled 'AUDIO AND VIDEO' and contains the following sections:

- Helpful Hints..**: Higher frame size, frame rate and bit rate gives better video quality. At the same time, it requires more network bandwidth. For best viewing results on a mobile phone, we suggest setting the Frame Rate to 5fps and the Bit Rate to 64 kbps. **Aspect Ratio:** An aspect ratio is the ratio between the width and height of an image. **Mode:** It can be H.264, JPEG, or MPEG4. In JPEG mode, the video frames are independent; MPEG4 consumes much less network bandwidth than JPEG, and H.264 can use less bandwidth but better image quality. **Frame Size:** 6 options exist for the sizes of the video display. It is recommended using 176x144 for mobile viewing and 1280x720 for computer viewing. **View window area:** The viewing region of the current video stream. **Max frame rate:** The maximum number of frames that is displayed in 1 second. 30fps is the highest video quality for this camera. In general, any frame rate above 15 fps is imperceptible to the human eye. **Video Quality:** This limits the maximal refresh frame rate, which can be combined with the "Fixed quality" to optimize the bandwidth utilization and video quality. If the User wants to fix the bandwidth utilization regardless of the video quality, choose "Constant bit rate" and select the desired bandwidth. **Audio Settings:** You can use the option to switch the external microphone on/off or adjust the volume.
- Save Settings** and **Don't Save Settings** buttons.
- VIDEO SETTINGS**: Aspect ratio is set to 16:9. A warning states: "Warning: Change the aspect ratio will clear the settings of privacy mask and preset and motion detection." Buttons for **Save** and **Default** are present.
- VIDEO PROFILE 1**: Mode is H.264, Frame size is 640x360, View window area is 640x360, Maximum frame rate is 30, Video quality is Excellent (selected). Options for Constant bit rate (1M) and Fixed quality (Excellent) are shown.
- VIDEO PROFILE 2**: Mode is JPEG, Frame size is 640x360, View window area is 640x360, Maximum frame rate is 30, Video quality is Excellent.
- VIDEO PROFILE 3**: Mode is H.264, Frame size is 320x176, View window area is 320x176, Maximum frame rate is 30, Video quality is Excellent (selected). Options for Constant bit rate (512K) and Fixed quality (Excellent) are shown.
- AUDIO SETTINGS**: Encoding is G.711, Audio in off is unchecked, Audio in gain level is 20dB, Audio out off is unchecked, and Audio out volume level is 10. **Save Settings** and **Don't Save Settings** buttons are at the bottom.

The bottom of the page features a 'SECURITY' section.

## Preset

This screen allows you to set preset points for the ePTZ function of the camera, which allows you to look around the camera's viewable area by using a zoomed view. Presets allow you to quickly go to and view a specific part of the area your camera is covering, and you can create preset sequences, which will automatically change the camera's view between the different presets according to a defined order and timing you can set.

**Note:** If your View window area is the same as your Frame size, you will not be able to use the ePTZ function.

**Video Profile:** This selects which video profile to use.

**ePTZ Speed:** You may select a value between 0 and 64. 0 is the slowest and 64 is the fastest.

**Arrow Buttons and Home Button:** Use these buttons to move to a specific part of the viewing area, which you can then set as a preset. Click the Home button to return to the center of the viewing area.

**Input Preset Name:** Enter the name of the preset you want to create, then click the **Add** button to make a new preset. If an existing preset has been selected from the Preset List, you can change its name by typing in a new name, then clicking the **Rename** button.

**Preset List:** Click this drop-down box to see a list of all the presets that have been created. You can select one, then click the **GoTo** button to change the displayed camera view to the preset. Clicking the **Remove** button will delete the currently selected preset.

The screenshot displays the D-Link web interface for the DCS-2136L camera. The top navigation bar includes 'LIVE VIDEO', 'SETUP', 'ADVANCED', 'MAINTENANCE', 'STATUS', and 'HELP'. The 'SETUP' menu is expanded, showing options like Setup Wizard, Network Setup, Wireless Setup, Dynamic DNS, Image Setup, Audio and Video, Preset, Motion Detection, Time and Date, Event Setup, SD Card, and Logout. The 'Preset' option is selected.

The main content area is divided into three sections:

- PRESET CONTROL:** This section provides instructions: "Using the Pan and Tilt controls, move the camera view to the required position. There are provides the tools for creating and saving Preset positions & Preset Sequence." It features a live video feed of an office interior. To the right of the feed are controls for 'VIDEO PROFILE' (set to 1) and 'ePTZ Speed' (set to 5). Below these are directional arrow buttons (Up, Down, Left, Right) and a Home button.
- PRESET:** This section allows for creating and managing presets. It includes an 'Input Preset Name' field with 'Add' and 'Rename' buttons. Below it is a 'Preset List' dropdown menu with 'GoTo' and 'Remove' buttons. A note indicates 'Support(0~9,A~Z,a~z,\*,/,\_)'. The 'Add' button is highlighted.
- PRESET SEQUENCE:** This section is for configuring preset sequences. It shows a 'Preset Name' field with 'Dwell time' selected. There are 'Add', 'Update', and 'Remove' buttons. The 'Dwell time' is currently set to 10 seconds, with a note 'Second(s)[3~30]'. There are also up, down, and delete (trash) buttons.

On the right side of the interface, there is a 'Helpful Hints..' section with the following text:

- Input Preset Name:** Using the Pan, Tilt and Zoom (PTZ) controls, move the camera view to the required position and simply by selecting the preset's name.
- Add:** This camera position is then saved as a preset position in the camera.
- GoTo:** for test the preset the preset position.
- Preset Sequence:** A preset sequence is an automated series of camera movements from one preset position to another. A guard tour can be set up to display the video streams from different preset positions in a pre-determined order, and for configurable time periods.
- Add:** set up a new preset sequence, Modify to change, and Remove to remove an existing preset sequence.

The bottom of the interface features a 'SECURITY' tab.



**Preset Sequence:** This section allows you to create a preset sequence, which automatically moves the camera's view between a set of preset views.

**Preset List:** To add a preset to the sequence, select it from the drop-down box at the bottom of this window, set the **Dwell time** to determine how long the camera view will stay at that preset, then click the **Add** button. The preset name will appear in the list, followed by the dwell time to view that preset for.

You can rearrange your presets in the sequence by selecting a preset in the sequence, then clicking the arrow buttons to move it higher or lower in the current sequence.

Clicking the trash can button will remove the currently selected preset from the sequence.

If you want to change the dwell time for a preset, select it from the list, enter a new dwell time, then click the **Update** button.



## Motion Detection

Enabling Video Motion will allow your camera to use the motion detection feature. You may draw a finite motion area that will be used for monitoring. After making any changes, click the **Save Settings** button to save your changes.

**Enable Video Motion:** Select this box to enable the motion detection feature of your camera.

**Sensitivity:** Specifies the measurable difference between two sequential images that would indicate motion. Please enter a value between 0 and 100.

**Percentage:** Specifies the amount of motion in the window being monitored that is required to initiate an alert. If this is set to 100%, motion is detected within the whole window will trigger a snapshot.

**Draw Motion Area:** Draw the motion detection area by dragging your mouse in the window (indicated by the red square).

**Erase Motion Area:** To erase a motion detection area, simply click on the red square that you wish to remove.

Right clicking on the camera image brings up the following menu options:

**Select All:** Draws a motion detection area over the entire screen.

**Clear All:** Clears any motion detection areas that have been drawn.

**Restore:** Restores the previously specified motion detection areas.

**D-Link**

DCS-2136L // LIVE VIDEO **SETUP** ADVANCED MAINTENANCE STATUS HELP

**MOTION DETECTION**

In order to use motion detection, you must first check the checkboxes, then draw the areas you want to monitor for motion.

Save Settings Don't Save Settings

**LIVE VIDEO**

Enable Video Motion

Sensitivity 85 0~100%

Percentage 5 0~100%

Save Settings Don't Save Settings

**Helpful Hints..**

**Enable Video Motion:** Select this option to enable motion detection for your camera.

**Sensitivity:** Sets the sensitivity for motion detection. The text field indicate the level of sensitivity for motion detection. As motion is detected the level will rise depending on the frequency of the movement.

**Percentage:** Adjusting the percentage allows you to set a requirement on how much of the motion window must be filled by movement. Example: If you set this to 50%, then the selected window must be half filled by a moving object before it triggers motion detection.

**D-Link**

DCS-2136L // LIVE VIDEO **SETUP** ADVANCED MAINTENANCE STATUS HELP

**MOTION DETECTION**

In order to use motion detection, you must first check the checkboxes, then draw the areas you want to monitor for motion.

Save Settings Don't Save Settings

**LIVE VIDEO**

Enable Video Motion

Sensitivity 85 0~100%

Percentage 5 0~100%

Select all  
Clear all  
Restore

Save Settings Don't Save Settings

**Helpful Hints..**

**Enable Video Motion:** Select this option to enable motion detection for your camera.

**Sensitivity:** Sets the sensitivity for motion detection. The text field indicate the level of sensitivity for motion detection. As motion is detected the level will rise depending on the frequency of the movement.

**Percentage:** Adjusting the percentage allows you to set a requirement on how much of the motion window must be filled by movement. Example: If you set this to 50%, then the selected window must be half filled by a moving object before it triggers motion detection.

## Time and Date

This section allows you to automatically or manually configure, update, and maintain the internal system clock for your camera. After making any changes, click the **Save Settings** button to save your changes.

**Time Zone:** Select your time zone from the drop-down menu.

**Enable Daylight Saving:** Select this to enable Daylight Saving Time.

**Auto Daylight Saving:** Select this option to allow your camera to configure the Daylight Saving settings automatically.

**Set Date and Time Manually:** Selecting this option allows you to configure the Daylight Saving date and time manually.

**Offset:** Sets the amount of time to be added or removed when Daylight Saving is enabled.

**Synchronize with NTP Server:** Enable this feature to obtain time automatically from an NTP server.

**NTP Server:** Network Time Protocol (NTP) synchronizes the DCS-2136L with an Internet time server. Choose the one that is closest to your location.

**Set the Date and Time Manually:** This option allows you to set the time and date manually.

**Copy Your Computer's Time Settings:** This will synchronize the time information from your PC.

**D-Link**

DCS-2136L // LIVE VIDEO SETUP ADVANCED MAINTENANCE STATUS HELP

**TIME AND DATE**  
You can set the current time for the IP camera.  
Save Settings Don't Save Settings

**TIME CONFIGURATION**  
Time Zone (UTC+08:00) Taipei  
 Enable Daylight Saving  
 Auto Daylight Saving  
 Set date and time manually  
Offset: +2:00  
Start time: 5:00 Sunday  
End time: 10:00 Sunday

**AUTOMATIC TIME CONFIGURATION**  
 Synchronize with NTP Server  
NTP Server: ntp.dlink.com.tw

**SET DATE AND TIME MANUALLY**  
 Set date and time manually  
Year: 2013 Month: 4 Day: 19  
Hour: 11 Minute: 14 Second: 22  
Copy Your Computer's Time Settings

Save Settings Don't Save Settings

**Helpful Hints..**  
Good timekeeping is important for accurate logs and scheduled firewall rules.  
**Time Zone:** Select your time zone from the drop-down menu.  
**Enable Daylight Saving:** Select this to enable the daylight saving time.  
**Auto Daylight Saving:** When you select it, the clock is automatically adjusted according to the daylight saving time of the selected time zone.  
**Offset:** Select the time offset, if your location observes daylight saving time.  
**Synchronize with NTP Server:** With the option selected, the camera will synchronize the time settings with the NTP server over the Internet whenever the camera starts up. If the timeserver cannot be reached, no time settings will be applied.  
**NTP Server:** Network Time Protocol (NTP) synchronizes the IP camera with an Internet time server. Choose the one that is closest to your location.  
**Copy Your Computer's Time Settings:** This will synchronize the time information from your PC.

**SECURITY**

## Event Setup

In a typical application, when motion is detected, the DCS-2136L sends images to a FTP server or via e-mail as notifications. As shown in the illustration below, an event can be triggered by many sources, such as motion detection or external digital input devices. When an event is triggered, a specified action will be performed. You can configure the DCS-2136L to send snapshots or videos to your e-mail address or FTP site.

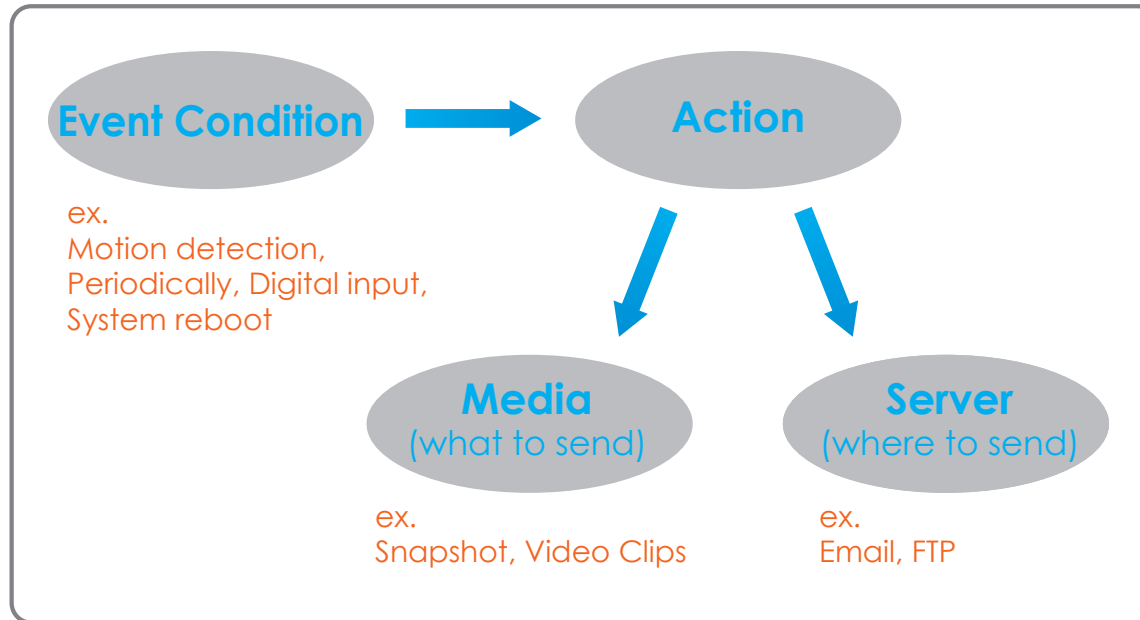

To start plotting an event, it is suggested to configure server and media columns first so that the DCS-2136L will know what action shall be performed when a trigger is activated.

## Section 4: Configuration

The Event Setup page includes 4 different sections.

- Server
- Media
- Event
- Recording

1. To add a new item - "server, media, or event," click **Add**. A screen will appear and allow you to update the fields accordingly.
2. To delete the selected item from the pull-down menu of event, server or media, click **Delete**.
3. Click on the item name to pop up a window for modifying.

**D-Link**

DCS-2136L // LIVE VIDEO SETUP ADVANCED MAINTENANCE STATUS HELP

Setup Wizard  
Network Setup  
Wireless Setup  
Dynamic DNS  
Image Setup  
Audio and Video  
Preset  
Motion Detection  
Time and Date  
Event Setup  
SD Card  
Logout

**EVENT SETUP**

There are four sections in Event Setup page. They are event, server, media and recording. Click Add to pop a window to add a new item of event, server, media or recording. Click Delete to delete the selected item from event, server, media or recording. Click on the item name to pop a window to edit it. There can be at most 2 events and 1 recording. There can be at most 5 server and 5 media configurations.

**SERVER**

Name	Type	Address/Location
<input type="button" value="Add"/>	<input type="button" value="Delete"/>	

**MEDIA**

Name	Type	Source
<input type="button" value="Add"/>	<input type="button" value="Delete"/>	

**EVENT**

Name	Status	Sun	Mon	Tue	Wed	Thu	Fri	Sat	Time	Trigger
<input type="button" value="Add"/>	<input type="button" value="Delete"/>									

**RECORDING**

Name	Status	Sun	Mon	Tue	Wed	Thu	Fri	Sat	Time	Source	Destination
<input type="button" value="Add"/>	<input type="button" value="Delete"/>										

**Helpful Hints..**

Suggest setting server and media first before setting event. The servers and media which selected in event list are not be able to modify or delete. Please remove them first from the event if you want to delete or modify them. Recommend using different media in different event to make use all media be produced and received correctly. If using the same media in different events and the events trigger almost simultaneously, the servers in the second triggered event will not receive any media; there would be only notifications.

**SECURITY**

## Add Server

You can configure up to 5 servers to save snapshots and/or video to. After making any changes, click the **Save Settings** button to save your changes.

**Server Name:** Enter the unique name of your server.

**E-mail:** Enter the configuration for the target e-mail server account.

**FTP:** Enter the configuration for the target FTP server account.

**Network Storage:** Specify a network storage device. Only one network storage device is supported.

**SD Card:** Use the camera's onboard SD card storage.

**SERVER**

You can set at most 5 different servers here for different event.

Test Save Settings Don't Save Settings

**SERVER TYPE**

Server Name:

**Email**

Sender email address

Recipient email address

Server address

User name

Password

Port

This server requires a secure connection (StartTLS)

**FTP**

Server address

Port

User name

Password

Remote folder name

Passive mode

**Network storage**

Network storage location   
(for example: \\my\_nas\disk\folder)

Workgroup

User name

Password

Primary WINS server

**SD Card**

Test Save Settings Don't Save Settings

## Add Media

There are three types of media, **Snapshot**, **Video Clip**, and **System Log**. After making any changes, click the **Save Settings** button to save your changes.

**Media Name:** Enter a unique name for media type you want to create.

**Snapshot:** Select this option to set the media type to snapshots.

**Source:** Set the video profile to use as the media source. Refer to **Audio and Video** on "Audio and Video" on page 38 for more information on video profiles.

**Send pre-event image(s) [0~4]:** Set the number of pre-event images to take. Pre-event images are images taken before the main event snapshot is taken.

**Send post-event image(s) [0~7]:** Set the number of post-event images to take. Post-event images are images taken after the main event snapshot is taken. You can set up to 7 post-event images to be taken.

**File name prefix:** The prefix name will be added on the file name.

**Add date and time suffix to file name:** Check it to add timing information as file name suffix.

**MEDIA**

You can set at most 5 different media here for different event.
 

Save Settings
Don't Save Settings

**MEDIA TYPE**

Media name:

Snapshot

Source:

Send  pre-event image(s) [0~4]

Send  post-event image(s) [0~7]

File Name Prefix:

Add date and time suffix to file name

Video Clip

Source:

Pre-event recording:  Second(s) [0~4]

Maximum duration:  Second(s) [1~100]

Maximum file size:  Kbytes [100~5000]

File Name Prefix:

System log

Save Settings
Don't Save Settings

**Video clip:** Select this option to set the media type to video clips.

**Source:** Set the video profile to use as the media source. Refer to "Audio and Video" on page 51 for more information on video profiles.

**Pre-event recording:** This sets how many seconds to record before the main event video clip starts. You can record up to 4 seconds of pre-event video.

**Maximum duration:** Set the maximum length of video to record for your video clips.

**Maximum file size:** Set the maximum file size to record for your video clips.

**File name prefix:** This is the prefix that will be added to the filename of saved video clips.

**System log:** Select this option to set the media type to system logs. This will save the event to the camera system log, but will not record any snapshots or video.

**MEDIA**

You can set at most 5 different media here for different event.

Save Settings Don't Save Settings

**MEDIA TYPE**

Media name:

Snapshot

Source: Profile 1 ▾

Send  pre-event image(s) [0~4]

Send  post-event image(s) [0~7]

File Name Prefix:

Add date and time suffix to file name

Video Clip

Source: Profile 1 ▾

Pre-event recording:  Second(s) [0~4]

Maximum duration:  Second(s) [1~100]

Maximum file size:  Kbytes [100~5000]

File Name Prefix:

System log

Save Settings Don't Save Settings



## Add Event

Create and schedule up to 2 events with their own settings here. After making any changes, click the **Save Settings** button to save your changes.

**Event name:** Enter a name for the event.

**Enable this event:** Select this box to activate this event.

**Priority:** Set the priority for this event. The event with higher priority will be executed first.

**Delay:** Select the delay time before checking the next event. It is being used for both events of motion detection and digital input trigger.

**Trigger:** Specify the input type that triggers the event.

**Video Motion Detection:** Motion is detected during live video monitoring. Select the windows that need to be monitored.

**Periodic:** The event is triggered in specified intervals. The trigger interval unit is in minutes.

**Digital input:** The external trigger input to the camera.

**System Boot:** Triggers an event when the system boots up.

**Network Lost:** Triggers an event when the network connection is lost.

**Passive Infrared Sensor:** Triggers an event when the PIR sensor is activated by moving infrared objects even in dark environment.

**EVENT**

You can set at most 2 events like motion detection or digital input trigger here and arrange the detection schedule at the same time.

**EVENT**

**Event name:**

Enable this event

Priority: normal

Delay for  seconds before detecting next event [For motion detection and digital input and Passive Infrared sensor]

**TRIGGER**

Video motion detection

Periodic  
Trigger every  minutes

Digital input

System boot

Network lost

Passive Infrared sensor

**Time:** Select **Always** or enter the time interval.

**Trigger D/O:** Select to trigger the digital output for a specific number of seconds when an event occurs.

**Trigger white light LED** Select to trigger the white light LED only during an event or for a specific duration of time when an event occurs.

### EVENT SCHEDULE

Sun  Mon  Tue  Wed  Thu  Fri  Sat

**Time**

Always

From   To

### ACTION

Trigger D/O for  seconds

Trigger White light LED

Keep active during event

Keep active for  seconds

Active :  Inactive :

## Add Recording

Here you can configure and schedule the recording settings. After making any changes, click the **Save Settings** button to save your changes.

**Recording entry name:** The unique name of the entry.

**Enable this recording:** Select this to enable the recording function.

**Priority:** Set the priority for this entry. The entry with a higher priority value will be executed first.

**Source:** The source of the stream.

**Recording schedule:** Scheduling the recording entry.

**Recording settings:** Configuring the setting for the recording.

**Destination:** Select the folder where the recording file will be stored.

**Total cycling recording size:** Input a value between 1MB and 2TB for recording space. New recordings will replace the oldest recording when the total recording size exceeds this value.

**Size of each file for recording:** If this is selected, files will be separated based on the file size you specify.

**Time of each file for recording:** If this is selected, files will be separated based on the maximum length you specify.

**File Name Prefix:** The prefix name will be added on the file name of the recording file(s).

**RECORDING**

You can setup schedule recording to network storage with your specify week day and time period.

---

**RECORDING**

**Recording entry name:**

Enable this recording

Priority:

Source:

---

**RECORDING SCHEDULE**

Sun  Mon  Tue  Wed  Thu  Fri  Sat

**Time**

Always

From   To

---

**RECORDING SETTINGS**

**Destination:**

Total cycling recording size:  Mbytes [200~2000000]

Size of each file for recording:  Mbytes

Time of each file for recording:  seconds

File Name Prefix:

## SD Card

Here you may browse and manage the recorded files which are stored on the SD card.

**Format SD Card:** Click this icon to automatically format the SD card and create "picture" & "video" folders.

**View Recorded Picture:** If the picture files are stored on the SD card, click on the picture folder and choose the picture file you would like to view.

**Playback Recorded Video:** If video files are stored on the SD card, click on the video folder and choose the video file you would like to view.

**Refresh:** Reloads the file and folder information from the SD card.

The screenshot shows the D-Link web interface for the DCS-2136L camera. The main content area is titled "SD CARD" and contains the following information:

SD Card: / SD Status: Ready

Files per Page: 10 Refresh 1 of 1

Delete	File	Num of files	Size
<input type="checkbox"/>	<a href="#">Picture</a>	8	
<input type="checkbox"/>	<a href="#">Video</a>	1	

Format SD Card Total:119247KB, Used:31848KB, Free:87399KB

OK

The sidebar on the right contains "Helpful Hints..":

- Format SD Card:** Click this icon, system will automatically format SD card and create "picture" & "video" folders.
- View recorded picture:** If SD stored recorded picture files, enter picture link and choose which picture file you desire to view. You will view picture via image viewer SW. (e. Windows Image Viewer)
- Playback recorded video:** If SD stored recorded video files, enter video link and choose which video file you desire to playback. Windows will guide you to open/download video file (AVI format) so that you can playback file via video decoder SW (e. Windows Media Player)

## Advanced Digital Input/Output

This screen allows you to control the behavior of digital input and digital output devices. The I/O connector provides the physical interface for digital output (DO) and digital input (DI) that is used for connecting a variety of external alarm devices such as IR-Sensors and alarm relays. The digital input is used for connecting external alarm devices and once triggered images will be taken and e-mailed. After making any changes, click the **Save Settings** button to save your changes.

**Select D/I or D/O Mode:** The camera will send a signal when an event is triggered, depending upon the type of device connected to the DI circuit.

N.C. stands for **Normally Closed**. This means that the normal state of the circuit is closed. Therefore events are triggered when the device status changes to "Open."

N.O. stands for **Normally Open**. This means that the normal state of the circuit is open. Therefore events are triggered when the device status changes to "Closed."

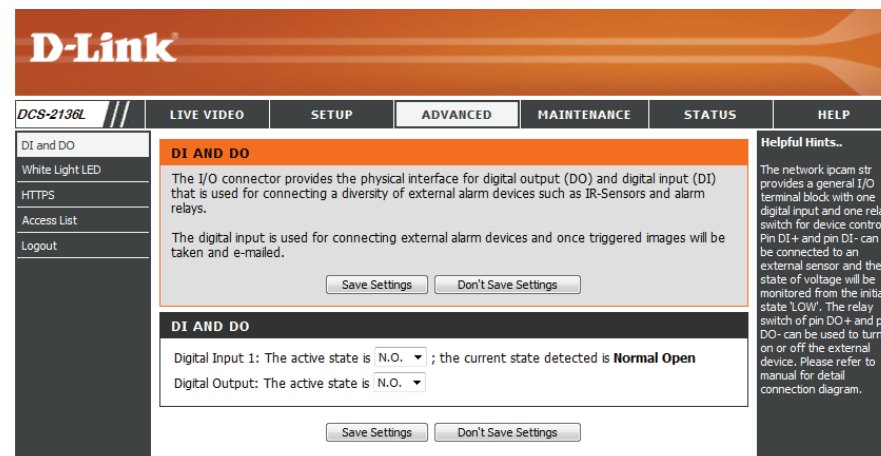

## White LED Light

Here you can configure the white light LED settings. The settings on this page will control how the light button on the live view page will appear. It will also set up how the white light LED functions when used with event triggers.

**Light:** The camera can enable or disable the white LED light according to your preferences. This setting provides additional controls depending on your selection. The options are **None**, **Pulse**, **Active**, and **Slider**.

**None:** If the white light LED option is set to none, the camera PIR sensor or any other external triggers will not activate the white light LED.

**Pulse:** Select **Pulse** to activate the built-in light for a defined period of time, for example 20 seconds. You can set how the white light functions by selecting an action for when the white light LED becomes active and goes inactive.

**Active:** Select Active to have the white light LED activated on a predefined event, or by enabling via button on the live view page. You can set how the white light functions by selecting an action for when the white light LED becomes active and goes inactive.

**Slider:** Selecting this option will enable a slider on the live view page. The slider will allow you to control the brightness of the built-in light, sliding it left to dim and sliding it right to brighten.

**Auto:** Selecting this option will enable the white LED to automatically come on when it senses a the surrounding light levels have reached a certain threshold.

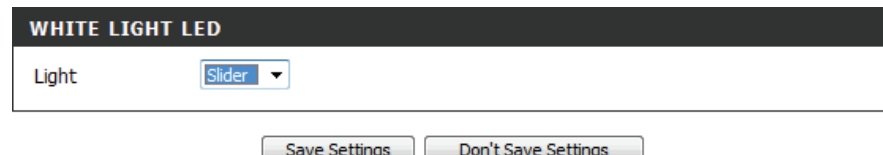
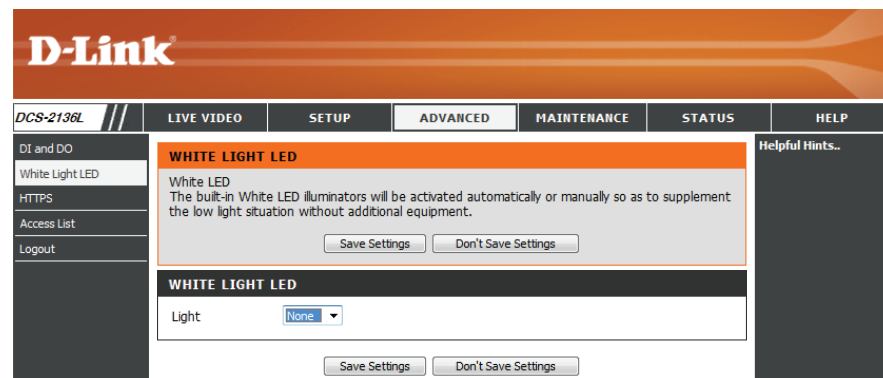

# HTTPS

This page allows you to install and activate an HTTPS certificate for secure access to your camera. After making any changes, click the **Save Settings** button to save your changes.

**Enable HTTPS Secure Connection:** Enable the HTTPS service.

**Create Certificate Method:** Choose the way the certificate should be created. Three options are available:

- Create a self-signed certificate automatically
- Create a self-signed certificate manually
- Create a certificate request and install

**Status:** Displays the status of the certificate.

**Note:** The certificate cannot be removed while the HTTPS is still enabled. To remove the certificate, you must first uncheck **Enable HTTPS secure connection**.

The screenshot shows the D-Link web interface for the DCS-2136L camera. The main navigation bar includes LIVE VIDEO, SETUP, ADVANCED, MAINTENANCE, STATUS, and HELP. The left sidebar lists menu items: DI and DO, White Light LED, HTTPS, Access List, and Logout. The main content area is titled 'HTTPS' and contains the following sections:

- HTTPS:** A message stating "To enable HTTPS, you have to create and install certificate first." with "Save Settings" and "Don't Save Settings" buttons.
- HTTPS:** A section with a checked checkbox "Enable HTTPS secure connection". Below it, the "Create certificate method" section has three radio button options: "Create self-signed certificate automatically" (selected), "Create self-signed certificate manually", and "Create certificate request and install". The "Create certificate:" field shows "Create" and "Private key existed" in red.
- CERTIFICATE INFORMATION:** A table showing certificate details:
 

Status	Active
Country	TW
State or province	Taiwan
Locality	Taipei
Organization	D-Link Taiwan
Organization Unit	R&D Dept.
Common Name	www.dlink.com.tw

 Below the table are buttons for "CSR Property", "Certificate Property", and "Remove".

At the bottom of the main content area are "Save Settings" and "Don't Save Settings" buttons. A "Helpful Hints.." sidebar on the right contains a note: "Enable HTTPS secure connection: allows you to enable HTTPS service. Note: 1. The certificate can't be removed while the HTTPS is still enable. To remove the certificate you have to uncheck the 'Enable HTTPS secure connection' first."

## Access List

Here you can set access permissions for users to view your DCS-2136L.

**Allow list:** The list of IP addresses that have the access right to the camera.

**Start IP address:** The starting IP Address of the devices (such as a computer) that have permission to access the video of the camera. Click **Add** to save the changes made.

**Note:** A total of seven lists can be configured for both columns.

**End IP address:** The ending IP Address of the devices (such as a computer) that have permission to access the video of the camera.

**Delete allow list:** Remove the customized setting from the Allow List.

**Deny list:** The list of IP addresses that have no access rights to the camera.

**Delete deny list:** Remove the customized setting from the Delete List.

**For example:**

When the range of the Allowed List is set from 1.1.1.0 to 192.255.255.255 and the range of the Denied List is set from 1.1.1.0 to 170.255.255.255. Only users with IPs located between 171.0.0.0 and 192.255.255.255 can access the DCS-2136L.

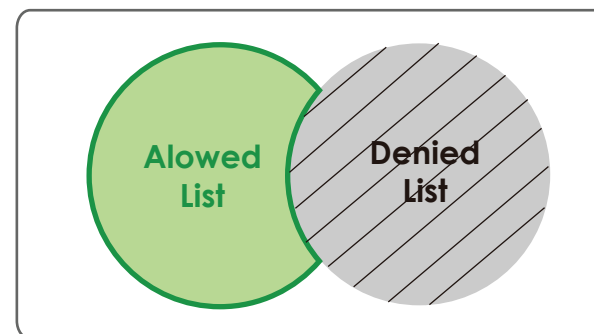



# Maintenance

## Device Management

You may modify the name and administrator's password of your camera, as well as add and manage the user accounts for accessing the camera. You may also use this section to create a unique name and configure the OSD settings for your camera.

**Admin Password Setting:** Set a new password for the administrator's account.

**Add User Account:** Add new user account.

**User Name:** The user name for the new account.

**Password:** The password for the new account.

**User List:** All the existing user accounts will be displayed here.

**Camera Name:** Create a unique name for your camera that will be added to the file name prefix when creating a snapshot or a video clip.

**Enable OSD:** Select this option to enable the On-Screen Display feature for your camera.

**Label:** Enter a label for the camera, which will be shown on the OSD when it is enabled.

**Show Time:** Select this option to enable the time-stamp display on the video screen.

**LED:** You may specify whether or not to illuminate the status LED on the camera.

The screenshot shows the D-Link web interface for the DCS-2136L camera. The 'MAINTENANCE' tab is selected. The interface is divided into several sections:

- ADMIN:** A section for managing the administrator account, including a description of the password change and user management options.
- ADMIN PASSWORD SETTING:** Fields for 'New Password' (63 characters maximum) and 'Retype Password' with a 'Save' button.
- ADD USER ACCOUNT:** Fields for 'User Name' (20 users maximum), 'New Password' (63 characters maximum), and 'Retype Password' with an 'Add' button.
- USER LIST:** A table with a 'User Name' column and a 'Delete' button.
- DEVICE SETTING:** Fields for 'IP camera Name' (63 characters maximum), 'Label' (30 characters maximum), and a 'Show time' checkbox. A 'Save' button is present.
- LED:** A section with radio buttons for 'On' and 'Off' and a 'Save' button.

On the right side, there are 'Helpful Hints..' and 'LED:' sections providing additional information and instructions.

## System

In this section, you may backup, restore and reset the camera configuration, or reboot the camera.

**Save To Local Hard Drive:** You may save your current camera configuration as a file on your computer.

**Load From Local Hard Drive:** Locate a pre-saved configuration by clicking **Browse** and then restore the pre-defined settings to your camera by clicking **Load Configuration**.

**Restore to Factory Defaults:** You may reset your camera and restore the factory settings by clicking **Restore Factory Defaults**.

**Reboot Device:** This will restart your camera.

The screenshot displays the D-Link web interface for the DCS-2136L camera. The top navigation bar includes 'LIVE VIDEO', 'SETUP', 'ADVANCED', 'MAINTENANCE', 'STATUS', and 'HELP'. The 'SYSTEM' page is active, showing options to 'Save To Local Hard Drive', 'Load From Local Hard Drive', 'Restore To Factory Defaults', and 'Reboot Device'. A 'Helpful Hints...' section on the right provides instructions for restoring factory settings. The bottom of the page features a 'SECURITY' section.

DCS-2136L	LIVE VIDEO	SETUP	ADVANCED	MAINTENANCE	STATUS	HELP
Admin	<b>SYSTEM</b> Here you may backup, restore, and reboot your IP camera.					Helpful Hints.. After the factory's default settings have been restored, use the installation wizard software provided with your IP camera to search and connect to the IP camera.
System	<b>SYSTEM</b>					
Firmware Upgrade	Save To Local Hard Drive	<input type="button" value="Save Configuration"/>				
Logout	Load From Local Hard Drive	<input type="text"/>	<input type="button" value="Browse..."/>	<input type="button" value="Load Configuration"/>		
	Restore To Factory Defaults	<input type="button" value="Restore Factory Defaults"/>				
	Reboot Device	<input type="button" value="Reboot Device"/>				

## Firmware Upgrade

The camera's current firmware version will be displayed on this screen. You may visit the D-Link Support Website to check for the latest available firmware version.

To upgrade the firmware on your DCS-2136L, please download and save the latest firmware version from the D-Link Support Page to your local hard drive. Locate the file on your local hard drive by clicking the **Browse** button. Select the file and click the **Upload** button to start upgrading the firmware.

**Current Firmware Version:** Displays the detected firmware version.

**Current Product Name:** Displays the camera model name.

**File Path:** Locate the file (upgraded firmware) on your hard drive by clicking **Browse**.

**Upload:** Uploads the new firmware to your camera.

The screenshot shows the D-Link web interface for the DCS-2136L camera. The top navigation bar includes 'LIVE VIDEO', 'SETUP', 'ADVANCED', 'MAINTENANCE', 'STATUS', and 'HELP'. The left sidebar has 'Admin', 'System', 'Firmware Upgrade', and 'Logout' options. The main content area is titled 'FIRMWARE UPGRADE' and contains the following text:

**FIRMWARE UPGRADE**

A new firmware upgrade may be available for your IP camera. It is recommended to keep your IP camera firmware up-to-date to maintain and improve the functionality and performance of your internet IP camera. Click here [D-Link Support Page](#) to check for the latest firmware version available.

To upgrade the firmware on your IP camera, please download and save the latest firmware version from the D-Link Support Page to your local hard drive. Locate the file on your local hard drive by clicking the Browse button. Once you have found and opened the file using the browse button, click the "Upload" button to start the firmware upgrade.

**FIRMWARE INFORMATION**

Current Firmware Version: 0.01.04  
Current Product Name: DCS-2136L

**FIRMWARE UPGRADE**

File Path:

**Helpful Hints..**

Firmware upgrade are released periodically to improve the functionality of your IP camera and also to add new features. If you run into a problem with a specific feature of the IP camera, check our support site by clicking [here](#) to check for an upgrade and see if updated firmware is available for your IP camera.

At the bottom of the page, there is a 'SECURITY' section.

# Status

## Device Info

This page displays detailed information about your device and network connection.

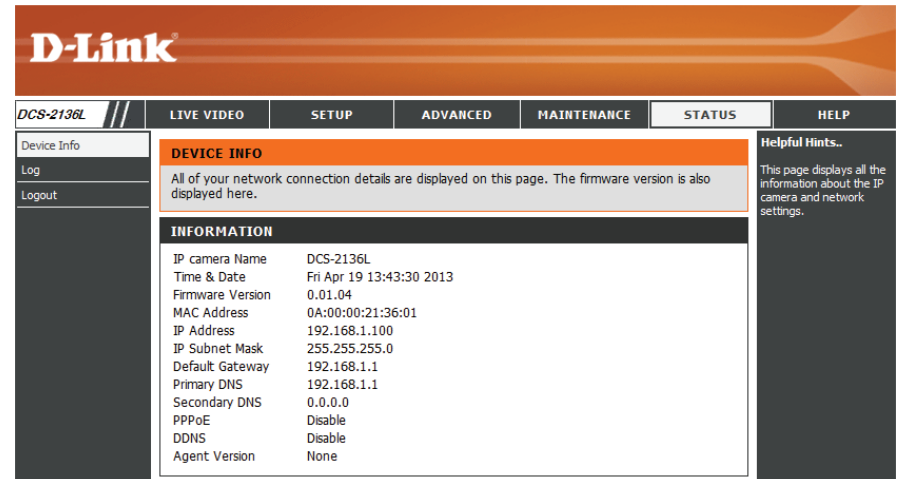

**D-Link**

DCS-2136L // LIVE VIDEO SETUP ADVANCED MAINTENANCE **STATUS** HELP

Device Info Log Logout

**DEVICE INFO**

All of your network connection details are displayed on this page. The firmware version is also displayed here.

**INFORMATION**

IP camera Name	DCS-2136L
Time & Date	Fri Apr 19 13:43:30 2013
Firmware Version	0.01.04
MAC Address	0A:00:00:21:36:01
IP Address	192.168.1.100
IP Subnet Mask	255.255.255.0
Default Gateway	192.168.1.1
Primary DNS	192.168.1.1
Secondary DNS	0.0.0.0
PPPoE	Disable
DDNS	Disable
Agent Version	None

**Helpful Hints..**

This page displays all the information about the IP camera and network settings.

## Logs

This page displays the log information of your camera. You may download the information by clicking **Download**. You may also click **Clear** to delete the saved log information.

The screenshot shows the D-Link web interface for the DCS-2136L camera. The top navigation bar includes tabs for LIVE VIDEO, SETUP, ADVANCED, MAINTENANCE, STATUS, and HELP. The left sidebar contains links for Device Info, Log, and Logout. The main content area is titled 'SYSTEM LOG' and contains a description: 'The system log records IP camera events that have occurred.' Below this is a 'CURRENT LOG' section with a list of 20 log entries. At the bottom of the log list are buttons for 'First Page', 'Previous 20', 'Next 20', 'Clear', and 'Download'. A 'Helpful Hints..' sidebar on the right explains that users can save the log to their local hard IP camera by clicking the Download button and can clear the log by clicking the Clear button.

DCS-2136L	LIVE VIDEO	SETUP	ADVANCED	MAINTENANCE	STATUS	HELP
Device Info	<b>SYSTEM LOG</b>					Helpful Hints..
Log	The system log records IP camera events that have occurred.					You can save the log to your local hard IP camera by clicking the Download button, and you can clear the log by clicking on the Clear button.
Logout	<b>CURRENT LOG</b>					
	<ol style="list-style-type: none"> <li>1. 2013-04-19 13:42:44 admin LOGIN OK FROM 192.168.1.2</li> <li>2. 2013-04-19 11:04:08 admin LOGIN OK FROM 192.168.1.2</li> <li>3. 2013-04-18 16:18:24 admin FROM 192.168.1.2 SET VIDEO CODEC Need Reset</li> <li>4. 2013-04-18 16:18:24 admin FROM 192.168.1.2 SET PROFILE 1 Viewer window area 640x360</li> <li>5. 2013-04-18 16:18:24 admin FROM 192.168.1.2 SET PROFILE 1 Frame Size 640x360</li> <li>6. 2013-04-18 16:17:30 admin LOGIN OK FROM 192.168.1.2</li> <li>7. 2013-04-18 15:38:06 IP CAMERA ACQUIRE DHCP IP 192.168.1.100</li> <li>8. 2013-04-18 15:38:04 NETWORK RECONNECT</li> <li>9. 2013-04-18 14:32:44 NETWORK LOSS</li> <li>10. 2013-04-15 17:02:29 IP CAMERA ACQUIRE DHCP IP 192.168.1.100</li> <li>11. 2013-04-15 17:02:27 SYSTEM SET IR LIGHT OFF</li> <li>12. 2013-04-15 17:02:25 SYSTEM BOOTING</li> <li>13. 2013-04-15 14:07:04 IP CAMERA ACQUIRE DHCP IP 192.168.1.100</li> <li>14. 2013-04-15 14:07:00 NETWORK RECONNECT</li> <li>15. 2013-04-15 14:06:59 SYSTEM SET IR LIGHT OFF</li> <li>16. 2013-04-15 14:06:59 NETWORK LOSS</li> <li>17. 2013-04-15 14:06:58 SYSTEM BOOTING</li> <li>18. 2013-04-15 13:55:57 NETWORK LOSS</li> <li>19. 2013-04-14 21:53:52 IP CAMERA ACQUIRE DHCP IP 192.168.1.100</li> <li>20. 2013-04-14 21:53:35 NETWORK RECONNECT</li> </ol>					
	<input type="button" value="First Page"/> <input type="button" value="Previous 20"/> <input type="button" value="Next 20"/>					
	<input type="button" value="Clear"/> <input type="button" value="Download"/>					

# Help

This page provides helpful information regarding camera operation.

The screenshot shows the D-Link web interface for the DCS-2136L camera. At the top, there is a navigation bar with the D-Link logo and tabs for LIVE VIDEO, SETUP, ADVANCED, MAINTENANCE, STATUS, and HELP. The HELP tab is selected. On the left side, there is a sidebar with 'Help' and 'Logout' links. The main content area is divided into sections: HELP (with links to LIVE VIDEO, SETUP, MAINTENANCE, ADVANCED, and STATUS), LIVE VIDEO (with a link to Camera), SETUP (with links to Setup Wizard, Network Setup, Wireless Setup, Dynamic DNS, Image Setup, Audio and Video, Preset, Motion Detection, Time and Date, Event Setup, and SD Card), ADVANCED (with links to DI and DO, ICR and White LED, HTTPS, and Access List), MAINTENANCE (with links to Admin, System, and Firmware Upgrade), and STATUS (with links to Device Info and Log). At the bottom of the page, there is a 'SECURITY' section.

# DI/DO Specifications

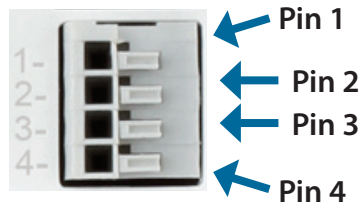

PIN	FUNCTION	NOTE
1	Digital Out (DO)	Uses an open-drain NFET transistor with the source connected to GND in camera. If used with an external relay, a diode must be connected in parallel with the load for protection against voltage transients. Max loading is 100 mA.
2	Digital In (DI)	A switch from DI to DC 5 V, activated by setting NO. or NC.
3	DC5V OUTPUT	DC 5 V Output / Max. 100 mA
4	GND	GND

Internal 5V Power

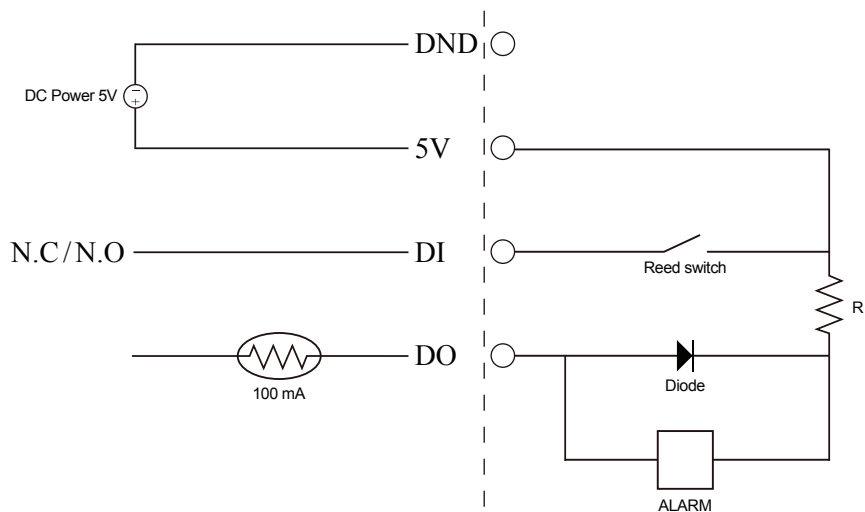

External 3~12V Power

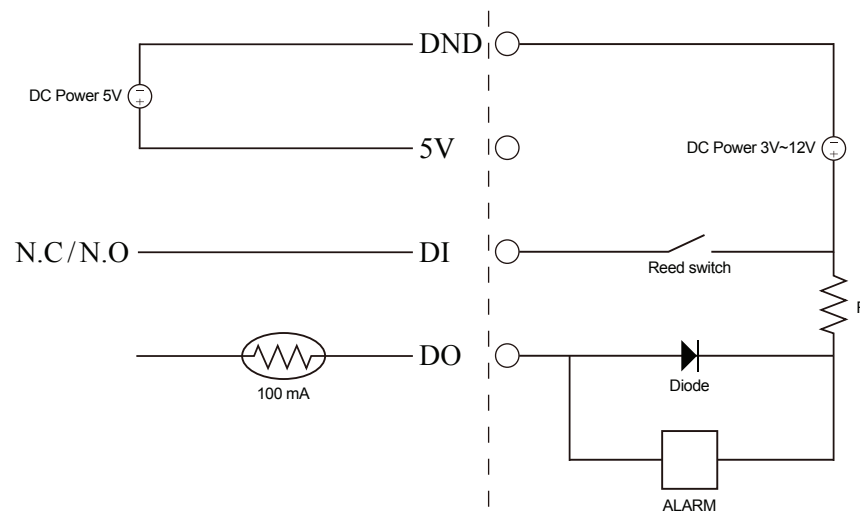

# Technical Specifications

<b>Camera</b>	Camera Hardware Profile	<ul style="list-style-type: none"> <li>▪ 1/3" Megapixel progressive CMOS sensor</li> <li>▪ 5 meter white light illumination distance</li> <li>▪ Minimum illumination: 0 lux with white light LED on</li> <li>▪ Built-in PIR sensor (5 meter)</li> <li>▪ Built-in microphone and speaker</li> <li>▪ 10x digital zoom</li> </ul>	<ul style="list-style-type: none"> <li>▪ Focal length: 3.6 mm</li> <li>▪ Aperture: F1.4</li> <li>▪ Angle of view:               <ul style="list-style-type: none"> <li>▪ (H) 64°</li> <li>▪ (V) 46.5°</li> <li>▪ (D) 92.4°</li> </ul> </li> </ul>
	Image Features	<ul style="list-style-type: none"> <li>▪ Configurable image size, quality, frame rate, and bit rate</li> <li>▪ Time stamp and text overlays</li> <li>▪ Configurable motion detection windows</li> </ul>	<ul style="list-style-type: none"> <li>▪ Configurable privacy mask zones</li> <li>▪ Configurable shutter speed, brightness, saturation, contrast, sharpness, and WDR</li> </ul>
	Video Compression	<ul style="list-style-type: none"> <li>▪ Simultaneous H.264/MPEG-4/MJPEG format compression</li> <li>▪ H.264/MPEG-4 multicast streaming</li> </ul>	<ul style="list-style-type: none"> <li>▪ JPEG for still images</li> </ul>
	Video Resolution	16:9 - 1280 x 720, 800 x 450, 640 x 360, 480 x 270, 320 x 176, 176 x 144 up to 30 fps recording	4:3 - 1024 x 768, 800 x 600, 640 x 480, 480 x 360, 320 x 240, 176 x 144 up to 30 fps recording
	Audio Support	<ul style="list-style-type: none"> <li>▪ G.726</li> </ul>	<ul style="list-style-type: none"> <li>▪ G.711</li> </ul>
	External Device Interface	<ul style="list-style-type: none"> <li>▪ 10/100 BASE-TX Fast Ethernet port</li> <li>▪ IEEE 802.11ac 2.4GHz, 5GHz Dual-Band Wireless</li> </ul>	<ul style="list-style-type: none"> <li>▪ DI/DO port</li> <li>▪ MicroSD/SDHC card slot</li> </ul>
<b>Network</b>	Network Protocols	<ul style="list-style-type: none"> <li>▪ IPv6</li> <li>▪ IPv4</li> <li>▪ TCP/IP</li> <li>▪ UDP</li> <li>▪ ICMP</li> <li>▪ DHCP client</li> <li>▪ NTP client (D-Link)</li> <li>▪ DNS client</li> <li>▪ DDNS client (D-Link)</li> <li>▪ SMTP client</li> <li>▪ FTP client</li> <li>▪ HTTP / HTTPS</li> </ul>	<ul style="list-style-type: none"> <li>▪ Samba client</li> <li>▪ PPPoE</li> <li>▪ UPnP port forwarding</li> <li>▪ RTP / RTSP / RTCP</li> <li>▪ IP filtering</li> <li>▪ QoS</li> <li>▪ CoS</li> <li>▪ Multicast</li> <li>▪ IGMP</li> <li>▪ SNMP</li> <li>▪ ONVIF compliant</li> </ul>
	Security	<ul style="list-style-type: none"> <li>▪ Administrator and user group protection</li> <li>▪ Password authentication</li> </ul>	<ul style="list-style-type: none"> <li>▪ HTTP and RTSP digest encryption</li> </ul>



## Appendix B: Technical Specifications

<b>System Management</b>	System Requirements for Web Interface	<ul style="list-style-type: none"> <li>Operating System: Microsoft Windows 7/Vista/XP/2000</li> </ul>	<ul style="list-style-type: none"> <li>Browser: Internet Explorer, Firefox, Netscape, Opera</li> </ul>	
	Event Management	<ul style="list-style-type: none"> <li>Motion detection</li> <li>Event notification and uploading of snapshots/video clips via e-mail or FTP</li> </ul>	<ul style="list-style-type: none"> <li>Supports multiple SMTP and FTP servers</li> <li>Multiple event notifications</li> <li>Multiple recording methods for easy backup</li> </ul>	
	Remote Management	<ul style="list-style-type: none"> <li>Take snapshots/video clips and save to local hard drive or NAS via web browser</li> </ul>	<ul style="list-style-type: none"> <li>Configuration interface accessible via web browser</li> </ul>	
	Mobile Support	Windows 7/Vista/XP system, Pocket PC, or mobile phone	mydlink mobile app for iOS and Android mobile devices	
	D-ViewCam™ System Requirements	<ul style="list-style-type: none"> <li>Operating System: Microsoft Windows 7/Vista/XP</li> <li>Web Browser: Internet Explorer 7 or higher</li> </ul>	<ul style="list-style-type: none"> <li>Protocol: Standard TCP/IP</li> </ul>	
	D-ViewCam™ Software Functions	<ul style="list-style-type: none"> <li>Remote management/control of up to 32 cameras</li> <li>Viewing of up to 32 cameras on one screen</li> </ul>	<ul style="list-style-type: none"> <li>Supports all management functions provided in web interface</li> <li>Scheduled motion triggered, or manual recording options</li> </ul>	
<b>General</b>	Weight	<ul style="list-style-type: none"> <li>Device: 84.0g (without stand)</li> <li>Stand: 45.0g</li> </ul>		
	External Power Adaptor	<ul style="list-style-type: none"> <li>Input: 100 to 240 V AC, 50/60 Hz</li> </ul>	<ul style="list-style-type: none"> <li>Output: 5 V DC, 1.2 A, 50/60 Hz</li> </ul>	
	Power Consumption	<ul style="list-style-type: none"> <li>4 watts</li> </ul>		
	Temperature	<ul style="list-style-type: none"> <li>Operating: 0 to 40 °C (32 to 104 °F)</li> </ul>	<ul style="list-style-type: none"> <li>Storage: -20 to 70 °C (-4 to 158 °F)</li> </ul>	
	Humidity	<ul style="list-style-type: none"> <li>Operating: 20% to 80% non-condensing</li> </ul>	<ul style="list-style-type: none"> <li>Storage: 5% to 95% non-condensing</li> </ul>	
	Certifications	<ul style="list-style-type: none"> <li>CE</li> <li>CE LVD</li> </ul>	<ul style="list-style-type: none"> <li>FCC</li> <li>C-Tick</li> </ul>	

Dimensions

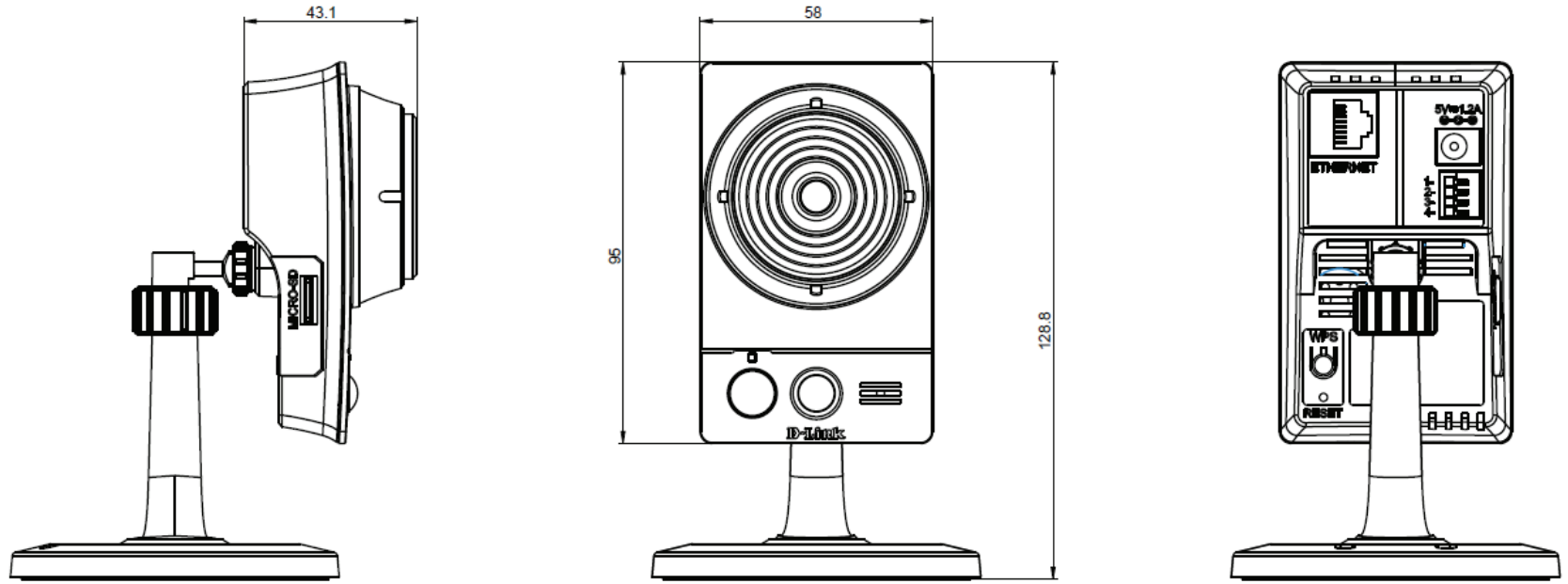

# Safety Statements

## **CE Mark Warning:**

This is a Class B product. In a domestic environment, this product may cause radio interference, in which case the user may be required to take adequate measures.

## **FCC Statement:**

This equipment has been tested and found to comply with the limits for a Class B digital device, pursuant to part 15 of the FCC Rules. These limits are designed to provide reasonable protection against harmful interference in a residential installation. This equipment generates, uses, and can radiate radio frequency energy and, if not installed and used in accordance with the instructions, may cause harmful interference to radio communication. However, there is no guarantee that interference will not occur in a particular installation. If this equipment does cause harmful interference to radio or television reception, which can be determined by turning the equipment off and on, the user is encouraged to try to correct the interference by one or more of the following measures:

- Reorient or relocate the receiving antenna.
- Increase the separation between the equipment and receiver.
- Connect the equipment into an outlet on a circuit different from that to which the receiver is connected.
- Consult the dealer or an experienced radio/TV technician for help.

## **FCC Caution:**

Any changes or modifications not expressly approved by the party responsible for compliance could void the user's authority to operate this equipment.

This device complies with Part 15 of the FCC Rules. Operation is subject to the following two conditions:

(1) This device may not cause harmful interference, and (2) this device must accept any interference received, including interference that may cause undesired operation.

### **IMPORTANT NOTICE:**

#### **FCC Radiation Exposure Statement:**

This equipment complies with FCC radiation exposure limits set forth for an uncontrolled environment. This equipment should be installed and operated with minimum distance 20cm between the radiator & your body. This transmitter must not be co-located or operating in conjunction with any other antenna or transmitter.

The availability of some specific channels and/or operational frequency bands are country dependent and are firmware programmed at the factory to match the intended destination. The firmware setting is not accessible by the end user.

For detailed warranty information applicable to products purchased outside the United States, please contact the corresponding local D-Link office.

#### **Industry Canada Notice:**

This device complies with RSS-210 of the Industry Canada Rules. Operation is subject to the following two conditions:

(1) This device may not cause harmful interference, and (2) this device must accept any interference received, including interference that may cause undesired operation.

### **IMPORTANT NOTE:**

#### **Radiation Exposure Statement:**

This equipment complies with IC radiation exposure limits set forth for an uncontrolled environment. This equipment should be installed and operated with minimum distance 20cm between the radiator & your body.

This device has been designed to operate with an antenna having a maximum gain of 2 dB. Antenna having a higher gain is strictly prohibited per regulations of Industry Canada. The required antenna impedance is 50 ohms.