

Canon

PIXMA G4000 series



Getting Started

Démarrage

Para Começar

Guía de inicio



QT61606V01

1

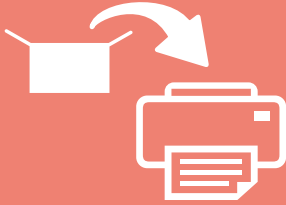

Installing the Printer.....	page 1
Installation de l'imprimante.....	page 1
Instalando a impressora.....	página 1
Instalación de la impresora.....	página 1

2



Connecting with Computer and Smartphone/Tablet.....	page 5
Connexion avec un ordinateur et un smartphone ou une tablette.....	page 5
Conectando a um computador e smartphone/tablet.....	página 5
Conexión con el ordenador y con el teléfono inteligente o la tableta.....	página 5

This product requires careful handling of ink. Ink may splatter when the ink tanks are filled with ink. If ink gets on your clothes or belongings, it may not come off.

L'encre utilisée avec ce produit doit être manipulée avec précaution. L'encre risque de provoquer des éclaboussures lorsque les cartouches d'encre sont remplies. Si de l'encre tache vos vêtements ou vos effets personnels, vous risquez de ne plus pouvoir l'enlever.

Este produto requer manuseio cauteloso da tinta. A tinta pode respingar quando os cartuchos de tinta estão cheios. Se a tinta entrar em contato com roupas ou objetos, pode ser que ela não saia.

Este producto requiere un manejo con cuidado de la tinta. La tinta puede salpicar al verterla en los depósitos de tinta para llenarlos. Si la tinta mancha la ropa o los objetos, puede que no se vaya.

1. Installing the Printer

For the procedure with  icon, you can watch the video tutorials for installing the printer by accessing the following URL or scanning the QR codes.



Checking Included Items

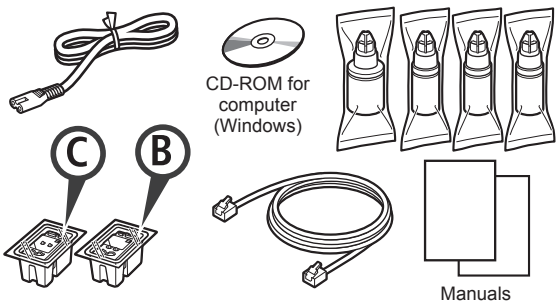

Removing Packing Materials

 You can watch the procedure on a movie by scanning the QR codes.



- 1 Remove the packing materials (such as tape) from outside the printer.
- 2
 - 1 Remove the orange tape.
 - 2 Open the scanning unit / cover.

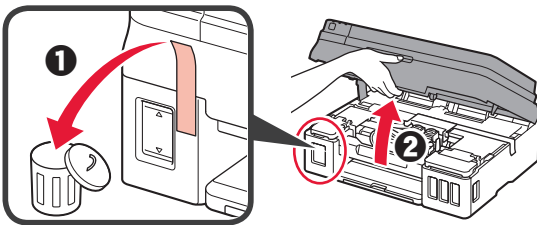

- 3 Remove the orange tape and the protective material and discard them.

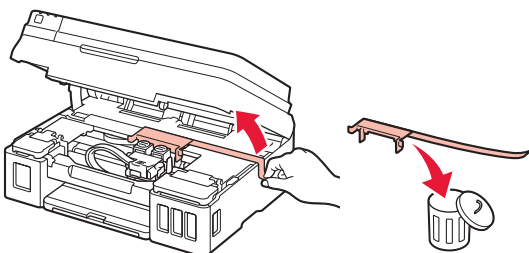

Installing the Cartridge

 You can watch the procedure on a movie by scanning the QR codes.



- 1
 - 1 Grab the knob on the cartridge locking cover.
 - 2 Open the cartridge locking cover.

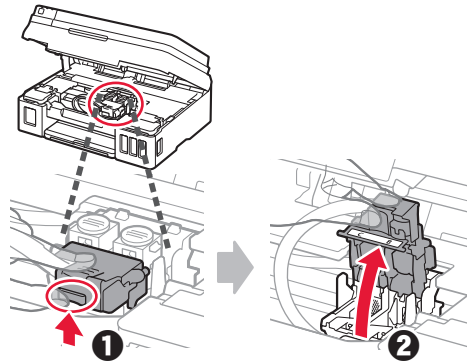

- 2 Take out the C (color) cartridge from the box and remove the label.

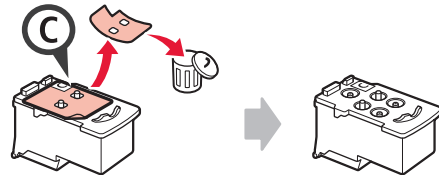

- 3 Remove the protective tape.

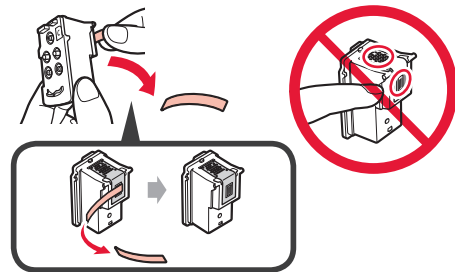

- 4 Insert the C (color) cartridge on the left.

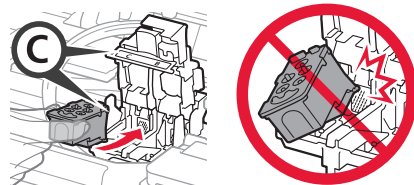

- 5 Repeat steps 2 to 4 to insert the B (black) cartridge on the right.

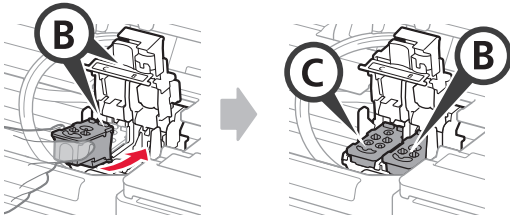

- 6 Close the cartridge locking cover and push it down.

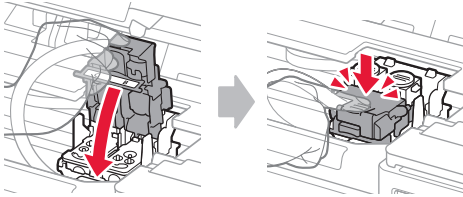

- 7 Press down both joint buttons.

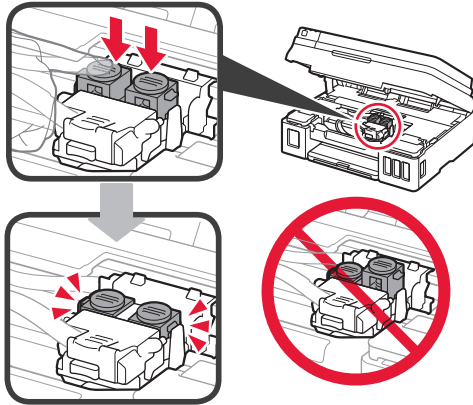

Pouring Ink

- ▶ You can watch the procedure on a movie by scanning the QR codes.



Android



iOS

- 1 Open the left ink tank cover.

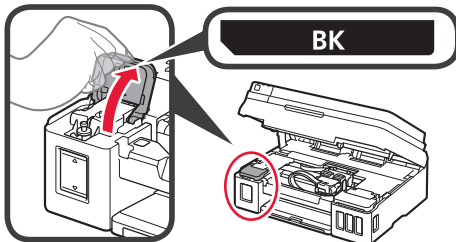

- 2 Grab and remove the tank cap of the ink tank, and then place it on the upper tank cap holder.

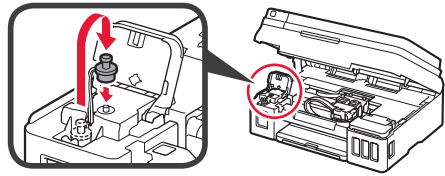

- 3
- 1 Take the BK (black) ink bottle out of its package.
 - 2 Hold the ink bottle upright and remove the bottle cap.

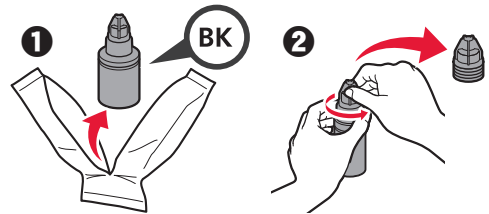

- 4 Insert the nozzle of the ink bottle into the inlet and stand the ink bottle upside down.

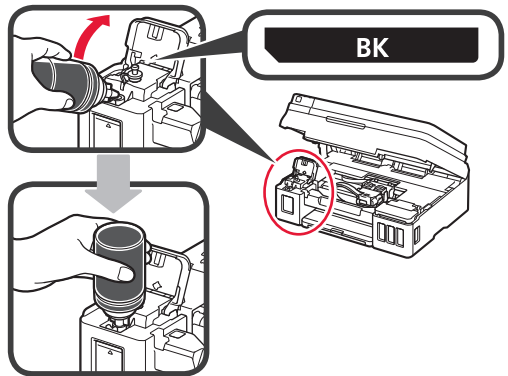

- 5 Pour all ink into the ink tank.

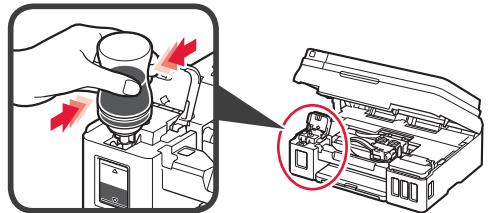

- 6 Close the tank cap.

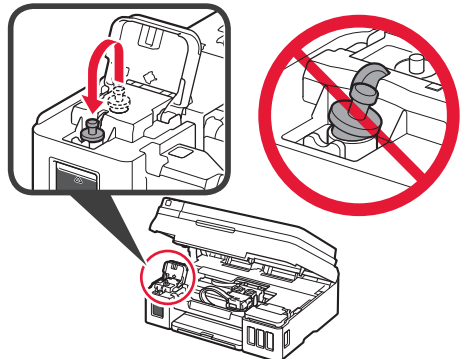

7 Close the ink tank cover.

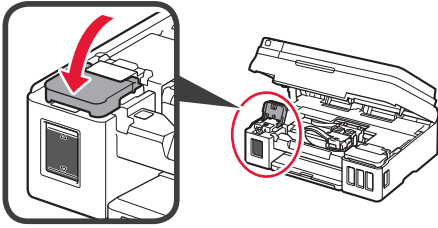

- 8
- 1 Open the right ink tank cover.
 - 2 Repeat steps 2 to 6 to pour all ink into the corresponding ink tanks on the right according to the label.
 - 3 Close the ink tank cover.

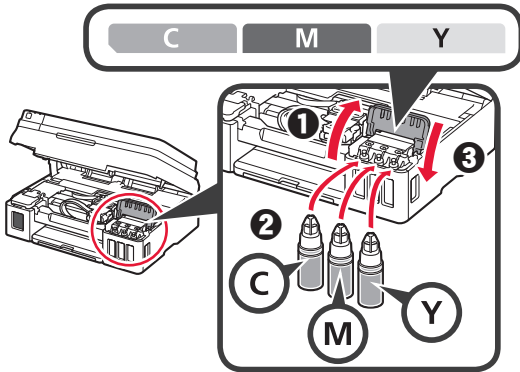

9 Check that all ink in the bottles is poured into the ink tanks.

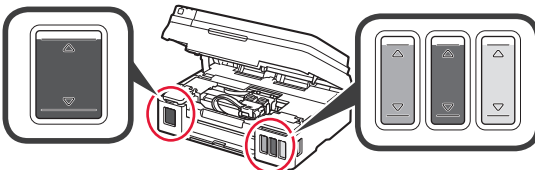

10 Close the scanning unit / cover.

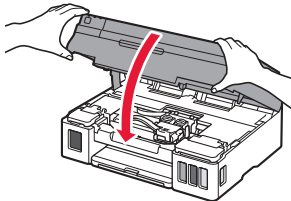

Turning on the Printer

You can watch the procedure on a movie by scanning the QR codes.



Android



iOS

ENGLISH

- 1 Connect the power cord.
- Do not connect any cables except the power cord yet.

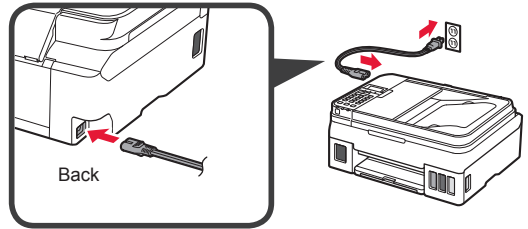

2 Press the **ON** button.

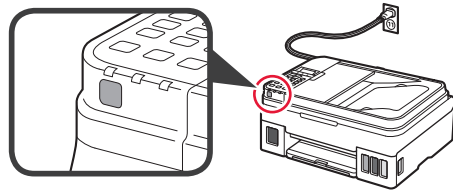

If an error message appears, make sure the cartridges are installed correctly.

3 Use the ◀ or ▶ button to select a language, and then press the **OK** button.

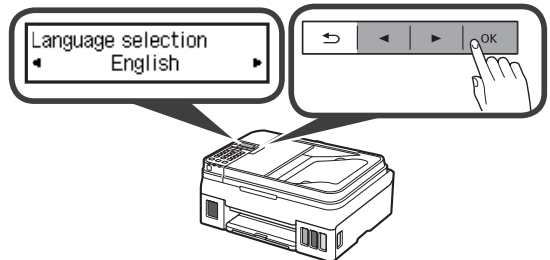

4 If the following screen appears, select your country or region, and then press the **OK** button.





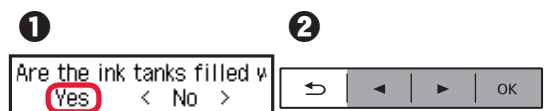



- 5
- 1 When the following screen appears, make sure the ink preparation is complete.
 - 2 Select **Yes**, and then press the **OK** button.

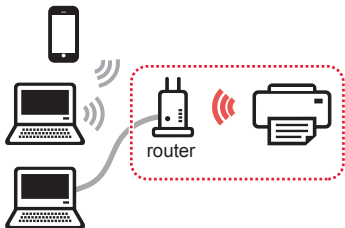

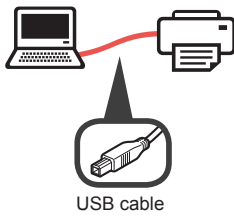
Selecting a Printer Connection Method

The connection method varies depending on how you use the printer. Select a printer connection method according to the table below. In the following description, smartphones and tablet devices are collectively described as smartphone.

Using the printer with your computer or smartphone connected		Using the printer without connecting any other devices
<p>Wireless LAN</p> <p>Connecting the printer to your computer or smartphone via a wireless router</p>  <p>Connecting the printer to your computer or smartphone directly without a wireless router *</p> 	<p>USB</p>  <p>USB cable</p>	<p>Do not connect</p>   <p>Use the ◀ or ▶ button to select Do not connect on the connection method selecting screen, and then press the OK button. Follow the on-screen instructions to proceed with the setup. Wait for about 6 minutes until the following screen appears. The setup is now complete.</p> 

* You may not connect your smartphone to the Internet wirelessly during connecting the printer to the smartphone directly. In that case, you may be charged depending on the contract with your service provider.

* Up to 5 devices can be connected to the printer via wireless LAN connection directly.

- 1 Select your printer connection method, and then press the **OK** button.



Follow the on-screen instructions to proceed with the setup.

Users who select USB:

Do not connect a USB cable until you are instructed.

- 2 If the following screen appears, proceed to the next page.

- If you select **Wireless LAN**:

Adjusting for first use...
See "Getting Started" and

Start connection setup
See "Getting Started"

- If you select **USB**:

Adjusting for first use...
See "Getting Started" and

Copy
100% Letter 01

2. Connecting with Computer and Smartphone/Tablet

If you connect the printer to both your computer and your smartphone, connect it to the computer first.

To connect the printer only to your smartphone, proceed to "Connecting with Smartphone" on page 6.

Connecting with Computer

You need connection setup for each computer. Proceed with the setup from step 1 for each computer.

The following describes the procedures for Windows and Mac OS.

If you use a computer except for Windows or Mac OS such as Chrome OS, access "<http://canon.com/ijsetup>", and then follow the instructions on the Canon website to set up your computer.

- 1 Select one of the following steps **A** or **B** to start up the setup file.

A Mac OS Windows

Accessing the Canon Website

- 1 Visit the Canon website below and click **Set Up**.

<http://canon.com/ijsetup>



Follow the on-screen instructions to proceed with the setup.

- 2 If the following screen appears, click **Download**.

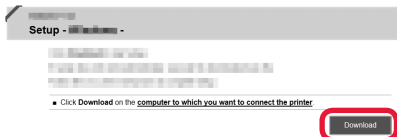

- 3 Start up the downloaded file.



B Windows

Using the Setup CD

- 1 Insert the setup CD into your computer.



When using Windows 10, Windows 8.1 or Windows 8:

- 2 Click  or  **File Explorer** on the taskbar.
- 3 Select **This PC** or **Computer** on the left side of the opened window.
- 4 Double-click the  CD-ROM icon on the right side of the window.

* If the contents of the CD-ROM appear, double-click **MSETUP4.EXE**.

- 2 Click **Start Setup**.

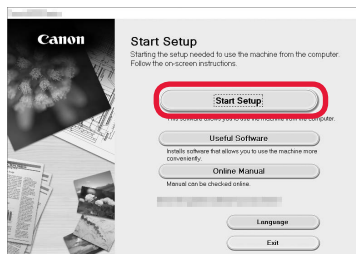

Follow the on-screen instructions to proceed with the setup.

You can set up your smartphone in the middle of the steps.

On the following screen, click **Instructions** to proceed with setup of your smartphone.

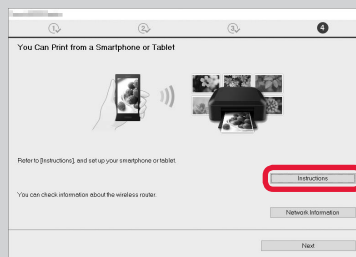

* Depending on your settings, the screen above may not appear. In that case, proceed to "Connecting with Smartphone" on page 6 after finishing the connection to your computer.

- 3 If the following screen appears, click **Exit**.

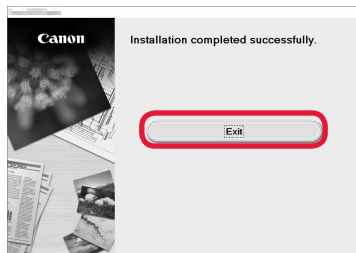

The connection with your computer is now complete. You can print from your computer.

Connecting with Smartphone

You need connection setup for each smartphone. Proceed with the setup from step 1 for each smartphone.

Preparation

- Turn on Wi-Fi on your smartphone.
- If you have a wireless router, connect your smartphone to the wireless router.
- * For operations, refer to manuals of your smartphone and the wireless router or contact those manufacturers.

- 1 Install the application software Canon PRINT Inkjet/SELPHY in your smartphone.



iOS : Search "Canon PRINT" in App Store.

Android : Search "Canon PRINT" in Google Play.

Or access the Canon website by scanning the QR code.



- 2 Check the display on the printer.

The screen turns off when no operation is made for 10 minutes. Press one of the buttons on the operation panel (except for the **ON** button) to display the screen.

- 1 Does the following screen appear?

Adjusting for first use...
See "Getting Started" and

No

Yes (Proceed to **B**.)

- 2 Does **Wi-Fi** (the printer is connected to the network) appear on the screen displayed by pressing the  **COPY** button?

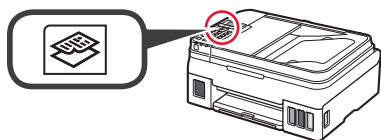

Copy mode
Wi-Fi 

Yes

No (Proceed to **B**.)

If  **Wi-Fi** appears, the printer can not communicate by wireless LAN connection. For details, access "<http://canon.com/ijsetup>" to see **Frequently Asked Questions**.

A **iOS** **Android**

- 1 Tap the installed application software.



- 2 Follow the on-screen instructions to register the printer.

- 3 Make sure that the following screen appears.



The connection with your smartphone is now complete. You can print from your smartphone.

To print photos, load photo paper. Proceed to "Loading Paper" on page 8.

- B** Procedures below vary depending on iOS or Android. Select your operating system and proceed to its procedure.

iOS

- 1 Tap **Settings** on the HOME screen, and then tap **Canon_ij_XXXX** on the Wi-Fi settings.

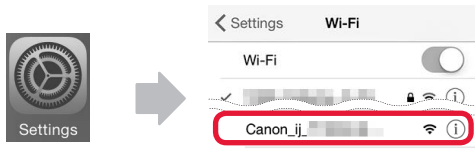

If **Canon_ij_XXXX** does not appear on the list, see "Preparation of the Printer" below to operate the printer, and then repeat step 1.

- 2 Tap the installed application software.



- 3 Follow the on-screen instructions to register the printer.

Follow the on-screen instructions to proceed with the setup.

If you select **Auto Select Conn. Method (recommended)** on the connection method selecting screen, the appropriate connection method is selected automatically depending on your environment.

- 4 Make sure that the following screen appears.



Android

- 1 Tap the installed application software.



- 2 Follow the on-screen instructions to register the printer.

If a message saying "**Printer is not registered. Perform printer setup?**" does not appear, see "Preparation of the Printer" below to operate the printer, and then wait for a while until a message appears.

Follow the on-screen instructions to proceed with the setup.

The appropriate connection method is selected depending on your environment.

- 3 Make sure that the following screen appears.



The connection with your smartphone is now complete. You can print from your smartphone.

To print photos, load photo paper. Proceed to "Loading Paper" on page 8.

Preparation of the Printer

- 1 Press the **Setup** button on the printer.

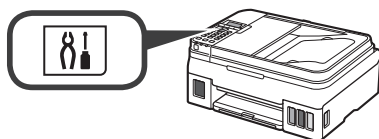

- 2 Use the ◀ or ▶ button to select **Wireless LAN setup > Easy WL connect**, and then press the **OK** button.

- 3 Return to the operation of your smartphone.

Loading Paper

- 1 Open the paper support and the paper support extension.

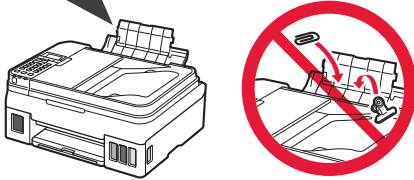
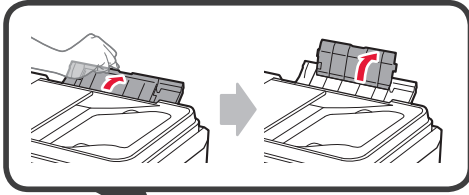

- 2 Slide the right paper guide to the right end.

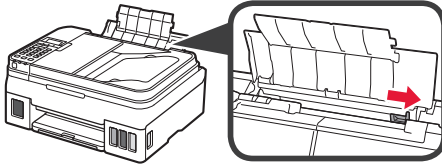

- 3 Insert several sheets of paper until it stops with the print side facing up.

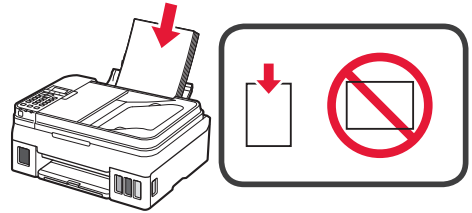

- 4 Slide the right paper guide to align it with the side of the paper stack.

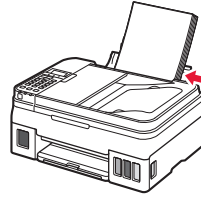

- 5
① Pull out the paper output tray.
② Open the output tray extension.

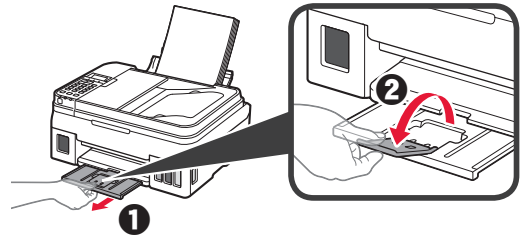

Using Fax Function

Before using the fax function, refer to the following manual to set up the fax function of your printer.

■ **Setting Up the FAX on the Online Manual**

- ① Visit the Canon website below and click **Set Up**.

<http://canon.com/ijsetup>



Follow the on-screen instructions to proceed with the setup.

- ② Click **Making Fax Ready for Use**.



■ **Setting Up the FAX in the Basic Manual** which is installed into your computer.



1. Installation de l'imprimante

Pour la procédure avec l'icône , vous pouvez regarder les didacticiels vidéo sur l'installation de l'imprimante en accédant à l'URL suivante ou en numérisant les codes QR.



Vérification des éléments fournis

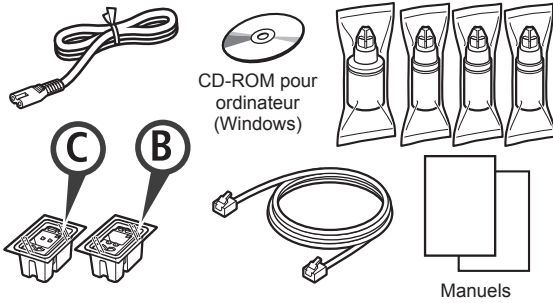

Retrait des matériaux d'emballage

Vous pouvez regarder une vidéo de la procédure en numérisant les codes QR.



- 1 Retirez les matériaux d'emballage (tels que la bande) de l'imprimante.
- 2
 - 1 Retirez la bande orange.
 - 2 Ouvrez l'unité de numérisation / capot.

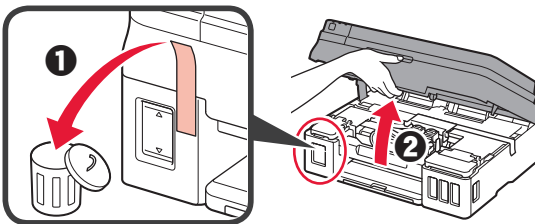

- 3 Retirez la bande orange et le matériau protecteur et jetez-les.

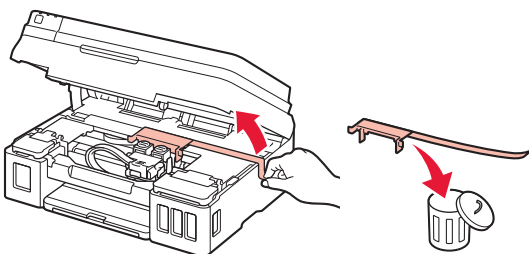

Installation de la cartouche

Vous pouvez regarder une vidéo de la procédure en numérisant les codes QR.

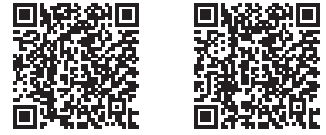

Android

iOS

- 1
 - 1 Saisissez le bouton sur le couvercle de verrouillage de cartouche.
 - 2 Ouvrez le couvercle de verrouillage de cartouche.

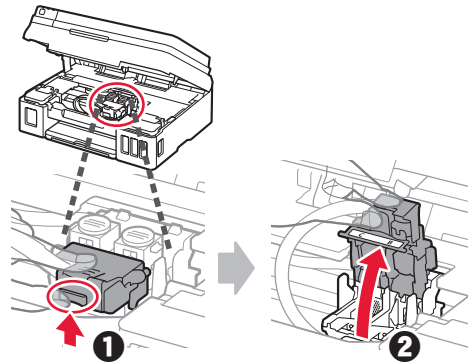

- 2 Sortez la cartouche C (couleur) de la boîte et retirez l'étiquette.

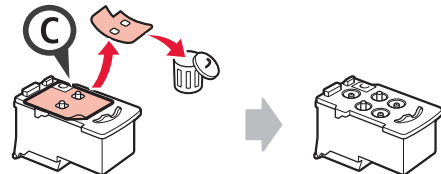

- 3 Retirez la bande protectrice.

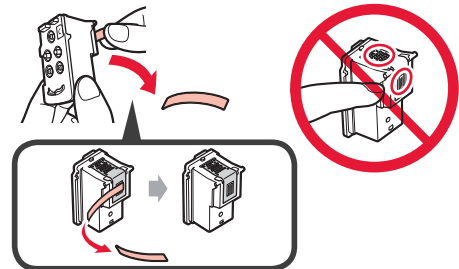

- 4 Insérez la cartouche C (couleur) à gauche.

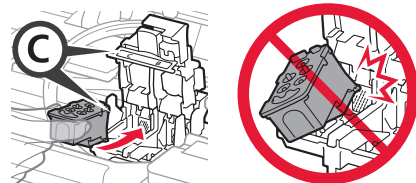

- 5 Répétez les étapes 2 à 4 pour insérer la cartouche B (noir) à droite.

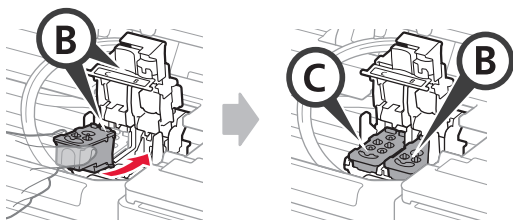

- 6 Fermez le couvercle de verrouillage de cartouche et poussez-le vers le bas.

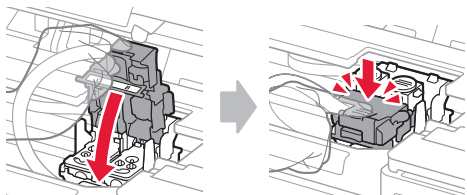

- 7 Appuyez sur les deux boutons mixtes.

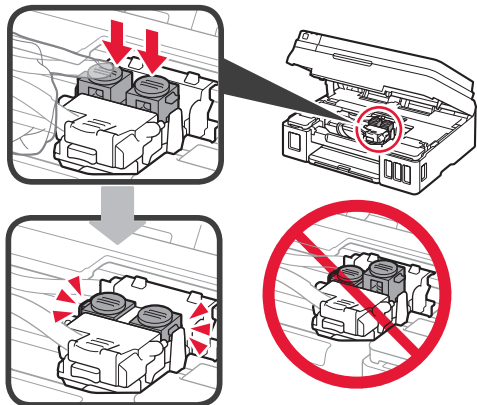

Versement de l'encre

- Vous pouvez regarder une vidéo de la procédure en numérisant les codes QR.



Android



iOS

- 1 Ouvrez le couvercle de cartouche d'encre gauche.

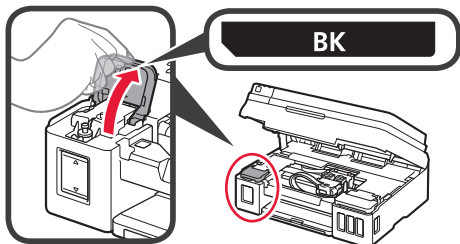

- 2 Saisissez et retirez le capuchon de cartouche de la cartouche d'encre, puis placez-le sur le porte-capuchon de cartouche supérieur.

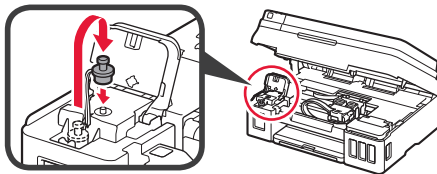

- 3 1 Sortez la bouteille d'encre BK (noire) de son emballage.
2 Tenez la bouteille d'encre bien droite et retirez le capuchon de bouteille.

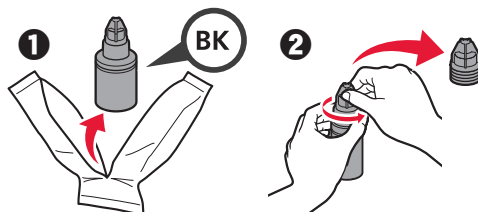

- 4 Insérez la buse de la bouteille d'encre dans l'arrivée et retournez la bouteille d'encre.

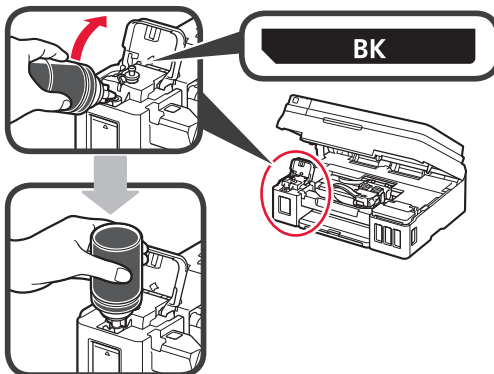

- 5 Versez toute l'encre dans la cartouche d'encre.

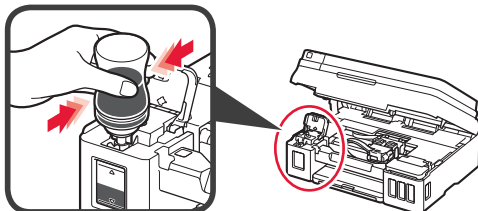

- 6 Fermez le capuchon de cartouche.

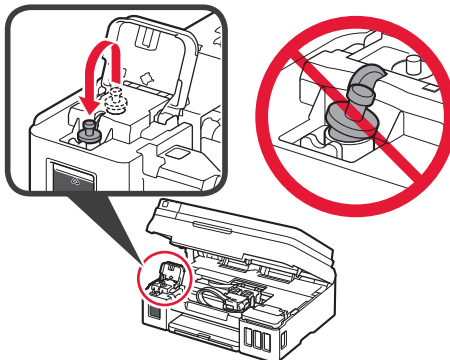

7 Fermez le couvercle de cartouche d'encre.

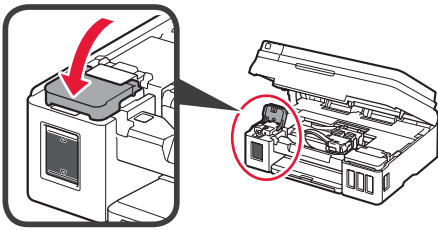

- 8
- 1 Ouvrez le couvercle de cartouche d'encre droit.
 - 2 Répétez les étapes 2 à 6 pour verser toute l'encre dans les cartouches d'encre correspondantes sur la droite en fonction de l'étiquette.
 - 3 Fermez le couvercle de cartouche d'encre.

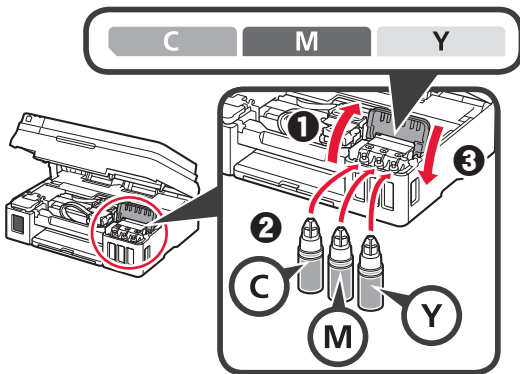

9 Vérifiez que toute l'encre des bouteilles soit versée dans les cartouches d'encre.

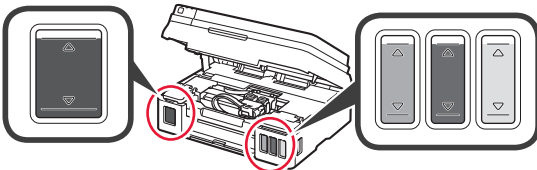

10 Fermez l'unité de numérisation / capot.

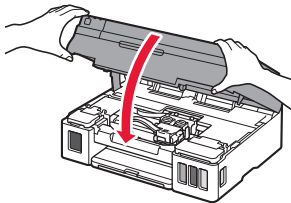

Mise sous tension de l'imprimante

Vous pouvez regarder une vidéo de la procédure en numérisant les codes QR.



Android



iOS

- 1 Branchez le cordon d'alimentation.
- ⊘ Ne branchez aucun câble pour le moment, à l'exception du cordon d'alimentation.

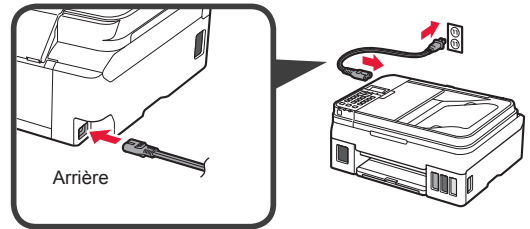

- 2 Appuyez sur le bouton **MARCHE (ON)**.

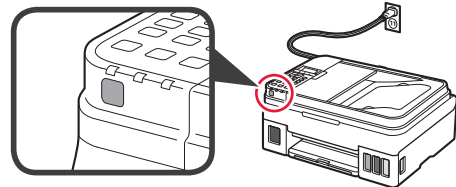

Si un message d'erreur apparaît, vérifiez que les cartouches sont correctement installées.

- 3 Utilisez le bouton ◀ ou ▶ pour sélectionner une langue, puis appuyez sur le bouton **OK**.

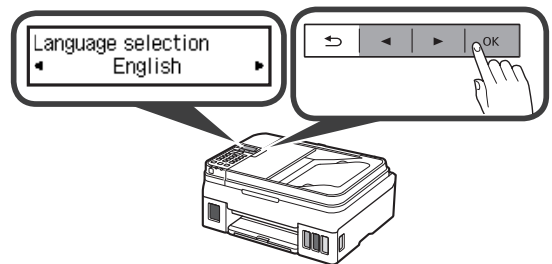

- 4 Si l'écran suivant s'affiche, sélectionnez votre pays ou votre région et appuyez sur le bouton **OK**.





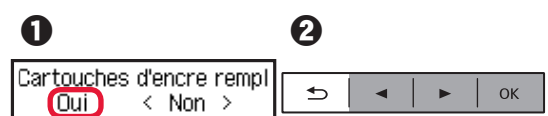

- 5
- 1 Lorsque l'écran suivant s'affiche, vérifiez que la préparation de l'encre est terminée.
 - 2 Sélectionnez **Oui**, puis appuyez sur le bouton **OK**.

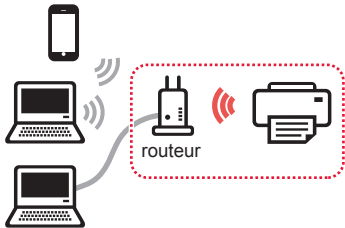

Sélection d'une méthode de connexion à l'imprimante

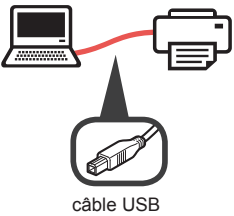
La méthode de connexion varie selon l'utilisation de l'imprimante. Sélectionnez une méthode de connexion à l'imprimante dans le tableau ci-dessous. Dans la description suivante, les smartphones et les tablettes sont regroupés sous le terme smartphone.

Utilisation de l'imprimante avec votre ordinateur ou votre smartphone connecté		Utilisation de l'imprimante sans aucun autre périphérique connecté
<p>Réseau sans fil</p> <p>Connexion de l'imprimante à votre ordinateur ou à votre smartphone via un routeur sans fil</p>  <p>Connexion de l'imprimante directement à votre ordinateur ou à votre smartphone sans routeur sans fil *</p> 	<p>USB</p> 	<p>Ne pas connecter</p>   <p>Utilisez le bouton ◀ ou ▶ pour sélectionner Ne pas connecter sur l'écran de sélection de la méthode de connexion, puis appuyez sur le bouton OK. Suivez les instructions à l'écran pour poursuivre la configuration. Patientez environ 6 minutes, jusqu'à ce que l'écran suivant s'affiche. La configuration est terminée.</p> <div style="border: 1px solid black; padding: 5px; width: fit-content;"> Copie 100% 01 </div>

* Il se peut que vous ne parveniez pas à connecter votre smartphone via une connexion sans fil à Internet lorsque l'imprimante est connectée directement au smartphone. Dans ce cas, vous risquez de devoir payer des frais en fonction du contrat avec votre fournisseur de services.

* Jusqu'à 5 périphériques peuvent être connectés directement à l'imprimante via une connexion réseau sans fil.

1 Sélectionnez votre méthode de connexion à l'imprimante, puis appuyez sur le bouton **OK**.



Suivez les instructions à l'écran pour poursuivre la configuration.

Pour les utilisateurs qui sélectionnent USB :

Ne branchez pas de câble USB tant que vous n'en recevez pas l'instruction.

2 Si l'écran suivant s'affiche, passez à la page suivante.

■ Si vous sélectionnez **Réseau sans fil** :

Réglage première util...
Voir "Démarrage" et cont

Lancez config. connexion
Voir "Démarrage"

■ Si vous sélectionnez **USB** :

Réglage première util...
Voir "Démarrage" et cont

Copie
100% **01**

2. Connexion avec un ordinateur et un smartphone ou une tablette

Si vous connectez l'imprimante à votre ordinateur et à votre smartphone, connectez-la d'abord à l'ordinateur.

Pour connecter l'imprimante uniquement à votre smartphone, reportez-vous à la section « Connexion avec un smartphone », à la page 6.

Connexion avec un ordinateur

Vous devez configurer la connexion pour chaque ordinateur. Poursuivez la configuration à partir de l'étape 1 pour chaque ordinateur.

La procédure suivante s'applique à Windows et à Mac OS.

Si vous utilisez un ordinateur autre que Windows ou Mac OS, par exemple Chrome OS, accédez à « <http://canon.com/ijsetup> » et suivez les instructions fournies sur le site Web Canon pour configurer votre ordinateur.

- 1 Sélectionnez une des étapes suivantes **A** ou **B** pour démarrer le fichier de configuration.

A Mac OS Windows

Accès au site Web Canon

- 1 Accédez au site Web Canon ci-dessous et cliquez sur **Configuration**.

<http://canon.com/ijsetup>



Suivez les instructions à l'écran pour poursuivre la configuration.

- 2 Si l'écran suivant s'affiche, cliquez sur **Télécharger**.

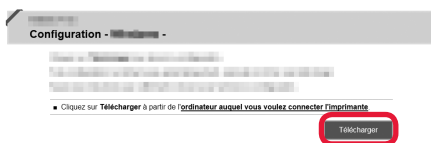

- 3 Démarrez le fichier téléchargé.

B Windows

Utilisation du CD d'installation

- 1 Insérez le CD d'installation dans l'ordinateur.



Lorsque vous utilisez Windows 10, Windows 8.1 ou Windows 8 :

- 2 Cliquez sur ou **Explorateur de fichiers** dans la barre des tâches.
- 3 Sélectionnez **Ce PC** ou **Ordinateur** dans la partie gauche de la fenêtre ouverte.
- 4 Double-cliquez sur l'icône CD-ROM dans la partie droite de la fenêtre.

* Si le contenu du CD-ROM s'affiche, double-cliquez sur **MSETUP4.EXE**.

- 2 Cliquez sur **Commencer la configuration**.

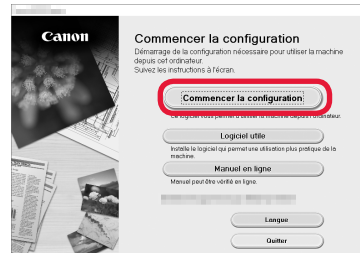

Suivez les instructions à l'écran pour poursuivre la configuration.

Vous pouvez configurer votre smartphone au cours des étapes.

Dans l'écran suivant, cliquez sur **Instructions** pour poursuivre la configuration de votre smartphone.

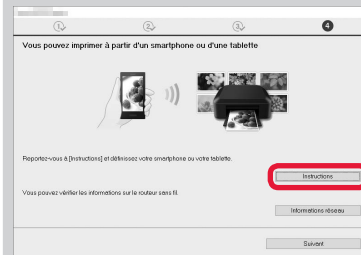

* En fonction de vos paramètres, l'écran ci-dessus peut ne pas s'afficher. Dans ce cas, passez à la section « Connexion avec un smartphone » à la page 6 lorsque la connexion avec votre ordinateur est terminée.

- 3 Si l'écran suivant s'affiche, cliquez sur **Quitter**.

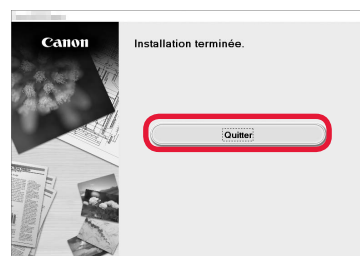

La connexion avec votre ordinateur est terminée. Vous pouvez imprimer à partir de votre ordinateur.

Connexion avec un smartphone

Vous devez configurer la connexion pour chaque smartphone. Poursuivez la configuration à partir de l'étape 1 pour chaque smartphone.

Préparation

- Activez Wi-Fi sur votre smartphone.
- Si vous avez un routeur sans fil, connectez votre smartphone au routeur sans fil.
- * Pour le fonctionnement, reportez-vous aux manuels de votre smartphone et du routeur sans fil ou prenez contact avec les fabricants.

1 Installez le logiciel d'application Canon PRINT Inkjet/SELPHY sur votre smartphone.



iOS : Recherchez « Canon PRINT » dans App Store.

Android : Recherchez « Canon PRINT » dans Google Play.

Vous pouvez également accéder au site Web Canon en numérisant le code QR.



2 Vérifiez l'affichage sur l'imprimante.

L'écran s'éteint si aucune action n'est effectuée pendant environ 10 minutes. Appuyez sur un des boutons du panneau de contrôle (sauf sur le bouton **MARCHE (ON)**) pour afficher l'écran.

1 L'écran suivant s'affiche-t-il ?

Réglage première util...
Voir "Démarrage" et cont

Non

Oui (Passez à l'étape **B**.)

2 Wi-Fi (l'imprimante est connectée au réseau) apparaît-il sur l'écran affiché lorsque vous appuyez sur le bouton **COPIE (COPY)** ?

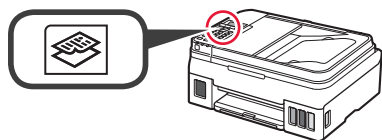

Mode copie
Wi-Fi

Oui

Non (Passez à l'étape **B**.)

Si  apparaît, l'imprimante ne peut pas communiquer via une connexion réseau sans fil. Pour plus de détails, accédez à « <http://canon.com/ijsetup> » pour consulter la section **Foire aux questions**.

A **iOS** **Android**

1 Touchez le logiciel d'application installé.



2 Suivez les instructions à l'écran pour enregistrer l'imprimante.

3 Assurez-vous que l'écran suivant s'affiche.



La connexion avec votre smartphone est terminée. Vous pouvez imprimer à partir de votre smartphone.

Pour imprimer des photos, chargez du papier photo. Passez à la section « Chargement du papier », à la page 8.

- B** Les procédures ci-dessous varient selon que vous utilisez iOS ou Android. Sélectionnez votre système d'exploitation et poursuivez avec la procédure s'y rapportant.

iOS

- 1 Touchez **Réglages** sur l'écran ACCUEIL, puis touchez **Canon_ij_XXXX** dans les réglages Wi-Fi.



Si **Canon_ij_XXXX** n'apparaît pas dans la liste, reportez-vous à la section « Préparation de l'imprimante » ci-dessous pour faire fonctionner l'imprimante, puis répétez l'étape 1.

- 2 Touchez le logiciel d'application installé.



- 3 Suivez les instructions à l'écran pour enregistrer l'imprimante.

Suivez les instructions à l'écran pour poursuivre la configuration.

Si vous sélectionnez **Méthode sél. auto conn. (recommandé)** dans l'écran de sélection de la méthode de connexion, la méthode de connexion appropriée est sélectionnée automatiquement selon votre environnement.

- 4 Assurez-vous que l'écran suivant s'affiche.



Android

- 1 Touchez le logiciel d'application installé.



- 2 Suivez les instructions à l'écran pour enregistrer l'imprimante.

Si le message « **L'imprimante n'est pas enregistrée. Configurer l'imprimante ?** » ne s'affiche pas, reportez-vous à la section « Préparation de l'imprimante » ci-dessous pour faire fonctionner l'imprimante et attendez qu'un message s'affiche.

Suivez les instructions à l'écran pour poursuivre la configuration.

La méthode de connexion appropriée est sélectionnée selon votre environnement.

- 3 Assurez-vous que l'écran suivant s'affiche.



La connexion avec votre smartphone est terminée. Vous pouvez imprimer à partir de votre smartphone.

Pour imprimer des photos, chargez du papier photo. Passez à la section « Chargement du papier », à la page 8.

Préparation de l'imprimante

- 1 Appuyez sur le bouton **Configuration (Setup)** de l'imprimante.

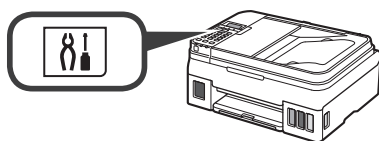

- 2 Utilisez le bouton ◀ ou ▶ pour sélectionner **Config. du rés. ss fil > Connex. facile ss fil**, puis appuyez sur le bouton **OK**.

- 3 Revenez au fonctionnement de votre smartphone.

Chargement du papier

- 1 Ouvrez le support papier et l'extension du support papier.

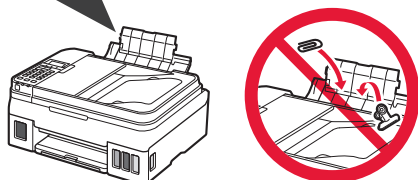
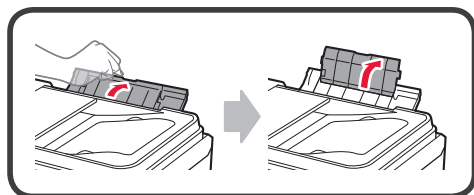

- 2 Faites glisser le guide papier droit vers l'extrémité droite.

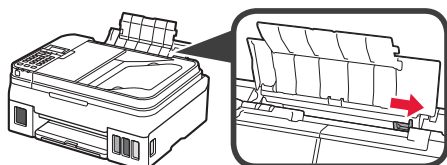

- 3 Insérez plusieurs feuilles de papier, face à imprimer vers le haut, jusqu'à ce qu'elles soient correctement en place.

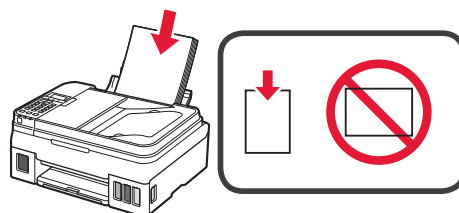

- 4 Faites glisser le guide papier droit de manière à l'aligner avec le côté de la pile de papier.

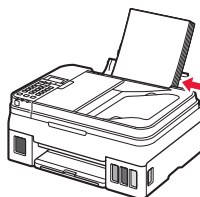

- 5 **1** Retirez le bac de sortie papier.
2 Ouvrez l'extension du bac de sortie papier.



Utilisation de la fonction de télécopie

Avant d'utiliser la fonction de télécopie, reportez-vous au manuel suivant pour définir la fonction télécopie de votre imprimante.

■ Configuration du FAX sur le Manuel en ligne

- 1** Accédez au site Web Canon ci-dessous et cliquez sur **Configuration**.

<http://canon.com/ijsetup>



Suivez les instructions à l'écran pour poursuivre la configuration.

- 2** Cliquez sur **Préparation du télécopieur**.



■ Configuration du FAX dans le Manuel de base installé sur votre ordinateur.



1. Instalando a impressora

Para os procedimentos com o ícone , você pode assistir a tutoriais em vídeo da instalação da impressora acessando a URL ou escaneando os códigos QR abaixo.

<http://canon.com/ijsetup>



Guias de Vídeo

Verificando os itens incluídos

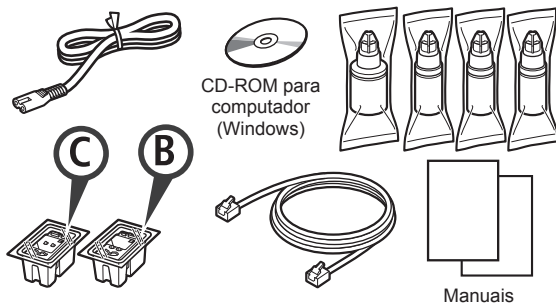

Removendo os materiais de embalagem

Você pode assistir a um vídeo do procedimento escaneando os códigos QR.



Android



iOS

- 1 Remova os materiais de embalagem (como fita) da parte externa da impressora.
- 2
 - 1 Remova a fita laranja.
 - 2 Abra a unidade de digitalização/tampa.

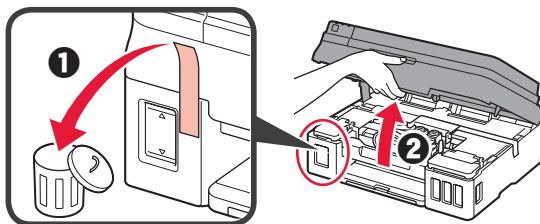

- 3 Remova a fita laranja e o material de proteção e descarte-os.

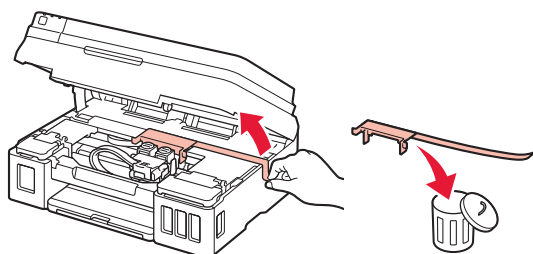

Instalando o cartucho

Você pode assistir a um vídeo do procedimento escaneando os códigos QR.



Android



iOS

- 1
 - 1 Segure o botão na tampa de fixação do cartucho.
 - 2 Abra a tampa de fixação do cartucho.

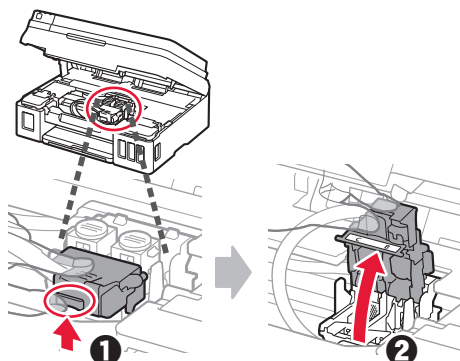

- 2 Tire o cartucho C (colorido) da caixa e remova a etiqueta.

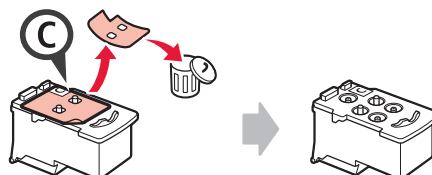

- 3 Retire a fita de proteção.

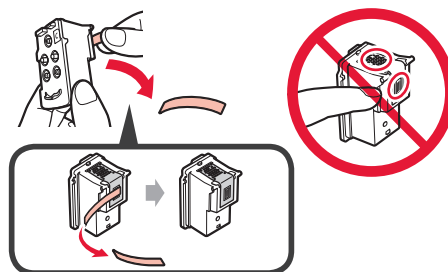

- 4 Insira o cartucho C (colorido) à esquerda.

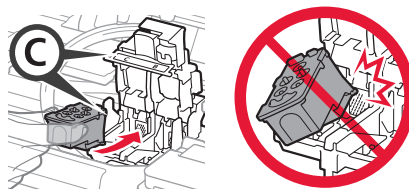

- 5 Repita as etapas de 2 a 4 para inserir o cartucho B (preto) à direita.

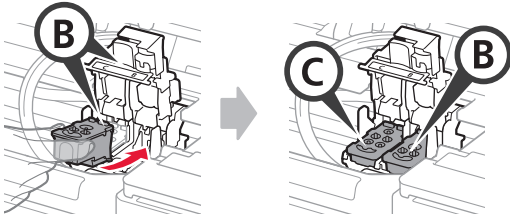

- 6 Feche a tampa de fixação do cartucho e empurre-a para baixo.

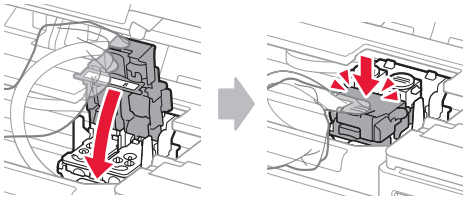

- 7 Pressione os dois botões acoplados para baixo.

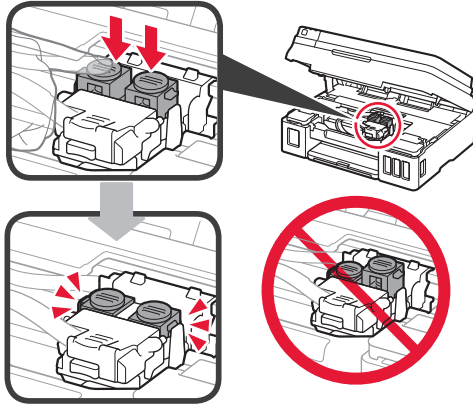

Colocando tinta

- 📺 Você pode assistir a um vídeo do procedimento escaneando os códigos QR.



Android



iOS

- 1 Abra a tampa do cartucho de tinta esquerda.

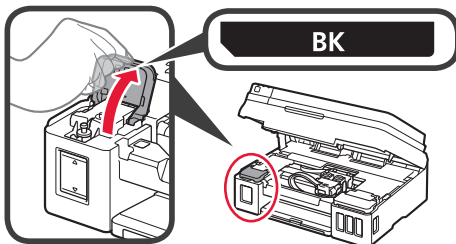

- 2 Segure e remova a tampa do cartucho de tinta e coloque-a sobre o suporte da tampa do cartucho superior.

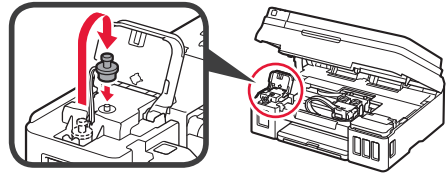

- 3 **1** Retire a garrafa de tinta BK (preta) da embalagem.
2 Segure a garrafa de tinta em posição vertical e remova a tampa da garrafa.

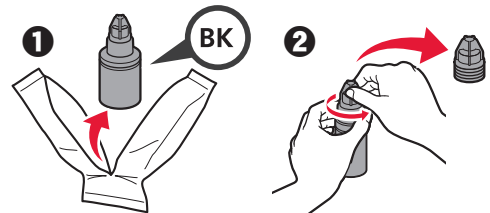

- 4 Insira o bocal da garrafa de tinta na entrada e segure a garrafa de tinta de cabeça para baixo.

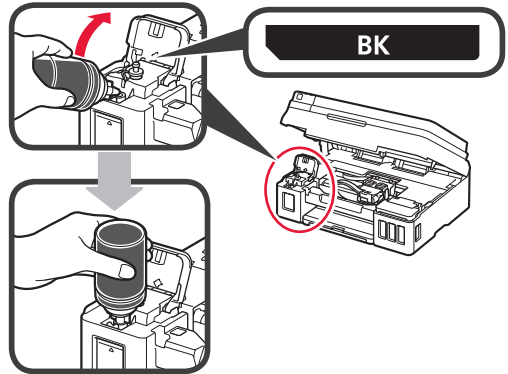

- 5 Coloque toda a tinta no cartucho de tinta.

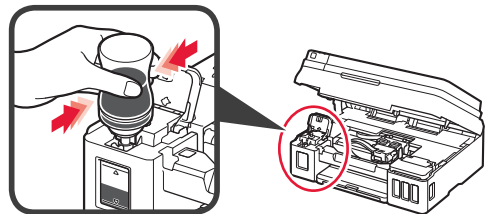

- 6 Feche a tampa do cartucho.

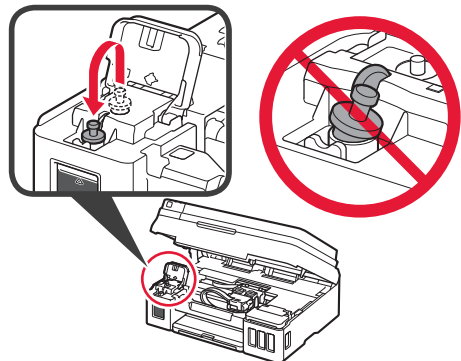

7 Feche a tampa do cartucho de tinta.

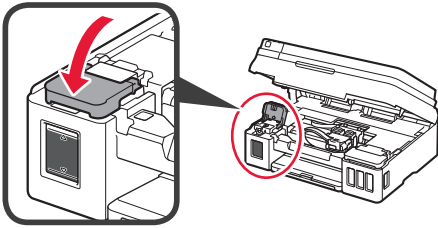

- 8
- 1 Abra a tampa do cartucho de tinta direita.
 - 2 Repita as etapas de 2 a 6 para colocar toda a tinta nos cartuchos de tinta correspondentes à direita, de acordo com a etiqueta.
 - 3 Feche a tampa do cartucho de tinta.

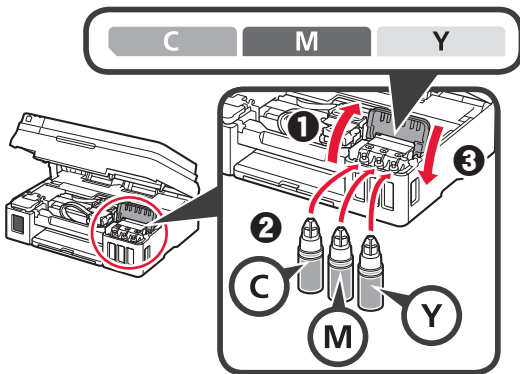

- 9 Verifique se toda a tinta das garrafas foi colocada nos cartuchos de tinta.

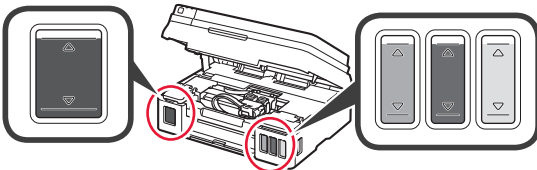

- 10 Feche a unidade de digitalização/tampa.

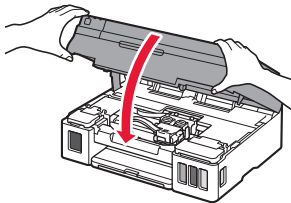

Ligando a impressora

- Você pode assistir a um vídeo do procedimento escaneando os códigos QR.



Android



iOS

- 1 Conecte o cabo de alimentação.
- ⊘ Não conecte os cabos ainda, exceto o cabo de alimentação.

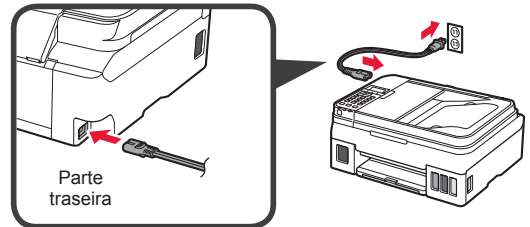

- 2 Pressione o botão **ATIVADO (ON)**.

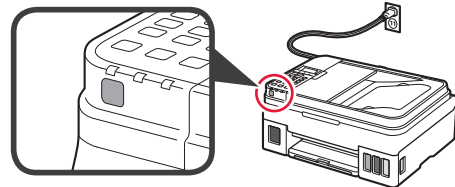

Se uma mensagem de erro for exibida, verifique se os cartuchos estão instalados corretamente.

- 3 Use o botão ◀ ou ▶ para selecionar um idioma e pressione o botão **OK**.

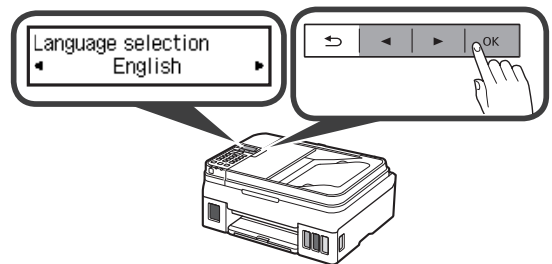

- 4 Se a tela a seguir for exibida, selecione seu país ou região e pressione o botão **OK**.





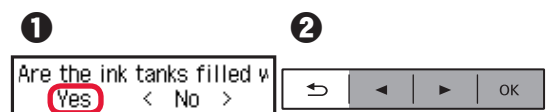



- 5
- 1 Quando a tela a seguir for exibida, certifique-se de que a preparação da tinta foi concluída.
 - 2 Selecione **Sim (Yes)** e pressione o botão **OK**.

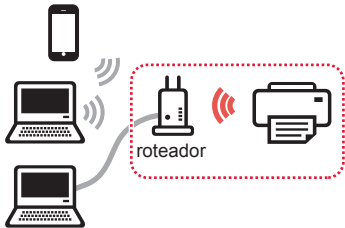

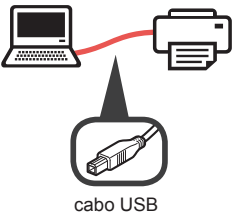
Selecionando um método de conexão para a impressora

O método de conexão varia dependendo do seu uso da impressora. Selecione um dos métodos de conexão para a impressora na tabela abaixo. Na descrição abaixo, smartphone se refere coletivamente a smartphones e tablets.

Usando a impressora com seu computador ou smartphone conectado		Usando a impressora sem conectá-la a qualquer dispositivo
LAN Sem-fio (Wireless LAN)	USB	Não conectar (Do not connect)
<p>Conectando a impressora a um computador ou smartphone por meio de um roteador sem fio</p>  <p>Conectando a impressora a um computador ou smartphone diretamente, sem um roteador sem fio *</p> 	 <p>cabo USB</p>	  <p>Use o botão ◀ ou ▶ para selecionar Não conectar (Do not connect) na tela de seleção do método de conexão e pressione o botão OK. Siga as instruções na tela para prosseguir com a configuração. Aguarde cerca de 6 minutos até que a tela a seguir seja exibida. A configuração foi concluída.</p> 

- * Não é possível conectar seu smartphone à Internet por meio de uma conexão sem fio se a impressora estiver diretamente conectada ao seu smartphone. Nesse caso, você poderá ser cobrado dependendo do contrato com seu provedor de serviço.
- * Até 5 dispositivos podem ser diretamente conectados à impressora por meio de uma conexão de LAN sem fio.

1 Selecione o método de conexão da sua impressora e pressione o botão **OK**.



Siga as instruções na tela para prosseguir com a configuração.

Usuários que selecionaram USB:
não conecte o cabo USB até que seja solicitado.

2 Se a seguinte tela for exibida, prossiga para a próxima página.

- Se você selecionar **LAN Sem-fio (Wireless LAN)**:

Adjusting for first use...
See "Getting Started" ani

Start connection setup
See "Getting Started"

- Se você selecionar **USB**:

Adjusting for first use...
See "Getting Started" ani

Copy
100% Letter 01

2. Conectando a um computador e smartphone/tablet

Se você quiser conectar a impressora a um computador e a um smartphone, conecte-a ao computador primeiro.

Para conectar a impressora apenas ao seu smartphone, prossiga para "Conectando a um smartphone" na página 6.

Conectando a um computador

Você precisará definir uma configuração de conexão para cada computador. Comece a configuração de cada computador pela etapa 1. Veja abaixo os procedimentos para Windows e Mac OS.

Se você usar um computador que não seja Windows ou Mac OS, como um computador Chrome OS, acesse "<http://canon.com/ijsetup>" e siga as instruções no site da Canon para configurar seu computador.

- 1 Selecione a etapa **A** ou **B** para iniciar o arquivo de configuração.

A Mac OS Windows

Acessando o site da Canon

- 1 Visite o site da Canon indicado abaixo e clique em **Configurar**.

<http://canon.com/ijsetup>



Siga as instruções na tela para prosseguir com a configuração.

- 2 Se a seguinte tela for exibida, clique em **Download**.

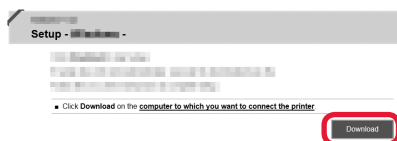

- 3 Inicie o arquivo baixado.

B Windows

Usando o CD de instalação

- 1 Insira o CD de instalação no computador.



Quando usar o Windows 10, Windows 8.1 ou Windows 8:

- 2 Clique em ou em **Explorador de Arquivos (File Explorer)** na barra de ferramentas.
- 3 Selecione **Este PC (This PC)** ou **Computador (Computer)** no lado esquerdo da janela aberta.
- 4 Clique duas vezes no ícone do CD-ROM no lado direito da janela.

* Se o conteúdo do CD-ROM aparecer, clique duas vezes em **MSETUP4.EXE**.

- 2 Clique em **Iniciar configuração (Start Setup)**.

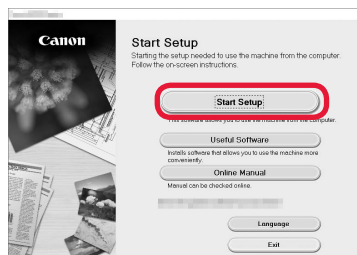

Siga as instruções na tela para prosseguir com a configuração.

Você pode configurar seu smartphone nas etapas intermediárias.

Na tela abaixo, clique em **Instruções (Instructions)** para configurar seu smartphone.

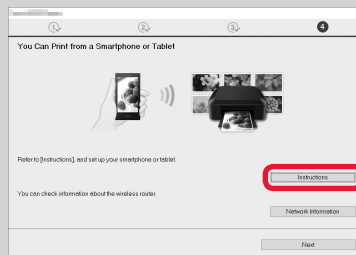

* Dependendo das suas configurações, a tela acima pode não ser exibida. Nesse caso, prossiga para "Conectando a um smartphone" na página 6 depois que você conectar a impressora ao seu computador.

- 3 Se a seguinte tela for exibida, clique em **Sair (Exit)**.

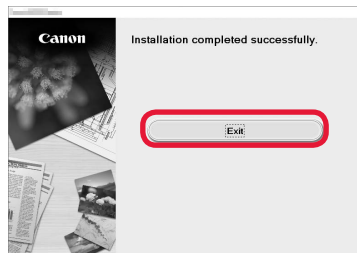

A conexão com o computador foi concluída. Você já pode imprimir usando o computador.

Conectando a um smartphone

Você precisará configurar a conexão para cada smartphone. Comece a configuração de cada smartphone pela etapa 1.

Preparação

- Ative o Wi-Fi em seu smartphone.
- Se você tiver um roteador sem fio, conecte seu smartphone a ele.
- * Para obter informações sobre operações, consulte os manuais do seu smartphone e do seu roteador sem fio ou entre em contato com seus respectivos fabricantes.

1 Instale o software aplicativo Canon PRINT Inkjet/SELPHY em seu smartphone.



iOS : Pesquise por "Canon PRINT" na App Store.

Android : Pesquise por "Canon PRINT" no Google Play.

Ou acesse o site da Canon digitalizando o código QR.



2 Verifique a tela da impressora.

A tela desliga quando nenhuma operação é realizada por 10 minutos. Pressione um dos botões do painel de controle (exceto o botão **ATIVADO (ON)**) para exibir a tela.

1 A tela a seguir é exibida?

Adjusting for first use...
See "Getting Started" and

Não

Sim (Prossiga para **B**.)

2 Wi-Fi (a impressora está conectada à rede) aparece na tela exibida quando o botão **COPIAR (COPY)** é pressionado?

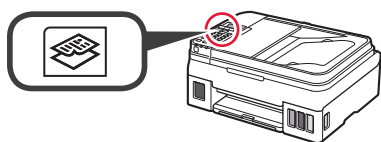

Sim

Não (Prossiga para **B**.)

Se  for exibido, a impressora não poderá se comunicar por meio de uma conexão de LAN sem fio. Para obter detalhes, acesse "<http://canon.com/ijsetup>" e consulte a seção **Perguntas Frequentes**.

A **iOS** **Android**

1 Toque no software aplicativo instalado.



2 Siga as instruções na tela para registrar a impressora.

3 Certifique-se de que a tela a seguir seja exibida.



A conexão com seu smartphone foi concluída. Você já pode imprimir usando seu smartphone.

Para imprimir fotos, coloque papel fotográfico. Prossiga para "Colocando papel" na página 8.

- B** Os procedimentos descritos abaixo podem variar para iOS e Android. Selecione seu sistema operacional e continue com o procedimento.

iOS

- 1 Toque em **Configurações (Settings)** na tela INÍCIO e toque em **Canon_ij_XXXX** nas configurações de Wi-Fi.



Se **Canon_ij_XXXX** não estiver na lista, consulte a seção "Preparação da impressora" abaixo para operar a impressora e repita a etapa 1.

- 2 Toque no software aplicativo instalado.



- 3 Siga as instruções na tela para registrar a impressora.

Siga as instruções na tela para prosseguir com a configuração.

Se você selecionar **Sel. Conexão auto. Método (recomendado) (Auto Select Conn. Method (recommended))** na tela de seleção do método de conexão, o método de conexão será selecionado automaticamente de acordo com o seu ambiente.

- 4 Certifique-se de que a tela a seguir seja exibida.



A conexão com seu smartphone foi concluída. Você já pode imprimir usando seu smartphone.

Para imprimir fotos, coloque papel fotográfico. Prossiga para "Colocando papel" na página 8.

Android

- 1 Toque no software aplicativo instalado.



- 2 Siga as instruções na tela para registrar a impressora.

Se a mensagem "**A impressora não está registrada. Executar configuração da impressora? (Printer is not registered. Perform printer setup?)**" não for exibida, consulte a seção "Preparação da impressora" abaixo para operar a impressora e aguarde até que essa mensagem seja exibida.

Siga as instruções na tela para prosseguir com a configuração.

O método de conexão apropriado é selecionado de acordo com o seu ambiente.

- 3 Certifique-se de que a tela a seguir seja exibida.



Preparação da impressora

- 1 Pressione o botão **Configuração (Setup)** na impressora.

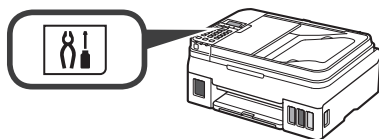

- 2 Use o botão ◀ ou ▶ para selecionar **Config. LAN sem-fio (Wireless LAN setup) > Conexão SF Easy (Easy WL connect)** e pressione o botão **OK**.

- 3 Retorne para a operação com seu smartphone.

Colocando papel

- 1 Abra o suporte de papel e a extensão do suporte de papel.

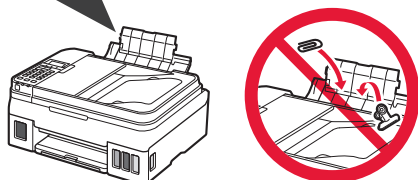
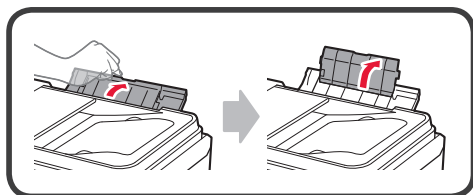

- 2 Deslize a guia do papel direita até a extremidade direita.

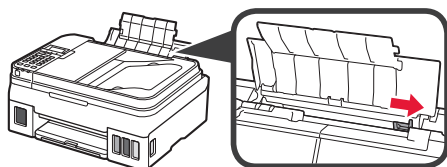

- 3 Insira várias folhas de papel com o lado de impressão voltado para cima até parar.

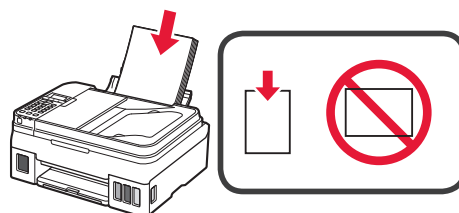

- 4 Deslize a guia do papel direita para alinhá-la à pilha de papel.

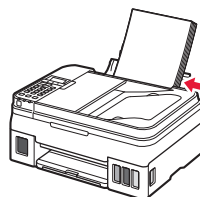

- 5 ❶ Puxe para fora a bandeja de saída do papel.
❷ Abra a extensão da bandeja de saída.

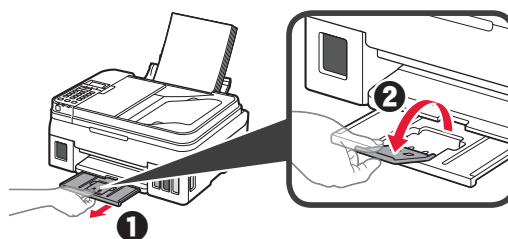

Usando a função de fax

Antes de usar a função de fax, consulte o seguinte manual para configurar essa função na impressora.

■ Configurando o FAX no Manual On-line

- ❶ Visite o site da Canon abaixo e clique em **Configurar**.

<http://canon.com/ijsetup>



Siga as instruções na tela para prosseguir com a configuração.

- ❷ Clique em **Apontando o Fax para Uso**.



■ Configurando o FAX no Manual Básico instalado no computador.



1. Instalación de la impresora

Para el procedimiento con el ícono , puede ver los tutoriales en vídeo para la instalación de la impresora accediendo a la siguiente URL o escaneando los códigos QR.

<http://canon.com/ijsetup>



Guías de vídeo

Comprobación de los elementos suministrados

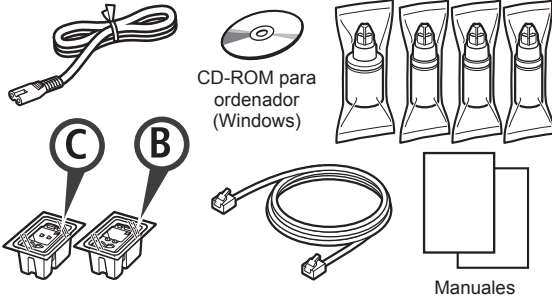

Retirar los materiales de protección

 Puede ver el procedimiento en una película escaneando los códigos QR.



Android



iOS

- 1 Retire los materiales de empaquetado (como la cinta) del exterior de la impresora.
- 2
 - 1 Retire la cinta naranja.
 - 2 Abra la cubierta/unidad de escaneo.

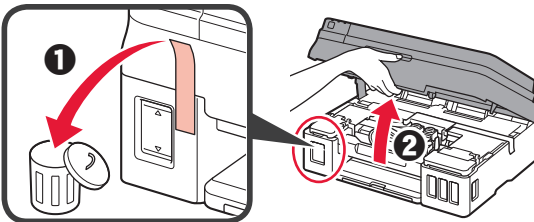

- 3 Retire la cinta naranja y el material de protección y deséchelos.

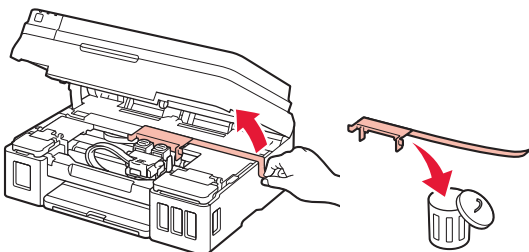

Instalar el cartucho

 Puede ver el procedimiento en una película escaneando los códigos QR.



Android



iOS

- 1
 - 1 Sujete la patilla de la tapa de bloqueo del cartucho.
 - 2 Abra la tapa de bloqueo del cartucho.

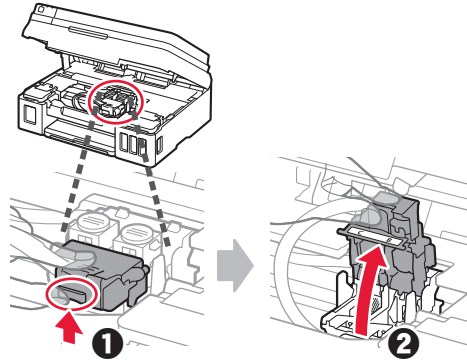

- 2 Saque el cartucho C (color) de la caja y retire la etiqueta.

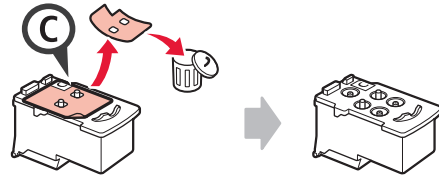

- 3 Retire la cinta protectora.

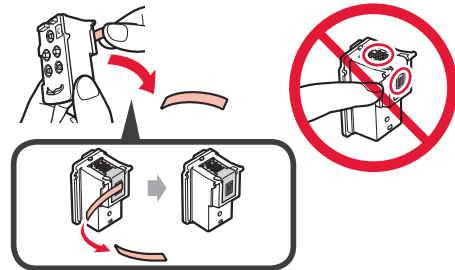

- 4 Inserte el cartucho C (color) en la parte izquierda.

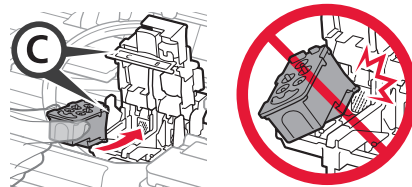

- 5 Repita los pasos del 2 al 4 para insertar el cartucho B (negro) en la parte derecha.

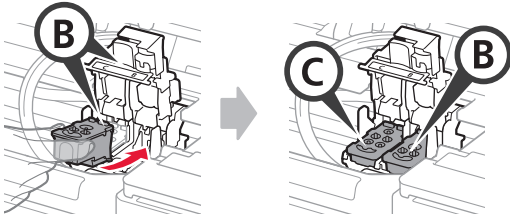

- 6 Cierre la tapa de bloqueo del cartucho y presione hacia abajo.

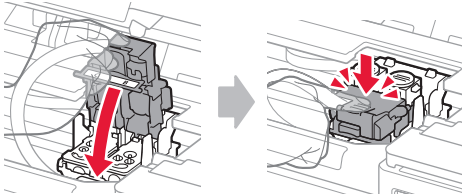

- 7 Presione hacia abajo ambos botones de unión.

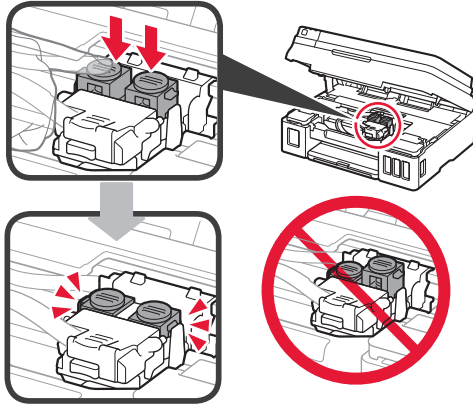

Verter la tinta

- ▶ Puede ver el procedimiento en una película escaneando los códigos QR.



Android



iOS

- 1 Abra la cubierta del depósito de tinta izquierda.

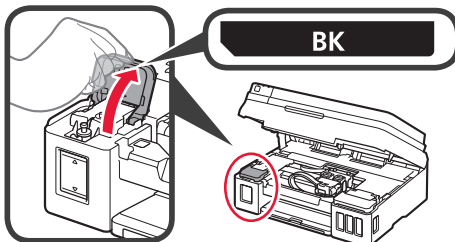

- 2 Sujete y retire la tapa del depósito del depósito de tinta y colóquela en el soporte de tapa del depósito superior.

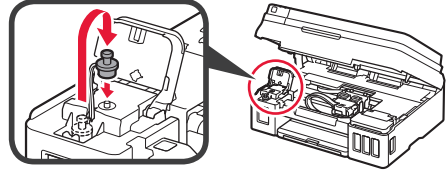

- 3 1 Saque el frasco de tinta BK (negro) del paquete.
2 Sujete el frasco de tinta hacia arriba y retire la tapa del frasco.

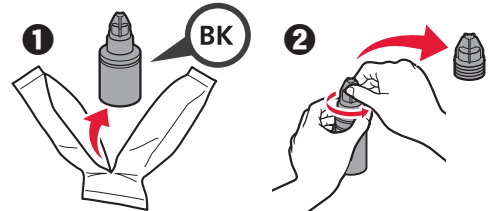

- 4 Inserte el inyector del frasco de tinta en la entrada y coloque el frasco de tinta boca abajo.

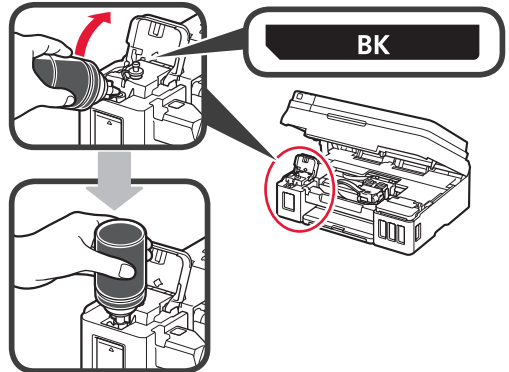

- 5 Vierta toda la tinta en el depósito de tinta.

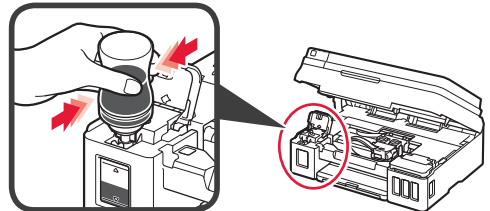

- 6 Cierre la tapa del depósito.

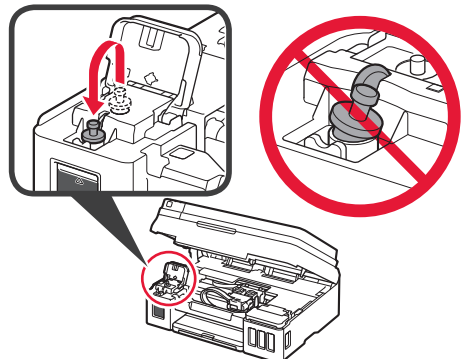

7 Cierre la cubierta del depósito de tinta.

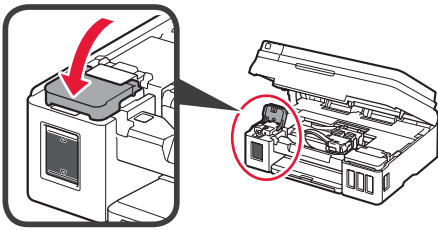

- 8
- 1 Abra la cubierta del depósito de tinta derecha.
 - 2 Repita los pasos del 2 al 6 a verter toda la tinta en los depósitos de tinta correspondientes de la derecha según la etiqueta.
 - 3 Cierre la cubierta del depósito de tinta.

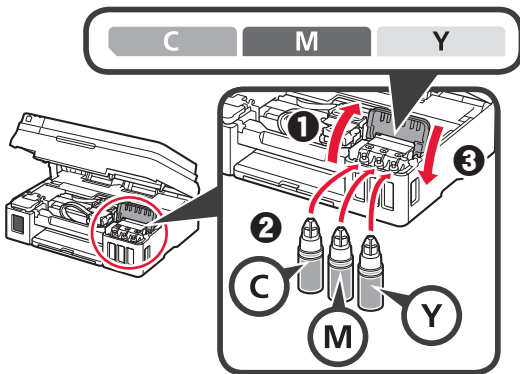

9 Compruebe que toda la tinta de los frascos se vierte en los depósitos de tinta.

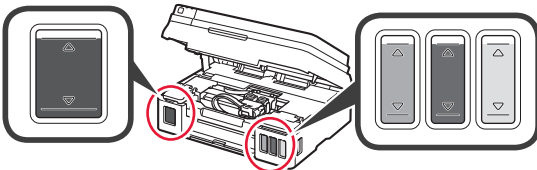

10 Cierre la cubierta/unidad de escaneado.

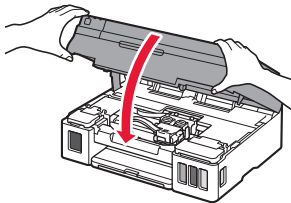

Encender la impresora

- Puede ver el procedimiento en una película escaneando los códigos QR.



Android



iOS

- 1 Conecte el cable de alimentación.
- ⊘ No conecte ningún cable excepto el de alimentación.

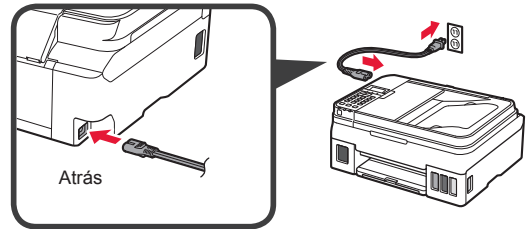

- 2 Pulse el botón **ACTIVADO (ON)**.

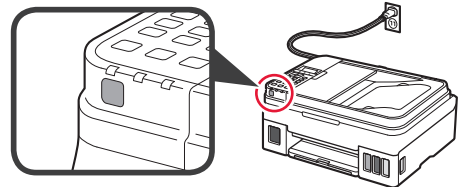

Si aparece un mensaje de error, asegúrese de que los cartuchos están instalados correctamente.

- 3 Utilice el botón ◀ ▶ para seleccionar un idioma y, a continuación, pulse el botón **OK**.

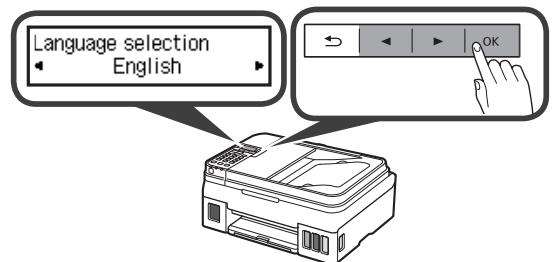

- 4 Si aparece la siguiente pantalla, seleccione su país o región y, a continuación, pulse el botón **OK**.





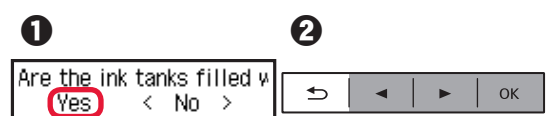



- 5
- 1 Cuando aparezca la siguiente pantalla, asegúrese de haber completado la preparación de la tinta.
 - 2 Seleccione **Sí (Yes)** y, a continuación, pulse el botón **OK**.

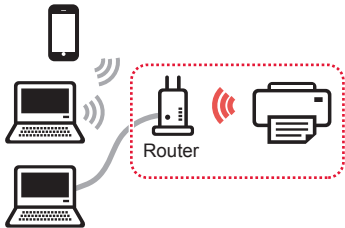

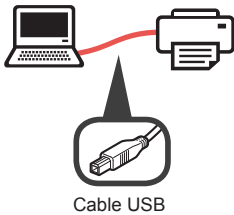
Selección del método de conexión de la impresora

El método de conexión varía en función de cómo usará la impresora. Seleccione un método de conexión de la impresora según la tabla a continuación. En la siguiente descripción, los teléfonos inteligentes y las tabletas se describen en conjunto como teléfonos inteligentes.

Uso de la impresora con su ordenador o con un teléfono inteligente conectado		Uso de la impresora sin conectar otro dispositivo
LAN inalámbrica (Wireless LAN)	USB	No conectar (Do not connect)
<p>Conexión de la impresora a su ordenador o teléfono inteligente mediante un router inalámbrico</p>  <p>Conexión de la impresora a su ordenador o teléfono inteligente directamente, sin un router inalámbrico *</p> 	 <p>Cable USB</p>	  <p>Utilice el botón ◀ o ▶ para seleccionar No conectar (Do not connect) en la pantalla de selección del método de conexión y, a continuación, pulse el botón OK. Siga las instrucciones en pantalla para continuar con la configuración. Espere unos 6 minutos hasta que aparezca la siguiente pantalla. Ha finalizado la configuración.</p> 

* No puede conectar su teléfono inteligente a Internet de forma inalámbrica durante la conexión directa de la impresora con su teléfono inteligente. En tal caso, es posible que tenga cargos en función del contrato con su proveedor de servicios.

* Se puede conectar un máximo de 5 dispositivos directamente a la impresora mediante la conexión LAN inalámbrica.

- 1 Seleccione el método de conexión de la impresora y, a continuación, pulse el botón **OK**.



Siga las instrucciones en pantalla para continuar con la configuración.

Los usuarios que seleccionen USB:

No conecte cables USB hasta que lo indiquen las instrucciones.

- 2 Si aparece la pantalla siguiente, avance a la siguiente página.

- Si selecciona **LAN inalámbrica (Wireless LAN)**:

Adjusting for first use...
See "Getting Started" ani

Start connection setup
See "Getting Started"

- Si selecciona **USB**:

Adjusting for first use...
See "Getting Started" ani

Copy
100% Letter 01

2. Conexión con el ordenador y con el teléfono inteligente o la tableta

Si conecta la impresora a su ordenador y a su teléfono inteligente, conéctela primero al ordenador. **Para conectar la impresora únicamente a su teléfono inteligente, consulte "Conexión con el teléfono inteligente" en la página 6.**

Conexión con el ordenador

Necesitará configurar la conexión de cada ordenador. Complete la configuración desde el paso 1 para cada ordenador.

A continuación, se describen los procedimientos para Windows y Mac OS.

Si usa un ordenador que no utiliza Windows o Mac OS, como Chrome OS, ingrese a "<http://canon.com/ijsetup>" y siga las instrucciones en el sitio web de Canon para configurar su ordenador.

- 1 Seleccione uno de los siguientes pasos, **A** o **B**, para iniciar el archivo de instalación.

A Mac OS Windows

Acceder al sitio web de Canon

- 1 Visite el sitio web de Canon a continuación y haga clic en **Configurar**.

<http://canon.com/ijsetup>



Siga las instrucciones en pantalla para continuar con la configuración.

- 2 Si aparece la siguiente pantalla, haga clic en **Descargar**.

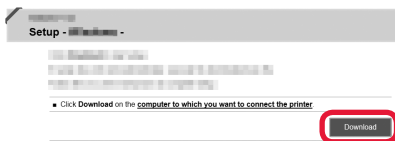

- 3 Ejecute el archivo descargado.

B Windows

Uso del CD de configuración

- 1 Introduzca el CD de configuración en su ordenador.



Cuando utilice Windows 10, Windows 8.1 o Windows 8:

- 2 Haga clic en el **Explorador de archivos (File Explorer)** o en la barra de tareas.
- 3 Seleccione **Este equipo (This PC)** o **Equipo (Computer)** en la parte izquierda de la ventana que se abra.
- 4 Haga doble clic en el icono de CD-ROM situado en la parte derecha de la ventana.

* Si aparece el contenido del CD-ROM, haga doble clic en **MSETUP4.EXE**.

- 2 Haga clic en **Iniciar configuración (Start Setup)**.

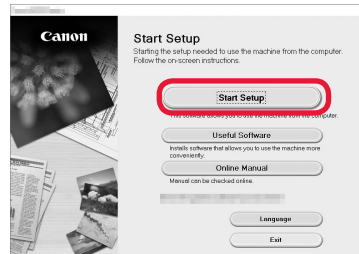

Siga las instrucciones en pantalla para continuar con la configuración.

Puede configurar su teléfono inteligente en el medio de dichos pasos.

En la siguiente pantalla, haga clic en **Instrucciones (Instructions)** para continuar con la configuración de su teléfono inteligente.

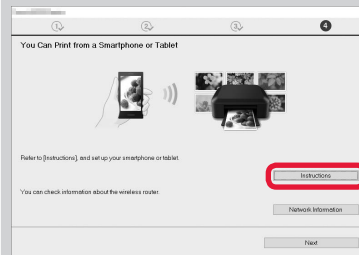

* Según los ajustes, es posible que la pantalla anterior no aparezca. En ese caso, vaya a "Conexión con el teléfono inteligente" en la página 6 cuando haya finalizado con la conexión a su ordenador.

- 3 Si aparece la siguiente pantalla, haga clic en **Salir (Exit)**.

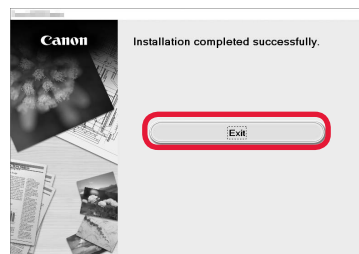

La conexión con su ordenador se ha completado. Ahora puede imprimir desde su ordenador.

Conexión con el teléfono inteligente

Necesitará configurar la conexión para cada teléfono inteligente. Complete la configuración desde el paso 1 para cada teléfono inteligente.

Preparativos

- Active la Wi-Fi en su teléfono inteligente.
- Si dispone de un router inalámbrico, conecte su teléfono inteligente al router.
- * Por cuestiones del funcionamiento, consulte los manuales de su teléfono inteligente y del router inalámbrico o póngase en contacto con los fabricantes.

1 Instale el software de la aplicación Canon PRINT Inkjet/SELPHY en su teléfono inteligente.



iOS : Busque "Canon PRINT" en App Store.

Android : Busque "Canon PRINT" en Google Play.

O acceda al sitio web de Canon escaneando el código QR.



2 Compruebe la pantalla en la impresora.

Cuando el equipo no se utiliza durante 10 minutos, la pantalla se apaga. Para mostrar la pantalla, pulse cualquier botón en el panel de control (excepto el botón **ACTIVADO (ON)**).

1 ¿Aparece la siguiente pantalla?

Adjusting for first use...
See "Getting Started" and

No

Sí (Continúe a **B**.)

2 ¿Aparece el mensaje **Wi-Fi** (la impresora está conectada a la red) en la pantalla que aparece cuando se pulsa el botón **COPIA (COPY)**?

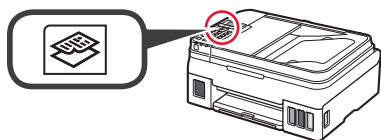

Sí

No (Continúe a **B**.)

Si aparece **Wi-Fi**, la impresora no puede comunicarse mediante una conexión inalámbrica LAN. Para más información, diríjase a "<http://canon.com/ijsetup>" para ver **Preguntas más frecuentes**.

A **iOS** **Android**

1 Puntee el software de la aplicación instalado.



2 Siga las instrucciones en pantalla para registrar la impresora.

3 Asegúrese de que aparezca la siguiente pantalla.



La conexión con su teléfono inteligente se ha completado. Ahora puede imprimir desde su teléfono inteligente.

Para imprimir fotos, cargue papel fotográfico. Continúe en "Cargar el papel" en la página 8.

- B** Los procedimientos a continuación varían en función de iOS o Android. Seleccione su sistema operativo y continúe con el procedimiento correspondiente.

iOS

- 1** Puntee **Ajustes (Settings)** en la pantalla INICIO y luego puntee **Canon_ij_XXXX** en los ajustes de Wi-Fi.

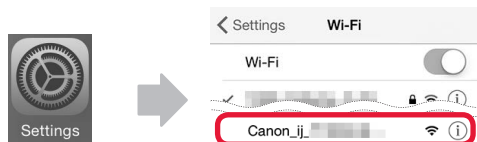

Si **Canon_ij_XXXX** no aparece en la lista, consulte la sección "Preparación de la impresora" a continuación para hacer funcionar la impresora y repita el paso **1**.

- 2** Puntee el software de la aplicación instalado.



- 3** Siga las instrucciones en pantalla para registrar la impresora.

Siga las instrucciones en pantalla para continuar con la configuración.

Si seleccionó **Selec. autom. método con. (recomendado) (Auto Select Conn. Method (recommended))** en la pantalla de selección del método de conexión, se seleccionará el método de conexión adecuado según su ambiente.

- 4** Asegúrese de que aparezca la siguiente pantalla.



La conexión con su teléfono inteligente se ha completado. Ahora puede imprimir desde su teléfono inteligente.

Para imprimir fotos, cargue papel fotográfico. Continúe en "Cargar el papel" en la página 8.

Android

- 1** Puntee el software de la aplicación instalado.



- 2** Siga las instrucciones en pantalla para registrar la impresora.

Si no aparece un mensaje que dice "**Impresora no registrada. ¿Realizar preparación de impresora? (Printer is not registered. Perform printer setup?)**", consulte la sección "Preparación de la impresora" a continuación para hacer funcionar la impresora y espere un momento hasta que aparezca un mensaje.

Siga las instrucciones en pantalla para continuar con la configuración.

El método de conexión adecuado se elige en función de su ambiente.

- 3** Asegúrese de que aparezca la siguiente pantalla.



Preparación de la impresora

- 1** Pulse el botón **Configuración (Setup)** de la impresora.

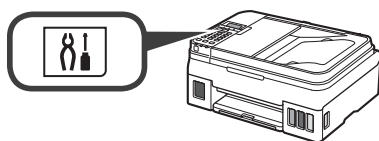

- 2** Utilice el botón ◀ o ▶ para seleccionar **Config. LAN inalám. (Wireless LAN setup)** > **Conex. inalám. fácil (Easy WL connect)** y, a continuación, pulse el botón **OK**.

- 3** Vuelva a la operación en su teléfono inteligente.

Cargar el papel

- 1 Abra el soporte del papel y la extensión del soporte del papel.

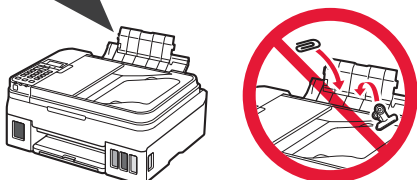
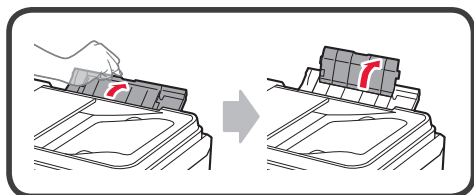

- 2 Deslice la guía del papel derecha hacia el extremo derecho.

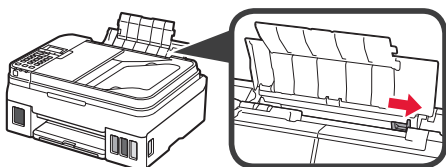

- 3 Inserte varias hojas de papel con la cara de impresión hacia arriba hasta que se detenga.

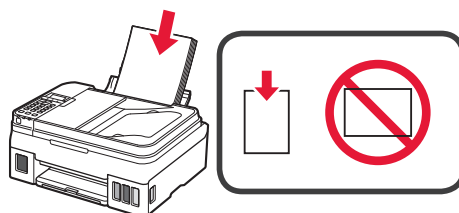

- 4 Deslice la guía de papel derecha para alinearla con el lateral de la pila de papel.

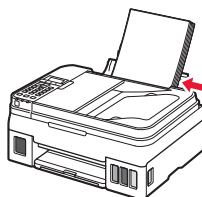

- 5 ❶ Extraiga la bandeja de salida del papel.
❷ Abra la extensión de la bandeja de salida.

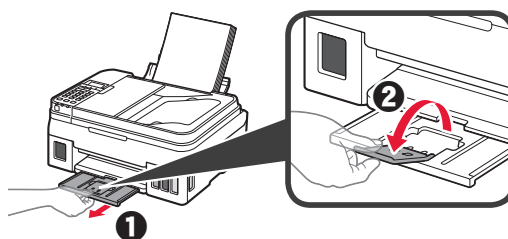

Usar la función de fax

Antes de usar la función de fax, consulte el siguiente manual para configurar la función de fax en la impresora.

■ Configuración del FAX en el Manual en línea

- ❶ Visite el sitio web de Canon indicado a continuación y haga clic en **Configurar**.

<http://canon.com/ijsetup>



Siga las instrucciones en pantalla para continuar con la configuración.

- ❷ Haga clic en **Preparación del fax para su uso**.



■ Configuración del FAX en el Manual básico que está instalado en su equipo.





Visit the Website

Visite o site

Rendez-vous sur le site Web

Acceda al sitio web

<http://canon.com/ijsetup>



Read Online Manual

Ler o Manual On-line

Lire le manuel en ligne

Leer el Manual en línea



Frequently Asked Questions

Perguntas Freqüentes

Foire aux questions

Preguntas más frecuentes