

PHILIPS

BASS+

SHB3075

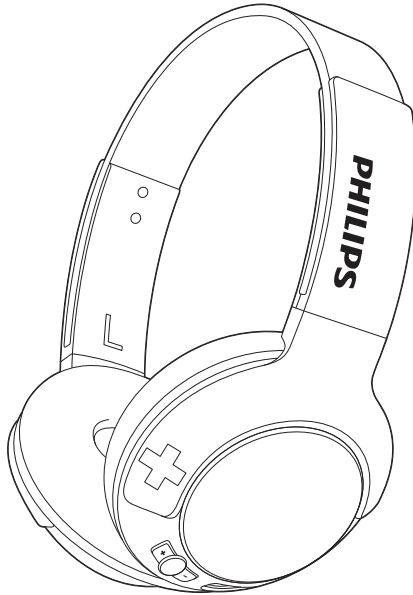

User manual

Register your product and get support at
www.philips.com/support

Contents

1	Important safety instructions	2
	Hearing Safety	2
	General information	2

2	Your Bluetooth wireless headphones	3
	What's in the box	3
	Other devices	3
	Overview of your Bluetooth wireless headphones	3

3	Get started	5
	Charge your headphones	5
	Pair the headphones with your mobile phone	5

4	Use your headphones	6
	Connect the headphones to a Bluetooth device	6
	Manage your calls and music	6
	Wear your headset	7

5	Technical data	8
----------	-----------------------	----------

6	Notice	9
	Declaration of conformity	9
	Disposal of your old product and battery	9
	Compliance with EMF	9
	Trademarks	10

7	Frequently asked questions	11
----------	-----------------------------------	-----------

1 Important safety instructions

Hearing Safety



Danger

- To avoid hearing damage, limit the time you use headphones at high volume and set the volume to a safe level. The louder the volume, the shorter the safe listening time is.

Be sure to observe the following guidelines when using your headset.

- Listen at reasonable volumes for reasonable periods of time.
- Be careful not to adjust the volume continuously upwards as your hearing adapts.
- Do not turn up the volume so high that you can't hear what's around you.
- You should use caution or temporarily discontinue use in potentially hazardous situations.
- Excessive sound pressure from earphones and headphones can cause hearing loss.
- Using headphones with both ears covered while driving is not recommended and may be illegal in some areas while driving.
- For your safety, avoid distractions from music or phone calls while in traffic or other potentially dangerous environments.

General information

To avoid damage or malfunction:

Caution

- Do not expose headphones to excessive heat.
- Do not drop your headphones.
- Headphones shall not be exposed to dripping or splashing.
- Do not allow your headphones to be submerged in water.
- Do not use any cleaning agents containing alcohol, ammonia, benzene, or abrasives.
- If cleaning is required use a soft cloth, if necessary dampened with a minimum amount of water or diluted mild soap, to clean the product.
- The integrated battery shall not be exposed to excessive heat such as sunshine, fire or the like.
- Danger of explosion if battery is incorrectly replaced. Replace only with the same or equivalent type.

About operating and storage temperatures and humidity

- Operate or store in a place where temperature is between -15°C (5°F) and 55°C (131°F) (up to 90% relative humidity).
- Battery life may be shorter in high or low temperature conditions.

2 Your Bluetooth wireless headphones

Congratulations on your purchase, and welcome to Philips! To fully benefit from the support that Philips offers, register your product at www.philips.com/welcome.

With this Philips wireless headphones, you can:

- enjoy convenient wireless handsfree calls;
- enjoy and control wireless music;
- switch between calls and music.

What's in the box

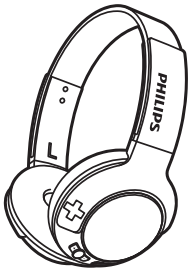

Philips Bluetooth wireless headphones BASS+ On-Ear (SHB3075)

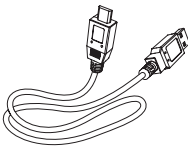

USB charging cable (for charging only)



Quick start guide

Other devices

A mobile phone or device (e.g. notebook, PDA, Bluetooth adapters, MP3 players etc) which supports Bluetooth and is compatible to the headphones (see 'Technical data' on page 8).

Overview of your Bluetooth wireless headphones

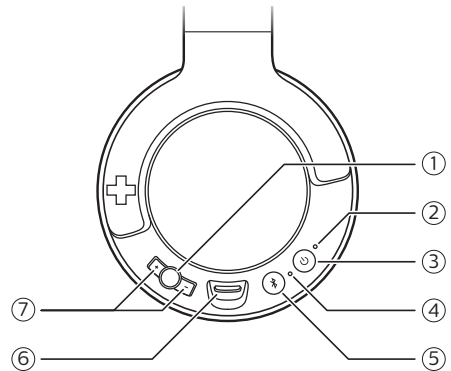

- ① Music/call/track control button
- ② LED indicator
- ③ On/off button
- ④ Microphone

- ⑤  Pairing/Mute button
- ⑥ Micro USB charging slot
- ⑦ +/- Volume control button

3 Get started

Charge your headphones

Note

- Before you use your headphones for the first time, charge the battery for 5 hours for optimum battery capacity and lifetime.
- Use only the original USB charging cable to avoid any damage.
- Finish your call before charging the headphones, as connecting the headphones for charging will power the headphones off.
- You can operate the headphones normally during charging.

Connect the supplied USB charging cable to:

- the micro USB charging slot on the headphones and;
 - the charger/USB port of a computer.
- ↳ LED turns white during charging and turns off when the headphones is fully charged.

Tip

- Normally, a full charge takes 3 hours.

Pair the headphones with your mobile phone

Before you use the headphones with your mobile phone for the first time, pair it with a mobile phone. A successful pairing establishes a unique encrypted link between the headphones and mobile phone. The headphones store the last 8 devices in the memory. If you try to pair more than 8 devices, the

earliest paired device is replaced by the new one.

- 1 Make sure that the headphones are fully charged.
- 2 Press and hold **⏻** for 2 seconds to turn the headphones on.
- 3 Press and hold **⌘** until the blue and white LED flashes alternately.
↳ The headphones remain in pairing mode for 5 minutes.
- 4 Make sure that the mobile phone is turned on and its Bluetooth feature is activated.
- 5 Pair the headphones with the mobile phone. For detailed information, refer to the user manual of your mobile phone.

The following example shows you how to pair the headphones with your mobile phone.

- 1 Activate the Bluetooth feature of your mobile phone, select **BASS+ On-Ear**.
- 2 Enter the headset password "0000" (4 zeros) if prompted. For those mobile phones featuring Bluetooth 3.0 or higher, no need to enter a password.



BASS+ On-Ear

4 Use your headphones

Connect the headphones to a Bluetooth device

- 1 Turn on your mobile phone/Bluetooth device.
- 2 Press and hold  for 2 seconds to turn the headphones on.
 - ↳ The blue LED flashes.
 - ↳ The headphones are reconnected to the last connected mobile phone/Bluetooth device automatically. If the last one is not available, the headphones try to reconnect to the second last connected device.

Tip



- If you turn on the mobile phone/Bluetooth device or activate the Bluetooth feature after turning on the headphones, you have to reconnect the headphones and mobile phone/Bluetooth device manually.

Note



- If the headphones fail to connect to any Bluetooth device within range in 5 minutes, it will switch off automatically to save the battery life.

Manage your calls and music



On/off

Task	Button	Operation
Turn the headphones on.		Press and hold for 2 seconds.
Turn the headphones off.		Press and hold for 6 seconds. ↳ The white LED is on and fades out.

Music control

Task	Button	Operation
Play or pause music.		Press once.
Adjust volume.	+/-	Press once/press and hold.
Skip forward.		Press twice.
Skip backward.		Press and hold for 2 seconds.

Call control

Task	Button	Operation
Pick up/hang up a call.		Press once. ↳ 1 beep.
Reject an incoming call.		Press and hold for 2 seconds. ↳ 1 beep.
Switch caller during a call.		Press and hold for 2 seconds.

Mute/unmute the microphone in a call.		Press once. ↳ 1 beep.
---------------------------------------	--	--------------------------

Voice control

Task	Button	Operation
Siri/Google Now.		Press and hold for 2 seconds.

Other headphones indicator status

Headphones status	Indicator
The headphones are connected to a Bluetooth device, while the headphones in standby mode or while you are listening to music.	The blue LED flashes for every 8 seconds.
The headphones are ready for pairing.	The LED flashes blue and white alternately.
The headphones are on but not connected to a Bluetooth device.	The blue LED flashes quickly. If no connection can be made, the headphones will turn itself off within 5 minutes.
Low battery level.	The white LED flashes 3 times for every 150 seconds until it is out of power.
Battery is fully charged.	The white LED is off.

Wear your headset

Adjust the headband to fit your head.

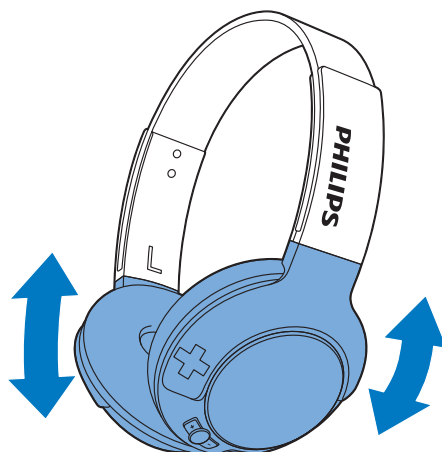

5 Technical data

- Music time: 12 hours
- Talk time: 12 hours
- Standby time: 166 hours
- Normal time for a full charge: 3 hours
- Rechargeable lithium polymer battery (240 mAh)
- Bluetooth 4.1, Bluetooth mono support (Headset Profile - HSP, Hands-Free Profile - HFP), Bluetooth stereo supported (Advanced Audio Distribution Profile - A2DP; Audio Video Remote Control Profile - AVRCP)
- Frequency range: 2.402-2.480GHz
- Transmitter power: <20dBm
- Operating range: Up to 10 meters (33 feet)
- Digital echo & noise reduction
- Auto power off



Note

- Specifications are subject to change without notice.

6 Notice

Declaration of conformity

Hereby, Gibson Innovations declares that this product is in compliance with the essential requirements and other relevant provisions of Directive 2014/53/EU. You can find the Declaration of Conformity on www.p4c.philips.com.

Disposal of your old product and battery



Your product is designed and manufactured with high quality materials and components, which can be recycled and reused.



This symbol on a product means that the product is covered by European Directive 2012/19/EU.



This symbol means that the product contains a built-in rechargeable battery covered by European Directive 2013/56/EU which cannot be disposed of with normal household waste. We strongly advise you to take your product to an official collection point or a Philips service centre to have a professional remove the rechargeable battery. Inform yourself about the local separate collection system for electrical and

electronic products and rechargeable batteries. Follow local rules and never dispose of the product and rechargeable batteries with normal household waste. Correct disposal of old products and rechargeable batteries helps prevent negative consequences for the environment and human health.

Remove the integrated battery

Note

- Make sure the headphones are disconnected from the USB charging cable before removing the battery.

If there is no collection/recycling system for electronic products in your country, you can protect the environment by removing and recycling the battery before disposing the headphones.

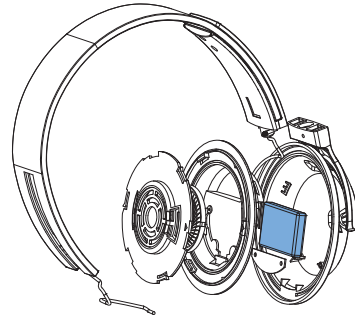

Compliance with EMF

This product complies with all applicable standards and regulations regarding exposure to electromagnetic fields.

Environmental information

All unnecessary packaging has been omitted. We have tried to make the packaging easy to separate into three materials: cardboard (box), polystyrene foam (buffer) and polyethylene (bags, protective foam sheet.)

Your system consists of materials which can be recycled and reused if disassembled by a specialized company. Please observe the local regulations regarding the disposal of packaging materials, exhausted batteries and old equipment.

Trademarks

Bluetooth

The Bluetooth® word mark and logos are registered trademarks owned by Bluetooth SIG, Inc. and any use of such marks by Gibson Innovations Limited is under license.

Siri

Siri is a trademark of Apple Inc., registered in the U.S. and other countries.

Google

Google and the Google Logo are registered trademarks of Google Inc.

7 Frequently asked questions

My Bluetooth headphones do not switch on.

The battery level is low. Charge the headphones.

I cannot pair my Bluetooth headphones with a mobile phone.

The Bluetooth is disabled. Enable the Bluetooth feature on your mobile phone and turn on the mobile phone before you turn on the headphones.

Pairing does not work.

Make sure the headphones are in pairing mode.

- Follow the steps described in this user manual (see ‘Pair the headphones with your mobile phone’ on page 5).
- Make sure that the LED light flashes blue and white alternately before you release . Do not stop holding the button if you see the blue LED only.

The mobile phone cannot find the headphones.

- The headphones may be connected to a previously paired device. Turn off the connected device or move it out of range.
- Pairing may have been reset or the headphones have been previously paired with another device. Pair the headphones with the mobile phone again as described in the user manual (see ‘Pair the headphones with your mobile phone’ on page 5).

My Bluetooth headphones are connected to a Bluetooth stereo enabled mobile phone, but music only plays on the mobile phone speaker. Refer to the user manual of your mobile phone. Select to listen to music through the headphones.

The audio quality is poor and crackling noise can be heard.

The Bluetooth device is out of range.

Reduce the distance between your headphones and Bluetooth device, or remove obstacles between them.

The audio quality is poor when streaming from the mobile phone is very slow, or audio streaming does not work at all.

Make sure your mobile phone not only supports (mono) HSP/HFP but also supports A2DP (see ‘Technical data’ on page 8).

I hear but cannot control music on my Bluetooth device (e.g. play/pause/skip forward/backward).

Make sure the Bluetooth audio source supports AVRCP (see ‘Technical data’ on page 8).

For further support, visit www.philips.com/support.



2017 © Gibson Innovations Limited. All rights reserved.
This product has been manufactured by, and is sold under the responsibility
of Gibson Innovations Ltd., and Gibson Innovations Ltd. is the warrantor in
relation to this product.
Philips and the Philips' Shield Emblem are registered
trademarks of Koninklijke Philips N.V.

UM_SHB3075_00_EN_V1.0
WK1704

