

SAMSUNG

FULL MANUAL

UBD-M9000

Imagine the possibilities

Thank you for purchasing this Samsung product.

To receive more complete service, please register
your product at www.samsung.com/register

Safety Information

Warning

CAUTION

RISK OF ELECTRIC SHOCK DO NOT OPEN

CAUTION : TO REDUCE THE RISK OF ELECTRIC SHOCK, DO NOT REMOVE THE COVER (OR BACK). THERE ARE NO USER SERVICEABLE PARTS INSIDE. REFER ALL SERVICING TO QUALIFIED PERSONNEL.



This symbol indicates that high voltage is present inside. It is dangerous to make any kind of contact with any internal part of this product.



This symbol indicates that this product has included important literature concerning operation and maintenance.



Class II product : This symbol indicates that it does not require a safety connection to electrical earth (ground).



AC voltage : This symbol indicates that the rated voltage marked with the symbol is AC voltage.



DC voltage : This symbol indicates that the rated voltage marked with the symbol is DC voltage.



Caution, Consult instructions for use : This symbol instructs the user to consult the user manual for further safety related information.

- The slots and openings in the cabinet and in the back or bottom are provided for necessary ventilation. To ensure reliable operation of this apparatus, and to protect it from overheating, these slots and openings must never be blocked or covered.
 - Do not place this apparatus in a confined space, such as a bookcase, or built-in cabinet, unless proper ventilation is provided.
 - Do not place this apparatus near or over a radiator or heat register, or where it is exposed to direct sunlight.
 - Do not place vessels (vases etc.) containing water on this apparatus. A water spill can cause a fire or electric shock.
- Do not expose this apparatus to rain or place it near water (near a bathtub, washbowl, kitchen sink, or pool, etc.). If this apparatus accidentally gets wet, unplug it and contact an authorised dealer immediately.
- This apparatus uses batteries. In your community, there might be environmental regulations that require you to dispose of these batteries properly. Please contact your local authorities for disposal or recycling information.

- Do not overload wall outlets, extension cords or adaptors beyond their capacity, since this can result in fire or electric shock.
- Route power-supply cords so that they are not likely to be walked on or pinched by items placed on or against them. Pay particular attention to cords at the plug end, at wall outlets, and the point where they exit from the apparatus.
- To protect this apparatus from a lightning storm, or when it is left unattended and unused for long periods of time, unplug it from the wall outlet and disconnect the antenna or cable system. This will prevent damage to the set due to lightning and power line surges.
- Before connecting the AC power cord to the DC adaptor outlet, make sure the voltage designation of the DC adaptor corresponds to the local electrical supply.
- Never insert anything metallic into the open parts of this apparatus. Doing so may create a danger of electric shock.
- To avoid electric shock, never touch the inside of this apparatus. Only a qualified technician should open this apparatus.
- Make sure to plug the power cord in until it is firmly seated. When unplugging the power cord from a wall outlet, always pull on the power cord's plug. Never unplug by pulling on the power cord. Do not touch the power cord with wet hands.
- If this apparatus does not operate normally - in particular, if there are any unusual sounds or smells coming from it - unplug it immediately and contact an authorised dealer or service Centre.
- Maintenance of Cabinet.
 - Before connecting other components to this product, be sure to turn them off.
 - If you move your product suddenly from a cold place to a warm place, condensation may occur on the operating parts and lens and cause abnormal disc playback. If this occurs, unplug the product, wait for two hours, and then connect the plug to the power outlet. Then, insert the disc, and try to play back again.
- Be sure to pull the power plug out of the outlet if the product is to remain unused or if you are leaving the house for an extended period of time (especially when children, elderly, or disabled people will be left alone in the house).
 - Accumulated dust can cause an electric shock, an electric leakage, or a fire by causing the power cord to generate sparks and heat or the insulation to deteriorate.
- Contact an authorised service Centre for information if you intend to install your product in a location with heavy dust, high or low temperatures, high humidity, chemical substances, or where it will operate 24 hours a day such as in an airport, a train station, etc. Failing to do so may lead to serious damage of your product.
- Use only a properly grounded plug and wall outlet.
 - An improper ground may cause electric shock or equipment damage. (Class 1 Equipment only.)
- To turn this apparatus off completely, you must disconnect it from the wall outlet. Consequently, the wall outlet and power plug must be readily accessible at all times.

Safety Information

- Do not allow children to hang on the product.
- Store the accessories (battery, etc.) in a location safely out of the reach of children.
- Do not install the product in an unstable location such as a shaky self, a slanted floor, or a location exposed to vibration.
- Do not drop or strike the product. If the product is damaged, disconnect the power cord and contact a Samsung service centre.
- To clean this apparatus, unplug the power cord from the wall outlet and wipe the product using a soft, dry cloth. Do not use any chemicals such as wax, benzene, alcohol, thinners, insecticide, air fresheners, lubricants, or detergent. These chemicals can damage the appearance of the product or erase the printing on the product.
- Do not expose this apparatus to dripping or splashing. Do not put objects filled with liquids, such as vases on the apparatus.
- Do not dispose of batteries in a fire.
- Do not plug multiple electric devices into the same wall socket. Overloading a socket can cause it to overheat, resulting in a fire.
- There is danger of an explosion if you replace the batteries used in the remote with the wrong type of battery. Replace only with the same or equivalent type.
- **WARNING - TO PREVENT THE SPREAD OF FIRE, KEEP CANDLES AND OTHER ITEMS WITH OPEN FLAMES AWAY FROM THIS PRODUCT AT ALL TIMES.**
- **WARNING**
 - To reduce the risk of fire or electric shock, do not expose this appliance to rain or moisture.



CLASS 1 LASER product

This Compact Disc player is classified as a CLASS 1 LASER product. Use of controls, adjustments or performance of procedures other than those specified herein may result in hazardous radiation exposure.

CAUTION :

- THIS PRODUCT USES AN INVISIBLE LASER BEAM WHICH CAN CAUSE HAZARDOUS RADIATION EXPOSURE IF DIRECTED. BE SURE TO OPERATE PRODUCT CORRECTLY AS INSTRUCTED.
- THIS PRODUCT UTILIZES A LASER. USE OF CONTROLS OR ADJUSTMENTS OR PERFORMANCE OF PROCEDURES OTHER THAN THOSE SPECIFIED HEREIN MAY RESULT IN HAZARDOUS RADIATION EXPOSURE. DO NOT OPEN COVERS AND DO NOT REPAIR YOURSELF. REFER SERVICING TO QUALIFIED PERSONNEL.

This product satisfies CE regulations when shielded cables and connectors are used to connect the unit to other equipment. To prevent electromagnetic interference with electric appliances, such as radios and televisions, use shielded cables and connectors for connections.

CLASS 1	LASER PRODUCT
KLASSE 1	LASER PRODUKT
LUOKAN 1	LASER LAITE
KLASS 1	LASER APPARAT
PRODUCTO	LÁSER CLASE 1

| NOTE |

- ▶ If the Region number of an Ultra HD Blu-ray Disc/Blu-ray Disc/DVD does not correspond to the Region number of this product, the product cannot play the disc.

IMPORTANT NOTE

The mains lead on this equipment is supplied with a molded plug incorporating a fuse. The value of the fuse is indicated on the pin face of the plug. If it requires replacing, a fuse approved to BS1362 of the same rating must be used.

Never use the plug with the fuse cover omitted if the cover is detachable. If a replacement fuse cover is required, it must be of the same colour as the pin face of the plug. Replacement covers are available from your dealer.

If the fitted plug is not suitable for the power points in your house or the cable is not long enough to reach a power point, you should obtain a suitable safety approved extension lead or consult your dealer for assistance.

However, if there is no alternative to cutting off the plug, remove the fuse and then safely dispose of the plug. Do not connect the plug to a mains jack, as there is a risk of shock hazard from the bared flexible cord.

To disconnect the apparatus from the mains, the plug must be pulled out from the mains socket, therefore the mains plug shall be readily operable. The product unit accompanying this user manual is licenced under certain intellectual property rights of certain third parties.

Contents

SAFETY INFORMATION

- 2 Warning

GETTING STARTED

- 8 Accessories
- 9 Front Panel
- 9 Rear Panel
- 10 Remote Control
- 10 Tour of the Remote Control

CONNECTIONS

- 12 Connecting to a TV
- 14 Connecting to an Audio Device
- 14 Method 1 Connecting to an HDMI (HDR) compatible Soundbar / AV receiver that supports pass through
- 15 Method 2 Connecting to a Soundbar / AV receiver with a Digital Optical Cable
- 15 Connecting to a Mobile Device
- 16 Connecting to a Network Router
- 16 Wireless Network
- 16 Wired Network

SETTINGS

- 17 The Initial Settings Procedure
- 17 The Home Screen
- 18 Accessing the Settings Screen
- 18 Buttons on the Remote Control Used for the Settings Menu
- 19 Settings Menu Functions
- 19 Picture
- 19 Sound
- 20 General
- 22 Support
- 23 Networks and the Internet
- 23 Configuring Your Network Connection
- 26 Upgrading Software
- 27 Update Now
- 27 Auto update

MEDIA PLAY

- 28 Playing Commercial Discs
- 28 Disc Storage & Management
- 28 Playing Photos, Videos, and Music (Multimedia)
- 28 Playing Media Content Saved on a USB Device
- 29 Playing Media Content Saved in a Computer
- 29 Playing a Disc with User Recorded Content
- 30 Controlling Video Playback
 - 30 Buttons on the Remote Control used for Video Playback
 - 31 Using the On-screen Menu during Playback of a Video
 - 33 Using the Sort By & Options Menus
- 33 Controlling Music Playback
 - 33 Buttons on the Remote Control used for Music Playback
 - 34 Using the Options Menu During Playback
 - 34 Using the Sort By & Options Menus on a File Screen
 - 34 Repeating Tracks on an Audio CD
 - 34 Shuffling Tracks on an Audio CD
 - 34 Creating a Playlist from an Audio CD
- 35 Playing Photo Contents
 - 35 Using the On-screen Menu during Playback of a Photo File
 - 36 Using the Sort By & Options Menus

NETWORK SERVICES

- 37 Creating a Samsung Account
- 38 Before Using Apps
- 38 Using Apps
 - 38 The Apps Screen at a Glance
 - 39 Starting an Application
- 40 Using the Internet
 - 41 The Web Browser window at a Glance
 - 43 Using the Browser Menu
- 44 Linking Your Internet Service Accounts to the Product
- 44 BD-LIVE™

APPENDIX

- 45 Additional Information
 - 45 Notes
 - 47 Resolution according to the contents type
 - 48 Digital Output Selection
- 49 Troubleshooting
- 52 Disc and Format Compatibility
 - 52 Disc types and contents your product can play
 - 52 Disc types your product cannot play
 - 53 Region Code
- 53 Logos of Discs the product can play
 - 54 Supported Formats
- 58 Compliance and Compatibility Notice
- 59 Copy Protection
- 59 Network Service Disclaimer
- 60 Licences
- 62 Specifications

Getting Started

Accessories

Check for the supplied accessories shown below.

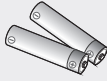

Batteries (AA Size)



Power Cable

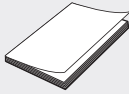

User Manual

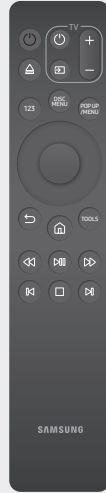

Remote Control

Front Panel

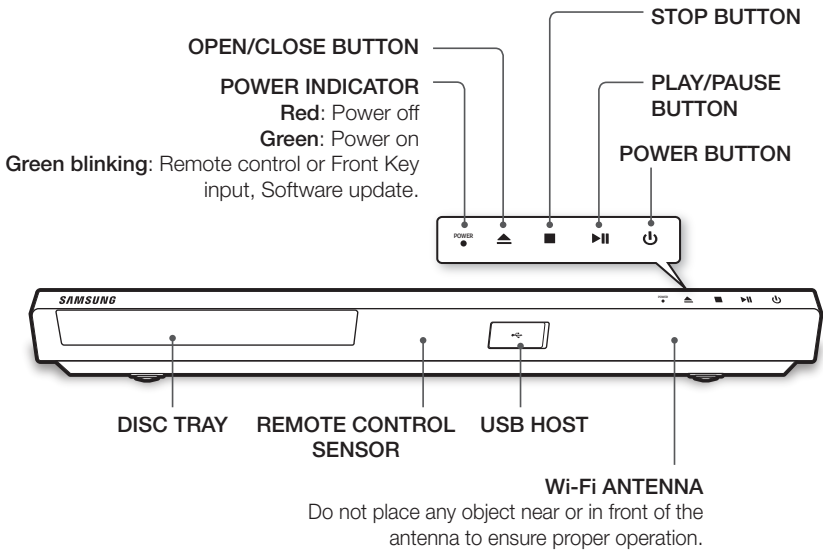

| NOTES |

- ▶ To upgrade the product's software through the **USB HOST** jack, you must use a USB memory stick.
- ▶ When the product displays an Ultra HD Blu-ray or standard Blu-ray Disc's menu, you cannot start the movie by pressing the **▶||** button on the remote control or player. To play the movie, you must select Play Movie or Start in the disc's menu, and then press the **● (OK)** button on the remote control.

Rear Panel

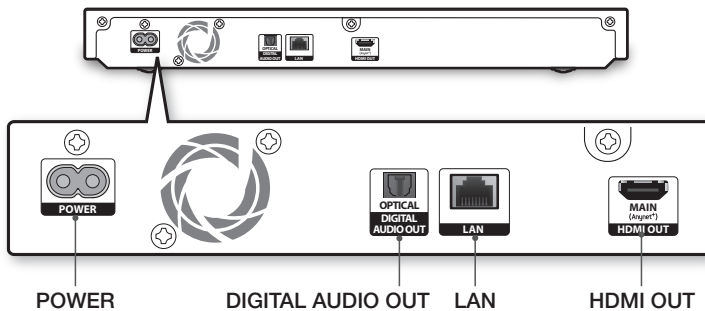

| NOTE |

- ▶ To use the **Anynet+ (HDMI-CEC)** function, connect an HDMI cable to the HDMI terminal.

Getting Started

Remote Control

| NOTE |

▶ Previous BD-Player remote controls may not be compatible with this player.

Tour of the Remote Control

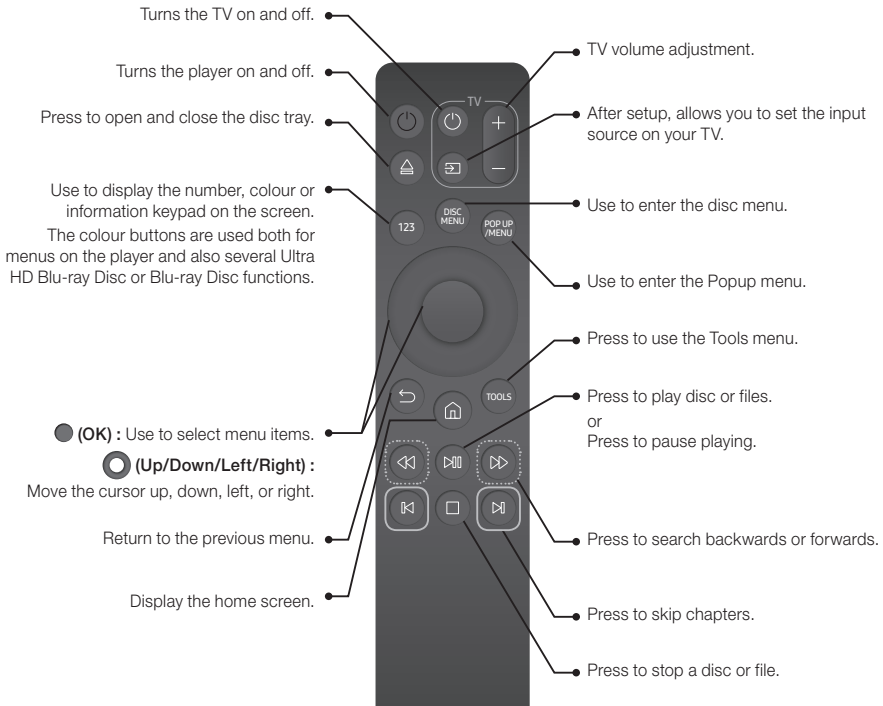



Inserting Batteries (AA Battery x2)

Slide the battery cover in the direction of the arrow until it is completely removed.

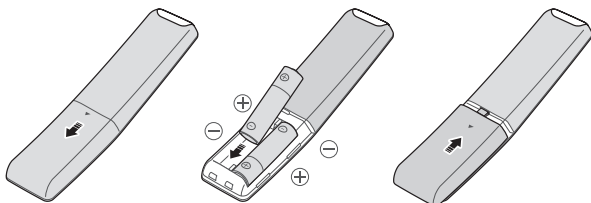
Insert 2 AA batteries (1.5V) in the correct +/- polarity configuration. Slide the battery cover back into position.



Using Remote Control Buttons to Enter TV Codes

1. Press and hold the  (TV Power) button.
2. While holding the  (TV Power) button, press the buttons on the remote that correspond to a two-digit TV Code from the list below. Use the illustration to the right as a guide.



For example: To enter **01**, press the **TOOLS** button and then press the **123** button. Note that some TV brands have more than one 2-digit code. If the first code does not work, try the next.

TV Control Codes

Brand	Codes
SAMSUNG	01, 02, 03, 04, 05, 06, 07, 08, 09
AIWA	82
ANAM	10, 11, 12, 13, 14, 15, 16, 17, 18
BANG & OLUFSEN	57
BLAUPUNKT	71
BRANDT	73
BRIONVEGA	57
CGE	52
CONTINENTAL EDISON	75
DAEWOO	19, 20, 23, 24, 25, 26, 27, 28, 29, 30, 31, 32, 33, 34
EMERSON	64
FERGUSON	73
FINLUX	06, 49, 57
FORMENTI	57
FUJITSU	84
GRADIENTE	70
GRUNDIG	49, 52, 71
HITACHI	60, 72, 73, 75
IMPERIAL	52
JVC	61, 79
LG	06, 19, 20, 21, 22, 78

Brand	Codes
LOEWE	06, 69
LOEWE OPTA	06, 57
MAGNAVOX	40
METZ	57
MITSUBISHI	06, 48, 62, 65
MIVAR	52, 77
NEC	83
NEWSAN	68
NOBLEX	66
NOKIA	74
NORDMENDE	72, 73, 75
PANASONIC	13, 53, 54, 74, 75
PHILIPS	06, 56, 57
PHONOLA	72, 73, 75
PIONEER	58, 59, 73, 74
RADIOLA	06, 56
RADIOMARELLI	57
RCA	45, 46
REX	74
SABA	57, 72, 73, 74, 75
SALORA	74
SANYO	41, 42, 43, 44, 48
SCHNEIDER	06
SELECO	74
SHARP	36, 37, 38, 39, 48
SIEMENS	71
SINGER	57
SINUDYNE	57
SONY	35, 48
TELEAVA	73
TELEFUNKEN	67, 73, 75, 76
THOMSON	72, 73, 75
THOMSON ASIA	80, 81
TOSHIBA	47, 48, 49, 50, 51, 52
WEGA	57
YOKO	06
ZENITH	63

Connections

Connecting to a TV

Connect an HDMI cable (not supplied) from the **HDMI OUT** jack on the back of the product to the **HDMI IN** jack on your TV.

- Do not connect the power cord to the wall outlet until you have made all the other connections.
- When you change the connections, turn off all devices before you start.

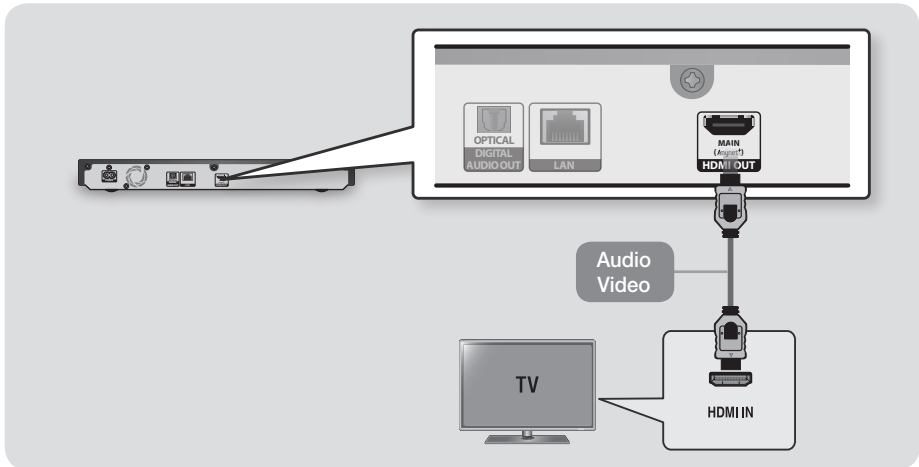

| NOTES |

- ▶ Optimum picture quality is automatically obtained (**HDMI UHD Color - On**) when the player is connected to a Samsung UHD TV.
- ▶ To use the **Anynet+ (HDMI-CEC)** function, connect the HDMI cable to the HDMI terminal.
- ▶ If you use an HDMI-to-DVI cable to connect to your display device, you must also connect the **DIGITAL AUDIO OUT** on the product to an audio system to hear audio.
- ▶ An HDMI to HDMI cable outputs digital video and audio, so you don't need to connect an audio cable.
- ▶ Depending on your TV, certain HDMI output resolutions may not work. Please refer to the user manual of your TV.
- ▶ When you connect the product to your TV using an HDMI cable or to a new TV, and then turn it on for the first time, the product automatically sets the HDMI output resolution to the highest supported by the TV.
- ▶ A long HDMI cable may cause screen noise. If this occurs, set **HDMI Deep Colour** to **Off** in the menu.
- ▶ To view video in the HDMI 720p, 1080p or 2160p output mode, you must use a high speed (category 2) HDMI cable.

- ▶ HDMI outputs only a pure digital signal to the TV.
If your TV does not support HDCP (High-bandwidth Digital Content Protection), random noise appears on the screen.
- ▶ If your TV does not support HDCP (High-bandwidth Digital Content Protection) version 2.2, some of Ultra HD Blu-ray titles may play at the 1080p resolution.
 - This operation is regulated by the Ultra HD Blu-ray Disc content's copyright protection standard according to the producer's intention to avoid infringing the copyright.
 - To view video from a Ultra HD Blu-ray Disc at its original resolution, connect the HDMI cable to an HDMI input port on the TV that supports HDCP 2.2.
 - To check whether the TV supports HDCP 2.2, check the HDMI port on the back of the TV or refer to the TV user's manual.
- ▶ This product supports the HDR function. (HDR: High Dynamic Range is a technique used to reproduce a greater dynamic range of luminosity than is possible with conventional imaging devices.)
 - To take advantage of the HDR function, you need HDR content, a TV supporting HDR, and a high-speed HDMI cable.
 - Connect the player to an HDMI input terminal on the TV that supports the HDR function using the high speed HDMI cable.
 - Use the TV's menu to activate the HDR related function. For further information, refer to the TV's user manual.

Connections

Connecting to an Audio Device

You can connect this product to an audio system using the methods illustrated below.

- Do not connect the power cord to the wall outlet until you have made all the other connections.
- When you change the connections, turn off all devices before you start.

Method 1 Connecting to an HDMI (HDR) compatible Soundbar / AV receiver that supports pass through

- Connect an HDMI cable (not supplied) from the **HDMI OUT** jack on the back of the product to the **HDMI IN** jack on your receiver. Connect another HDMI cable from the **HDMI OUT** jack of your receiver to the **HDMI IN** jack of your TV.
- Your receiver must have 4K pass through capability to pass through UHD video content.

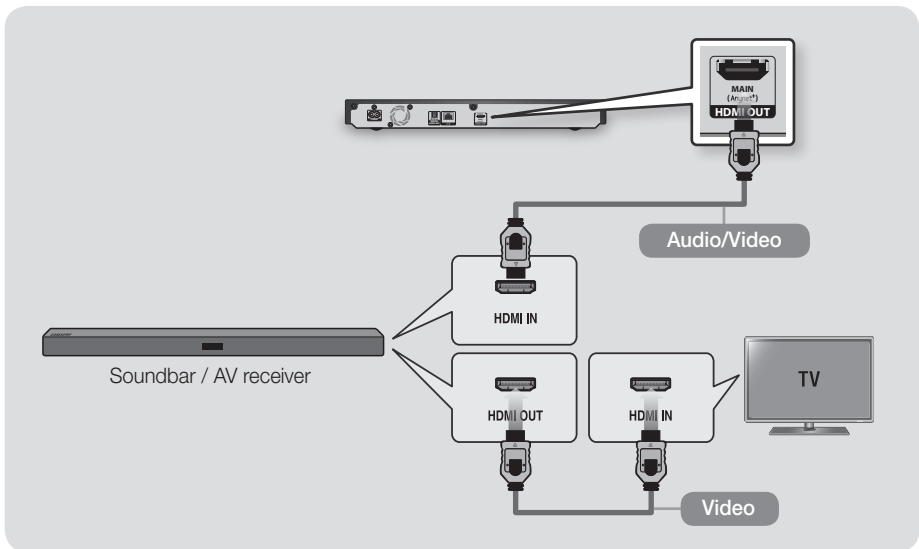

| NOTES |

- ▶ You must set up **HDMI UHD Color** to enable HDR on your Samsung TV manually if your player is not directly connected to the TV. (For example, through a Soundbar or AV receiver.)
- ▶ If AAC2.0 was applied to the contents that you want to play, the contents may not be displayed on the screen depending on the AV receiver connected. For more detailed information, refer to the user manual of your AV receiver.

Method 2 Connecting to a Soundbar / AV receiver with a Digital Optical Cable

- Using a digital Optical cable (not supplied), connect the **DIGITAL AUDIO OUT** jack on the product to the **DIGITAL AUDIO IN** jack of the receiver.
- You will hear sound only through the front two speakers with **Digital Output** set to **PCM**.

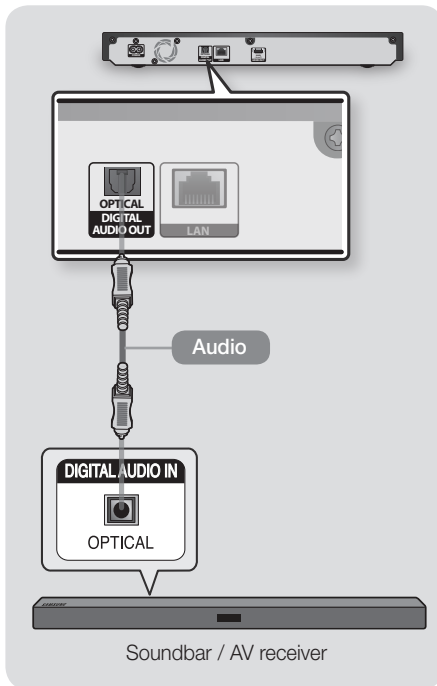

| NOTE |

- ▶ If you connect a receiver to the player's **DIGITAL AUDIO OUT** port, the receiver's audio reproduction may not synchronise with that of the TV.

Connecting to a Mobile Device

The **Smart View** function lets you view the screen of your mobile device or Android tablet on the TV that you have connected to the player.



1. On the Home screen, select  (**Source**), and then press the **Up** button.
2. Select **Connection Guide**, and then press the **OK** button.
3. Launch **Smart View** on your mobile device.
4. On your mobile device, find the name of the player in the list of available devices, and then select it.
5. The TV displays a connecting message (for example, Connecting to Android_92gb..) and then displays the connected message.
6. In a few moments, the screen of your device appears on the TV screen.
7. To stop **Smart View**, press  (**Return**) on the remote control, or exit **Smart View**.

| NOTES |

- ▶ When you are using the **Smart View** function, video stuttering or audio dropouts may occur, depending on your environment.
- ▶ Bluetooth transmissions can interfere with the Smart View signal. Before using the **Smart View** function, we strongly recommend that you turn off the Bluetooth function on your mobile device or smart device (tablet, etc.).
- ▶ If your wireless router (Wi-Fi) uses a DFS channel, you cannot use this function. Contact your Internet service provider for details.

Connections

Connecting to a Network Router

You can connect your product to your network router using one of the methods illustrated below. The connection can be wireless or wired.

Wireless Network

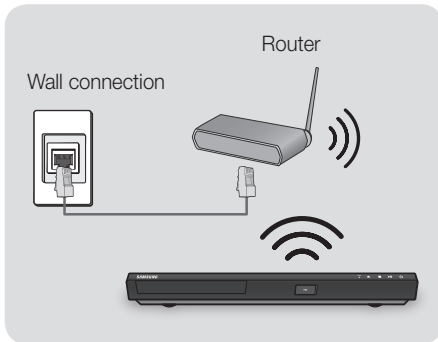

| NOTES |

- ▶ If your wireless router supports DHCP, this product can use a DHCP or static IP address to connect to the wireless network.
- ▶ Set your wireless router to Infrastructure mode. Ad-hoc mode is not supported.
- ▶ The product supports only the following wireless security key protocols:
 - WEP (OPEN/SHARED), WPA-PSK (TKIP/AES), WPA2-PSK (TKIP/AES)
- ▶ Select a channel on the wireless router that is not currently being used. If the channel set for the wireless router is currently being used by another device nearby, it will result in interference and communication failure.
- ▶ If you select the Pure High-throughput (Greenfield) 802.11n mode and set the Encryption type on your router to WEP, TKIP or TKIP-AES (WPS2Mixed), the product will not support a connection in compliance with new Wi-Fi certification specifications.

- ▶ Wireless LAN, by its nature, may cause interference, depending on the operating conditions (router performance, distance, obstacles, interference by other radio devices, etc).

Wired Network

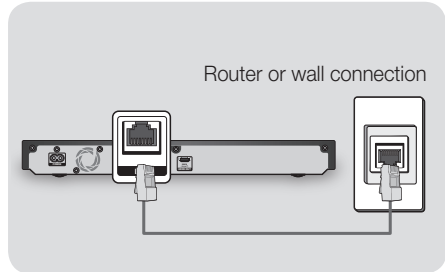

| NOTES |

- ▶ Your router or your Internet Service Provider's policies may prevent the product from accessing Samsung's software update server. If this occurs, contact your Internet Service Provider (ISP) for more information.
- ▶ DSL users, please use a router to make a network connection.
- ▶ Use Cat 7 (*STP Type) cable for the connection. (* Shielded Twist Pair)

The Initial Settings Procedure

- The Home screen will not appear if you do not configure the initial settings.
- The OSD (On Screen Display) may change in this product after you upgrade the software version.
- The access steps may differ depending on the menu you selected.

After you have connected the product to your TV, turn on the TV and product. When you turn on the product the first time, the product's Initial Settings screen appears on the TV. The Initial Settings procedure lets you set the On Screen Display (OSD) and menu languages, the aspect ratio (screen size), and network configuration, and connect the player to the Internet. Follow the directions on the screen.

| NOTES |

- ▶ If you skip Network Setup during the Initial Settings procedure, you can configure your network settings later. See "Configuring Your Network Connection" on pages 23~26 for instructions.
- ▶ If you want to display the Initial Settings screen again and make changes, select **Settings** > **General** > **Start Setup** in the Home screen or select **Settings** > **Support** > **Reset**. (See page 22)
- ▶ If you want to use the **Anynet+ (HDMI-CEC)** function, please follow the instructions below.
 - 1) Connect the product to an **Anynet+ (HDMI-CEC)**-compliant Samsung TV using an HDMI Cable.
 - 2) Set the **Anynet+ (HDMI-CEC)** feature to **On** in both the TV and the product.
 - 3) Set the player to the Initial Settings Procedure.

The Home Screen

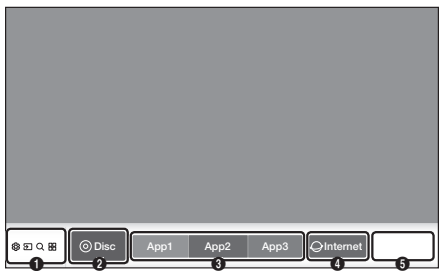

- (Functions)**
- **Settings** : Opens the product's menu. In the menu, you can set various functions to suit your personal preferences. When you move focus to the **Settings** menu, the **Quick Settings** menu appears. Use the menu to customise various options, such as **Picture Mode**, **Fit Screen Size**, **Sound Output**, **Audio Output Format**, and **Network**.
 - **Source** : Select an inserted disc or USB storage device, a connected network device, or **Smart View**.
 - **Search** : Lets you search for content in Apps and YouTube by entering corresponding search words.
 - **APPS** : Access various for pay or free-of-charge applications.
-
- 2 Disc** : Displays the selected source.
-
- 3 Downloaded Apps** : Displays downloaded apps. Apps displayed here can be deleted, edited, or rearranged, if necessary.
-
- 4** You can access the Internet.
-
- 5** Use the **Add to Home** option to add frequently used menu items to the bottom of the Home screen.

Settings

| NOTE |

- ▶ If you leave the player in the stop mode for more than 5 minutes without using it, a screen saver will appear on your TV. If the player is left in the screen saver mode for more than 15 minutes, the power will automatically turn off.

Accessing the Settings Screen

1. Select **Settings** on the Home screen, and then press ● (OK) button. The **Settings** screen appears.

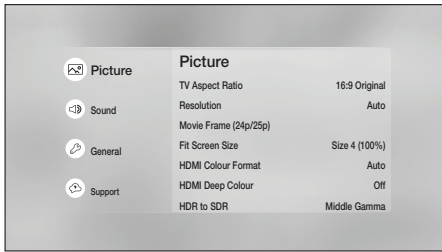

2. To access the menus, sub-menus, and options on the **Settings** screen, please refer to the remote control illustration in the next column.

Buttons on the Remote Control Used for the Settings Menu

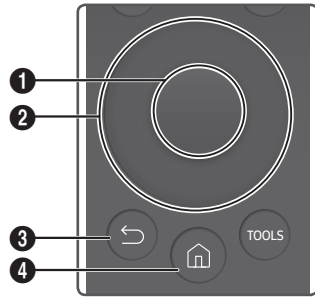

1	● (OK) button : Press to activate the currently selected item or confirm a setting.
2	○ (Up/Down/Left/Right) buttons : Press to move the cursor or select an item.
3	↶ (Return) button : Press to return to the previous menu.
4	🏠 (Home) button : Press to move to the Home screen.

Detailed Function Information

Each Settings function, menu item, and individual option is explained in detail on-screen. To view an explanation, use the **Up/Down/Left/Right** buttons to select the function, menu item, or option. The explanation will usually appear on the right side of the screen. A short description of each Settings function starts on the next page. Additional information on some of the functions is also in the Appendix of this manual.

Settings Menu Functions

Picture

TV Aspect Ratio

Lets you adjust the output of the product to the screen size and screen format of your TV.

Resolution

Set the output resolution of the HDMI video signal to **Auto**, **2160p**, **1080p**, **720p**, or **576p/480p**.

The number indicates the number of lines of video per frame. Generally, the more lines, the higher the quality.

Movie Frame (24p/25p)

If the product is connected to a 24p/25p compatible TV, setting the **Movie Frame (24p/25p)** feature to **Auto** lets the product adjust its HDMI output to 24 frames per second automatically for improved picture quality.

- You can enjoy the **Movie Frame (24p/25p)** feature only on a TV supporting this frame rate.
- The **Movie Frame (24p/25p)** feature becomes active only if the player is playing 24 frame rate contents.
- **Movie Frame** is only available when the product is in the HDMI 1080p or 2160p output resolution modes.

Fit Screen Size

Set the screen to the optimal size.

HDMI Colour Format

Lets you set the colour space format for the HDMI output so that it matches the capabilities of the connected device (TV, monitor, etc). The screen goes black momentarily after you have selected a format.

HDMI Deep Colour

Lets you set the product to output HDMI video with Deep Colour. Deep Colour provides more accurate colour reproduction with greater colour depth.

HDR to SDR

Lets you set the gamma level when watching video converted from HDR to SDR.

Sound

Sound Output

Lets you select which speakers are active. Select an audio device from the list.

Wi-Fi Speaker Surround Setup

Connect the Samsung Soundbar to wireless speakers via Wi-Fi to configure a stereo or surround sound system.

| NOTE |

- ▶ If your wireless router (Wi-Fi) uses a DFS channel, you cannot make a surround connection using Wi-Fi. Contact your Internet service provider for details.

Audio Output Format

Lets you select the digital audio output format (HDMI) that is suitable for your AV Receiver.

| NOTE |

- ▶ If the player is connected to an ATMOS Soundbar with **Auto** on, the sound option automatically switches to Bitstream.

Audio Output Format (Optical)

Lets you select the digital audio output format (Optical) that is suitable for your AV Receiver.

Settings

PCM Downsampling

Lets you choose to have 96kHz PCM signals downsampled to 48kHz before they are outputted to an amplifier. Turn on **PCM Downsampling** if the amplifier or receiver is not compatible with 96 kHz signal.

Dynamic Range Control

Lets you apply dynamic range control to Dolby Digital, Dolby Digital Plus, and Dolby TrueHD audio.

- ✓ **Auto** : Automatically controls the dynamic range of Dolby TrueHD audio, based on information in the Dolby TrueHD soundtrack. Also turns dynamic range control on for Dolby Digital and Dolby Digital Plus.
- ✓ **Off** : Leaves the dynamic range uncompressed, letting you hear the original sound.
- ✓ **On** : Turns dynamic range control on for all three Dolby formats. Quieter sounds are made louder and the volume of loud sounds is reduced.

Downmixing Mode

Lets you select the multi-channel downmix method that is compatible with your stereo system. You can choose to have the product downmix to normal stereo or to surround compatible stereo.

DTS Neo:6 Mode

You can enjoy multichannel sound via HDMI output from a 2 channel audio source.

Audio Sync

In some cases, when the product is connected to a digital TV, the audio signal may not synchronise with the video signal. If this occurs, adjust the audio delay time to match the video signal.

- You can set the audio delay time between 0 ms and 240 ms. Adjust it to the optimal setting.

| NOTES |

- ▶ The audio delay time you specify may not be exact depending on the content played.
- ▶ This function can be used when playing Optical Disc format contents.

General

Network

- ✓ **Network Status** : Lets you check the current network and Internet status.
- ✓ **Network Settings** : Configure the network connection so you can enjoy various features such as Internet services, and perform Software Updates.
- ✓ **BD-Live Settings** : Set various BD-Live functions. BD-Live allows you to access extra features available on some Ultra HD Blu-ray Discs or Blu-ray Discs if you are connected to the Internet.
 - **BD-Live Internet Connection** : Lets you fully allow, partly allow, or prohibit a BD-Live Internet connection.
 - **BD Data Management** : Manage BD data downloaded from a BD-Live service or Ultra HD Blu-ray Disc/Blu-ray Disc.

| NOTE |

- ▶ To use **BD-Live Settings** function, connect the USB storage device first, and then select it from the **BD Data Management** menu.

System Manager

You can change the options listed below to match your preferences.

- ✓ **Language** : You can select the language you prefer for the On-screen menu, disc menu, audio, subtitles, etc.
 - The language you select for the disc menu, disc audio, or subtitles will only appear if it is supported on the disc.
- ✓ **Device Name** : Lets you input a name for the product that will identify it on your network.
- ✓ **View Notifications** : You can view the list of event messages generated by the player.
- ✓ **Samsung Account** : Create and manage your own Samsung account. To create a Samsung account select : **Settings > General > System Manager > Samsung Account > Create Account**. Some of the Smart Hub services are paid services.
- ✓ **Security** : The default security PIN is 0000. Enter the default PIN to access the security function if you haven't created your own PIN. After you have accessed the security function for the first time, change the PIN using the **Change PIN** function.
 - **BD Parental Rating** : Prevents playback of Ultra HD Blu-ray Discs or Blu-ray Discs with a rating equal to or above a specific age rating you have set unless you enter the PIN.
 - **DVD Parental Rating** : Prevents playback of DVDs with a rating above a specific numerical rating you have set unless you enter the PIN.
 - **Change PIN** : Change the 4-digit PIN used to access security functions.

▪ If you forget your PIN:

1. Remove any disc or USB storage device.
2. Press and hold the **▲ (Open/Close)** button on the top panel for 5 seconds or more. The initialisation message appears on the screen, and the power will turn off automatically. When you turn your product on again, all the settings will be reset.

- ✓ **WoL/WoWLAN** : Turn on or turn off the WOL (Wake on LAN) or WoWLAN (Wake on Wireless LAN) function.

External Device Manager

- ✓ **Anynet+ (HDMI-CEC)** : Anynet+ is a convenient function that offers linked operations with other Samsung product that have the Anynet+ feature and lets you control those products with one Samsung TV remote. To operate this function, you must connect this product to an Anynet+ Samsung TV using an HDMI cable.
- ✓ **DivX® Video On Demand** : View DivX® VOD Registration Codes to purchase and play DivX® VOD contents.
- ✓ **Keyboard Manager** : Set the language and type for a keyboard connected via USB.

| NOTES |

- ▶ You can use the keyboard only when a QWERTY keyboard screen or window appears in the Web Browser.
- ▶ Some USB HID keyboards and mice may not be compatible with this player.
- ▶ Some HID keyboard keys may not work.
- ▶ Wired USB keyboards are not supported.
- ▶ Some applications may not be supported.
- ▶ If a wireless HID Keyboard does not operate because of interference, move the keyboard closer to the player.

Settings

✓ **Device Connection Manager** : Lets you control which devices on your network, such as mobile device and tablets, can share content with this player.

▪ **Allowing a Connection with a Mobile Device**

To play the media content stored on a mobile device, you must allow the connection between the mobile device and the product.

Navigate to **Settings > General > External Device Manager > Device Connection Manager > Device list**. The mobile devices connected to the same network as the product are listed.

1. Select content to play from the mobile device. (Refer to "Connecting to a Mobile Device" on page 15.)

| NOTE |

- ▶ Smart View can be referred to as Screen Mirroring or Miracast, depending on the mobile device manufacturer.
- 2. A notification message appears at the top of the TV screen when the mobile device attempts to connect to the player. Select **Allow**. You can only play media files from devices that have been allowed to connect to the product.

| NOTE |

- ▶ If you do not want to display a notification message when a mobile device attempts to connect, set **Device Connection Manager > Access Notification** to **Off**.
- 3. Play content from the mobile device.
- 4. The TV connected to the player displays content files saved on the mobile device.

| NOTE |

- ▶ If you switch the mobile device screen during playback, connection to the product is terminated.

Accessibility

- ✓ **High Contrast** : Set up the background and font in high contrast colour in Apps (Smart Hub) and Multimedia.
- ✓ **Enlarge** : Set whether to enlarge the highlighted item in Apps (Smart Hub) and Multimedia.

Start Setup

Lets you re-run the Initial Settings procedure.

Support

Software Update

This menu allows you to upgrade the product's software for performance improvements or additional services.

Reset Smart Hub

Resets all Smart Hub settings to their default settings. To use, you must enter the security PIN. The default security PIN is 0000.

Reset

Resets all settings to their default settings except for the network and Smart Hub settings, and then starts the Setup function. To use, you must enter the security PIN. The default security PIN is 0000.

Remote Management

When activated, lets Samsung Call Centre agents diagnose and fix problems with this player remotely. Requires an active Internet connection.

| NOTES |

- ▶ Remote Management service might not be available in some countries.
- ▶ To use Remote Management:
 - 1) Call the Samsung Contact Centre and ask for remote support.
 - 2) Open the player's menu on your TV and go to the Support section.
 - 3) Select **Remote Management**, and then read and agree to the service agreements. When the PIN screen appears, provide the PIN number to the agent.
 - 4) The agent accesses this player.

About This Device

Provides contact information for assistance with your product.

Terms & Policy

You must review and agree to both the App Terms & Conditions and the privacy policy to use App services.

Networks and the Internet

When you connect this product to a network, you can use network based applications and functions such as Smart Hub and BD-LIVE, and upgrade the product's software through the network connection. For more information about accessing and using Internet services, see the Network Services chapter of this manual on pages 37~44. Instructions for configuring the network connection start below.

Configuring Your Network Connection

Before you begin, determine if your IP address is static or dynamic. (Most are dynamic.) If it is dynamic, and you have a wired or wireless network, we recommend using the Automatic configuration procedures described below.

If you are connecting to a wired network, connect the product to your router using a LAN cable before you start the configuration procedure. If you are connecting to a wireless network, disconnect any wired network connections before you begin.

| NOTE |

- ▶ Use **Quick Settings > Network** on the Home screen to simplify the network configuration process.

To begin configuring your network connection, follow these steps:

Wired Network

□ Wired - Automatic

1. In the Home screen, select **Settings**, and then press the ● (OK) button.
2. Select **General**, and then press the ● (OK) button.
3. Select **Network**, and then press the ● (OK) button.
4. Select **Network Settings**, and then press the ● (OK) button.
5. Select **Wired** in the **Network Type** screen, and then press the ● (OK) button.

Settings

6. The product detects the wired connection, verifies the network connection, and then connects to the network.
7. Press the ● (OK) button.

❑ Wired - Manual

If you have a static IP address or the Automatic procedure does not work, you'll need to set the **Network Settings** values manually.

Follow Steps 1 and 3 in Wired - Automatic, and then follow these steps:

1. Select **Network Status**. The product searches for a network, and then displays the connection failed message.
2. On the bottom of the screen, select **IP Settings**, and then press the ● (OK) button. The **IP Settings** screen appears.
3. Select the **IP Settings** field, and then press the ● (OK) button.
4. Select **Enter manually** in the **IP Settings** field, and then press the ● (OK) button.
5. Select a parameter to enter (**IP Address**, for example), and then press the ● (OK) button. Use the **Up/Down** buttons on the remote control to enter the numbers for the parameter. Use the **Left/Right** buttons on the remote control to move from entry field to entry field within a parameter. When done with one parameter, press the ● (OK) button.
6. Press the **Up** or **Down** button to move to another parameter, and then enter the numbers for that parameter following the instructions in Step 5.
7. Repeat Steps 5 and 6 until you have filled in all parameters.

| NOTE |

- ▶ You can get the Network parameters from your Internet provider.
8. When finished entering all the parameters, select **OK**, and then press the ● (OK) button. The product verifies the network connection and then connects to the network.

Wireless Network

You can set up a wireless network connection in four ways:

- Wireless Automatic
- Wireless Manual
- WPS(PBC)
- WPS(PIN)

When you configure the wireless network connection, any wireless network devices currently connected through the product or, if applicable, the product's current wired connection, will be disconnected.

❑ Wireless - Automatic

1. In the Home screen, select **Settings**, and then press the ● (OK) button.
2. Select **General**, and then press the ● (OK) button.
3. Select **Network**, and then press the ● (OK) button.
4. Select **Network Settings**, and then press the ● (OK) button.
5. Select **Wireless** in the **Network Type** screen, and then press the ● (OK) button.

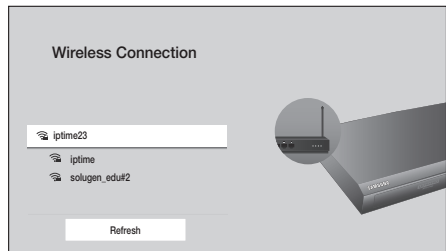

6. Select the desired network, and then press the ● (OK) button.

| NOTE |

- ▶ Alternatively, select **Add Network** at the bottom of the wireless network list to establish a connection. This method can be used when you know the SSID (name) of the wireless router.

- On the Security screen, enter your network's Security Code or Pass Phrase.
Enter letters by selecting a letter with an arrow button, and then pressing ● (OK) button.

| NOTE |

- To view the password as you enter it, use the arrow buttons to select **Show Password** on the right side, and then press ● (OK) button.
- When finished, select **Done** and then press the ● (OK) button. The product verifies the network connection and then connects to the network.
 - When verification is complete, select **OK**, and then press the ● (OK) button.

| NOTE |

- You should be able to find the Security Code or Pass Phrase on one of the set up screens you used to set up your router or modem.

□ Wireless - Manual

If you have a static IP address or the Automatic procedure does not work, you'll need to set the **Network Settings** values manually.

- Follow the directions in Wireless - Automatic through Step 6.
- The product searches for a network, and then displays the connection failed message.
- On the bottom of the screen, select **IP Settings**, and then press the ● (OK) button. The **IP Settings** screen appears.
- Select the **IP Settings** field, and then press the ● (OK) button.
- Select **Enter manually** in the **IP Settings** field, and then press the ● (OK) button.
- Select a parameter to enter (**IP Address**, for example), and then press the ● (OK) button. Use the **Left/Right** buttons on the remote control to enter the numbers for the parameter.
Use the **Left/Right/● (OK)** buttons on the remote control to move from entry field to entry field within a parameter. When done with one parameter, select the **Done**.

- Press the **Up** or **Down** button to move to another parameter, and then enter the numbers for that parameter following the instructions in Step 6.
- Repeat Steps 6 and 7 until you have filled in all parameters.

| NOTE |

- You can get the Network parameters from your Internet provider.
- When finished, select **OK**, and then press the ● (OK) button. The Security Screen appears.
 - On the Security screen, enter your network's Security Code or Pass Phrase. Enter letters by selecting a letter with the **Up/Down/Left/Right** buttons, and then press the ● (OK) button.
 - When finished, select **Done** at the right of the screen, and then press the ● (OK) button. The product verifies the network connection and then connects to the network.
 - After the product verifies the network, select **OK**, and then press the ● (OK) button.

□ WPS(PBC)

- In the Home screen, select **Settings**, and then press the ● (OK) button.
- Select **General**, and then press the ● (OK) button.
- Select **Network**, and then press the ● (OK) button.
- Select **Network Settings**, and then press the ● (OK) button.
- Select **Wireless** in the **Network Type** screen, and then press the ● (OK) button. The product searches for and then displays a list of the available networks.
- Press the **Down** button on your remote, and then press the ● (OK) button to select **Use WPS**. The "Press the WPS or PBC button on your wireless router within the next two minutes." message appears.

Settings

7. Press the WPS or PBC button on your router within two minutes. Your product automatically acquires all the network settings values it needs and connects to your network.

□ WPS(PIN)

Before you begin, open the router's setup menu on your PC and access the screen with the **WPS PIN** entry field.

1. In the Home screen, select **Settings**, and then press the ● (OK) button.
2. Select **General**, and then press the ● (OK) button.
3. Select **Network**, and then press the ● (OK) button.
4. Select **Network Settings**, and then press the ● (OK) button.
5. Select **Wireless** in the **Network Type** screen, and then press the ● (OK) button. The product searches for and then displays a list of the available networks.
6. Select the desired network, and then press the ● (OK) button.
7. Select the **WPS(PIN)**, and then press the ● (OK) button. The PIN pop-up appears.
8. Enter the PIN into the **WPS PIN** entry field in the router's Set Up screen, and then save the screen.

| NOTES |

- ▶ Contact the manufacturer of the router for instructions explaining how to access the route's set up screens or refer to the router's user's manual.
- ▶ For a WPS connection, set your wireless router's security encryption method to AES. WPS connections do not support WEP security encryption.

Upgrading Software

This menu allows you to upgrade the product's software for performance improvements or additional services.

- Never turn the product off or back on manually during the update process.

1. In the Home screen, select **Settings**, and then press the ● (OK) button.
2. Select **Support**, and then press the ● (OK) button.
3. Select **Software Update**, and then press the ● (OK) button.
4. To download update software and update now, select **Update Now**, and then press the ● (OK) button.
5. To let the product download update software automatically when available, select **Auto update**, and then press the ● (OK) button. See "Auto update" on page 27 for details.

| NOTES |

- ▶ The upgrade is complete when the product turns off, and then turns on again by itself.
- ▶ Samsung Electronics takes no legal responsibility for any product malfunction caused by an unstable Internet connection or consumer negligence during a Software Update.
- ▶ If you want to cancel the upgrade while the upgrade software is downloading, press the ● (OK) button.

Update Now

1. Select **Support > Software Update > Update Now**.
2. An online update function downloads and installs the update software directly from the Internet.
 - This option requires an Internet connection.

| NOTES |

- ▶ When the system update is done, check the software details in the Product Information section of the Contact Samsung screen.
- ▶ Do not turn off the product during the Software Update. It may cause the product to malfunction.

Auto update

You can set the **Auto update** function so that the product downloads new upgrade software when it is in Auto update mode.

This allows the product to download upgrade software automatically, when you are not using it.

1. Press the **Up/Down** buttons to select **Auto update**, and then press the **● (OK)** button.
2. The function turns on or off each time the **● (OK)** button is pressed.

| NOTE |

- ▶ To use the **Auto update** function, your product must be connected to the Internet.

Update by USB

To upgrade by USB, follow these steps:

1. Visit Samsung's website on a computer and download the update package to a USB device.
2. Save the update package in the USB device's top-level folder.
 - Otherwise, the product will not be able to locate the update package.
3. Connect the USB device with the update package to the product.
4. Select **Support > Software Update > Update Now**.
5. The software is updated using the update package on the USB device.

| NOTES |

- ▶ There should be no disc in the product when you upgrade the software using the USB jack.
- ▶ When the system upgrade is done, check the software details in the Product Information section of the Contact Samsung screen.
- ▶ Do not turn off the product during the Software Update. It may cause the product to malfunction.
- ▶ Software Updates using the USB jack must be performed with a USB flash memory stick only.

Media Play

Your Ultra HD Blu-ray Player can play content located on Ultra HD Blu-ray/Blu-ray/DVD/CD discs, USB devices, PCs, and on the Web. To play content located on your PC, you must connect the PC and the product to your network.

Playing Commercial Discs

1. Press the **▲** button to open the disc tray.
2. Place a disc gently into the disc tray with the disc's label facing up.

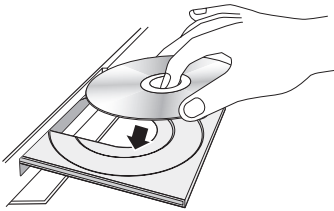

3. Press the **▲** button to close the disc tray. Playback starts automatically.
4. If playback does not start automatically, press the **🏠 (Home)** button, select **Play disc** of the Home screen, and then press the **● (OK)** button on the remote.

Disc Storage & Management

- Holding Discs
 - Fingerprints or scratches on a disc may reduce sound and picture quality or cause skipping.
 - Avoid touching the surface of a disc where data has been recorded.
 - Hold the disc by the edges so that fingerprints will not get on the surface.
 - Do not stick paper or tape on the disc.



- Cleaning Discs

- If you get fingerprints or dirt on a disc, clean it with a mild detergent diluted in water and wipe with a soft cloth.
- When cleaning, wipe gently from the inside to the outside of the disc.



- Disc Storage

- Do not keep in direct sunlight.
- Keep in a cool ventilated area.
- Keep in a clean protective jacket and store vertically.

Playing Photos, Videos, and Music (Multimedia)

You can play media content saved on a USB device, or computer on the product.

| NOTES |

- ▶ You cannot play media content if the content or the storage device is not supported by the product.
- ▶ Backup important files before connecting a USB device. Samsung is not responsible for damaged or lost files.

Playing Media Content Saved on a USB Device

1. Connect your USB device to the product.
2. Press the **🏠 (Home)** button. Select **📁 (Source)**, and then **USB Storage**. The folders and files in the USB device are listed.
3. Select the media content you want to play from the list. The media content plays.
4. To exit, press the **■ (Stop)** button or **↶ (Return)** button.

| NOTE |

- ▶ When connected to a USB device, the screen displays a message at the top. To view content files on the USB device, select **Browse**.

Playing Media Content Saved in a Computer

You can play media content on the product that is stored on a computer connected to the same network as the product.

| NOTES |

- ▶ To play content on a computer, make sure that home network mode is enabled on the computer.
 - ▶ The content shared by a computer may not play depending on the encoding type and file format of the content. In addition, some functions may not be available.
 - ▶ The media content may not play smoothly depending on the network status. If the content does not play smoothly, transfer the content to a USB device, connect the USB device to the player, and then play the content from the USB device.
1. Connect your PC and the player to the same network.
 2. Press the **Home** button. Select **Source**, and then **User's PC**. The folders and files in your PC are listed.
 3. Select the media content you want to play from the list. The media content plays.
 4. To exit, press the **Stop** button or **Return** button.

| NOTE |

- ▶ Playing UHD BD content may require a network connection. Depending on the network environment and the status of the Contents Server (Studio), playback may not be successful.

Playing a Disc with User Recorded Content

You can play multimedia files you have recorded on Blu-ray, DVD, or CD discs.

1. Place a user recorded disc into the disc tray with the disc's label facing up, and then close the tray.
2. Press the **Home** button. Select **Source**, and then **Disc**. The folders and files in the disc are listed.

| NOTE |

- ▶ Even though the product will display folders for all content types, it will only display files of the Content Type you selected in the **Filter By** menu. For example, if you selected **Music**, you will only be able to see music files. You can change this selection by returning to the **Filter By** menu.
3. A screen appears listing the contents of the disc. Depending on how the contents are arranged, you will see either folders, individual files, or both.
 4. If necessary, use the **Up/Down/Left/Right** buttons to select a folder, and then press the **OK** button.
 5. Use the **Up/Down/Left/Right** buttons to select a file to view or play, and then press the **OK** button.
 6. Press the **Return** button one or more times to exit a current screen, exit a folder, or to return to the Home screen.
 7. Go to pages 30~36 for instructions that explain how to control playback of videos, music, and pictures on a disc.

Controlling Video Playback

You can control the playback of video content located on a Disc, USB, or PC. Depending on the disc or contents, some of the functions described in this manual may not be available.

Buttons on the Remote Control used for Video Playback

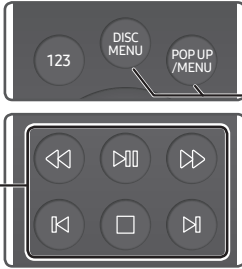

■ To use the disc menu, popup menu, or title list

DISC MENU button	During playback, press this button to display the Disc menu.
POP UP /MENU button	During playback, press this button to display the Popup menu.

■ Playback related buttons

The product does not play sound in Search, or Step mode.

- To return to normal speed playback, press the ►|| button.

► button	Starts playback. When a disc is playing, push to pause playback. Push again to restart.
■ button	Stops playback.
Fast Motion Play	During playback, press the ◀◀ or ▶▶ button. Each time you press the ◀◀ or ▶▶ button, the playback speed will change.
Slow Motion Play	In pause mode, press the ▶▶ button. Each time you press the ▶▶ button, the playback speed will change.
Skip Motion Play	During playback, press the ◀◀ or ▶▶ button. Each time you press the ◀◀ or ▶▶ button, the disc moves to the previous or next chapter or file.

Using the On-screen Menu during Playback of a Video

Use the **Up/Down/Left/Right** buttons to select each function and then press the **● (OK)** button.

Displaying optional menus

When playing a disc: Press **TOOLS** on the remote control.

When playing a video file: Press **● (OK)** on the remote control, and then select  on the screen.

| NOTE |

▶ Available optional menus differ by disc or file format. Refer to the table below.

Optional Menu	Description	Menu Availability	
		Disc	File
Information	Lets you view a video's information.	○	○
Play from the beginning	Select to return to the beginning of the movie, and then press the ● (OK) button.	○	
Select Scene	<ul style="list-style-type: none"> - Search Titles : If there is more than one movie on the disc or device, select to start a different title. <ol style="list-style-type: none"> 1. Select Search Titles, and then press the ● (OK) button. 2. Use the Up/Down buttons to select a title, and then press the ● (OK) button. - Chapter Search : Select to play the chapter of your choice. <ol style="list-style-type: none"> 1. Select Chapter Search, and then press the ● (OK) button. 2. Use the Up/Down buttons to select a chapter, and then press the ● (OK) button. - Search Time Bar : Select to play the movie from a selected time point. <ol style="list-style-type: none"> 1. Select Search Time Bar, and then press the ● (OK) button. 2. Using the Left/Right buttons, enter the time point you want to go to. 	○	

Media Play

Optional Menu	Description	Menu Availability	
		Disc	File
Select Scene	<p> NOTES </p> <ul style="list-style-type: none"> ▶ You can also use the Left/Right buttons to advance or rewind the movie. The movie advances or rewinds one minute each time you press the Left/Right buttons. ▶ If the index information in the file is damaged or the file does not support indexing, you will not be able to use the Select Scene function. ▶ If you play files on a network device after you have connected the player to a computer on your network, Select Scene may not work. ▶ During playback of a video file, use the Up button on the remote control to jump to specific scenes. 	○	
Repeat Mode	Lets you repeat a title, chapter, or specific section.	○	
Picture Mode	<p>Lets you set the picture mode.</p> <ul style="list-style-type: none"> - Dynamic : Increases sharpness and brightness. - Standard : Choose this setting for most viewing applications. - Movie : The best setting for watching movies. - User : Lets you adjust the sharpness and noise reduction function respectively. 	○	○
Audio	Use to set the desired audio language.	○	
Audio Sync	Select to adjust the audio sync.	○	○
Subtitle	Use to set the desired subtitle language.	○	
Angle	Lets you view a scene from another angle. The Angle option displays the number of angles available to view. When an Ultra HD Blu-ray Disc/Blu-ray Disc/DVD contains multiple angles of a particular scene, you can change to another angle.	○	
Rotate	You can rotate the screen clockwise or counterclockwise by 90 degrees.		○

| NOTE |

- ▶ Video files with high bit rates of 20Mbps or more strain the product's capabilities and may stop playing during playback.

Using the Sort By & Options Menus

Using the Sort By Menu

On a file screen containing video files, select **Sort By**, and then press the **OK** button. Arrange folders or files in order by **Date** or **Title**.

Using the Options Menu

On a file screen containing video files, select **Options**, and then press the **OK** button.

Play Selected	Lets you select specific files to play. It works essentially the same for all media.
Refresh	Refreshes the files and folders list from the media or storage device.

Controlling Music Playback

You can control the playback of music content located on a Disc, USB, or PC.

Depending on the disc or contents, some of the functions described in this manual may not be available.

Buttons on the Remote Control used for Music Playback

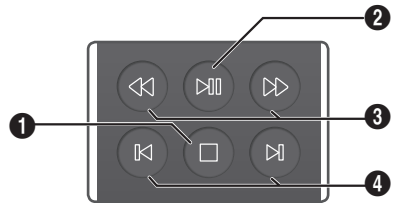

1	■ button : Stops a track.
2	▶ button : Plays/Pauses a track.
3	Fast Play (Audio CD [CD-DA] only) During playback, press the ◀◀ or ▶▶ button. Each time you press the ◀◀ or ▶▶ button, the playback speed will change.
4	◀▶▶▶ buttons : Move to the previous/next track.

Using the Options Menu During Playback

On the music file playback screen, use the **Up/Down/Left/Right** buttons to select the  and then press the **● (OK)** button.

Play Selected	Lets you create a playlist by selecting specific tracks to play. It works essentially the same way for all media. See "Creating a Playlist from an Audio CD" on page 34.
Information	Select to see the Contents information.

| NOTE |

- ▶ Depending on the disc or storage device, the menu may differ.

Using the Sort By & Options Menus on a File Screen

Using the Sort By Menu

On a file screen containing music files, select **Sort By**, and then press the **● (OK)** button. Arrange folders or files in order by **Date** or **Title**.

Using the Options Menu

On a file screen containing music files, select **Options**, and then press the **● (OK)** button.

Play Selected	Lets you select specific files to play. It works essentially the same for all media. See the "Repeating Tracks on an Audio CD" on page 34.
Refresh	Refreshes the files and folders list from the media or storage device.

Repeating Tracks on an Audio CD

You can set the product to repeat tracks on an audio CD (CD-DA/MP3).

1. On the Playback screen, use the **Up/Down/Left/Right** buttons to select  in the lower left corner of the screen, and then press the **● (OK)** button.
2. Use the **Up/Down** buttons to select the repeat mode you want - **Off**, **One Song**, or **All** - and then press the **● (OK)** button.

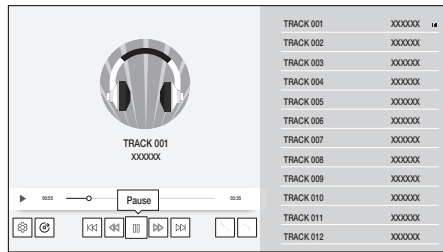

Shuffling Tracks on an Audio CD

You can set the product to play tracks on an audio CD (CD-DA/MP3) at random.

1. On the Playback screen, use the **Up/Down/Left/Right** buttons to select  in the lower left corner of the screen, and then press the **● (OK)** button.
2. Use the **Up/Down** buttons to set the Shuffle mode **On** or **Off**, and then press the **● (OK)** button.

Creating a Playlist from an Audio CD

1. With the Playback screen displayed, select the  and then press the **● (OK)** button. The **Settings** menu appears.
2. Use the **Up/Down** buttons to select **Play Selected**, and then press the **● (OK)** button.
3. Use the **Up/Down** buttons to select a track, and then press the **● (OK)** button. A check appears to the left of the track.

4. Repeat Step 3 to select and check additional tracks.
5. To remove a track from the list, move to the track, and then press the ● (OK) button again.
The check on the track is removed.
6. When done, press the **Up/Down** buttons to select **Done**, and then press the ● (OK) button. The Music Playback screen reappears listing only the tracks you checked. The selected tracks play automatically.

| NOTES |

- ▶ You can create a playlist with up to 99 tracks on Audio CDs (CD-DA).
- ▶ On the Selection Play screen, you can also choose **Select All**, **Deselect All**, and **Cancel**.
 - Use **Select All** to select all tracks. This cancels your individual track selections. When you press the ↵ (Return) button on your remote control or select the **Done** button, and then press the ● (OK) button, all tracks will appear on the Music Playback screen, and the product will begin to play all tracks from Track 001.
 - Use **Deselect All** to deselect all selected tracks at once. Then, select individual tracks or use **Select All** to select all the tracks, and then press the ↵ (Return) button on your remote control. If you do not use **Select All** or select individual tracks, the Playlist will not change.
 - **Cancel** cancels any changes you made on the Play Select screen. When you return to the Playback screen, the Playlist will be unchanged.

Playing Photo Contents

You can play photo contents located on a DVD, USB, or PC.

Using the On-screen Menu during Playback of a Photo File

Use the **Up/Down/Left/Right** buttons to select each function and then press the ● (OK) button. To display the **Options** menu during playback or in pause mode, press the **TOOLS** button. Alternatively, use the **Up/Down/Left/Right** buttons to select  and then press the ● (OK) button.

Fit to Screen	Resizes photos to fit the screen.
Zoom	Select to enlarge the current picture. (Enlarge up to 4 times)
Rotate left	This will rotate the picture counterclockwise.
Rotate right	This will rotate the picture clockwise.
Slideshow Speed	Select to set the slide show speed.
Slideshow Effect	Select to set the slide show effect.
Background Music	Select to listen to music while viewing a slide show. NOTE ▶ The number of music files available from external devices will differ depending on the device.
Information	Select to see the Contents information.

| NOTES |

- ▶ Depending on the disc or storage device, the menu may differ.

Media Play

- ▶ To enable the **Background Music** function, the photo file must be on the same storage media as the music file.

Note that the sound quality can be affected by the bit rate of the MP3 file, the size of the photo, and the encoding method.

Using the Sort By & Options Menus

Using the Sort By Menu

On a file screen containing photo files, select **Sort By**, and then press the ● (OK) button. Arrange folders or files in order by **Date** or **Title**.

Using the Options Menu

On a file screen containing photo files, select **Options**, and then press the ● (OK) button.

Play Selected	Lets you select specific files to play. It works essentially the same for all media. See "Creating a Playlist from an Audio CD" on page 34.
Refresh	Refreshes the files and folders list from the media or storage device.

You can enjoy various network services such as streaming video or on-line apps by connecting the product to your network.

To use network services, you must first:

1. Connect the player to a network.
(See page 16)
2. Configure the network settings.
(See pages 23~26)

Creating a Samsung Account

Create a Samsung account so you can take advantage of all Samsung has to offer on line. Set up accounts for each household member so each member can access their own accounts on Facebook, Twitter, etc. You also need a Samsung account if you want to download for-pay apps and rent movies.

| NOTE |

- ▶ The terms of agreement screen appears if you skipped Smart Hub terms of agreement at the initial settings stage. Agree to all the terms and then follow the steps shown below.

1. On the Home screen, press the **APPS**.
The **Samsung Account** screen appears.
2. On the **Samsung Account** screen, select **Create Account**, and then press the **(OK)** button.
3. Only users over 14 years can create a Samsung account. When a window asking if you are eligible, select **Yes** and press the **(OK)** button.
The **Samsung account Terms & Conditions and Privacy Policy** screen appears.
4. Press the **(OK)** button to agree, press the **Right** button, and then press the **(OK)** button.
The **Create Account** screen appears.
5. Select the ID field, and then press the **(OK)** button. The keyboard pop-up appears.

6. Enter your e-mail address using the keyboard. Use the arrow buttons to move from character to character.
Press **(OK)** to select a character. Select the **⇧** on the left to enter capitals. Select the **#@!** to enter additional symbols.
7. When finished, select the **Next** on the keyboard, and then press the **(OK)** button. When a window confirming that the ID is valid appears, press the **(OK)** button. The **Create Account** screen reappears. Enter the password, use the directional keys on the remote control to select **Done**, and then press the **(OK)** button.
8. Press the **(OK)** button again to display the next page.
9. Enter your first name, and last name in the same fashion.
10. Select the Date of Birth field, and then select numbers using the up and down arrow buttons or by pressing numbers on your remote. After filling in the required input fields, select **Next** and press the **(OK)** button. When creation of your Samsung account is complete, you are automatically logged in via the new account.

| NOTES |

- ▶ Samsung sends a confirming e-mail to the address you entered. You must open the e-mail and respond as requested to finalise your account.
- ▶ To manage your Samsung account, use the **Samsung Account > My Account** menu items.

Network Services

Before Using Apps

If you haven't set up Smart Hub, when you use Apps for the first time, the product will ask you to perform the Smart Hub set up procedure.

1. On the Home screen, select **APPS**, and then press the **(OK)** button.
2. If you haven't set up Smart Hub, the **Smart Hub Terms & Conditions, Privacy Policy** screen appears.
3. To view details before agreeing to the terms of agreement, select **View All** and press the **(OK)** button.

| NOTE |

- ▶ You do not need to consent to the Supplemental Privacy Notice, but one or more Smart Hub features or functions may not be available if you do not.
4. Select **I agree to all**, and then press the **(OK)** button. The Setup Complete screen appears. Press the **(OK)** button.

Using Apps

You can download applications from the Internet, and access various applications and view them on your TV. To access some applications, you need to have a Samsung account.

| NOTE |

- ▶ For some 4K streaming service Apps (Netflix, Amazon, etc.), the use of the 4K service is enabled if the TV supports HDCP 2.2. If the TV (or the connected HDMI terminal) does not support HDCP 2.2, the 4K category will not be displayed.

The Apps Screen at a Glance

The **APPS** screen displays a list of a variety of apps. Use the list to download apps with ease.

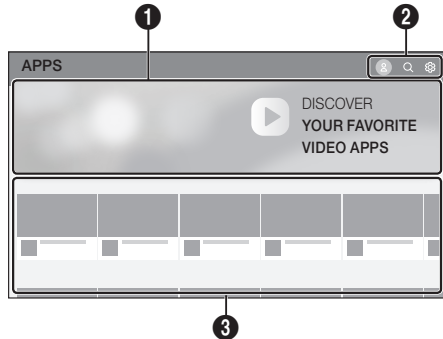

1	Download a video app to play video.	
2		Log in with your Samsung account. Use a variety of Samsung-provided functions. If you do not have a Samsung account, create one here.
		Enter the name of a specific app to search for it.
3		Configure settings for a downloaded app.
	Available apps are displayed at the bottom. Use the Up/Down/Left/Right buttons to download or use a desired app.	

The first time you open the **APPS** screen, the Ultra HD Blu-ray Player automatically downloads a group of free apps. Once these apps have been downloaded, they appear on the **Downloaded App** list.

Downloading an App

1. Use the **Up/Down** buttons to move to **Editor's Choice**, **Most Popular**, **Group Content**, or **Genre**. If you have moved to **Group Content** or **Genre**, press the ● (OK) button to select the desired category or genre.
2. Use the **Up/Down/Left/Right** buttons to move to the app you want to download, and then press the ● (OK) button. The Detail Information screen for the app appears.

| NOTE |

- ▶ Apps already installed show "Installed" in the app thumbnail.
3. Select **Install** on the screen, and then press the ● (OK) button. **Install** changes to **Cancel** and the app begins to download.
 4. If you want to cancel the download, select **Cancel**, and then press the ● (OK) button.
 5. When the download is complete, **Cancel** changes to **Open**. Select **Open**, and then press the ● (OK) button to start the application. Alternately, press the ↵ (Return) button until the **APPS** screen reappears. The app you downloaded will be displayed on the **Downloaded App** list.

| NOTES |

- ▶ To add the installed app to the bottom of the Home screen, select **Add to Home** on the installation complete screen.
- ▶ If the App cannot be downloaded due to insufficient remaining internal memory, connect a USB storage device and try again.

Starting an Application

1. On the Home screen, select  **APPS**, and then press the ● (OK) button.
2. On the **APPS** screen, use the **Up/Down** buttons to move to **Downloaded App**. Use the **Left/Right** buttons to move to the desired app, and then press the ● (OK) button. The app starts.

The Settings Menu

Use the **Up/Down/Left/Right** buttons to move to  **Settings** in the top right of the **APPS** screen, and then press the ● (OK) button.

Auto update

Turn on or turn off the automatic app update option. Select **Auto update** in the top right of the **Settings** screen, and then press the ● (OK) button. The option turns **On** or **Off** each time the button is pressed.

Delete

1. On the **Settings** screen, select the app to delete.
2. Select **Delete**, and then press the ● (OK) button.

Add to Home

1. On the **Settings** screen, select the app to be added to the Home screen.
2. Select **Add to Home**, and then press the ● (OK) button.
3. At the bottom of the screen, use the **Left/Right** buttons to specify the location of the app to add, and then press the ● (OK) button.

Network Services

Lock/Unlock

This function blocks access to an app unless you enter your PIN. Unlock removes the lock.

1. On the **Settings** screen, select the app to be locked.
2. Select **Lock/Unlock**, and then press the ● (OK) button. Enter your PIN. A check appears next to the app.

| NOTE |

- ▶ To unlock apps, follow essentially the same directions, but select apps that have locks.

Move

1. On the **Settings** screen, select the app to be moved.
2. Select **Move**, and then press the ● (OK) button.
3. Use the **Left/Right** buttons to move the app.
4. When the app is where you want it, press the ● (OK).

Reinstall

1. On the **Settings** screen, select the app to be reinstalled.
2. Select **Reinstall**, and then press the ● (OK) button. The app is reinstalled. Reinstallation may take a few minutes.

View Details

1. On the **Settings** screen, select the app you want to view details for.
2. Select **View Details**, and then press the ● (OK) button. The detailed information page for the app appears.

Using the Internet

You can access the Internet using the Internet application.

Select **Internet** on the Home screen, and then press the ● (OK) button.

| NOTES |

- ▶ The Web Browser is not compatible with Java applications.
- ▶ If you attempt to download a file, and the file cannot be saved, an error message will appear.
- ▶ E-commerce (purchasing products online) is not supported.
- ▶ ActiveX is not supported.
- ▶ Access may be blocked to some websites or to web browsers operated by certain businesses.
- ▶ Playing Flash videos is not supported.

The Web Browser window at a Glance

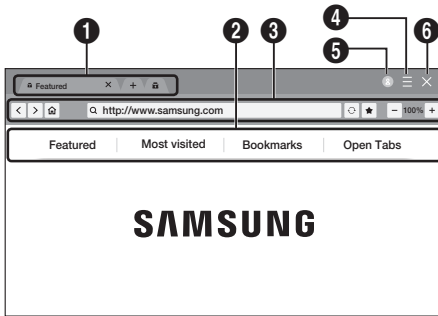

1

- **Current Tab:** Shows the current screen name. To delete the tab, click the X next to the tab name.
- **Open new tab :** Opens a new web browser tab.
- **Open New Secret Tab:** Opens a new browser tab in Security Mode.

2

- **Featured:** Shows recommended websites.
- **Most visited:** Shows frequently visited websites.
- **Bookmarks:** Shows a list of bookmarks. You can also select an existing bookmark, and edit and delete bookmarks.
- **Open Tabs:** Shows a list of your open tabs and the tabs opened in another web browser logged in using the same account.

The Control Panel, which runs across the top of the screen, has a series of icons which start a number of useful functions.

3

- < : Moves to the previous page.
- > : Moves to the next web page.
- Home icon : Moves to the Home screen of the Web Browser.
- Search bar : Use the on-screen keyboard pop-up to enter a URL or keyword to search for specific information. See "Using the Keyboard Pop-up" on page 42.
- Refresh icon : Reloads the current page so that it is refreshed on the screen.
- Star icon : Adds the current page to your bookmarks.
- Zoom icon : Lets you enlarge or shrink the screen by various percentages.

4

- Menu icon : Lets you configure the Browser's settings. See "Using the Browser Menu" on page 43.

5

- Account icon : The **Samsung Account** page appears.

6

- Close icon : Closes the Web Browser.

Network Services

Using the Keyboard Pop-up

When you click the , or access a data or text entry field, and then press the **(OK)** button, the keyboard pop-up appears.

To use the keyboard pop-up with your remote, follow these steps:

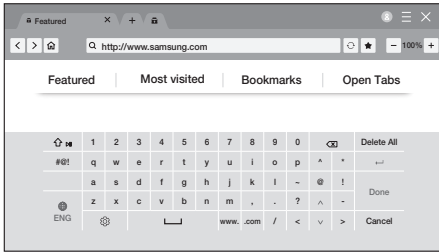

| NOTE |

- ▶ Characters that can be displayed using the keyboard depend on the selected language.
1. Use the **Up/Down/Left/Right** buttons on your remote to move the highlight to a letter or number of your choice.
 2. Press the **(OK)** button to enter the letter or number into the entry field.
 3. To access capital letters, move the highlight to the **⇧** key on the top left, and then press the **(OK)** button. Press the **(OK)** button again with the **⇧** key highlighted to access lowercase letters again. When the on-screen keyboard pops up, press the **▶▶** button on the remote control to switch between uppercase and lowercase modes.
 4. To access symbols and additional punctuation marks, highlight the **#@!** on the left, and then press the **(OK)** button.
 5. To delete a character you entered, move the highlight to the **<X>**, and then press the **(OK)** button.
 6. To delete all the characters you entered, move the highlight to **Delete All**, and then press the **(OK)** button.
 7. When finished entering, move the highlight to **Done**, and then press the **(OK)** button.

| NOTE |

- ▶ If you have a wireless keyboard connected to your product, you can use the wireless keyboard to enter letters, numbers, symbols, and punctuation. Note that the wireless keyboard will work only when the keyboard popup appears and can only be used to enter letters, numbers, symbols, and punctuation.

Options on the Keyboard Pop-Up

To access the keyboard pop-up options, highlight the **⊞** on the bottom left of the keyboard, and then press the **(OK)** button.

Reset Recommended Text Memory

Reset erases the Samsung Keyboard's memory. Select Reset to erase everything that the Samsung Keyboard has learned about your writing style, including any new words you have used.

Predict Next Character (when using direction buttons)

The keyboard predicts the next letter as you enter letters. The predictions appear in a ring around the letter you have just entered. You can select a predicted letter or move to another letter. You can turn this function on or off.

Language

Select the language for the keyboard. You can select English, French, Russian, etc.

Using the Browser Menu

The menu contains functions that control how the browser operates and browser security functions. To open the menu, highlight the ☰ (Menu) icon, and then press the ● (OK) button. To select an option in the menu, highlight the option, and then press the ● (OK) button.

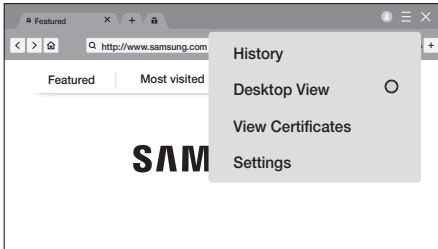

History

Displays a list of visited websites. To delete the list, click **Remove All**.

Desktop View

You can turn on or turn off **Desktop View**.

View Certificates

Shows the certificate information of the current Web Site.

Settings

• General

- **Sync and View Tabs and Bookmarks Across Devices:** Log in with your Samsung account to sync the main unit with other devices. You can share bookmarks and view tabs that are opened in the other devices.
- **Hide Tabs and Toolbar automatically:** Automatically hides the tabs and toolbar.
- **Pop-up Blocker:** Blocks pop-up windows.
- **Reset Settings:** You can reset all web browser settings to their factory defaults. Your Bookmarks and History won't be affected.

- **Home Page:** You can set the Browser's home page.
- **Search Engine:** You can set the desired Search Engine.
- **Privacy & Security**
 - **Do Not Track:** Deters websites from tracking you.
 - **Delete History:** Deletes your entire browsing history.
 - **JavaScript:** Allows all sites to run JavaScript for a better browsing experience.
 - **Delete browsing data:** Deletes all browsing data such as cookies, cached images, and data. Your Bookmarks and History won't be affected.
- **Parental Lock:** Enable web access only to pages that you have approved.
 - **Parental Lock PIN:** Set a PIN for managing the Parental lock. Click **Set PIN** to set the PIN.
 - **Approved Pages:** Lets you approve specific pages or remove Approved pages.
- **Encoding:** You can set the encoding setting for web pages to automatic or select the encoding format manually from a list.
- **About:** Provides basic information about the operation of the Web Browser.

| NOTE |

- ▶ Depending on the web site, some of the **Settings** functions may not be activated. Functions that are not activated are greyed out and cannot be used.

Network Services

Linking Your Internet Service Accounts to the Product

The Link Service Accounts function lets you link your product to your accounts with Internet services such as Pandora so that the product can log you in to the service automatically when you start the app for that service.

Register your account by going to **HOME** →

 **APPS** →  **Sign in** → **Create with Facebook.**

BD-LIVE™

Once the product is connected to your network, you can enjoy various movie-related service content available on BD-LIVE compliant discs.

1. Attach a USB flash memory drive to the USB jack on the front of the product, and then check its remaining memory. The memory device must have at least 1GB of free space to accommodate the BD-LIVE services.
2. Select **Settings** on the Home screen, and then press the ● (OK) button.
3. Select **General**, and then press the ● (OK) button.
4. Select **Network**, and then press the ● (OK) button.
5. Select **BD-Live Settings**, and then press the ● (OK) button.
6. Select **BD Data Management**, and then press the ● (OK) button.
7. Select **Select Device**, and then press the ● (OK) button.
8. Select **USB Storage**, and then press the ● (OK) button.
9. Insert an Ultra HD Blu-ray Disc or Blu-ray Disc that supports BD-LIVE.
10. Select an item from the list of BD-LIVE service contents provided by the disc manufacturer.

| NOTE |

- ▶ The way you use BD-LIVE and the provided contents may differ, depending on the disc manufacturer.

Additional Information

Notes

Settings	TV Aspect Ratio
	<ul style="list-style-type: none"> • Depending on the disc type, some aspect ratios may not be available. • If you select an aspect ratio and option that is different than the aspect ratio of your TV screen, the picture might appear to be distorted. • If you select the 16:9 Original, your TV may display 4:3 Pillarbox (black bars on the sides of the picture).
	Digital Output
	<ul style="list-style-type: none"> • Be sure to select the correct Digital Output or you will hear no sound or just loud noise. • If the HDMI device (AV receiver, TV) is not compatible with compressed formats (Dolby Digital, DTS), the audio signal outputs as PCM. • Regular DVDs do not have BONUSVIEW audio and Navigation Sound Effects. • Some Ultra HD Blu-ray Discs and standard Blu-ray Discs do not have BONUSVIEW audio and Navigation Sound Effects. • The Digital Output setup does not affect the HDMI audio output to your TV. It affects the optical and HDMI audio output when your product is connected to an AV receiver. • If you play MPEG audio soundtracks, the audio signal outputs as PCM regardless of your Digital Output selections (PCM or Bitstream).
	PCM Downsampling
<ul style="list-style-type: none"> • Even when PCM Downsampling is set to Off, some discs will only output downsampled audio through the optical digital output. • HDMI <ul style="list-style-type: none"> - If your TV is not compatible with compressed multi-channel formats (Dolby Digital, DTS), the product may output PCM 2ch downmixed audio even though you selected Bitstream (either Reencoded or Unprocessed) in the setup menu. - If your TV is not compatible with PCM sampling rates over 48kHz, the product will output at 48kHz. 	
BD-Live Internet Connection	
<ul style="list-style-type: none"> • What is a valid certificate? When the product uses BD-LIVE to send the disc data and a request to the server to certify the disc, the server uses the transmitted data to check if the disc is valid and sends the certificate back to the product. • The Internet connection may be restricted while you are using BD-LIVE contents. 	

Settings	BD Data Management
	<ul style="list-style-type: none"> • In the external memory mode, disc playback may be stopped if you disconnect the USB device in the middle of playback. • Only those USB devices formatted in the FAT file system (DOS 8.3 volume label) are supported. We recommend you use USB devices that support the USB 2.0 protocol with 4 MB/sec or faster read/write speed. • The Resume Play function may not work after you format the storage device. • The total memory available to BD Data Management may differ, depending on conditions.
Media Play	Anynet+ (HDMI-CEC)
	<ul style="list-style-type: none"> • Depending on your TV, certain HDMI output resolutions may not work. Please refer to the user manual of your TV. • This function is not available if the HDMI cable does not support CEC. • If your Samsung TV has an Anynet+ logo, then it supports the Anynet+ function.
Media Play	Selecting the Audio Language
	<ul style="list-style-type: none"> • The Left/Right indicator will not appear on the screen if the BONUSVIEW section does not contain any BONUSVIEW audio settings. • The languages available through the Audio Language function depend on the languages that are encoded on the disc. This function or certain languages may not be available. • Some Ultra HD Blu-ray Discs and standard Blu-ray Discs may allow you to select either the PCM or Dolby Digital audio soundtrack in English.
Media Play	Selecting the Subtitle Language
	<ul style="list-style-type: none"> • Depending on the Ultra HD Blu-ray Disc/Blu-ray Disc/DVD Disc, you may be able to change the subtitle language in the Disc Menu. Press the DISC MENU button. • This function depends on the selection of subtitles that are encoded on the disc and may not be available on all Ultra HD Blu-ray Discs/Blu-ray Discs/DVDs. • Information about the main feature BONUSVIEW mode will also appear if the Ultra HD Blu-ray Disc or Blu-ray Disc has a BONUSVIEW section. • This function changes both the primary and secondary subtitles at the same time. • The total number of primary and secondary subtitles, respectively, is displayed.

Resolution according to the contents type

Setup		Contents Type		Ultra HD Blu-ray Disc/ Blu-ray Disc	E-contents/ Digital contents	DVD Disc
		Disc Content	Auto	2160p(1080p)@24	2160p(1080p)@60	2160p(1080p)@60
Movie Frame (24p/25p) * 2160p, 1080p only	Disc Content	Off	Max.Resolution of TV input	Max.Resolution of TV input	Max.Resolution of TV input	
		Streaming Content	Auto	2160p(1080p)@60	2160p(1080p)@24	2160p(1080p)@60
	Off		Max.Resolution of TV input	Max.Resolution of TV input	Max.Resolution of TV input	
	Resolution	Auto		Max.Resolution of TV input	Max.Resolution of TV input	Max.Resolution of TV input
2160p		2160p@60	2160p@60	2160p@60		
1080p		1080p@60	1080p@60	1080p@60		
720p		720p@60	720p@60	720p@60		
576p/480p		576p/480p@60	576p/480p@60	576p/480p@60		

| NOTES |

- ▶ If the TV you connected to the product does not support Movie Frame or the resolution you selected, the message *"If no pictures are shown after selecting 'Yes', please wait for 15 seconds to return to the previous resolution. Do you want to change the resolution?"* appears. If you select **Yes**, the TV's screen will go blank for 15 seconds, and then the resolution will revert to the previous resolution automatically.
- ▶ If the screen stays blank after you have changed the resolution, remove all discs, and then press and hold the **▲ (Open/Close)** button on the top of the product for more than 5 seconds. The initialisation message appears on the screen and the player turns off automatically. When you turn your product on again, all the settings will be reset. Run the Initial Settings procedure again. Then, go to **Settings > Picture > Resolution** in the Menu, and select the correct resolution for your TV.
- ▶ When you run the Initial Settings procedure, re-select the language and aspect ratio (screen size and format) only. Resetting does not affect your network settings, so you should be able to skip Network Setup and Software Update.
- ▶ When the factory default settings are restored, all stored user BD data is deleted.
- ▶ An Ultra HD Blu-ray Disc or standard Blu-ray Disc must have the 24 frame feature for the product to use the **Movie Frame (24p/25p)** mode.

Digital Output Selection

Setup		PCM		Bitstream (Unprocessed)		Bitstream (Re-encoded DTS)	Bitstream (Re-encoded Dolby D)
		HDMI	Optical	HDMI	Optical	HDMI or Optical	HDMI or Optical
Audio Stream on Ultra HD Blu-ray Disc/ Blu-ray Disc	PCM	Up to PCM 7.1ch	PCM 2ch	PCM	PCM 2ch	DTS re-encoded	Re-encoded Dolby Digital *
	Dolby Digital	Up to PCM 7.1ch	PCM 2ch	Dolby Digital	Dolby Digital	DTS re-encoded	Re-encoded Dolby Digital *
	Dolby Digital Plus	Up to PCM 7.1ch	PCM 2ch	Dolby Digital Plus	Dolby Digital	DTS re-encoded	Re-encoded Dolby Digital *
	Dolby TrueHD	Up to PCM 7.1ch	PCM 2ch	Dolby TrueHD	Dolby Digital	DTS re-encoded	Re-encoded Dolby Digital *
	DTS	Up to PCM 6.1ch	PCM 2ch	DTS	DTS	DTS re-encoded	Re-encoded Dolby Digital *
	DTS-HD High Resolution Audio	Up to PCM 7.1ch	PCM 2ch	DTS-HD High Resolution Audio	DTS	DTS re-encoded	Re-encoded Dolby Digital *
	DTS-HD Master Audio	Up to PCM 7.1ch	PCM 2ch	DTS-HD Master Audio	DTS	DTS re-encoded	Re-encoded Dolby Digital *
Audio Stream on DVD	PCM	PCM 2ch	PCM 2ch	PCM 2ch	PCM 2ch	PCM 2ch	PCM 2ch
	Dolby Digital	Up to PCM 5.1ch	PCM 2ch	Dolby Digital	Dolby Digital	Dolby Digital	Dolby Digital
	DTS	Up to PCM 6.1ch	PCM 2ch	DTS	DTS	DTS	DTS
Definition for Ultra HD Blu-ray Disc/ Blu-ray Disc	Any	Decodes the main feature audio and BONUSVIEW audio stream together into PCM audio and adds Navigation Sound Effects.		Outputs only the main feature audio stream so that your AV receiver can decode the audio bitstream. You will not hear BONUSVIEW audio or Navigation Sound Effects.		Decodes the main feature audio and BONUSVIEW audio stream together into PCM audio and adds Navigation Sound Effects, then re-encodes the PCM audio into DTS bitstream.	Decodes the main feature audio and BONUSVIEW audio stream together into PCM audio and adds Navigation Sound Effects, then re-encodes the PCM audio into Dolby Digital bitstream or PCM.

* If the Source Stream is 2ch or mono, "Re-encoded Dolby D" Settings are not applied. Output will be PCM 2ch.

* If Audio Output is set to Auto, the player automatically switches to the proper format from the four listed above.

Ultra HD Blu-ray Discs and standard Blu-ray Discs may include three audio streams :

- Main Feature Audio : The audio soundtrack of the main feature.
- BONUSVIEW audio : An additional soundtrack such as the director or actor's commentary.
- Navigation Sound Effects : When you choose some menu navigation functions, Navigation Sound Effects may sound. Navigation Sound Effects are different on each Ultra HD Blu-ray Disc/Blu-ray Disc.

Troubleshooting

Before requesting service, please try the following solutions.

PROBLEM	SOLUTION
No operation can be performed with the remote control.	<ul style="list-style-type: none"> • Check the batteries in the remote control. They may need replacing. • Operate the remote control at a distance of no more than 6.1m from the product. • Remove the batteries and hold down one or more buttons for several minutes to drain the microprocessor inside the remote control to reset it. Reinstall the batteries and try to operate the remote control again.
The disc does not play.	<ul style="list-style-type: none"> • Ensure that the disc is installed with the label side facing up. • Check the region number of the Ultra HD Blu-ray Disc/Blu-ray Disc/DVD.
The disc Menu does not appear.	<ul style="list-style-type: none"> • Confirm that the disc has disc menus.
The prohibition message appears on the screen.	<ul style="list-style-type: none"> • This message appears when an invalid button is pressed. • The Ultra HD Blu-ray Disc/Blu-ray Disc/DVD's software doesn't support the feature (e.g., angles). • You've requested a title or chapter number or search time that is out of range.
Play mode differs from the Setup Menu selection.	<ul style="list-style-type: none"> • Some of the functions selected in the Setup Menu may not work properly if the disc is not encoded with the corresponding function.
The screen ratio cannot be changed.	<ul style="list-style-type: none"> • The Screen Ratio on your Ultra HD Blu-ray Disc/Blu-ray Disc/DVD Disc is fixed and cannot be changed. • This is not a problem with the product.
No audio.	<ul style="list-style-type: none"> • Make sure you have selected the correct Digital Output in the Audio Options Menu.
The screen is blank.	<ul style="list-style-type: none"> • If the HDMI output is set to a resolution your TV cannot support (for example, 1080p), you may not see a picture on your TV. • Press the ▲ (Open/Close) button (on the top panel) for more than 5 seconds with no disc inside. The initialisation message appears on the screen, and the player turns off automatically. When you turn your product on again, all the settings will be reset. • When the factory default settings are restored, all stored user BD data will be deleted.

Appendix

PROBLEM	SOLUTION
Forgot password.	<ul style="list-style-type: none"> • Press the ▲ (Open/Close) button (on the top panel) for more than 5 seconds with no disc inside. The initialization message appears on the screen, and the player turns off automatically. When you turn your product on again, all the settings will be reset. Don't use this unless absolutely necessary. • When the factory default settings are restored, all stored user BD data will be deleted.
The picture is noisy or distorted.	<ul style="list-style-type: none"> • Make sure that the disc is not dirty or scratched. • Clean the disc.
No HDMI output.	<ul style="list-style-type: none"> • Check the connection between the TV and the HDMI jack of the product. • Check if your TV supports the 576p/480p, 720p, 1080p, or 2160p HDMI input resolution. • To view video in the HDMI 720p, 1080p, or 2160p output mode, you must use a high speed (category 2) HDMI cable.
Abnormal HDMI output appears on the screen.	<ul style="list-style-type: none"> • If random noise appears on the screen, it means that TV does not support HDCP (High-bandwidth Digital Content Protection).
If you experience other problems.	<ul style="list-style-type: none"> • Go to the table of contents and find the section of the user manual that contains information about the feature you are having the problem with, and then follow the procedure again. • If you still cannot resolve the problem, please contact your nearest Samsung authorised service centre.
Play Multimedia on network devices	
You can see folders shared on network devices, but cannot see the files.	<ul style="list-style-type: none"> • The multimedia list only shows Video, Photo, and Music files. Other types of files are not displayed.
Video plays intermittently.	<ul style="list-style-type: none"> • Check if the network is stable. • Check if the network cable is properly connected and if the network is not overloaded.
The Network connection between the product and the PC is unstable.	<ul style="list-style-type: none"> • IP addresses within the same subnetwork should be unique. If they are not, IP interference can cause this phenomenon. • Check if you have a firewall enabled. If so, disable the firewall function.

PROBLEM	SOLUTION
BD-LIVE	
<p>This product cannot connect to the BD-LIVE server.</p>	<ul style="list-style-type: none"> • Test whether the network connection is working using the Network Status function. (See page 20) • Check whether a USB memory device is connected to the product. • The memory device must have at least 1GB of free space to accommodate the BD-LIVE service. You can check the available size in BD Data Management. (See page 20) • See if the BD-Live Internet Connection option is set to Allow(All). • If all above fails, contact the content provider or update the product to the latest firmware.
<p>When using the BD-LIVE service, an error occurs.</p>	<ul style="list-style-type: none"> • The memory device must have at least 1GB of free space to accommodate the BD-LIVE service. You can check the available size in BD Data Management. (See page 20)

| NOTE |

- ▶ When the factory default settings are restored, all stored user BD data will be deleted.

Disc and Format Compatibility

Disc types and contents your product can play

Media	Disc Type	Details
VIDEO	Ultra HD Blu-ray Disc	Ultra HD BD-ROM format.
	Blu-ray Disc	BD-ROM format.
	DVD-VIDEO DVD-RW DVD-R DVD+RW DVD+R	DVD-VIDEO, recorded DVD+RW/DVD-RW(V)/DVD-R/+R that have been recorded and finalised, or a USB storage media containing DivX, MKV, MP4 contents.
MUSIC	CD-RW/-R, DVD-RW/-R, CDDA, BD-RE/-R	Audio CD (CD-DA), music recorded on CD-RW/-R, DVD-RW/-R, BD-RE/-R or a USB storage media containing MP3 or WMA contents.
PHOTO	CD-RW/-R, DVD-RW/-R, BD-RE/-R	Photos recorded on CD-RW/-R, DVD-RW/-R, BD-RE/-R or a USB storage media containing JPEG contents.

| NOTES |

- ▶ The product may not play certain CD-RW/-R and DVD-R because of the disc type or recording conditions.
- ▶ If a DVD-RW/-R has not been recorded properly in DVD video format, it will not be playable.
- ▶ Your product will not play content that has been recorded on a DVD-R at a bit-rate that exceeds 10 Mbps.
- ▶ Your product will not play content that has been recorded on a BD-R or USB device at a bit rate that exceeds 25 Mbps.
- ▶ Playback may not work for some types of discs, or when you use specific functions, such as angle change and aspect ratio adjustment. Information about the discs is written in detail on the disc box. Please refer to this if necessary.
- ▶ When you play a BD-J title, loading may take longer than a normal title. Also, some functions may perform slowly.



Disc types your product cannot play

- HD DVD
- DVD-ROM/PD/MV, etc
- DVD-RAM
- Super Audio CD (except CD layer)
- DVD-RW (VR mode)
- CVD/CD-ROM/CDV/CD-G/CD-I/LD (CD-Gs play audio only, not graphics.)
- 3.9 GB DVD-R for Authoring.





Region Code

Both products and discs are coded by region. These regional codes must match for a disc to play. If the codes do not match, the disc will not play.

The Region Number for this product is displayed on the rear panel of the product.

Disc Type	Region Code	Area
Blu-ray Disc		North America, Central America, South America, Korea, Japan, Taiwan, Hong Kong and South East Asia.
		Europe, Greenland, French territories, Middle East, Africa, Australia and New Zealand.
		India, China, Russia, Central and South Asia.
DVD-VIDEO		The U.S., U.S. territories and Canada
		Europe, Japan, the Middle East, Egypt, Africa, Greenland
		Taiwan, Korea, the Philippines, Indonesia, Hong Kong
		Mexico, South America, Central America, Australia, New Zealand, Pacific Islands, Caribbean
		Russia, Eastern Europe, India, North Korea, Mongolia
		China

Logos of Discs the product can play

	
Blu-ray Disc	BD-LIVE
	
Ultra HD Blu-ray Disc	
	
PAL broadcast System in U.K., France, Germany, etc.	DivX

Appendix

Supported Formats

Supported Video File Formats

File Extension	Container	Video Codec	Resolution	Frame rate (fps)	Bit rate (Mbps)	Audio Codec
*.avi *.mkv *.asf *.wmv *.mp4 *.mov *.3gp *.vro *.mpg *.mpeg *.ts *.tp *.trp *.mov *.flv *.vob *.svi *.m2ts *.mts *.divx	AVI	H.264 BP/MP/HP	4096x2160	4096X2160: 30	60	Dolby Digital LPCM ADPCM (IMA, MS) AAC HE-AAC WMA DD+ MPEG(MP3) DTS (Core , LBR) G.711 (A-Law, μ -Law)
		(H.265 - Main, Main10)		60		
	MKV	Motion JPEG	3840x2160	30	80	
	ASF	MVC	1920x1080	60	20	
	MP4	DivX 3.11 / 4 / 5 / 6				
	3GP	MPEG4 SP/ASP				
	MOV	Window Media Video v9(VC1)				
	FLV	MPEG2				
	VRO	MPEG1				
	VOB	Microsoft MPEG-4 v1, v2, v3				
	PS	Window Media Video v7(WMV1), v8(WMV2)				
	TS	H 263 Sorrenson				
	SVAF	VP6				
	*.webm	WebM	VP8	1920x1080	60	
VP9			4096x2160	4096X2160: 60	40	
*.rmvb	RMVB	RV8/9/10 (RV30/40)	1920x1080	60	20	RealAudio 6

■ Limitations

- Even when a file is encoded by a supported codec listed in the Video File Support table, the file might not play if its content has a problem.
- Normal playback is not guaranteed if the file's container information is wrong or the file itself is corrupted.
- Playing back contents having higher rates than the base bit rate/frame rate may cause stuttering sound or video.
- The Seek (Jump) function is not available if the file's index table is damaged.
- When you playback a file remotely through a network connection, video playback may stutter depending on the network conditions.
- Some USB/Digital camera devices may not be compatible with the product.
- HEVC codec is supported only for MKV, MP4 and TS containers.
- The DivX codec is not supported by models made for the U.S. or Canada.

■ Video decoder

- Supports up to H.264 Level 4.1. (Does not support FMO/ASO/RS)
- Does not support VC1/AP/L4.
- CODECs except for WMV v7, v8, MSMPEG4 v3, MVC, VP6
 - 1) Below 1280 x 720 : 60 frames max.
 - 2) Above 1280 x 720 : 30 frames max.
- Does not support GMC 2 or higher.
- Supports SVAf Top/Bottom, Side by Side, Left/Right view sequence type(2 ES)
- Supports BD MVC Spec.

■ Audio decoder

- Supports WMA 10 PRO (Up to 5.1ch).
- Does not support WMA lossless audio.
- Also supports the M2 profile.
- The RealAudio 10 lossless format is not supported by models made for China and Hong Kong.
- Does not support QCELP/AMR NB/WB.
- Supports vorbis (Up to 2ch).

- Supports DD+ (Up to 7.1ch)
- The DTS LBR codec is supported only for MKV / MP4 / TS containers.

□ Supported DivX subtitle file formats

*.txt, *.smi, *.srt, *.sub, *.txt

| NOTE |

- ▶ Some DivX, MKV and MP4 format discs may not play, depending on their video resolution and frame rate.

Supported Subtitle File Formats

	Name	File Extension
External	MPEG-4 Timed text	.txt
	SAMI	.smi
	SubRip	.srt
	SubViewer	.sub
	Micro DVD	.sub or .txt
	SubStation Alpha	.ssa
	Advanced SubStation Alpha	.ass
	Powerdivx	.psb
	SMPTE-TT Text	.xml
Internal	Xsub	AVI
	SubStation Alpha	MKV
	Advanced SubStation Alpha	MKV
	SubRip	MKV
	VobSub	MKV
	MPEG-4 Timed text	MP4
	TTML in smooth streaming	MP4
	SMPTE-TT TEXT	MP4
	SMPTE-TT PNG	MP4

Supported Music File Formats

File Extension	Type	Codec	Support Range
*.mp3	MPEG	MPEG1 Audio Layer 3	-
*.m4a *.mpa *.aac	MPEG4	AAC	-
*.flac	FLAC	FLAC	24bit/192kHz Supports up to two channels.
*.ogg	OGG	Vorbis	Supports up to two channels.
*.wma	WMA	WMA	For WMA 10 Pro supports up to M2 profile and 5.1 channels. WMA lossless audio is not supported.
*.wav	wav	wav	-
*.mid *.midi	midi	midi	Type 0, type 1 and Seek is not supported. Only available with USB.
*.ape	ape	ape	-
*.aif *.aiff	AIFF	AIFF	-
*.m4a	ALAC	ALAC	-

Supported Picture File Formats

File Extension	Type	Resolution
*.jpg *.jpeg	JPEG	15360x8640
*.png	PNG	4096x4096
*.bmp	BMP	4096x4096

Notes on the USB connection

- This player supports USB storage media, MP3 players, digital cameras, and USB card readers.
- Some USB/digital camera devices may not be compatible with the player.
- This player supports the FAT16, FAT32, and NTFS file systems.
- Connect USB devices directly to the player's USB port. Connecting through a USB cable may cause compatibility problems.
- Inserting more than one memory device into a multi-card reader may cause the reader to operate improperly.
- The player does not support the PTP (Peer to Peer) protocol.
- Do not disconnect a USB device while it is transferring or recording data.
- The bigger the image resolution, the longer the image takes to display.
- This player cannot play MP3 files with DRM (Digital Rights Management) downloaded from commercial sites.
- This player only supports video that is under 30fps (frame rate).
- This player only supports USB Mass Storage Class (MSC) devices such as thumb drives and USB HDD. (HUB is not supported.)
- Certain USB HDD Devices, multi-card readers and thumb drives may not be compatible with this player.
- If some USB devices require excessive power, they may be limited by the circuit safety device.

- If playback from a USB HDD is unstable, provide additional power by plugging the HDD into a wall socket.
If the problem continues, contact the USB HDD manufacturer.
- SAMSUNG is not responsible for any data file damage or data loss.
- This player does not support NTFS compressed, sparse, or encrypted files.
 - You can repair or format a USB device on your Desktop PC. (MS-Windows OS only)

AVCHD (Advanced Video Codec High Definition)

- This player can play back AVCHD format discs. These discs are normally recorded and used in camcorders.
- The AVCHD format is a high definition digital video camera format.
- The MPEG-4 AVC/H.264 format compresses images with greater efficiency than the conventional image compressing format.
- Some AVCHD discs use the "x.v.Colour" format. This player can play back AVCHD discs that use "x.v.Colour" format.
- "x.v.Colour" is a trademark of Sony Corporation.
- "AVCHD" and the AVCHD logo are trademarks of Matsushita Electronic Industrial Co., Ltd. and Sony Corporation.

| NOTES |

- ▶ Some AVCHD format discs may not play, depending on the recording conditions. AVCHD format discs need to be finalised.
- ▶ "x.v.Colour" offers a wider colour range than normal DVD camcorder discs.

Compliance and Compatibility Notice

NOT ALL discs are compatible

- Subject to the restrictions described below and those noted throughout this Manual, including the Disc Type and Characteristics section of this user manual, disc types that can be played are: pre-recorded commercial Ultra HD BD-ROM, BD-ROM, DVD-VIDEO, and Audio CD (CD-DA); BD-RE/-R, DVD-RW/-R; and CD-RW/-R.
- Discs other than the above cannot and/or are not intended to be played by this player. And some of the above discs may not play due to one or more reasons provided below.
- Samsung cannot assure that this player will play every disc bearing the Ultra HD BD-ROM, BD-ROM, BD-RE/-R, DVD-VIDEO, DVD-RW/-R, DVD+RW/+R and CD-RW/-R logos, and this player may not respond to all operating commands or operate all features of every disc. These and other disc compatibility and player operation issues with new and existing format discs are possible because:
 - Ultra HD Blu-ray/Blu-ray is a new and evolving format and this player may not operate all features of Ultra HD Blu-ray Discs/Blu-ray Discs because some features may be optional, additional features may have been added to the Ultra HD Blu-ray Disc/Blu-ray Disc format after the production of this player, and certain available features may be subject to delayed availability;
 - not all new and existing disc format versions are supported by this player;
 - new and existing disc formats may be revised, changed, updated, improved and/or supplemented;
 - some discs are produced in a manner that allows specific or limited operation and feature during playback;
 - some features may be optional, additional features may have been added after the production of this player or certain available features may be subject to delayed availability;
 - some discs bearing the Ultra HD BD-ROM, BD-ROM, BD-RE/-R, DVD-VIDEO, DVD-RW/-R, DVD+RW/+R and CD-RW/-R logos may still be non-standardized discs;
 - some discs may not be played depending on their physical state or recording conditions;
 - problems and errors can occur during the creation of Ultra HD Blu-ray Disc, Blu-ray Disc, or DVD disc software and/or during the manufacture of discs;
 - this player operates differently than a standard DVD player or other AV equipment; and/or
 - for reasons noted throughout this user manual and for other reason(s) discovered and posted by SAMSUNG customer care Centre.
- If you encounter disc compatibility or player operation problems, please contact SAMSUNG customer care Centre.
You may also contact SAMSUNG customer care Centre for possible updates on this player.
- For additional information on playback restrictions and disc compatibility, refer to the Precautions, Before Reading the user manual, Disc Types and Characteristics, and Before Playing sections of this user manual.
- **For product progressive scan output** : CONSUMERS SHOULD NOTE THAT NOT ALL HIGH DEFINITION TELEVISION SETS ARE FULLY COMPATIBLE WITH THIS PRODUCT AND MAY CAUSE ARTIFACTS TO BE DISPLAYED IN THE PICTURE. IN CASE OF PROGRESSIVE SCAN PICTURE PROBLEMS, IT IS RECOMMENDED THAT THE USER SWITCH THE CONNECTION TO THE 'STANDARD DEFINITION' OUTPUT. IF THERE ARE QUESTIONS REGARDING OUR TV SET COMPATIBILITY WITH THIS PRODUCT, PLEASE CONTACT OUR CUSTOMER SERVICE CENTRE.

Copy Protection

- Because AACS (Advanced Access Content System) is approved as content protection system for Ultra HD Blu-ray Disc and Blu-ray Disc format, similar to use of CSS (Content Scramble System) for DVD format, certain restrictions are imposed on playback, analogue signal output, etc., of AACS protected contents.
The operation of this product and restrictions on this product may vary depending on your time of purchase as those restrictions may be adopted and/or changed by AACS after the production of this product. Furthermore, BD-ROM Mark and BD+ are additionally used as content protection systems for Ultra HD Blu-ray Disc and Blu-ray Disc formats, which imposes certain restrictions including playback restrictions for BD-ROM Mark and/or BD+ protected contents. To obtain additional information on AACS, BD-ROM Mark, BD+, or this product, please contact SAMSUNG customer care Centre.
- Many Ultra HD Blu-ray Discs/Blu-ray Discs/DVDs are encoded with copy protection. Because of this, you should only connect your Player directly to your TV, not to a VCR. Connecting to a VCR results in a distorted picture from copy-protected Ultra HD Blu-ray Discs/Blu-ray Discs/DVDs.
- Under the U.S. Copyright laws and Copyright laws of other countries, unauthorized recording, use, display, distribution, or revision of television programs, videotapes, Ultra HD Blu-ray Discs, Blu-ray Discs, DVDs, and other materials may subject you to civil and/or criminal liability.
- **Cinavia Notice** : This product uses Cinavia technology to limit the use of unauthorised copies of some commercially-produced film and videos and their soundtracks. When a prohibited use of an unauthorised copy is detected, a message will be displayed and playback or copying will be interrupted.

More information about Cinavia technology is provided at the Cinavia Online Consumer Information Centre at <http://www.cinavia.com>. To request additional information about Cinavia by mail, send a postcard with your mailing address to: Cinavia Consumer Information Centre, P.O. Box 86851, San Diego, CA, 92138, USA.

This product incorporates proprietary technology under Licence from Verance Corporation and is protected by U.S. Patent 7,369,677 and other U.S. and worldwide patents issued and pending as well as copyright and trade secret protection for certain aspects of such technology. Cinavia is a trademark of Verance Corporation. Copyright 2004-2015 Verance Corporation. All rights reserved by Verance. Reverse engineering or disassembly is prohibited.

Network Service Disclaimer

All content and services accessible through this device belong to third parties and are protected by copyright, patent, trademark and/or other intellectual property laws. Such content and services are provided solely for your personal noncommercial use. You may not use any content or services in a manner that has not been authorised by the content owner or service provider. Without limiting the foregoing, unless expressly authorised by the applicable content owner or service provider, you may not modify, copy, republish, upload, post, transmit, translate, sell, create derivative works, exploit, or distribute in any manner or medium any content or services displayed through this device.

Appendix

THIRD PARTY CONTENT AND SERVICES ARE PROVIDED "AS IS." SAMSUNG DOES NOT WARRANT CONTENT OR SERVICES SO PROVIDED, EITHER EXPRESSLY OR IMPLIEDLY, FOR ANY PURPOSE. SAMSUNG EXPRESSLY DISCLAIMS ANY IMPLIED WARRANTIES, INCLUDING BUT NOT LIMITED TO, WARRANTIES OF MERCHANTABILITY OR FITNESS FOR A PARTICULAR PURPOSE. SAMSUNG DOES NOT GUARANTEE THE ACCURACY, VALIDITY, TIMELINESS, LEGALITY, OR COMPLETENESS OF ANY CONTENT OR SERVICE MADE AVAILABLE THROUGH THIS DEVICE AND UNDER NO CIRCUMSTANCES, INCLUDING NEGLIGENCE, SHALL SAMSUNG BE LIABLE, WHETHER IN CONTRACT OR TORT, FOR ANY DIRECT, INDIRECT, INCIDENTAL, SPECIAL OR CONSEQUENTIAL DAMAGES, ATTORNEY FEES, EXPENSES, OR ANY OTHER DAMAGES ARISING OUT OF, OR IN CONNECTION WITH, ANY INFORMATION CONTAINED IN, OR AS A RESULT OF THE USE OF ANY CONTENT OR SERVICE BY YOU OR ANY THIRD PARTY, EVEN IF ADVISED OF THE POSSIBILITY OF SUCH DAMAGES.

Third party services may be terminated or interrupted at any time, and Samsung makes no representation or warranty that any content or service will remain available for any period of time. Content and services are transmitted by third parties by means of networks and transmission facilities over which Samsung has no control. Without limiting the generality of this disclaimer, Samsung expressly disclaims any responsibility or liability for any interruption or suspension of any content or service made available through this device.

Samsung is neither responsible nor liable for customer service related to the content and services. Any question or request for service relating to the content or services should be made directly to the respective content and service providers.

Licences

- Manufactured under license from Dolby Laboratories. Dolby, Dolby Audio, Pro Logic, and the double-D symbol are trademarks of Dolby Laboratories.



- For DTS patents, see <http://patents.dts.com>. Manufactured under license from DTS Licensing Limited. DTS, the Symbol, DTS in combination with the Symbol, the DTS-HD logo, and DTS-HD Master Audio are registered trademarks or trademarks of DTS, Inc. in the United States and/or other countries. © DTS, Inc. All Rights Reserved.



- DivX

This DivX Certified[®] device can play DivX[®] HD video files (including .avi, .divx). Download free software at www.divx.com to create, play and stream digital videos. To play purchased DivX movies, first register your device at vod.divx.com. Find your registration code in the DivX VOD section of your device setup menu.



This DivX Certified[®] device can play DivX[®] HD video (including .avi, .divx).

DivX[®], DivX Certified[®] and associated logos are trademarks of DivX, LLC and are used under license. Covered by one or more of the following U.S. patents: 7,295,673; 7,460,668; 7,515,710; 8,656,183; 8,731,369; RE45,052.

- The terms HDMI and HDMI High-Definition Multimedia Interface, and the HDMI Logo are trademarks or registered trademarks of HDMI Licensing LLC in the United States and other countries.
- Oracle and Java are registered trademarks of Oracle and/or its affiliates. Other names may be trademarks of their respective owners.
- Open Source Licence Notice
 - In the case of using open source software, Open Source Licences are available on the product menu.
- Blu-ray Disc™, Blu-ray™, Ultra HD Blu-ray Disc™, Ultra HD Blu-ray™ and the logos are trademarks of the Ultra HD Blu-ray Disc/Blu-ray Disc Association.



Hereby, Samsung Electronics, declares that this equipment is in compliance with Directive 2014/53/EU.

The full text of the EU declaration of conformity is available at the following internet address: <http://www.samsung.com> go to Support > Search Product Support and enter the model name.

This equipment may be operated in all EU countries.

The 5GHz WLAN(Wi-Fi or SRD) function of this equipment may only be operated indoors.



Appendix

Specifications

General	Weight	1.9 kg
	Dimensions	406.0 (W) X 44.7 (H) X 230.0 (D) mm
	Operating Temperature Range	+5°C to +35°C
	Operating Humidity Range	10 % to 75 %
USB	Type A	USB 2.0
	DC output	5V 500mA Max.
HDMI	Video	2160p, 1080p, 720p, 576p/480p
	Audio	PCM, Bitstream
Audio Output	Digital Audio Output	Optical
Network	Ethernet	100BASE - TX Terminal
	Wireless LAN	Built-in
	Security	WEP (OPEN/SHARED) WPA-PSK (TKIP/AES) WPA2-PSK (TKIP/AES)
	WPS(PBC)	Supported
Wireless device output power	Wi-Fi max transmitter power	100mW at 2.4GHz – 2.4835GHz, 5.15GHz – 5.35GHz & 5.47GHz – 5.725GHz

- Network speeds equal to or below 10Mbps are not supported.
- Design and specifications are subject to change without prior notice.
- For information about the power supply and power consumption, refer to the label attached to the product.
- Weight and dimensions are approximate.

Overall Standby Power Consumption (W)		1.6W
Wi-Fi	Port Deactivation Method	HOME >  Settings > General > System Manager > WoL/WoWLAN On/Off

- An administration fee may be charged if either
 - (a) an engineer is called out at your request and there is no defect in the product (i.e. where you have failed to read this user manual).
 - (b) you bring the unit to a repair centre and there is no defect in the product (i.e. where you have failed to read this user manual).
- The amount of such administration charge will be advised to you before any work or home visit is carried out.



Correct disposal of batteries in this product

(Applicable in the European Union and other European countries with separate battery return systems.)

This marking on the battery, manual or packaging indicates that the batteries in this product should not be disposed of with other household waste at the end of their working life. Where marked, the chemical symbols *Hg*, *Cd* or *Pb* indicate that the battery contains mercury, cadmium or lead above the reference levels in EC Directive 2006/66.

If batteries are not properly disposed of, these substances can cause harm to human health or the environment.

To protect natural resources and to promote material reuse, please separate batteries from other types of waste and recycle them through your local, free battery return system.



Correct Disposal of This Product (Waste Electrical & Electronic Equipment)

(Applicable in the European Union and other European countries with separate collection systems)

This marking on the product, accessories or literature indicates that the product and its electronic accessories (e.g. charger, headset, USB cable) should not be disposed of with other household waste at the end of their working life.

To prevent possible harm to the environment or human health from uncontrolled waste disposal, please separate these items from other types of waste and recycle them responsibly to promote the sustainable reuse of material resources.

Household users should contact either the retailer where they purchased this product, or their local government office, for details of where and how they can take these items for environmentally safe recycling.

Business users should contact their supplier and check the terms and conditions of the purchase contract.

This product and its electronic accessories should not be mixed with other commercial wastes for disposal.

For information on Samsung's environmental commitments and product specific regulatory obligations e.g. REACH, WEEE, Batteries, visit:

http://www.samsung.com/uk/aboutsamsung/samsungelectronics/corporatecitizenship/data_corner.html



UNITED KINGDOM



EIRE

This Samsung product is warranted for the period of twelve (12) months from the original date of purchase, against defective materials and workmanship. In the event that warranty service is required, you should return the product to the retailer from whom it was purchased. However, Samsung Authorised Dealers and Authorised Service Centres in other EC Countries will comply with the warranty on the terms issued to purchasers in the country concerned. In case of difficulty, details of our Authorised Service Centres are available from:

Samsung Electronics U.K. Ltd
Samsung Customer Support Centre
Selectapost 38, Sheffield, S97 3FJ
United Kingdom

United Kingdom
Tel : 0330 SAMSUNG (7267864)
www.samsung.com/uk/support

EIRE
Tel : 0818 717100
www.samsung.com/ie/support

■ **WARRANTY CONDITIONS**

1. The warranty is only valid if, when warranty service is required, the warranty card is fully and properly completed and is presented with the original invoice or sales slip or confirmation, and the serial number on the product has not been defaced.
2. Samsung's obligations are limited to the repair or, at its discretion, replacement of the product or the defective part.
3. Warranty repairs must be carried out by Authorised Samsung Dealers or Authorised Service Centres. No re-imbusement will be made for repairs carried out by non Samsung Dealers and, any such repair work and damage to the products caused by such repair work will not be covered by this warranty.
4. This product is not considered to be defective in materials nor workmanship by reason that it requires adaptation in order to conform to national or local technical or safety standards in force in any Country other than the one for which the product was originally designed and manufactured. This warranty will not cover, and no re-imbusement will be made for such adaptation nor any damage which may result.
5. This warranty covers none of the following:
 - a) Periodic check ups, maintenance and repair or replacement of parts due to normal wear and tear.
 - b) Cost relating to transport, removal or installation of the product.
 - c) Misuse, including the failure to use this product for its normal purposes or incorrect installation.
 - d) Damage caused by Lightning, Water, Fire, Acts of God, War, Public Disturbances, incorrect mains voltage, improper ventilation or any other cause beyond the control of Samsung.
6. This warranty is valid for any person who legally acquired possession of the product during the warranty period.
7. The consumers statutory rights in any applicable national legislation whether against the retailer arising from the purchase contract or otherwise are not affected by this warranty. Unless there is national legislation to the contrary, the rights under this warranty are the consumers sole rights and Samsung, its subsidiaries and distributors shall not be liable for indirect or consequential loss or any damage to records, compact discs, videos or audio taper or any other related equipment or material.

SAMSUNG ELECTRONICS (U.K.) LTD.

SAMSUNG

© 2017 Samsung Electronics Co., Ltd. All rights reserved.

Contact SAMSUNG WORLD WIDE

If you have any questions or comments relating to Samsung products, please contact the SAMSUNG customer care centre.

Country	Contact Centre ☎	Web Site
■ Europe		
UK	0330 SAMSUNG (7267864)	www.samsung.com/uk/support
IRELAND (EIRE)	0818 717100	www.samsung.com/ie/support
GERMANY	06196 77 555 77	www.samsung.com/de/support
FRANCE	01 48 63 00 00	www.samsung.com/fr/support
ITALIA	800-SAMSUNG (800.7267864)	www.samsung.com/it/support
SPAIN	0034902172678	www.samsung.com/es/support
PORTUGAL	808 207 267	www.samsung.com/pt/support
LUXEMBURG	261 03 710	www.samsung.com/be_fr/support
NETHERLANDS	088-9090100 (lokaal tarief)	www.samsung.com/nl/support
BELGIUM	02-201-24-18	www.samsung.com/be/support (Dutch) www.samsung.com/be_fr/support (French)
NORWAY	815 56480	www.samsung.com/no/support
DENMARK	707 019 70	www.samsung.com/dk/support
FINLAND	030-6227 515	www.samsung.com/fi/support
SWEDEN	0771 726 786	www.samsung.com/se/support
POLAND	801-172-678* lub +48 22 607-93-33* * (koszt połączenia według taryfy operatora)	www.samsung.com/pl/support
HUNGARY	0680SAMSUNG (0680-726-7864)	www.samsung.com/hu/support

Country	Contact Centre ☎	Web Site
AUSTRIA	0800-SAMSUNG (0800-7267864) [Only for Dealers] 0810-112233	www.samsung.com/at/support
SWITZERLAND	0800 726 78 64 (0800-SAMSUNG)	www.samsung.com/ch/support (German) www.samsung.com/ch_fr/support (French)
CZECH	800 - SAMSUNG (800-726786)	www.samsung.com/cz/support
SLOVAKIA	0800 - SAMSUNG (0800-726 786)	www.samsung.com/sk/support
CROATIA	072 726 786	www.samsung.com/hr/support
BOSNIA	055 233 999	www.samsung.com/support
MONTENEGRO	020 405 888	www.samsung.com/support
SLOVENIA	080 697 267 (brezplačna številka)	www.samsung.com/si/support
SERBIA	011 321 6899	www.samsung.com/rs/support
BULGARIA	*3000 Цена в мрежата 0800 111 31 , Безплатна телефонна линия	www.samsung.com/bg/support
ROMANIA	*8000 (apel in retea) 08008-726-78-64 (08008-SAMSUNG) Apel GRATUIT	www.samsung.com/ro/support
CYPRUS	8009 4000 only from landline, toll free	
GREECE	80111-SAMSUNG (80111 726 7864) only from land line (+30) 210 6897691 from mobile and land line	www.samsung.com/gr/support
LITHUANIA	8-800-7777	www.samsung.com/lt/support
LATVIA	8000-7267	www.samsung.com/lv/support
ESTONIA	800-7267	www.samsung.com/ee/support