

DCS-6111

Version 2.0

**Fixed Dome Day & Night
Network Camera w/ WDR Sensor**

 **Quick Install Guide**

Minimum System Requirements

- Internet Explorer 6.x or above
- Windows® XP or Windows Vista®
- 1.7GHz processor or higher
- 256MB of RAM
- 1 Ethernet connection

Package Contents



DCS-6111
WDR D&N Fixed
Dome Network
Camera



Dome Enclosure



Ring Enclosure



CD-ROM with Manual
and Setup Wizard



AC Power Adapter



CAT5 Ethernet Cable



Screwdriver



Screws and I/O
Connector

If any of the above items are missing, please contact your reseller.

Hardware Overview

Connections

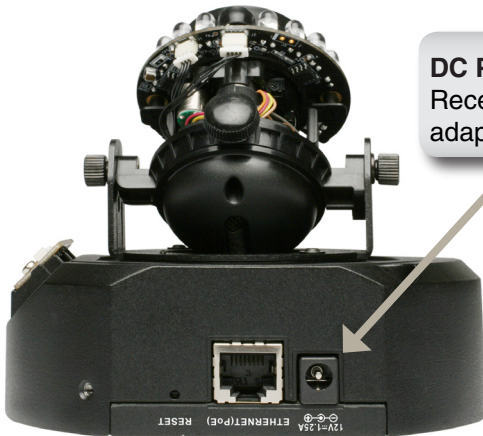

DC Power Connector
Receptor for the supplied power adapter.

Ethernet Cable Connector (PoE)

The IP camera's side panel features an RJ-45 connector for connections to 10Base-T Ethernet cabling or 100Base-TX Fast Ethernet cabling. This network port supports the NWay protocol, allowing this IP camera to automatically detect or negotiate the transmission speed of the network. The Ethernet port can also be used to power the camera by using a PoE switch.

Reset Button

Press and hold the reset button until the Power LED flashes through its cycle twice. This will reset the camera to its factory default settings.



LEDs



Hardware Installation

When Mounting to a Ceiling

Find a suitable place to install the camera by using the alignment stencil. Place the camera at the desired operating location and insert the screws through the two holes located at the base of the camera. Use screwdriver to tighten and secure.

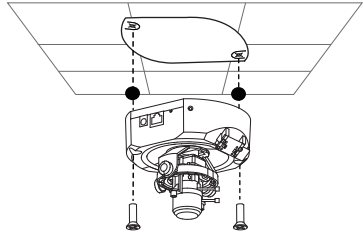

When Mounting to a Wall

Find a suitable place to install the camera by using the alignment stencil to find a desired operating location on the wall. Drill two pilot holes where the holes of the alignment stencil are located. Insert the supplied plastic anchors into the drilled holes, and align the holes at the base of the camera with the plastic anchors. Once aligned, insert the provided screws through the holes. Use screwdriver to tighten and secure.

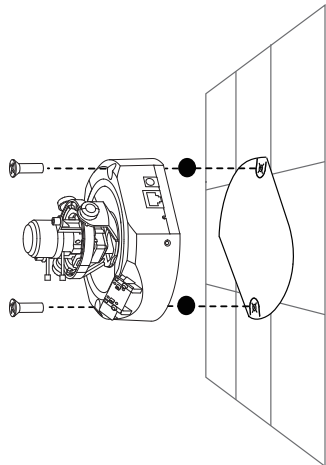

Network Deployment

General Connection (without PoE)

Connect the IP camera to a switch or router via Ethernet cable and connect the supplied power cable from the camera to a power outlet.

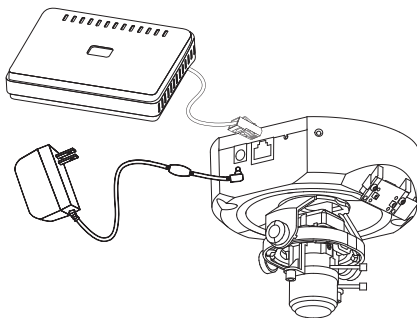

Connection with a PoE Switch

If using a PoE switch or router, connect the IP camera via Ethernet cable, which will provide both power and data transmission over a single cable.

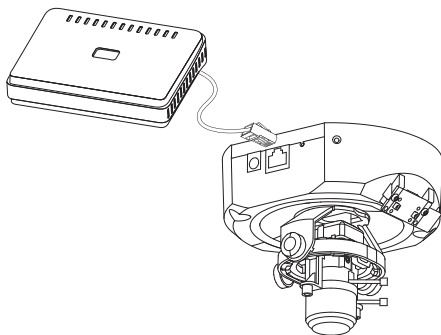

Software Installation

Turn on the computer and insert the D-Link DCS-6111 Autorun CD into the CD-ROM drive. The following step-by-step instructions displayed are shown when using Windows Vista® operating system. The steps and screens are similar when using other Windows® operating systems.

Click **Installation Wizard**



Click **Next** to continue.

Click **Next**

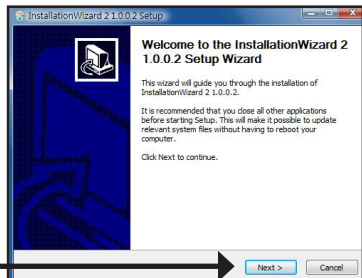

Click **I Agree** to accept the License Agreement.

Click **I Agree**

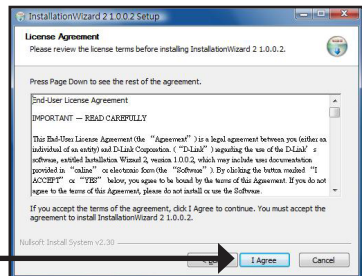

To start the installation click **Install**.

Note: *The installation may take several minutes to complete.*

Click **Install**

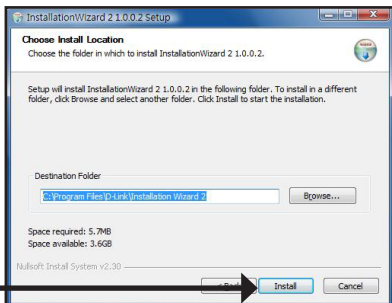

Click **Finish** to complete the installation.

Click **Finish**

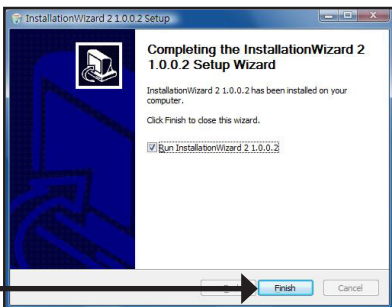

Configuring Your Camera with the Installation Wizard

Click on the D-Link Installation Wizard icon that was created in your Windows Start menu.

The Installation Wizard will appear and show the MAC address of your DCS-6111 and an IP Address (which may or may not be correct depending on what you have your DCS-6111 connected to). If you have a DHCP server on your network, there will be a valid IP Address displayed here.

Note: A DHCP server is a device that supplies the IP address such as a router.

Click **Manual Setup**

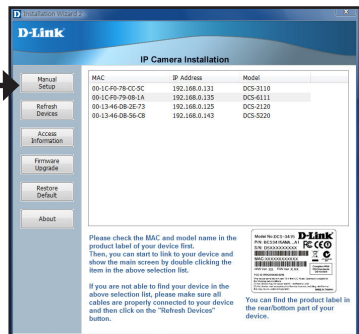

Enter and confirm a password if you wish to assign one for your admin account. Click **Next** to continue.

Note: The default Admin ID is **admin** with the password left blank.

Click **Next**

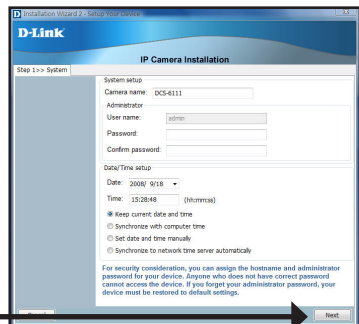

Configuration

A new window will pop up to ask if you want to setup a PPPoE for the device. Click **No** for quick setup. For further information, refer to the user manual for details.

Click **No**

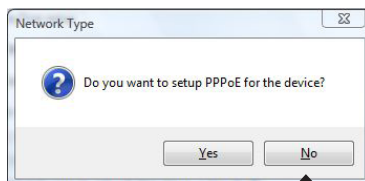

Check the Get IP by DHCP Server automatically box to obtain a new IP address every time the camera starts up. Click **Next** to continue.

Click **Next**

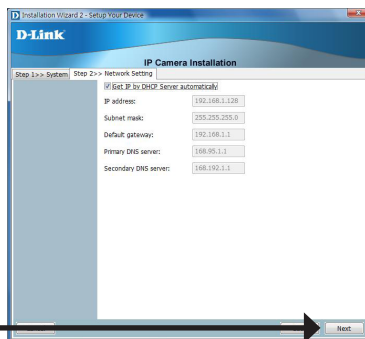

Select UPnP Port Forwarding if your router supports this function. If not, choose Manual to manually enter your port numbers. Click **Next** to continue.

Click **Next**

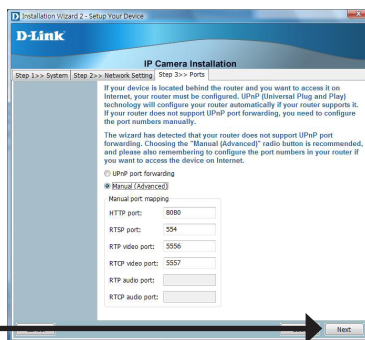

Click **Next** to continue.

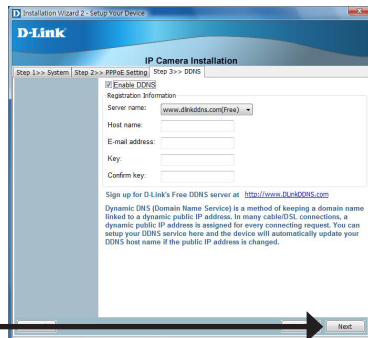

A window will pop up asking you if you want to access the DCS-6111 via mobile phone. Clicking **Yes** will set the video resolution to 176x144.

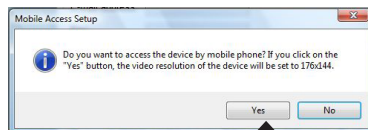

Click **Apply** to apply the settings listed in the window to the device. Application may take a few minutes to process.

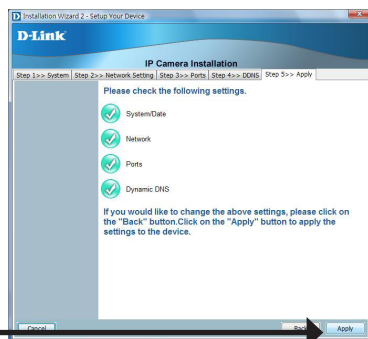

Configuration

A window will pop up to confirm that the application was successfully configured. Click **OK** to continue.

A new window will pop up displaying the links/addresses to access your device. Click **Add** to my favorite to save the address and then click **Exit** to complete the installation.

Click **Exit**



Double-click the DCS-6111 to launch the camera's web configuration page.

Note: Please see the user manual for more information.

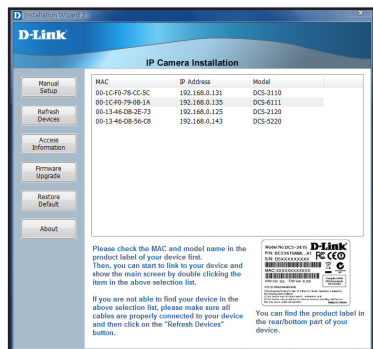

Enter **admin** as the default username and leave the password blank. Click **OK** to continue.

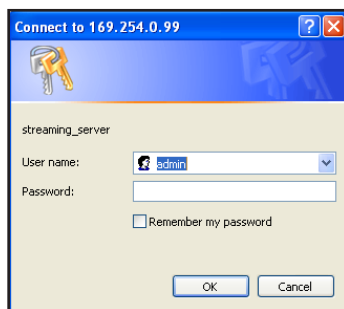

This section shows your camera's live video. You may control the settings using the buttons at the bottom. For more information on using the web configuration, please refer to the user manual.

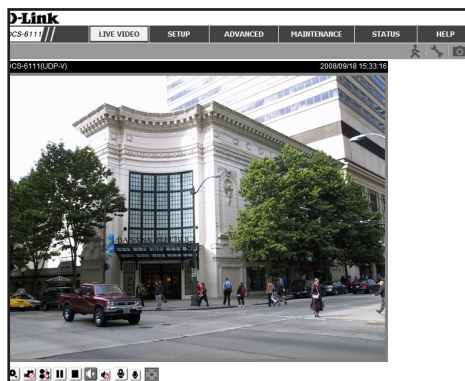

Adjusting the Lens

Based on the live image retrieved from the camera, adjust the camera lens by performing the following procedures:

Adjusting the Viewing Angle

Loosen the pan screw and turn the lens module left and right until the desired position is achieved; tighten the pan screw once completed.

Loosen the tilt screws on both sides of the camera, and turn the lens module up and down until the desired position is achieved; tighten the tilt screws once completed.

Loosen the image adjustment screw and turn the lens to adjust the IP camera's image until the desired orientation is achieved, tighten the image adjustment screw once completed.

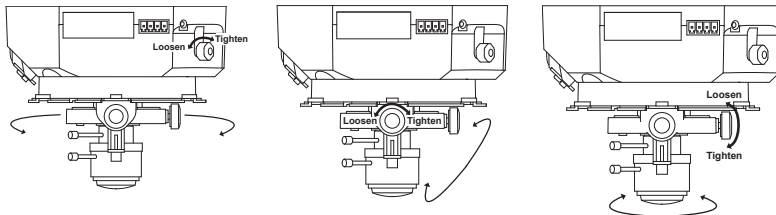

Adjusting Zoom and Focus

Loosen the zoom controller and adjust the zoom factor by moving the controller left and right until the desired range is achieved. Tighten the zoom controller once completed.

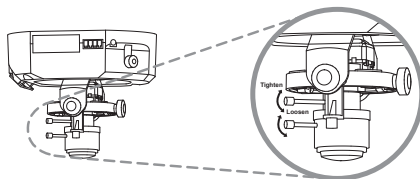

Loosen the focus controller and adjust the focus range by moving the controller left and right until the image is clear. Tighten the focus controller once completed.

Attaching the Enclosure

Once the lens is properly adjusted, rearrange the light shield so that it will not obstruct the lens during surveillance.

Place the dome enclosure over the IP camera so that the LED sticker on the dome enclosure is properly aligned with the camera's LED. Insert the supplied screws into the two holes located at the base of the dome enclosure, tighten until secure.

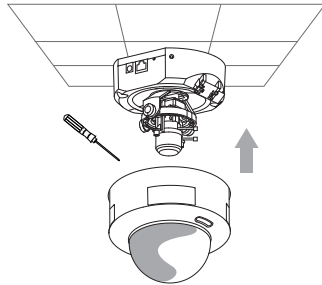

Place the ring enclosure over the dome enclosure. Once placed, gently turn the ring enclosure clockwise until it locks and is securely attached to the dome enclosure.

Note: When attaching the ring enclosure, be sure to first align the line on the ring enclosure with the triangle on the dome enclosure. When attachment is successfully made, the line on the ring enclosure will be aligned with the line on the dome enclosure.

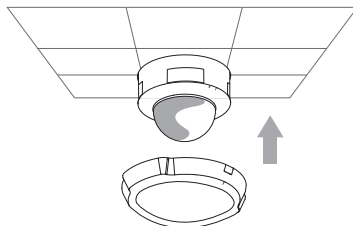

Technical Support

D-Link's website contains the latest user documentation and software updates for D-Link products.

U.S. and Canadian customers can contact D-Link Technical Support through our website or by phone.

United States

Telephone

(877) 354-6555

World Wide Web

<http://support.dlink.com>

Canada

Telephone

(877) 354-6560

World Wide Web

<http://support.dlink.ca>



Version 2.0
March 31, 2010
625006801G

Copyright ©2008-2010 D-Link Corporation/D-Link Systems, Inc. All rights reserved. D-Link and the D-Link logo are registered trademarks of D-Link Corporation or its subsidiaries in the United States and other countries. Other trademarks are the property of their respective owners. Actual data throughput will vary. Network conditions and environmental factors, including volume of network traffic, building materials and construction, and network overhead lower actual data throughput rate. Product specifications, size and shape are subject to change without notice, and actual product appearance may differ from that depicted on the packaging. Visit www.dlink.com for more details.