



SCETAWL

EL. HÖHENVERSTELLBARES SYSTEM ZUR WANDMONTAGE
EL. HEIGHT ADJUSTABLE SYSTEM FOR WALL MOUNTING

Conen Produkte GmbH & Co. KG
Conenstr. 4
54497 Morbach-Gonzerath
Germany

Tel.: +49 (0) 6533 75 - 203/ - 300
Fax: +49 (0) 6533 75 - 600
eMail: info@conen-interaktiv.de

www.conen-interaktiv.de

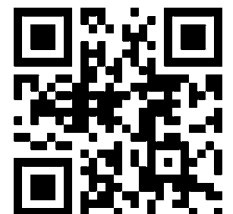

PRODUKTEIGENSCHAFTEN | PRODUCT FEATURES

- ◆ Elektrisch höhenverstellbare Pylone, natur eloxiert
- ◆ 500 mm Hub
- ◆ Geeignet zur Montage an massiver Wand, Standardwandabstand: 70 mm, 4 Bodenausgleichsfüße
- ◆ Halterung zur Verwendung mit 42" – 100" Display
- ◆ VESA 200 x 200 bis 800 x 600
- ◆ Maximale Belastung ca. 150 kg
- ◆ Electrical height adjustable column, natural anodized
- ◆ 500 mm height adjustment
- ◆ System suitable for wall mounting on massive walls, wall clearance by default 70 mm, 4 leveling feet
- ◆ Mount for use with 42" – 100" display
- ◆ VESA 200 x 200 up to 800 x 600
- ◆ Maximum load approximately 150 kg

HÖCHSTE STELLUNG | HIGHEST POSITION

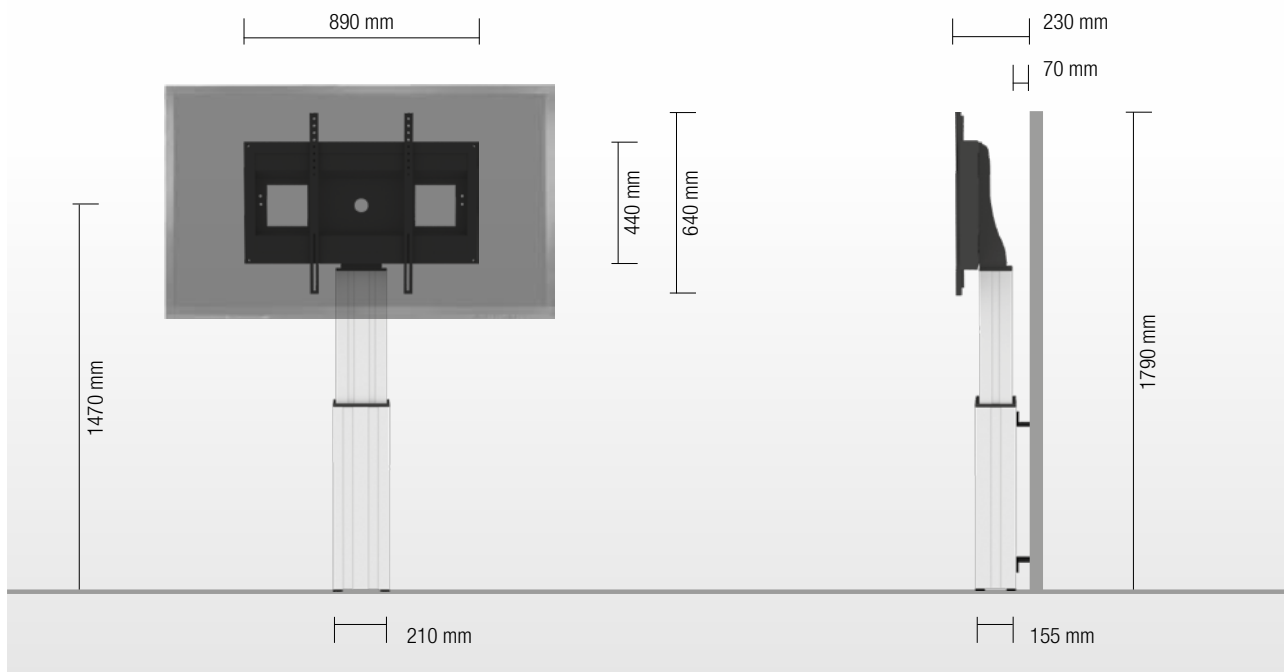

NIEDRIGSTE STELLUNG | LOWEST POSITION

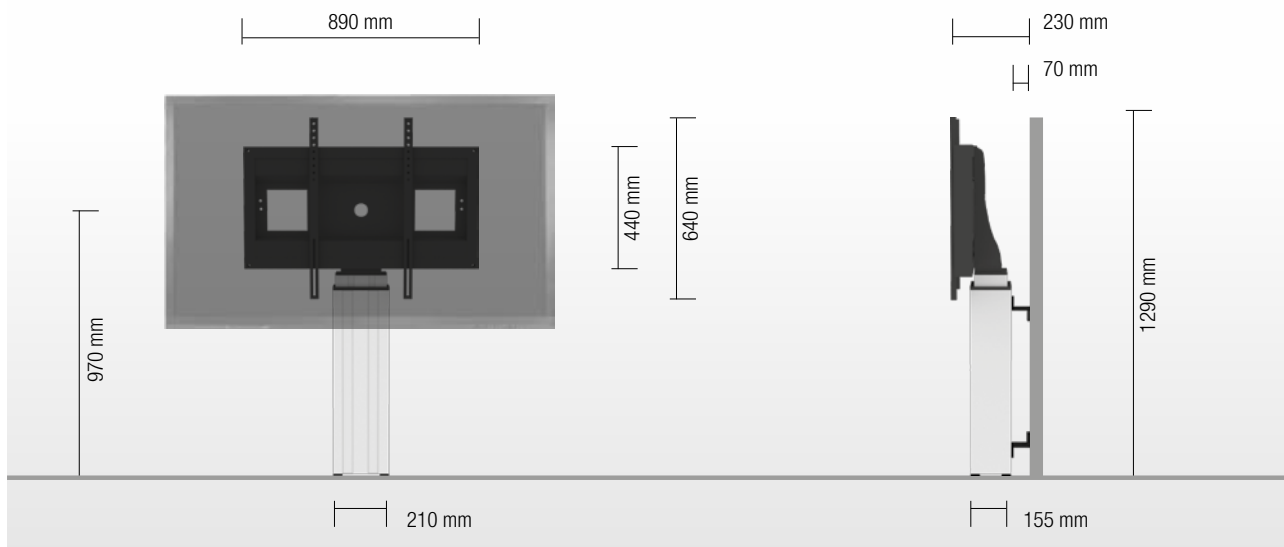

DETAILANSICHTEN | DETAIL VIEWS



Schnappklammern erleichtern die Montage
Pull & release locking brackets for easier mounting of display



BodenausgleichsfüÙe
Leveling feet



Elektrische Höhenverstellung
Wired remote control

WÄHLBARES ZUBEHÖR | AVAILABLE ACCESSORIES

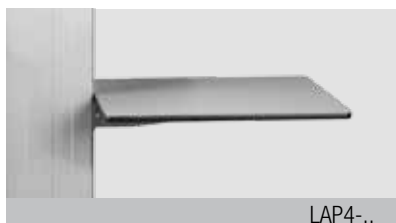

LAP4-..

Seitentisch
Side shelf



FSH-..

Ablagetisch
Front shelf



MINI-FUJI

Abschließbare Mini-PC Halterung
Lockable mini PC bracket



AFSCETAKB

Tastaturhalterung
Keyboard shelf



LAP-CAB

Verschließbarer Notebookschrank
Lockable notebook cabinet

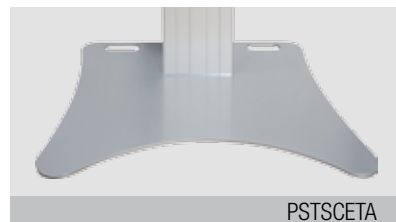

PSTSCETA

Bodenplatte
Floor plate

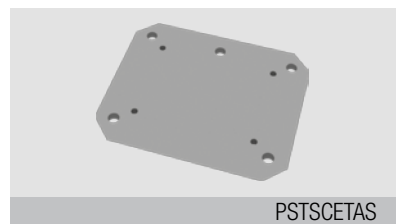

PSTSCETAS

Platte zur Bodenmontage
Plate to groundfixing



REM-FOOT

Fußschalter
Foot remote control



CCE-EXT20

Verlängerung (200 mm)
Extender (200 mm)



SCHLIESS-VH

Display Sicherheitsschloss
Display securing padlock

GRÖßENINDEX | SIZE INDEX

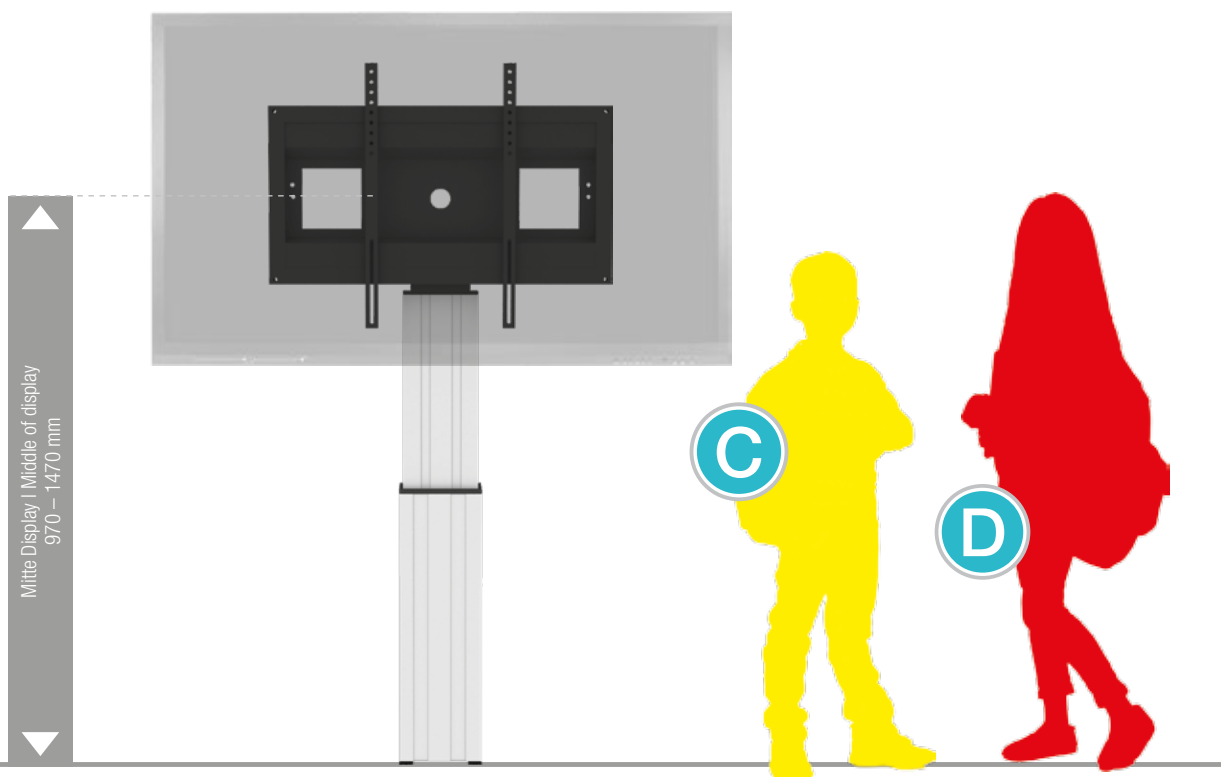

Bereich Department	Kindergarten			Grundschule Primary school		Weiterführende Schule Secondary school		Erwachsene Adults
	A	B	C	D	E	F	G	
Silhouette Silhouette	A	B	C	D	E	F	G	
Alter (Jahre) Age (years)	2 – 3	3 – 4	4 – 7	6 – 11	11 – 14	13 – 16	ab from 16	
Körpergröße Body size (mm)	930 – 980	1080 – 1210	1190 – 1420	1330 – 1590	1460 – 1765	1590 – 1880	1740 – 2070	
Farbe Colour	Green	Purple	Yellow	Red	Green	Blue		

PACKEINHEITEN | PACKING UNITS

Artikel-Nr. Item no.	Beschreibung Description	Packmaße Packing dimensions (mm)	Nettogewicht Net weight (kg)	Bruttogewicht Gross weight (kg)
CCE50-W	Elektrisch höhenverstellbare Pylone, 500 mm Hub, L = 700 mm Electrical height adjustable column, 500 mm height adjustment, L = 700 mm	970 x 270 x 220	18,0	19,5
AF-SCETA-N	Display Halterung Display mount	160 x 900 x 450	11,7	13,6
Gesamtgewicht Total weight			28,7	33,1