

# SHARP®

# AQUOS

LIQUID CRYSTAL TELEVISION  
TÉLÉVISEUR À CRISTAUX  
LIQUIDES

TELEVISOR DE CRISTAL  
LÍQUIDO

OPERATION MANUAL  
MODE D'EMPLOI  
MANUAL DEL USUARIO

- Please choose your favorite page from the content.  
If you want to close the operation manual, press the **EXIT** button.  
Also, if you want to return to the previously displayed page, press the **RETURN** button.
- Veuillez choisir votre page favorite dans le contenu.  
Appuyez sur le bouton **EXIT** pour refermer le mode d'emploi. Par ailleurs, appuyez sur le bouton **RETURN** si vous souhaitez revenir à la page précédemment affichée.
- Elija su página favorita entre los contenidos.  
Si desea cerrar el manual de instrucciones, pulse el botón **EXIT**. Además, si desea volver a la página mostrada anteriormente, pulse el botón **RETURN**.





# Contents



## 1. Part Names

- 1-1. TV (For PN-LE601/701/801 models)
- 1-2. TV (For PN-LE901 model)
- 1-3. Remote Control Unit

## 2. Introduction

- 2-1. Displaying an External Equipment Image
- 2-2. Initial Installation

## 3. Direct Button Operation

- 3-1. Changing Channels
- 3-2. Changing Volume
- 3-3. MUTE
- 3-4. APPS
- 3-5. AUDIO
- 3-6. Sleep Timer

## 4. On-Screen Display Menu

- 4-1. Introduction
- 4-3. On-Screen Display Menu Operation
- 4-4. Menu Operation Buttons
- 4-5. Initial Setup
- 4-13. Information
- 4-16. Picture Settings
- 4-20. Audio Settings
- 4-21. Network Settings
- 4-23. System Options

## 5. Enjoying Photo/Music/Video Playback

- 5-1. Preparation
- 5-2. Selecting the Folders to Play Back
- 5-4. Playing Back Files on a USB Memory Device/Home Network Server

## 6. Using LINK Operation

- 6-1. Controlling HDMI Equipment Using LINK Operation
- 6-3. Link Operation Menu
- 6-5. Using a Smartphone with the TV

## 7. Using a PC

- 7-1. Adjusting the PC Image
- 7-2. Setting Audio Input
- 7-3. Control of the TV
- 7-9. PC Compatibility Chart

## 8. Using the Internet

- 8-1. Connecting to the Internet
- 8-2. Entering Text (Software Keyboard)
- 8-4. Using the Browser
- 8-8. Using Keyboard and Mouse

## 9. Using the Miracast devices

- 9-1. Miracast devices

## 10. Appendix

- 10-1. Removing the Stand
- 10-2. Setting the TV on the Wall
- 10-6. Troubleshooting

## 11. Specifications

- 11-1. TV (For PN-LE901 model)
- 11-2. TV (For PN-LE801/701/601 models)
- 11-3. Wireless LAN

## 12. Trademarks

## 13. Dimensional Drawings

## 14. Software License



# IMPORTANT INFORMATION



## IMPORTANT:

To aid reporting in case of loss or theft, please record the TV's model and serial numbers in the space provided. The numbers are located at the rear and left side of the TV.

Model No.:

Serial No.:

**WARNING:** TO REDUCE THE RISK OF FIRE OR ELECTRIC SHOCK, DO NOT EXPOSE THIS PRODUCT TO RAIN OR MOISTURE.

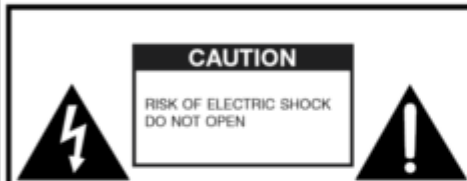

The lightning flash with arrow-head symbol, within an equilateral triangle, is intended to alert the user to the presence of uninsulated "dangerous voltage" within the product's enclosure that may be of sufficient magnitude to constitute a risk of electric shock to persons.

CAUTION: TO REDUCE THE RISK OF ELECTRIC SHOCK, DO NOT REMOVE COVER (OR BACK). NO USER-SERVICEABLE PARTS INSIDE. REFER SERVICING TO QUALIFIED SERVICE PERSONNEL.



The exclamation point within a triangle is intended to alert the user to the presence of important operating and maintenance (servicing) instructions in the literature accompanying the product.

**CAUTION:** TO PREVENT ELECTRIC SHOCK, MATCH WIDE BLADE OF PLUG TO WIDE SLOT, FULLY INSERT.

**WARNING:** FCC Regulations state that any unauthorized changes or modifications to this equipment not expressly approved by the manufacturer could void the user's authority to operate this equipment.

**CAUTION:** This product satisfies FCC regulations when shielded cables and connectors are used to connect the unit to other equipment. To prevent electromagnetic interference with electric appliances such as radios and televisions, use shielded cables and connectors for connections.

## DECLARATION OF CONFORMITY:

SHARP LIQUID CRYSTAL TELEVISION, MODEL PN-LE901/PN-LE801/PN-LE701/PN-LE601  
This device complies with Part 15 of the FCC Rules. Operation is subject to the following two conditions:

(1) This device may not cause harmful interference, and (2) this device must accept any interference received, including interference that may cause undesired operation.

### RESPONSIBLE PARTY:

SHARP ELECTRONICS CORPORATION  
100 Paragon Drive Suite #100  
Montvale, NJ 07645 USA

For Business Customers: URL <http://www.sharpusa.com>

## INFORMATION:

This equipment has been tested and found to comply with the limits for a Class B digital device, pursuant to Part 15 of the FCC Rules. These limits are designed to provide reasonable protection against harmful interference in a residential installation. This equipment generates, uses and can radiate radio frequency energy and, if not installed and used in accordance with the instructions, may cause harmful interference to radio communications. However, there is no guarantee that interference will not occur in a particular installation. If this equipment does cause harmful interference to radio or television reception, which can be determined by turning the equipment off and on, the user is encouraged to try to correct the interference by one or more of the following measures:

- Reorient or relocate the receiving antenna.
- Increase the separation between the equipment and receiver.
- Connect the equipment into an outlet on a circuit different from that to which the receiver is connected.
- Consult the dealer or an experienced radio/TV technician for help.



# IMPORTANT INFORMATION

## **FCC Compliance Statement**

This device complies with part 15 of the FCC Rules. Operation is subject to the following two conditions:  
(1) This device may not cause harmful interference, and (2) this device must accept any interference received, including interference that may cause undesired operation.

## **Wireless Radio**

For product available in the USA/Canada market, only channel 1–11 can be operated. Selection of other channels is not possible. This device is going to be operated in 2.412–2.462GHz frequency range.  
**Important:** Any changes or modifications not expressly approved by the party responsible for compliance could void the user's authority to operate the equipment.

**FCC Radiation Exposure Statement:** This equipment complies with FCC radiation exposure limits set forth for an uncontrolled environment. This equipment should be installed and operated with minimum distance 20cm between the radiator & your body.

## **Industry Canada Statement**

This Class B digital apparatus complies with CAN ICES-003(B)/NMB-3(B)

## **Wireless Radio**

For product available in the USA/Canada market, only channel 1–11 can be operated. Selection of other channels is not possible.  
The device could automatically discontinue transmission in case of absence of information to transmit, or operational failure.  
Note that this is not intended to prohibit transmission of control or signaling information or the use of repetitive codes where required by the technology.

**Important:** Any changes or modifications not expressly approved by the party responsible for compliance could void the user's authority to operate the equipment.

**IC Radiation Exposure Statement:** This device complies with IC RSS-210 rules; Operation is subject to the following two conditions:

(1) This device may not cause harmful interference, and (2) this device must accept interference received, including interference that may cause undesired operation.

\*Note to CATV system installer: This reminder is provided to call the CATV system installer's attention to Article 820 of the National Electrical Code that provides guidelines for proper grounding and, in particular, specifies that the cable ground shall be connected to the grounding system of the building, as close to the point of cable entry as practical.\*



## DEAR SHARP CUSTOMER



Thank you for your purchase of the Sharp Liquid Crystal Television. To ensure safety and many years of trouble-free operation of your product, please read the Important Safety Instructions carefully before using this product.

## IMPORTANT SAFETY INSTRUCTIONS

Electricity is used to perform many useful functions, but it can also cause personal injuries and property damage if improperly handled. This product has been engineered and manufactured with the highest priority on safety. However, improper use can result in electric shock and/or fire. In order to prevent potential danger, please observe the following instructions when installing, operating and cleaning the product. To ensure your safety and prolong the service life of your Liquid Crystal Television, please read the following precautions carefully before using the product.

- 1) Read these instructions.
- 2) Keep these instructions.
- 3) Heed all warnings.
- 4) Follow all instructions.
- 5) Do not use this apparatus near water.
- 6) Clean only with dry cloth.
- 7) Do not block any ventilation openings. Install in accordance with the manufacturer's instructions.
- 8) Do not install near any heat sources such as radiators, heat registers, stoves, or other apparatus (including amplifiers) that produce heat.
- 9) Do not defeat the safety purpose of the polarized or grounding-type plug. A polarized plug has two blades with one wider than the other. A grounding type plug has two blades and a third grounding prong. The wide blade or the third prong are provided for your safety. If the provided plug does not fit into your outlet, consult an electrician for replacement of the obsolete outlet.
- 10) Protect the power cord from being walked on or pinched particularly at plugs, convenience receptacles, and the point where they exit from the apparatus.
- 11) Only use attachments/accessories specified by the manufacturer.
- 12) Use only with the cart, stand, tripod, bracket, or table specified by the manufacturer, or sold with the apparatus. When a cart is used, use caution when moving the cart/apparatus combination to avoid injury from tip-over.
- 13) Unplug this apparatus during lightning storms or when unused for long periods of time.
- 14) Refer all servicing to qualified service personnel. Servicing is required when the apparatus has been damaged in any way, such as power-supply cord or plug is damaged, liquid has been spilled or objects have fallen into the apparatus, the apparatus has been exposed to rain or moisture, does not operate normally, or has been dropped.



### Additional Safety Information

- 15) Power Sources—This product should be operated only from the type of power source indicated on the marking label. If you are not sure of the type of power supply to your home, consult your product dealer or local power company. For products intended to operate from battery power, or other sources, refer to the operating instructions.
- 16) Overloading—Do not overload wall outlets, extension cords, or integral convenience receptacles as this can result in a risk of fire or electric shock.
- 17) Object and Liquid Entry—Never push objects of any kind into this product through openings as they may touch dangerous voltage points or short-out parts that could result in a fire or electric shock. Never spill liquid of any kind on the product.
- 18) Damage Requiring Service—Unplug this product from the wall outlet and refer servicing to qualified service personnel under the following conditions:
  - a) When the AC cord or plug is damaged.
  - b) If liquid has been spilled, or objects have fallen into the product.
  - c) If the product has been exposed to rain or water.
  - d) If the product does not operate normally by following the operating instructions.
 Adjust only those controls that are covered by the operating instructions as an improper adjustment of other controls may result in damage and will often require extensive work by a qualified technician to restore the product to its normal operation.
  - e) If the product has been dropped or damaged in any way, and

## IMPORTANT SAFETY INSTRUCTIONS

- f) When the product exhibits a distinct change in performance - this indicates a need for service.
- 19) Replacement Parts—When replacement parts are required, be sure the service technician has used replacement parts specified by the manufacturer or have the same characteristics as the original part. Unauthorized substitutions may result in fire, electric shock, or other hazards.
- 20) Safety Check—Upon completion of any service or repairs to this product, ask the service technician to perform safety checks to determine that the product is in proper operating condition.
- 21) Wall or ceiling mounting—When mounting the product on a wall or ceiling, be sure to install the product according to the method recommended by the manufacturer.

- Outdoor Antenna Grounding — If an outside antenna is connected to the television equipment, be sure the antenna system is grounded so as to provide some protection against voltage surges and built-up static charges. Article 810 of the National Electrical Code, ANSI/NFPA 70, provides information with regard to proper grounding of the mast and supporting structure, grounding of the lead-in wire to an antenna discharge unit, size of grounding conductors, location of antenna-discharge unit, connection to grounding electrodes, and requirements for the grounding electrode.

EXAMPLE OF ANTENNA GROUNDING AS PER NATIONAL ELECTRICAL CODE, ANSI/NFPA 70

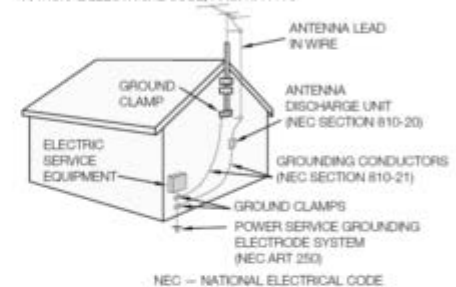

NEC — NATIONAL ELECTRICAL CODE

- Water and Moisture — Do not use this product near water - for example, near a bath tub, wash bowl, kitchen sink, or laundry tub; in a wet basement; or near a swimming pool; and the like.
- Stand — Do not place the product on an unstable cart, stand, tripod or table. Placing the product on an unstable base can cause the product to fall, resulting in serious personal injuries as well as damage to the product. Use only a cart, stand, tripod, bracket or table recommended by the manufacturer or sold with the product. When mounting the product on a wall, be sure to follow the manufacturer's instructions. Use only the mounting hardware recommended by the manufacturer.
- Selecting the location — Select a place with no direct sunlight and good ventilation.
- Ventilation — The vents and other openings in the cabinet are designed for ventilation. Do not cover or block these vents and openings since insufficient ventilation can cause overheating and/or shorten the life of the product. Do not place the product on a bed, sofa, rug or other similar surface, since they can block ventilation openings. This product is not designed for built-in installation; do not place the product in an enclosed place such as a bookcase or rack, unless proper ventilation is provided or the manufacturer's instructions are followed.
- The front panel used in this product is made of glass. Therefore, it can break when the product is dropped or applied with impact. Be careful not to be injured by broken glass pieces in case the panel breaks.
- Heat — The product should be situated away from heat sources such as radiators, heat registers, stoves, or other products (including amplifiers) that produce heat.
- The Liquid Crystal panel is a very high technology product with 2,073,600 pixels, giving you fine picture details. Occasionally, a few non-active pixels may appear on the screen as a fixed point of blue, green or red. Please note that this does not affect the performance of your product.
- Lightning — For added protection for this television equipment during a lightning storm, or when it is left unattended and unused for long periods of time, unplug it from the wall outlet and disconnect the antenna. This will prevent damage to the equipment due to lightning and power-line surges.
- Power Lines — An outside antenna system should not be located in the vicinity of overhead power lines or other electric light or power circuits, or where it can fall into such power lines or circuits. When installing an outside antenna system, extreme care should be taken to keep from touching such power lines or circuits as contact with them might be fatal.
- To prevent fire, never place any type of candle or flames on the top or near the TV set.
- To prevent fire or shock hazard, do not place the AC cord under the TV set or other heavy items.

## IMPORTANT SAFETY INSTRUCTIONS

- Do not display a still picture for a long time, as this could cause an afterimage to remain.
- To prevent fire or shock hazard, do not expose this product to dripping or splashing. No objects filled with liquids, such as vases, should be placed on the product.
- Do not insert foreign objects into the product. Inserting objects in the air vents or other openings may result in fire or electric shock. Exercise special caution when using the product around children.

### Precautions when transporting the TV

- When transporting the TV, never carry it by holding or otherwise putting pressure onto the display. Be sure to always carry the TV by two people (90/80 inch model: three people) holding it with two hands.
- When transporting the TV, never carry it by stand base. (Except for PN-LE901)



### Do not install the TV in a location in which it will be subject to water drops such as underneath an air conditioning unit or in the vicinity of a humidifier

- Water drops falling onto the TV and water entering inside it may result in fire, electric shock, or malfunctions.
- We recommend that you install the TV at least 3.3 ft (1m) away from the outlet of an air conditioner.



### Caring for the cabinet

- Use a soft cloth (cotton, flannel, etc.) and gently wipe the surface of the cabinet.
  - Using a chemical cloth (wet/dry sheet type cloth, etc.) may deform the components of the main unit cabinet or cause cracking.
  - Wiping with a hard cloth or using strong force may scratch the surface of the cabinet.
  - If the cabinet is very dirty, wipe with a soft cloth (cotton, flannel, etc.) soaked in neutral detergent diluted with water and thoroughly wrung out, and then wipe with a soft dry cloth.
  - Avoid using benzene, thinner, and other solvents, as these may deform the cabinet and cause the paint to peel off.
  - Do not apply insecticides or other volatile liquids.
- Also, do not allow the cabinet to remain in contact with rubber or vinyl products for a long period of time. Plasticizers inside the plastic may cause the cabinet to deform and cause the paint to peel off.

### Caring for the front panel

- Turn off the main power and unplug the AC cord from the wall outlet before handling.
- Gently wipe the surface of the front panel with a soft cloth (cotton, flannel, etc.). To protect the front panel, do not use a dirty cloth, liquid cleaners, or a chemical cloth (wet/dry sheet type cloth, etc.). This may damage the surface of the front panel.
- Wiping with a hard cloth or using strong force may scratch the surface of the front panel.
- Use a soft damp cloth to gently wipe the front panel when it is really dirty. (It may scratch the surface of the front panel when wiped strongly.)
- If the front panel is dusty, use an anti-static brush, which is commercially available, to clean it.
- To avoid scratching the frame or screen, please use a soft, lint free cloth for cleaning. Approved cleaning cloths are available directly from Sharp in single (00Z-LCD-CLOTH) or triple (00Z-LCD-CLOTH-3) packs. Call 1-877-PRO-ADV1 (1-877-776-2381) for ordering, or VISIT <http://www.sharppusa.com>.



### Especially for child safety

- Don't allow children to climb on or play with the TV.
- Don't place the TV on furniture that can easily be used as steps, such as a chest of drawers.
- Remember that children can become excited while watching a program, especially on a "larger than life" TV. Care should be taken to place or install the TV where it cannot be pushed, pulled over, or knocked down.
- Care should be taken to route all cords and cables connected to the TV so that they cannot be pulled or grabbed by curious children.

### Wireless LAN

This TV has received the following certifications.

- Wi-Fi CERTIFIED™ (certification program from the Wi-Fi Alliance®)
- Wi-Fi Protected Setup™ (certification program from the Wi-Fi Alliance®)

### FCC

This device complies with part 15 of the FCC Rules. Operation is subject to the following two conditions: (1) This device may not cause harmful interference, and (2) this device must accept any interference received, including interference that may cause undesired operation. Changes or modifications not expressly approved by the party responsible for compliance could void the user's authority to operate the equipment. To comply with the FCC RF exposure compliance requirements, this device and its antenna must not be co-located or operated in conjunction with any other antenna or transmitter.

### IFETEL

This equipment operates on a secondary basis and, consequently, must accept harmful interference, including from station of the same kind, and may not cause harmful interference to systems operating on a primary basis.

CONTAINS TRANSMITTER MODULE IFETEL ID: RCPSH-WN14-1198

Brand: SHARP

Model: WN4616L

(Front)

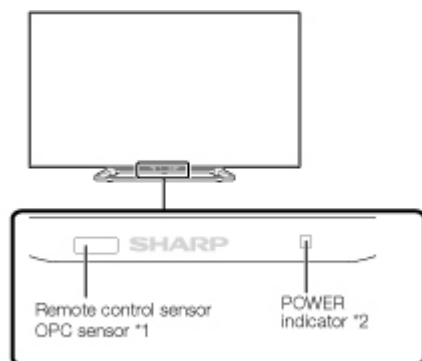

\*1 See page 4-17.

\*2 See page 4-27.

(Side)

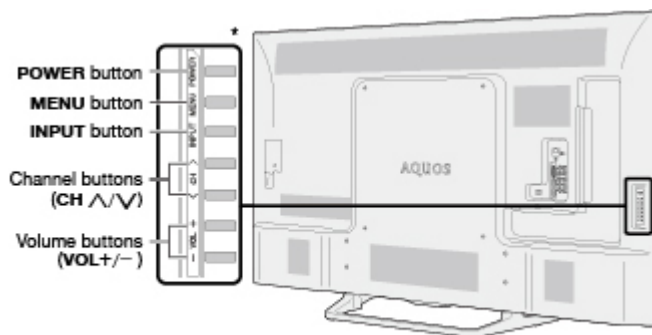

\* See pages 2-1 and 4-4 for button operations.

(Rear)

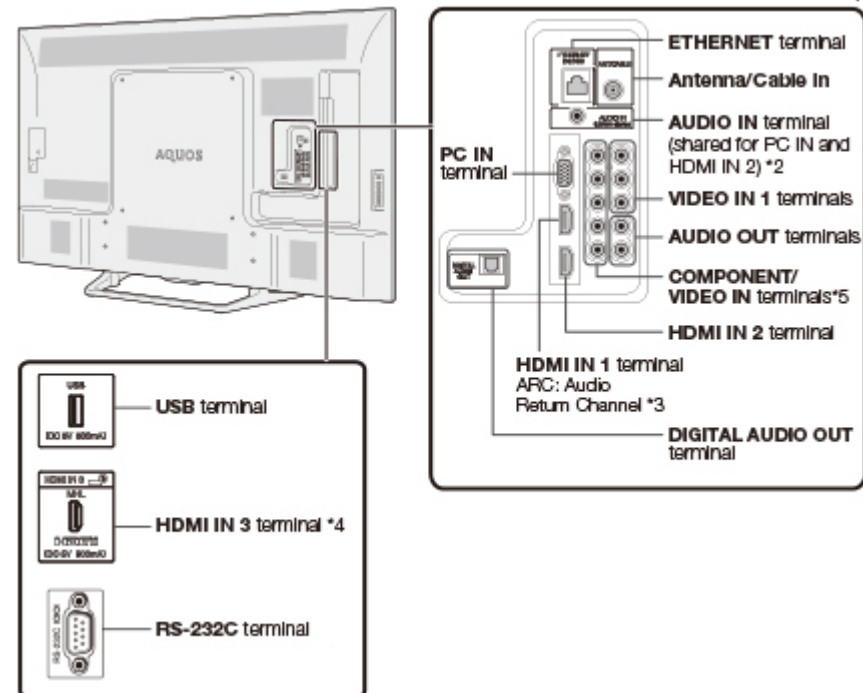

\*1 See the Setup Guide.

And see page 6-1 for external equipment connection.

\*2 See page 7-2 for details on the Audio Select function.

\*3 See page 6-2 for details on the Audio Return Channel.

\*4 See page 6-5 for details on the MHL function.

\*5 See page 4-12 for details on the Input Select function.

- The illustrations and on-screen displays in this operation manual are for explanation purposes and may vary slightly from the actual operations.
- The examples used throughout this manual are based on the PN-LE601 model.

(Front)

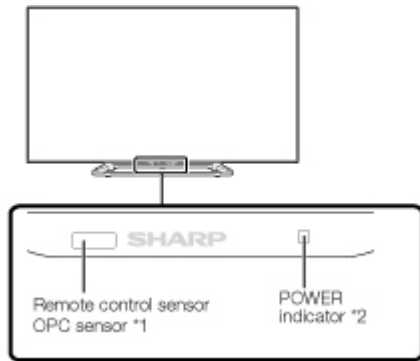

\*1 See page 4-17.

\*2 See page 4-27.

(Side)

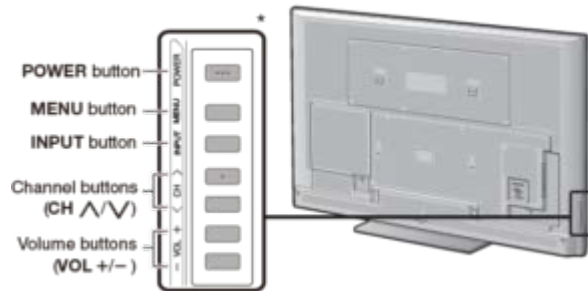

\* See pages 2-1 and 4-4 for button operations.

(Rear)

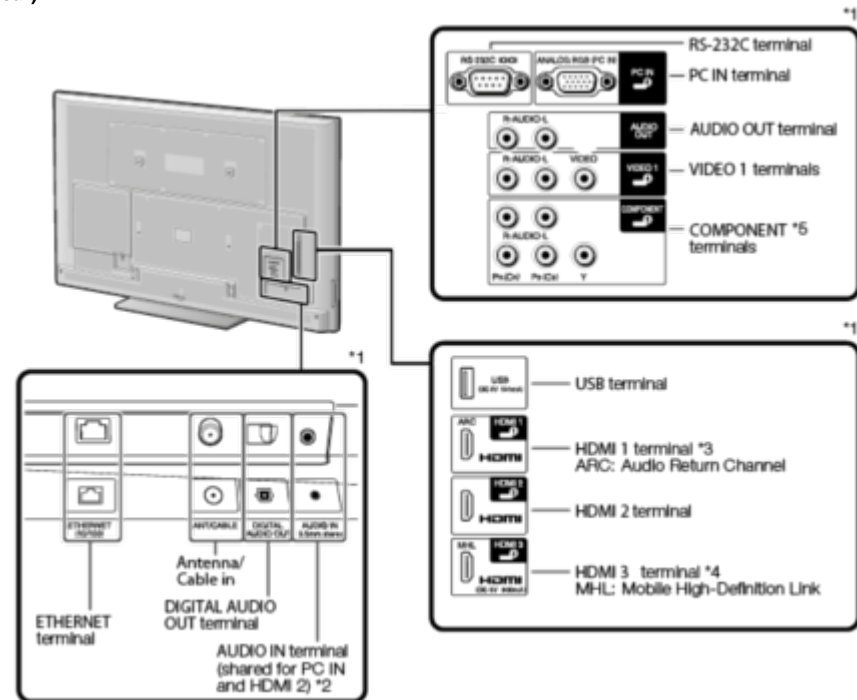

\*1 See the Setup Guide.

And see page 6-1 for external equipment connection.

\*2 See page 7-2 for details on the Audio Select function.

\*3 See page 6-2 for details on the Audio Return Channel.

\*4 See page 6-5 for details on the MHL function.

\*5 See page 4-12 for details on the Input Select function.

- The illustrations and on-screen displays in this operation manual are for explanation purposes and may vary slightly from the actual operations.



**NOTE**

- When using the remote control unit, point it at the TV.

**1 POWER:** Switch the TV power on or enter standby.

**2 DISPLAY:** Display the channel information.

**3 SLEEP:** Set the sleep timer  
([See page 3-6.](#))

**4 0-9:** Set the channel.  
([See pages 3-1.](#))

**5 • (DOT):** Set the channel.  
([See pages 3-1.](#))

**6 OPTION:** Display the Link Operation Menu screen. This button will function only when LINK Operation is used.  
([See page 6-1 to 6-15.](#))

**7 VOL+/-:** Set the volume.  
([See page 3-2.](#))

**8 AUDIO:** Select the MTS/SAP or the audio mode during multichannel audio broadcast.  
([See page 3-5.](#))

**9 MUTE:** Mute the sound.  
([See page 3-3.](#))

**10 ▲/▼/◀/▶, ● (ENTER):** Select a desired item on the screen.

**11 EXIT:** Turn off the menu screen.

**12 A/B/C/D:** Select 4 preset favorite channels in 4 different categories.  
([See page 4-6.](#))

**13 MANUAL:** Display the operation manual.  
([See page 4-15.](#))

**14 APPS:** Display the application window.  
([See page 8-4.](#))

**15 INPUT:** Select a TV input source.  
([See page 2-1.](#))

**16 CH:** Select the channel.  
([See page 3-1.](#))

**17 MENU:** Display the menu screen.  
([See page 4-1.](#))

**18 RETURN:** Return to previous menu screen.

&gt;&gt;

## Introduction

&lt;&lt;

### Displaying an External Equipment Image

To view external source images, select the input source by pressing **INPUT** on the remote control unit or on the TV.



#### Example



- 1 Press **INPUT**.
  - The INPUT list screen displays.
- 2 Press **▲▼** to select the input source.
  - An image from the selected source automatically displays.

- You can also select the input source by pressing **INPUT**.
- Each time **INPUT** is pressed, the input source toggles.

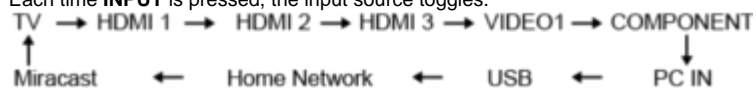



## Initial Installation

Perform the following steps before you press **POWER** on the remote control unit.

1. Insert the batteries into the remote control unit.
2. Connect the antenna cable to the Monitor.
3. Plug in the AC cord to the AC outlet.

### Language (Language setting)

Select from among 3 languages: English, French and Spanish.

- 1 Press ▲▼ to select the desired language listed on the screen, and then press **ENTER**.

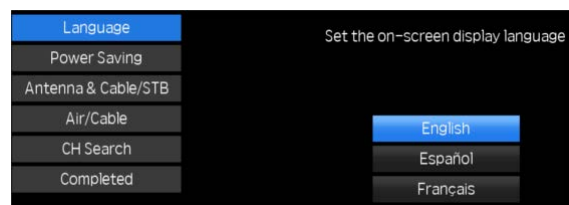



## Initial Installation (Continue)

### Power Saving

Select "Yes" or "No" to configure default Display settings.

- 2 Press to select "Yes" or "No". Press **ENTER** to enter the setting.

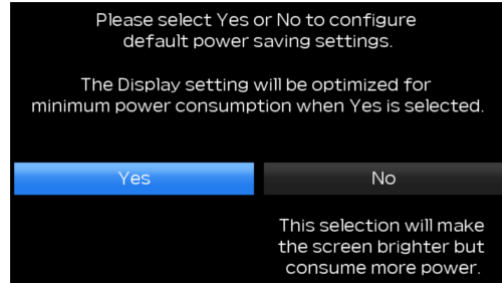

**Yes:** AV MODE is set to "STANDARD" and Automatically Light Sensor is set to "On".

**No:** AV MODE is set to "DYNAMIC (Fixed)" and Automatically Light Sensor is set to "Off". Picture Reset can be set.

**Picture Reset:** AV MODE will be set to "DYNAMIC (Fixed)" regardless of whether Picture Reset is "On" or "Off".

- If you select "On" and there is no operation for 30 minutes:
  - AV MODE will be reset to "DYNAMIC (Fixed)".
- When "Off" is selected:
  - Even after 30 minutes elapses, AV MODE is not reset to "DYNAMIC (Fixed)".

### Antenna & Cable/STB

Select the type of connection you will use to watch TV.

- 3 Press to select "Antenna & Cable" or "Set-top box", and then press **ENTER**.



**To watch TV via an antenna or cable connection (without using a set-top box):**

Select "Antenna & Cable", and then go to step 4. To watch TV via set-top box:

- 1 Select "Set-top box" and then press **ENTER**.
- 2 Check that the set-top box connected to the TV is on.

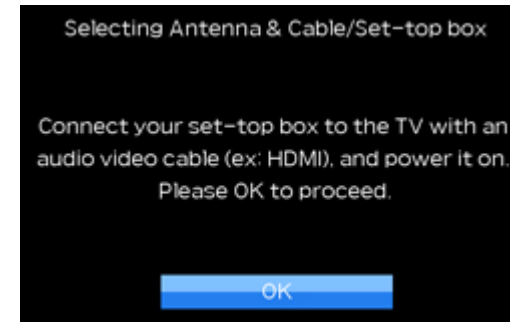



## Initial Installation (Continue)

### CH Search (Channel search)

Channel auto search makes the TV look for all channels viewable in the set area.

#### 4 When "Air" is selected in Antenna setting:

Press to select "Start", and then press **ENTER**.



#### When "Cable" is selected in Antenna setting:

Press to select "Analog & Digital Search Start" to search both analog and digital broadcasts, or to select "Analog Search Start" to search only analog broadcasts, and then press **ENTER**.

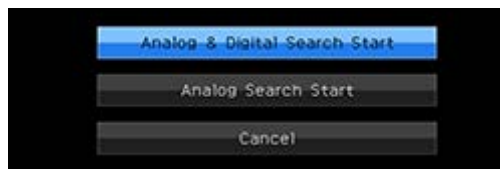

- The Channel search will start automatically.
- To exit the Channel search screen, select "Cancel", and then press **ENTER**.



## Initial Installation (Continue)

### Completed

- 5 The settings confirmation screen is displayed. Confirm the information displayed on the screen, and then press **ENTER**.

Examples of the settings confirmation screen  
When "Antenna & Cable" was selected in step 6.

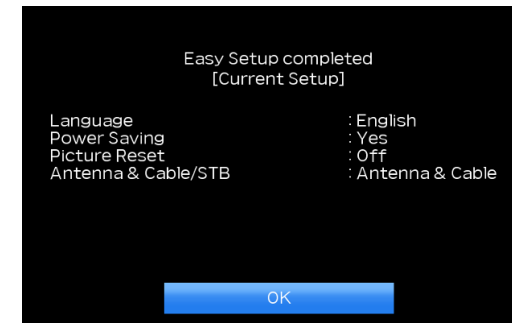



## Initial Installation (Continue)

### NOTE

- If no channel is found, confirm the type of connection made with your TV and try "Easy Setup" again.

When "Set-top box" was selected in step 6.

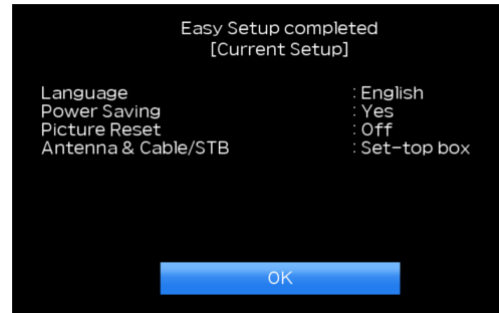

- Click "OK" to display the confirmation screen for input source switching.

**Show the input list:** You can check the current connection status of external equipment. Confirm which input terminal is connected to the set-top box.

**OK:** Clicking "OK" will complete the Easy Setup procedure.

### NOTE

- For changing the settings of the Initial Installation, perform "Easy Setup" on the Initial Setup menu on [page 4-5](#).

## Direct Button Operation



### Changing Channels

You can change channels in several ways.

#### Method 1

Using **CH**  on the remote control unit or on the TV.

#### Method 2

Using remote control buttons **0-9**, **• (DOT)**.

#### Examples:

**To select a 1 or 2-digit channel number (e. g., Channel 5):**

Press **5** → **ENTER**

**To select a 3-digit channel number (e. g., Channel 115):**

Press **1** → **1** → **5** → **ENTER**

**To select a 4-digit channel number (e. g., Channel 22.1):**

Press **2** → **2** → **• (DOT)** → **1** → **ENTER**

#### NOTE

- When selecting a 1-digit channel number, it is not necessary to press **0** before the number.
- When you enter **0-9** only, channel selection will be made if there is no operation within a few seconds.
- if you push "0" by itself, nothing will happen.
- Complete the above steps within a few seconds.
- When you enter 0-9 and **• (DOT)**, channel selection will be made if there is no operation within a few seconds.





## Changing Volume

You can change the volume by pressing **VOL+/-** on the TV or on the remote control unit.

- To increase the volume, press **VOL +**.
- To decrease the volume, press **VOL -**.



### Audio status

Output device	Output Select	
	Fixed	Variable
Speaker	Variable sound	Mute

- When "Output Select" is set to "Variable", the indicator on the screen changes as shown below.



### NOTE

- [See page 4-12](#) for details on the Output Select function.



## MUTE

Mutes the current sound output.

Press  (MUTE).

- " will be displayed on the screen for 30 minutes, and the sound is silenced.



### NOTE

- Mute can be cancelled by pressing **VOL+/-** or **MUTE**.



## APPS

Allows you to directly activate various types of applications.

- 1 Press **APPS** to display the application window.
  - Press **APPS** again to switch back to the currently select input.
- 2 Press  to select the desired application, and then press **ENTER**.
  - If  is displayed, check the USB connection.
  - If  is displayed, check your Monitor's network settings and connection.

### NOTE

- [See page 5-2, 8-5 to 8-9](#) for details of viewable applications.
- When this function is not available, "Can not operate this function now" will display.



## AUDIO

### MTS/SAP stereo mode

The TV has a feature that allows reception of sound other than the main audio for the program. This feature is called Multi-channel Television Sound (MTS). The TV with MTS can receive mono sound, stereo sound and Secondary Audio Programs (SAP). The SAP feature allows a TV station to broadcast other information, which could be audio in another language or something completely different like weather information.

### You can enjoy Hi-Fi stereo sound or SAP broadcasts where available.

- **Stereo broadcasts:** View programs like live sporting events, shows and concerts in dynamic stereo sound.
- **SAP broadcasts:** Receive TV broadcasts in either MAIN or SAP sound.  
MAIN sound: The normal program soundtrack (either in mono or stereo).  
SAP sound: Listen to a second language, supplementary commentary or other information. (SAP is mono sound.)

### If stereo sound is difficult to hear.

- Obtain a clearer sound by manually switching to fixed mono-sound mode.

You can change MTS as shown below to match the television broadcast signal.

Press **AUDIO** to toggle between audio modes.

### Examples: when receiving MTS and SAP

STEREO mode: ST(SAP) → SAP(ST) → MONO

STEREO + SAP mode: STEREO ↔ MONO

MAIN + SAP mode: MAIN ↔ SAP

MONO mode: MONO

### Digital broadcasting audio mode

The types of audio transmitted in a digital broadcast include SURROUND as well as MONO and STEREO. In addition, it is possible for multiple audio tracks to accompany a single video track.

Press **AUDIO** to toggle between audio modes.

### Example: when receiving Digital broadcasting

STEREO (Audio1) → STEREO (Audio2)  
← SURROUND (Audio3) ←

### NOTE

- MTS only operates while in TV mode.
- You can have the same settings by choosing "Change Audio" on the menu items.  
(See page 4-24.)



### Sleep Timer

Allows you to set a time when the TV automatically switches to standby.

Press **SLEEP**.

- The remaining time displays when the sleep timer has been set.
- Each time you press **SLEEP**, the remaining time switches as shown below.

```

Off  →  0hr30min  →  1hr00min
  ↑      ↓
2hr30min ← 2hr00min ← 1hr30min
  
```

- When set, the time automatically starts counting down.
- If you want to adjust the sleep timer, you can press **SLEEP** twice then change the time setting.
- When it is 5 minutes before the time expires, the remaining time will start to keep appearing every minute.

#### NOTE

- Select "Off" by pressing SLEEP to cancel the sleep timer.
- The TV will enter standby when the remaining time reaches 0.

>>

# On-Screen Display Menu

<<

## Introduction



LCFONT embedded

① Guide display

- This indicates the buttons that can be operated on the displayed screen. The guide display varies depending on the menu setting screen.
- The operations for some selected items may be displayed in the operational guide bar at the bottom of the screen.

② Item displayed in blue

- This indicates the item currently selected.
- Press **ENTER** to go to the adjustment screen for this item.

③ Item in brackets

- This indicates the current setting for the item.

④ Item displayed in white

- This indicates that the item can be selected.

⑤ Item displayed in gray

- This indicates that the item cannot be selected. There are various reasons why the items cannot be selected, but the main reasons are as follows:
  - Nothing is connected to the selected input terminal.
  - The function is not compatible with the current input signal.
  - When this conflicts with other functions, you must change the settings for the other functions.



## Introduction (Continue)

### About Menu Items

- Some menu items may not be displayed depending on the selected input source.

### NOTE

- The screens in the operation manual are for explanation purposes (some are enlarged, others cropped) and may vary slightly from the actual screens.
- The order of explanations for each menu item in the following pages is not necessarily in accordance with the alignment of the items on the screen.



### LCFONT:

- This product is embedded with LC Font technology, which was developed by SHARP Corporation for clearly displaying easy-to-read characters on LCD screens.

>>

# On-Screen Display Menu

<<

## On-Screen Display Menu Operation

Example



1 Press **MENU** to display the MENU screen.

2 ① Press to select the desired menu.

② Press to select a specific adjustment item, and then press **ENTER**.

- Additional related adjustment items may be displayed. Press to select the desired item.

③ Adjust the item while referring to the guide display.

- Operations vary depending on the function or item. Refer to the guide display corresponding to the menu setting screen for button operations.

3 Press **MENU** to exit.

### NOTE

- Menu options differ in the selected input modes, but the operating procedures are the same.





### Menu Operation Buttons

#### Using the remote control

Use the following buttons on the remote control to operate the menu.

**MENU:** Press to open or close the menu screen.

**▲/▼/◀/▶:** Press to select a desired item on the screen or adjust a selected item.

**ENTER:** Press to go to the next step or complete the setting.

**RETURN:** Press to return to the previous step.

#### Using the control panel of the TV

You can also operate the menu with the control panel of the TV.

Button operations on the control panel correspond to the ones on the remote control as shown below.

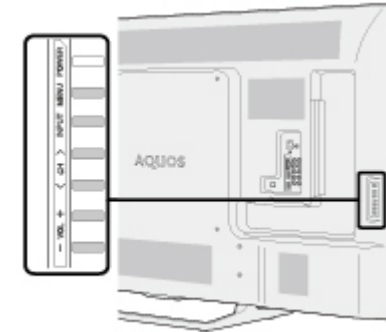

**MENU:** MENU on the remote control.

**INPUT:** ENTER on the remote control.

**CH/▲/▼:** Cursor ▲/▼ on the remote control.

**VOL+/-:** Cursor ◀▶ on the remote control.

Example



## Initial Setup

### NOTE

- For operating the on-screen display menu, [see page 4-3](#).

### Easy Setup

You can change the settings of the Initial Installation.

**Language:** Select from among 3 languages (English, French and Spanish).

**Power Saving:** Select "Yes" or "No" to configure default Display settings.

**Yes:** AV MODE is set to "STANDARD" and Automatically Light Sensor is set to "On".

**No:** AV MODE is set to "DYNAMIC (Fixed)" and Automatically Light Sensor is set to "Off". Picture Reset can be set.

**Picture Reset:** AV MODE will be set to "DYNAMIC (Fixed)" regardless of whether Picture Reset is "On" or "Off". If you select "On", AV MODE will be reset to "DYNAMIC (Fixed)" if there is no operation for 30 minutes. When "Off" is selected, even after 30 minutes elapses, AV MODE is not reset to "DYNAMIC (Fixed)".

**Antenna & Cable/STB:** Select the type of connection you will use to watch TV.

**Air/Cable:** Make sure what kind of connection is made with your TV when selecting "Air" or "Cable".

**CH Search:** Channel auto search makes the TV look for all channels viewable in the set area.

**Completed:** The settings confirmation screen is displayed. Confirm the information displayed on the screen.

### NOTE

- See Initial Installation on [pages 2-2 to 2-6](#) for setting each item.
- If no channel is found, confirm the type of connection made with your TV and try "Easy Setup" again.
- If you select "Analog Search Start" and initiate the channel search, the CH Memory for Cable Digital will be deleted.

## Language

You can also select a language from the Initial Setup menu. Select from among 3 languages: English, French and Spanish.

### NOTE

- To change the language of the manual, select "MENU" > "Initial Setup" > "Language" to change the language. Then, press **MANUAL** again.

## TV Channel Setup

### Channel Setup

If Initial Installation does not memorize all the channels in your region, follow the instructions below to manually memorize the channels.

**Air/Cable:** Make sure what kind of connection is made with your TV when selecting "Air" or "Cable".

**CH Search:** Channel auto search makes the TV look for all channels viewable in the set area.

**CH Memory:** You can select the channels to skip in each ANALOG (Air), ANALOG (Cable), DIGITAL (Air) and DIGITAL (Cable).

**On:** Skips channels. (Channel selection disabled using **CH** )

**Off:** Does not skip channels. (Channel selection enabled using **CH** )

### NOTE

- See Initial Installation on [pages 2-2 to 2-6](#) for setting each item.
- If no channel is found, confirm the type of connection made with your TV and try channel search again.
- If you select "Analog Search Start" and initiate the channel search, the CH Memory for Cable Digital will be deleted.

Example



## Initial Setup (Continue)

### TV Channel Setup

#### Favorite CH (Favorite Channel Setting)

This function allows you to program 4 favorite channels, in 4 different categories. By setting the favorite channels in advance, you can select your favorite channels easily.

#### To register your favorite channel:

Select "Register" and then press **ENTER**. Press ▲/▼/◀/▶ to select the position in the category, and then press **ENTER** to register.

#### To delete your favorite channel:

Select "1 Data Clear" and then press **ENTER**. Press ▲/▼/◀/▶ to select the channel you want to delete, and then press **ENTER**. Select "Yes" and then press **ENTER**.

To delete all the favorite channels, select "All Data Clear".

#### NOTE

- Before setting the channel, select the channel you want to register as a favorite channel.
- You can display the "Favorite CH" screen by pressing **FAV CH** on the remote control.

#### Antenna Setup-DIGITAL

In order to receive digital air broadcasts, you need a digital broadcast antenna. You can confirm the antenna configuration through the "Antenna Setup-DIGITAL" screen. If necessary, adjust the direction of the antenna to obtain the maximum signal strength.

**Signal Strength:** The signal strength of DIGITAL channel is displayed. The signal information is based on the current channel.

**Channel Strength:** Input the 2-digit channel number to check the signal strength of the selected channel. Make sure the signal is strong enough for each channel.

- This function is available for DIGITAL (Air) only.

Example



## Initial Setup (Continue)

### Individual Setup

#### Secret No.

Allows you to use a secret number to protect certain settings from being accidentally changed.

#### IMPORTANT:

Three conditions must be met to enable the V-Chip

1. Secret No. is registered.
2. V-Chip/V-Chip (DTV Only) settings have been made.
  - The "V-Chip (DTV Only)" will only be selectable when a new rating system can be downloaded via digital broadcasting in the U.S.
3. "Status" is set to "Enable".

#### Setting Secret No.

You can set and change the secret number by using **0-9**.

**New Secret No.:** Changes or sets the Secret No.

**Confirm Secret No:** Enter Secret No. to confirm.

#### NOTE

- As a precautionary measure, make a note of your secret number and keep it in a familiar place.

#### Parental Control (Parental Control Setting)

#### V-Chip

V-CHIP is an electronic filtering device built into your TV. This tool gives parents a great degree of control over broadcasts accessed by their children. It allows parents to select programs judged suitable for child viewing while blocking ones judged not suitable. It does so automatically once you activate the V-CHIP feature in your TV. "V-Chip" and "Status" will not be selectable from the menu if you do not first configure your secret number.

- The U.S. has two rating systems for viewing content: TV Parental Guidelines and movie ratings.
- The TV Parental Guidelines work in conjunction with the V-CHIP to help parents screen out inappropriate television shows from their children.
- Movie ratings are used for original movies rated by the Motion Picture Association of America (MPAA) as watched on cable TV and not edited for television. The V-CHIP can also be set to block MPAA-rated movies.

#### NOTE

- The setting automatically enters "Block" for any ratings below your selection.
- If Status is not set to "Enable", the configuration settings will not work.

#### MPAA (Voluntary movie rating system)

Example

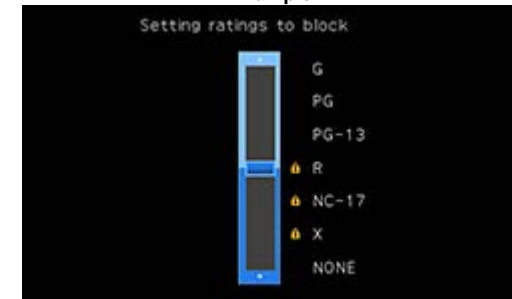

Press **▲/▼** to adjust the item to your desired position. **■** indicates the item is blocked. Press **MENU** to exit.

**G:** General audiences. All ages admitted.

**PG:** Parental guidance suggested. Some material may not be suitable for children.

**PG-13:** Parents strongly cautioned. Some material may be inappropriate for children under 13.

**R:** Restricted. Under 17 requires accompanying parent or adult guardian (age varies in some jurisdictions).

**NC-17:** No one 17 and under admitted.

**X:** X is an older rating that is unified with NC-17 but may be encoded in the data of older movies.

#### NOTE

- Voluntary movie rating system only uses an age-based rating.

Example



## Initial Setup (Continue)

### Individual Setup

#### Parental Control (Parental Control Setting)

#### TV Parental Guidelines

Example

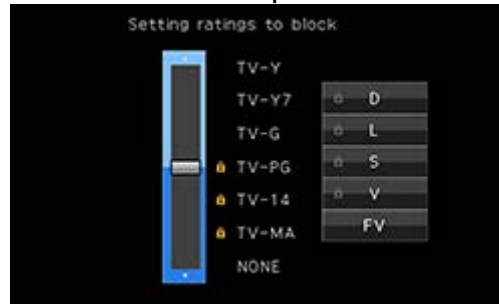

Suggested age

**TV-Y:** All children.

**TV-Y7:** Directed to older children.

**TV-G:** General audience.

**TV-PG:** Parental Guidance suggested.

**TV-14:** Parents strongly cautioned.

**TV-MA:** Mature audience only.

#### When setting an individual content-based rating item:

- 1 Press **▶** or **ENTER** to access blocked content items from the currently selected age-based rating item.
- 2 Press **▲/▼** to select an individual item, and then press **ENTER** to unblock it ("L" is removed). Repeat the same steps for the other items.
- 3 Press **◀** or **RETURN** to register after all individual content rating items are set.

Content

**FV:** Fantasy violence.

**V:** Violence.

**S:** Sexual situation.

**L:** Adult language.

**D:** Sexually suggestive dialog.

Rating	Content					
	FV	V	S	L	D	
Suggested age	TV-Y	☒	☒	☒	☒	☒
	TV-Y7	×	☒	☒	☒	☒
	TV-G		☒	☒	☒	☒
	TV-PG		×	×	×	×
	TV-14		×	×	×	×
	TV-MA		×	×	×	

☒: The content rating can be set, but this rating is not normally broadcast by TV stations.

×: Content rating can be set.

#### Canadian Rating Systems (Canadian English ratings and Canadian French ratings)

- The TV rating systems in Canada are based on the Canadian Radio-Television and Telecommunications Commission (CRTC) policy on violence in television programming.
- While violence is the most important content element to be rated, the structure developed takes into consideration other program content like language, nudity, sexuality and mature themes.
- When setting the V-CHIP on the Canadian system you can choose either the Canadian English ratings or the Canadian French ratings.

&gt;&gt;

# On-Screen Display Menu

&lt;&lt;

Example



## Initial Setup (Continue)

### Individual Setup

#### Parental Control (Parental Control Setting)

#### Canadian English Ratings

**E:** Exempt: Includes news, sports, documentaries and other information programming; talk shows, music videos, and variety programming.

**C:** Children: Intended for younger children under the age of 8 years. Pays careful attention to themes that could threaten their sense of security and well-being.

**C8+:** Children over 8 years old: Contains no portrayal of violence as the preferred, acceptable, or only way to resolve conflict; nor encourage children to imitate dangerous acts which they may see on the screen.

**G:** General: Considered acceptable for all age groups. Appropriate viewing for the entire family, contains very little violence, physical, verbal or emotional.

**PG:** Parental Guidance: Intended for a general audience, but may not be suitable for younger children (under the age of 8) because it could contain controversial themes or issues.

**14+:** Over 14 years: Could contain themes where violence is one of the dominant elements of the storyline, but it must be integral to the development of plot or character. Language usage could be profane and nudity present within the context of the theme.

**18+:** Adults: Intended for viewers 18 years and older and might contain depictions of violence, which while related to the development of plot, character or themes, are intended for adult viewing. Could contain graphic language and portrayals of sex and nudity.

#### Canadian French Ratings

**E:** Exempt programming.

**G:** General: All ages and children, contains minimal direct violence, but may be integrated into the plot in a humorous or unrealistic manner.

**8ans+:** General but inadvisable for young children: May be viewed by a wide public audience, but could contain scenes disturbing to children under 8 who cannot distinguish between imaginary and real situations.

Recommended for viewing with parent.

**13ans+:** Over 13 years: Could contain scenes of frequent violent scenes and therefore recommended for viewing with parent.

**16ans+:** Over 16 years: Could contain frequent violent scenes and intense violence.

**18ans+:** Over 18 years: Only for adult viewing. Could contain frequent violent scenes and extreme violence.

#### How to temporarily release the V-CHIP BLOCK

When the V-CHIP BLOCK is working and censors a broadcast, "V-CHIP HAS BEEN ACTIVATED." displays.

1 Press **ENTER** while the V-CHIP is working, and then the secret number setting menu displays.

2 Input the 4-digit secret number by using **0-9**. At this time V-CHIP BLOCK temporarily releases.

&gt;&gt;

# On-Screen Display Menu

&lt;&lt;

Example



## Initial Setup (Continue)

### Individual setup

#### Parental Control (Parental Control Setting)

##### Reactivating the temporarily released V-CHIP BLOCK

You can reactivate the temporarily released V\_CHIP BLOCK as shown below.

- Select "Status" setting from the Parental Control menu to reactivate BLOCK.
- Select "V\_Chip" setting ("MPAA", "TV Guidelines", "Can. English Ratings" or "Can. French Ratings") from the Parental Control to reactivate BLOCK.  
(See pages 4-7 to 4-9)
- Switch off the TV power. (When "Quick Start Mode" is "OFF".)

##### NOTE

- Performing any of the three above will activate the V-CHIP BLOCK.

##### Status

Used to enable or disable the parental control function. This function will not be selectable from the menu if you do not first configure your secret number.

## Quick Start Mode

When this function is activated, you can reduce the Monitor's start-up time or even let the TV in standby mode start displaying images and so on via the connected equipment on the network.

##### NOTE

- Setting "Quick Start Mode" to "On" consumes more power.

Example



## Initial Setup (Continue)

### Input Settings

#### HDMI auto view

When you view images sent from external equipment in an HDMI connection, this function allows the image size on the TV to automatically switch to an appropriate one.

#### NOTE

- Refer to your external equipment operation manual for the signal type.

#### Digital Audio Output

You can output digital audio to an AV amplifier or similar device whose DIGITAL AUDIO INPUT terminal is connected to the DIGITAL AUDIO OUT terminal on the TV. Please select an audio output format compatible with the audio format of the program you are watching and the equipment connected.

**PCM:** For connecting to equipment that does not support Dolby Digital and DTS. The same audio (main, sub, or main/sub) as the audio of the program being viewed is output.

2-channel audio with a sampling rate of 48 kHz or less is output as linear PCM audio.

**Bitstream:** For connecting to an audio system that supports Dolby Digital and DTS. Audio is output through both the main and sub channels.

#### NOTE

- Video input audio are output in PCM mode even when "Bitstream" is selected.
- PCM digital input signals are output in PCM mode even when "Bitstream" is selected.

#### Audio Select

This function sets the terminal to output the computer audio. The adjustment items vary depending on the input source. Select the input source corresponding to the terminal connected to the PC and then adjust the desired item. To perform the operation, refer to "Initial Setup" > "Input Settings" > "Audio Select".

[\(See page 7-2.\)](#)

#### Output Select

Allows you to select what controls the audio output.

**Fixed:** Sound via speaker is adjusted with **VOL+/-** on the remote control unit or on the TV.

Sound via the AUDIO OUT terminal is not adjustable and outputs at a consistent level.

**Variable:** Sound via the AUDIO OUT terminal is adjusted with **VOL+/-** on the remote control unit or on the TV.

Sound via speaker is muted.

#### Input Select

For image input applied to the COMPONENT IN or VIDEO IN terminal, switch to "**COMPONENT**" or "**Video**", respectively.

**COMPONENT:** Select component video

**Video:** Select composite video.

#### NOTE

- If no (color) image display, try changing to another signal type.
- Check the operation manual of the external equipment for the signal type.

#### Input Skip

This setting allows you to skip the TV, HDMI or PC IN Input ("TV, PC IN, COMPONENT, HDMI 1, HDMI 2, HDMI 3 and VIDEO") on the Input Selection operation.



&gt;&gt;

# On-Screen Display Menu

&lt;&lt;

Example



## Initial Setup (Continue)

### Input Settings

#### Color System

Select the video signal system compatible with your equipment from the list below:

**AUTO/NTSC/PAL-M/PAL-N**

#### NOTE

- "Color System" can only be set for the TV or VIDEO IN.

#### HDMI CEC Link

Make the settings to use LINK Operation.

Set the settings with "Initial Setup" > "Input Settings" > "HDMI CEC Link Setup".

[\(See page 6-2.\)](#)

#### Fine Sync.

You can adjust the position on the image input from a PC the settings with "Initial Setup" > "Input Settings" > "Fine Sync.".

[\(See page 7-1.\)](#)

## Reset

If complex adjustments are made and the settings cannot be restored to normal, you can reset the settings to the factory preset values.

- If you have already set the Secret No., input the 4-digit secret number here.

## Example

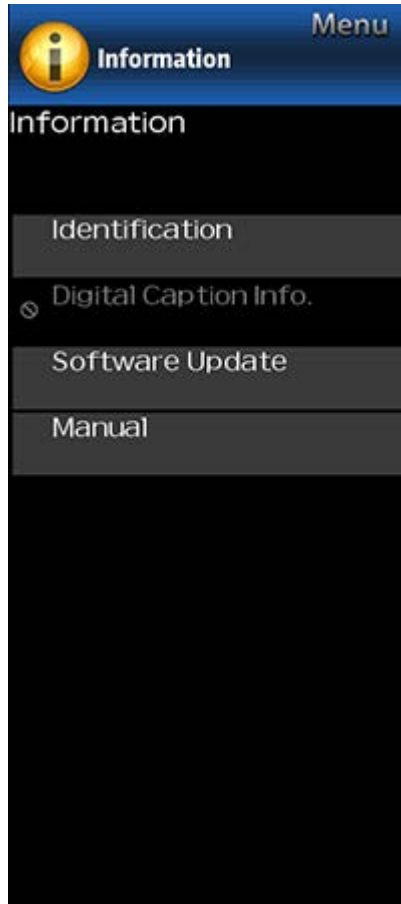

## Information

**NOTE**

- For operating the on-screen display menu, [see page 4-3.](#)

## Identification

The current version of the TV software is displayed.

Digital Caption Info.  
(Digital Caption Information)

This function allows viewing of digital closed caption information for the digital broadcast program being viewed.

**NOTE**

- This list is not displayed for analog broadcasts or external input audio/video.
- This information is not included in CC1, CC2, Text1, or Text2, and is not displayed in a list.

## Software Update

This is used to upgrade the system software to enhance the TV functions.

- 1 Press **MENU** to display the MENU screen, and then press **◀▶** to select "Information".
- 2 Press **▲▼** to select "Software Update", and then press **ENTER**.
- 3 Press **▲▼** to select "Manual Update" or "Auto Update Setting", and then press **ENTER**.
  - The operations thereafter vary depending on the setting.

## Auto Update Setting

When the TV is on, or when an Internet application is being accessed, this function enables the TV to connect to the network and check for updates automatically. When an update is available, a message is displayed. Press **◀▶** to select "Yes", and then press **ENTER** to display the download screen.

[\(See page 4-15.\)](#)

**NOTE**

- This function does not work when a broadband connection or Internet Setup is not available.
- A message may also be displayed when an application is running. The message varies depending on the application.

## Manual Update

Select the method for manually updating the software.

**USB Update:** Updates the software using a USB memory device containing the update file. (See "Updating the Software with a USB Memory Device".)

**Network Update:** Downloads the update file via the network and then updates the software.

[\(See page 4-15.\)](#)

**NOTE**

- A broadband connection and Internet Setup are required to update the software using the network. [\(See page 8-1.\)](#)
- It may take time to access and download the update depending on the Internet connection and other factors.

&gt;&gt;

# On-Screen Display Menu

&lt;&lt;

Example

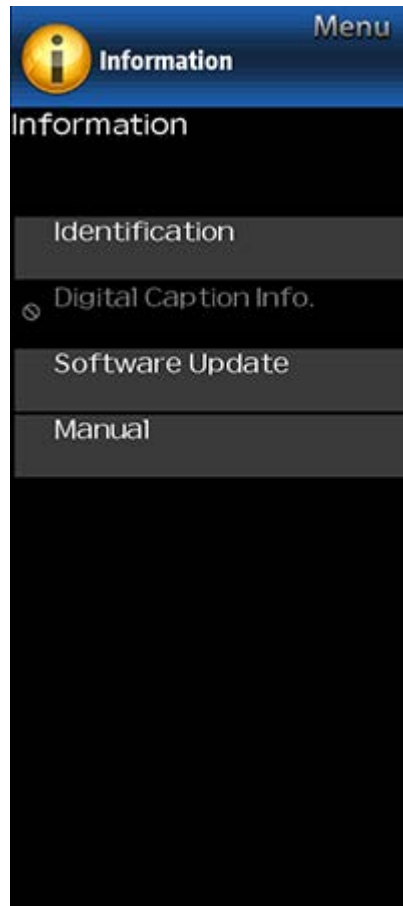

## Information (Continue)

### Software Update

#### Manual Update

#### CAUTION

- Do not remove the USB memory device or unplug the AC cord while the software is being updated.
  - Be sure to properly follow the whole procedure described below, step by step. Otherwise, for example, the TV cannot read the data in the USB memory device and software updating will fail.
- 1 Insert the USB memory device with the update file into the USB terminal on the TV.

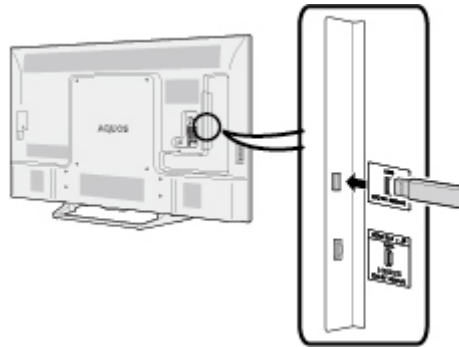

- 2 Press **▲/▼** on the Manual Update screen to select "USB Update", and then press **ENTER**.
- 3 Press **ENTER** to start checking the data in the USB memory device.



- 4 During the data checking, "Checking" blinks.
- The current version of the Monitor software and the version of the update file on the USB memory device are displayed.
  - If the USB memory device is not properly installed or the correct update file cannot be found on the USB memory device, an error message is displayed. Check the file on the USB memory device, and then reinsert the USB memory device correctly.

Example

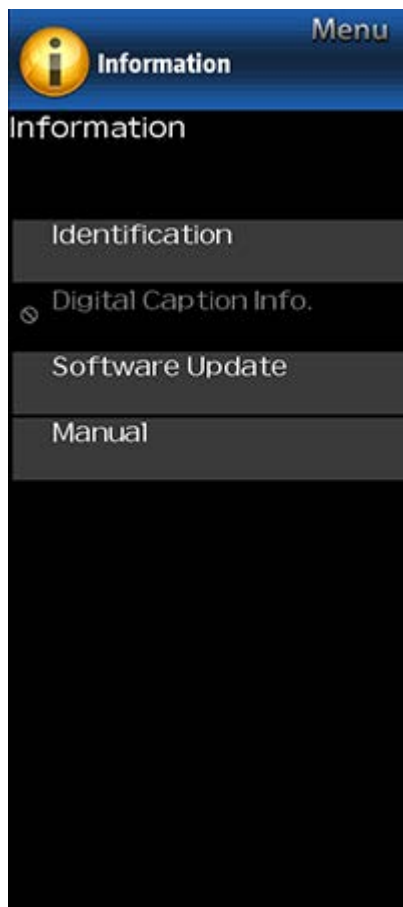

## Information (Continue)

### Software Update

#### Manual Update

#### CAUTION

- **Do not remove the USB memory device or unplug the AC cord while the software is being updated.**
- 5 When the software is successfully updated, a screen is displayed indicating that the update process is completed. After this screen is displayed, the TV automatically turns off and then turns on again.
- If the update has failed, check the file in the USB memory device and try Software Update again.
- 6 Remove the USB memory device.

#### Updating the Software via the Network

- 1 Press ▲/▼ on the Manual Update screen to select "Network Update", and then press **ENTER**.
  - The TV connects to the network and checks for updates.
  - To cancel, press **ENTER**.
- 2 The current version of the TV and the latest version of software are displayed. To update the TV software, select "Yes", and then press **ENTER**.
  - When a server connection cannot be established or an update is not available, a message is displayed. If a server connection cannot be established, check the broadband connection and Internet Setup.
- 3 After the update file is downloaded, the software update process begins.

#### CAUTION

- **Do not unplug the AC cord while the software is being updated.**
- 4 When the software is successfully updated, a screen is displayed indicating that the update process is completed. A screen indicating that the update is completed is displayed. 4 seconds later, the TV restarts automatically.
- If the software was not updated successfully, check the broadband connection and Internet Setup, and then try updating the software again.

### Manual

Displays the built-in operation manual on the screen. You can read information about how to use this device.

Example



## Picture Settings

Adjusts the picture to your preference with the following picture settings.

### NOTE

- For operating the on-screen display menu, [see page 4-3](#).

Selected item	◀ button	▶ button
<b>Backlight</b>	The screen dims	The screen brightens
<b>Contrast</b>	For less contrast	For more contrast
<b>Brightness</b>	For less brightness	For more brightness
<b>Color</b>	For less color intensity	For more color intensity
<b>Tint</b>	Skin tones become reddish	Skin tones become greenish
<b>Sharpness</b>	For less sharpness	For more sharpness

- For resetting all Picture adjustment items to the factory preset values, press ▲/▼ to select "Reset", press **ENTER**, press ▲/▼ to select "Yes", and then press **ENTER**.

## AV MODE (Changing Pic.Quality)

The audio and picture settings can be changed to suit the program or input content being watched. You can use USER Mode to create customized settings for each TV input. These settings will be automatically saved on each input for convenience.

**STANDARD:** For a highly defined image in a normal lighting.

**MOVIE:** For a movie.

**PC:** For PC.

**USER:** Allows the user to customize settings as desired. You can set the mode for each input source.

**DYNAMIC:** For a clear-cut image emphasizing high contrast, useful for sports viewing.

**DYNAMIC (Fixed):** Changes the image and sound settings to the factory preset values. No adjustments are allowed.

### NOTE

- You can select a different AV MODE item for each input mode. (For example, select STANDARD for TV input and DYNAMIC for COMPONENT.)
- The selectable items vary depending on the input source and on the model of your TV.

Example



## Picture Settings (Continue)

### Automatic Light Sensor(Light Sensor)

Automatically adjusts the brightness of the screen.

**Off:** The brightness is fixed at the value set in "Backlight".

**On:** Automatically adjusts.

**On:Display:** Displays the Light Sensor effect on the screen while adjusting the brightness of the screen.

#### NOTE

- When set to "On", the Light Sensor senses the surrounding light and automatically adjusts the backlight brightness. Make sure nothing obstructs the Light Sensor, which could affect its ability to sense surrounding light.
- When set to "On:Display", Light Sensor effect displays on the screen while the Light Sensor adjusts the screen brightness.

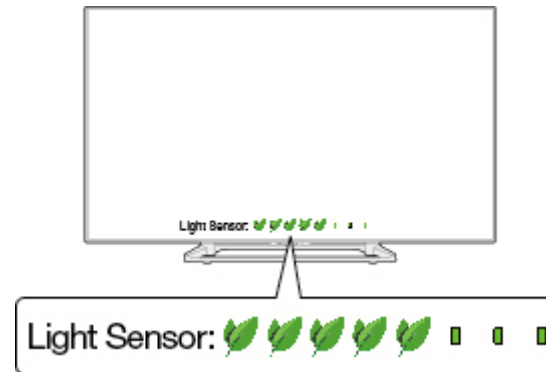

Example



## Picture Settings (Continue)

### Advanced

#### Motion Enhancement

Use Motion Enhancement to view fast-action video more clearly.

Selected item	Description
AquoMotion240	Turn the LED backlight on or off for 120Hz drive display.
120Hz	For obtaining a clearer image.
Off	Original image.

#### NOTE

- "Motion Enhancement" may cause image noise. If this occurs, turn the function "Off".

#### Digital Noise Reduction

Produces a clearer video image.

**AUTO:** Automatically adjusts the level of noise reduction.

**High/Middle/Low:** You can select a desired level for viewing a clearer video image.

**Off:** No adjustment.

#### C.M.S. (Color Management System)

Color tone is managed using the six-color adjustment setting.

**C.M.S.-Hue:** This is a standard to adjust the color either more reddish or more bluish in tone.

**C.M.S.-Saturation:** Increases or decreases the saturation of a selected color.

**C.M.S.-Value:** A higher value makes the image brighter. A lower value makes the image darker.

#### NOTE

- For resetting all adjustment items to the factory preset values, press ▲/▼ to select "Reset", and then press ENTER.

#### Color Temp. (Color Temperature)

For a better white balance, use color temperature correction.

**High:** White with bluish tone

**Middle:**



**Low:** White with reddish tone

#### Fine tuning the color temperature

White balance can be adjusted between a maximum of +30 and a minimum of -30 for each color temperature.

#### NOTE

- For resetting all adjustment items to the factory preset values, press ▲/▼ to select "Reset", and then press ENTER.

>>

# On-Screen Display Menu

<<

Example



## Picture Settings (Continue)

### Advanced

#### Active Contrast

Automatically adjusts the image contrast according to the scene.

**On:** Produces high contrast image.

**Off:** No adjustment.

#### Film Mode (3:2 pull-down)

This function provides high-quality playback of images originally encoded at 24 frames/second, such as films.

**Advanced:** Adjusts effects to reduce judder film contents. You can select a desired level of judder reduction from 0 to +10.

**Standard:** Plays back image with equal display time for each frame, reproducing movie theater experience.

**Off:** Normal viewing mode.

#### NOTE

- "Film Mode" does not function depending on input signal type.
- "Standard" does not function depending on input signal type.

### Monochrome

For viewing a video in monochrome.

### Reset

Returns Picture Settings to their factory preset values. To reset, select "YES" and then press **ENTER**.



## Example



## Audio Settings

You can adjust the sound quality to your preference with the following settings.

**NOTE**

- For operating the on-screen display menu, [see page 4-3.](#)

Selected item	◀ button	▶ button
Treble	For weaker treble	For stronger treble
Bass	For weaker bass	For stronger bass
Balance	Decrease audio from the right speaker	Decrease audio from the left speaker

**NOTE**

- The Audio menu is grayed out when "Output Select" is set to "Variable".  
([See page 4-11.](#))
- For resetting Audio adjustment items to the factory preset values, press ▲/▼ to select "Reset", press **ENTER**, press ▲/▼ to select "Yes", and then press **ENTER**.

## SURROUND

The surround function produces Surround effect from the speakers.

**NOTE**

- The Audio Settings menu is grayed out when "Output Select" is set to "Variable".  
([See page 4-11.](#))
- For some discs, setup may be required on your BD/DVD player. In this case, please refer to the operation manual of your BD/DVD player.

## Auto Volume

Different sound sources sometimes do not have the same loudness level, such as a program and its commercial breaks. The Automatic Volume Control(Auto Volume) reduces this problem by equalizing.

**ON:** Reduces the loudness gaps among different sound source. The result is automatically adjusted according to the sound sources.

**OFF:** No adjustment.

## Reset

Returns Audio Settings to their factory preset values. To reset, select "YES" and then press **ENTER**.

## Example



## Network Settings

## Dashboard

You can display a list of the main Network settings.

## Connection Type

Select the connection type.

**Wired:** The signal is detected and setup is performed automatically. Use "Wired Setup" to check and change the settings as necessary.

**Wireless:** Configure the access point settings on "Wireless Setup".

## Wired Setup

You can make adjustments manually for the IP.

- You can switch the "Connect Type" to "AUTO" or "Manual".
- Check that numbers are displayed for each setting.
- If there are any settings without numbers, specify the numbers by following the on-screen instructions.
- Input the IP address etc by using remote control buttons 0-9.

## Wireless Setup

Make adjustments and confirm the settings necessary for wireless LAN connection (such as search for the access point and registration of it).

**WPS**

**WPS push button:** Allows the TV to automatically establish the connection using a button on the access point.

**WPS PIN code:** Sets up the connection by registering a PIN code for the access point.

**Search:** Searches for and selects the access point to be connected.

**Manual Setup:** Allows you to make the connection by entering an SSID for the access point.

If your access point supports Wi-Fi Protected Setup (WPS push button method), it is recommended that you use this function for the wireless connection. You can press the WPS button on the access point to configure the settings automatically.

- The name of the WPS button function may differ depending on the access point. See the operation manual of the access point for details.

1 Confirm the current settings in "Connection Type".

- If "Wired" is selected, press ▲/▼ to select "Wireless".

2 Select the desired connection method and follow the instructions shown on the display.

3 When a connection is established, the connection details are displayed. Press ENTER.

## IP Control

Set this function when operating the TV from equipment connected by LAN.

[\(See page 7-3.\)](#)

>>

# On-Screen Display Menu

<<

Example



## Network Settings (Continue)

### Device Name

Set this function when operating the TV from equipment connected by LAN or wireless LAN.

[\(See page 7-3.\)](#)

Use the software keyboard when you need to input text at Device Name Setting.

### Software Keyboard



#### ABC

Switches character to uppercase. If "abc" is pressed again, switches character to lowercase.

#### ":&12"

Changes character set into the alphabet, numbers, symbols, etc.

#### OK

Applies the entered information and closes the software keyboard.

#### space

Enters a space.

#### DEL

Erases the character string.

&gt;&gt;

# On-Screen Display Menu

&lt;&lt;

Example



## System Options

### NOTE

- For operating the on-screen display menu, [see page 4-3.](#)

### Power Control

Power control setting allows you to save energy.

#### No Signal Off

When this function is enabled, the TV automatically shuts down if no signal is received for more than 15 minutes.

### NOTE

- When it is 5 minutes before the power shuts down, the remaining time will start to keep appearing every minute.
- When a TV program finishes, this function may not operate.

#### No Operation Off

When you enable this function, the TV automatically shuts down if no operation is performed for more than 3 hours.

### NOTE

- When it is 5 minutes before the power shuts down, the remaining time will start to keep appearing every minute.

&gt;&gt;

# On-Screen Display Menu

&lt;&lt;

Example





## System Options (Continue)

### View option

#### View Mode

This function changes the screen size. Select "View Option" on the menu to display the View Mode menu screen. The View Mode menu varies depending on the input source.

#### For HD Video source

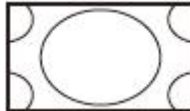
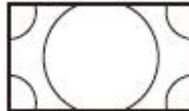
Stretch	Dot by Dot (Full Screen)	S.Stretch (Smart stretch)	Zoom
 <p>Suitable for viewing wide-screen 1.78:1 aspect ratio Video source, stretch mode will still show very thin black bands at the top and bottom of the screen.</p>	 <p>"Dot by Dot" when the number of pixels on the screen and the resolution of the signal are the same. "Full Screen" when the number of pixels on the screen and the resolution of the signal are different. In either case, the image fully fills the screen.</p>	 <p>Suitable for stretching 4:3 Video source to fill the screen.</p>	 <p>Suitable for viewing wide-screen 2.35:1 aspect-ratio Video source in full screen.</p>

#### NOTE

- When using Dot by Dot or Full Screen, it is possible to see noise or bars around different outer portions of the screen. Please change view mode to correct this.

>>

# On-Screen Display Menu

<<

Example

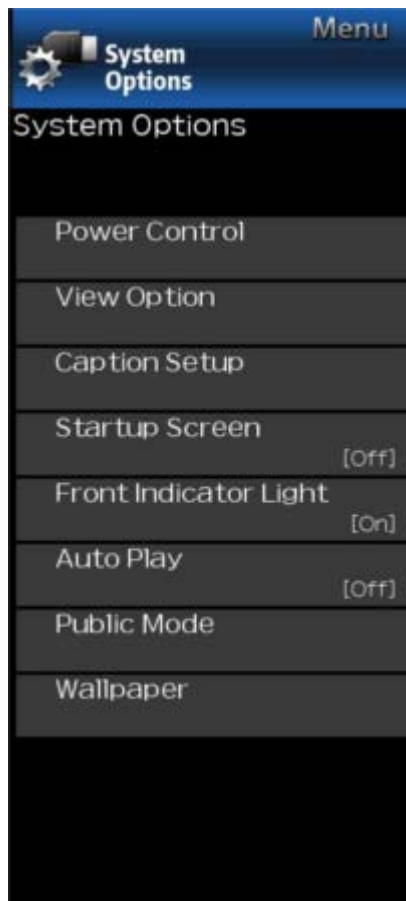



## System Options (Continue)

### View option

#### View Mode

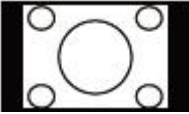

For 4:3 Video source

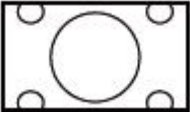
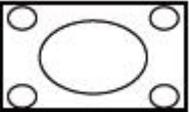
Example: Screen size images

Side Bar	S.Stretch (Smart stretch)	Zoom	Stretch
			
Suitable for viewing conventional 4:3 Video source in their normal format.	Suitable for stretching 4:3 Video source to fill the screen.	Suitable for viewing wide-screen 2.35:1 anamorphic DVDs in full screen.	This mode is useful for 1.78:1 DVDs. When viewing 1.85:1 DVDs, stretch mode will still show very thin black bands at the top and bottom of the screen.

For USB-Video, Home Network Video or Internet applications

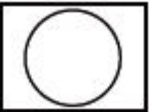
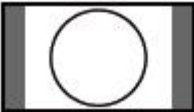
Example: Screen size images

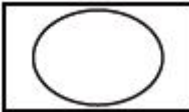
Input signal	Auto	Original	Stretch
			
	Keeps the original aspect ratio in a full screen display.	Displays an image by an original size.	An image fully fills the screen.

Example

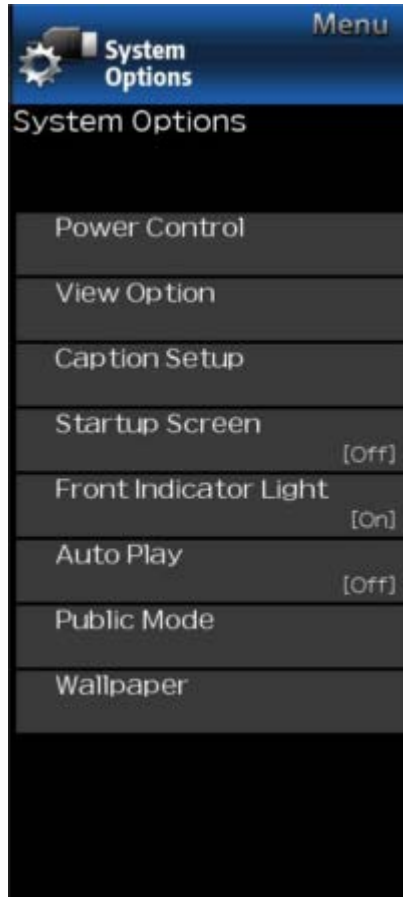

## System Options (Continue)

### View option

#### View Mode

For PC  
 Example: Screen size images

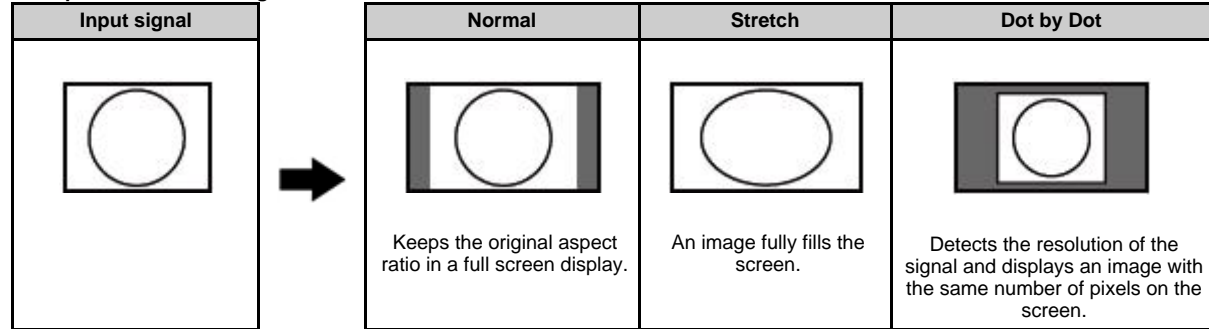

#### NOTE

- Connect the PC before making adjustments. See the Setup Guide.
- Selectable screen size may vary with input signal type.

#### MPX

Allows you to change the audio when multiple audio is available for the video you are watching.

#### NOTE

- You can change Audio by pressing AUDIO on the remote control unit. [See page 3-5](#) for details of Audio function.

#### Audio Only

When listening to music from a music video, you can turn the screen off and enjoy audio only.

#### NOTE

- The screen image will return to normal when a button (except those for audio adjustment, such as **VOL**, **MUTE**) is pressed.

#### Change CC

Allows you to change the Closed Caption display. Select "Change CC" on the menu to display the Closed Caption information.

- The information displayed varies depending on the video you are watching.

#### NOTE

- Closed Caption is available for TV and Video input and is unavailable for Component input.

Example



## System Options (Continue)

### Caption Setup

This function allows you to adjust the closed caption screen appearance to suit your preference.

**Size/Edge Effect/Edge Color/Text Color/Background Color/Text Opacity/Background Opacity**

### Startup Screen

With this function activated, the SHARP logo will be displayed when you turn on the Monitor.

#### NOTE

- This function is not available when the Monitor is set to "Quick Start Mode".

### Front Indicator Light

When this function is set to "On", the LED on the front of the Monitor turns on.

#### NOTE

- "On" is the factory preset value. If you want to turn off the LED, set the function to "Off".

### Auto Play

You can automatically start USB media player or web browser.

#### NOTE

**Off:** This function does not work.

**USB:** After the power is turned on, the video is played back continuously or slide show of still images automatically starts.

**Web Browser:** After the power is turned on, the Web Browser starts automatically and displays the Home page.

#### NOTE

- When more than one video is played back continuously, the screen goes black while the data of the next video is being loaded. To shorten this blackout time, adjust the data size of the content.
- Create a folder named "Auto Play" in the root directory of the USB memory device (the first directory when the USB memory device is opened), and store into the folder the video or still images you want to playback.

- When both video and still images are saved in "Auto Play" folder, video has priority.
- You must insert the USB memory device to the Monitor before turning off the TV.
- If there are images on the USB memory device but they do not appear on the screen, switch to USB mode and check whether the image files on the USB memory device are shown correctly.
- It will be interrupted by remote control operation. After a few minutes, it will automatically start again.

## Public Mode

### 1. How to start Public Mode setup screen.

- There are two ways to enter the public mode.

① Press a/b/c/d to select "MENU" > "System Options" > "Public Mode", and then press ENTER.

② You can also select the "Public Mode" by below method.

1. Press the "INPUT" and "VOL (+)" keys on the set at once and turn on the power.
2. Get the password input screen displayed.



#### Procedure

- The Input starts with the left most digit.
- Use the numeric keys [1] thru [9] and [0] keys on the remote controller. The other keys are not acceptable.
- With a numeric-key input, "-" will change to "\*". The input position will move one digit to the right.
- With all the 3 digits entered, the password will be verified.

3. The 3-digit password is now verified.

The password [0] [2] [7] provides for the public mode screen. (This screen comes on with whatever adjustment process settings.)

With any other passwords, the screen changes to the normal mode.



Example

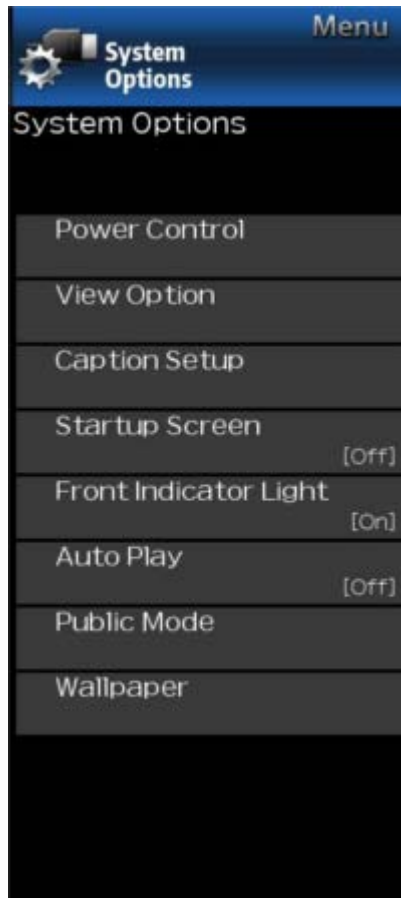

## System Options (Continue)

### Public Mode

#### 2. How to exit from Public Mode setup screen

There are the following ways to quit the public mode setup screen.

- Turn off the power with the "POWER" key.
- Select "EXECUTE".

#### 3. Public Mode Menu

The guidance is not displayed on screen.

Setup procedure

- Turn off the power with the "POWER" key.
- To move the cursor up and down, use the "cursor UP/DOWN" key (remote controller) or "CH (▲/▼)" key (remote controller and TV set).
- To change the settings, use the "cursor RIGHT/LEFT" key (remote controller) or "VOL (+)/(-)" key (remote controller and TV set).
- To save new settings, select "EXECUTE" and press "ENTER" key (remote controller and TV set).

PUBLIC MODE	
POWER ON FIXED	[ VARIABLE ]
MAXIMUM VOLUME	[ 100 ]
VOLUME FIXED	[ VARIABLE ]
VOLUME FIXED LEVEL	[ 20 ]
RC BUTTON	[ RESPOND ]
PANEL BUTTON	[ RESPOND ]
MENU BUTTON	[ RESPOND ]
AV POSITION FIXED	[ VARIABLE ]
ON SCREEN DISPLAY	[ YES ]
INPUT MODE START	[ NORMAL ]
INPUT MODE FIXED	[ VARIABLE ]
LOUD SPEAKER	[ ON ]
RC_PATH_THROUGH	[ OFF ]
232C POWON	[ ENABLE ]
PUBLIC MODE	[ OFF ]
RESET	
EXECUTE	
COPY MODE	

Example



## System Options (Continue)

## Public Mode

## 4. On Setting Items

## 1. POWER ON FIXED

Selection	Selection between "Variable" and "Fixed"
Default	- (Variable)
Explanation	In "Fixed setting, the power-off by the power key of the unit is invalidated and the image is kept being received. The power can be turned off by stopping the power supply from AC.
Limit in Setting	Rfer to the "Power-On Fixed" sheet.
Exception	None
Remarks	<ul style="list-style-type: none"> <li>In "Variable" setting, the power operation is in wait for 1 sec and then turn off when the main power switch is off.</li> </ul>

## 2. MAXIMUM VOLUME

Selection	Adjustment from 0 to 100
Default	100
Explanation	Sound volume can not be adjusted higher than the present value.
Limit in Setting	<ul style="list-style-type: none"> <li>When the sound volume is set lower than 99, only figures are displayed and the sound volume bar is not displayed.</li> </ul>
Exception	
Remarks	<ul style="list-style-type: none"> <li>When the sound volume is set higher than the MAX setting by the adjusting process, the sound volume control operation is prohibited for turn-up and the sound volume should be turned down to MAX in this state.</li> </ul>

## 3. VOLUME FIXED

Selection	Selection between "Variable", "Fixed", "ACON (AC CTRL)" and "AC/RCON (AC/RC CTRL)"
Default	(Variable)
Explanation	<ul style="list-style-type: none"> <li>FIXED: Fixed at the level adjusted for a fixed volume.</li> <li>AC CTRL: Start-up at the level specified for a fixed volume at ACON.</li> <li>AC/RC CTRL: Start-up at the level specified for a fixed volume at start.</li> </ul>
Limit in Setting	<ul style="list-style-type: none"> <li>The sound volume for the ON-timer (Wake up timer) is fixed also without display of menu. Besides, the setting is made impossible. (Basically, the menu is not displayed.)</li> <li>The following keys become invalid: <ul style="list-style-type: none"> <li>Sound volume Up/Down (VOL +/-) [for both remote control and the unit]</li> <li>Mute (MUTE)</li> </ul> </li> </ul>
Exception	<ul style="list-style-type: none"> <li>In the item "VOLUME" of adjustment process, the sound volume can be set freely irrespective of this setting.</li> </ul>
Remarks	<ul style="list-style-type: none"> <li>As for sound volume fixing and sound volume MAX level, the sound volume fixing has priority.</li> <li>Once the sound volume has been changed by adjustment process, it should be set back to the sound volume preset by sound volume fixing level when the adjustment process ends.</li> </ul>

Example



## System Options (Continue)

## Public Mode

## 4. VOLUME FIXED LEVEL

Selection	Adjustment from 1 to 100
Default	30
Explanation	The sound volume to be fixed by "Volume fixed" is determined.
Limit in Setting	None
Exception	None
Remarks	Setting is valid only when "Volume fixed" is selected for "fixed".

## 5. RC BUTTON

Selection	Selection between "Respond", "No Respond" and "Limited"
Default	Respond
Explanation	Making the remote controller settings. <ul style="list-style-type: none"> <li>At the "No Respond" setting, the remote controller keys are disabled. Its power key (reception/standby key) is disabled too.</li> <li>At the "Limited" setting, volume ▲/▼, channel ▲/▼, are operative.</li> </ul>
Limit in Setting	<ul style="list-style-type: none"> <li>In "No respond" setting, all the keys (including the power key) are not accepted.</li> </ul>
Exception	<ul style="list-style-type: none"> <li>Adjustment process, inspection process and hotel only keys are valid irrespective of setting.</li> <li>All the keys can be used in adjustment process, inspection mode and hotel menu irrespective of setting.</li> </ul>
Remarks	

## 6. PANEL BUTTON

Selection	Selection between "Respond" and "No respond"
Default	Respond
Explanation	All the operations by keys (except the power key) of the unit can be invalidated. Limit
Limit in Setting	
Exception	<ul style="list-style-type: none"> <li>Adjustment process, inspection mode and hotel menu mode can be started irrespective of setting.</li> <li>All the keys can be used in adjustment process, inspection mode and hotel menu irrespective of setting.</li> </ul>
Remarks	

Example



## System Options (Continue)

## Public Mode

## 7. MENU BUTTON

Selection	Selection between "Respond" and "No respond"
Default	Respond
Explanation	In "No respond" setting, the menu operation by the menu key of the remote control and the menu key of the unit are invalid.
Limit in Setting	
Exception	<ul style="list-style-type: none"> <li>Adjustment process, inspection mode and hotel menu mode can be started irrespective of setting.</li> <li>All the keys can be used in adjustment process, inspection mode and hotel menu irrespective of setting</li> </ul>
Remarks	

## 8. ON SCREEN DISPLAY

Selection	Selection between "Yes", "No"
Default	Yes
Explanation	<ul style="list-style-type: none"> <li>At the "No" setting, all OSD except public mode menu are not displayed on screen. An input selection is immediately made because the menu is not displayed.</li> </ul>
Limit in Setting	<ul style="list-style-type: none"> <li>Keys falling under any of the following items become invalid.             <ol style="list-style-type: none"> <li>Appearance of screen changes and the sound changes.</li> <li>Personal functions which are hard to restore.</li> </ol> </li> </ul> Screen display, menu, OFF-timer, AV MODE, screen size switching, AUDIO ONLY, sound changeover, LANGUAGE, CLOSED CAPTION
Others	<ul style="list-style-type: none"> <li>Simple input switching is generated</li> </ul>
Exception	<ul style="list-style-type: none"> <li>Such a caution which is displayed independently is displayed as it is. Non-responding signal caution</li> </ul>
Remarks	<ul style="list-style-type: none"> <li>When CC has already been ON, CLOSED CAPTION is displayed.</li> </ul>

## 9. INPUT MODE START

Selection	Selection between "Normal", "Air (*)", "Cable (*)", "COMPONENT", "VIDEO", "PC", "HDMI 1/2/3"
Default	Normal
Explanation	In power-ON, the input source to be started or channel can be set. (In standard mode, the operation follows the last memory.)
About options	<ul style="list-style-type: none"> <li>All the input sources in the model are made selectable.</li> <li>In TV mode, the channel to be set follows the last memory and the content of the last memory is included in the notation by options. Ex.) Air (2), Cable (98.1) etc.</li> </ul>
Limit in Setting	<ul style="list-style-type: none"> <li>The display of channel setting menu and the channel setting operation are prohibited.</li> </ul>
Exception	
Remarks	<ul style="list-style-type: none"> <li>In setting at "Normal", the setting of "Input mode fixed" is changed to "Variable" and selection should be prohibited.</li> </ul>

Example

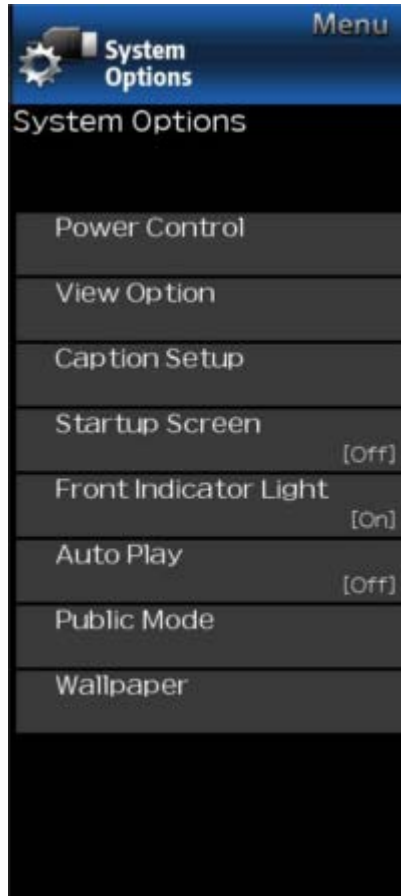

## System Options (Continue)

## Public Mode

## 10. INPUT MODE FIXED

Selection	Selection between "Variable", "Fixed", "ACON (AC CTRL)" and "AC/RCON (AC/RC CTRL)"
Default	- (Variable)
Explanation	<ul style="list-style-type: none"> <li>At the "Fixed" setting, the TV set gets started with the settings of "Input mode start", and then any other channels and inputs are not accepted.</li> <li>At the "ACON (AC CTRL)" setting, the TV set gets started with the settings of "Input mode start" under AC control.</li> <li>At the "AC/RCON (AC/RC CTRL)" setting, the TV set gets started with the settings of "Input mode start" under either control.</li> </ul>
Limit in Setting	<ul style="list-style-type: none"> <li>The following keys are invalidated. CH ▲ / ▼, direct tuning button, FLASHBACK, input</li> <li>* However, the keys (input switching and CH ▲ / ▼ keys) of the unit for menu operation remain valid.</li> </ul>
Exception	None
Remarks	<ul style="list-style-type: none"> <li>In the following case, setting is cancelled and mode is changed to "Variable". When the setting of "Input mode start" is set to "Normal".</li> </ul>

## 11. RC\_PATH\_THROUGH

Selection	Selection between "OFF", "ON: TV RCE" and "ON: TV RCD"
Default	OFF
Explanation	Function to feed the remote controller-received signal to Pin 9 (open) on the RS232C.
Limit in Setting	None
Exception	None
Remarks	When the setting is "ON: TV RCD", TV doesn't respond to the RC operation.

## 12. AV POSITION FIXED

Selection	Selection between "Variable" and "Fixed"
Default	Variable
Explanation	<ul style="list-style-type: none"> <li>In case of "Fixed" setting, –Menu "Picture" and "Audio" setting can't be changed like "Dynamic (Fixed)". –When "AV Mode" key is pressed, TV just displays current AV Mode (cannot be changed.).</li> </ul>
Limit in Setting	None
Exception	None
Remarks	<ul style="list-style-type: none"> <li>When receiving AV Position key and other direct audio select keys, the current display stays on and no setting can be changed.</li> </ul>

&gt;&gt;

# On-Screen Display Menu

&lt;&lt;

Example

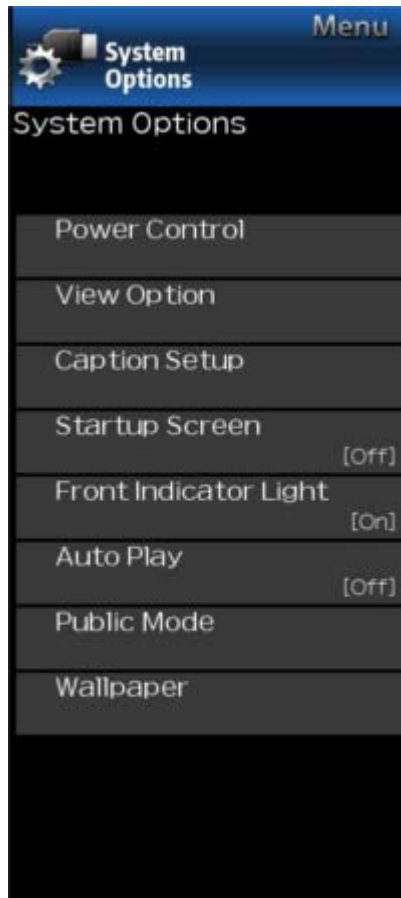

## System Options (Continue)

### Public Mode

#### 13. LOUD SPEAKER (ON/OFF)

Selection	Selection between "ON" and "OFF"
Default	ON
Explanation	If "OFF" is selected, TV stops Speaker output even without Headphone connected.
Limit in Setting	None
Exception	None
Remarks	<ul style="list-style-type: none"> <li>• Press the volume UP/DOWN key, and the mute icon appears for 4 seconds.</li> <li>• The mute key and audio-related keys are displayed with caution.</li> <li>• Usually, the audio output can be adjustable.</li> </ul>

#### 14. .232C POWON

Selection	Selection between "Disable" and "Enable"
Default	Enable
Explanation	In the standby mode, the power-on by the 232C command is enabled or disabled.
Limit in Setting	None
Exception	None
Remarks	The setting by "RSPW" RS-232C/IP control command has priority over this setting.

#### 15. PUBLIC MODE (ON/OFF)

Selection	Selection between "ON" and "OFF"
Default	OFF
Explanation	In case of "ON", public mode settings are effected.
Limit in Setting	None
Exception	None
Remarks	The public-mode settings are operable only when this item is set at ON.

Example



## System Options (Continue)

### Wallpaper

Activating the function will display still images when the TV is in standby mode.

#### Wallpaper Mode

Configures Wallpaper Mode settings.

**Off:** Nothing will be displayed.

**On:** Still images will be displayed when the TV is in standby mode.

#### Data Source

For the wallpaper, you can select either the still images pre-installed in the TV or your favorite still images stored in the USB memory device.

**Pre-Installed:** The images pre-installed in the TV will be displayed in a slideshow.

**USB:** Your favorite images stored for the wallpaper will appear.

If only a single still image is stored in the USB memory device, that image will be displayed as the wallpaper.

When there are multiple still images in the memory, all the images will be displayed in a slideshow.

#### NOTE

- Images are displayed in 3-minute intervals as a slideshow.

#### When you display images by using the USB memory device:

- Create a folder named "WP" in the root directory of the USB memory device (the first directory when the USB memory device is opened), and store into the folder the still images you want to display for the wallpaper.
- You must insert the USB memory device to the TV before turning off the TV.
- If there are images on the USB memory device but they do not appear on the screen, switch to USB mode and check whether the image files on the USB memory device are shown correctly.

### Timer Setting

You can set the length of time the TV will remain in the Wallpaper Mode.

**3 hours/6 hours/12 hours/24 hours**

#### NOTE

- No buttons except for **POWER** work even while the still images are being displayed.
- If the ready-for-use USB memory device is not inserted, the still images pre-installed in the TV will be displayed in a slideshow even when "Data Source" is set to "USB".
- Because the USB memory device cannot be detected immediately after the TV is turned on from standby mode, the wallpaper pre-installed in the TV may be displayed even when "Data Source" is set to "USB".
- The still images will be displayed until the set time has elapsed.

## Enjoying Photo/Music/Video Playback

### Preparation

You can connect the Monitor to a USB memory device, USB hard drive or Home Network server to enjoy viewing pictures, listening to music, and watching videos.

#### NOTE

- Depending on the USB memory device/USB hard drive/Home Network server, the Monitor may not be able to recognize the recorded data.
- It may take time to read the recorded data if the USB TV device/USB hard drive/Home Network server contains many files or folders.
- Use only alphanumeric characters for naming files.
- File names over 80 characters (may vary depending on character set) may not be displayed.

### Connecting a USB Memory Device/USB Hard Drive

Insert the USB memory device with recorded photos, music or videos into the USB terminal on the TV.

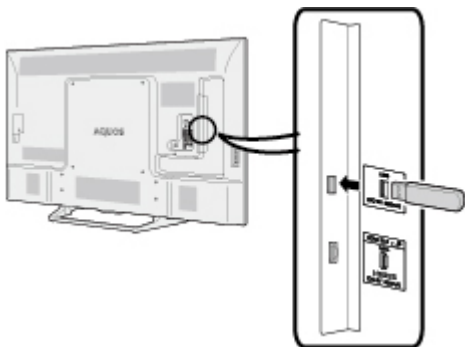

- When connecting a USB hard drive, be sure to use a hard drive with an AC adapter.
- Do not remove a USB memory device or memory card from the TV while transferring files, using the slide show function, or switching screens, or before you exit "USB" from the INPUT list.
- Do not insert and remove a USB memory device/USB hard drive to and from the TV repeatedly.
- When using a card reader, be sure to insert a USB memory device first.

#### CAUTION

- Do not use a USB extension cable when connecting a USB memory device to the USB terminal on the TV.
- Using a USB extension cable with the USB memory device may prevent the TV from performing correctly.

### Connecting a Home Network Server

Connect the TV to the Home Network server using an ETHERNET cable.

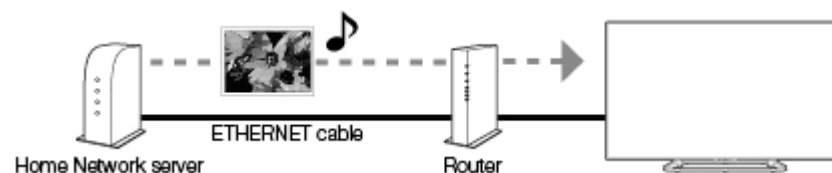

#### NOTE

- Do not disconnect a Home Network server from the TV while transferring files, when a screen is switching to another or before you exit "Home Network" from the INPUT list.
- Do not connect and disconnect a Home Network server from the TV repeatedly.



## Enjoying Photo/Music/Video Playback



### Selecting the Folders to Play Back

- To play back data on a USB memory device, insert the USB memory device on the TV.
- Use the following procedure to switch back to USB mode after switching from USB mode to another mode.

- Select "USB" or "Home Network" from INPUT list screen.
- Press to select "Photo", "Music" or "Video", and then press **ENTER**.

#### Example



- Press to select the desired folder, and then press **ENTER**.
  - "VIEW MODE" is fixed during the Music mode. During "Video mode", you can select "Auto", "Original" or "Stretch".
  - During "Video mode", videos that are smaller than the number of pixels on the screen are displayed at their original size. In these cases, switch "VIEW MODE" to "Auto" to have the video fill the screen.

#### NOTE

- 16 is the maximum number of USB drives and 10 is the maximum number of Home Network servers that can be displayed.

#### USB Device Compatibility

USB device	USB Memory, USB card reader (Mass Storage class), USB hard drive
File system	FAT/FAT32/NTFS (USB hard drive only)
Photo file format	JPEG (.jpg) (DCF2.0 compliant)
Music file format	MP3 (.mp3) Bitrate: 32k, 40k, 48k, 56k, 64k, 80k, 96k, 112k, 128k, 160k, 192k, 224k, 256k, 320kbps Sampling frequency: 32k, 44.1k, 48kHz

# Enjoying Photo/Music/Video Playback



## Selecting the Folders to Play Back (Continue)

Video file format			
File extension	Container	Video	Audio
.avi	AVI	MPEG-1 MPEG-4 SP/ASP(XviD) MPEG-4 AVC (H.264) Motion JPEG	MPEG-Audio LPCM MS-ADPCM DTS AC3
.mkv	MKV	MPEG-1 MPEG-2 MPEG-4 SP/ASP(XviD) MPEG-4 AVC (H.264)	MPEG-Audio LPCM MS-ADPCM DTS AC3
.asf .wmv	ASF WMV	MPEG-4 SP/ASP(XviD) WMV 7/8/9	LPCM WMA
.mp4	MP4	MPEG-4 SP/ASP(XviD) MPEG-4 AVC (H.264) Motion JPEG	MPEG-Audio LPCM MS-ADPCM AC3
.mpg .mpeg	MPG	MPEG-1 MPEG-2	MPEG-Audio LPCM MS-ADPCM AC3

### NOTE

- Progressive format jpeg files are not supported.
- USB 1.1 devices may not be played properly.
- Operation using USB hubs is not guaranteed.
- Some video file formats may not be played depending on the file.
- Some images may not be displayed in the appropriate aspect ratio depending on the file format.

### Home Network Server Compatibility

Photo file format	JPEG
Music file format	LPCM, MP3
Video file format	AVI, ASF, MP4, WMV, MPG

### NOTE

- Progressive format jpeg files are not supported.
- Some video file formats may not be played depending on the file or the server.

# Enjoying Photo/Music/Video Playback



## Playing Back Files on a USB Memory Device/Home Network Server

### NOTE

- The screen images in this section are for the USB mode. It may be slightly different in the Home Network mode.

### Photo Mode

#### Viewing Thumbnails

#### Example



#### Buttons for thumbnail operations

Buttons	Description
▲▼◀▶	Select a desired item.
ENTER	When selecting a folder icon: Enter this directory. When selecting a photo thumbnail: Start the slide show.
RETURN	Return to the previous process.
A (red)	Clear the file information display.
B (green)	
C (blue)	
D (yellow)	

### NOTE

- A few seconds after the cursor is positioned on a thumbnail, the file information is displayed in the right of the center of the screen.



## Playing Back Files on a USB Memory Device/Home Network Server (Continue)

### Slide Show

The photos displayed on the thumbnail selection screen are displayed as a slide show.

### Buttons for slide show operation

Buttons	Description
RETURN	Return to the thumbnail selection screen.
B (green)	Previous file
C (blue)	Displaying/hiding operation guidance
D (yellow)	Next file

### NOTE

- Rotating photos only applies to the temporarily selected item and this setting is not saved.



## Playing Back Files on a USB Memory Device/Home Network Server (Continue)

### Music Mode

#### Example

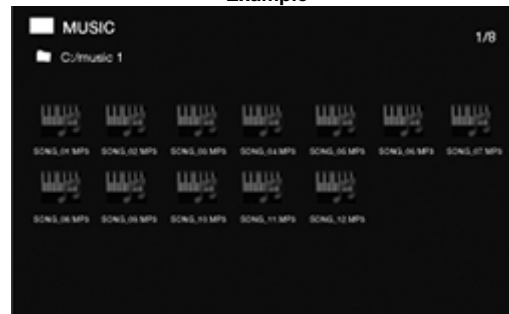

#### Buttons for music mode

Buttons	Description
▲▼▶◀	Select a desired item.
ENTER	When selecting a folder icon: Enter this directory. When selecting a music file: Play music.
RETURN	Return to the previous process.
A (red)	Clear the file information display.
B (green)	
C (blue)	
D (yellow)	

#### NOTE

- The displayed play time may differ slightly from the actual play time depending on the files.
- A few seconds after the cursor is positioned on a thumbnail, the file information is displayed in the right of the center of the screen.



## Playing Back Files on a USB Memory Device/Home Network Server (Continue)

### Video Mode

Example



Buttons for file selecting operations

Buttons	Description
▲▼/▶◀	Select a desired item.
ENTER	When selecting a folder icon: Enter this directory. When selecting a video file: Play the video.
RETURN	Return to the previous process.
A (red)	Clear the file information display.
B (green)	
C (blue)	
D (yellow)	

### NOTE

- A few seconds after the cursor is positioned on a thumbnail, the file information is displayed in the right of the center of the screen.
- When more than one video is played back continuously, the screen goes black while the data of the next video is being loaded. To shorten this blackout time, adjust the data size of the content.



## Playing Back Files on a USB Memory Device/Home Network Server (Continue)

### Buttons for playing mode

Buttons	Description
▲	Stop playback
▼	Stop playback
▶	Fast forward
◀	Fast rewind
A (red)	Subtitle
B (green)	Previous file
C (blue)	Display/hide operation guide
D (yellow)	Next file
RETURN	Go back to the file selection screen.

## Controlling HDMI Equipment Using LINK Operation

**What's LINK Operation?**

- Using the HDMI CEC (Consumer Electronics Control) protocol, with LINK Operation you can interactively operate compatible system equipment (Blu-ray disc equipment, AV amplifier, DVD).
- LINK Operation allows you to operate the HDMI-connected equipment with one remote control.

**NOTE**

- For connecting the TV to LINK-compatible equipment, use commercially available cables.
- Point the remote control toward the TV, not to connected HDMI equipment.
- Video noise may occur depending on the type of HDMI cable used. Make sure to use an HDMI-certified cable.
- Up to 3 pieces of HDMI recording equipment and one AV amplifier can be connected using this system.
- These operations affect the HDMI equipment selected as the current input source. If the equipment does not operate, turn on the equipment and select the appropriate input source using **INPUT**.
- The LINK feature may not operate properly when an HDMI splitter or AV selector unit is used. These devices may cause interruptions to the image and/or sound.

Connected LINK-compatible devices can be operated without changing the settings of the remote control unit.

The **OPTION** button will function only when LINK Operation is used.

**Control the LINK-compatible audio system**

Set the volume of LINK-compatible audio system.

**NOTE**

- The steps in "HDMI CEC LINK" on [page 6-2](#) need to be completed beforehand.
- Refer to this operation manual and the operation manual of the LINK device to be used with this TV.

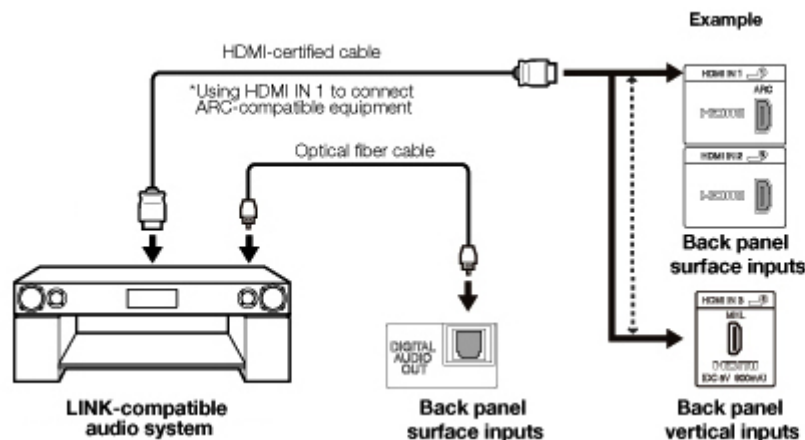





## Controlling HDMI Equipment Using LINK Operation (Continue)

### HDMI CEC LINK

Make the settings to use LINK Operation. Set the settings with "Initial Setup" > "Input Settings" > "HDMI CEC LINK".

### Link Operation

Select LINK Operation Control to disable the LINK function even when a LINK-compatible HDMI device is connected to the TV. This function prevents the device from starting to operate unexpectedly.

### Auto Power On

If this is activated, the One Touch Play function is enabled. While the TV is in standby mode, it automatically turns on and plays back the image from the HDMI source.

### Audio Return Channel

This function allows you to listen to the TV audio via audio equipment without using an optical fiber cable, which conventionally is required.

#### Requirements for using an ARC-compatible AV amplifier:

- ARC-compatible AV amplifier connected to the ARC-compatible HDMI IN terminal. (HDMI IN 1) (Refer to the operation manual of the ARC-compatible equipment for details.)
- Use of an ARC-compatible cable.

**Auto:** You can listen to the TV audio with ARC-compatible audio equipment.

**Off:** This function does not work.

#### NOTE

- If the TV audio cannot be output from the AV amplifier even after making the necessary settings, connect the TV to the AV amplifier with an optical fiber cable and select "Off".

&gt;&gt;

## Using LINK Operation

&lt;&lt;



### Link Operation Menu

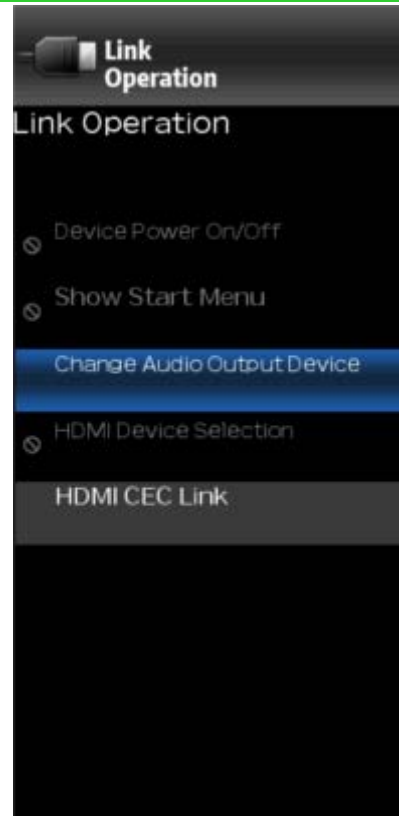

### Device Power On/Off

You can manually turn on/off the power of the connected LINK-compatible equipment. Each time you press **ENTER**, the connected equipment switches on or off.

The Link Operation Menu allows you to make adjustments during operation of LINK-compatible equipment.

- 1 Press **OPTION** to display the Link Operation Menu.
- 2 Press **▲▼** to select the desired item, and then press **ENTER**.
  - Specific operations differ depending on the item you select. Following are the basic operations for each item.



## Link Operation Menu (Continue)

### Show Start Menu

You can call up a setup menu from the connected LINK-compatible equipment.

#### NOTE

- Depending on the status of the equipment (recording or in standby mode, etc), the setup menu will not be displayed.

### Change Audio Output Device

You can select to listen to the TV sound only from the LINK-compatible audio system.

**Audio Return Channel:** The sound from the TV speaker is muted and only the sound from the LINK-compatible audio system is audible.

- You can use **VOL+/-** and **MUTE**.

**Built-in Speaker:** The sound is output from the TV speaker.

### HDMI Device Selection

If multiple HDMI devices are connected in a daisy chain, you can specify which device to control here.

Press **▲/▼** to select the desired device from a list of connected HDMI devices, and then press **ENTER**.

### HDMI CEC LINK

You can also display the HDMI CEC LINK screen from the Link Operation Menu.



### Using a Smartphone with the TV

This function enables you to connect the TV to a smartphone that supports Mobile High-Definition Link (MHL™) using an MHL cable.

To connect the TV to your MHL-compatible smartphone, be sure to use an MHL cable (commercially available).

- You can view pictures and video on a large screen.
- You can play back music files.

#### NOTE

- An MHL-compatible portable device is required to use this function. Connect the device to the HDMI IN 3 terminal.
- This product incorporates MHL 2.2

#### Auto Power On

When an MHL-compatible device is connected to the TV, the TV turns on automatically.

- This function operates when "LINK Operation" is set to "On".

[\(See page 6-2.\)](#)

#### Auto Input Selection

When an MHL-compatible device is connected while the TV is on, the input mode is selected automatically.

- This function operates when "LINK Operation" is set to "On".

[\(See page 6-2.\)](#)

#### Operation Using the Remote Control

The remote control of the TV can be used to operate a portable device.

- ▲/▼/◀/▶, ENTER, EXIT, 0-9, • (DOT), ENT, etc.
- The operations vary depending on the connected equipment and content being viewed.

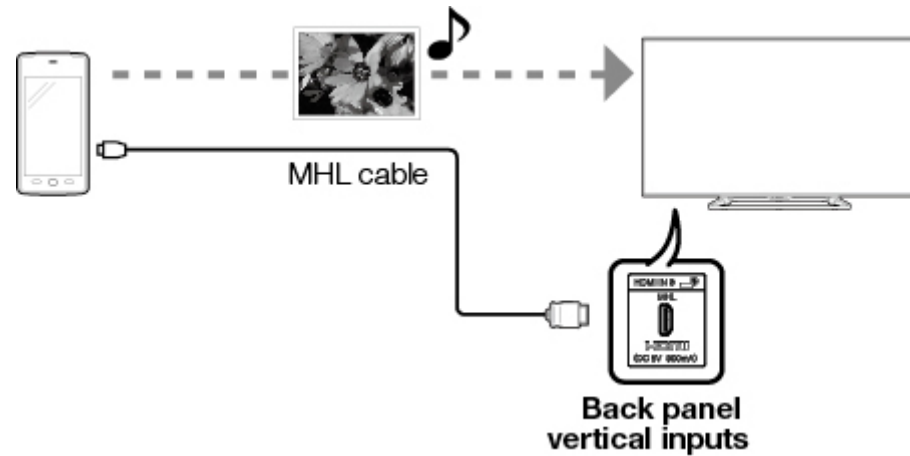



## Using a PC



### Adjusting the PC Image

You can adjust the position of the image input from a PC by selecting "Initial Setup" > "Input Settings" > "Fine Sync."

#### Fine Sync.

Ordinarily you can easily adjust the picture as necessary to change image position using "Auto Sync.". In some cases, however, manual adjustment is needed to optimize the image.

**Input Signal:** Select the input signal.

**1024x768**

**1360x768**

**Auto Sync.:** For automatically adjusting the PC image.

**Yes:** Auto Sync. starts and "Now adjusting the image." is displayed.

**No:** This function does not work.

**H-Pos.:** Centers the image by moving it to the left or right.

**V-Pos.:** Centers the image by moving it up or down.

**Clock:** Adjust when the image flickers with vertical stripes.

**Phase:** Adjust when characters have low contrast or when the image flickers.

#### NOTE

- "Auto Sync." may fail if the computer image has low resolution, has unclear (black) edges, or is moved while executing "Auto Sync."
- Be sure to connect the PC to the TV and switch it on before starting "Auto Sync."
- It is not necessary to adjust the "Clock" or "Phase" when a digital signal is being input, so it cannot be selected.
- The default cursor position may not be in the center, because the screen position variable ranges may be asymmetrical.
- The screen position variable ranges depend on the View Mode or the signal type. The ranges can be seen on the position-setting screen.



## Using a PC



### Setting Audio Input

#### Audio Select

This function sets the terminal to output the computer audio. The adjustment items vary depending on the input source. Select the input source corresponding to the terminal connected to the PC and then adjust the desired item. To perform the operation, refer to "Initial Setup" > "Input Settings" > "Audio Select".

#### HDMI 2

**HDMI2(Digital):** Select this when the TV and PC are connected using an HDMI-certified cable and audio is input via the same cable.

**HDMI+Analog:** Select this when the TV and PC are connected using an HDMI-certified cable and the audio is input via a Ø 3.5 mm stereo minijack.

#### NOTE

- When "Audio Select" is set to "HDMI+Analog", sound will not be produced if you use only an HDMI-certified cable to connect HDMI-compatible equipment. To produce sound, you should make an analog audio connection.
- If you want to connect HDMI-compatible equipment using only an HDMI-certified cable, set "Audio Select" to "HDMI2(Digital)".

- The TV can be controlled from a PC, control panels and other devices using the RS-232C or IP.
- Use a cross-type RS-232C cable, ETHERNET cable (commercially available) or wireless LAN for the connections.

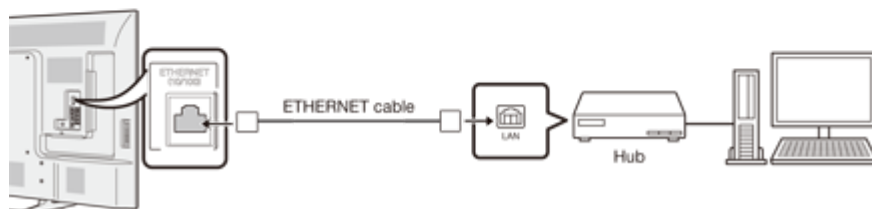
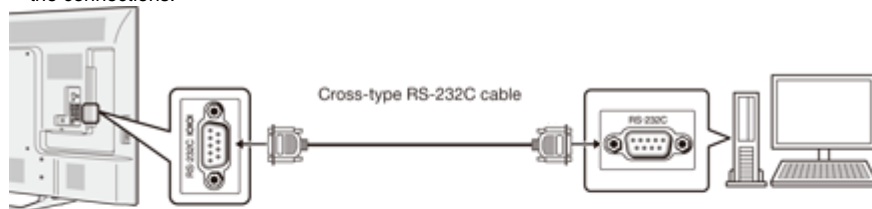
**NOTE**

- This operation system should be used by a person who is accustomed to using computers.

**IP Control**

Set this function when operating the TV from equipment connected by LAN. To perform the operation, refer to "Network Settings".

**IP Control**

When "IP Control" is selected, "Change" will be highlighted. Press **ENTER**.

**Detailed Settings**

Make the detailed settings (Login ID, password, etc.).  
Follow the on-screen instructions to configure the settings.

**Device Name Setting**

Set the name of the TV displayed on other network devices.

- Use the software keyboard to set the name.  
[See page 4-24](#) for details on the software keyboard.

**Communication Conditions for IP**

Connect to the TV with the following settings made for IP on the PC.

<b>IP protocol:</b>	TCP/IP
<b>Host IP address:</b>	Set the IP address on the TV menu
<b>Service:</b>	None (Do not select Telnet or SSH)
<b>TCP port#:</b>	Set a port number on the TV menu (Control port)

When you set your ID and password on the TV menu, you need to enter them as soon as you connect to the TV.

**NOTE**

- When you use this function, make settings for "IP Control".
- The connection will be cut off when there has been no communication for 3 minutes.

**Communication Conditions for RS-232C**

Set the RS-232C communication settings on the PC to match the Monitors communication conditions.

The Monitor's communication settings are as follows:

<b>Baud rate:</b>	9,600 bps
<b>Data length:</b>	8 bits
<b>Parity bit:</b>	None
<b>Stop bit:</b>	1 bit
<b>Flow control:</b>	None

**Communication procedure**

Send the control commands from the PC via the RS-232C or IP.

The Monitor operates according to the received command and sends a response message to the PC.  
Do not send multiple commands at the same time.

Wait until the PC receives the OK response before sending the next command.

**Command format**

Eight ASCII codes +CR



Command 4-digits: Command. The text of four characters.

Parameter 4-digits: Parameter 0–9, x, blank, ?

**Parameter**

Input the parameter values, aligning left, and fill with blank(s) for the remainder. (Be sure that 4 values are input for the parameter.)

When the input parameter is not within an adjustable range, "ERR" returns. (Refer to "Response code format".)

Any numerical value can replace the "x" on the table.

0				When "?" is input for some commands, the present setting value responds.				
0	0	0	9		?			
-	3	0			?	?	?	?

**Response code format**

Normal response



Problem response

(communication error or incorrect command)

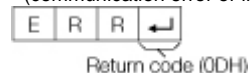
**Command table**

• Commands not indicated here are not guaranteed to operate.

CONTROL ITEM		COMMAND				PARAMETER			CONTROL CONTENTS		
POWER ON COMMAND SETTING		R	S	P	W	0	-	-	-	Off	The Power On command rejected.
						1	-	-	-	On [RS-232C]	The Power On command accepted. (For LE661U and EQ30U models only)
						2	-	-	-	On [IP]	The Power On command accepted.
POWER SETTING		P	O	W	R	0	-	-	-	Power Off	It shifts to standby.
						1	-	-	-	Power On	Power On *1
INPUT SELECTION	TOGGLE	I	T	G	D	x	-	-	-	(Toggle)	It input-switches by the toggle. (It is the same as an input change key)
	TV	I	T	V	D	0	-	-	-		It input-switches to TV. (A channel remains as it is. (Last memory))

\*1 Select "Initial Setup" from the menu screen and set "Quick Start Mode" to "On" to enable the Power On command for LAN and Wi-Fi.

You can "Wake On LAN (Magic Packet)" to turn on the power via LAN. It is not available on Wi-Fi connection.

**NOTE**

- If an underbar (\_) appears in the parameter column, enter a space.
- If an asterisk (\*) appears, enter a value in the range indicated in brackets under CONTROL CONTENTS.
- Any numerical value can replace the "x" on the table.



## Control of the TV (Continue)

CONTROL ITEM		COMMAND				PARAMETER				CONTROL CONTENTS	
INPUT SELECTION	1-6	I	A	V	D	*	_	_	_	1: HDMI IN 1, 2: HDMI IN 2, 3: HDMI IN 3, 4: VIDEO IN 1, 5: COMPONENT/VIDEO IN 2, 6: PC IN	
AV MODE SELECTION		A	V	M	D	*	_	_	_	0: (Toggle), 1: STANDARD, 2: MOVIE, 4: USER, 5: DYNAMIC (Fixed), 6: DYNAMIC, 7: PC	Although it can choose now, it is toggle operation in inside.
VOLUME		V	O	L	M	*	*	*	_	Volume (0-100)	
POSITION	H- POSITION	H	P	O	S	*	*	*	_	(-50-50)	For PC input. The screen position variable ranges depend on the View Mode or the signal type. The ranges can be seen on the position- setting screen.
	V- POSITION	V	P	O	S	*	*	*	_	(-50-50)	
	CLOCK	C	L	C	K	*	*	*	_	(0-100)	
	PHASE	P	H	S	E	*	*	_	_	(0-63)	

CONTROL ITEM	COMMAND				PARAMETER				CONTROL CONTENTS	
VIEW MODE	W	I	D	E	*	*	_	_	0: (Toggle) [AV], 1: Side Bar [AV], 2: S.Stretch [AV] 3: Zoom [AV], 4: Stretch [AV, USB- Video, Home Network Video or Internet applications], 5: Normal [PC] 7: Stretch [PC], 8: Dot by Dot [PC] [AV], 9: Full Screen [AV] 10: Auto [USB- Video, USB-Photo, Home Network Video, Photo or Internet applications], 11: Original [USB- Video, USB-Photo, Home Network Video, Photo or Internet applications]	0: Although it can choose now, it is toggle operation in inside. 1: Only available when 4:3 signal is being input. 5: Only available when 4:3 signal is being input. 8: [PC] Available except when UXGA is being input. [AV] Only available when 1080i/p is being input. 9: Only available when 720p is being input. 10, 11: Available when USB-Video, USB-Photo, Home Network Video, Photo or Internet application is used.
MUTE	M	U	T	E	*	_	_	_	0: (Toggle), 1: On, 2: Off	

**NOTE**

- If an underbar (\_) appears in the parameter column, enter a space.
- If an asterisk (\*) appears, enter a value in the range indicated in brackets under CONTROL CONTENTS.
- Any numerical value can replace the "x" on the table.

&gt;&gt;

## Using a PC

&lt;&lt;

### Control of the TV (Continue)

CONTROL ITEM	COMMAND				PARAMETER				CONTROL CONTENTS
SURROUND	A	C	S	U	*	-	-	-	0: (Toggle), 1: On, 2: Off
AUDIO SELECTION	A	C	H	A	x	-	-	-	(Toggle)
SLEEP TIMER	O	F	T	M	*	-	-	-	0: Off, 1: OFF TIMER - 30 MIN., 2: OFF TIMER - 60 MIN., 3: OFF TIMER - 90 MIN., 4: OFF TIMER - 120 MIN., 5: OFF TIMER - 150 MIN.

CONTROL ITEM		COMMAND				PARAMETER				CONTROL CONTENTS	
CHANNEL	DIRECT CHANNEL (ANALOG)	D	C	C	H	*	*	*	-	The channel number of TV (1-135)	An input change is included if it is not TV display. In Air, 2-69ch is effective. In Cable, 1-135ch is effective.
	DIRECT CHANNEL (DIGITAL)	D	A	2	P	*	*	*	*	(0100-9999)	DIGITAL Air (Two-Part numbers, 2-digit plus 2-digit)
		D	C	2	U	*	*	*	-	(1-999)	DIGITAL Cable (Two-Part numbers, 3-digit plus 3-digit) Front half of DIGITAL CABLE CHANNEL NO. (Designate major channel)
D		C	2	L	*	*	*	-	(0-999)	DIGITAL Cable (Two-Part numbers, 3-digit plus 3-digit) Rear half of DIGITAL CABLE CHANNEL NO. (Designate minor channel)	

#### NOTE

- If an underbar (\_) appears in the parameter column, enter a space.
- If an asterisk (\*) appears, enter a value in the range indicated in brackets under CONTROL CONTENTS.
- Any numerical value can replace the "x" on the table.

&gt;&gt;

## Using a PC

&lt;&lt;

## Control of the TV (Continue)

CONTROL ITEM		COMMAND				PARAMETER				CONTROL CONTENTS	
CHANNEL	DIRECT CHANNEL (DIGITAL)	D	C	1	0	*	*	*	*	(0-9999)	DIGITAL Cable (One-Part numbers, 5-digit, less than 10,000)
		D	C	1	1	*	*	*	*	(0-6383)	DIGITAL Cable (One-Part numbers, 5-digit, more than 10,000)
	CH UP	C	H	U	P	x	-	-	-	The channel number of TV +1	If it is not TV display, it will input-switch to TV. (same function as CH $\wedge$ )
	CH DOWN	C	H	D	W	x	-	-	-	The channel number of TV -1	If it is not TV display, it will input-switch to TV. (same function as CH $\vee$ )
CC		C	L	C	P	x	-	-	-	(Toggle)	Toggle operation of a closed caption.
DEVICE NAME		T	V	N	M	1	-	-	-		The device name set in "Device Name Setting" is displayed.
MODEL NAME		M	N	R	D	1	-	-	-		The model name of the TV.

CONTROL ITEM	COMMAND				PARAMETER				CONTROL CONTENTS	
SOFTWARE VERSION	S	W	V	N	1	-	-	-		The current version of the TV software is displayed.
IP PROTOCOL VERSION	I	P	P	V	1	-	-	-		The currently supported version of IP protocol is displayed.

**NOTE**







- If an underbar (\_) appears in the parameter column, enter a space.
- If an asterisk (\*) appears, enter a value in the range indicated in brackets under CONTROL CONTENTS.
- Any numerical value can replace the "x" on the table.

&gt;&gt;

## Using a PC

&lt;&lt;

### Control of the TV (Continue)

CONTROL ITEM	COMMAND				PARAMETER				CONTROL CONTENTS
REMOTE CONTROL BUTTONS	R	C	K	Y	*	*	-	-	0-9: 0-9, 10: DOT, 12: POWER, 13: DISPLAY, 23: OPTION, 24: SLEEP, 31: MUTE, 32: VOL -, 33: VOL +, 34: CH  , 35: CH  , 36: INPUT, 38: MENU, 40: ENTER, 41:  , 42:  , 43:  , 44:  , 45: RETURN, 46: EXIT, 49: AUDIO, 50: A (red), 51: B (green), 52: C (blue), 53: D (yellow), 61: MANUAL

#### NOTE

- If an underbar ( \_ ) appears in the parameter column, enter a space.
- If an asterisk (\*) appears, enter a value in the range indicated in brackets under CONTROL CONTENTS.
- Any numerical value can replace the "x" on the table.
- You can use "Wake On LAN (Magic Packet)" to turn on the power via LAN. It is not available on Wi-Fi connection.



## Using a PC



### PC Compatibility Chart

It is necessary to set the PC correctly to display XGA and WXGA signal.

Resolution		Horizontal Frequency	Vertical Frequency	VESA Standard
VGA	720 x 400	31.5 kHz	70 Hz	—
	640 x 480	31.5 kHz	60 Hz	○
		37.9 kHz	72 Hz	○
		37.5 kHz	75 Hz	○
SVGA	800 x 600	35.1 kHz	56 Hz	○
		37.9 kHz	60 Hz	○
		48.1 kHz	72 Hz	○
		46.9 kHz	75 Hz	○
XGA	1024 x 768	48.4 kHz	60 Hz	○
		56.5 kHz	70 Hz	○
		60.0 kHz	75 Hz	○
WXGA	1360 x 768	47.7 kHz	60 Hz	○
SXGA	1280 x 1024	64.0 kHz	60 Hz	○
SXGA+	1400 x 1050	65.3 kHz	60 Hz	○
UXGA	1600 x 1200	75.0 kHz	60 Hz	○
1080p	1920 x 1080	67.5 kHz	60 Hz	—

VGA and XGA are registered trademarks of International Business Machines Corp.

By connecting your TV to a broadband system, you can access the Internet from the TV.

## Connecting to the Internet

- To connect your TV to the Internet, you must have a broadband Internet connection.
- If you do not have a broadband Internet connection, consult the store where you purchased your TV or ask your Internet service provider or telephone company.
- When an Internet connection is made, an Ethernet and wireless connection cannot be used at the same time. Use only one of the connection types.

### Using an ETHERNET cable

Use an ETHERNET cable (commercially available) to connect the ETHERNET terminal on the TV to your broadband router (commercially available).

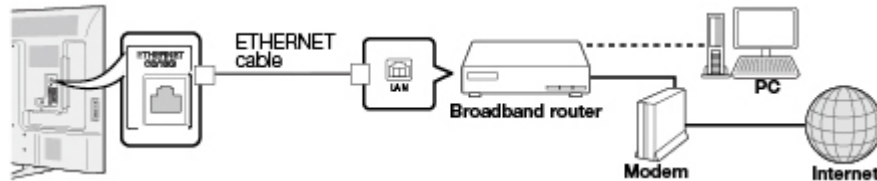

### Using the wireless LAN

This TV is equipped with a wireless LAN function.

For a wireless LAN connection, you must use "Wireless Setup" to connect the access point and TV.



## Network Settings

Perform the procedure below to make adjustments or to confirm the settings for accessing the Internet.

- 1 Press **MENU** to display the MENU screen, and then press **ENTER**.
- 2 Press **◀▶** to select "Network Setting", and then press **ENTER**.
- 3 Press **▲▼** to select "Connection Type", and then press **ENTER**.
  - Press **▲▼** select "Wired" or "Wireless". and press **ENTER**.
- 4 Press **▲▼** to select "Wired Setup", or "Wireless Setup", and then press **ENTER**.
  - Select "Wired Setup" when you make general adjustments to connect to the Internet. [See page 4-21.](#)
- 5 Press **MENU** to exit.

### NOTE

- This TV has a built-in wireless LAN function. Using a separate wireless USB LAN adapter may result in radio communications that do not comply with regulations on radio communications. Therefore, do not use a separate wireless LAN
- A wireless LAN connection and performance cannot be guaranteed for all residential environments. In the following cases, the wireless LAN signal may be poor or drop, or the connection speed may become slower.
  - When used in buildings made with concrete, reinforced steel, or metal
  - When placed near objects that obstruct the signal
  - When used with other wireless devices that emit the same frequency
  - When used in the vicinity of microwave ovens and other devices that emit a magnetic field, electrostatic charge, or electromagnetic interference.



## Entering Text (Software Keyboard)

When you are editing an input screen or specifying the Network settings used for accessing the Internet, enter text from the software keyboard.

### NOTE

- You can enter up to 128 characters for text.
- Some special characters or diacritics may not be available depending on where you enter the text.

The text you enter is displayed as you type it in.

To move the cursor (the current input position), use "**<**" or "**>**" on the software keyboard.



While you are entering text, likely input conversion candidates are displayed based on what you typed in.

### ↑Shift

If "alphabet" is selected, this switches characters between uppercase and lowercase. Each time you press **ENTER**, the character type switches.

### ;

Press **ENTER** to select the type of characters entered: alphabet, or sign.

### ⊞ (BACKSPACE)

Erases text one character at a time.



## Entering Text (Software Keyboard) (Continue)

### Enter

Applies the entered information and closes the software keyboard.

### Space

Enters a space.

### Clear

Erases the character string.

- When the cursor is somewhere in a line: the character string to the right of the cursor will be erased.
- When the cursor is at the right end of a line: the entire line will be erased.

### Close

Closes the software keyboard without applying the entered information.

Buttons on the remote control unit	Description
▲▼/◀▶	Moves the focus. When moved at the far edge, the focus moves to the opposite edge.
ENTER	Performs the processing for the button currently in the focus.
EXIT	Closes the software keyboard without applying the original input elements for the entered text.
RETURN	
0-9	Directly enters the single-byte number for that button.
• (DOT)	Erases text one character at a time.





## Using the Browser

- 1 Press **APPS**, press **◀▶** to select the browser icon from the application window, and then press **ENTER**.
  - Press **APPS** again to switch back to the currently tuned channel.

### Buttons for Using the Browser

#### ENTER, ▲▼◀▶

- Press **▲▼◀▶** to select a link that you want to jump, and then press **ENTER**.

#### EXIT

- Press the button to return to the Monitor screen.

#### RETURN

- Press the button to return to the previous page.

#### NOTE

- Restrictions apply to window display.

## Using the Application Window

### During Dock Display

You can move the application icons.

#### Example

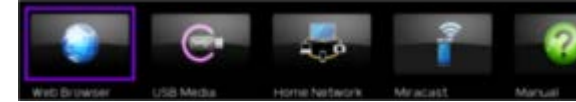

- 1 Select an application, and then press **▲**.
- 2 Press **◀▶** to move the icon to the desired location.





### Move the Icons



You can move the icons of the more commonly used applications closer to the left. Press **◀▶** to move the icon to the desired location.



## Using the Browser (Continue)

Tool bar 

Selected item	Description
	Allows you to go back to the previous page.
	Allows you to go to the next page.
	Refreshes the page. Interrupts a page while it is loading.
	Displays the home page.

Selected item	Description
	Displays the bookmarks list.
	Displays your browsing history.
	Configures browser settings.

## Using the Toolbar

You can use the toolbar to control the browser and to specify settings.

1 Press  to select a function, and then press **ENTER**.

## Browsing Web Contents

You can display the web content you want to enjoy.

1 Press  to move to the address area in the toolbar, and then press **ENTER**.

- The Enter Address menu is displayed.

2 Enter an address, and then press **ENTER**.

- The web content you want to view is displayed.



## Using the Browser (Continue)

### CAUTION

- If the power is cut due to a power failure or the TV being unplugged while you are using the Internet, information such as bookmarks or cookies may not be saved correctly.

To users who access the Internet from a PC

- When you access the Internet from this TV, the procedures may not be the same as regular browser-based access on a PC.
- On some pages, video and audio, text or images may not be displayed correctly.

### About links







- Web pages on the Internet often include "links" that allow you to jump to other web pages (or sites).
- "Links" can take various forms, including words or images, but they always work in the same way letting you jump to the link destination when you select them.
- Selected items (such as links of text input fields) are enclosed in a frame.
- You can jump from a "link" to the corresponding link destination.



## Using the Browser (Continue)

### Browser Settings

You can check or modify your browser settings from the Browser menu.

- 1 Press  to select "  " in the toolbar, and then press **ENTER**.
- 2 Press /// to specify the required setting, and then press **ENTER**.



### Using Keyboard and Mouse

You can use a keyboard or mouse for operating the TV while using the browser.

- When you use the USB devices, connect the device to the USB terminal on the TV.

#### NOTE

- The keyboard and mouse can only be used on a browser screen.  
The keyboard or mouse may not operate properly depending on the application being used.



## Miracast devices

When you connect a device such as a Miracast-compatible smartphone or tablet to this TV, you can enjoy video and audio from the device on the Monitor's large screen and speakers.

- 1 Press **APPS** to display the application window.
- 2 Press **◀▶** to select the Miracast, and then press **ENTER**.
- 3 Enable the Miracast function on the Miracast device and connect to the TV.  
(The Monitor screen changes according to the behavior of the device)

### NOTE

- When the TV is turned off or the connection is ended on the device, you must connect the device again.
- For details about the operation of the Miracast-compatible device, check the manual for that device.
- When the Miracast device is connected to the TV over a wireless LAN, Miracast video may be distorted and Miracast audio may be interrupted depending on the status of the Monitor's connection to the access point.

## Removing the Stand

- Before detaching (or attaching) the stand, make sure to turn off the TV and unplug the AC cord.

**CAUTION**

- Do not remove the stand from the TV unless using an optional wall mount bracket to mount it.

- 1 Unfasten the four screws used to secure the stand in place.

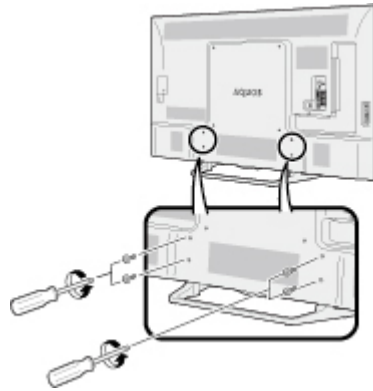
**Example**

- 2 Detach the stand from the TV.

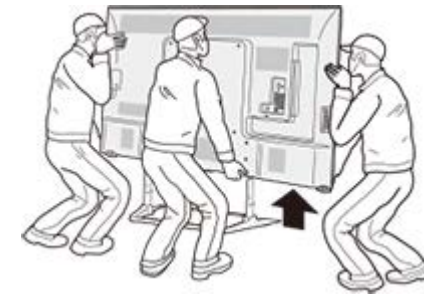
**NOTE**

- Be sure to always carry the TV by two people (90/80 inch models: three people) holding it with two hands.
- In the installation procedure, be careful not to catch your fingers between the TV set and the floor.

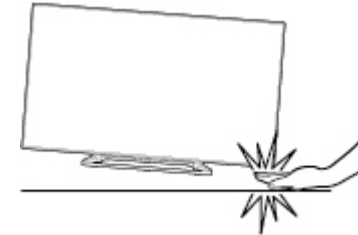

## Setting the TV on the Wall

The wall mount kit commercially available allows you to mount the TV on the wall. For detailed information on installing the wall mount, see the instructions provided with the product. We recommend you to contact a technician for assistance when installing it. SHARP is not responsible for any damage to the product or injury to yourself or others if you elect to install the wall mount on your own.

**CAUTION**

- Install your wall mount on a solid wall perpendicular to the floor. When you want to attach the wall mount to surfaces other than plaster board, please contact your nearest retailer/adviser for additional information. If you install the TV on a ceiling or slanted wall, it may fall and result in severe personal injury. Always have two people mount the TV on a wall.

**NOTE**

- Due to the terminal configuration on this TV, when you wall-mount this model, make sure there is enough space between the wall and the TV for the cables.
- To use this TV mounted on a wall, remove the AC cord holder on the rear of the TV, and then use the screws supplied with the wall mount bracket to secure the bracket to the rear of the TV.

## PN-LE901/PN-LE801

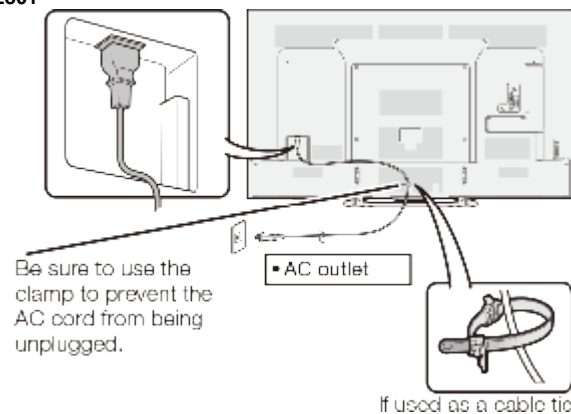

## PN-LE701/PN-LE601

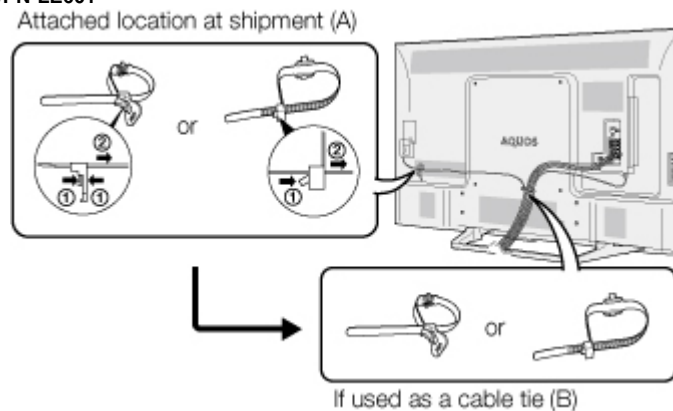

- The location of the AC cord holder differs depending on whether it is in its shipment location (A) or has been used as a cable tie (B).



## Setting the TV on the Wall(Continue)

**Wall Mount Kit Specifications**

Standard dimensions for wall mount kits are shown below.

- The illustration is based on the PN-Q601 model as an example.

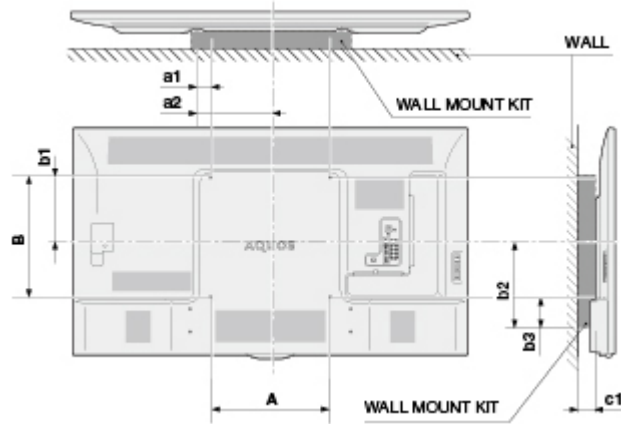

- a1: Maximum distance from the mounting hole
- a2: Maximum distance from the Monitor's center
- b1: Distance between the Monitor's center and the mounting hole
- b2: Maximum distance from the Monitor's center
- b3: Maximum distance from the mounting hole
- c1: Minimum gap

Unit: inch  
(mm)

		PN-LE901	PN-LE801	PN-LE701	PN-LE601
VESA screw hole specs (A-B)		23 5/8(600)-15 3/4(400)	23 5/8(600) - 15 3/4(400)	15 3/4(400) - 15 3/4(400)	
Width	a1	1 37/64(40)	1 5/8(41)	2 3/8(60)	
	a2	13 25/64(340)	13 7/16(341)	10 1/4(260)	
Height	b1	7 7/8(200)	8 9/32(210)		8 43/64(220)
	b2	14 49/64(375)	11 47/64(298)	10 29/32(277)	10 33/64(267)
	b3	6 57/64(175)	4 7/32(107)	3 7/16(87)	
c1		3 5/32(80)	3 13/64(81)	1 15/16(49)	1 31/32(50)

## Setting the TV on the Wall (Continue)

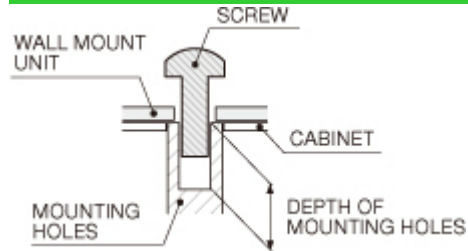
Unit: inch  
(mm)

For the screws, refer to the table shown below.

	90/80 inch models	70/60 inch models
Standard screws	M8 (Use 1.25 pitch screws.)	M6 (Use 1.0 pitch screws.)
Length(Depth of mounting holes)	15/32(12)	15/32 (12)
Quantity	4 pcs.	4 pcs.

**NOTE**

- To use this TV mounted on a wall, remove the cable tie as needed.
- Do not use screws that do not comply with the VESA standard screw specifications.
- Do not use screws that are longer than the standard length. Screws that are too long may cause damage to the inside of the TV.
- Do not fasten the screws too firmly or loosely. This may damage the product or cause the product to fall, leading to personal injury. SHARP is not liable for these kinds of accidents.
- SHARP is not liable for product damage or personal injury when a non-VESA or non-specified wall mount is used or the consumer fails to follow the product installation instructions.



Do not install the wall mount kit while your TV is turned on. It may result in personal injury due to electric shock.

## Troubleshooting

Problem	Possible Solution
<ul style="list-style-type: none"> <li>No power</li> </ul>	<ul style="list-style-type: none"> <li>Check if you pressed <b>POWER</b> on the remote control unit.</li> <li>Is the AC cord disconnected?</li> <li>Has the power been turned on?</li> </ul>
<ul style="list-style-type: none"> <li>Unit cannot be operated.</li> </ul>	<ul style="list-style-type: none"> <li>External influences such as lightning, static electricity, may cause improper operation. In this case, operate the unit after first turning off the power of the TV or unplugging the AC cord and replugging it in after 1 or 2 minutes.</li> </ul>
<ul style="list-style-type: none"> <li>Remote control unit does not operate.</li> </ul>	<ul style="list-style-type: none"> <li>Are batteries inserted with polarity (+, -) aligned?</li> <li>Are batteries worn out? (Replace with new batteries.)</li> <li>Are you using it under strong or fluorescent lighting?</li> <li>Is a fluorescent light illuminated near the remote control sensor?</li> </ul>
<ul style="list-style-type: none"> <li>Picture is cut off/with sidebar screen.</li> </ul>	<ul style="list-style-type: none"> <li>Is the image position correct? <a href="#">Page 7-1</a></li> <li>Are screen mode adjustments such as picture size made correctly? <a href="#">Pages 4-24 to 4-26</a></li> </ul>
<ul style="list-style-type: none"> <li>Strange color, light color, or color misalignment</li> </ul>	<ul style="list-style-type: none"> <li>Adjust the picture tone. <a href="#">Pages 4-16 to 4-20</a></li> <li>Is the room too bright? The picture may look dark in a room that is too bright.</li> </ul>
<ul style="list-style-type: none"> <li>Power is suddenly turned off.</li> </ul>	<ul style="list-style-type: none"> <li>Is the sleep timer set? <a href="#">Pages 3-6</a></li> <li>Check the power control settings. <a href="#">Page 4-19</a></li> <li>The unit's internal temperature has increased. Remove any objects blocking vent or clean.</li> </ul>

Problem	Possible Solution
<ul style="list-style-type: none"> <li>No picture</li> </ul>	<ul style="list-style-type: none"> <li>Is connection to other components correct?</li> <li>Is the correct input selected? <a href="#">Pages 2-1</a></li> <li>Is "On" selected in "Audio Only"? <a href="#">Page 4-19</a></li> <li>If the PC image is not displayed, check the following: <ul style="list-style-type: none"> <li>When connecting a laptop PC to the TV, check that display output mode of the PC is set to external TV.</li> <li>Check the resolution setting on the PC. Is a non-compatible signal being input? <a href="#">Page 7-9</a></li> </ul> </li> </ul>
<ul style="list-style-type: none"> <li>Picture quality of HD videos is poor.</li> </ul>	<ul style="list-style-type: none"> <li>To enjoy HD images from external equipment, you are required to set up HDMI connection or component connection.</li> <li>If the Video source is not of HD quality, HD images cannot be displayed. Check that the Video source you are viewing provides HD images.</li> <li>The HD cable/satellite set-top box may need to be configured to output HD images via cable/satellite.</li> </ul>
<ul style="list-style-type: none"> <li>The TV sometimes makes a cracking sound.</li> </ul>	<ul style="list-style-type: none"> <li>This is not a malfunction. This happens when the cabinet slightly expands and contracts according to change in temperature. This does not affect the Monitor's performance.</li> </ul>
<ul style="list-style-type: none"> <li>Some Internet functions used on a PC are not available from the TV.</li> </ul>	<ul style="list-style-type: none"> <li>The TV has only limited functions compared with regular PC browsers. <a href="#">Pages 8-4 to 8-6</a></li> </ul>

## Troubleshooting (Continue)

Problem	Possible Solution
<ul style="list-style-type: none"> <li>No sound</li> </ul>	<ul style="list-style-type: none"> <li>Is connection to other components correct?</li> <li>Is the volume too low? <a href="#">Page 3-2</a></li> <li>Is "Variable" selected in "Output Select"? <a href="#">Page 4-11</a></li> <li>Have you pressed <b>MUTE</b> on the remote control unit? <a href="#">Page 3-3</a></li> <li>Check the audio output of the connected external equipment. Is the volume too low or muted?</li> <li>When external equipment is connected via an HDMI cable, you may need to configure the audio to be output through the HDMI cable.</li> <li>When audio is not output from external equipment connected to the PC IN or HDMI IN 2 terminal, check the "Audio Select" setting. <a href="#">Page 7-2</a></li> <li>Even when external equipment is connected using an HDMI-certified cable, an audio cable connection may be required depending on the type of equipment and the media being played back. In this case, in addition to connecting an HDMI-certified cable to the HDMI IN 2 terminal, connect a Ø 3.5 mm stereo minijack cable to the AUDIO IN terminal and set "Audio Select" to "HDMI+Analog". <a href="#">Page 7-2</a></li> <li>When connecting a PC via an HDMI-certified cable, check the following: <ul style="list-style-type: none"> <li>Is the audio output of the PC configured correctly? Check the audio output settings and output audio format in Sound Properties on the PC. The audio formats compatible with this TV are PCM and Dolby Digital. With other formats, audio cannot be output.</li> <li>Depending on the board, only video signals may be output. In this case, in addition to connecting an HDMI-certified cable to the HDMI IN 2 terminal, connect a Ø 3.5 mm stereo minijack cable to the AUDIO IN terminal and set "Audio Select" to "HDMI+Analog". <a href="#">Page 7-2</a></li> </ul> </li> </ul>

**Cautions regarding use in high and low temperature environments**

- When the unit is used in a low temperature space (e.g. room, office), the picture may leave trails or appear slightly delayed. This is not a malfunction, and the unit will recover when the temperature returns to normal.
- Do not leave the unit in a hot or cold location. Also, do not leave the unit in a location exposed to direct sunlight or near a heater, as this may cause the cabinet to deform and the front panel to malfunction.  
Storage temperature: -4°F to +140°F (-20°C to +60°C)

&gt;&gt;

# Specifications

&lt;&lt;

## TV (For PN-LE901 model)

Item		Model: PN-LE901	
LCD panel	Size	90" Class (90/164" Diagonal)	
	Resolution	2,073,600 pixels (1,920 x 1,080)	
TV Function	TV-standard (CCIR)	American TV Standard ATSC/NTSC System	
	Receiving Channel	VHF/UHF	VHF 2-13ch, UHF 14-69ch
		CATV	1-135ch (non-scrambled channel only)
		Digital Terrestrial Broadcast (8VSB)	2-69ch
		Digital cable*1 (64/256 QAM)	1-135ch (non-scrambled channel only)
Audio multiplex	BTSC System		
Audio out		10W x 2	
Terminals	Back panel vertical side	HDMI IN 1	HDMI in with HDCP, ARC
		HDMI IN 2	HDMI in with HDCP, Audio in (Ø 3.5 mm stereo jack)
		HDMI IN 3	HDMI in with HDCP, MHL
		USB 1	Photo/Music/Video mode, Software update, USB keyboard/mouse, Wallpaper Picture
	Back panel surface side	COMPONENT IN	COMPONENT in
		VIDEO IN 1	AV in
		AUDIO OUT	Audio out
		PC IN	ANALOG RGB (PC) in (15-pin mini D-sub female connector), Audio in (Ø 3.5 mm stereo jack)
		RS-232C	9-pin D-sub male connector
	Back panel horizontal side	ANT/CABLE	75 Ω Unbalance, F Type x 1 for Analog (VHF/UHF/CATV) and Digital (AIR/CABLE)
		AUDIO IN	Audio in (Ø 3.5 mm stereo jack)
		DIGITAL AUDIO OUT	Optical Digital audio out x 1 (PCM/Dolby Digital/DTS)
		ETHERNET	Network connector
OSD language		English/French/Spanish	
Power Requirement		AC 120 V, 60 Hz	
On Mode Power		138 W	
Power Consumption		290 W (0.5 W Standby with AC 120 V)	
Weight	TV + stand	150.0 lbs./68.0 kg	
	TV only	141.1 lbs./64.0 kg	
Dimensions*2 W x H x D inch (mm)	TV + stand	80 7/8(2054) x 48 61/64(1243) x 17 3/32(434)	
	TV only	80 7/8(2054) x 47 11/16(1211) x 4 37/64(116)	
Operating temperature		+32°F to +104°F (0°C to +40°C)	

\*1 Emergency alert messages via Cable are unreceivable.

- As part of policy of continuous improvement, SHARP reserves the right to make design and specification changes for product improvement without prior notice. The performance specification figures indicated are nominal values of production units. There may be some deviations from these values in individual units.

&gt;&gt;

# Specifications

&lt;&lt;

## TV (PN-LE801/701/601 models)

Item		Model: PN-LE801	Model:PN-LE701	Model: PN-LE601
LCD panel	Size	80" Class (80" Diagonal)	70" Class (69 1/2" Diagonal)	60" Class (60 3/32" Diagonal)
	Resolution	2,073,600 pixels (1,920 x 1,080)		
TV Function	TV-standard (CCIR)	American TV Standard ATSC/NTSC System		
	Receiving Channel	VHF/UHF	VHF 2-13ch, UHF 14-69ch	
		CATV	1-135ch (non-scrambled channel only)	
		Digital Terrestrial Broadcast (8VSB)	2-69ch	
		Digital cable*1 (64/256 QAM)	1-135ch (non-scrambled channel only)	
Audio multiplex	BTSC System			
Audio out	10W x 2			
Terminals	Back panel vertical side	HDMI IN 3	HDMI in with HDCP, MHL	
		USB	Photo/Music/Video mode, Software update, USB keyboard/mouse, Wallpaper Picture	
		RS-232C	9-pin D-sub male connector.	
	Back panel surface side	HDMI IN 1	HDMI in with HDCP, ARC	
		HDMI IN 2	HDMI in with HDCP, Audio in (Ø 3.5 mm stereo jack)	
		COMPONENT/VIDEO IN	COMPONENT in, AV in	
		VIDEO IN 1	AV in	
		PC IN	ANALOG RGB (PC) in (15-pin mini D-sub female connector), Audio in (Ø 3.5 mm stereo jack)	
		ANT/CABLE	75 Ω Unbalance, F Type x 1 for Analog (VHF/UHF/CATV) and Digital (AIR/CABLE)	
		AUDIO IN	Audio in (Ø 3.5 mm stereo jack)	
		AUDIO OUT	Audio out (RCA)	
		DIGITAL AUDIO OUT	Optical Digital audio out x 1 (PCM/Dolby Digital/DTS)	
		ETHERNET	Network connector	
		OSD language	English/French/Spanish	
Power Requirement	AC 120 V, 60 Hz			
On Mode Power	106 W	88 W	72 W	
Power Consumption	300 W (0.5 W Standby with AC 120 V)	180 W (0.5 W Standby with AC 120 V)	150 W (0.5 W Standby with AC 120 V)	
Weight	TV + stand	114.6lbs./52.0kg	78.3 lbs./35.5 kg	56.2 lbs./25.5 kg
	TV only	110.2lbs./50.0kg	75.0 lbs./34.0 kg	52.9 lbs./24.0 kg
Dimensions*2 W x H x D inch (mm)	TV + stand	71 1/2(1816) x 42 61/64(1091) x 18 5/32(461)	61 35/64(1563) x 37 1/16(941) x 13 3/4(349)	53 23/64(1355) x 32 31/64(825) x 13 3/4(349)
	TV only	71 1/2(1816) x 41 35/64(1055) x 4 1/2(114)	61 35/64(1563) x 35 53/64(910) x 3 7/16(87)	53 23/64(1355) x 31 3/16(792) x 3 25/64(86)
Operating temperature	+32°F to +104°F (0°C to +40°C)			

\*1 Emergency alert messages via Cable are unreceivable.

- As part of policy of continuous improvement, SHARP reserves the right to make design and specification changes for product improvement without prior notice. The performance specification figures indicated are nominal values of production units. There may be some deviations from these values in individual units.

&gt;&gt;

## Specifications

&lt;&lt;

### Wireless LAN

Specification	
Standard	IEEE 802.11b/g/n
Frequency Band	2.412-2.462 GHz
Security	64-bit, 128-bit WEP, TKIP, AES, WPA, WPA2, WPS, IEEE802.11i
Modulation	DBPSK@1MBPS DQPSK@2Mbps CCK@5.5/11Mbps BPSK@6/9Mbps QPSK@12/18Mbps 16-QAM@24Mbps 64-QAM@48/54Mbps



## Trademarks



- Dolby, Dolby Audio, and the doubleD symbol are trademarks of Dolby Laboratories.

- The terms HDMI and HDMI High-Definition Multimedia Interface, and the HDMI Logo are trademarks or registered trademarks of HDMI Licensing, LLC in the United States and other countries.

- The Wi-Fi CERTIFIED Logo is a certification mark of the Wi-Fi Alliance.
- The Wi-Fi Protected Setup Mark is a mark of the Wi-Fi Alliance.
- Wi-Fi CERTIFIED Miracast™ and Miracast™ are trademarks of Wi-Fi Alliance.

- **LCフォント、LCFONT、エルシーフォント** and LC logo mark are registered trademarks of SHARP Corporation.  
This product is embedded with LC Font technology, which was developed by SHARP Corporation for clearly displaying easy-to-read characters on LCD screens. However, other fonts are used for some screen pages, too.

- For DTS patents, see <http://patents.dts.com>. Manufactured under license from DTS Licensing Limited. DTS, the Symbol, & DTS and the Symbol together are registered trademarks, and DTS 2.0+Digital Out is a trademark of DTS, Inc. © DTS, Inc. All Rights Reserved.

- MHL, the MHL Logo, and Mobile High-Definition Link are trademarks or registered trademarks of MHL LLC in the United States and other countries.
- MHL™





# Dimensional Drawings



PN-LE901

Unit: inch (mm)

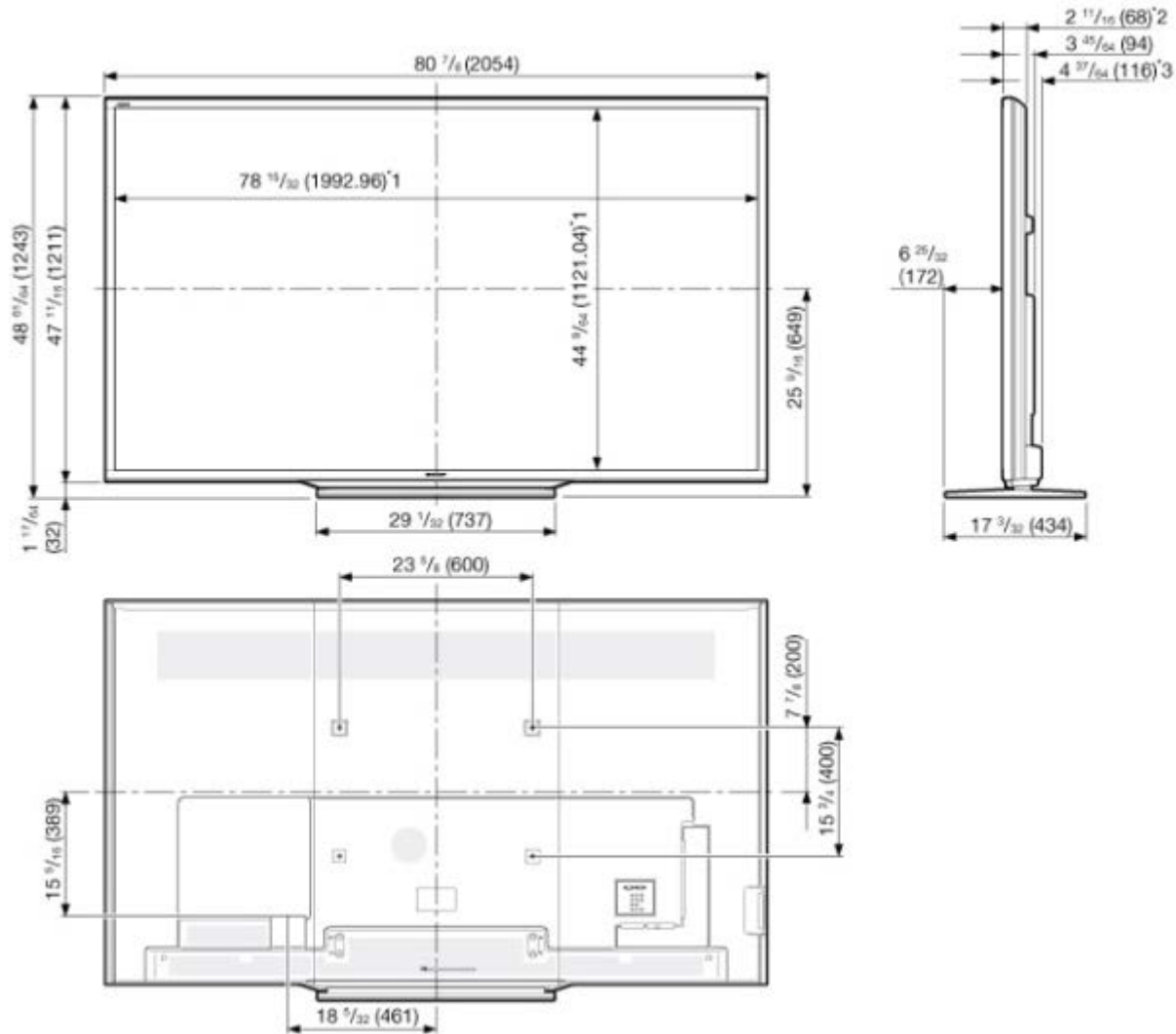

- \*1 Active area
- \*2 Thinnest part
- \*3 Including projecting parts



# Dimensional Drawings



PN-LE801

Unit: inch (mm)

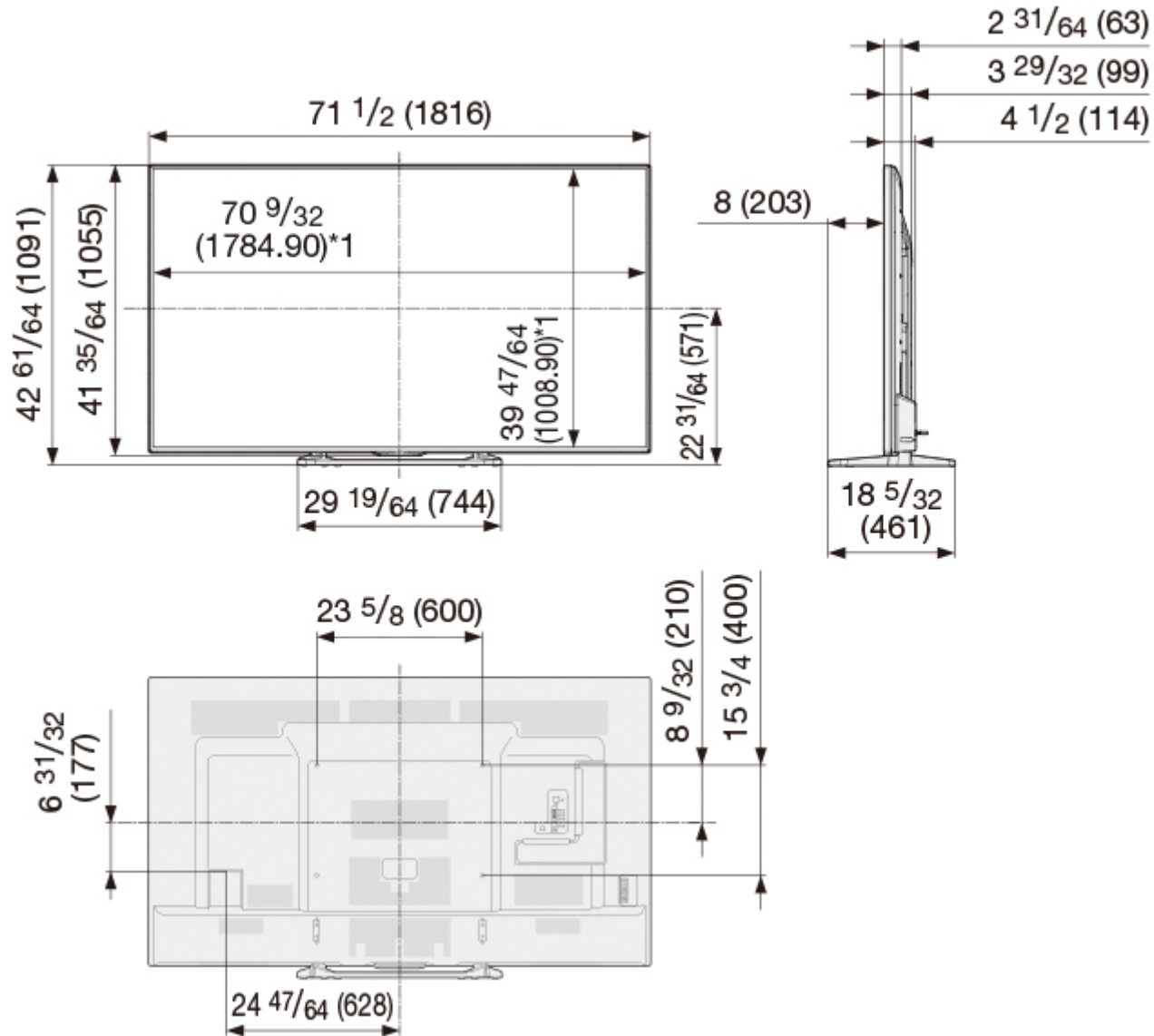

\*1 Active area

\*2 Thinnest part

\*3 Including projecting parts



# Dimensional Drawings



PN-LE701

Unit: inch (mm)

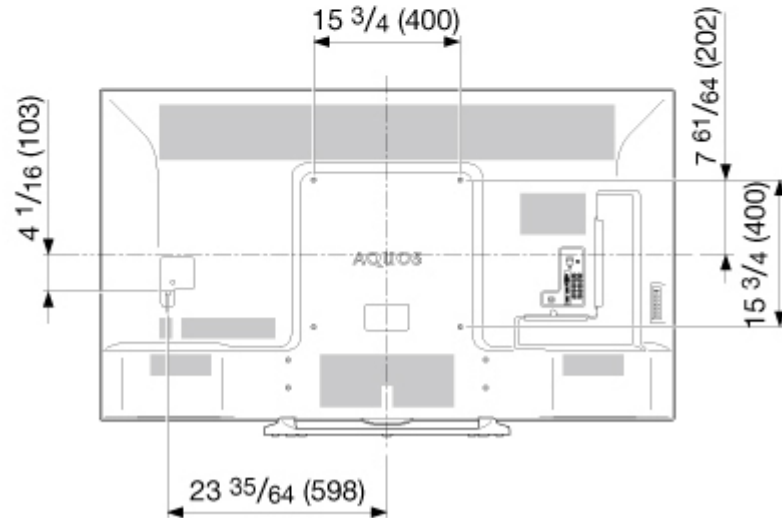
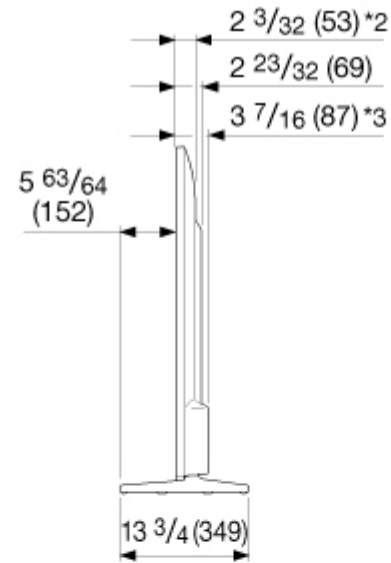
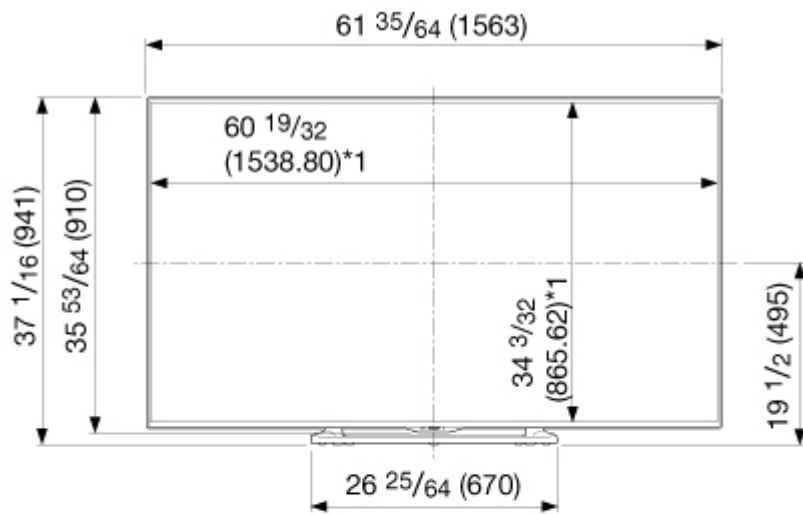

- \*1 Active area
- \*2 Thinnest part
- \*3 Including projecting parts



# Dimensional Drawings



PN-LE601

Unit: inch (mm)

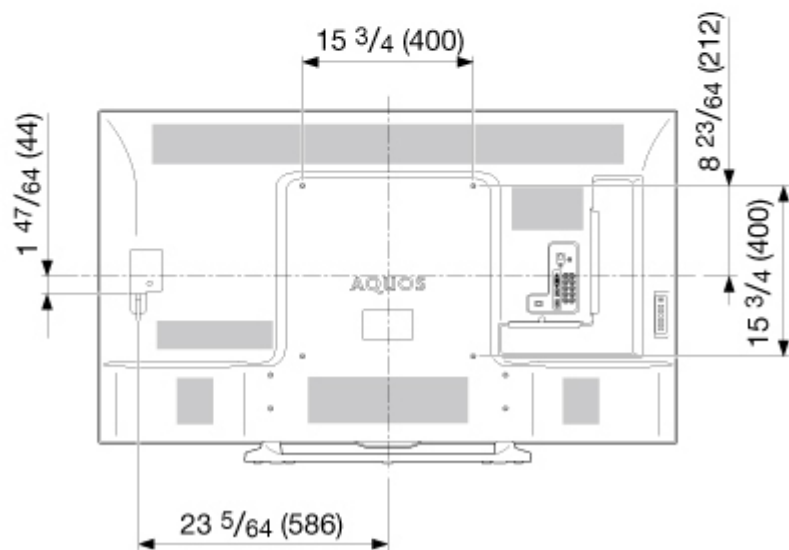
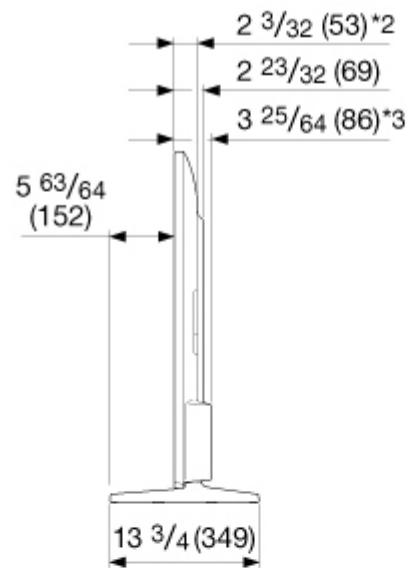
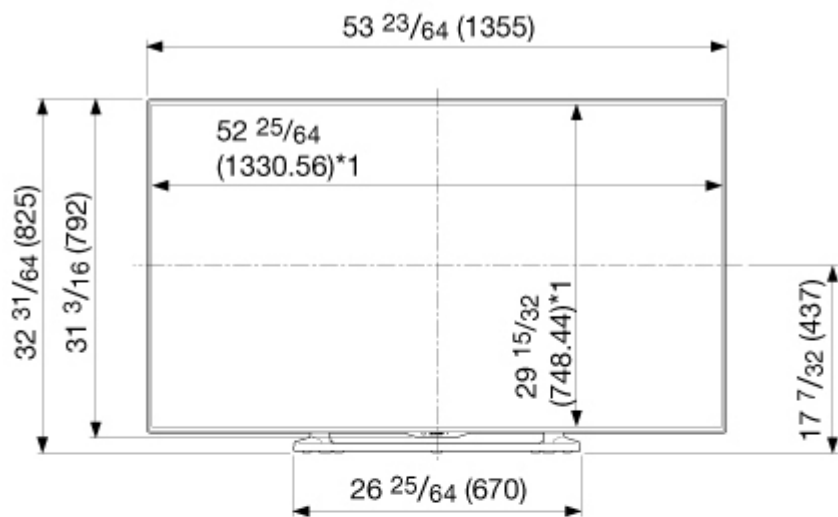

- \*1 Active area
- \*2 Thinnest part
- \*3 Including projecting parts



## Software License



Information on the open-source software license.

### Software composition

The software included in this product is comprised of various software components whose individual copyrights are held by third parties.

This product also makes use of freely distributed software and software components whose copyrights are held by third parties. These include software components covered by a GNU General Public License (hereafter GPL), a GNU Lesser General Public License (hereafter LGPL) or other license agreement.

### Obtaining source code

Some of the open source software licensors require the distributor to provide the source code with the executable software components. GPL and LGPL include similar requirements. For information on obtaining the source code for the open source software and for obtaining the GPL, LGPL, and other license agreement information.

### Acknowledgements

The following open source software components are included in this product:

/bootcode/uboot

/linux-3.7.2

/system/ap/develop/busybox/busybox-1.18.4

/system/lib/develop/e2fsprogs/e2fsprogs-1.42.6

/system/lib/develop/uClibc-0.9.30.3

/system/ap/develop/mtd/util

/system/tools/squashfs

/Platform\_Lib/Graphics/FontRenderer/libotf-0.9.9

/Platform\_Lib/Graphics/FontRenderer/fribidi-0.10.9

/Platform\_Lib/Graphics/FontRenderer/freetype-2.3.5

/Utility/tinymce

/Application/Win32/RSSClient/tinymce

/Include/Utility/tinymce"

/Utility/wpa\_supplicant

/system/tools/lzma

/open\_source/icu-54.1

/open\_source/harfbuzz/harfbuzz-0.9.35

/open\_source/graphite2/graphite2-1.2.4

/src/Platform\_Lib/Graphics/DirectFB/DirectFB-1.4.2

/open\_source/curl/curl-7.32.0

/open\_source/libwebp/libwebp-0.4.1

/open\_source/FastJpegLib/jpeg-6b

/open\_source/libmng/libmng-2.0.2

/open\_source/Libpng

/open\_source/font/freetype-2.4.11

/open\_source/c-ares/c-ares-1.10.0

/open\_source/openssl-1.0.1j

/open\_source/expat

/open\_source/zlib-1.2.3

/open\_source/Tremor

/open\_source/Alsa/alsa-lib-1.0.23

/open\_source/picotts

/Utility/wpa\_supplicant

/libmediaplayerservice/wfdisplay/spu/core/bigd\*

/open\_source/HTTPC

/open\_source/upnp

/system/src/Platform\_Lib/Graphics/JpegRenderer

/system/open\_source/libpng

/system/open\_source/gif

/system/open\_source/libwebp

[http://svnrs.realtek.com.tw/svn/col/DVR/branches/Maria/system/open\\_source/Alsa/](http://svnrs.realtek.com.tw/svn/col/DVR/branches/Maria/system/open_source/Alsa/)

[http://svnrs.realtek.com.tw/svn/col/DVR/branches/Maria/system/open\\_source/curl/curl-7.28.1/](http://svnrs.realtek.com.tw/svn/col/DVR/branches/Maria/system/open_source/curl/curl-7.28.1/)

[http://svnrs.realtek.com.tw/svn/col/DVR/branches/Maria/system/open\\_source/c-ares/c-ares-1.9.1/](http://svnrs.realtek.com.tw/svn/col/DVR/branches/Maria/system/open_source/c-ares/c-ares-1.9.1/)

[http://svnrs.realtek.com.tw/svn/col/DVR/branches/Maria/system/open\\_source/icu\\_4\\_8\\_1\\_1/](http://svnrs.realtek.com.tw/svn/col/DVR/branches/Maria/system/open_source/icu_4_8_1_1/)

[http://svnrs.realtek.com.tw/svn/col/DVR/branches/Maria/system/open\\_source/mpg123-1.21.0/](http://svnrs.realtek.com.tw/svn/col/DVR/branches/Maria/system/open_source/mpg123-1.21.0/)

[http://svnrs.realtek.com.tw/svn/col/DVR/branches/Maria/system/open\\_source/fontconfig/](http://svnrs.realtek.com.tw/svn/col/DVR/branches/Maria/system/open_source/fontconfig/)

[http://svnrs.realtek.com.tw/svn/col/DVR/branches/software\\_branches/software\\_DTV\\_QtWebKit/system/](http://svnrs.realtek.com.tw/svn/col/DVR/branches/software_branches/software_DTV_QtWebKit/system/)

[everywhere-opensource-src-5.0.0](http://svnrs.realtek.com.tw/svn/col/DVR/branches/software_branches/software_DTV_QtWebKit/system/everywhere-opensource-src-5.0.0)

[http://svnrs.realtek.com.tw/svn/col/DVR/branches/Maria/system/open\\_source/openssl-1.0.11](http://svnrs.realtek.com.tw/svn/col/DVR/branches/Maria/system/open_source/openssl-1.0.11)



## Software License



### Software copyrights

#### Bootcode:

uboot

GPL V2 <http://tv.bobitag.com/LGPL/uboot.tgz>

#### Kernel:

vmlinux

GPL V2 <http://tv.bobitag.com/LGPL/linux-3.7.2.tgz>

#### busybox

GPL V2 <http://tv.bobitag.com/LGPL/busybox-1.18.4.tgz>

#### e2fsprogs

GPL V2 <http://tv.bobitag.com/LGPL/e2fsprogs-1.42.6.tar.gz>

<http://tv.bobitag.com/LGPL/e2fsprogs-libs-1.42.6.tar.gz>

#### uclibc

LGPL 2.1 <http://tv.bobitag.com/LGPL/uClibc-0.9.30.3.tar.bz2>

#### mkfs.jffs2

GPL V2 <http://tv.bobitag.com/LGPL/jffs2.tgz>

#### mksquashfs

GPL V2 <http://tv.bobitag.com/LGPL/squashfs4.2.tar.gz>

#### Library:

libotf

LGPL V2.1 <http://tv.bobitag.com/LGPL/libotf-0.9.9.tar.gz>

fribidi

LGPL V2.1 <http://tv.bobitag.com/LGPL/fribidi-0.10.9.tar.gz>

#### freetype

FTL ~ BSD <http://tv.bobitag.com/LGPL/freetype-2.4.11.tar.gz>

tinymce

zlib <http://sourceforge.net/projects/tinymce/files/>

openssl

Apache License 1.0 BSD

<http://tv.bobitag.com/LGPL/openssl-1.0.1l.tgz>

<http://tv.bobitag.com/LGPL/openssl-1.0.1j.tar.gz>

#### Utility:

wpa\_supplicant

BSD [http://tv.bobitag.com/LGPL/wpa\\_supplicant-2.4.tar.gz](http://tv.bobitag.com/LGPL/wpa_supplicant-2.4.tar.gz)

lzma

public domain <http://tv.bobitag.com/LGPL/lzma-4.65.tgz>

Netflix

ICU

Non-restrictive open-source license

<http://tv.bobitag.com/LGPL/icu-4.8.1.1.tgz>

[http://tv.bobitag.com/LGPL/icu4c-53\\_1.tgz](http://tv.bobitag.com/LGPL/icu4c-53_1.tgz)

[http://tv.bobitag.com/LGPL/icu4c-54\\_1-src.tgz](http://tv.bobitag.com/LGPL/icu4c-54_1-src.tgz)

Harfbuzz

MIT

<http://tv.bobitag.com/LGPL/harfbuzz-0.9.35.tar.bz2>

Graphite

Apache 2.0 <http://tv.bobitag.com/LGPL/graphite2-1.2.4.tgz>

gperftools

New BSD License <http://tv.bobitag.com/LGPL/gperftools-2.2.tar.gz>

directFB

LGPL V2 <http://tv.bobitag.com/LGPL/DirectFB-1.4.2.tar.gz>

CURL

MIT/X

<http://tv.bobitag.com/LGPL/curl-7.28.1.tgz>

<http://tv.bobitag.com/LGPL/curl-7.32.0.tar.gz>

libwebp

BSD

<http://tv.bobitag.com/LGPL/libwebp-0.4.1.tar.gz>

<http://tv.bobitag.com/LGPL/libwebp-0.4.3.tar.gz>

libjpeg

JPEG

libmng

MNG License



## Software License



libpng  
libpng license.

FreeType  
freetype

c-ares  
MIT

Miracast:  
openSSL  
OpenSSL/SSLLeay

expat  
MIT/X

zlib  
Zlib

Tremor  
Xiph.org

alsa  
LGPL 2.1  
<http://tv.bobitag.com/LGPL/alsa-lib-1.0.23.tar.gz>  
<http://tv.bobitag.com/LGPL/alsa-lib-1.0.23.tgz>

picoTTS  
apache 2  
LGPL 2 <http://tv.bobitag.com/LGPL/JavaScriptCore.r118995.tar.gz>  
MIT  
BSD

Miracast:  
openssl  
Apache License 1.0  
BSD  
<http://tv.bobitag.com/LGPL/openssl-1.0.1j.tar.gz>  
<http://tv.bobitag.com/LGPL/openssl-1.0.1l.tgz>

BigDigits  
<http://www.di-mgt.com.au/bigdigitsCopyright.txt>  
<http://tv.bobitag.com/LGPL/bigdigits.tar.gz>

Http:  
neon  
GPL <http://tv.bobitag.com/LGPL/HTTTPC.tar.bz2>

DLNA:  
upnp  
No License  
<http://tv.bobitag.com/LGPL/upnp.1.6.16.tar.gz>  
<http://tv.bobitag.com/LGPL/upnp.tar.bz2>

photo:  
jpeg6b  
public domain <http://tv.bobitag.com/LGPL/jpegsrc.v6b.tar.gz>

libpng  
public domain  
<http://tv.bobitag.com/LGPL/libpng-1.6.7.tar.gz>  
<http://tv.bobitag.com/LGPL/libpng-1.6.17.tar.gz>

giflib  
public domain <http://tv.bobitag.com/LGPL/giflib-5.1.1.tar.bz2>

libwebp  
public domain  
<http://tv.bobitag.com/LGPL/libwebp-0.4.1.tar.gz>  
<http://tv.bobitag.com/LGPL/libwebp-0.4.3.tar.gz>

Others:  
alsa  
LGPL 2.1  
<http://tv.bobitag.com/LGPL/alsa-lib-1.0.23.tar.gz>  
<http://tv.bobitag.com/LGPL/alsa-lib-1.0.23.tgz>

curl  
MIT/X derivate license  
<http://tv.bobitag.com/LGPL/curl-7.28.1.tgz>  
<http://tv.bobitag.com/LGPL/curl-7.32.0.tar.gz>



## Software License



c-ares

C89 compatibility, MIT licensed  
<http://tv.bobitag.com/LGPL/c-ares-1.9.1.tgz>  
<http://tv.bobitag.com/LGPL/c-ares-1.10.0.tar.gz>

icu

ICU license , a simple, permissive non-copyleft free software license, compatible with the GNU GPL.  
<http://tv.bobitag.com/LGPL/icu-4.8.1.1.tgz>  
[http://tv.bobitag.com/LGPL/icu4c-53\\_1.tgz](http://tv.bobitag.com/LGPL/icu4c-53_1.tgz)  
[http://tv.bobitag.com/LGPL/icu4c-54\\_1-src.tgz](http://tv.bobitag.com/LGPL/icu4c-54_1-src.tgz)

mpg123

LGPL 2.1  
<http://tv.bobitag.com/LGPL/mpg123-1.21.0.tgz>

fontconfig

Copyright Ac 2000,2001,2002,2003,2004,2006,2007 Keith Packard  
Copyright Ac 2005 Patrick Lam  
Copyright Ac 2009 Roozbeh Pournader  
Copyright Ac 2008,2009 Red Hat, Inc.  
Copyright Ac 2008 Danilo A?egan  
Copyright Ac 2012 Google, Inc.  
<http://tv.bobitag.com/LGPL/fontconfig-2.11.0.tgz>

expat

same as the MIT/X Consortium license.  
<http://tv.bobitag.com/LGPL/expat.2.0.1.tar.gz>  
<http://tv.bobitag.com/LGPL/expat-1.95.tgz>

QT(including Webkit)

LGPL 2.1 <http://tv.bobitag.com/LGPL/qt-everywhere-opensource-src-5.0.0.tgz>

openssl

Apache License 1.0 BSD  
<http://tv.bobitag.com/LGPL/openssl-1.0.1j.tar.gz>  
<http://tv.bobitag.com/LGPL/openssl-1.0.1l.tgz>

## GNU GENERAL PUBLIC LICENSE

Version 2, June 1991

Copyright (C) 1989, 1991 Free Software Foundation, Inc.  
51 Franklin Street, Fifth Floor, Boston, MA 02110-1301, USA

Everyone is permitted to copy and distribute verbatim copies of this license document, but changing it is not allowed.

### Preamble

The licenses for most software are designed to take away your freedom to share and change it. By contrast, the GNU General Public License is intended to guarantee your freedom to share and change free software--to make sure the software is free for all its users. This General Public License applies to most of the Free Software Foundation's software and to any other program whose authors commit to using it. (Some other Free Software Foundation software is covered by the GNU Lesser General Public License instead.) You can apply it to your programs, too.

When we speak of free software, we are referring to freedom, not price. Our General Public Licenses are designed to make sure that you have the freedom to distribute copies of free software (and charge for this service if you wish), that you receive source code or can get it if you want it, that you can change the software or use pieces of it in new free programs; and that you know you can do these things.

To protect your rights, we need to make restrictions that forbid anyone to deny you these rights or to ask you to surrender the rights. These restrictions translate to certain responsibilities for you if you distribute copies of the software, or if you modify it.

For example, if you distribute copies of such a program, whether gratis or for a fee, you must give the recipients all the rights that you have. You must make sure that they, too, receive or can get the source code. And you must show them these terms so they know their rights.

We protect your rights with two steps: (1) copyright the software, and (2) offer you this license which gives you legal permission to copy, distribute and/or modify the software.





## Software License



Also, for each author's protection and ours, we want to make certain that everyone understands that there is no warranty for this free software. If the software is modified by someone else and passed on, we want its recipients to know that what they have is not the original, so that any problems introduced by others will not reflect on the original authors' reputations.

Finally, any free program is threatened constantly by software patents. We wish to avoid the danger that redistributors of a free program will individually obtain patent licenses, in effect making the program proprietary. To prevent this, we have made it clear that any patent must be licensed for everyone's free use or not licensed at all.

The precise terms and conditions for copying, distribution and modification follow.

### TERMS AND CONDITIONS FOR COPYING, DISTRIBUTION AND MODIFICATION

0. This License applies to any program or other work which contains a notice placed by the copyright holder saying it may be distributed under the terms of this General Public License. The "Program", below, refers to any such program or work, and a "work based on the Program" means either the Program or any derivative work under copyright law: that is to say, a work containing the Program or a portion of it, either verbatim or with modifications and/or translated into another language. (Hereinafter, translation is included without limitation in the term "modification".) Each licensee is addressed as "you".

Activities other than copying, distribution and modification are not covered by this License; they are outside its scope. The act of running the Program is not restricted, and the output from the Program is covered only if its contents constitute a work based on the Program (independent of having been made by running the Program). Whether that is true depends on what the Program does.

1. You may copy and distribute verbatim copies of the Program's source code as you receive it, in any medium, provided that you conspicuously and appropriately publish on each copy an appropriate copyright notice and disclaimer of warranty; keep intact all the notices that refer to this License and to the absence of any warranty; and give any other recipients of the Program a copy of this License along with the Program.

You may charge a fee for the physical act of transferring a copy, and you may at your option offer warranty protection in exchange for a fee.

2. You may modify your copy or copies of the Program or any portion of it, thus forming a work based on the Program, and copy and distribute such modifications or work under the terms of Section 1 above, provided that you also meet all of these conditions:

- a) You must cause the modified files to carry prominent notices stating that you changed the files and the date of any change.
- b) You must cause any work that you distribute or publish, that in whole or in part contains or is derived from the Program or any part thereof, to be licensed as a whole at no charge to all third parties under the terms of this License.
- c) If the modified program normally reads commands interactively when run, you must cause it, when started running for such interactive use in the most ordinary way, to print or display an announcement including an appropriate copyright notice and a notice that there is no warranty (or else, saying that you provide a warranty) and that users may redistribute the program under these conditions, and telling the user how to view a copy of this License. (Exception: if the Program itself is interactive but does not normally print such an announcement, your work based on the Program is not required to print an announcement.)

These requirements apply to the modified work as a whole. If identifiable sections of that work are not derived from the Program, and can be reasonably considered independent and separate works in themselves, then this License, and its terms, do not apply to those sections when you distribute them as separate works. But when you distribute the same sections as part of a whole which is a work based on the Program, the distribution of the whole must be on the terms of this License, whose permissions for other licensees extend to the entire whole, and thus to each and every part regardless of who wrote it.

Thus, it is not the intent of this section to claim rights or contest your rights to work written entirely by you; rather, the intent is to exercise the right to control the distribution of derivative or collective works based on the Program.

In addition, mere aggregation of another work not based on the Program with the Program (or with a work based on the Program) on a volume of a storage or distribution medium does not bring the other work under the scope of this License.

3. You may copy and distribute the Program (or a work based on it, under Section 2) in object code or executable form under the terms of Sections 1 and 2 above provided that you also do one of the following:

- a) Accompany it with the complete corresponding machine-readable source code, which must be distributed under the terms of Sections 1 and 2 above on a medium customarily used for software interchange; or,
- b) Accompany it with a written offer, valid for at least three years, to give any third party, for a charge no more than your cost of physically performing source distribution, a complete machine-readable copy of the corresponding source code, to be distributed under the terms of Sections 1 and 2 above on a medium customarily used for software interchange; or,
- c) Accompany it with the information you received as to the offer to distribute corresponding source code. (This alternative is allowed only for noncommercial distribution and only if you received the program in object code or executable form with such an offer, in accord with Subsection b above.)

The source code for a work means the preferred form of the work for making modifications to it. For an executable work, complete source code means all the source code for all modules it contains, plus any associated interface definition files, plus the scripts used to control compilation and installation of the executable. However, as a special exception, the source code distributed need not include anything that is normally distributed (in either source or binary form) with the major components (compiler, kernel, and so on) of the operating system on which the executable runs, unless that component itself accompanies the executable.

If distribution of executable or object code is made by offering access to copy from a designated place, then offering equivalent access to copy the source code from the same place counts as distribution of the source code, even though third parties are not compelled to copy the source along with the object code.

4. You may not copy, modify, sublicense, or distribute the Program except as expressly provided under this License. Any attempt otherwise to copy, modify, sublicense or distribute the Program is void, and will automatically terminate your rights under this License. However, parties who have received copies, or rights, from you under this License will not have their licenses terminated so long as such parties remain in full compliance.

5. You are not required to accept this License, since you have not signed it. However, nothing else grants you permission to modify or distribute the Program or its derivative works. These actions are prohibited by law if you do not accept this License. Therefore, by modifying or distributing the Program (or any work based on the Program), you indicate your acceptance of this License to do so, and all its terms and conditions for copying, distributing or modifying the Program or works based on it.

6. Each time you redistribute the Program (or any work based on the Program), the recipient automatically receives a license from the original licensor to copy, distribute or modify the Program subject to these terms and conditions. You may not impose any further restrictions on the recipients' exercise of the rights granted herein. You are not responsible for enforcing compliance by third parties to this License.

7. If, as a consequence of a court judgment or allegation of patent infringement or for any other reason (not limited to patent issues), conditions are imposed on you (whether by court order, agreement or otherwise) that contradict the conditions of this License, they do not excuse you from the conditions of this License. If you cannot distribute so as to satisfy simultaneously your obligations under this License and any other pertinent obligations, then as a consequence you may not distribute the Program at all. For example, if a patent license would not permit royalty-free redistribution of the Program by all those who receive copies directly or indirectly through you, then the only way you could satisfy both it and this License would be to refrain entirely from distribution of the Program.

If any portion of this section is held invalid or unenforceable under any particular circumstance, the balance of the section is intended to apply and the section as a whole is intended to apply in other circumstances.

It is not the purpose of this section to induce you to infringe any patents or other property right claims or to contest validity of any such claims; this section has the sole purpose of protecting the integrity of the free software distribution system, which is implemented by public license practices. Many people have made generous contributions to the wide range of software distributed through that system in reliance on consistent application of that system; it is up to the author/donor to decide if he or she is willing to distribute software through any other system and a licensee cannot impose that choice.

This section is intended to make thoroughly clear what is believed to be a consequence of the rest of this License.



## Software License



8. If the distribution and/or use of the Program is restricted in certain countries either by patents or by copyrighted interfaces, the original copyright holder who places the Program under this License may add an explicit geographical distribution limitation excluding those countries, so that distribution is permitted only in or among countries not thus excluded. In such case, this License incorporates the limitation as if written in the body of this License.

9. The Free Software Foundation may publish revised and/or new versions of the General Public License from time to time. Such new versions will be similar in spirit to the present version, but may differ in detail to address new problems or concerns.

Each version is given a distinguishing version number. If the Program specifies a version number of this License which applies to it and "any later version", you have the option of following the terms and conditions either of that version or of any later version published by the Free Software Foundation. If the Program does not specify a version number of this License, you may choose any version ever published by the Free Software Foundation.

10. If you wish to incorporate parts of the Program into other free programs whose distribution conditions are different, write to the author to ask for permission. For software which is copyrighted by the Free Software Foundation, write to the Free Software Foundation; we sometimes make exceptions for this. Our decision will be guided by the two goals of preserving the free status of all derivatives of our free software and of promoting the sharing and reuse of software generally.

### NO WARRANTY

11. BECAUSE THE PROGRAM IS LICENSED FREE OF CHARGE, THERE IS NO WARRANTY FOR THE PROGRAM, TO THE EXTENT PERMITTED BY APPLICABLE LAW. EXCEPT WHEN OTHERWISE STATED IN WRITING THE COPYRIGHT HOLDERS AND/OR OTHER PARTIES PROVIDE THE PROGRAM "AS IS" WITHOUT WARRANTY OF ANY KIND, EITHER EXPRESSED OR IMPLIED, INCLUDING, BUT NOT LIMITED TO, THE IMPLIED WARRANTIES OF MERCHANTABILITY AND FITNESS FOR A PARTICULAR PURPOSE. THE ENTIRE RISK AS TO THE QUALITY AND PERFORMANCE OF THE PROGRAM IS WITH YOU. SHOULD THE PROGRAM PROVE DEFECTIVE, YOU ASSUME THE COST OF ALL NECESSARY SERVICING, REPAIR OR CORRECTION.

12. IN NO EVENT UNLESS REQUIRED BY APPLICABLE LAW OR AGREED TO IN WRITING WILL ANY COPYRIGHT HOLDER, OR ANY OTHER PARTY WHO MAY MODIFY AND/OR REDISTRIBUTE THE PROGRAM AS PERMITTED ABOVE, BE LIABLE TO YOU FOR DAMAGES, INCLUDING ANY GENERAL, SPECIAL, INCIDENTAL OR CONSEQUENTIAL DAMAGES ARISING OUT OF THE USE OR INABILITY TO USE THE PROGRAM (INCLUDING BUT NOT LIMITED TO LOSS OF DATA OR DATA BEING RENDERED INACCURATE OR LOSSES SUSTAINED BY YOU OR THIRD PARTIES OR A FAILURE OF THE PROGRAM TO OPERATE WITH ANY OTHER PROGRAMS), EVEN IF SUCH HOLDER OR OTHER PARTY HAS BEEN ADVISED OF THE POSSIBILITY OF SUCH DAMAGES.

### END OF TERMS AND CONDITIONS

#### How to Apply These Terms to Your New Programs

If you develop a new program, and you want it to be of the greatest possible use to the public, the best way to achieve this is to make it free software which everyone can redistribute and change under these terms.

To do so, attach the following notices to the program. It is safest to attach them to the start of each source file to most effectively convey the exclusion of warranty; and each file should have at least the "copyright" line and a pointer to where the full notice is found.

one line to give the program's name and an idea of what it does.  
Copyright (C) yyyy name of author

This program is free software; you can redistribute it and/or modify it under the terms of the GNU General Public License as published by the Free Software Foundation; either version 2 of the License, or (at your option) any later version.

This program is distributed in the hope that it will be useful, but WITHOUT ANY WARRANTY; without even the implied warranty of MERCHANTABILITY or FITNESS FOR A PARTICULAR PURPOSE. See the GNU General Public License for more details.



## Software License



You should have received a copy of the GNU General Public License along with this program; if not, write to the Free Software Foundation, Inc., 51 Franklin Street, Fifth Floor, Boston, MA 02110-1301, USA.

Also add information on how to contact you by electronic and paper mail.

If the program is interactive, make it output a short notice like this when it starts in an interactive mode:

```
Gnomovision version 69, Copyright (C) year name of author
Gnomovision comes with ABSOLUTELY NO WARRANTY; for details type `show w'. This is free
software, and you are welcome to redistribute it under certain conditions; type `show c' for details.
```

The hypothetical commands ``show w'` and ``show c'` should show the appropriate parts of the General Public License. Of course, the commands you use may be called something other than ``show w'` and ``show c'`; they could even be mouse-clicks or menu items--whatever suits your program.

You should also get your employer (if you work as a programmer) or your school, if any, to sign a "copyright disclaimer" for the program, if necessary. Here is a sample; alter the names:

```
Yoyodyne, Inc., hereby disclaims all copyright interest in the program `Gnomovision' (which makes
passes at compilers) written by James Hacker.
```

```
signature of Ty Coon, 1 April 1989
Ty Coon, President of Vice
```

This General Public License does not permit incorporating your program into proprietary programs. If your program is a subroutine library, you may consider it more useful to permit linking proprietary applications with the library. If this is what you want to do, use the GNU Lesser General Public License instead of this License.



**SHARP**<sup>®</sup>  
SHARP CORPORATION