

SEC. WORK	가	나	다	PRINTING DEGREE	MATERIAL AND PRINTING DESCRIPTION	LG MODEL 명	SUFFIX	LANGUAGE	PAGE	REMARK
	BRAND	MODEL	P/NO.							
74	LG	F8K5XNK(0~9)	MFL68881074	1	SNOW WHITE 80g OFFSET 인쇄	F8K5XNK(0~9)	A**QKUK	ENG	48	W-Module - PJT 매뉴얼 작업처 : 인쇄물 개발파트 양산처 : 국제인쇄

<< 주기 >>

1. 재질, 인쇄방법, 인쇄도수, 외곽치수등은 작업표에 준한다.
2. 인쇄내용, 문자크기 및 형상, 선의 굵기 등은 설계에서 제시된 FILM에 준함.
3. 외곽치수는 절단후 치수임.
4. 양산전에 설계 한도를 득할 것.
5. 본 부품에 금지물질이 포함되지 않도록 하고, 상세내용은 LG(63)-A-5501-34를 만족할 것

<< NOTES >>

1. Material, printing and exterior size are refer to work tables.
2. Printing, text size and line are based on LG design film.
3. Exterior size on the drawing is cutting line.
4. Before product controlled by criteria sample.
5. The part should not contain prohibited substances(Pb,Cd,Hg,Cr+6,PBB,PBDE) and details should comply with LG standard of LG(63)-A-5501-34

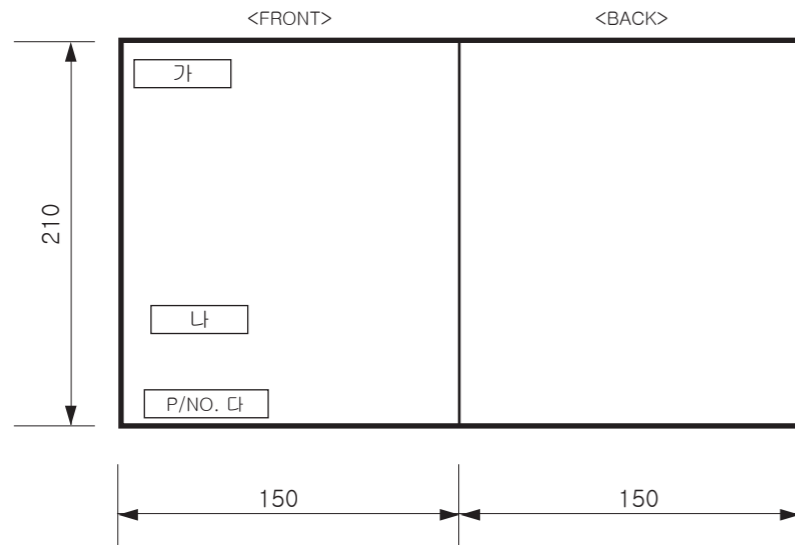

PDF ILLUSTRATOR
DR COMPLETED
도면 DR 완료
완료일:

REV. NO. 기호	REVISION DESCRIPTION 변경 사항	REF. NO. 시방 번호	DATE 년/월/일	PREPARED 시방자	APPROVED 승인자
△	인쇄물 심의의 Comment 사항 반영을 위한 매뉴얼 수정	EAGH300687	17/03/17	남호빈	김영수
△					
△					
△					

TRIG.	UNIT	mm	SCALE	N	S
MODELING	DESIGNED	REVIEWED	CHECKED	APPROVED	
	남호빈 17.03.13	김민수 17.03.13	전종목 17.03.13	김영수 17.03.13	
LG 전자 (주) LG Electronics Inc.			RELATED DWG.		DWG. No.

MANUAL, OWNER'S
DRUM-EXPORT | 1/1
MFL68881074



OWNER'S MANUAL

WASHING MACHINE



Before beginning installation, read these instructions carefully. This will simplify installation and ensure that the product is installed correctly and safely. Leave these instructions near the product after installation for future reference.

F8K5XN3



MFL68881074
Rev.00_031617

www.lg.com

TABLE OF CONTENTS

This manual may contain images or content different from the model you purchased.

This manual is subject to revision by the manufacturer.

SAFETY INSTRUCTIONS	4
IMPORTANT SAFETY INSTRUCTIONS	4
Disposal of Your Old Appliance	9
INSTALLATION	10
Parts	10
Accessories	11
Specifications	11
Installation Place Requirements	12
Stacking the Pedestal Washing Machine	13
Connecting the Supply Hose	14
Installing the Drain Hose	16
Leveling the Appliance.....	17
OPERATION	19
Using the Appliance.....	19
Sorting Laundry	20
Closing the Door and Drawer	21
Adding Cleaning Products	22
Control Panel	24
Programme Table	25
Option Programme	27
SMART FUNCTIONS	28
Using Smart ThinQ Application.....	28
Using Smart Diagnosis™	31
MAINTENANCE.....	32
Cleaning the Washing Machine	32
Cleaning the Drum.....	33
Cleaning the Water Inlet Filter	33
Caution on Freezing During Winter	34
TROUBLESHOOTING	36
Diagnosing Problems	36
Error Messages	40

The following safety guidelines are intended to prevent unforeseen risks or damage from unsafe or incorrect operation of the appliance.

The guidelines are separated into 'WARNING' and 'CAUTION' as described below.

 This symbol is displayed to indicate matters and operations that can cause risk. Read the part with this symbol carefully and follow the instructions in order to avoid risk.

 **WARNING**

This indicates that the failure to follow the instructions can cause serious injury or death.

 **CAUTION**

This indicates that the failure to follow the instructions can cause the minor injury or damage to the product.

IMPORTANT SAFETY INSTRUCTIONS

 **WARNING**

To reduce the risk of explosion, fire, death, electric shock, injury or scalding to persons when using this product, follow basic precautions, including the following:

Children in the Household

This appliance is not intended for use by persons (including children) with reduced physical, sensory or mental capabilities, or lack of experience and knowledge, unless they have been given supervision or instruction concerning use of the appliance by a person responsible for their safety. Children should be supervised to ensure that they do not play with the appliance.

For use in Europe:

This appliance can be used by children aged from 8 years and above and persons with reduced physical, sensory or mental capabilities or lack of experience and knowledge if they have been given supervision or instruction concerning use of the appliance in a safe way and understand the hazards involved. Children shall not play with the appliance. Cleaning and user maintenance shall not be made by children without supervision.

Children of less than 3 years should be kept away unless continuously supervised.

Installation

- Never attempt to operate the appliance if it is damaged, malfunctioning, partially disassembled, or has missing or broken parts, including a damaged cord or plug.
- This appliance should only be installed and transported by two or more people holding the appliance securely.
- Do not install the appliance in a damp and dusty place. Do not install or store the appliance in any outdoor area, or any area that is subject to weathering conditions such as direct sunlight, wind, or rain or temperatures below freezing.
- Tighten the drain hose to avoid separation.

- If the power cord is damaged or the hole of the socket outlet is loose, do not use the power cord and contact an authorized service centre.
- This appliance must not be installed behind a lockable door, a sliding door or a door with a hinge on the opposite side to that of the appliance, in such a way that a full opening of the appliance door is restricted.
- This appliance must be grounded. In the event of malfunction or breakdown, grounding will reduce the risk of electric shock by providing a path of least resistance for electric current.
- This appliance is equipped with a power cord having an equipment-grounding conductor and a grounding power plug. The power plug must be plugged into an appropriate socket outlet that is installed and grounded in accordance with all local codes and ordinances.
- Improper connection of the equipment-grounding conductor can result in risk of electric shock. Check with a qualified electrician or service personnel if you are in doubt as to whether the appliance is properly grounded.
- Do not modify the power plug provided with the appliance. If it does not fit the outlet, have a proper outlet installed by a qualified electrician.

Operation

- Do not use a sharp object like drill or pin to press or separate an operation unit.
- Do not repair or replace any part of the appliance. All repairs and servicing must be performed by qualified service personnel unless specifically recommended in this Owner's Manual. Use only authorized factory parts.
- Use new hose or hose-set supplied with the appliance. Reusing old hoses can cause a water leak and subsequent property damage.
- Do not reach into the appliance if the tub or agitator is moving.
- Keep the area underneath and around the appliance free of combustible materials such as lint, paper, rags, chemicals, etc.
- Do not put animals, such as pets into the appliance.
- Do not leave the appliance door open. Children may hang on the door or crawl inside the appliance, causing damage or injury.
- Never reach into the appliance while it is operating. Wait until the drum has completely stopped.
- Do not put in, wash or dry articles that have been cleaned in, washed in, soaked in, or spotted with combustible or explosive substances (such as wax, oil, paint, gasoline, degreasers, drycleaning solvents, kerosene, vegetable oil, cooking oil, etc.). Improper use can cause fire or explosion.
- In case of flood, disconnect the power plug and contact the LG Electronics customer information centre.
- Do not push down the drawer excessively, when the appliance drawer is open.

- Do not touch the door during a high temperature programme.
- Do not use flammable gas and combustible substances (benzene, gasoline, thinner, petroleum, alcohol, etc.) near the appliance.
- If the drain hose or inlet hose is frozen during winter, use it only after thawing.
- Keep all washing detergents, softener and bleach away from children.
- Do not touch the power plug or the appliance controls with wet hands.
- When pulling out the power plug from an outlet, hold the power plug, not the cable.
- Do not bend the power cable excessively or place a heavy object on it.
- If there is a gas leakage (isobutane, propane, natural gas, etc.), do not touch the appliance or power plug and ventilate the area immediately.
- Do not operate the pedestal washing machine with two or more pedestal washing machines stacked.
- To avoid breaking the door glass, do not push too hard on the door when closing.
- Do not step on the pedestal washing machine.
- Do not wash rugs, mats, shoes or pet blankets, or any other items other than clothes or sheets, in this machine.
- This appliance must only be used for domestic household purposes and should not be used in mobile applications.
- Do not open or close the door by foot.

Maintenance

- Securely plug the power plug in the socket outlet after completely removing any moisture and dust.
- Disconnect the power cord before cleaning the appliance.
- Never unplug the appliance by pulling on the power cable. Always grip the power plug firmly and pull straight out from the socket outlet.
- Do not spray water inside or outside the appliance to clean it.

Disposal

- Before discarding an old appliance, unplug it. Cut off the cable directly behind the appliance to prevent misuse.
- Dispose of all packaging materials (such as plastic bags and styrofoam) away from children. The packaging materials can cause suffocation.
- Remove the door before disposing of or discarding this appliance to avoid the danger of children or small animals getting trapped inside.

Disposal of Your Old Appliance



- This crossed-out wheeled bin symbol indicates that waste electrical and electronic products (WEEE) should be disposed of separately from the municipal waste stream.
- Old electrical products can contain hazardous substances so correct disposal of your old appliance will help prevent potential negative consequences for the environment and human health. Your old appliance may contain reusable parts that could be used to repair other products, and other valuable materials that can be recycled to conserve limited resources.
- You can take your appliance either to the shop where you purchased the product, or contact your local government waste office for details of your nearest authorised WEEE collection point. For the most up to date information for your country please see www.lg.com/global/recycling.

Parts

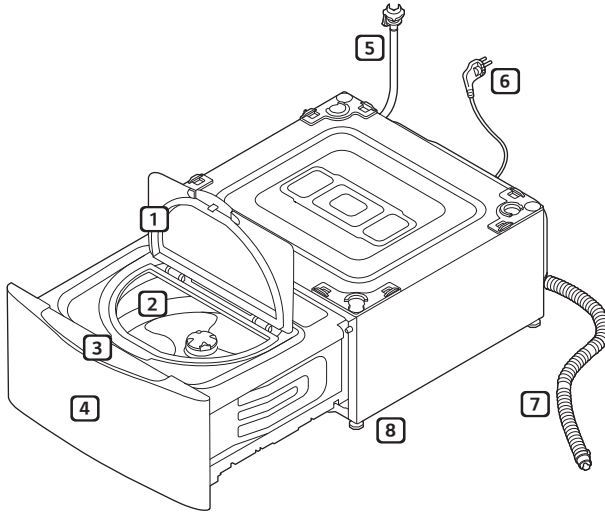

1 Door

2 Drum

3 Control Panel

4 Drawer

5 Water Supply Hose

6 Power Plug

7 Water Drain Hose

8 Leveling Feet

Accessories

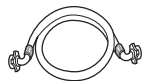

Water supply hose
(for cold water)



Connecting
supply hose



Water drain hose



Water supply hose
connector



Water drain hose
connector



Anti-slip sheets
(2 EA)



Detergent
measuring
cup

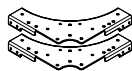

Brackets (front)
(2 EA)



Brackets (back)
(2 EA)



Spanner

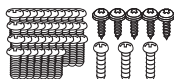

* Screws
Type A (37 EA)
Type B (5 EA)
Type C (3 EA)



Cable ties
(2 EA)



Band clamps
(3 EA)



Stacking holder



Remote control
(optional)

* Type A : long sheet metal screw, Type B : short sheet metal screw, Type C : machine screw

NOTE

- Different accessories may apply to each model.
- The stacking holder is for preventing independent operation.
- Depending on the installation environment, you may have to purchase a separate drain hose connector.
- In addition to the screws required for installation, extra screws have been provided.

Specifications

Power supply	220 - 240 V~, 50 Hz
Size	600 mm (W) X 700 mm (D) X 365 mm(H)
Product weight	43 kg
Permissible water pressure	0.1 - 0.8 Mpa (1.0 - 8.0 kgf / cm ²)
Wash capacity	2 kg

- Appearance and specifications may change without notice to improve the quality of the product.

Installation Place Requirements

Location

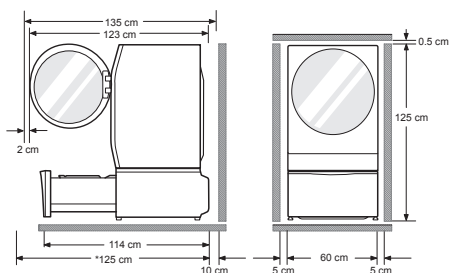

*125 cm: minimum space for installation

Level floor : Allowable slope under the entire appliance is 1°.

Power outlet : Must be within 1.5 meters of either side of the location of the appliance.

- Do not overload the outlet with more than one appliance.

Additional Clearance : 5 cm at the sides and 10 cm behind the unit.

- Do not place or store laundry products on top of the appliance at any time. These products may damage the finish or controls.

⚠ WARNING

- The plug must be plugged into an appropriate outlet that is properly installed and grounded in accordance with all local codes and ordinances.

Positioning

- Install the appliance on a flat hard floor.
- Make sure that air circulation around the appliance is not impeded by carpets, rugs, etc.
- Never try to correct any unevenness in the floor with pieces of wood, cardboard or similar materials under the appliance.
- If it is impossible to avoid positioning the appliance next to a gas cooker or coal burning stove, an insulation (85x60 cm) covered with aluminum foil on the side facing the cooker or stove must be inserted between the two appliances.

- Do not install the appliance in rooms where freezing temperatures may occur. Frozen hoses may burst under pressure. The reliability of the electronic control unit may be impaired at temperatures below freezing point.
- Ensure that when the appliance is installed, it is easily accessible for an engineer in the event of a breakdown.
- With the appliance installed, adjust all four feet using a transit bolt spanner to ensure the appliance is stable, and a clearance of approximately 5 mm is left between the top of the appliance and the underside of any work-top.
- If the appliance is delivered in winter and temperatures are below freezing, place the appliance at room temperature for a few hours before putting it into operation.
- Do not use a drip pan as it can block the drawer. Using the drip pan may result in increased vibration and noise during operation.

⚠ WARNING

- This appliance is not designed for maritime use or for use in mobile installations such as caravans, aircraft etc.

Electrical Connection

- Do not use an extension cord or double adapter.
- Always unplug the appliance and turn off the water supply after use.
- Connect the appliance to an earthed socket in accordance with current wiring regulations.
- The appliance must be positioned so that the plug is easily accessible.
- Repairs to the appliance must only be carried out by qualified personnel. Repairs carried out by inexperienced persons may cause injury or serious malfunctioning. Contact your local service centre.

Stacking the Pedestal Washing Machine

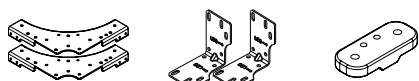
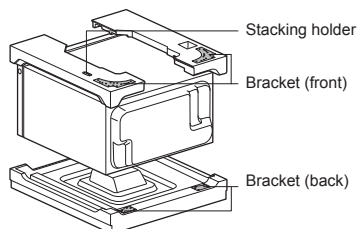

Brackets (front) Brackets (back) Stacking holder

- 1** Tilt and hold the front-loading washing machine.

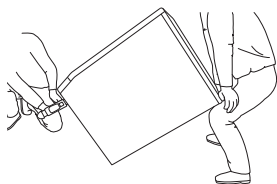

- 2** Assemble the bracket (front) and stacking holder at the bottom of the front-loading washing machine.

- First assemble each bracket using 7 type A screws, then the stacking holder using 2 type A screws.

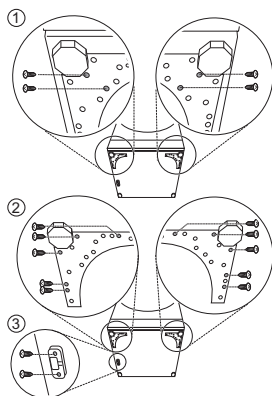

- 3** Pull and save the foam block for future use.

- If the washing machine must be moved in the future, the foam block will help prevent damage to the washing machine during transportation.

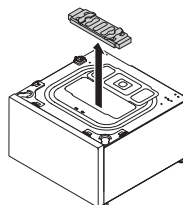

NOTE

- To prevent damage, do not remove the foam block until the pedestal washing machine is at the final location.

- 4** Turn the top cover about 180 degrees. Cover the upper hole with the top cover and install 4 type B screws to fix it in place.

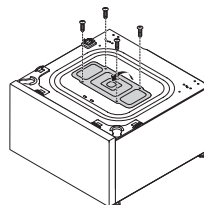

- 5** Attach the two back brackets on the rear top of the pedestal washing machine by inserting 4 type A screws in each bracket.

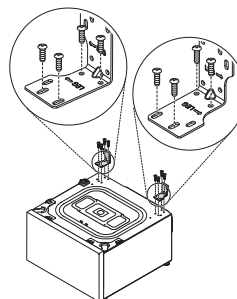

- 6** Place the front-loading washing machine on top of pedestal washing machine.

- Make sure the 4 legs are totally locked and the holes of the pedestal washing machine align with the holes of the front-loading washing machine.

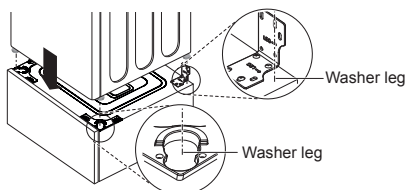

- 7** Securely attach the two appliances at the corners using 14 type A screws.

- First, insert screws on each side. Then insert screws on the front and back side.

NOTE

- It can be difficult to assemble if it is not assembled in the proper order.
- Use two type C screws to assemble the stacking holder.

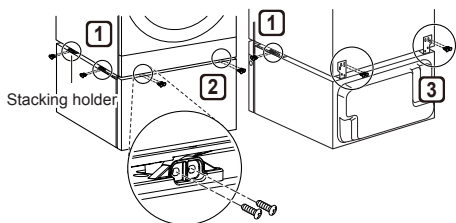

- 8** Turn the feet of the front-loading washing machine slightly until it is snugged up against the pedestal washing machine.

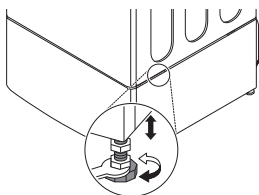

NOTE

- Pedestal washing machine will not work as a standalone unit.

Connecting the Supply Hose

- Water supply pressure must be between 0.1 MPa and 0.8 MPa (1.0–8.0 kgf/cm²).
- Do not overtighten the water supply hose.
- If the water supply pressure is more than 0.8 MPa, a decompression device should be installed.
- Periodically check the condition of the hose and replace the hose if necessary.
- Contact the service centre if there is no rubber seal.

Checking the Rubber Seal on the Supply Hose

Two rubber seals are supplied with the water supply hoses. They are used for preventing water leaks. Make sure the connection to taps is sufficiently tight.

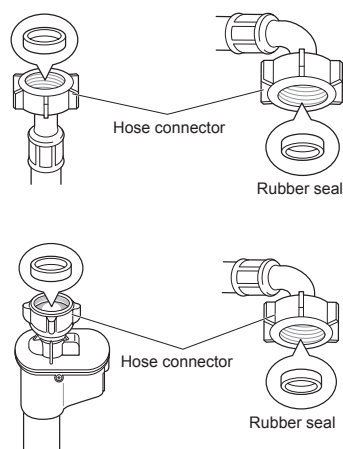

Connecting Hose to Water Tap

Connecting Screw-Type Hose to Tap with Thread

Screw the hose connector onto the water supply tap.

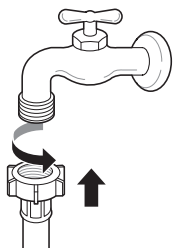

Connecting Hose to Two Washing Machines

- 1 Connect the water supply hose connector to the water supply hose of the front-loading washing machine. Open the accessory package for pedestal washing machine installation.

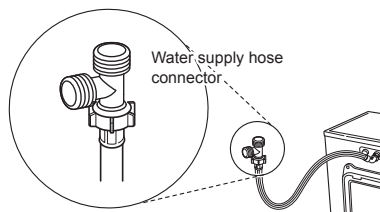

- 2 Connect the water supply hose of pedestal washing machine to the water supply hose connector, pedestal washing machine to be installed.

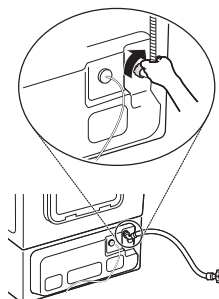

- 3** Connect the additionally provided water supply hose of the front-loading washing machine to the water supply hose connector and water tap.

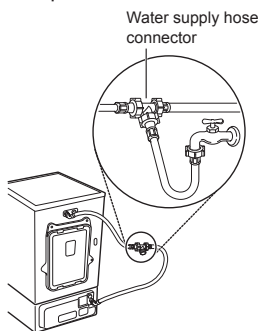

NOTE

- Make sure the water supply hose is not kinked or pinched.

Installing the Drain Hose

- The drain hose should not be placed higher than 100 cm above the floor. Water in the appliance may not drain or may drain slowly.

- 1** Insert the band clamp onto the drain hose elbow.

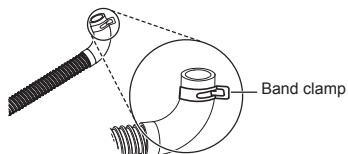

- 2** With the hose leading up from the elbow, insert the elbow onto the drain outlet on the back of the pedestal washing machine.

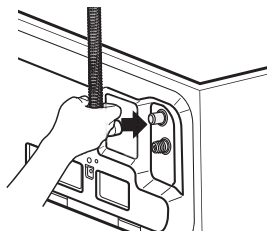

- 3** Adjust the band clamp with pliers to keep the hose securely in place and prevent leaking.

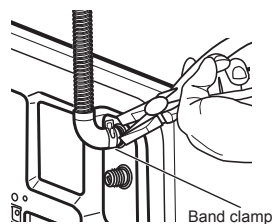

Using the Drain Hose Connector

- 1 Connect the drain hose of the front-loading washing machine and the pedestal washing machine to the drain connector.
- 2 Insert the included band clamps on to the ends of the two drain hoses.
- 3 Push the drain hoses firmly onto the drain connector.

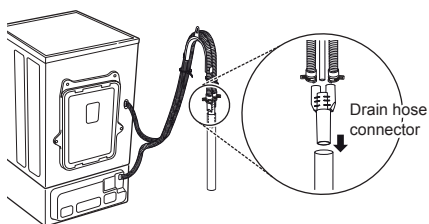

⚠ CAUTION

- Adjust the band clamps to prevent the hoses from coming loose or leaking. Failure to do so could result in flooding. Use of the drain connector helps avoid siphoning, odors, or improper draining.
- Make sure the drain hose is not kinked or pinched. This is a potential cause of drainage problems or noise.

NOTE

- Depending on the installation environment, you may have to purchase a separate drain hose connector.

Leveling the Appliance

If the floor is uneven, turn the adjustable feet as required (Do not insert pieces of wood etc. under the feet). Make sure that all four feet are stable and resting on the floor and then check that the appliance is perfectly level (Use a spirit level).

- Once the appliance is level, tighten the lock nuts up towards the base of the appliance. All lock nuts must be tightened.

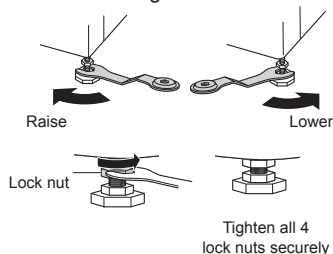

Diagonal Check

- When pushing down the edges of the top plate diagonally, the appliance should not move up and down at all (check both directions). If the appliance rocks when pushing the machine top plate diagonally, adjust the feet again.

⚠ WARNING

- When stacking the front-loading washing machine on the pedestal washing machine, use the leveling feet on the pedestal washing machine to level both. The front-loading washing machine's leveling feet should be minimized and the locknuts turned counterclockwise to secure them.

NOTE

- Timber or suspended type flooring may contribute to excessive vibration and unbalance.
- If the washing machine is installed on a raised platform, it must be securely fastened in order to eliminate the risk of falling off.

Using Anti-Slip Sheets (Optional)

If you install the appliance on a slippery surface, it may move because of excessive vibration. Incorrect leveling may cause malfunction through noise and vibration. If this occurs, install the anti-slip sheets under the leveling feet and adjust the level.

- 1 Clean the floor to attach the anti-slip sheets.
 - Use a dry rag to remove and clean foreign objects and moisture. If moisture remains, the anti-slip sheets may slip.
- 2 Adjust the level after placing the appliance in the installation area.
- 3 Place the adhesive side of the anti-slip sheets on the floor.
 - It is most effective to install the anti-slip sheets under the front feet. If it is difficult to place the pads under the front feet, place them under the back feet.

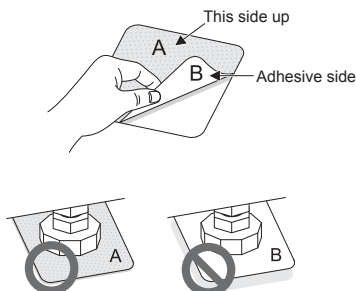

- 4 Ensure the appliance is level.
 - Push or rock the top edges of the appliance gently to make sure that the appliance does not rock. If the appliance rocks, level the appliance again.

NOTE

- You can obtain anti-slip sheets from the LG Service Centre.

Using the Appliance

1 Sort laundry and load items.

- Sort laundry by fabric type, soil level, colour and load size as needed. Open the door and load items into the washing machine.

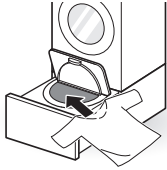

2 Add cleaning products.

- Add the proper amount of detergent with the detergent measuring cup to the washing drum evenly.

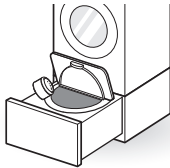

3 Closing the door and drawer.

4 Turn on the washing machine.

- Press the **Power** button to turn on the washing machine.

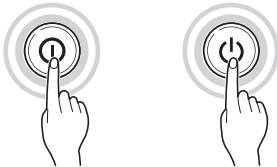

5 Choose the desired washing cycle.

- Press the cycle button repeatedly until the desired cycle is selected.



6 Begin cycle.

- Press the **Start/Pause** button to begin the cycle. The washing machine will agitate briefly without water to measure the weight of the load. If the **Start/Pause** button is not pressed within 15 minutes, the washing machine will shut off and all settings will be lost.



7 Add softener.

- When the machine chimes for about 20 seconds, add the softener and press **Start/Pause** to restart the cycle.

8 End of cycle.

- When the cycle is finished, a melody will sound. Immediately remove your clothing from the washing machine to remove wrinkling and odors.
- After washing is complete, wipe off the washing machine door, gasket and inside the washing drum with a dry towel for clean washing.

Sorting Laundry

1 Look for a care label on your clothes.

- This will tell you about the fabric content of your garment and how it should be washed.
- Symbols on the care labels.



Wash temperature



Normal machine wash



Permanent press



Delicate



Hand wash



Do not wash

2 Sorting laundry.

- To get the best results, sort clothes into loads that can be washed with the same wash cycle.
- Different fabrics need to be washed at varying temperatures and spin speeds.
- Wash two or more towels or knits together. If washed separately, laundry which absorbs a lot of water may not be washed well or abnormal spin-drying may occur due to leaning.
- Always sort dark colours from pale colours and whites. Wash separately as dye and lint transfer can occur causing discolouration of white and pale garments. If possible, do not wash heavily soiled items with lightly soiled ones.

- Soil (Heavy, Normal, Light) :
Separate clothes according to amount of soil.
- Colour (White, Lights, Dark):
Separate white fabrics from coloured fabrics.
- Lint (Lint producers, Collectors):
Wash lint producers and lint collectors separately.

3 Caring before loading.

- Do not wash 'memory wire' on female inner wear (such as a brassiere) as it may damage other clothes or the washing machine and create noise.
- Check all pockets to make sure that they are empty. Items such as nails, hair clips, matches, pens, coins and keys can damage both your washing machine and your clothes.

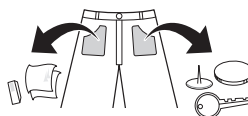

- Close zippers, hooks and strings to make sure that these items don't snag on other clothes.
- Pre-treat dirt and stains by brushing a small amount of detergent dissolved water onto stains to help lift dirt.
- If an item of clothing has a long lace attached to it, arrange the lace so it cannot be tangled or put it into a washing net.
- Remove the insides of cushions, pillows, or sitting mats and only wash the cover. The insides may protrude, damaging other laundry. Plastic parts may generate abnormal vibrations.

⚠ CAUTION

- Divide laundry in large volume for washing so that the laundry can be submerged under water completely. If laundry expands during washing, it may cause damage to the laundry and parts during washing or spin.

Closing the Door and Drawer

- 1 Push the washing machine door until it clicks.

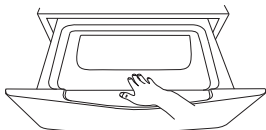



- 2 Push the drawer completely closed.

CAUTION

- Do not let your hands get stuck between the door and the washing machine, as this can cause injury.
- Forcing the drawer or the door to open can cause part damages and safety problems.
- Closing the drawer before having closed the door completely may scratch the door glass.
- Ensure the drawer is pulled out completely to prevent the door from contacting the front load washing machine.

NOTE

- Door lock may fail if there is too much laundry in the machine or if the door is not completely closed.
- If the product is operating or the drawer lock  indicator is displayed, the door cannot open. To open the door, press the **Start/Pause** button to stop the product, and when drawer lock  indicator disappears, open the door. Do not force the drawer and door open.
- If **dE1**, **dE2**, **dD** or a warning sign appears on the display, close the drawer and the door completely. After doing so, press the **Start/Pause** button.
- If the drawer cannot be opened completely, pull the drawer forward with a little force using both hands.
- If power failure occurs during product operation, the door cannot be opened. Provide the power again or contact the LG service centre.
- If the door cannot open due to high temperature, carry out rinsing with cold water using the Rinse+Spin programme or wait a while before opening the door.

Adding Cleaning Products

Detergent Dosage

- Detergent should be used according to the instruction of the detergent manufacturer and selected according to type, colour, soiling of the fabric and washing temperature.
- If too much detergent is used, too many suds can occur and this will result in poor washing results or cause heavy load to the motor.
- If you wish to use liquid detergent follow the guidelines provided by the detergent manufacturer.
- If too many suds occur, reduce the detergent amount.
- Detergent usage may need to be adjusted for water temperature, water hardness, size and soil level of the load. For best results, avoid oversudsing.
- Refer to the label of the clothes, before choosing the detergent and water temperature.
- When using the washing machine, use designated detergent for each type of clothing only:
 - General powdered detergents for all types of fabric
 - Powdered detergents for delicate fabric
 - Liquid detergents for all types of fabric or designated detergents only for wool
- For better washing performance and whitening, use detergent with the general powdered bleach.

Adding Detergent

Measure the detergent with the detergent dispenser and pour it into the tub.

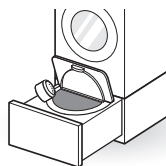

- Use the provided detergent measuring cup to add only one cup of detergent.
- Reduce the amount of detergent for lightly soiled laundry. If you use too much detergent, excessive bubbles will remain after rinsing.

Adding Softeners

Adding Fabric Softener

CASE 1. When the machine chimes:

- 1 Press **Start/Pause** to pause the cycle.
 - It can be paused by pressing the **Start/Pause** button of the pedestal washing machine or by using the remote control.
- 2 Slide open the drawer, open the door, and add the liquid fabric softener.
- 3 Close the door, slide the drawer closed, and press **Start/Pause** to restart the cycle.

NOTE

- To disable or enable the fabric softener alert, press and hold the **Extra Rinse** button for three seconds.
- The fabric softener can be added within 30 seconds after the signal sounded.

CASE 2. If you miss the softener add point:

- 1 Press the **Power** button to interrupt the cycle.
- 2 Slide open the drawer, open the door, and add the liquid fabric softener.
- 3 Close the door, Slide the drawer, and select the **Rinse+Spin** programme.
- 4 Press the **Start/Pause** to restart the cycle.

NOTE

- Do not pour fabric softener directly on the clothes.
- The softener can also be diluted with water and added directly into the drum. Do not pour undiluted softener directly onto clothing because it may stain fabrics.

Adding Water Softener

- A water softener, such as anti-limescale (e.g. Calgon) can be used to cut down on the use of detergent in extremely hard water areas. Dispense according to the amount specified on the packaging. First add detergent and then the water softener.
- Use the quantity of detergent required for soft water.

CAUTION

- Do not directly put bleach to the laundry. This may cause partial discoloration and severe damage to the laundry.
- Do not use chlorine bleach or acidic cleaner when washing the laundry, as it can cause damage to clothes such as discoloration and decoloration of laundry.

Control Panel

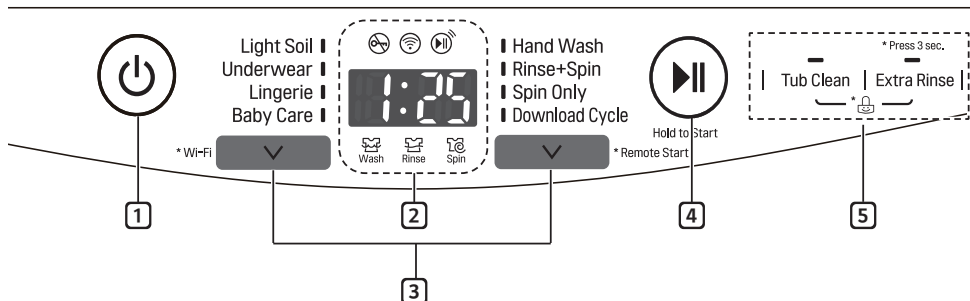

1 Power Button

- Press the **Power** button to turn the washing machine on.

2 Display

- The display shows the cycle status and estimated time remaining.
- : Drawer lock indicator
- : Wi-Fi connect indicator
- : Remote start indicator

3 Programme Button

- Programmes are available according to laundry type.
- In order to use the Download Cycle function, refer to SMART FUNCTIONS.

4 Start/Pause Button

- This **Start/Pause** button is used to start the wash cycle or pause the wash cycle.
- If a temporary stop of the wash cycle is needed, press the **Start/Pause** button.

NOTE

- If you do not press the **Start/Pause** button within 15 minutes of selecting a programme, the washing machine automatically turns off and all cycle settings are lost.

5 Options

- Use these buttons to select the desired options for the selected programme.
- The setting lights above the buttons illuminate to show the current selection.

Programme Table

Washing Programme

Programme	Description	Note	Maximum Load
Light Soil	Use this programme to wash lightly soiled normal items, except delicate fabrics such as wool or silk.	<ul style="list-style-type: none"> To change the setting during washing, change the setting after pressing Start/Pause button. 	2.0 kg
Underwear	Use this programme to wash delicate items such as lingerie or sheer and lacy clothes which could easily be damaged in a normal programme.	<ul style="list-style-type: none"> This programme is not for silk items. 	1.5 kg
Lingerie	Use this programme to wash textiles, lingerie, or fine clothes likely to shrink or deform.	<ul style="list-style-type: none"> To reduce damage to textiles and improve washing performance, use special neutral detergent for wool. To prevent damage to clothes, the drum spins gently to the left and right for washing. 	1.0 kg
Baby Care	Use this programme to wash baby wear hygienically.	<ul style="list-style-type: none"> Select a proper type of neutral detergent. It is more effective to pre-wash laundry stained with food, sweat, urine and feces briefly before washing. This programme is not recommended for wool, silk or any other delicates. 	1.5 kg

Programme	Description	Note	Maximum Load
Hand Wash	Use this programme to wash shrinkable woolen or hand- washable items requiring delicate care. Only wash woolen items that are labeled machine wash or hand wash.	<ul style="list-style-type: none"> • Laundry weight should be less than 1 kg to prevent damage to the fabric. • Use only natural or wool-safe detergent safe for fabrics and load $1/2$ of the normal amount of detergent. • The Hand Wash programme uses a gentle wash action and low speed spin for the ultimate fabric care. 	1.0 kg
Rinse+Spin	Select this programme to rinse and spin a load separately from a regular cycle.	<ul style="list-style-type: none"> • Add fabric softener only. 	1.5 kg

NOTE

- The table below describes information of main washing programmes at full load.

Programme	Time in Minutes	Water in Litre	Energy in Kwh
Light Soil	49	45	0.06
Baby Care	117	80	0.52

Option Programme

Spin Only

Use this option to spin-dry.

Tub Clean

Use this option to keep the drum clean. For information on using Tub Clean, see the Cleaning the Washing Machine section.

Extra Rinse

Use this option to increase the number of rinsing programmes.

- 1 Press the **Power** button.
- 2 Select a washing programme.
- 3 Press the **Extra Rinse** button to set time required.
 - When you press the **Extra Rinse** button, the number of rinsing cycles (1 - 5) to be added will be displayed.
- 4 Press the **Start/Pause** button.

Child Lock

Use this option to disable the controls. This feature can prevent children from changing cycles or operating the appliance.

Locking the Control Panel

- 1 Press and hold the **Tub Clean** and **Extra Rinse** button at the same time for three seconds.
- 2 **EL** will appear on the display. When the Child Lock is set, all buttons are locked except the **Power** button.

NOTE

- Turning off the power or completing all cycles will not reset the child lock function. You must deactivate child lock before you can access any other functions.

Unlocking the Control Panel

Press and hold the **Tub Clean** and **Extra Rinse** button at the same time for three seconds.

- To change the cycle or option, press the **Start/Pause** button to stop operation, and then choose the cycle or option which you wish to change.

Using Smart ThinQ Application

Installing Smart ThinQ

Search for the LG Smart ThinQ application from the Google Play Store or Apple App Store on a smart phone. Follow instructions to download and install the application.

Wi-Fi Function

- For appliances with the  or  logo

Washer Cycle (Remote Start, Download Cycle)

Set or download any preferred cycle and operate by remote control.

Tub Clean Coach

This function shows how many cycles remain before it is time to run the Tub Clean cycle.

Energy Monitoring

Check the energy consumption of the recently used cycles and monthly average.

Smart Diagnosis™

This function provides useful information for diagnosing and solving issues with the appliance based on the pattern of use.

Settings

Various functions are available.

Push Alert

Turn on the Push Alerts to receive appliance status notifications. The notifications are triggered even if the LG Smart ThinQ application is off.

NOTE

- To verify the Wi-Fi connection, check that **Wi-Fi**  icon on the control panel is lit.
- LG Smart ThinQ is not responsible for any network connection problems or any faults, malfunctions, or errors caused by network connection.
- The machine supports 2.4 GHz Wi-Fi networks only.
- If the security protocol of the router is set to **WEP**, you may fail to set up the network. Please change it to other security protocols (**WPA2** is recommended) and register the product again.
- Router SSID, please use only letters, numbers. Other characters may not be supported.
- If the appliance is having trouble connecting to the Wi-Fi network, it may be too far from the router. Purchase a Wi-Fi repeater (range extender) to improve the Wi-Fi signal strength.
- The Wi-Fi connection may not connect or may be interrupted because of the home network environment.
- The network connection may not work properly depending on the internet service provider.
- The surrounding wireless environment can make the wireless network service run slowly.
- The application is subject to change for appliance improvement purposes without notice to users.
- Functions may vary by model.

Using Washer Cycle

Remote Start

Use a smart phone to control your appliance remotely. You can also monitor your cycle operation so you know how much time is left in the cycle.

To Use Remote Start:

- 1 Press the **Power** button.
- 2 Put the laundry in drum.
- 3 Press and hold **Remote Start** button for 3 seconds to enable Remote Start function.
- 4 Start a cycle from the LG Smart ThinQ application on your smart phone.

NOTE

- Once the Remote Start mode is enabled, you can start a cycle from the LG Smart ThinQ smartphone application. If the cycle is not started, the machine will wait to start the cycle until it is turned off remotely from the application or the Remote Start mode is disabled.
- When Remote Start is turned on, the door is automatically locked.

To Disable Remote Start:

When the Remote Start is activated, press and hold **Remote Start** button for 3 seconds.

Download Cycle

Download new and special cycles that are not included in the basic cycles on the appliance.

Appliances that have been successfully registered can download a variety of specialty cycles specific to the appliance.

Only one cycle can be stored on the appliance at a time.

Once cycle download is completed in the appliance, the product keeps the downloaded cycle until a new cycle is downloaded.

Wireless LAN Module Specifications

Model	LCW-004
Frequency Range	2412 to 2472 MHz
Output Power(Max)	IEEE 802.11b:17.82 dBm IEEE 802.11g:17.72 dBm IEEE 802.11n:16.61 dBm

Standby power consumption	0.5 W
Network standby power consumption	3.0 W
The period of time after which the power management function, or a similar function, switches the equipment automatically into standby and/or off mode and/or the condition providing networked standby	20 min.

Declaration of Conformity

CE 0197

Hereby, LG Electronics European Shared Service Center B.V., declares that this Washing machine is compliant with the essential requirements and other relevant provisions of Directive 1999/5/EC. The complete Declaration of Conformity may be requested through the following postal address:

LG Electronics European Shared Service Centre
B.V.
Krijgsman 1
1186 DM Amstelveen
The Netherlands

or can be requested at our dedicated DoC website:

<http://www.lg.com/global/support/cedoc/cedoc#>

This device is a 2.4 GHz wideband transmission system, intended for use in all EU member states and EFTA countries.

Open Source Software Notice



Information

To obtain the source code under GPL, LGPL, MPL, and other open source licenses, that is contained in this product, please visit <http://opensource.lge.com>.

In addition to the source code, all referred license terms, warranty disclaimers and copyright notices are available for download.

LG Electronics will also provide open source code to you on CD-ROM for a charge covering the cost of performing such distribution (such as the cost of media, shipping, and handling) upon email request to opensource@lge.com. This offer is valid for three (3) years from the date on which you purchased the product.

Smart Diagnosis™ Using a Smart Phone

- For appliances with the  or  logo

Use this function if you need an accurate diagnosis by an LG Electronics customer information centre when the appliance malfunctions or fails.

Smart Diagnosis™ can not be activated unless the appliance is connected to power. If the appliance is unable to turn on, then troubleshooting must be done without using Smart Diagnosis™.

Using Smart Diagnosis™

Smart Diagnosis™ Through the Customer Information Centre

Use this function if you need an accurate diagnosis by an LG Electronics customer information center when the appliance malfunctions or fails. Use this function only to contact the service representative, not during normal operation.

- 1 Press the **Power** button to turn on the appliance. Do not press any other buttons or turn the programme selector knob.
- 2 When instructed to do so by the call centre, place the mouthpiece of your phone close to the Smart Diagnosis™ icon.

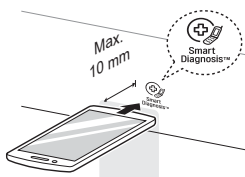

- 3 Press and hold the **Tub Clean** button for three seconds, while holding the phone mouthpiece to the icon or **Power** button.
- 4 Keep the phone in place until the tone transmission has finished. Time remaining for data transfer is displayed.
 - For best results, do not move the phone while the tones are being transmitted.
 - If the call centre agent is not able to get an accurate recording of the data, you may be asked to try again.

- 5 Once the countdown is over and the tones have stopped, resume your conversation with the call centre agent, who will then be able to assist you using the information transmitted for analysis.

NOTE

- The Smart Diagnosis™ function depends on the local call quality.
- The communication performance will improve and you can receive better service if you use the home phone.
- If the Smart Diagnosis™ data transfer is poor due to poor call quality, you may not receive the best Smart Diagnosis™ service.

⚠ WARNING

- Unplug the washing machine before cleaning to avoid the risk of electric shock. Failure to follow this warning may result in serious injury, fire, electric shock, or death.
- Never use harsh chemicals, abrasive cleaners, or solvents to clean the washing machine. They may damage the finish.

Cleaning the Washing Machine

Care After Wash

- After the cycle is finished, wipe the door and the inside of the door seal to remove any moisture.
- Leave the door open to dry the drum interior.
- Wipe the body of the washing machine with a dry cloth to remove any moisture.

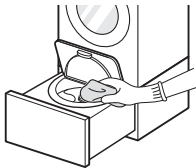

Cleaning the Exterior

Proper care of your washing machine can extend its life.

Door:

- Wash with a damp cloth on the outside and inside and then dry with a soft cloth.

Exterior:

- Immediately wipe off any spills.
- Wipe with a damp cloth.
- Do not press the surface or the display with sharp objects.

Cleaning the Interior

- Use a towel or soft cloth to wipe around the washing machine door opening and door glass.
- Always remove items from the washing machine as soon as the cycle is complete. Leaving damp items in the washing machine can cause wrinkling, colour transfer, and odour.
- Run the Tub Clean programme once a month (or more often if needed) to remove detergent buildup and other residue

Cleaning the Drum

Use the Tub Clean option to keep the drum clean.

- 1 Press the **Power** button.
- 2 Dilute 200 ml liquid chlorine bleach in 1 ℓ of water and pour the mixture in the drum.
- 3 Press the **Tub Clean** button to set time required.
- 4 Press the **Start/Pause** button.

CAUTION

- If there is a child, be careful not to leave the door open for too long.

Cleaning the Water Inlet Filter

- Turn off the stopcock if the washing machine is to be left for any length of time (e.g. holiday), especially if there is no floor drain (gully) in the immediate vicinity.
 -  icon may blink on the display when the water pressure is weak or an inlet filter is clogged with dirt. Clean the inlet filter.
 - The inlet filter screens could be plugged by hard water scale, sediment in the water supply, or other debris.
- 1 Turn off the water tap and unscrew the water inlet hose.

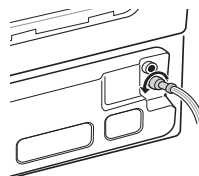

- 2 Clean the filter using a hard bristle brush.

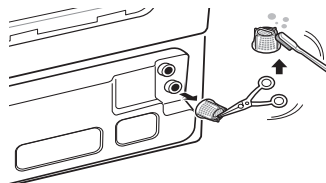

Caution on Freezing During Winter

- When frozen, the product does not operate normally. Make sure to install the product where it will not freeze during winter.
- In case the product must be installed outside on a porch or in other outdoor conditions, make sure to check the following.

How to Keep the Product from Freezing

- After closing the tap, disconnect the cold supply hose from the tap, and remove water while keeping the hose facing downwards.

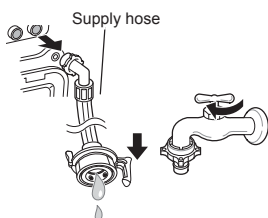

How to Handle Freezing

Step 1. When the Door is Frozen

- Thaw out the door using a hot water cloth.

Step 2. When the Water Supply Hose is Frozen

- **FE** icon may blink on the display when water supply problems occur, take the following measures.
 - Take out water supply hose and connect to the tap and check that water comes from the tap and supply hose.
 - Turn off the tap, and thaw out the tap and both connection areas of supply hose of the product using a hot water cloth.
 - Take out supply hose and immerse in warm water below 50–60 °C.

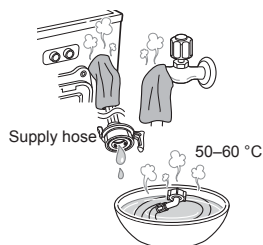

Step 3. When the Drain Pump is Frozen

- **FF**, **DE** icon may blink on the display when drain pump problems occur, take the following measures.

- 1** Pour 15 l warm water below 50–60 °C in the drum until washing machine wing nuts are immersed and wait for an hour.
- 2** Press the **Power** button and then run the Baby Care programme for an hour.
 - When **TE** icon appears on the display, repeat steps 1 to 2.
- 3** Turn off the power when the Baby Care programme is finished. If the drawer is open, select the **Rinse+Spin** programme and press the **Start/Pause** button to check that the washing machine works.
- 4** When **DE** icon appears on the display, thaw out the drain hose inner part with the hot water.

The appliance is equipped with an automatic error-monitoring system to detect and diagnose problems at an early stage. If the appliance does not function properly or does not function at all, check the following before you call for service:

Diagnosing Problems





Symptoms	Reason	Solution
The drawer does not open.	Power failure, or the power cord was pulled out during washing.	<ul style="list-style-type: none"> After providing the power again, press the Power button with the control panel of the front-loading washing machine or the remote control.
Draining starts when pressing Start/ Pause button.	The Start/Pause button is pressed during washing.	<ul style="list-style-type: none"> When pressing the Start/Pause button during washing, the drawer is unlocked after drainage for safety.
Rattling and clanking noise	Foreign objects, such as keys, coins, or safety pins may be in drum.	<ul style="list-style-type: none"> Stop washing machine, check drum for foreign objects. If noise continues after washing machine is restarted, call for service.
Thumping sound	Heavy wash loads may produce a thumping sound.	<ul style="list-style-type: none"> If sound continues, wash load is probably out of balance. Stop and redistribute wash load.
	Wash load may be out of balance.	<ul style="list-style-type: none"> Pause the cycle and redistribute the load after the door unlocks.
Vibrating noise	Packaging materials were not removed.	<ul style="list-style-type: none"> Remove packing materials.
	Wash load may be unevenly distributed in the drum.	<ul style="list-style-type: none"> Pause the cycle and redistribute the load after the door unlocks.
	Not all leveling feet are resting firmly and evenly on the floor.	<ul style="list-style-type: none"> See Leveling the Appliance in the Installation section.
	Floor not rigid enough.	<ul style="list-style-type: none"> Make sure that the floor is solid and does not flex.
Water leaks every load	Hoses not installed correctly.	<ul style="list-style-type: none"> Check all fill and drain hose connections to ensure that they are tight and secure.
Excessive sudsing	Too much detergent or incorrect detergent.	<ul style="list-style-type: none"> Reduce the amount of detergent for lightly soiled laundry. If you use too much detergent, excessive bubbles will remain after rinsing.









Symptoms	Reason	Solution
Staining	Clothes were not properly sorted.	<ul style="list-style-type: none"> • Always wash dark colors separately from light colors and whites to prevent discoloration. • Never wash heavily soiled items washed with lightly soiled items.
Water leaking	Supply hose connection is loose at the tap, washing machine, or drain hose connector.	<ul style="list-style-type: none"> • Check hoses and drain hose connectors for leaks, cracks and splits. • Tighten hose connections.
	House drain pipes are clogged.	<ul style="list-style-type: none"> • The washing machine pumps out water very rapidly. Check for water backing up out of the drain pipe during drain. If water is seen coming out of the drain, check for proper drain hose installation and check for restrictions in the drain. Contact a plumber to repair drain pipe.
	Drain hose has come out of drain connector or is not inserted far enough.	<ul style="list-style-type: none"> • Tie drain hose to supply hose or standpipe to prevent it from coming out during drain. For smaller drain pipes, insert the drain hose into the pipe as far as the drain hose flange. For larger drain pipes, insert the drain hose into the pipe 2-5 cm past the flange.
	Load is too large for the drum.	<ul style="list-style-type: none"> • Reduce the load or use the front-loading washing machine. • Stop the washing machine and check the load. Make sure the load fits loosely in the drum and the door closes easily.
	Oversudsing of detergent.	<ul style="list-style-type: none"> • Oversudsing may create leaks, and may be caused by the type and amount of detergent used. Always reduce the amount of detergent if the load is small or lightly soiled, or if your water is very soft. Never use more than the maximum amount shown in the dispenser provided.
Wrinkling	Washing machine not unloaded promptly.	<ul style="list-style-type: none"> • Always remove items from the washing machine as soon as the cycle is complete.
	Washing machine overloaded.	<ul style="list-style-type: none"> • The washing machine can be fully loaded, but the drum should not be tightly packed with items. The door of the washing machine should close easily.

Symptoms	Reason	Solution
Washing machine will not operate.	Control panel has powered off due to inactivity.	<ul style="list-style-type: none"> This is normal. Press the Power button to turn the washing machine on.
	Washing machine is unplugged.	<ul style="list-style-type: none"> Make sure cord is plugged securely into a working outlet.
	Water supply is turned off.	<ul style="list-style-type: none"> Turn the cold water tap fully on.
	Controls are not set properly.	<ul style="list-style-type: none"> Make sure the cycle was set correctly, close the door and press the Start/Pause button.
	Door or drawer is open.	<ul style="list-style-type: none"> Close the door and drawer make sure that nothing is caught under the door preventing it from closing completely.
	Circuit breaker/fuse is tripped/blown.	<ul style="list-style-type: none"> Check house circuit breakers/fuses. Replace fuses or reset breaker. The washing machine should be on a dedicated branch circuit. The washing machine will resume the cycle where it stopped once power is restored.
	Control needs to be reset.	<ul style="list-style-type: none"> Press the Power button, then re-select the desired programme and press the Start/Pause button.
	Start/Pause was not pressed after a cycle was set.	<ul style="list-style-type: none"> Press the Start/Pause button with control panel of the front-loading washing machine or remote control after closing the drawer. When using the control panel of the pedestal washing machine, press the Start/Pause button and close the drawer within 5 seconds.
	Extremely low water pressure.	<ul style="list-style-type: none"> Check another tap in the house to make sure that household water pressure is adequate.
Washing machine is too cold.	<ul style="list-style-type: none"> If the washing machine has been exposed to temperatures below freezing for an extended period of time, allow it to warm up before pressing the Power button. 	

Symptoms	Reason	Solution
Washing machine is not filling properly.	Filter clogged.	<ul style="list-style-type: none"> • Make sure the inlet filters on the fill valves are not clogged. Refer to the filter cleaning instructions.
	Supply hoses may be kinked.	<ul style="list-style-type: none"> • Check that supply hoses are not kinked or clogged.
	Insufficient water supply.	<ul style="list-style-type: none"> • Make sure that the cold water tap is turned on all the way.
	door and drawer are open.	<ul style="list-style-type: none"> • The washing machine will not operate if the door is open. Close the door and make sure that nothing is caught under the door preventing it from closing completely.
	Water level is too low.	<ul style="list-style-type: none"> • The fill level is optimized for the wash motion to achieve the best wash performance.
Water in the washing machine does not drain or drains slowly.	Drain hose is kinked, pinched, or clogged.	<ul style="list-style-type: none"> • Make sure the drain hose is free of clogs, kinks, etc., and is not pinched behind or under the washing machine.
Poor stain removal	Heavily soiled load.	<ul style="list-style-type: none"> • Use the front-loading washing machine.
	Previously set stains.	<ul style="list-style-type: none"> • Articles that have previously been washed may have stains that have been set. These stains may be difficult to remove and may require hand washing or pre-treating to aid in stain removal.
Wash cycle time is longer than usual.	The washing machine automatically adjusts the wash time for the amount of laundry, water pressure and other operating conditions.	<ul style="list-style-type: none"> • This is normal. The washing machine adjusts cycle time automatically to provide optimal results for the selected programme. The time remaining shown in the display is only an estimate. Actual time may vary.
Musty or mildewy odor in washing machine	Incorrect or too much detergent has been used.	<ul style="list-style-type: none"> • This machine requires very little detergent. Use the provided detergent measuring cup.
	Inside of drum was not cleaned properly.	<ul style="list-style-type: none"> • Run the Tub Clean programme regularly.
Washing machine chimes repeatedly before final rinse.	This is not an error.	<ul style="list-style-type: none"> • This is an alert to allow the addition of liquid fabric softener before the final rinse.

Error Messages

Symptoms	Reason	Solution
	Drawer is not closed properly.	<ul style="list-style-type: none"> • Close the drawer and press Start/Pause button to start the cycle. • If the drawer is closed and the drawer lock error message is displayed, call for service.
	Door is not closed properly.	<ul style="list-style-type: none"> • Open the drawer and make sure the latch area is free of clothing or other obstructions. • Close the door, shut the drawer, and press Start/Pause to start the cycle. • If the door is closed and the door error message is displayed, call for service.
	The cold water tap is not fully open.	<ul style="list-style-type: none"> • Make sure that the cold water tap is fully open.
	Water line hoses are kinked, pinched, or crushed.	<ul style="list-style-type: none"> • Make sure that the hoses are not kinked or pinched. Be careful when moving the washing machine during cleaning and maintenance.
	Water inlet filters are clogged.	<ul style="list-style-type: none"> • Clean the inlet filters.
	Water supply pressure to tap or house is too low.	<ul style="list-style-type: none"> • Check another tap in the house to make sure that household water pressure is adequate and flow is not restricted. Disconnect the supply hose from the washing machine and run a few liters of water through the hose to flush the water supply lines. If flow is too low, contact a plumber to have the water lines repaired.
	Water supply connected with leak-limiting hoses.	<ul style="list-style-type: none"> • Hoses designed to limit leaks can trip falsely and prevent the washing machine from filling. The use of leak limiting hoses is not recommended.
	Drain hose is kinked, pinched, or clogged.	<ul style="list-style-type: none"> • Make sure the drain hose is free of clogs, kinks, etc., and is not pinched behind or under the washing machine.

Symptoms	Reason	Solution
	UE rebalancing operation is not successful.	<ul style="list-style-type: none"> The automatic attempt to rebalance the load was not successful. The cycle has been paused to allow the load to be manually adjusted.
	The load is too small.	<ul style="list-style-type: none"> Add more items to allow the washing machine to balance the loads.
	Heavy articles are mixed with lighter items.	<ul style="list-style-type: none"> Wash articles of somewhat similar weight.
	The load is out of balance.	<ul style="list-style-type: none"> Manually redistribute the load if articles have become tangled.
	Control error.	<ul style="list-style-type: none"> Unplug the power plug and call for service.
	Water level is too high due to a faulty water valve.	<ul style="list-style-type: none"> Close the cold water tap, unplug the washing machine, and call for service.
	The water level sensor is not working correctly.	<ul style="list-style-type: none"> Close the cold water tap, unplug the washing machine, and call for service.
	A motor error has occurred.	<ul style="list-style-type: none"> Allow the washing machine to stand for 30 minutes and then restart the cycle. If the LE error code persists, call for service.
	It is time to run the Tub Clean programme.	<ul style="list-style-type: none"> Run the Tub Clean programme.
	Pedestal washing machine is being operated without a full-size washing machine.	<ul style="list-style-type: none"> Pedestal washing machine will not operate as a standalone unit. It must be stacked under an LG front-loading washing machine.
	Stacking switch is not working properly.	<ul style="list-style-type: none"> The stacking switch will not operate properly if the unit is stacked under a non-LG appliance, or an LG appliance manufactured before 2017.
	Drain hose, supply hose or drain pump is frozen.	<ul style="list-style-type: none"> Thaw out the supply hose using a hot water cloth. Pour warm water in the drum.
	CL is not an error. This prevents children from changing cycles or operating the appliance.	<ul style="list-style-type: none"> To deactivate, turn off the Child Lock in control panel of the front-loading washing machine or press the Tub Clean and Extra Rinse button for three seconds in control panel of the pedestal washing machine.

Memo

Memo

Memo

Memo

Memo

