

Dell OptiPlex 7450 All-In-One

Owner's Manual



Notes, cautions, and warnings

 **NOTE:** A NOTE indicates important information that helps you make better use of your product.

 **CAUTION:** A CAUTION indicates either potential damage to hardware or loss of data and tells you how to avoid the problem.

 **WARNING:** A WARNING indicates a potential for property damage, personal injury, or death.

© 2017 Dell Inc. or its subsidiaries. All rights reserved. Dell, EMC, and other trademarks are trademarks of Dell Inc. or its subsidiaries. Other trademarks may be trademarks of their respective owners.

1 Working on your computer	7
Before working inside your computer.....	7
Safety instructions.....	7
Recommended tools.....	8
Turning off your computer.....	8
After working inside your computer.....	8
Important Information.....	8
2 Removing and installing components	9
Stand.....	9
Removing the stand.....	9
Installing the stand.....	9
Cable cover.....	10
Removing the cable cover.....	10
Installing the cable cover.....	10
Back cover.....	10
Removing the back cover.....	10
Installing the back cover.....	12
Power and On-Screen Display (OSD) buttons board.....	12
Removing the power and On-Screen Display (OSD) buttons board.....	12
Installing the power and OSD buttons board.....	13
Speaker cover.....	13
Removing the speaker cover.....	13
Installing the speaker cover.....	14
Hard drive.....	14
Removing the hard drive assembly.....	14
Installing the hard drive assembly.....	15
Optical drive.....	16
Removing the optical drive assembly.....	16
Installing the optical drive assembly.....	17
System board shield.....	17
Removing the system board shield.....	17
Installing the system board shield.....	18
Memory module.....	18
Removing the memory module.....	18
Installing the memory module.....	18
Solid State Drive (SSD).....	19
Removing the SSD card.....	19
Installing the SSD card.....	19
Coin cell battery.....	20
Removing the coin cell battery.....	20
Installing the coin cell battery.....	20
WLAN card.....	21

Removing the WLAN card.....	21
Installing the WLAN card.....	21
Heat sink.....	22
Removing the heat sink	22
Installing the heat sink.....	22
Speaker.....	23
Removing the speaker module.....	23
Installing the speaker module.....	24
Power supply unit.....	24
Removing the Power Supply Unit (PSU).....	24
Installing the Power Supply Unit (PSU).....	26
VESA mount bracket.....	26
Removing the VESA mount bracket.....	26
Installing the VESA mount bracket.....	27
Converter board.....	27
Removing the converter board.....	28
Installing the converter board.....	28
System fan.....	29
Removing the system fan.....	29
Installing the system fan.....	30
Intrusion switch.....	30
Removing the intrusion switch.....	30
Installing the intrusion switch.....	31
Processor.....	32
Removing the processor.....	32
Installing the processor.....	32
System board.....	33
Removing the system board.....	33
Installing the system board.....	35
System board layout.....	36
Chassis frame.....	36
Removing the chassis frame.....	37
Installing the chassis frame.....	37
Display panel.....	38
Removing the display panel.....	38
Installing the display panel.....	39

3 Technology and components..... 40

Processors.....	40
Skylake — 6th Generation Intel Core processors.....	40
Kaby Lake — 7th Generation Intel Core processors.....	41
Identifying processors in Windows 10.....	41
Identifying processors in Windows 7.....	42
Chipsets.....	42
Identifying the chipset in Device Manager on Windows 10.....	42
Storage options.....	42
Hard drives.....	42



Solid State Drives (SSD).....	42
Identifying the hard drive in Windows 10.....	43
Entering BIOS setup.....	43
Memory configurations.....	43
Verifying system memory in Windows 10 and Windows 7	43
DDR4.....	44
Key Specifications.....	44
DDR4 Details.....	45
4 System setup.....	46
Boot Sequence.....	46
Navigation keys.....	46
System setup options.....	47
System setup options.....	47
General screen options.....	47
System configuration screen options.....	48
Security screen options.....	49
Secure boot screen options.....	51
Intel Software Guard Extensions options.....	52
Performance screen options.....	52
Power management screen options.....	53
POST behavior screen options.....	54
Virtualization support screen options.....	54
Maintenance screen options.....	55
System Log screen options.....	55
Updating the BIOS	55
System and setup password.....	56
Assigning a system password and setup password.....	56
Deleting or changing an existing system and/or setup password.....	57
5 Troubleshooting your computer.....	58
Enhanced Pre-Boot System Assessment (ePSA) diagnostics.....	58
Running the ePSA diagnostics.....	58
Power supply—built in self test (BIST).....	58
LCD built in self test (BIST).....	59
Invoking BIST with user modes.....	61
OSD toggle.....	61
ePSA.....	61
6 Technical specifications.....	63
System specifications.....	63
Memory specifications.....	63
Video specifications.....	64
Audio specifications.....	64
Communication specifications.....	64
Cards specifications.....	65
Display specifications.....	65



Drives specifications.....	65
Port and connector specifications.....	65
Power specifications.....	65
Camera (optional) specifications.....	66
Stand specifications.....	66
Physical specifications.....	66
Environmental specifications.....	66
7 Contacting Dell.....	68



Working on your computer

Before working inside your computer

To avoid damaging your computer, perform the following steps before you begin working inside the computer.

- 1 Ensure that you follow the [Safety instructions](#).
- 2 Ensure that your work surface is flat and clean to prevent the computer cover from being scratched.
- 3 Turn off your computer.

CAUTION: To disconnect a network cable, first unplug the cable from your computer and then unplug the cable from the network device.

- 4 Disconnect all network cables from the computer.
- 5 Disconnect your computer and all attached devices from their electrical outlets.
- 6 Press and hold the power button while the computer is unplugged to ground the system board.
- 7 Remove the cover.

CAUTION: Before touching anything inside your computer, ground yourself by touching an unpainted metal surface, such as the metal at the back of the computer. While you work, periodically touch an unpainted metal surface to dissipate static electricity, which could harm internal components.

Safety instructions

Use the following safety guidelines to protect your computer from potential damage and to ensure your personal safety. Unless otherwise noted, each procedure included in this document assumes that the following conditions exist:

- You have read the safety information that shipped with your computer.
- A component can be replaced or, if purchased separately, installed by performing the removal procedure in reverse order.

WARNING: Disconnect all power sources before opening the computer cover or panels. After you finish working inside the computer, replace all covers, panels, and screws before connecting to the power source.

WARNING: Before working inside your computer, read the safety information that shipped with your computer. For additional safety best practices information, see the Regulatory Compliance Homepage at www.Dell.com/regulatory_compliance

CAUTION: Many repairs may only be done by a certified service technician. You should only perform troubleshooting and simple repairs as authorized in your product documentation, or as directed by the online or telephone service and support team. Damage due to servicing that is not authorized by Dell is not covered by your warranty. Read and follow the safety instructions that came with the product.

CAUTION: To avoid electrostatic discharge, ground yourself by using a wrist grounding strap or by periodically touching an unpainted metal surface, such as a connector on the back of the computer.

CAUTION: Handle components and cards with care. Do not touch the components or contacts on a card. Hold a card by its edges or by its metal mounting bracket. Hold a component such as a processor by its edges, not by its pins.

CAUTION: When you disconnect a cable, pull on its connector or on its pull-tab, not on the cable itself. Some cables have connectors with locking tabs; if you are disconnecting this type of cable, press in on the locking tabs before you disconnect the cable. As you pull connectors apart, keep them evenly aligned to avoid bending any connector pins. Also, before you connect a cable, ensure that both connectors are correctly oriented and aligned.

NOTE: The color of your computer and certain components may appear differently than shown in this document.



Recommended tools

The procedures in this document require the following tools:

- Small flat blade screwdriver
- Phillips # 1 screwdriver
- Small plastic scribe
- Hex screwdriver

Turning off your computer

After working inside your computer

After you complete any replacement procedure, ensure that you connect any external devices, cards, and cables before turning on your computer.

- 1 Replace the cover.

 **CAUTION:** To connect a network cable, first plug the cable into the network device and then plug it into the computer.

- 2 Connect any telephone or network cables to your computer.
- 3 Connect your computer and all attached devices to their electrical outlets.
- 4 Turn on your computer.
- 5 If required, verify that the computer works correctly by running **ePSA diagnostics**.

Important Information

 **NOTE:** Avoid using the touchscreen in dusty, hot, or humid environments.

 **NOTE:** Sudden change in temperature may cause condensation on the inner surface of the glass screen, which will disappear after a short time and does not affect normal usage.

Removing and installing components

This section provides detailed information on how to remove or install the components from your computer.

Stand

Removing the stand

- 1 Follow the procedure in [Before working inside your computer](#).
- 2 Place the computer on a flat surface with the display facing downward.
- 3 To remove the stand:
 - a Press the tab on the cover to release the stand [1].
 - b Lift the stand upward [2].

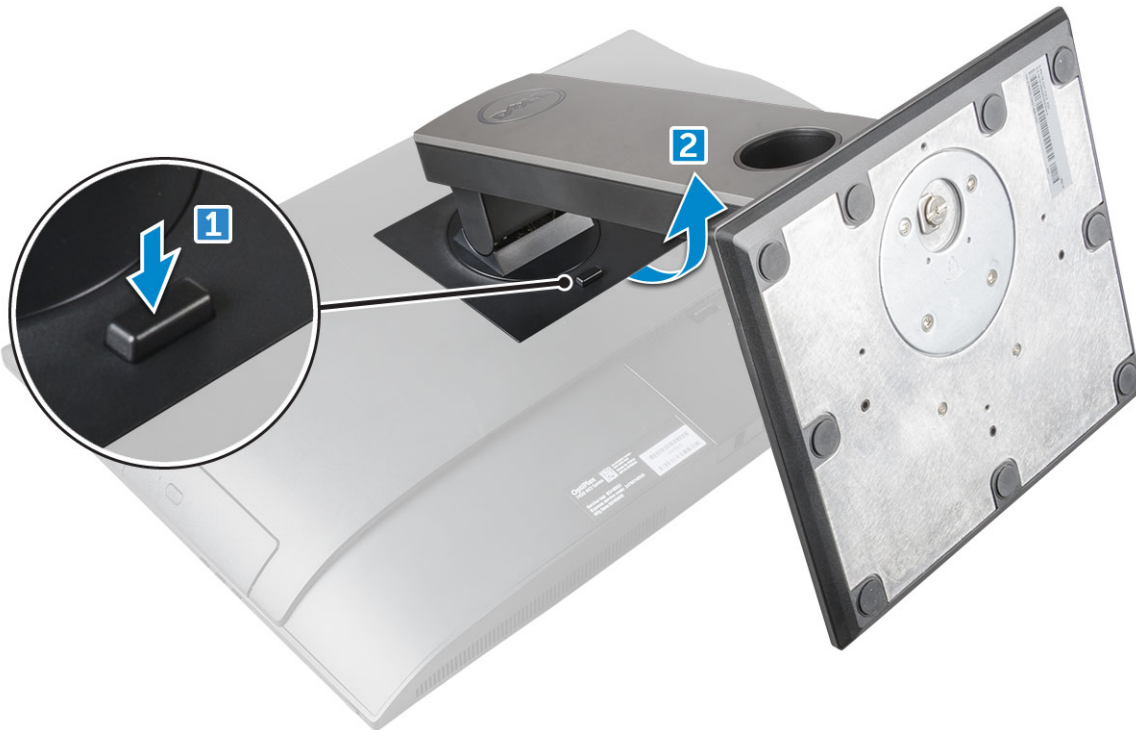

Installing the stand

- 1 Align the stand and slide it on the back of the computer.
- 2 Press the stand down till it snaps in.
- 3 Follow the procedure in [After working inside your computer](#).



Cable cover

Removing the cable cover

- 1 Follow the procedure in [Before working inside your computer](#).
- 2 Remove the [stand](#).
- 3 To remove the cable cover:
 - a Remove the screw that secures the cable cover to the computer [1].
 - b Push the release tabs to release the cable cover [2].
 - c Lift the cable cover away from the computer [3].



Installing the cable cover

- 1 Align the notches on the cable cover to the holes on the computer and press the cable cover until it snaps in.
- 2 Tighten the screw to secure the cable cover to the computer.
- 3 Install the [stand](#).
- 4 Follow the procedure in [After working inside your computer](#).

Back cover

Removing the back cover

- 1 Follow the procedure in [Before working inside your computer](#).
- 2 Remove the:

- a stand
- b cable cover

3 Pry the edges of the back cover from the bottom to release it from the computer.



4 Lift the back cover from the computer.



Installing the back cover

- 1 Align the notches on the back cover to the holes on the computer, and press the back cover until it snaps in.
- 2 Install the:
 - a cable cover
 - b stand
- 3 Follow the procedure in [After working inside your computer](#).

Power and On-Screen Display (OSD) buttons board

Removing the power and On-Screen Display (OSD) buttons board

- 1 Follow the procedure in [Before working inside your computer](#).
- 2 Remove the:
 - a stand
 - b back cover
- 3 To remove the power and OSD buttons board:
 - a Remove the screw to remove the metal plate that secures the power and OSD buttons board to the computer [1].
 - b Peel off the tape from the OSD buttons board [2].
 - c Remove the power and OSD buttons board from the chassis.
 - d Disconnect the cables from the power and OSD buttons board to release the board from the computer [3].

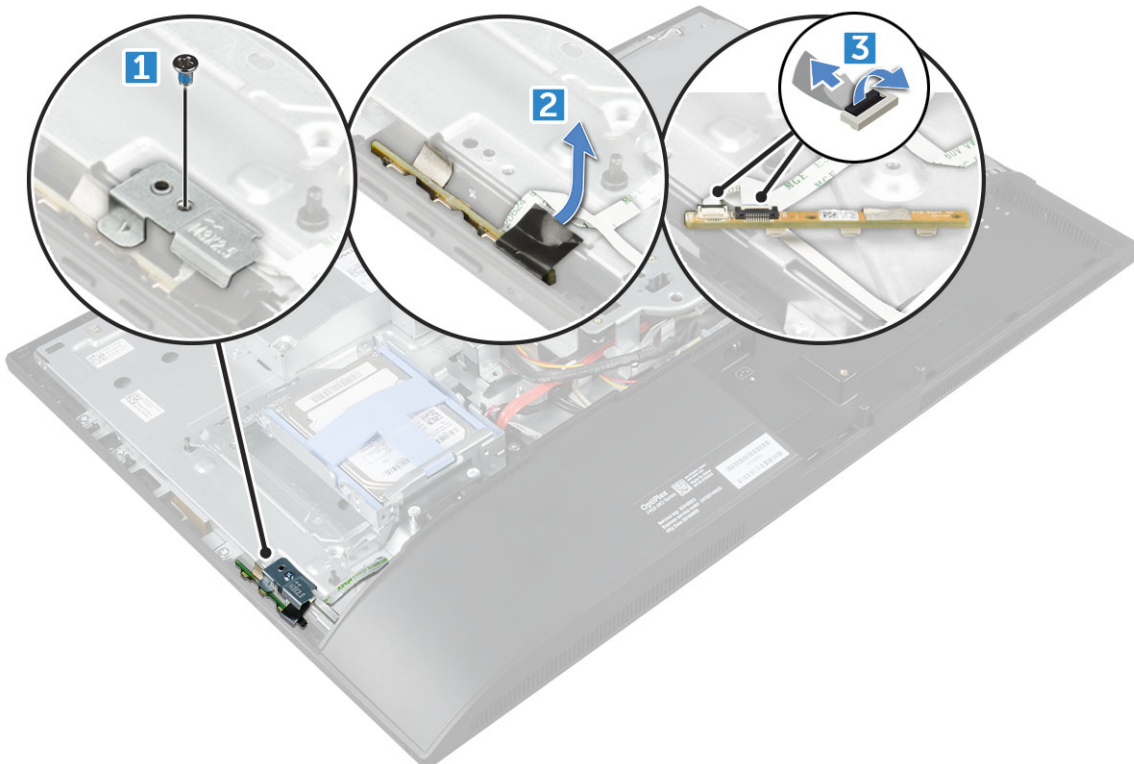

Installing the power and OSD buttons board

- 1 Connect the cable to the power and OSD buttons board.
- 2 Affix the tape on the OSD buttons board.
- 3 Insert the power and OSD buttons board into the slot.
- 4 Align the metal plate on the power and OSD buttons board.
- 5 Tighten the screw to secure the power and OSD buttons board.
- 6 Install the:
 - a back cover
 - b stand
- 7 Follow the procedure in [After working inside your computer](#).

Speaker cover

Removing the speaker cover

- 1 Follow the procedure in [Before working inside your computer](#).
- 2 Remove the:
 - a stand
 - b cable cover
 - c back cover
- 3 To remove the speaker cover:
 - a Remove the screws that secure the speaker cover to the computer [1].
 - b Slide the speaker cover to release it from the computer [2].

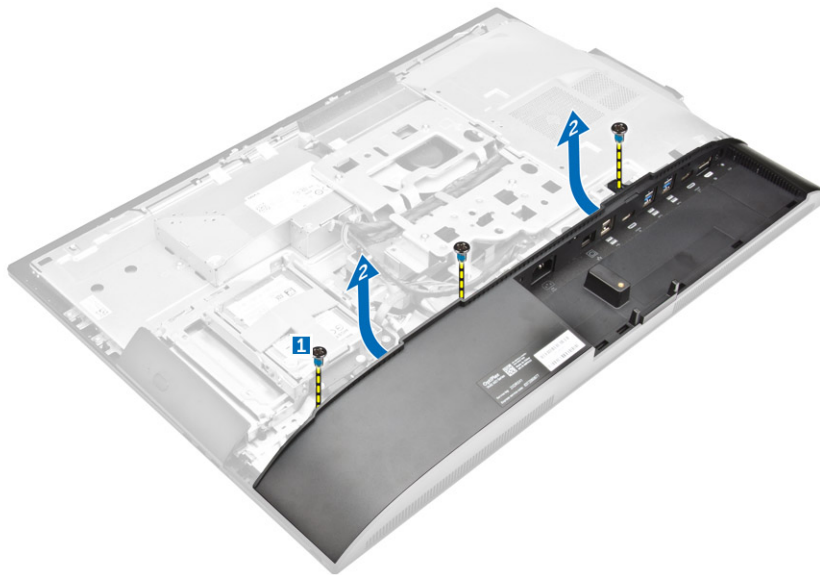

- 4 Slide and remove the speaker cover from the computer.

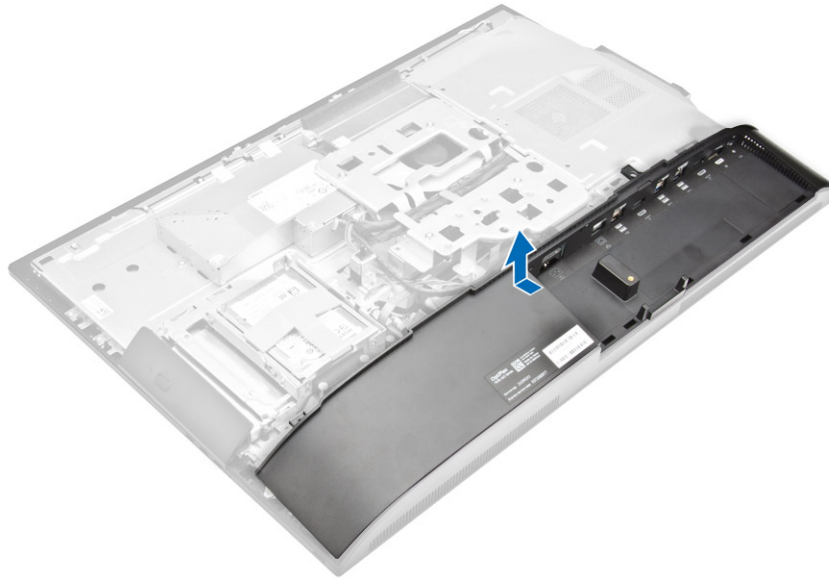

Installing the speaker cover

- 1 Align the speaker cover to its position on the back of the computer.
- 2 Tighten the screws to secure the speaker cover to the computer.
- 3 Install the:
 - a [back cover](#)
 - b [cable cover](#)
 - c [stand](#)
- 4 Follow the procedure in [After Working Inside Your Computer](#).

Hard drive

Removing the hard drive assembly

- 1 Follow the procedure in [Before working inside your computer](#).
- 2 Remove the:
 - a [stand](#)
 - b [back cover](#)
- 3 To remove the hard drive assembly:
 - a Press the tab on the bracket, and slide the hard-drive assembly until the tabs are released from either side of the assembly [1].
 - b Slide the hard-drive assembly upwards to remove it from the computer [2].

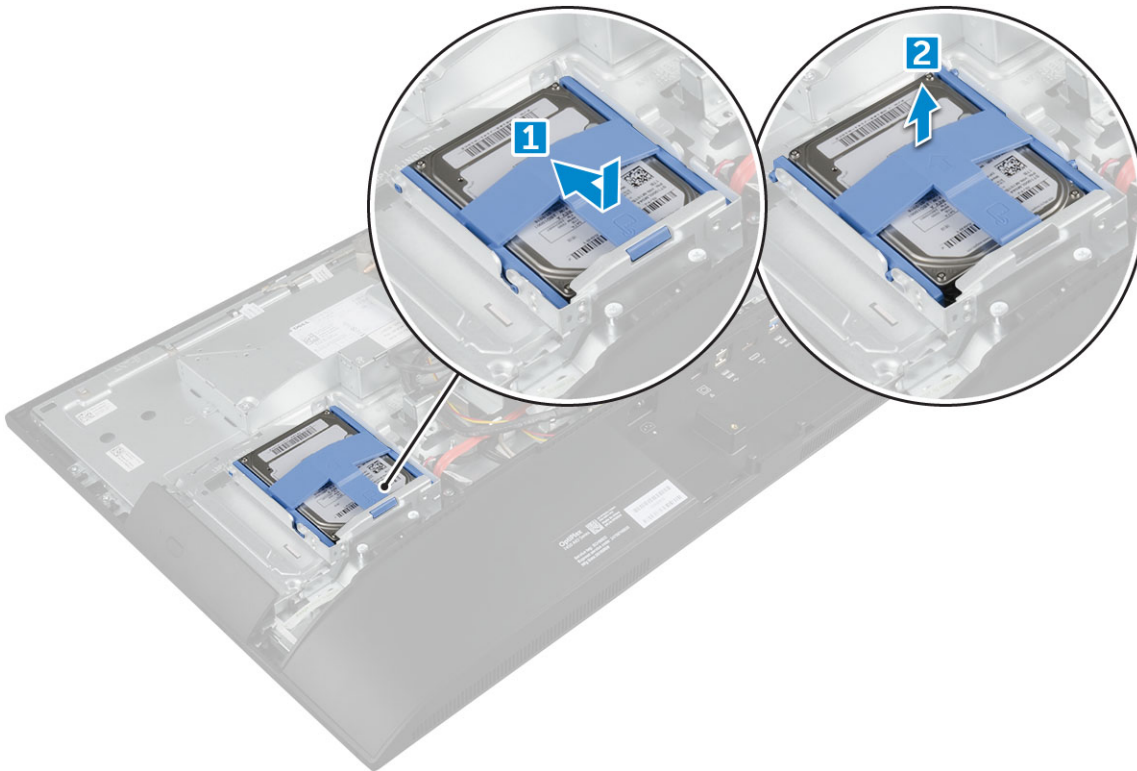

- 4 To remove the hard drive bracket:
 - a Pry the edges of the bracket to release the hard drive [1].
 - b Slide the hard drive and lift it away from the bracket [2].

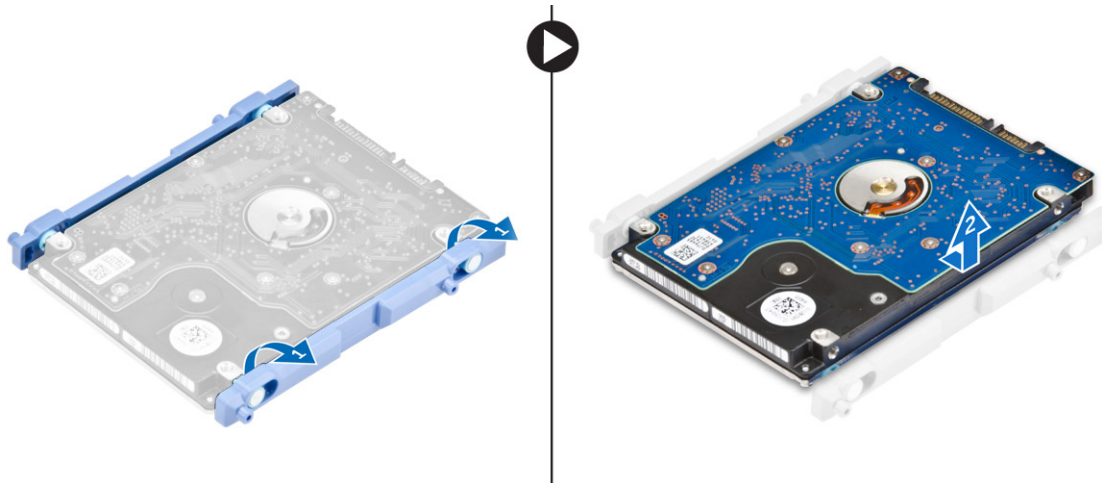

Installing the hard drive assembly

- 1 Align the hard drive until the notches are aligned and the hard drive is secured in the bracket.
- 2 Place the hard drive on the hard drive cage until the notches are aligned and it snaps in.
- 3 Install the:
 - a back cover
 - b stand
- 4 Follow the procedure in [After working inside your computer](#).



Optical drive

Removing the optical drive assembly

- 1 Follow the procedure in [Before working inside your computer](#).
- 2 Remove the:
 - a stand
 - b back cover
- 3 To remove the optical drive assembly:
 - a Press the securing tab at the base of the drive to release the optical drive assembly [1].
 - b Slide the optical drive assembly to remove it away from the computer [3][2].



- 4 To remove the optical drive bracket:
 - a Remove the screws that secure the optical drive bracket [1].
 - b Remove the bracket away from the optical drive [2].

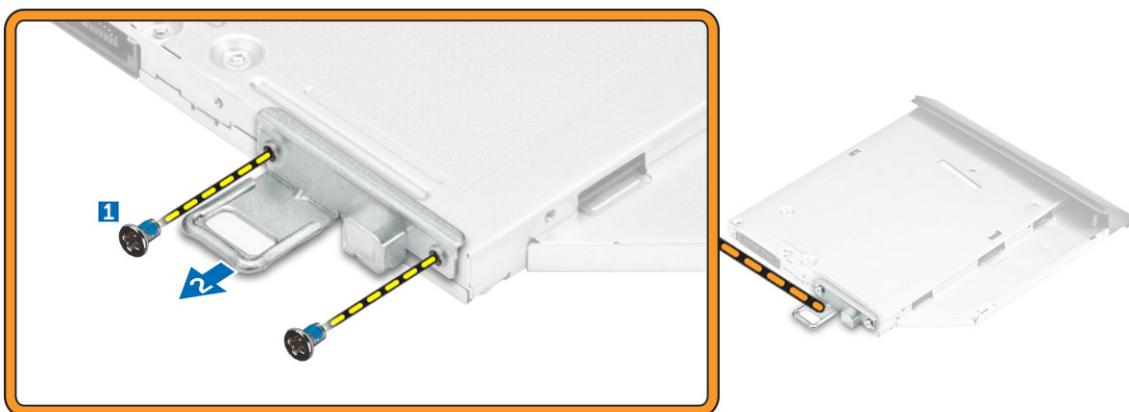

Installing the optical drive assembly

- 1 Place the bracket to align the screw holders on the optical drive.
- 2 Tighten the screws to secure the bracket to the optical drive.
- 3 Insert the optical drive assembly into the drive slot, until it snaps in.
- 4 Install the:
 - a back cover
 - b stand
- 5 Follow the procedure in [After working inside your computer](#).

System board shield

Removing the system board shield

- 1 Follow the procedure in [Before working inside your computer](#).
- 2 Remove the:
 - a stand
 - b back cover
- 3 To remove the system board shield:
 - a Press the securing tab to release the system board shield from the slots on the computer [1].
 - b Slide the system board shield away from the computer [2].

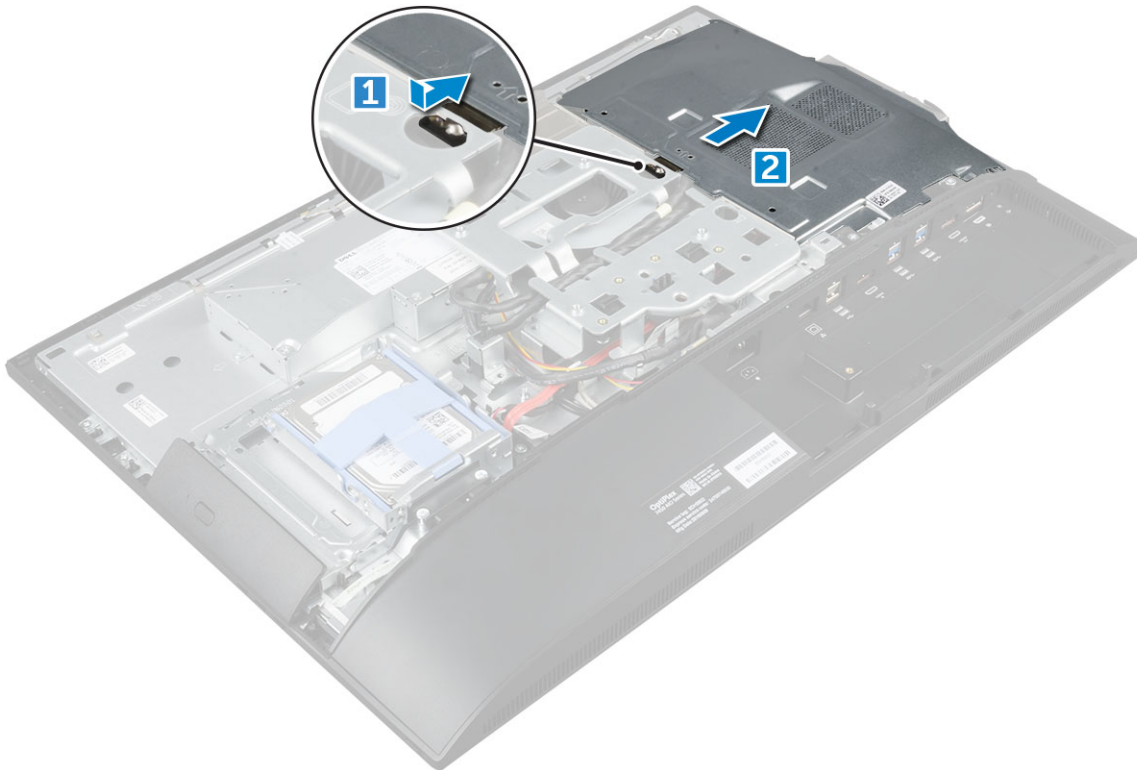

Installing the system board shield

- 1 Align and slide the system board shield until it snaps in.
- 2 Install the:
 - a back cover
 - b stand
- 3 Follow the procedure in [After working inside your computer](#).

Memory module

Removing the memory module

- 1 Follow the procedure in [Before working inside your computer](#).
- 2 Remove the:
 - a stand
 - b back cover
 - c system board shield
- 3 To remove the memory module:
 - a Pry the retention clips away from the memory module until it pops up [1].
 - b Lift the memory module from the connector [2].

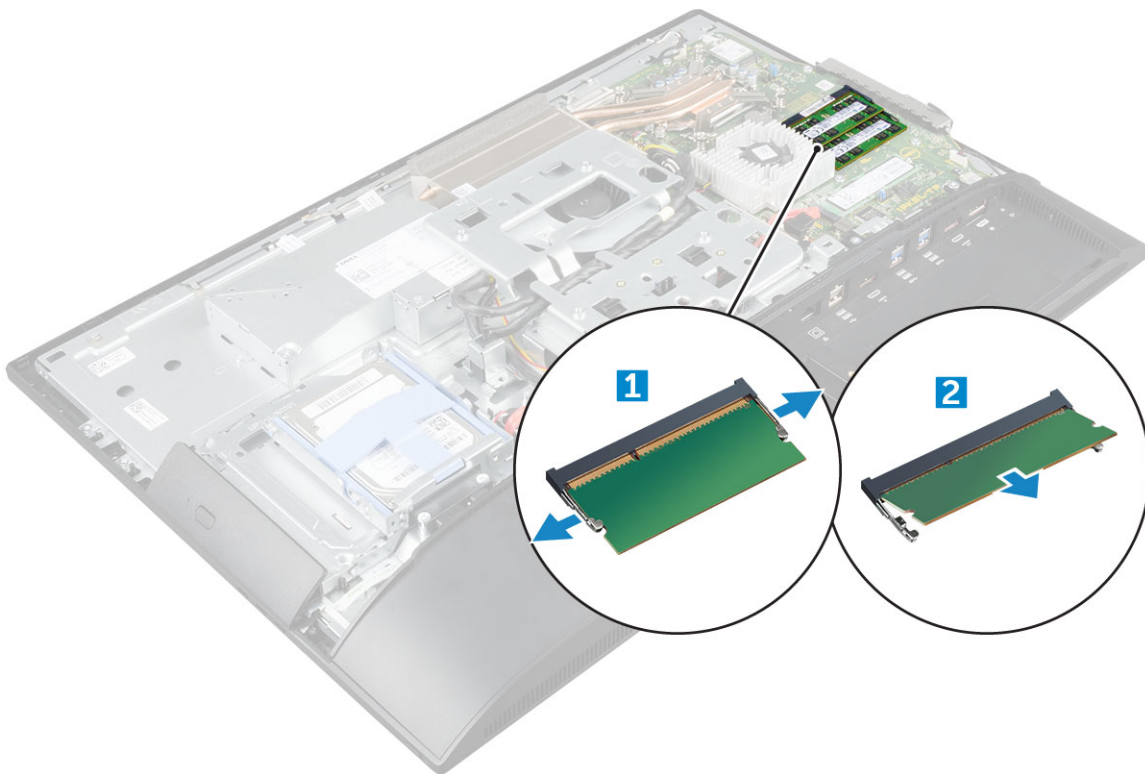

Installing the memory module

- 1 Insert the memory module on the memory connector until the clips secure the memory module.
- 2 Install the:

- a system board shield
 - b back cover
 - c stand
- 3 Follow the procedure in [After working inside your computer](#).

Solid State Drive (SSD)

Removing the SSD card

- 1 Follow the procedure in [Before working inside your computer](#).
- 2 Remove the:
 - a stand
 - b back cover
 - c system board shield
- 3 To remove the SSD card:
 - a Remove the screw that secures the SSD card to the computer [1].
 - b Lift the SSD card away from the connector [2].

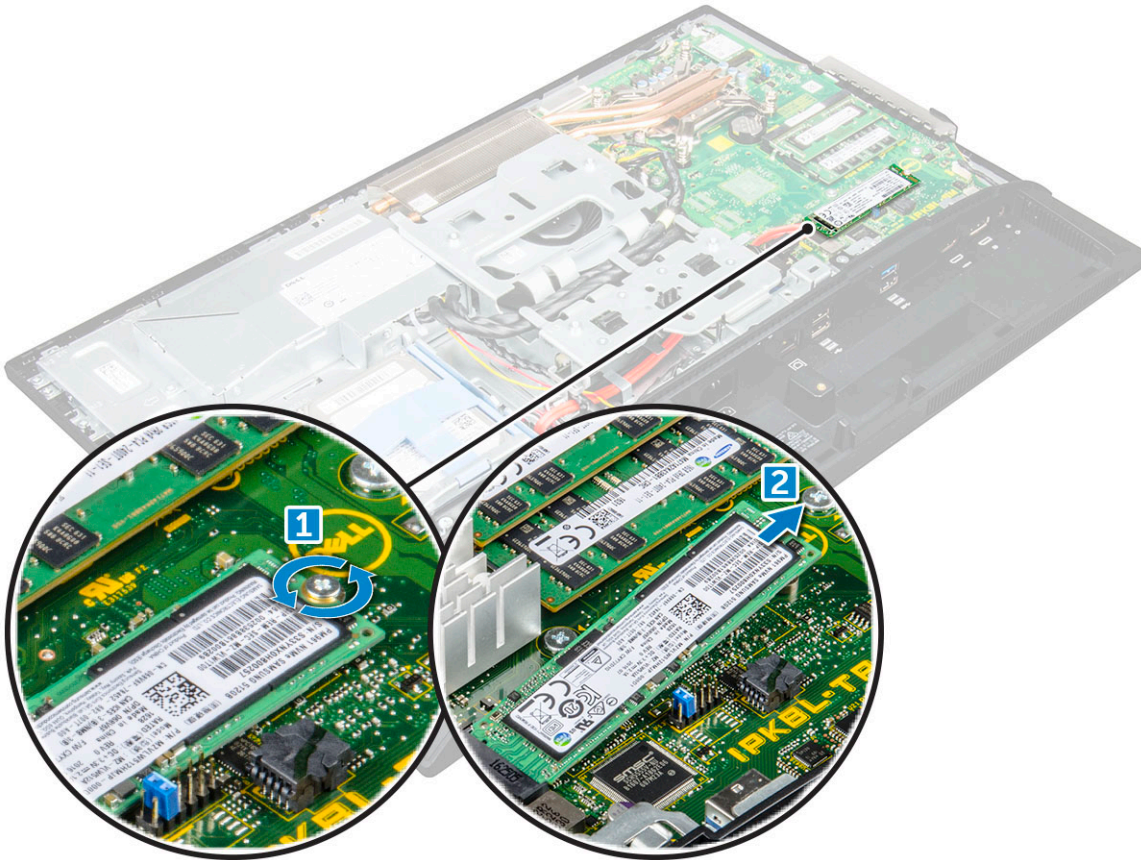

Installing the SSD card

- 1 Insert the SSD card into the connector.
- 2 Tighten the screw to secure the SSD card to the system board.
- 3 Install the:
 - a system board shield



- b back cover
- c stand

4 Follow the procedure in [After working inside your computer](#).

Coin cell battery

Removing the coin cell battery

- 1 Follow the procedure in [Before working inside your computer](#).
- 2 Remove the:
 - a stand
 - b back cover
 - c system board shield
- 3 Press the latch to release the coin cell battery and remove it from the computer.

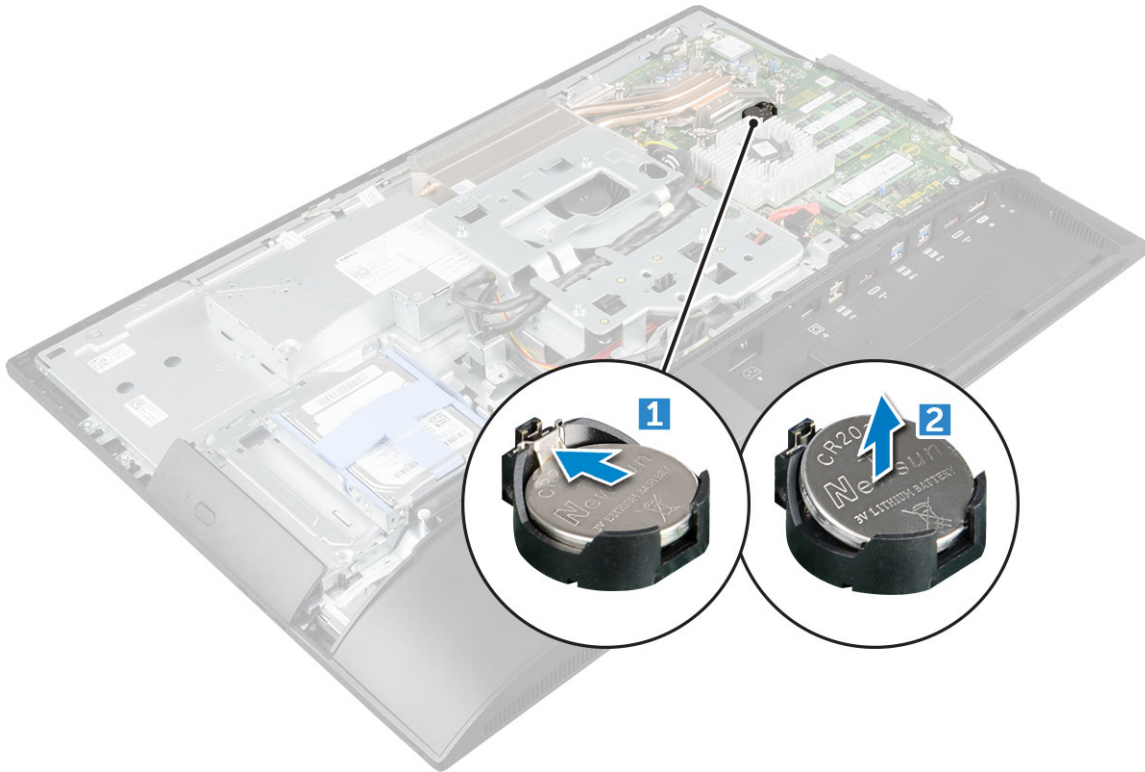

Installing the coin cell battery

- 1 Insert the coin cell battery into the slot on the system board until it fits securely.
- 2 Install the:
 - a system board shield
 - b back cover
 - c stand
- 3 Follow the procedure in [After working inside your computer](#).

WLAN card

Removing the WLAN card

- 1 Follow the procedure in [Before working inside your computer](#).
- 2 Remove the:
 - a [stand](#)
 - b [back cover](#)
 - c [system board shield](#)
- 3 To remove the WLAN card:
 - a Disconnect the antenna cables from the connectors on the WLAN card [1].
 - b Remove the screw that secures the WLAN card to the system board [2].
 - c Hold the WLAN card and pull it from the connector on the system board [3].

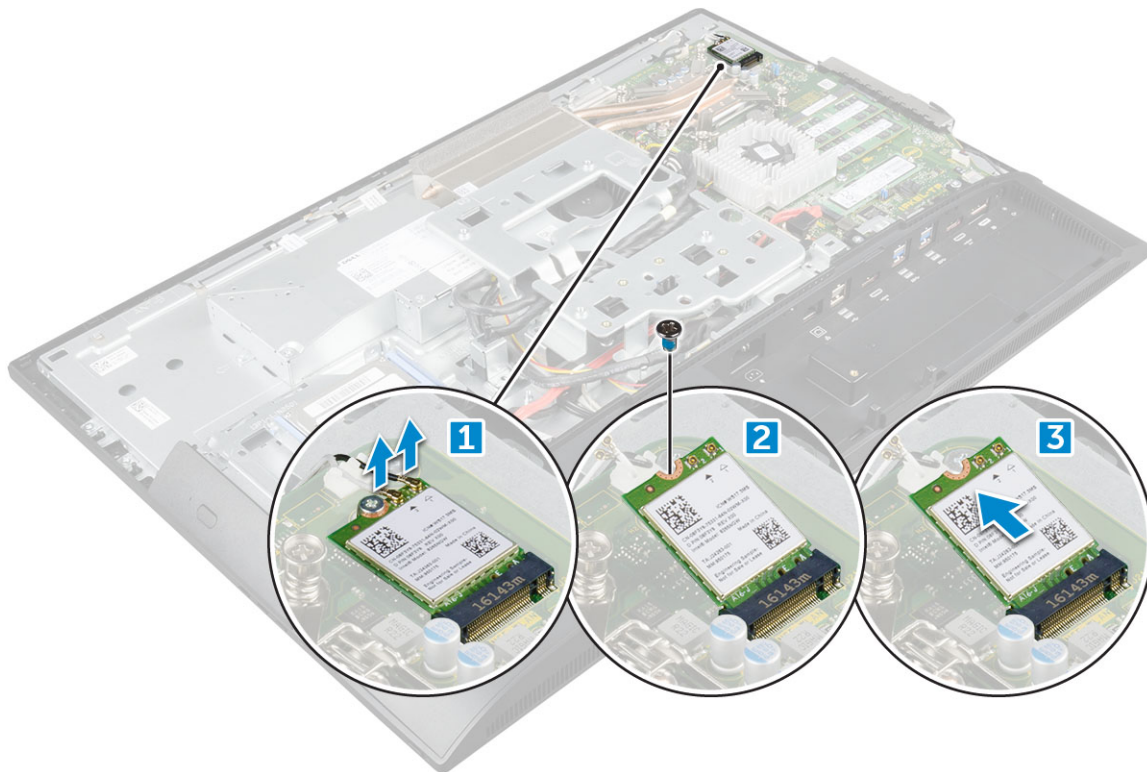

Installing the WLAN card

- 1 Align the WLAN card to the connector on the system board.
- 2 Tighten the screw to secure the WLAN card to the system board.
- 3 Connect the antenna cables to the connectors on the WLAN card.
- 4 Install the:
 - a [system board shield](#)
 - b [back cover](#)
 - c [stand](#)
- 5 Follow the procedure in [After working inside your computer](#).



Heat sink

Removing the heat sink

- 1 Follow the procedure in [Before working inside your computer](#).
- 2 Remove the:
 - a [stand](#)
 - b [back cover](#)
 - c [system board shield](#)
- 3 To remove the heat sink:
 - a Remove the screws that secure the heat sink to the chassis [1, 2].
 - b Lift the heat sink away from the computer [3].

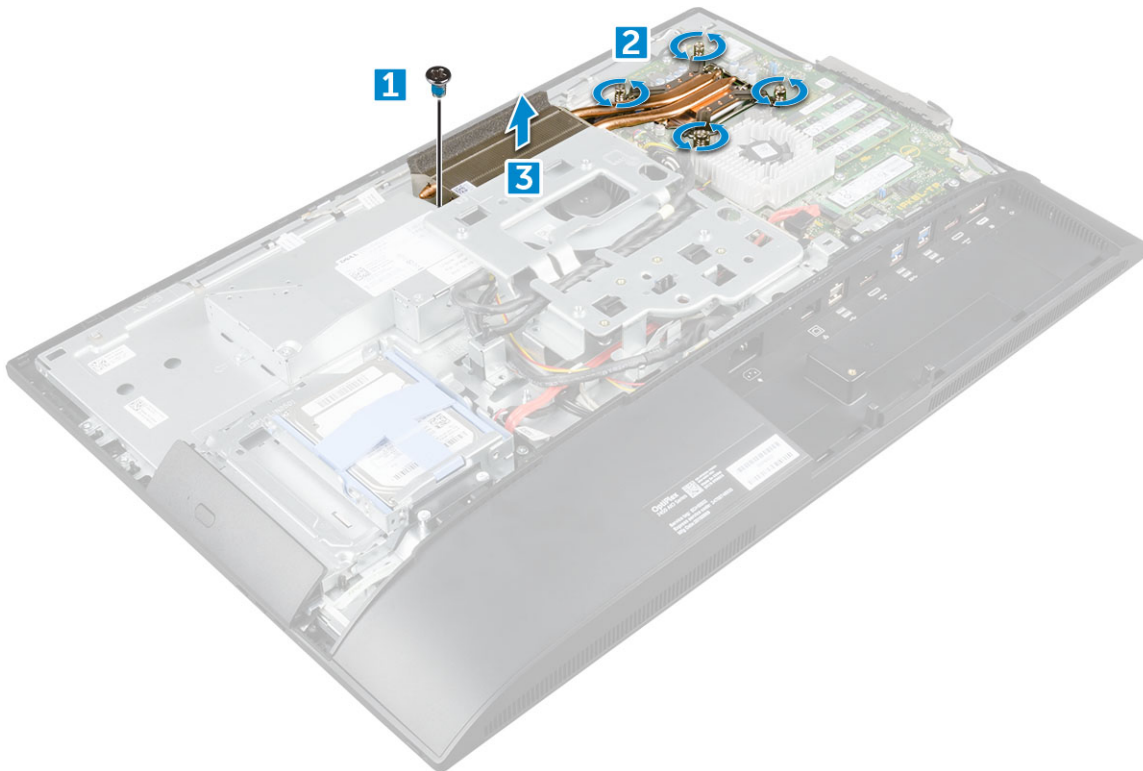

Installing the heat sink

- 1 Align and place the heat sink in the slot.
- 2 Tighten the screws to secure the heat sink to the computer.
- 3 Install the:
 - a [system board shield](#)
 - b [back cover](#)
 - c [stand](#)
- 4 Follow the procedure in [After working inside your computer](#).

Speaker

Removing the speaker module

- 1 Follow the procedure in [Before working inside your computer](#).
- 2 Remove the:
 - a stand
 - b back cover
 - c cable cover
 - d speaker cover
 - e system board shield
- 3 To release the speaker module:
 - a Disconnect the speaker cable from the connector on the system board [1].
 - b Unthread the speaker cables from the retention clips [2].

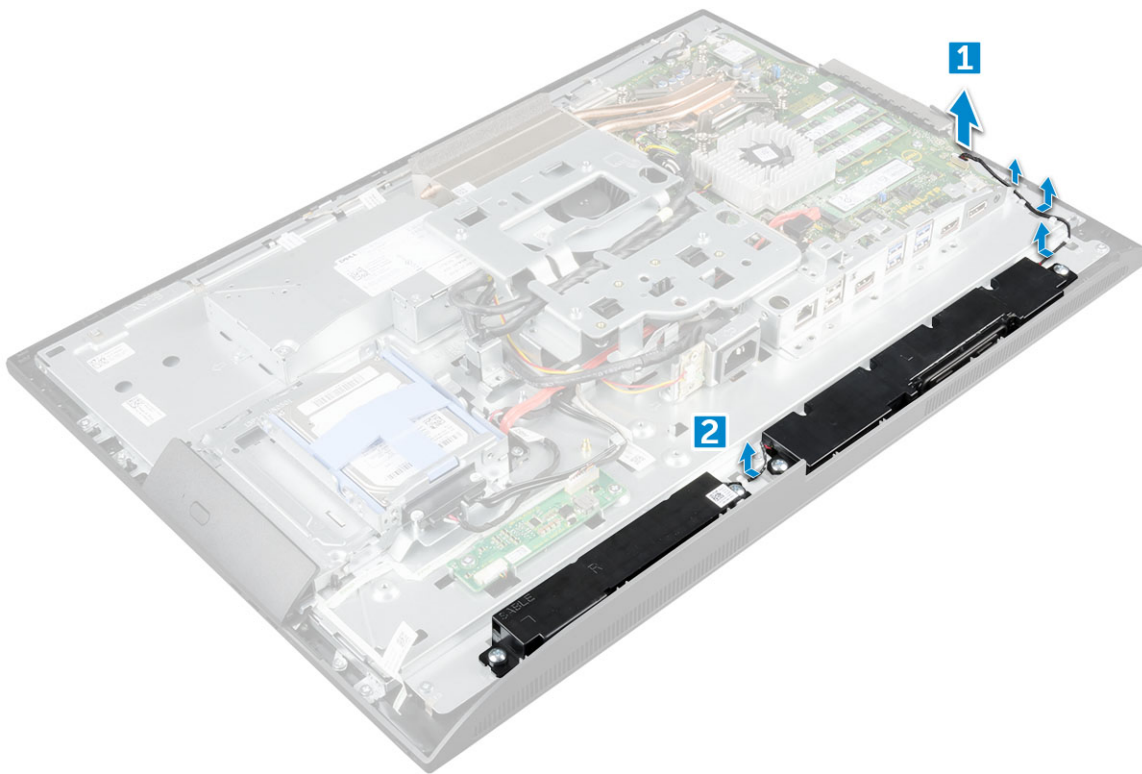

- 4 To remove the speaker module:
 - a Remove the screws that secure the speaker module to the chassis [1].
 - b Lift the speaker module and remove it from the chassis [2].

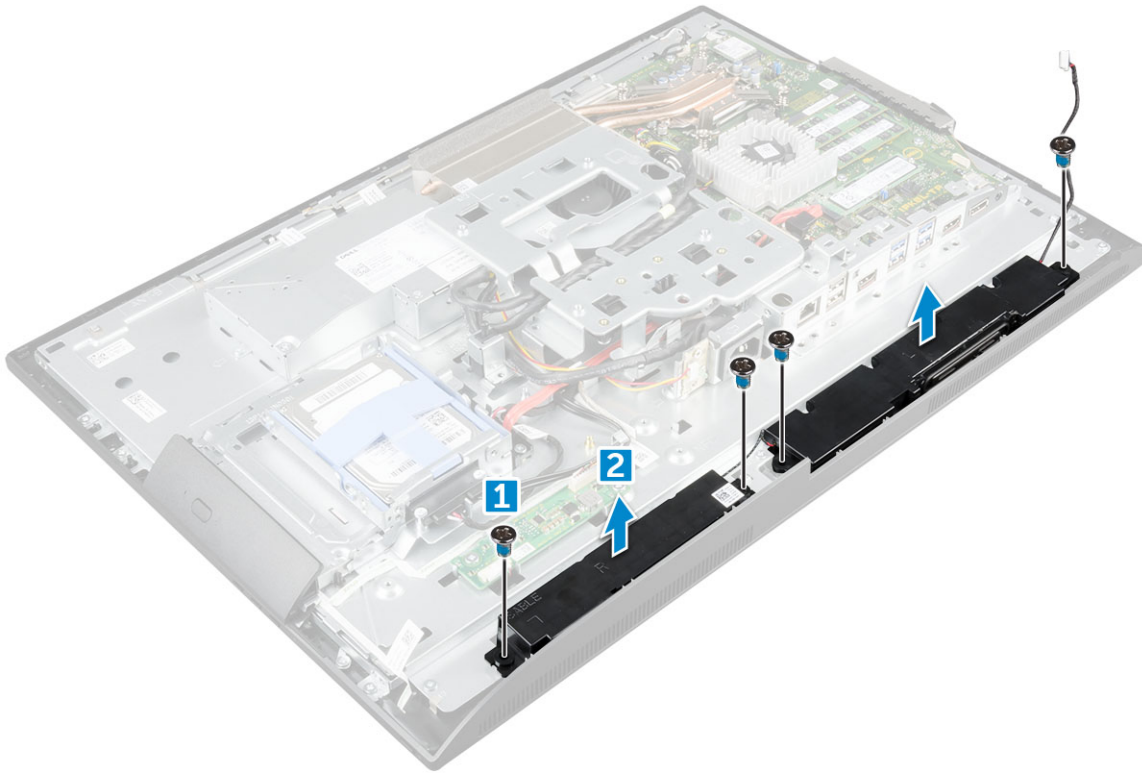

Installing the speaker module

- 1 Insert the speaker module into the slot on the chassis.
- 2 Tighten the screws to secure the speaker to the chassis.
- 3 Secure the speaker cables through the retention clips.
- 4 Connect the speaker cable to the connector on the system board.
- 5 Install the:
 - a system board shield
 - b speaker cover
 - c back cover
 - d cable cover
 - e stand
- 6 Follow the procedure in [After working inside your computer](#).

Power supply unit

Removing the Power Supply Unit (PSU)

- 1 Follow the procedure in [Before working inside your computer](#).
- 2 Remove the:
 - a stand
 - b back cover
 - c cable cover
 - d speaker cover
 - e system board shield
- 3 To release the PSU cable:

- a Unthread the power supply cables from the retention clips in the chassis [1].
- b Disconnect the power supply cable from the connector on the system board [2].

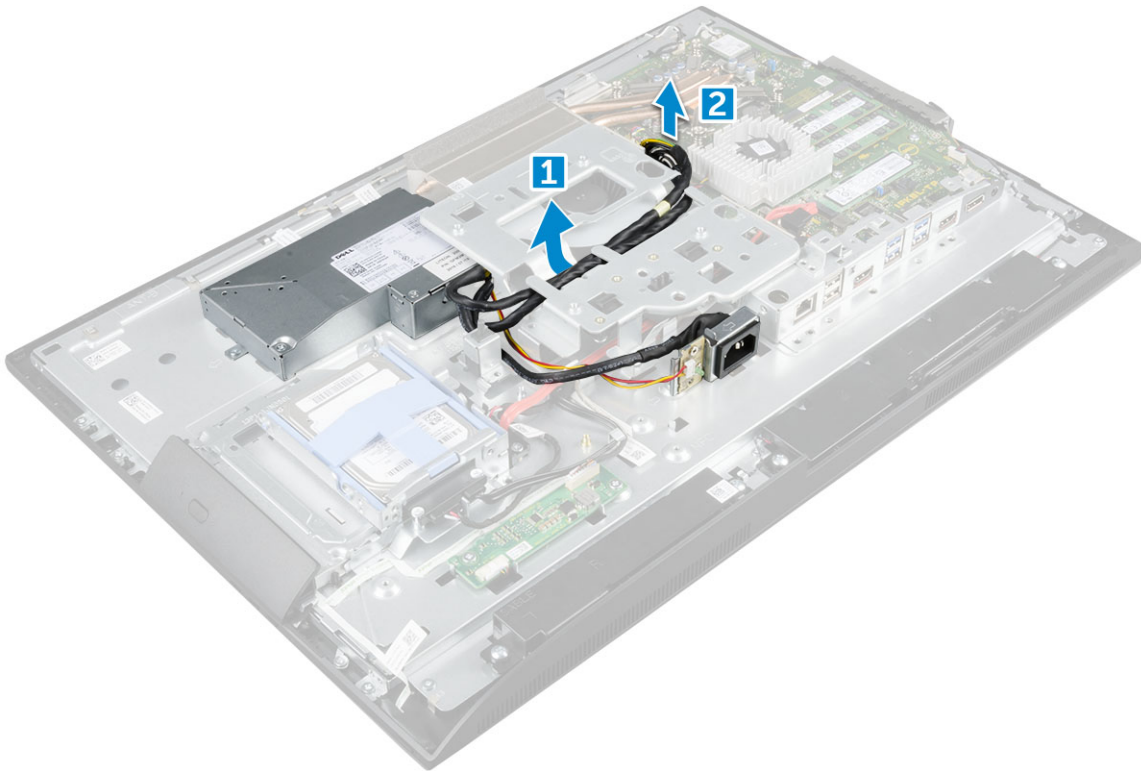

- 4 To release the PSU:
 - a Remove the screw that secures the power supply socket to the chassis [1].
 - b Slide the socket to remove it from the computer [2].

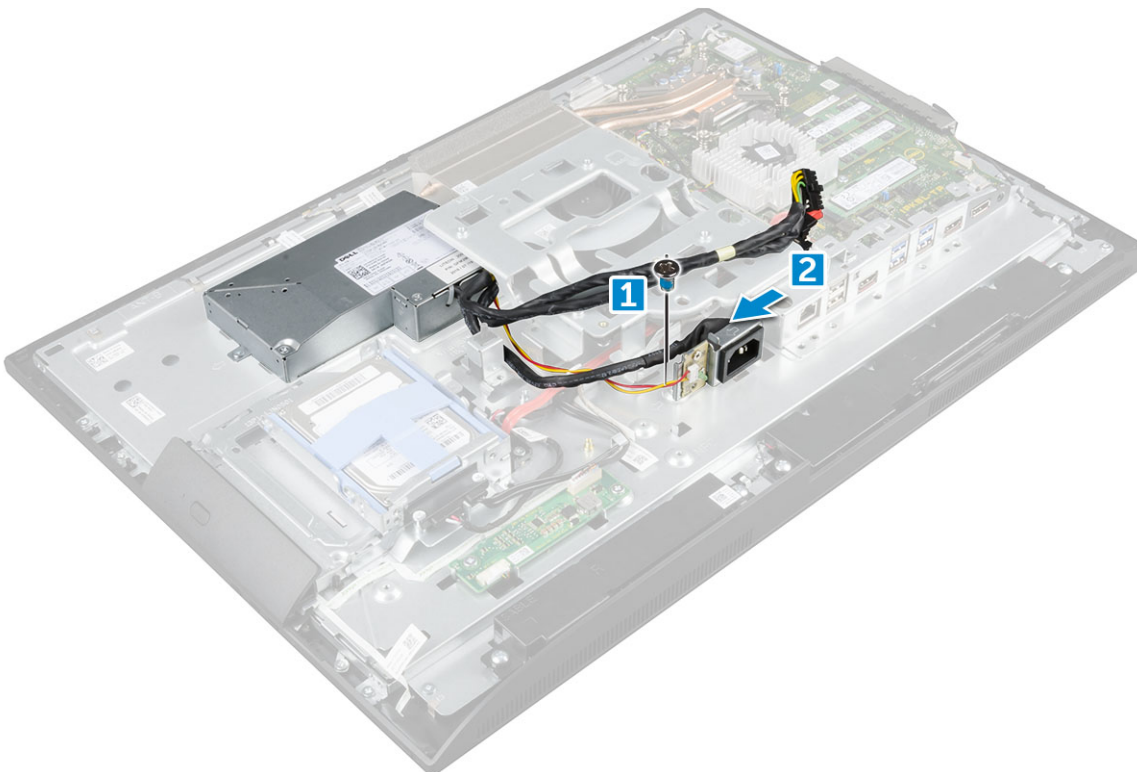

- 5 To remove the PSU:
 - a Remove the screw that secure the PSU to the chassis [1].



- b Slide the PSU and lift it away from the chassis [2].

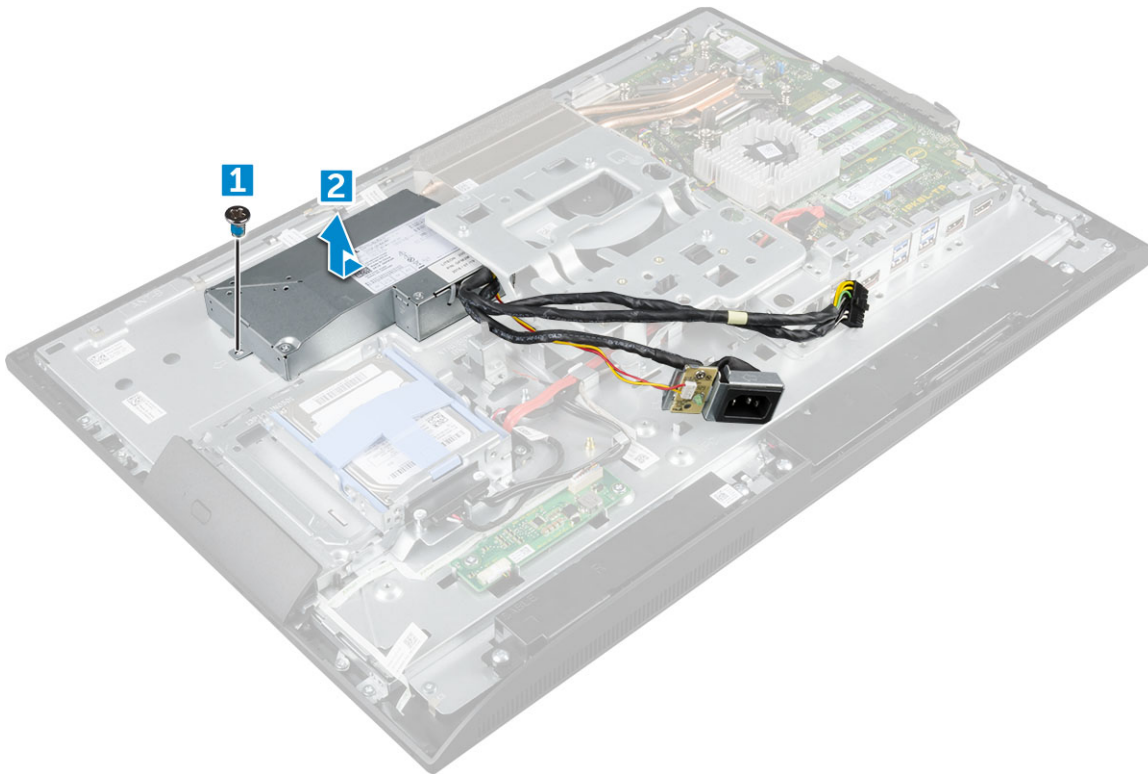

Installing the Power Supply Unit (PSU)

- 1 Place the PSU on the chassis.
- 2 Tighten the screw to secure the PSU to the chassis.
- 3 Place the power supply socket in the slot on the chassis.
- 4 Tighten the screw to secure the power supply socket to the chassis.
- 5 Secure the power supply cable on the retention clips in the chassis.
- 6 Connect the power supply cables to the connectors on the system board.
- 7 Install the:
 - a [system board shield](#)
 - b [speaker cover](#)
 - c [cable cover](#)
 - d [back cover](#)
 - e [stand](#)
- 8 Follow the procedure in [After working inside your computer](#).

VESA mount bracket

Removing the VESA mount bracket

- 1 Follow the procedure in [Before working inside your computer](#).
- 2 Remove the:
 - a [stand](#)
 - b [back cover](#)

- c cable cover
 - d speaker cover
 - e system board shield
 - f power supply unit
- 3 To remove the VESA mount bracket:
- a Remove the screws that secure the VESA mount bracket to the computer [1].
 - b Lift the bracket away from the computer [2].

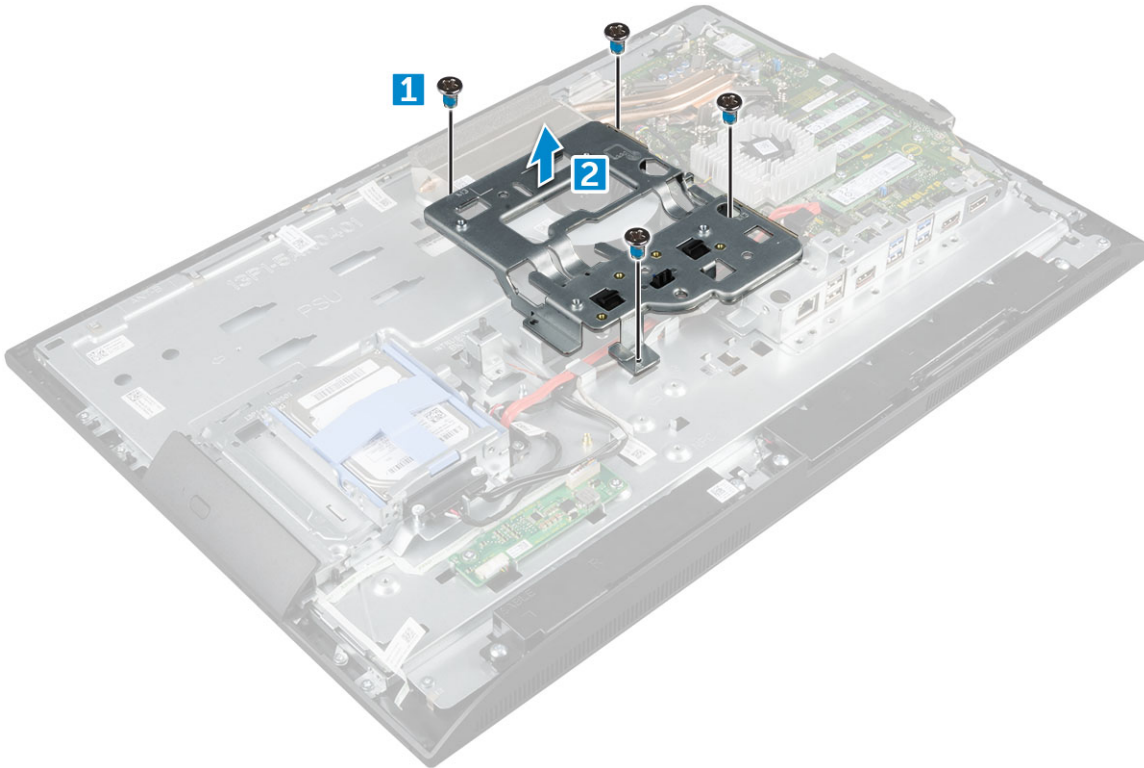

Installing the VESA mount bracket

- 1 Align and place the bracket in the slot on the computer.
- 2 Tighten the screws that secure the VESA mount bracket to the computer.
- 3 Install the:
 - a power supply unit
 - b system board shield
 - c speaker cover
 - d cable cover
 - e back cover
 - f stand
- 4 Follow the procedure in [After working inside your computer](#).

Converter board



Removing the converter board

- 1 Follow the procedure in [Before working inside your computer](#).
- 2 Remove the:
 - a [stand](#)
 - b [back cover](#)
 - c [cable cover](#)
 - d [speaker cover](#)
 - e [system board shield](#)
 - f [power supply unit](#)
 - g [VESA mount bracket](#)
- 3 To remove the converter board:
 - a Disconnect the converter board cable from the converter board [1].
 - b Disconnect the display backlight cable from the converter board [2].
 - c Remove the screws that secure the converter board to the computer [3].
 - d Lift the converter board away from the computer [4].

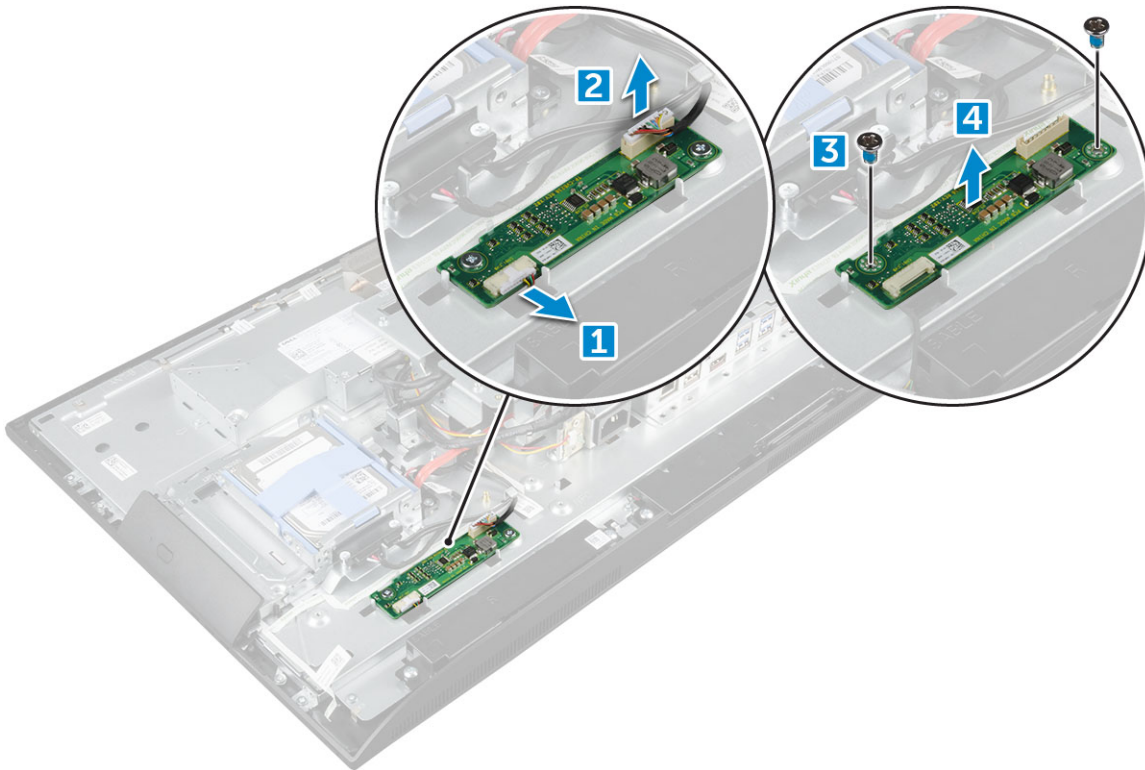

Installing the converter board

- 1 Place the converter board in the slot.
- 2 Tighten the screws to secure the converter board to the chassis.
- 3 Connect the converter board cable and display backlight cable to the connectors on the converter board.
- 4 Install the:
 - a [VESA mount bracket](#)
 - b [power supply unit](#)
 - c [system board shield](#)

- d speaker cover
- e cable cover
- f back cover
- g stand

5 Follow the procedure in [After working inside your computer](#).

System fan

Removing the system fan

- 1 Follow the procedure in [Before working inside your computer](#).
- 2 Remove the:
 - a stand
 - b back cover
 - c cable cover
 - d speaker cover
 - e system board shield
 - f power supply unit
 - g VESA mount bracket
- 3 To remove the system fan:
 - a Disconnect the system fan cable from the connector on the system board [1].
 - b Remove the screws that secure the system fan to the computer [2].
 - c Lift the system fan away from the computer [3].

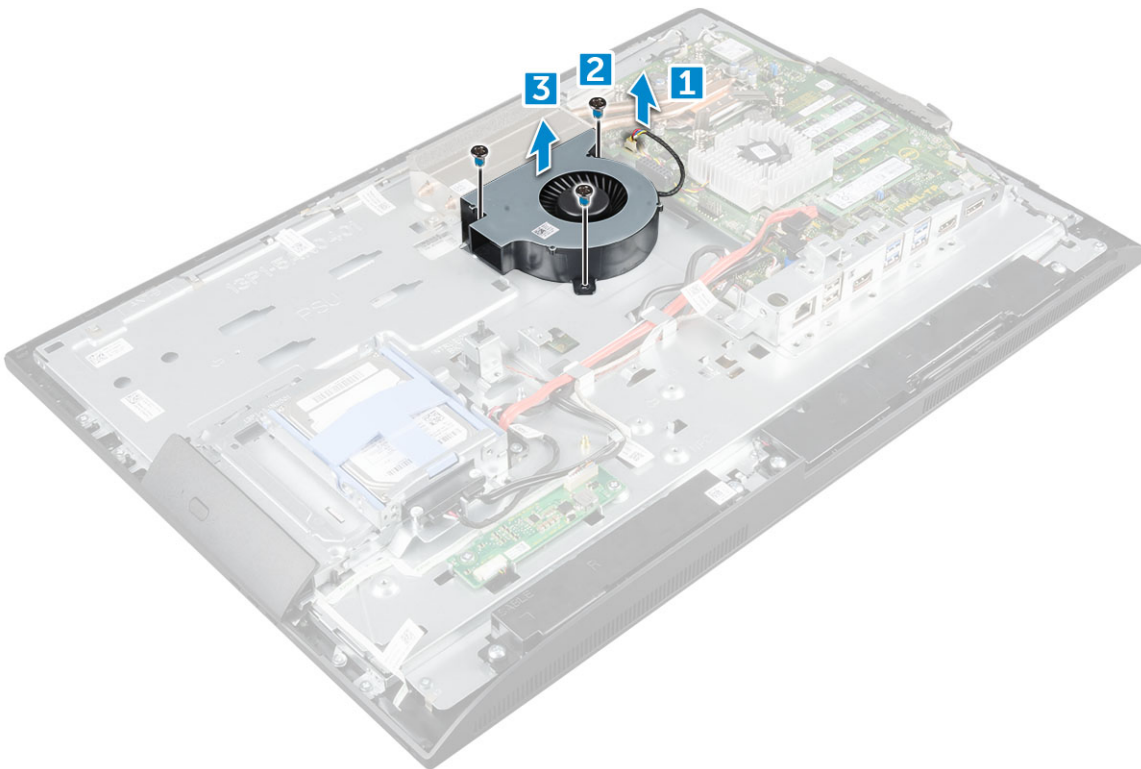

Installing the system fan

- 1 Align and place the system fan in the slot on the chassis.
- 2 Tighten the screws to secure the system fan to the system board.
- 3 Connect the system fan cable to the connector on the system board.
- 4 Install the:
 - a VESA mount bracket
 - b power supply unit
 - c system board shield
 - d speaker cover
 - e cable cover
 - f back cover
 - g stand
- 5 Follow the procedure in [After working inside your computer](#).

Intrusion switch

Removing the intrusion switch

- 1 Follow the procedure in [Before working inside your computer](#).
- 2 Remove the:
 - a stand
 - b back cover
 - c cable cover
 - d speaker cover
 - e system board shield
 - f power supply unit
 - g VESA mount bracket
- 3 To remove the intrusion switch:
 - a Disconnect the intrusion switch cable from the connector on the system board [1].
 - b Unthread the intrusion switch cable from the retention clips on the computer [2].
 - c Remove the screw that secures the intrusion switch to the computer [3].
 - d Slide and lift the intrusion switch away from the computer [4].

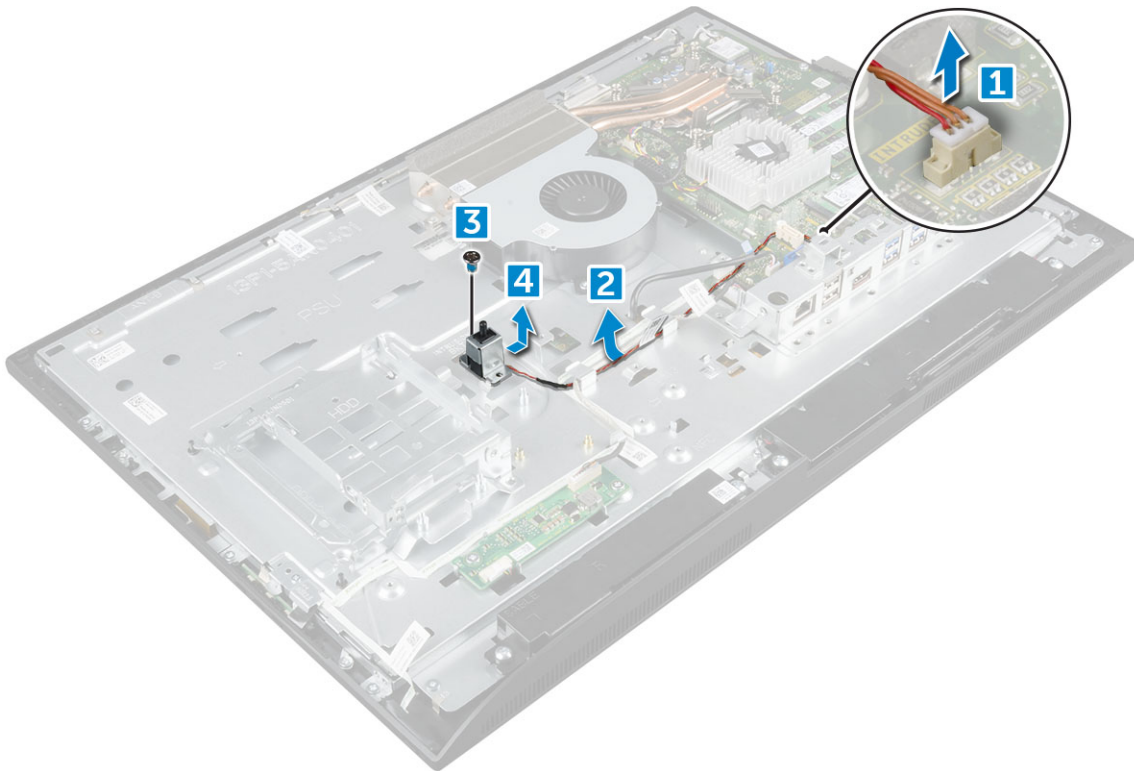

- 4 Perform the following instructions as shown in the illustration:
 - a Remove the screw that secures the intrusion switch to the chassis [1].
 - b Slide and lift the intrusion switch to remove it from the computer [2].

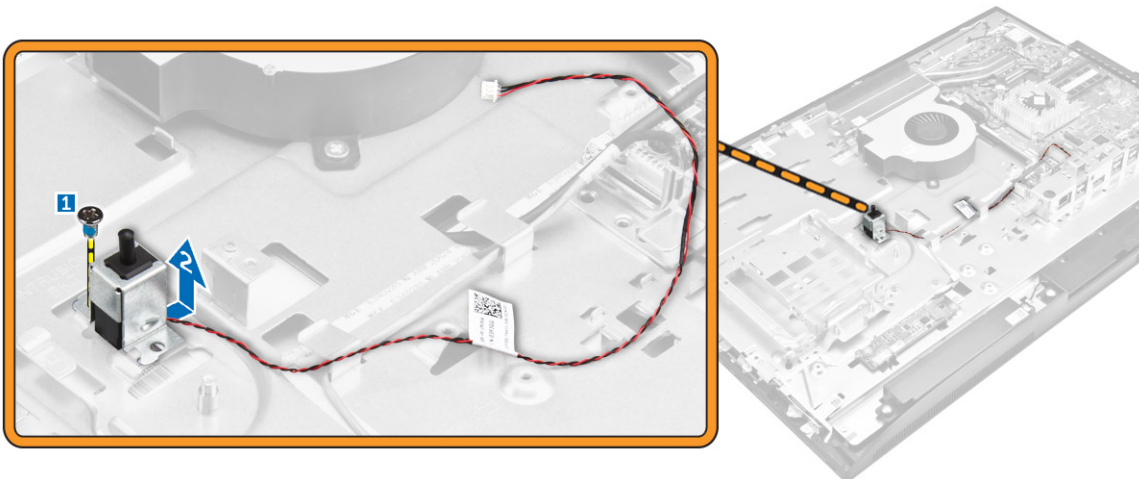

Installing the intrusion switch

- 1 Place the intrusion switch in the slot on the computer.
- 2 Tighten the screw to secure the intrusion switch to the chassis.
- 3 Route intrusion switch cable along the retention clips on the chassis.
- 4 Connect the intrusion switch cable to the connector on the system board.
- 5 Install:
 - a [VESA mount bracket](#)
 - b [power supply unit](#)
 - c [system board shield](#)



- d speaker cover
- e cable cover
- f back cover
- g stand

6 Follow the procedures in [After working inside your computer](#).

Processor

Removing the processor

1 Follow the procedure in [Before working inside your computer](#).

2 Remove the:

- a stand
- b back cover
- c cable cover
- d speaker cover
- e speaker
- f VESA mount bracket
- g system board shield
- h SSD card
- i WLAN card
- j memory
- k heat sink
- l system fan

3 To remove the processor:

- a Release the socket lever by pushing the lever down and out from under the tab on the processor shield [1].
- b Lift the lever upward and lift the processor shield [2].

CAUTION: The processor socket pins are fragile and can be permanently damaged. Be careful not to bend the pins in the processor socket when removing the processor out of the socket.

- c Lift the processor out of the socket [3].

NOTE: After removing the processor, place it in an antistatic container for reuse, return, or temporary storage. Do not touch the bottom of the processor to avoid damage to the processor contacts. Touch only the side edges of the processor.



Installing the processor

1 Align the processor with the socket keys.

 **CAUTION:** Do not use force to seat the processor. When the processor is positioned correctly, it engages easily into the socket.

- 2 Align the pin-1 indicator of the processor with the triangle on the socket.
- 3 Place the processor on the socket such that the slots on the processor align with the socket keys.
- 4 Close the processor shield by sliding it under the retention screw.
- 5 Lower the socket lever and push it under the tab to lock it.
- 6 Install:
 - a system fan
 - b heat sink
 - c memory
 - d WLAN card
 - e SSD card
 - f system board shield
 - g VESA mount bracket
 - h cable cover
 - i speaker
 - j speaker cover
 - k back cover
 - l stand
- 7 Follow the procedure in [After working inside your computer](#).

System board

Removing the system board

- 1 Follow the procedure in [Before working inside your computer](#).
- 2 Remove the:
 - a stand
 - b back cover
 - c cable cover
 - d speaker cover
 - e speaker
 - f hard drive
 - g optical drive
 - h VESA mount bracket
 - i system board shield
 - j SSD card
 - k WLAN card
 - l memory
 - m heat sink
 - n system fan
 - o processor
 - p coin cell battery
 - q power supply unit
- 3 Disconnect the following cables from the system board:
 - a intrusion switch [1]
 - b hard drive and optical drive [2]
 - c SATA [3]
 - d speaker [4]
 - e camera and microphone [5]
 - f display [6]
 - g system fan [7]



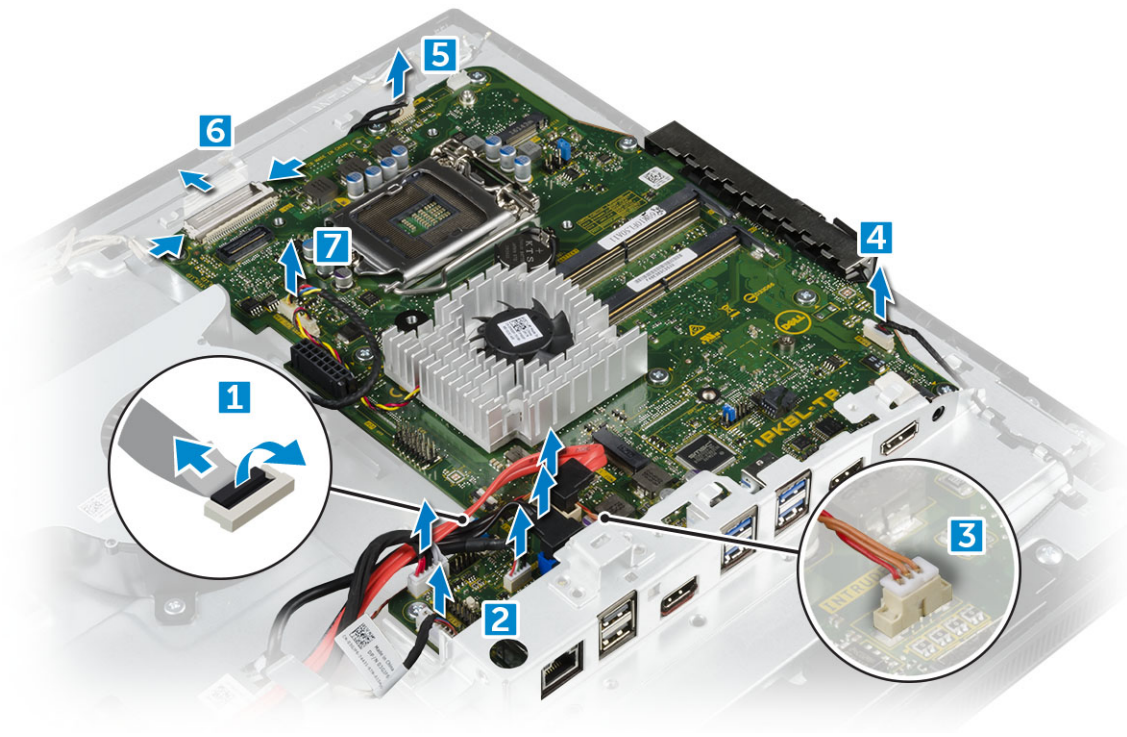

- 4 To remove the system board:
- a Remove the screws that secure the system board to the chassis [1].
 - b Slide and lift the system board away from the computer [2].

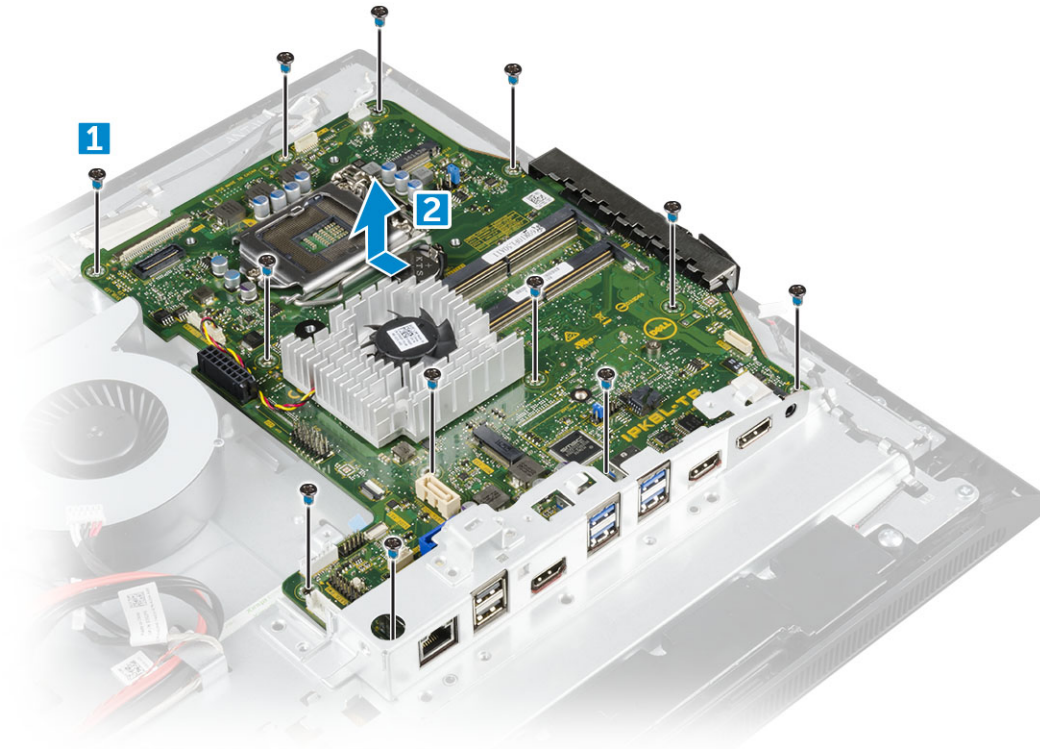

Installing the system board

- 1 Place the system board on the computer.
- 2 Connect all the cables to the system board.
- 3 Tighten the screws to secure the system board to the base panel.
- 4 Install the:
 - a power supply unit
 - b coin cell battery
 - c system fan
 - d processor
 - e heat sink
 - f memory
 - g WLAN card
 - h SSD card
 - i system board shield
 - j VESA mount bracket
 - k optical drive
 - l hard drive
 - m cable cover
 - n speaker
 - o speaker cover
 - p back cover
 - q stand
- 5 Follow the procedure in [After working inside your computer](#).



System board layout

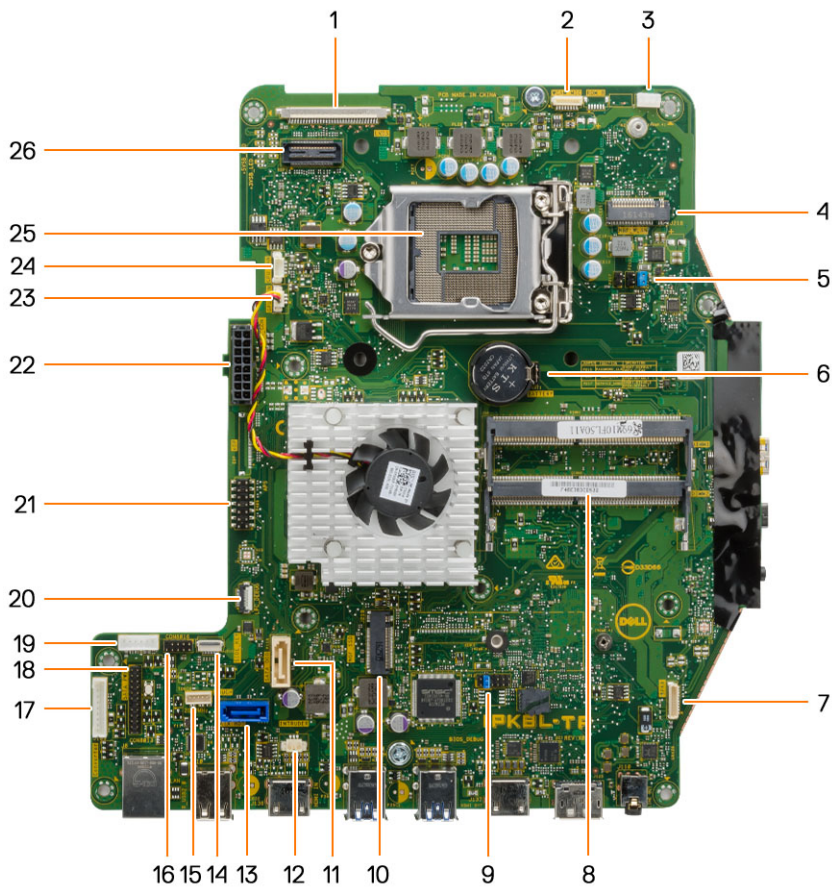

- | | | | |
|----|---------------------------|----|--------------------------------|
| 1 | LVDS connector | 2 | Camera connector |
| 3 | Antenna wire clip | 4 | WLAN connector |
| 5 | Jumper connector | 6 | Coin cell battery |
| 7 | Speaker connector | 8 | Memory module connector |
| 9 | Jumper connector | 10 | M.2 SSD slot |
| 11 | Optical drive connector | 12 | Intrusion switch connector |
| 13 | Hard drive connector | 14 | Side buttons connector |
| 15 | Touchpad connector | 16 | CAC/PIV connector (reserved) |
| 17 | Converter board connector | 18 | Windows serial debug connector |
| 19 | HDD/ODD power connector | 20 | LPC debug connector |
| 21 | APS debug connector | 22 | Power supply connector |
| 23 | CPU fan connector | 24 | CPU fan connector |
| 25 | CPU socket | | |

Chassis frame



Removing the chassis frame

① **NOTE:** These instructions are applicable only for systems with a non-touch screen display.

- 1 Follow the procedure in [Before working inside your computer](#).
- 2 Remove the:
 - a stand
 - b back cover
 - c cable cover
 - d speaker cover
 - e speaker
 - f hard drive
 - g optical drive
 - h VESA mount bracket
 - i system board shield
 - j SSD card
 - k WLAN card
 - l memory
 - m heat sink
 - n system fan
 - o processor
 - p coin cell battery
 - q power supply unit
 - r system board
- 3 To remove the chassis frame:
 - a Peel the adhesive tapes that secure the chassis frame [1].
 - b Remove the screws that secure the chassis frame to the computer [2].
 - c Lift the chassis frame away from the computer [3].

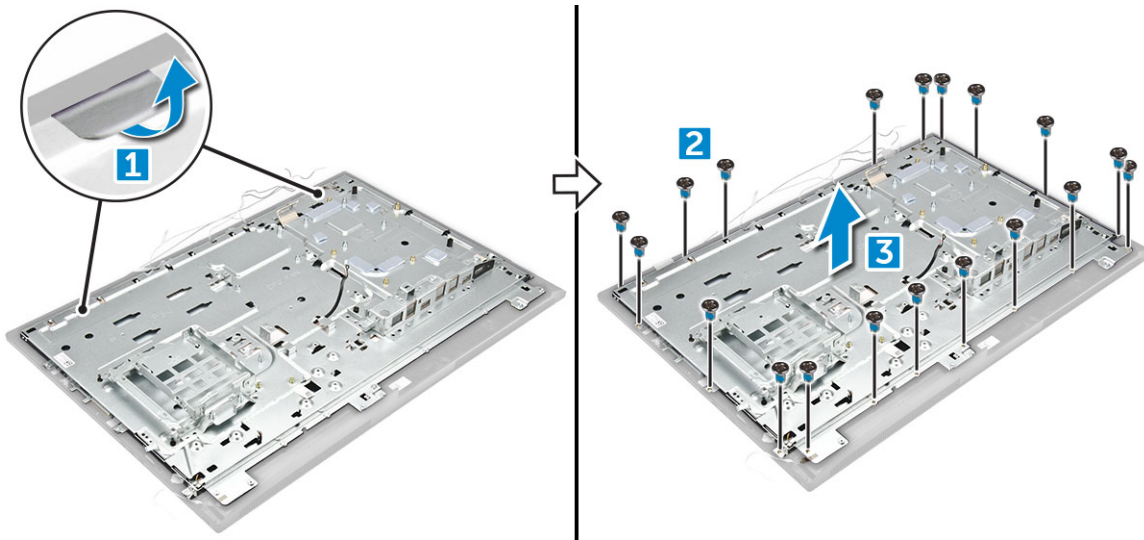

Installing the chassis frame

- 1 Place the chassis frame on the computer.
- 2 Tighten the screws to secure the chassis frame to the computer.
- 3 Affix the adhesive tapes to secure the chassis frame to the computer.



- 4 Install the:
 - a system board
 - b power supply unit
 - c coin cell battery
 - d system fan
 - e processor
 - f heat sink
 - g memory
 - h WLAN card
 - i system board shield
 - j SSD card
 - k VESA mount bracket
 - l optical drive
 - m hard drive
 - n cable cover
 - o speaker
 - p speaker cover
 - q back cover
 - r stand
- 5 Follow the procedure in [After working inside your computer](#).

Display panel

Removing the display panel

- 1 Follow the procedure in [Before working inside your computer](#).
- 2 Remove the:
 - a stand
 - b back cover
 - c cable cover
 - d speaker cover
 - e speaker
 - f hard drive
 - g optical drive
 - h VESA mount bracket
 - i system board shield
 - j SSD card
 - k WLAN card
 - l memory
 - m heat sink
 - n system fan
 - o processor
 - p coin cell battery
 - q power supply unit
 - r system board
 - s chassis frame
- 3 To remove the display panel:
 - a Disconnect the cables from the connectors [1].
 - b Remove the screws that secure the display panel to the computer [2].
 - c Lift the display panel away from the computer [3].

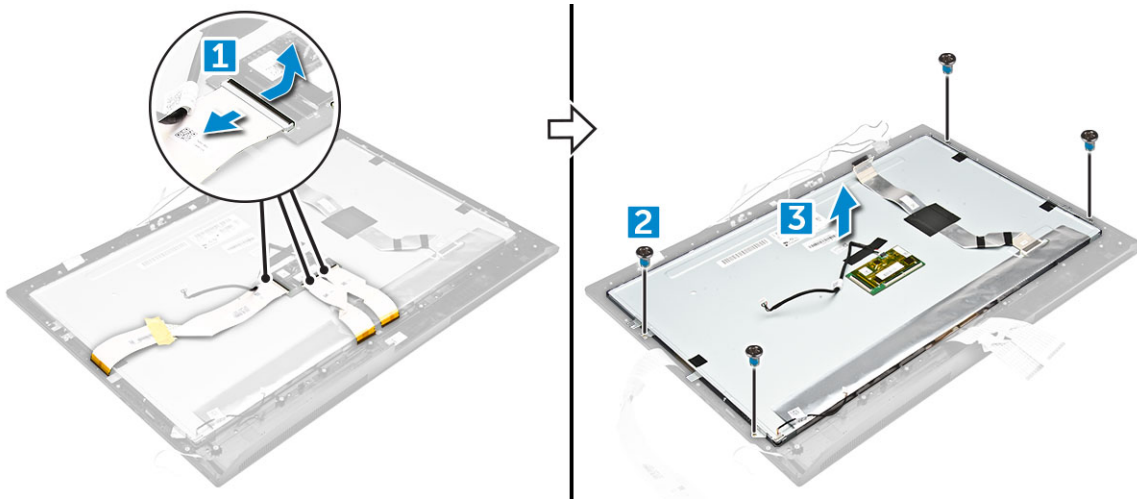

Installing the display panel

- 1 Align the display panel with the screw holes on the computer.
- 2 Tighten the screws to secure the display panel to the computer.
- 3 Connect the cables to the connectors.
- 4 Install the:
 - a chassis frame
 - b system board
 - c power supply unit
 - d coin cell battery
 - e system fan
 - f processor
 - g heat sink
 - h memory
 - i WLAN card
 - j system board shield
 - k SSD card
 - l VESA mount bracket
 - m optical drive
 - n hard drive
 - o cable cover
 - p speaker
 - q speaker cover
 - r back cover
 - s stand
- 5 Follow the procedure in [After working inside your computer](#).

Technology and components

This chapter details the technology and components available in the systems.

Topics:

- [Processors](#)
- [Chipsets](#)
- [Storage options](#)
- [Memory configurations](#)
- [DDR4](#)

Processors

Processor numbers are not a measure of performance. Processor availability is subject to change and may vary by region or country. The following table lists the processors that are supported in OptiPlex 7450 AIO:

Table 1. 7th generation Intel Processors (Support for Windows 10/ Linux Only)

Intel Pentium G4560 Processor (Dual Core/ 3MB/ 2T/ 3.5GHz/ 54W)
Intel Core i3-7100 Processor (Dual Core/ 3MB/ 4T/ 3.9GHz/ 51W)
Intel Core i5-7500 Processor (Quad Core/ 6MB/ 4T/ 3.4GHz/ 65W)
Intel Core i5-7600 Processor (Quad Core/ 6MB/ 4T/ 3.5GHz/ 65W)
Intel Core i7-7700 Processor (Quad Core/ 8MB/ 8T/ 3.6GHz/ 65W)

Table 2. 6th generation Intel Processors (Support for Windows 7/ 8.1/ 10/ Linux)

Intel Pentium G4400 Processor (Dual Core/ 3MB/ 2T/ 3.3GHz/ 47W)
Intel Core i3-6100 Processor (Dual Core/ 3MB/ 4T/ 3.7GHz/ 47W)
Intel Core i5-6500 Processor (Quad Core/ 6MB/ 4T/ 3.2GHz/ 65W)
Intel Core i5-6600 Processor (Quad Core/ 6MB/ 4T/ 3.3GHz/ 65W)
Intel Core i7-6700 Processor (Quad Core/ 8MB/ 8T/ 3.4GHz/ 65W)

Skylake — 6th Generation Intel Core processors

Intel Skylake is the successor to the Intel Broadwell processor. It is a micro architecture redesign using an existing process technology and it is branded as Intel 6th generation Core. Like Broadwell, Skylake is available in four variants with suffixes SKL-Y, SKL-H, SKL-U, and SKL-S.

The Skylake also includes Core i7, i5, i3, and Pentium, processors.

Skylake specifications

Table 3. Skylake specifications for OptiPlex 5250 AIO

Processor number	Clock Speed	Cache	No. of cores/No. of threads	Power
Intel Pentium G4400	3.3 GHz	3 MB	4/4	47 W
Intel Core i3-6100	3.7 GHz	3 MB	4/4	47 W
Intel Core i5-6500	3.2 GHz	6 MB	4/4	65 W
Intel Core i5-6600	3.3 GHz	6 MB	4/4	65 W
Intel Core i7-6700	3.4 GHz	8 MB	4/4	65 W

Kaby Lake — 7th Generation Intel Core processors

The 7th Gen Intel Core processor (Kaby Lake) family is the successor of 6th generation processors (Skylake). Its main features include:

- Intel 14 nm Manufacturing Process Technology
- Intel Turbo Boost Technology
- Intel Hyper Threading Technology
- Intel Built-in Visuals
 - Intel HD graphics - exceptional videos, editing smallest details in the videos
 - Intel Quick Sync Video - excellent video conferencing capability, quick video editing and authoring
 - Intel Clear Video HD - visual quality and color fidelity enhancements for HD playback and immersing web browsing
- Integrated memory controller
- Intel Smart Cache
- Optional Intel vPro technology (on i5/i7) with Active Management Technology 11.6
- Intel Rapid Storage Technology

Kaby Lake specifications

Table 4. Kaby Lake specifications

Processor number	Clock Speed	Cache	No. of cores/No. of threads	Power
Intel Pentium G4560	3,5 GHz	3 MB	4/4	54 W
Intel Core i3-7100	3.9 GHz	3 MB	4/4	51 W
Intel Core i5-7500	3.4 GHz	6 MB	4/4	65 W
Intel Core i5-7600	3.5 GHz	6 MB	4/4	65 W
Intel Core i7-7700	3.6 GHz	8 MB	8	65 W

Identifying processors in Windows 10

- 1 Tap **Search the Web and Windows**.
- 2 Type `Device Manager`.



- 3 Tap **Processor**.

Identifying processors in Windows 7

- 1 Click **Start > Control Panel > Device Manager**.
- 2 Select **Processor**.

Chipsets

All laptops or notebook communicate with the CPU through the chipset. This laptop is shipped with the Intel 100 Series chipset .

Identifying the chipset in Device Manager on Windows 10

- 1 Click **All Settings**  on the Windows 10 Charms Bar.
- 2 From the **Control Panel**, select **Device Manager**.
- 3 Expand **System Devices** and search for the chipset.

Storage options

This topic details the supported storage options.

Hard drives

Table 5. Hard drive

- 2.5" 500 GB SATA 5400 RPM Hard Disk Drive
- 2.5" 500 GB SATA 7200 RPM Hard Disk Drive
- 2.5" 500 GB SATA 5400 RPM Solid State Hybrid Drive with 8 GB Flash
- 2.5" 500 GB SATA 7200 RPM Self Encrypting Drive (OPAL FIPS)
- 2.5" 1.0 TB SATA 7200 RPM Hard Disk Drive
- 2.5" 1.0 TB SATA 5400 RPM Solid State Hybrid Drive w/ 8GB Flash
- 2.5" 2.0 TB SATA 5400 RPM Hard Disk Drive

Solid State Drives (SSD)

Table 6. SSD

- 2.5" 256 GB SATA Solid State Drive Class 20
- 2.5" 512 GB SATA Solid State Drive Class 20
- M.2 128 GB SATA Solid State Drive Class 20
- M.2 256 GB PCIe NVMe Solid State Drive Class 40
- M.2 256 GB PCIe NVMe Self Encrypting Solid State Drive Class 40

- M.2 512 GB PCIe NVMe Solid State Drive Class 40
- M.2 1 TB PCIe NVMe Solid State Drive Class 40

Identifying the hard drive in Windows 10

- 1 Click **All Settings**  on the Windows 10 Charms Bar.
- 2 Click **Control Panel**, select **Device Manager**, and expand **Disk drives**.
The hard drive is listed under **Disk drives**.

Entering BIOS setup

- 1 Turn on or restart your laptop.
- 2 When the Dell logo appears, perform one of the following actions to enter the BIOS setup program:
 - With keyboard — Tap F2 until the **Entering BIOS** setup message appears. To enter the Boot selection menu, tap F12.
Hard drive is listed under the **System Information** under the **General** group.

Memory configurations

The supported memory configurations for are as follows:

- 2GB DDR4, 2400MHz, (1 x 2GB)- Linux operating system only
- 4GB DDR4, 2400MHz, (1 x 4GB)
- 8GB DDR4, 2400MHz, (1 x 8GB)
- 8GB DDR4, 2400MHz, (2 x 4GB)
- 16GB DDR4, 2400MHz, (2 x 8GB)
- 32GB DDR4, 2400MHz, (2 x 16GB)

 **NOTE:** If this computer is purchased with Intel 6th Generation CPUs, the maximum MHz the computer can achieve is 2133.

Verifying system memory in Windows 10 and Windows 7

Windows 10

- 1 Click the **Windows** button and select **All Settings**  > **System**.
- 2 Under **System**, click **About**.

Windows 7

- Click **Start** → **Control Panel** → **System**.



DDR4

DDR4 (double data rate fourth generation) memory is a higher-speed successor to the DDR2 and DDR3 technologies and allows up to 512 GB in capacity, compared to the DDR3's maximum capacity of 128 GB per DIMM. DDR4 synchronous dynamic random-access memory is keyed differently from both SDRAM and DDR to prevent the user from installing the wrong type of memory into the system.

DDR4 needs 20 percent less or just 1.2 volts, compared to DDR3 which requires 1.5 volts of electrical power to operate. DDR4 also supports a new, deep power-down mode that allows the host device to go into standby without needing to refresh its memory. Deep power-down mode is expected to reduce standby power consumption by 40 to 50 percent.

Key Specifications

The following table lists the specifications' comparison between DDR3 and DDR4:

Table 7. DDR3 vs DDR4

Feature/Option	DDR3	DDR4	DDR 4 Advantages
Chip Densities	512 Mb-8 Gb	4 Gb-16 Gb	Larger DIMM capacities
Data rates	800 Mb/s-2133 Mb/s	1600 Mb/s-3200 Mb/s	Migration to higher speed I/O
Voltage	1.5 V	1.2 V	Reduced memory power demand
Low voltage standard	Yes (DDR3L at 1.35V)	Anticipated at 1.05V	Memory Power Reductions
Internal banks	8	16	Higher data rates
Bank groups (BG)	0	4	Faster burst accesses
VREF inputs	2 —DQs and CMD/ADDR	1 — CMD/ADDR	VREFDQ Now Internal
tCK — DLL Enabled	300 Mhz-800 Mhz	667Mhz-1.6Ghz	Higher data rates
tCK — DLL Disabled	10MHz – 125MHz (optional)	Undefined to 125MHz	DLL-off now fully supported
Read Latency	AL+CL	AL+CL	Expanded values
Write Latency	AL+CWL	AL+CWL	Expanded values
DQ Driver (ALT)	40&Omega	48&Omega	Optimal for PtP Applications
DQ Bus	SSTL15	POD12	Less I/O Noise and Power
RTT Values (in &Omega)	120,60,40,30,20	240,120,80,60,48,40,34	Support for higher data rates
RTT not allowed	READ Bursts	Disables during READ Bursts	Ease of use
ODT Modes	Nominal, Dynamic	Nominal, Dynamic, Park	Add'l Control Mode; OTF Value Change
ODT Control	ODT Signaling Required	ODT Signaling Not Required	Ease of ODT Control; Allows Non-ODT Routing, PtP Apps
Multi-Purpose Register	Four Registers – 1 Defined, 3 RFU	Four Registers – 3 Defined, 1 RFU	Provides Additional Specialty Readout
DIMM Types	RDIMM, LRDIMM, UDIMM, SODIMM	RDIMM, LRDIMM, UDIMM, SODIMM	
DIMM Pins	240 (R, LR, U); 204 (SODIMM)	288 (R, LR, U); 260 (SODIMM)	



Feature/Option	DDR3	DDR4	DDR 4 Advantages
RAS	ECC	CRC, Parity, Addressability, GDM	More RAS features; improved data integrity

DDR4 Details

There are subtle differences between DDR3 and DDR4 memory modules, as listed below.

Key notch difference

The key notch on a DDR4 module is in a different location from the key notch on a DDR3 module. Both notches are on the insertion edge, but the notch location on the DDR4 is slightly different, to prevent the module from being installed into an incompatible board or platform.

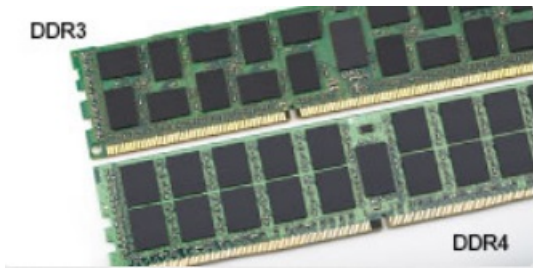

Figure 1. Notch difference

Increased thickness

DDR4 modules are slightly thicker than DDR3, to accommodate more signal layers.

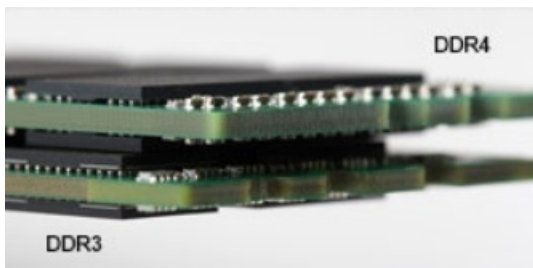

Figure 2. Thickness difference

Curved edge

DDR4 modules feature a curved edge to help with insertion and alleviate stress on the PCB during memory installation.



Figure 3. Curved edge

System setup

System Setup enables you to manage your computer hardware and specify BIOS level options. From the System Setup, you can:

- Change the NVRAM settings after you add or remove hardware
- View the system hardware configuration
- Enable or disable integrated devices
- Set performance and power management thresholds
- Manage your computer security

Topics:

- [Boot Sequence](#)
- [Navigation keys](#)
- [System setup options](#)
- [System setup options](#)
- [Updating the BIOS](#)
- [System and setup password](#)

Boot Sequence

Boot Sequence allows you to bypass the System Setup–defined boot device order and boot directly to a specific device (for example: optical drive or hard drive). During the Power-on Self Test (POST), when the Dell logo appears, you can:

- Access System Setup by pressing F2 key
- Bring up the one-time boot menu by pressing F12 key

The one-time boot menu displays the devices that you can boot from including the diagnostic option. The boot menu options are:

- Removable Drive (if available)
- STXXXX Drive

 **NOTE: XXX denotes the SATA drive number.**

- Optical Drive (if available)
- Diagnostics

 **NOTE: Choosing Diagnostics, will display the ePSA diagnostics screen.**

The boot sequence screen also displays the option to access the System Setup screen.

Navigation keys

 **NOTE: For most of the System Setup options, changes that you make are recorded but do not take effect until you restart the system.**

Keys	Navigation
Up arrow	Moves to the previous field.

Keys	Navigation
Down arrow	Moves to the next field.
Enter	Selects a value in the selected field (if applicable) or follow the link in the field.
Spacebar	Expands or collapses a drop-down list, if applicable.
Tab	Moves to the next focus area.
	 NOTE: For the standard graphics browser only.
Esc	Moves to the previous page until you view the main screen. Pressing Esc in the main screen displays a message that prompts you to save any unsaved changes and restarts the system.
F1	Displays the System Setup help file.

System setup options

 **NOTE: Depending on the computer and its installed devices, the items listed in this section may or may not appear.**

System setup options

 **NOTE: Depending on the computer and its installed devices, the items listed in this section may or may not appear.**

General screen options

This section lists the primary hardware features of your computer.

Option	Description
System Information	<p>This section lists the primary hardware features of your computer.</p> <ul style="list-style-type: none"> • System Information: Displays BIOS Version, Service Tag, Asset Tag, Ownership Tag, Ownership Date, Manufacture Date, and the Express Service Code. • Memory Information: Displays Memory Installed, Memory Available, Memory Speed, Memory Channels Mode, Memory Technology, DIMM 1 Size, DIMM 2 Size, • PCI Information: Displays SLOT 1 and SLOT_M.2 • Processor Information: Displays Processor Type, Core Count, Processor ID, Current Clock Speed, Minimum Clock Speed, Maximum Clock Speed, Processor L2 Cache, Processor L3 Cache, HT Capable, and 64-Bit Technology. • Device Information: Displays Primary Hard Drive, M.2 SATA2, M.2 SATA, M.2 PCIe SSD-0, LOM MAC Address, Video Controller, Video BIOS Version, Video Memory, Panel Type, Native Resolution, Audio Controller, Wi-Fi Device, WiGig Device, Cellular Device, Bluetooth Device.
Battery Information	Displays the battery status and the type of AC adapter connected to the computer.
Boot Sequence	<p>Allows you to change the order in which the computer attempts to find an operating system.</p> <ul style="list-style-type: none"> • Diskette Drive • Internal HDD • USB Storage Device • CD/DVD/CD-RW Drive • Onboard NIC
Advanced Boot Options	This option allows you the legacy option ROMs to load. By default, the Enable Legacy Option ROMs is disabled.





Option	Description
UEFI Booth Path Security	<p>This options controls whether or not the system will prompt the user to enter the Admin password when booting a UEFI boot path from the F12 Boot Menu.</p> <ul style="list-style-type: none"> · Always, Except Internal HDD · Always · Never: This option is enabled by default.
Date/Time	Allows you to change the date and time.

System configuration screen options





Option	Description
Integrated NIC	<p>If you enable UEFI network stack, UEFI network protocols will be available. UEFI network allows pre-os and early os networking features to use NICs that are enabled. This may be used without PXE turned on. When you enable Enabled w/PXE, the type of PXE boot (Legacy PXE or UEFI PXE) depends on the current boot mode and type of option ROMs in use. The UEFI Network Stack is required in order to have UEFI PXE functionality fully enabled.</p> <ul style="list-style-type: none"> · Enabled UEFI Network Stack - This option is disabled by default. <p>Allows you to configure the integrated network controller. The options are:</p> <ul style="list-style-type: none"> · Disabled · Enabled · Enabled w/PXE: This option is enabled by default. <p>NOTE: Depending on the computer and its installed devices, the items listed in this section may or may not appear.</p>
SATA Operation	<p>Allows you to configure the internal SATA hard-drive controller. The options are:</p> <ul style="list-style-type: none"> · Disabled · AHCI: This option is enabled by default.
Drives	<p>Allows you to configure the SATA drives on board. All drives are enabled by default. The options are:</p> <ul style="list-style-type: none"> · SATA-0 · SATA-1 · SATA-2 · SATA-3 · SATA-4
SMART Reporting	<p>This field controls whether hard drive errors for integrated drives are reported during system startup. This technology is part of the SMART (Self Monitoring Analysis and Reporting Technology) specification. This option is disabled by default.</p> <ul style="list-style-type: none"> · Enable SMART Reporting
USB Configuration	<p>This field configures the integrated USB controller. If Boot Support is enabled, the system is allowed to boot any type of USB Mass Storage Devices (HDD, memory key, floppy).</p> <p>If USB port is enabled, device attached to this port is enabled and available for OS.</p>

Option	Description
	<p>If USB port is disabled, the OS cannot see any device attached to this port.</p> <p>The options are:</p> <ul style="list-style-type: none"> · Enable Boot Support · Enable Rear USB Ports: Include options for 6 ports · Enable Front USB Ports: Include options for 2 ports <p>All the options are enabled by default.</p> <p> NOTE: USB keyboard and mouse always work in the BIOS setup irrespective of these settings.</p>
Side USB Configuration	<p>This field allows you to enable or disable side USB ports.</p> <ul style="list-style-type: none"> · Side Port1 (Top) · Side Port2 (Bottom)
Rear USB Configuration	<p>This field allows you to enable or disable rear USB ports.</p> <ul style="list-style-type: none"> · Rear Port (Rear Right) · Rear Port 2 (Front Right) · Rear Port 3 (Rear Left) (Rear Port 4 (Front Left))
Audio	<p>This field enables or disables the integrated audio controller. By default, the Enable Audio option is selected. The options are:</p> <ul style="list-style-type: none"> · Enable Microphone (by default enable) · Enable Internal Speaker (by default enable)
OSD Button Management	<p>This field allows you to enable or disable the OSD (On-Screen Display) buttons on the All-In-One system.</p> <p>This option is disabled by default.</p>
Touchscreen	<p>This option allows you to enable or disable touchscreen.</p>
Miscellaneous Devices	<p>Allows you to enable or disable the following devices:</p> <ul style="list-style-type: none"> · Enable PCI Slot (enabled by default) · Enable Secure Digital (SD) card (enabled by default) · Secure Digital (SD) Card Boot

Security screen options

Option	Description
Admin Password	<p>Allows you to set, change, or delete the administrator (admin) password.</p> <p> NOTE: You must set the admin password before you set the system or hard drive password. Deleting the admin password automatically deletes the system password and the hard drive password.</p> <p> NOTE: Successful password changes take effect immediately.</p>



Option	Description
	Default setting: Not set
System Password	Allows you to set, change or delete the system password.
	 NOTE: Successful password changes take effect immediately.
	Default setting: Not set
Strong Password	Allows you to enforce the option to always set strong passwords.
	Default Setting: Enable Strong Password is not selected.
	 NOTE: If Strong Password is enabled, Admin and System passwords must contain at least one uppercase character, one lowercase character and be at least 8 characters long.
Password Configuration	Allows you to determine the minimum and maximum length of Administrator and System passwords.
Password Bypass	Allows you to enable or disable the permission to bypass the System and the Internal HDD password, when they are set. The options are:
	<ul style="list-style-type: none"> · Disabled · Reboot bypass
	Default setting: Disabled
Password Change	Allows you to enable the disable permission to the System and Hard Drive passwords when the admin password is set.
	Default setting: Allow Non-Admin Password Changes is selected.
UEFI Capsule Firmware Updates	This option controls whether the system allows BIOS updates through UEFI capsule update packages.
	 NOTE: Disabling this option will block the BIOS updates from services such as Microsoft Windows Update and Linux Vendor Firmware Service (LVFS).
	This option is enabled by default.
TPM 2.0 Security	Allows you to enable the Trusted Platform Module (TPM) during POST. This option is enabled by default. The options are:
	<ul style="list-style-type: none"> · TPM On · Clear · PPI Bypass for Enabled Commands · PPI Bypass for Disabled Commands
	 NOTE: Activation, deactivation, and clear options are not affected if you load the setup program's default values. Changes to this option take effect immediately.
Computrace	Allows you to activate or disable the optional Computrace software The options are:
	<ul style="list-style-type: none"> · Deactivate · Disable · Activate
	 NOTE: The Activate and Disable options will permanently activate or disable the feature and no further changes will be allowed

Option	Description
	Default setting: Deactivate
Chassis Intrusion	<p>This field controls the chassis intrusion feature. The options are:</p> <ul style="list-style-type: none"> · Enabled · Disabled · On-slient <p>Default Setting: Disabled</p>
OROM Keyboard Access	<p>Allows you to set an option to enter the Option ROM Configuration screens using hotkeys during boot. The options are:</p> <ul style="list-style-type: none"> · Enabled · One Time Enable · Disabled <p>Default Setting: Enabled</p>
Admin Setup Lockout	<p>Allows you to enable or disable the option to enter setup when an admin password is set.</p> <ul style="list-style-type: none"> · Enable Admin Setup Lockout - This option is disabled by default.
Master Password Lockout	<p>If enabled, this option disables the master password support. The Hard Disk passwords need to be cleared before the setting can be changed. Default setting: Disabled</p>

Secure boot screen options

Option	Description
Secure Boot Enable	<p>This option enables or disables the Secure Boot feature.</p> <ul style="list-style-type: none"> · Disabled · Enabled <p>Default setting: Enabled.</p>
Expert Key Management	<p>Allows you to manipulate the security key databases only if the system is in Custom Mode. The Enable Custom Mode option is disabled by default. The options are:</p> <ul style="list-style-type: none"> · PK · KEK · db · dbx <p>If you enable the Custom Mode, the relevant options for PK, KEK, db, and dbx appear. The options are:</p> <ul style="list-style-type: none"> · Save to File—Saves the key to a user-selected file · Replace from File—Replaces the current key with a key from a user-selected file · Append from File—Adds a key to the current database from a user-selected file · Delete—Deletes the selected key · Reset All Keys—Resets to default setting · Delete All Keys—Deletes all the keys



Option	Description
	 NOTE: If you disable the Custom Mode, all the changes made will be erased and the keys will restore to default settings.

Intel Software Guard Extensions options

Option	Description
Intel SGX Enable	Allows you to enable or disable the Intel Software Guard Extensions to provide a secured environment for running code/storing sensitive information in the context of the main operating system. <ul style="list-style-type: none"> · Disabled (default) · Enabled
Enclave Memory Size	Allows you to set the Intel SGX Enclave Reserve Memory Size. <ul style="list-style-type: none"> · 32 MB · 64 MB · 128 MB

Performance screen options

Option	Description
Multi Core Support	Specifies whether the process will have one or all cores enabled. The performance of some applications will improve with the additional cores. <ul style="list-style-type: none"> · All - This option is enabled by default · 1 · 2 · 3
Intel SpeedStep	Allows you to enable or disable the Intel SpeedStep feature. <ul style="list-style-type: none"> · Enable Intel SpeedStep Default setting: The option is enabled.
C-States Control	Allows you to enable or disable the additional processor sleep states. <ul style="list-style-type: none"> · C states Default setting: The option is enabled.
Limit CPUID Value	Allows you to limit the maximum value of the Standard CPUID function support. Some operation systems will not complete installation when maximum CPUID Function supported is greater than 3. <ul style="list-style-type: none"> · Enable CPUID Limit - This option is disabled by default.
Intel TurboBoost	Allows you to enable or disable the Intel TurboBoost mode of the processor. <ul style="list-style-type: none"> · Enable Intel TurboBoost

Option	Description
	Default setting: The option is enabled.

Power management screen options

Option	Description
AC Recovery	Specifies how the computer will respond when AC power is applied after an AC power loss. You can set the AC Recovery to: <ul style="list-style-type: none"> Power Off (default) Power On Last Power State

Auto On Time	Allows you to set the time at which the computer must turn on automatically. The options are: <ul style="list-style-type: none"> Disabled Every Day Weekdays Select Days
---------------------	--

Default setting: Disabled

NOTE: This feature does not work if you turn off your computer using the switch on a power strip or surge protector or if Auto Power is set to disabled.

Deep Sleep Control	Allows you to define the controls when Deep Sleep is enabled. <ul style="list-style-type: none"> Disabled Enabled in S5 only Enabled in S4 and S5 – This option is enabled by default.
---------------------------	---

USB Wake Support	Allows you to enable USB devices to wake the system from Standby.
-------------------------	---

NOTE: This feature is only functional when the AC power adapter is connected. If the AC power adapter is removed during Standby, the system setup removes power from all the USB ports to conserve battery power.

- Enable USB Wake Support

Default setting: The option is disabled.

Wake on LAN/WLAN	Allows you to enable or disable the feature that powers on the computer from the Off state when triggered by a LAN signal. <ul style="list-style-type: none"> Disabled LAN Only WLAN Only LAN or WLAN LAN with PXE Boot
-------------------------	--

Default setting: Disabled

Block Sleep	This option lets you block entering to sleep (S3 state) in operating system environment.
--------------------	--



Option	Description
	Block Sleep (S3 state) Default setting: This option is disabled
Intel Ready Mode	This option enables the capability of Intel Ready Mode technology.

POST behavior screen options

Option	Description
Numlock LED	Specifies if the NumLock function can be enabled when the system boots. This option is enabled by default.
Keyboard Errors	Specifies whether keyboard related errors are reported when it boots. This option is enabled by default.
Fastboot	Allows you to speed up the boot process by bypassing some of the compatibility steps. The options are: <ul style="list-style-type: none"> Minimal Through (default) Auto
Extended BIOS POST Time	This option creates an additional pre-boot delay and allows you to see the POST status messages. The options are: <ul style="list-style-type: none"> 0 seconds (default) 5 seconds 10 seconds
Full screen Logo	This option displays the full screen logo if your image match the screen resolution. The option is disabled by default.
Warnings and Errors	This option causes the boot process to only pause when warnings or errors detected. The options are: <ul style="list-style-type: none"> Prompt on Warnings and Errors Continue on Warnings Continue on Warnings and Errors

Virtualization support screen options

Option	Description
Virtualization	Allows you to enable or disable the Intel Virtualization Technology. Enable Intel Virtualization Technology (default).
VT for Direct I/O	Enables or disables the Virtual Machine Monitor (VMM) from utilizing the additional hardware capabilities provided by Intel® Virtualization technology for direct I/O. Enable VT for Direct I/O - enabled by default.

Maintenance screen options

Option	Description
Service Tag	Displays the Service Tag of your computer.
Asset Tag	Allows you to create a system asset tag if an asset tag is not already set. This option is not set by default.
SERR Messages	Controls the SERR message mechanism. This option is enabled by default. Some graphics cards require that the SERR message mechanism be disabled.
BIOS Downgrade	<p>This controls flashing of the system firmware to previous revisions.</p> <ul style="list-style-type: none">· Data Wipe· Wipe on Next boot· BIOS recovery· BIOS recovery from the hard drive <p>Follow the procedure to recover BIOS from hard drive.</p> <ol style="list-style-type: none">1 Power on the system.2 While the blue Dell logo is visible, press the F2 key to enter the System Setup.3 Press the Num Lock key, and verify that the Num Lock light is on.4 Press the Caps Lock key, and verify that the Caps Lock light is on.5 Press the Scroll Lock key, and verify that the Scroll Lock light is on.6 Press the Alt + F keys at the same time. The system will beep as the setup defaults are restored.7 Press the Alt + F keys at the same time to restart the system. The changes are automatically saved.
Data Wipe	<p>This field allows your to securely erase data from all internal storage devices. The following is a list of devices affected by this operation:</p> <ul style="list-style-type: none">· Internal HDD· Internal SSD· Internal mSATA· Internal eMMC <p> WARNING: This operation will permanently delete all data from the devices.</p>
BIOS Recovery	This option enable you to recover from certain corrupted BIOS conditions from a recovery file on the primary hard drive or an external USB key.This option is enabled by default.

System Log screen options

Option	Description
BIOS Events	Allows you to view and clear the System Setup (BIOS) POST events.

Updating the BIOS

It is recommended to update your BIOS (system setup), on replacing the system board or if an update is available.

- 1 Re-start the computer.
- 2 Go to dell.com/support.



3 Enter the **Service Tag** or **Express Service Code** and click **Submit**.

NOTE: To locate the **Service Tag**, click **Where is my Service Tag?**

NOTE: If you cannot find your **Service Tag**, click **Detect My Product**. Proceed with the instructions on screen.

4 If you are unable to locate or find the **Service Tag**, click the **Product Category** of your computer.

5 Choose the **Product Type** from the list.

6 Select your computer model and the **Product Support** page of your computer appears.

7 Click **Get drivers** and click **View All Drivers**.

The **Drivers and Downloads** page opens.

8 On the **Drivers and Downloads** screen, under the **Operating System** drop-down list, select **BIOS**.

9 Identify the latest **BIOS** file and click **Download File**.

You can also analyze which drivers need an update. To do this for your product, click **Analyze System for Updates** and follow the instructions on the screen.

10 Select your preferred download method in the **Please select your download method below window**; click **Download File**.

The **File Download** window appears.

11 Click **Save** to save the file on your computer.

12 Click **Run** to install the updated **BIOS** settings on your computer.

Follow the instructions on the screen.

System and setup password

You can create a system password and a setup password to secure your computer.

Password type	Description
System password	Password that you must enter to log on to your system.
Setup password	Password that you must enter to access and make changes to the BIOS settings of your computer.

CAUTION: The password features provide a basic level of security for the data on your computer.

CAUTION: Anyone can access the data stored on your computer if it is not locked and left unattended.

NOTE: Your computer is shipped with the system and setup password feature disabled.

Assigning a system password and setup password

You can assign a new **System Password** only when the status is in **Not Set**.

NOTE: If the password jumper is disabled, the existing **System Password** and **Setup Password** are deleted and you need not provide the system password to log on to the computer.

To enter the system setup, press **F2** immediately after a power-on or re-boot.

1 In the **System BIOS** or **System Setup** screen, select **Security** and press **Enter**.

The **Security** screen is displayed.

2 Select **System Password** and create a password in the **Enter the new password** field.

Use the following guidelines to assign the system password:

- A password can have up to 32 characters.
- The password can contain the numbers 0 through 9.
- Only lower case letters are valid, upper case letters are not allowed.
- Only the following special characters are allowed: space, ("), (+), (.), (-), (.), (/), (:), ([), (\), (]), (`).

3 Type the system password that you entered earlier in the **Confirm new password** field and click **OK**.

- 4 Press Esc and a message prompts you to save the changes.
- 5 Press Y to save the changes.
The computer reboots.

Deleting or changing an existing system and/or setup password

Ensure that the **Password Status** is Unlocked (in the System Setup) before attempting to delete or change the existing System and/or Setup password. You cannot delete or change an existing System or Setup password, if the **Password Status** is Locked. To enter the System Setup, press F2 immediately after a power-on or reboot.

- 1 In the **System BIOS** or **System Setup** screen, select **System Security** and press Enter.
The **System Security** screen is displayed.
- 2 In the **System Security** screen, verify that **Password Status** is **Unlocked**.
- 3 Select **System Password**, alter or delete the existing system password and press Enter or Tab.
- 4 Select **Setup Password**, alter or delete the existing setup password and press Enter or Tab.

NOTE: If you change the System and/or Setup password, re-enter the new password when promoted. If you delete the System and/or Setup password, confirm the deletion when promoted.

- 5 Press Esc and a message prompts you to save the changes.
- 6 Press Y to save the changes and exit from System Setup.
The computer reboots.



Troubleshooting your computer

You can troubleshoot your computer using indicators like diagnostic lights, beep codes, and error messages during the operation of the computer.

Enhanced Pre-Boot System Assessment (ePSA) diagnostics

The ePSA diagnostics (also known as system diagnostics) performs a complete check of your hardware. The ePSA is embedded with the BIOS and is launched by the BIOS internally. The embedded system diagnostics provides a set of options for particular devices or device groups allowing you to:

- Run tests automatically or in an interactive mode
- Repeat tests
- Display or save test results
- Run thorough tests to introduce additional test options to provide extra information about the failed device(s)
- View status messages that inform you if tests are completed successfully
- View error messages that inform you of problems encountered during testing

⚠ CAUTION: Use the system diagnostics to test only your computer. Using this program with other computers may cause invalid results or error messages.

ℹ NOTE: Some tests for specific devices require user interaction. Always ensure that you are present at the computer terminal when the diagnostic tests are performed.

Running the ePSA diagnostics

- 1 Power-on the computer.
- 2 As the computer boots, press the F12 key as the Dell logo appears.
- 3 On the boot menu screen, select the **Diagnostics** option.
The **Enhanced Pre-boot System Assessment** window is displayed, listing all devices detected in the computer. The diagnostics starts running the tests on all the detected devices.
- 4 To run a diagnostic test on a specific device, press Esc and click **Yes** to stop the diagnostic test.
- 5 Select the device from the left pane and click **Run Tests**.
- 6 If there are any issues, error codes are displayed.
Note the error code and contact Dell.

Power supply—built in self test (BIST)

ships with a power supply with the built in self-test (BIST) feature that drives new troubleshooting steps for customers and technicians. All power supply units include a self-test ability in an isolation mode.

Customers can test the health of the power system by pressing the test button. The button is lit by a signal in the power supply called Power_Good (PG). When the +3.3v, +5v, and +12v rails are up and within spec, the PG signal turns on, lighting the self-test LED. By removing the cable harness in units that do not pass this test, the customer, or technician can isolate the failure's cause to an attached device of the power supply.

Power supply BIST button is located near the power supply connector.

LCD built in self test (BIST)

All-in-One (AIO) systems supports LCD BIST similar to any other Dell systems that have BIST test implemented. It allows the user to isolate the LCD during troubleshooting to determine which sub-system is at fault. The main difference is the lack of an integrated keyboard scan controller in the AIO. When BIST is initiated, an internal generated pattern from the LCD will be emitted for user's observation. This pattern will go by sequence through this pattern. Black-White-Red-Green-Blue or a White-Black-Red-Green-Blue where each pattern is emitted for 2 to 3 seconds. The following images displays the pattern of the colors on the LCD.

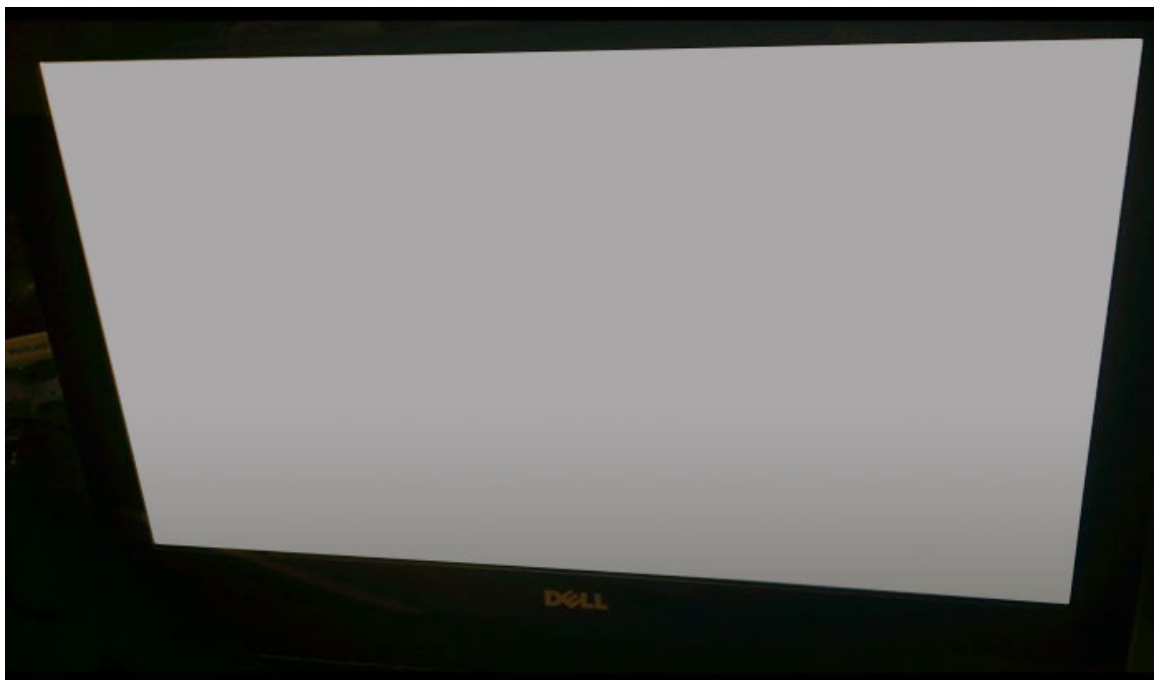

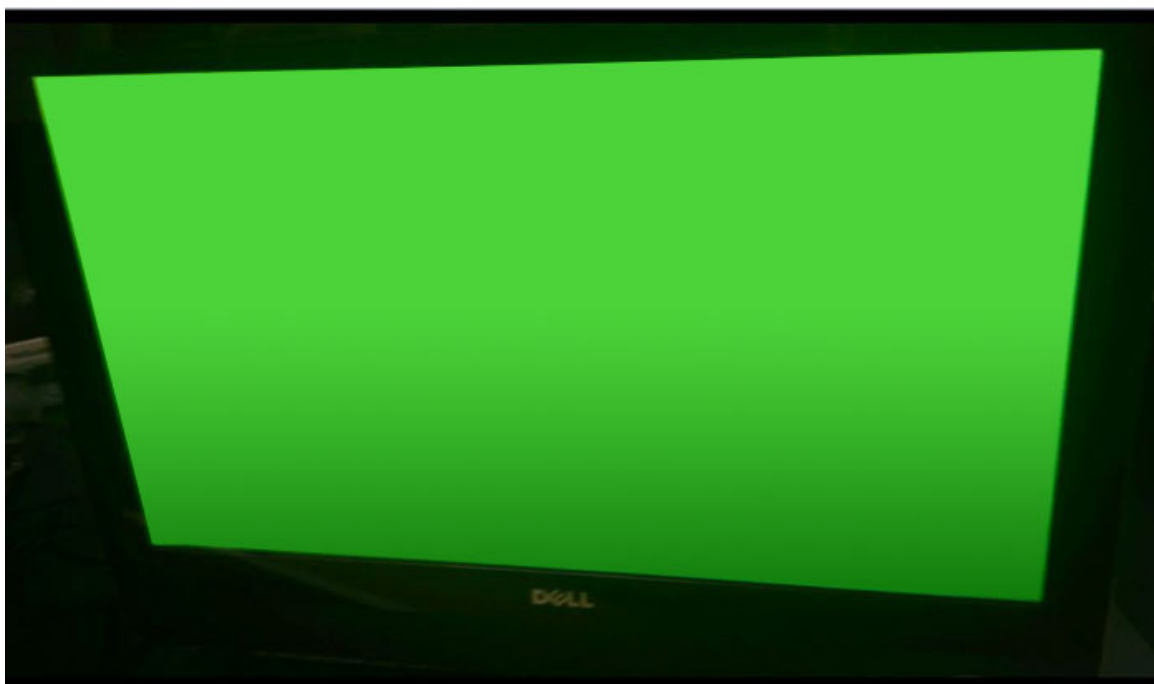

Invoking BIST with user modes



There are two methods to invoke the LCD BIST .

- OSD Toggle
- ePSA

OSD toggle

The first method of user initiation is via OSD toggle button. The user should press the OSD toggle button and hold it in while the power button is applied to turn the AIO on. This is the hardware-initiated method that does not require the CPU and BIOS to be functional. The panel will stay in BIST mode until the BIOS reboots the system. The test duration is approximately 20 seconds which allows 2 cycles of color bar patterns.

To invoke the BIST test via OSD Toggle:

- 1 Press and hold down the OSD toggle button.
- 2 Press the power button to turn on the computer while holding down on the OSD toggle button.

NOTE: The OSD toggle is located at the right side of the chassis, just above the Hard Disk indicator light.

ePSA

The second method to troubleshoot is via ePSA entry. The user initiates a Pre-Boot POST via F12 function key and the system enters ePSA. The ePSA menu will have an LCD BIST selection that asserts the proper signals via BIOS commands. The BIST mode will loop for





approximately 20 seconds giving 2 cycles of color bar patterns that the user can observe. The time period is controlled by BIOS. After the time period, the BIOS will return the system to the ePSA menu.



Technical specifications

NOTE: Offerings may vary by region. For more information regarding the configuration of your computer in:

- Windows 10, click or tap **Start**  > **Settings** > **System** > **About**.
- Windows 8.1 and Windows 8, from the charms sidebar, click or tap **Settings** > **Change PC settings**. In the **PC Settings** window, select **PC and devices** > **PC Info**.
- Windows 7, click **Start** , right-click **My Computer**, and then select **Properties**.

Topics:

- System specifications
- Memory specifications
- Video specifications
- Audio specifications
- Communication specifications
- Cards specifications
- Display specifications
- Drives specifications
- Port and connector specifications
- Power specifications
- Camera (optional) specifications
- Stand specifications
- Physical specifications
- Environmental specifications

System specifications

Feature	Specification
Processor cache	Intel Core i3/ i5 / i7 series
Total cache	Up to 8 MB cache depending on processor type
Chipset	Intel Q170 chipset

Memory specifications

Feature	Specification
Memory type	up to 1600 MHz, unbuffered non-ECC, dual-channel DDR4 2133 configuration
Memory capacity	4 GB and 8 GB



Feature	Specification
Memory connectors	two internally-accessible DDR4 SODIMM sockets
Minimum memory	4 GB
Maximum memory	16 GB

Video specifications

Feature	Specification
Video Controller (Integrated)	Integrated Intel HD Graphics (Gen 9 iGfx), 2GB GDDR5 for dGPU
Video Memory	shared memory
External display support	Display port, HDMI in and HDMI out

Audio specifications

Feature	Specification
Controller	Intel High Definition Audio with Waves MaxxVoice Pro
Speaker	single 4-ohms speakers in both the left and right speaker assembly (4 W average per channel)
Internal speaker amplifier	up to 7.6 W at 4-ohm per channel
Internal microphone support	dual digital microphone
Volume controls	Volume up/down buttons, program menus, and keyboard media-control keys

⚠ WARNING: Excessive sound pressure from earphones or headphones can cause hearing damage or loss. Adjustment of the volume control as well as the equalizer to settings other than the center position may increase the earphones or headphones output voltage, and therefore the sound pressure level. The use of factors influencing the earphones or headphones output other than those specified by the manufacturer (e.g. operating system, equalizer software, firmware, driver, etc.) may increase the earphones or headphones output voltage and therefore the sound pressure level. The use of earphones or headphones other than those specified by the manufacturer may lead to heightened sound pressure level.

Communication specifications

Features	Specification
Network adapter	Intel 10/100/1000 Mbps RJ-45 Ethernet
Wireless	<ul style="list-style-type: none"> M.2 2230 card combo M.2 card (Intel Wireless 8260 M.2 PCIe WLAN card (802.11n/ac) with Bluetooth)

Cards specifications

Feature	Specification
M.2 slots	<ul style="list-style-type: none">· One 2230 D3 Key-A M.2 Socket 1· One 2280 D3 Key-M M.2 Socket 3

Display specifications

Drives specifications

Feature	Specification
Hard drive	one 2.5-inch SATA drive with an adapter bracket and one 2.5-inch SATA drive (optional)
Optical drive (optional)	one DVD-ROM SATA drive or DVD+/- RW SATA drive

Port and connector specifications

Feature	Specification
Audio	<ul style="list-style-type: none">· one line-out connector at rear· one global headset port at side
Network adapter	One RJ-45 connector
USB 2.0 (Front/Rear)	0(side)/2
USB 3.0 (Front/Rear)	2(side)/4
USB port with PowerShare support	1(side) USB 3.0
Video	one display port
HDMI	<ul style="list-style-type: none">· one 19-pin output port· one 19-pin input port
Media card reader	one 4-in-1 slot

Power specifications

Feature	Specification
155 Watt PSU for UMA	
200 Watt dGPU and UHD(4K)	



Feature	Specification
Frequency	47 Hz — 63 Hz
Voltage	90 VAC — 264 VAC
Input current	<ul style="list-style-type: none"> Maximum 2.6 A (Low AC range) Maximum 1.3 A (High AC range)

Camera (optional) specifications

Feature	Specification
Image resolution	2.0 megapixel
Video resolution	FHD (1080p)
Diagonal viewing angle	74 degrees

Stand specifications

Feature	Specification
Tilt	–5 degrees to 30 degrees

Physical specifications

Feature	Specification
Width	575.24 mm (22.65 inches)
Height	392.90 mm (15.47 inches)
Depth:	
Non-touch	62.79 mm (2.47 inches)
Touch	62.79 mm (2.47 inches)
Weight:	
Non-touch	9.76 kg with stand (21.52 lb)
Touch	11.00 kg with stand (24.25 lb)

NOTE: The weight of your computer may vary depending on the configuration ordered and the manufacturing variability.

Environmental specifications

Temperature	Specifications
Operating	0°C to 35°C (50°F to 95°F)
Storage	–40°C to 65°C (–40°F to 149°F)
Relative humidity (maximum)	
Operating	20 % to 80 % (non condensing)

Relative humidity (maximum) Specifications

Storage 20 % to 80 % (non condensing)

Maximum vibration Specifications

Operating 0.26 GRMS at 5 to 350 Hz

Storage 2.2 GRMS at 5 to 500 Hz

Maximum shock Specifications

Operating 40 G

Storage 45 G

Altitude (maximum) Specifications

Operating 0 m to 5000 m (0 ft to 16,404 ft)

Non-operating 0 m to 5000 m (0 ft to 16,404 ft)

Airborne contaminant level G2 or lower as defined by ANSI/ISA-S71.04-1985



Contacting Dell

NOTE: If you do not have an active Internet connection, you can find contact information on your purchase invoice, packing slip, bill, or Dell product catalog.

Dell provides several online and telephone-based support and service options. Availability varies by country and product, and some services may not be available in your area. To contact Dell for sales, technical support, or customer service issues:

- 1 Go to **Dell.com/support**.
- 2 Select your support category.
- 3 Verify your country or region in the **Choose a Country/Region** drop-down list at the bottom of the page.
- 4 Select the appropriate service or support link based on your need.