

PHILIPS

Blu-ray disc /
DVD player

BDP3290B

Blu-ray
3D™

User manual

使用手冊

Manual pengguna

คู่มือผู้ใช้

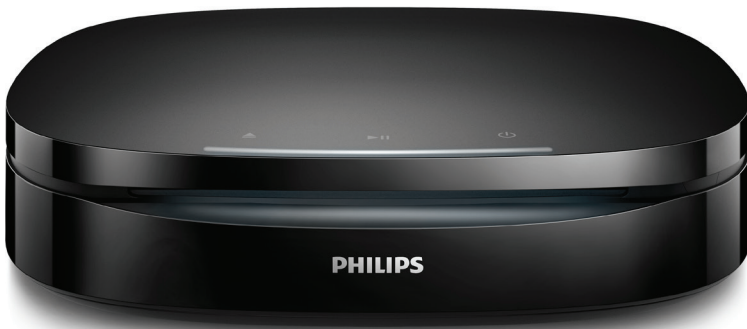

Register your product and get support at
www.philips.com/support

English

Safety and important notice

Read and understand all instructions before you use this Blu-ray disc/ DVD player. If damage is caused by failure to follow the instructions, the warranty does not apply.

Safety

Risk of electric shock or fire!

- Before you make or change any connections, make sure that all devices are disconnected from the power outlet.
- Never expose the product and accessories to rain or water. Never place liquid containers, such as vases, near the product. If liquids are spilled on or into the product, disconnect it from the power outlet immediately. Contact Philips Consumer Care to have the product checked before use.
- Never place the product and accessories near naked flames or other heat sources, including direct sunlight.
- Never insert objects into the ventilation slots or other openings on the product.
- Where the mains plug or an appliance coupler is used as the disconnect device, the disconnect device shall remain readily operable.
- Batteries (battery pack or batteries installed) shall not be exposed to excessive heat such as sunshine, fire or the like.

- Disconnect the product from the power outlet before lightning storms.
- When you disconnect the power cord, always pull the plug, never the cable.

Risk of short circuit or fire!

- For identification and supply ratings, see the type plate at the back or bottom of the product.
- Before you connect the product to the power outlet, ensure that the power voltage matches the value printed on the back or bottom of the product. Never connect the product to the power outlet if the voltage is different.

Risk of injury or damage to the product!

- For wall mounting, this product must be securely attached to the wall in accordance with the installation instructions. Use only the supplied wall mount bracket (if available). Improper wall mounting may result in accident, injury or damage. If you have any query, contact Consumer Care in your country.
- Visible and invisible laser radiation when open. Avoid exposure to beam.
- Do not touch the disc optical lens inside the disc compartment.
- Never place the product or any objects on power cords or on other electrical equipment.
- If the product is transported in temperatures below 5°C, unpack the product and wait until its temperature matches room temperature before connecting it to the power outlet.

Risk of overheating!

- Never install this product in a confined space. Always leave a space of at least four inches around the product for ventilation. Make

sure that curtains or other objects never cover the ventilation slots on the product.

Risk of contamination!

- Do not mix batteries (old and new or carbon and alkaline, etc.).
- Danger of explosion if batteries are incorrectly replaced. Replace only with the same or equivalent type.
- Remove batteries if they are exhausted or if the remote control is not to be used for a long time.
- Batteries contain chemical substances, they should be disposed of properly.

Risk of swallowing batteries!

- The product/remote control may contain a coin/button type battery, which can be swallowed. Keep the battery out of reach of children at all times! If swallowed, the battery can cause serious injury or death. Severe internal burns can occur within two hours of ingestion.
- If you suspect that a battery has been swallowed or placed inside any part of the body, seek immediate medical attention.
- When you change the batteries, always keep all new and used batteries out of reach of children. Ensure that the battery compartment is completely secure after you replace the battery.
- If the battery compartment cannot be completely secured, discontinue use of the product. Keep out of reach of children and contact the manufacturer.



This is CLASS II apparatus with double insulation, and no protective earth provided.



Use only the power supplies listed in the user manual.



3D health warning

- If you or your family has a history of epilepsy or photosensitive seizures, consult a medical professional before exposing yourself to flashing light sources, rapid image sequences or 3D viewing.
- To avoid discomfort such as dizziness, headache or disorientation, we recommend not watching 3D for extended periods of time. If you experience any discomfort, stop watching 3D and do not immediately engage in any potentially hazardous activity (for example driving a car) until your symptoms have disappeared. If symptoms persist, do not resume watching 3D without consulting a medical professional first.
- Parents should monitor their children during 3D viewing and ensure they do not experience any discomfort as mentioned above. Watching 3D is not recommended for children under 6 years of age as their visual system is not fully developed yet.

Care for your product

- Do not insert any objects other than discs into the disc compartment.
- Do not insert warped or cracked discs into the disc compartment.
- Remove discs from the disc compartment if you are not using the product for an extended period of time.
- Only use microfiber cloth to clean the product.

Care of the environment

Disposal of your old product



Your product is designed and manufactured with high quality materials and components, which can be recycled and reused.

Do not throw away the product with the normal household waste at the end of its life, but hand it in at an official collection point or recycling. By doing this, you help to preserve the environment.

Copyright



**Be responsible
Respect copyrights**

This item incorporates copy protection technology that is protected by U.S. patents and other intellectual property rights of Rovi Corporation. Reverse engineering and disassembly are prohibited.

This product incorporates proprietary technology under license from Verance Corporation and is protected by U.S. Patent 7,369,677 and other U.S. and worldwide patents issued and pending as well as copyright and trade secret protection for certain aspects of such technology. Cinavia is a trademark of Verance Corporation. Copyright 2004–2013 Verance Corporation. All rights reserved by Verance. Reverse engineering or disassembly is prohibited.

Cinavia notice

This product uses Cinavia technology to limit the use of unauthorized copies of some commercially-produced film and videos and their soundtracks. When a prohibited use of an unauthorized copy is detected, a message will be displayed and playback or copying will be interrupted.

More information about Cinavia technology is provided at the Cinavia Online Consumer Information Center at <http://www.cinavia.com>. To request additional information about Cinavia by mail, send a postcard with your mailing address to: Cinavia Consumer Information Center, P.O. Box 86851, San Diego, CA, 92138, USA.

Open source software

Philips Electronics Hong Kong hereby offers to deliver, upon request, a copy of the complete corresponding source code for the copyrighted open source software packages used in this product for which such delivery is requested by the respective licenses. This offer is valid up to three years after product purchase to anyone in receipt of this information. To obtain source code, please send your request in English with product

type to open.source@philips.com. If you prefer not to use email or if you do not receive confirmation receipt within 2 weeks after mailing to this email address, please write in English to “Open Source Team, Philips Intellectual Property & Standards, P.O. Box 220, 5600 AE Eindhoven, The Netherlands”. If you do not receive timely confirmation of your letter, please email to the email address above. The texts of the licenses and acknowledgements for open source software used in this product are included on a separate leaflet.

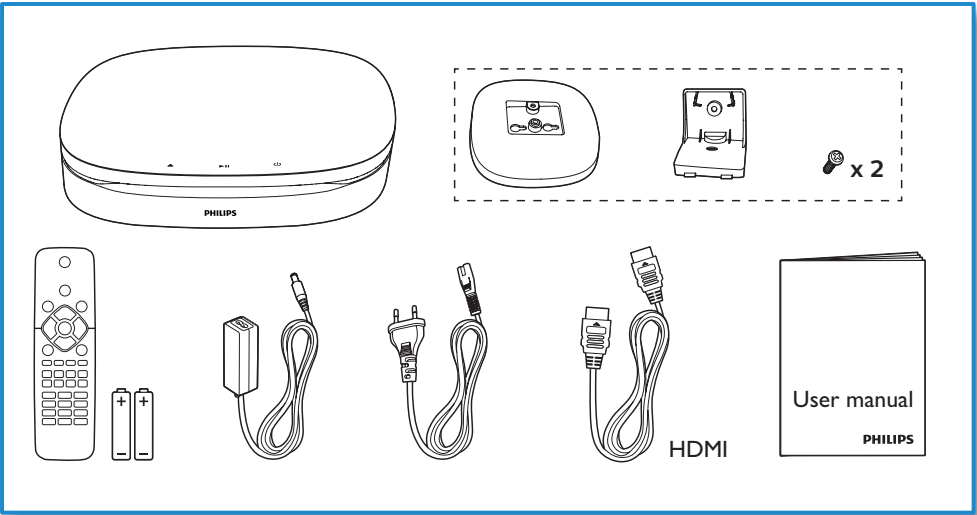

1

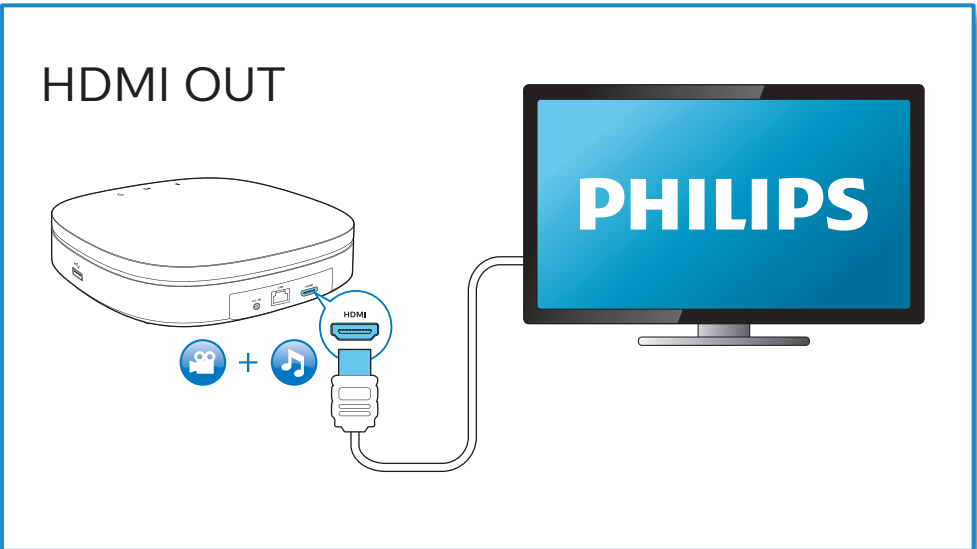

2

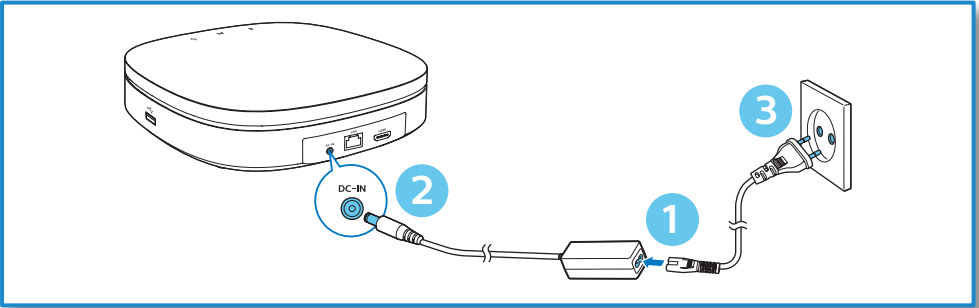

3

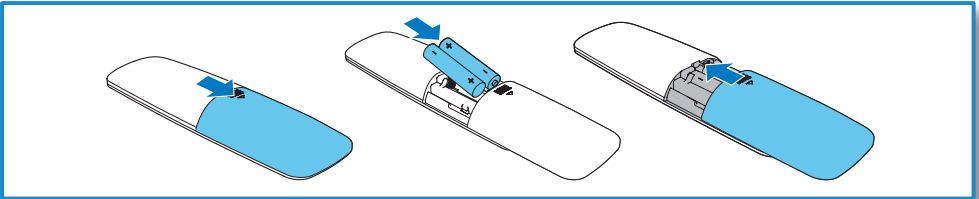

4

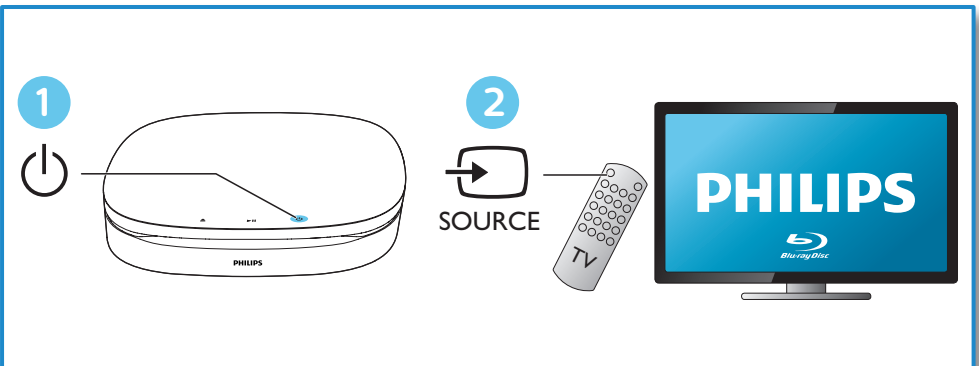

5

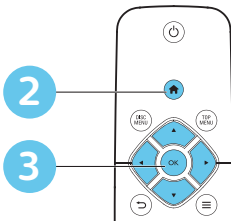
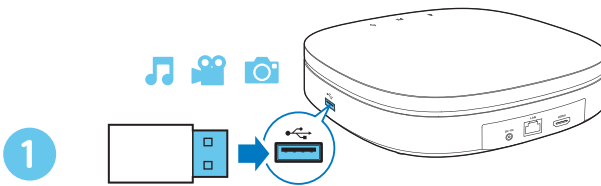
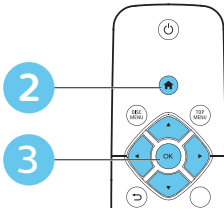
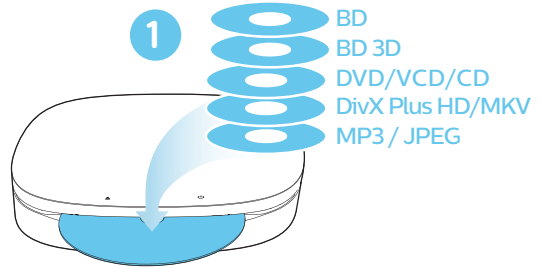

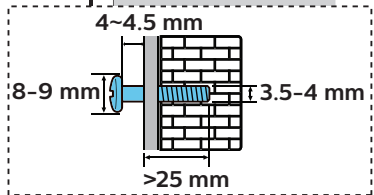
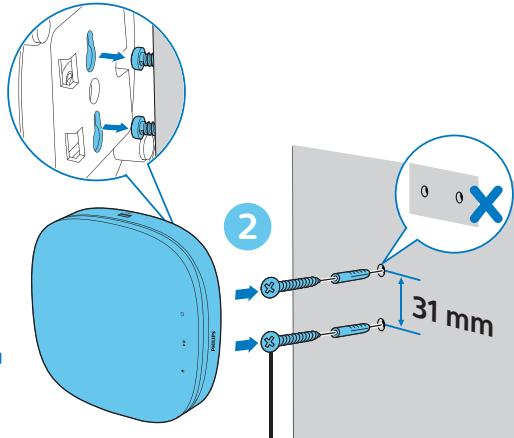
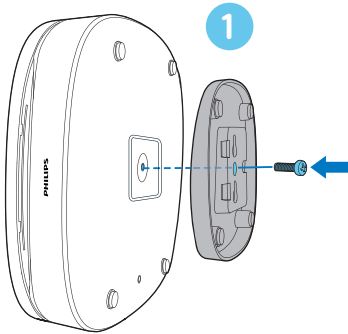
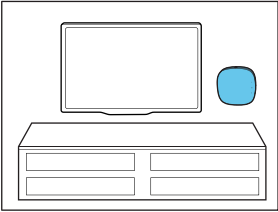
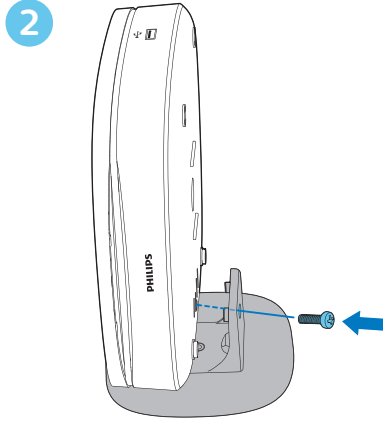
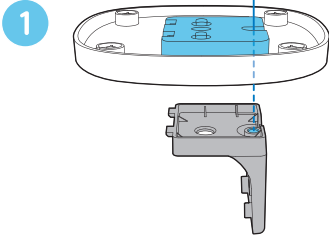
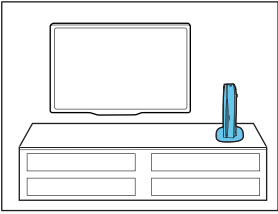

Contents

1 Use your Blu-ray disc/ DVD player	2
Basic play control	2
“Smile” light indication	3
Video, audio and picture options	3
DivX videos	4
Play a musical slideshow	5
Auto play	5
BonusView on Blu-ray	6
BD-Live on Blu-ray	6
Play a Blu-ray 3D video	6
Set up a network	7
Use Philips EasyLink	7

2 Change settings	8
Picture	8
Sound	8
Network (installation, status...)	8
Preference (languages, parental control...)	9
Advanced options (clear memory...)	9

3 Update software	10
Update software via USB	10

4 Optional placement	11
Vertical placement	11
Wall mount	11

5 Product specifications	12
---------------------------------	----

6 Troubleshooting	15
--------------------------	----

1 Use your Blu-ray disc/ DVD player

Congratulations on your purchase, and welcome to Philips! To fully benefit from the support that Philips offers (e.g. product software upgrade), register your product at www.philips.com/welcome.

Basic play control

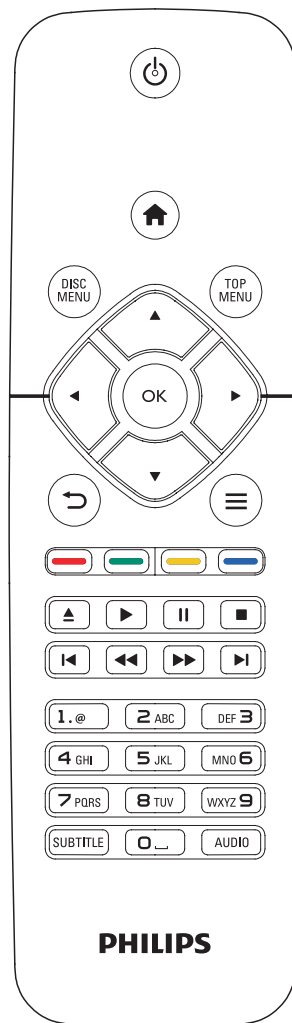

During play, press the following buttons to control.

Button	Action
	Turn on the player, or switch to standby.
	Access the home menu.

Button	Action
DISC MENU	Access or exit the disc menu or Pop-up menu.
TOP MENU	Access the main menu of a video disc.
▲▼◀▶	Navigate the menus. Press ▲▼ to rotate a picture clockwise or counter-clockwise during slideshow.
OK	Confirm a selection or entry.
↶	Return to a previous display menu.
☰	Access more options during play.
Color buttons	Select tasks or options for Blu-ray discs.
▲	Eject a disc from the disc compartment.
▶	Start or resume play.
	Pause play. Press repeatedly to slow forward frame by frame.
■	Stop play.
◀/▶	Skip to the previous or next track, chapter or file.
◀◀/▶▶	Fast backward or forward. Press repeatedly to change the search speed. Press once, and then press ▶▶ to slow forward.
AUDIO	Select an audio language or channel.
SUBTITLE	Select a subtitle language.
Alphanumeric buttons	Select an item to play. Enter values. Enter letters via SMS style entry.

“Smile” light indication

This product is designed with an animated light strip to form an expression of this product’s current status.

- **Light off:** standby.
- **Light on:** power on and ready.
- **Light dim:** playback in progress.
- **2 lights flashing:** Error or unable to read disc.
- **Other light animation:** Like starting up, loading disc, pause, stop, skip to next/previous, forward/backward play, and ejecting disc.

Video, audio and picture options

More options are available for video or picture play from a disc or USB storage device.

Video options

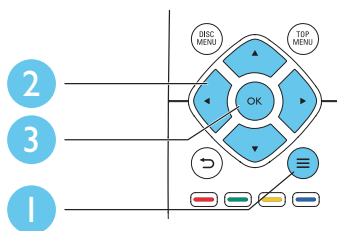

Access more options during video play.

- **[Audio language]:** Select an audio language.
- **[Subtitle language]:** Select a subtitle language.
- **[Subtitle shift]:** Change the subtitle position on the screen. Press ▲▼ to change the subtitle position.
- **[Info]:** Display play information.

- **[Character set]:** Select a character set that supports the DivX video subtitle (only for DivX videos).
- **[Time search]:** Skip to a specific time via the numeric buttons on the remote control.
- **[2nd audio language]:** Select the second audio language (only for Blu-ray discs that support BonusView).
- **[2nd subtitle language]:** Select the second subtitle language (only for Blu-ray discs that support BonusView).
- **[Titles]:** Select a title.
- **[Chapters]:** Select a chapter.
- **[Angle list]:** Select a camera angle.
- **[Menus]:** Display a disc menu.
- **[PIP selection]:** Display a picture-in-picture window (only for Blu-ray discs that support BonusView).
- **[Zoom]:** Zoom into a video picture. Press ◀▶ to select a zoom factor.
- **[Repeat]:** Repeat a chapter or title.
- **[Repeat A-B]:** Mark two points within a chapter for repeat play, or turn off repeat mode.
- **[Picture settings]:** Select a predefined color setting.

Note

• Available video options depend on the video source.

Picture options

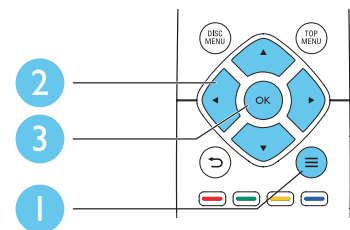

Access more options during slideshow.

- **[Rotate +90]:** Rotate a picture 90 degrees clockwise.
- **[Rotate -90]:** Rotate a picture 90 degrees counter-clockwise.
- **[Zoom]:** Zoom into a picture. Press ◀▶ to select a zoom factor.
- **[Info]:** Display picture information.
- **[Duration per slide]:** Set a display interval for a slideshow.
- **[Slide animation]:** Select a transition effect for a slideshow.
- **[Picture settings]:** Select a predefined color setting.
- **[Repeat]:** Repeat a selected folder.

Audio options

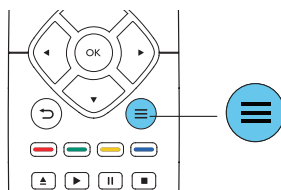

Press  repeatedly to cycle through the following options.

- Repeat the current track.
- Repeat all the tracks on the disc or folder.
- Play audio tracks in a random loop.
- Turn off a repeat mode.

DivX videos

You can play DivX videos from a disc or a USB storage device.

VOD code for DivX

- Before you purchase DivX videos and play them on this player, register this player on www.divx.com using the DivX VOD code.

- Display the DivX VOD code: press **⬆**, and select **[Setup]** > **[Advanced]** > **[DivX® VOD Code]**.

DivX subtitles

- Press **SUBTITLE** to select a language.
- If the subtitle is not displayed correctly, change the character set that supports the DivX subtitle. Select a character set: press **≡**, and select **[Character set]**.

Character set	Languages
[Standard]	English, Albanian, Danish, Dutch, Finnish, French, Gaelic, German, Italian, Kurdish (Latin), Norwegian, Portuguese, Spanish, Swedish, and Turkish
[Central Europe]	Albanian, Croat, Czech, Dutch, English, German, Hungarian, Irish, Polish, Romanian, Slovak, Slovene, and Serbian
[Cyrillic]	Bulgarian, Belorussian, English, Macedonian, Moldavian, Russian, Serbian, and Ukrainian
[Greek]	Greek
[Baltic]	Estonian, Latvian and Lithuanian
[Chinese]	Simplified Chinese
[Chinese-Traditional]	Traditional Chinese
[Korean]	English and Korean

Note

- To use the subtitles, make sure that the subtitle file has the same name as the DivX video file name. For example, if the DivX video file is named "movie.avi", save the subtitle file as "movie.srt", or "movie.sub".
- This player can play subtitle files in the following formats: .srt, .sub, .txt, .ssa, and .smi.

Play a musical slideshow

Play music and pictures simultaneously to create a musical slideshow.

- 1 From a disc or connected USB storage device, play a music file.
- 2 Press **↩**, and go to the picture folder.
- 3 Select a picture from the same disc or USB, and press **OK** to start slideshow.
- 4 Press **■** to stop slideshow.
- 5 Press **■** again to stop music play.

Auto play

This player can automatically play a disc or a video file.

Auto play disc

When this player is switched on, the disc automatically plays.

- 1 Press **⬆** (**Home**).
- 2 Select **[Setup]**, and then press **OK**.
- 3 Select **[Preference]** > **[Auto play disc]** > **[On]**.
 - The feature is turned on.
 - To turn off the feature, select **[Off]**. The disc will not automatically play.

Auto play video sequentially

If two or more video files are available in the same folder from a USB storage device, the next video file automatically plays after the end of a video.

- 1 Press **▲** (**Home**).
- 2 Select **[Setup]**, and then press **OK**.
- 3 Select **[Preference] > [Auto play after video] > [On]**.
 - The feature is turned on.
 - To turn off the feature, select **[Off]**. The next video file will not automatically play after the end of a video in the same folder.

BonusView on Blu-ray

View special content (such as commentaries) in a small screen window.

This feature is only applicable to Blu-ray discs compatible with BonusView (also known as picture in picture).

- 1 During play, press **≡**.
 - ↳ The options menu is displayed.
- 2 Select **[PIP selection] > [PIP]**, and press **OK**.
 - ↳ PIP options [1]/[2] depend on the video contents.
 - ↳ The secondary video window is displayed.
- 3 Select **[2nd audio language]** or **[2nd subtitle language]**, and press **OK**.

BD-Live on Blu-ray

Access exclusive online services, such as movie trailers, games, ringtones and other bonus contents.

This feature is only applicable to Blu-ray discs that are BD-Live enabled.

- 1 Prepare the Internet connection and set up a network (see "Set up a network").
- 2 Connect a USB storage device to the **↔** (**USB**) connector on this player.
 - A USB storage device is used to store the downloaded BD-Live content.
 - To delete the BD-Live previously downloaded on the USB storage device for memory release, press **▲** and select **[Setup] > [Advanced] > [Clear memory]**.
- 3 Play a disc that is BD-Live enabled.
- 4 On the disc menu, select the BD-Live icon, and press **OK**.
 - ↳ BD-Live starts to load. The loading time depends on the disc and the Internet connection.
- 5 On the BD-Live interface, select an item to access.

Note

- BD-Live services vary from discs and countries.
- When you use BD-Live, data on the disc and this player are accessed by the content provider
- Use a USB storage device with at least 1GB of free space to store the download.

Play a Blu-ray 3D video

What you need

- A 3D compliant TV
- This player is connected to the TV through HDMI
- 3D glasses compatible with the TV
- 3D Blu-ray disc

- 1 Make sure that 3D output is turned on: press **⬆**, and select **[Setup] > [Video] > [Watch 3D video] > [Auto]**.
- 2 Play a Blu-ray 3D video.
- 3 Put on the 3D glasses for 3D effects.
 - To turn off 3D output, press **⬆**, and select **[Setup] > [Video] > [Watch 3D video] > [Off]**.

! Caution

- Before you connect to a network, familiarize yourself with the network router and networking principles. If necessary, read documentation accompanying network components. Philips is not responsible for lost, damaged, or corrupt data.

Set up a network

Connect this player to the Internet to access the following service:

- **BD-Live:** access online bonus features (applicable to Blu-ray discs that are BD-Live enabled).

- 1 Connect this player to the Internet through wired (Ethernet) connection.
 - Connect a network cable (not supplied) to the **LAN** port on the back panel of this player.

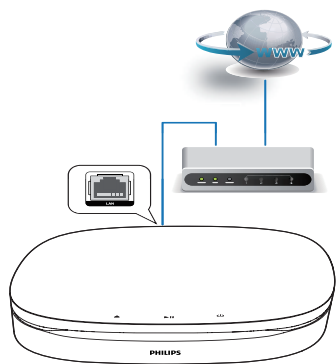

- 2 Perform the network installation.

- 1) Press **⬆**.
 - 2) Select **[Setup]**, and press **OK**.
 - 3) Select **[Network] > [Network installation]**, and press **OK**.
 - 4) Follow the instructions on the TV screen to complete the installation.
-

Use Philips EasyLink

This player supports Philips EasyLink which uses the HDMI CEC (Consumer Electronics Control) protocol. You can use a single remote control to control EasyLink compliant devices that are connected through HDMI. Philips does not guarantee 100% interoperability with all HDMI CEC devices.

- 1 Connect the HDMI CEC compliant devices through HDMI, and turn on the HDMI CEC operations on the TV and other connected devices (see the user manual of the TV or other devices for details).
- 2 Press **⬆**.
- 3 Select **[Setup] > [EasyLink]**.
- 4 Select **[On]** under the options: **[EasyLink]**, **[One Touch Play]** and **[One Touch Standby]**.
 - ↳ EasyLink function is turned on.

One Touch Play

When a video disc is in the disc compartment, press **▶** to wake up the TV from standby, and then play a disc.

One Touch Standby

When a connected device (for example TV) is put to standby with its own remote control, this player is put to standby automatically.

2 Change settings

This section helps you change the settings of this player.

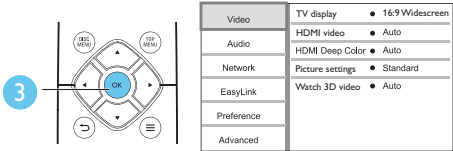
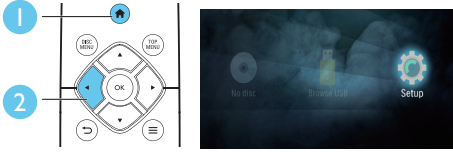

Video	TV display	● 16:9 Widescreen
Audio	HDMI video	● Auto
Network	HDMI Deep Color	● Auto
EasyLink	Picture settings	● Standard
Preference	Watch 3D video	● Auto
Advanced		

Note

- You cannot change a menu option that is grayed out.
- To return to the previous menu, press .
- To exit the menu, press .

Picture

- 1 Press .
- 2 Select **[Setup]** > **[Video]** to access the video setup options.
 - **[TV display]**: Select a picture display format to fit the TV screen.
 - **[HDMI video]**: Select an HDMI video resolution.
 - **[HDMI Deep Color]**: Display colors with more shades and hues when the video content is recorded in Deep Color and the TV supports this feature.
 - **[Picture settings]**: Select a predefined color setting.

- **[Watch 3D video]**: Set to 3D or 2D output when playing a Blu-ray 3D disc. The player must be connected to a 3D TV through HDMI.

Note

- If you change a setting, make sure that the TV supports the new setting.

Sound

- 1 Press .
- 2 Select **[Setup]** > **[Audio]** to access the audio setup options.
 - **[Night mode]**: Select quiet or full dynamic sound. Night mode decreases the volume of loud sound and increases the volume of soft sound (such as speech).
 - **[HDMI audio]**: Set an HDMI audio format when this player is connected through HDMI.

Note

- Night mode is only available for Dolby® TrueHD / Dolby® Digital Plus encoded DVD and Blu-ray discs.

Network (installation, status...)

- 1 Press .
- 2 Select **[Setup]** > **[Network]** to access the network setup options.
 - **[Network installation]**: Start a wired installation to make the network work.
 - **[View network settings]**: Display the current network status.

Preference (languages, parental control...)

- 1 Press **▲**.
- 2 Select **[Setup] > [Preference]** to access the preference setup options.
 - **[Menu language]**: Select an onscreen display menu language.
 - **[Audio]**: Select an audio language for video.
 - **[Subtitle]**: Select a subtitle language for video.
 - **[Disc menu]**: Select a menu language for a video disc.
 - **[Parental control]**: Restrict access to discs that are encoded with ratings. Input "0000" to access the restriction options. To play all discs irrespective of the rating, select level "8".
 - **[Screen saver]**: Enable or disable screen saver mode. If enabled, the screen enters idle mode after 10 minutes of inactivity (for example, in pause or stop mode).
 - **[Auto subtitle shift]**: Enable or disable subtitle shift. If enabled, the subtitle position is changed automatically to fit the TV screen (this feature works with some Philips TVs only).
 - **[Change password]**: Set or change a password to play a restricted disc. Input "0000" if you do not have a password or if you have forgotten your password.
 - **[Auto standby]**: Enable or disable auto standby. If enabled, the player switches to standby after 18 minutes of inactivity (for example, in pause or stop mode).
 - **[Fast wake up]**: Enable or disable the player to wake up faster from standby. If fast wakeup is turned on,

more power is consumed during standby.

- **[VCD PBC]**: Display or skip the content menu for VCD and SVCD.
- **[Auto play disc]**: Enable or disable the automatic disc playback after power on.
- **[Auto play after video]**: Enable or disable sequential playback of videos from USB.



Note

- If your preferred language is not available for disc language, audio or subtitle, you can select **[Other]** from the menu options and input 4-digit language code which can be found at the back of this user manual.
- If you select a language which is not available on a disc, this player uses the default language of the disc.

Advanced options (clear memory...)

- 1 Press **▲**.
- 2 Select **[Setup] > [Advanced]** to access the advanced setup options.
 - **[BD-Live security]**: Restrict or allow access to BD-Live (only for non-commercial, user-created BD-Live discs).
 - **[Downmix mode]**: Control 2-channel stereo audio output.
 - **[Software update]**: Update software through a USB storage device.
 - **[Clear memory]**: Delete the previous BD-Live download on the USB storage device. A "BUDA" folder is automatically created to store the BD-Live download.
 - **[DivX® VOD Code]**: Display the DivX® registration code or the deregistration code for this player.

- **[Version information]**: Display the software version of this player.
- **[Restore default settings]**: Reset this player to the default settings made at the factory, except for password and parental control level.



Note

- You cannot restrict Internet access on commercial Blu-ray discs.
- Before you purchase DivX videos and play them on this player, register this player on www.divx.com with the DivX VOD code.

3 Update software

Before you update the software of this player, check the current software version:

- Press **▲**, and then select **[Setup]** > **[Advanced]** > **[Version information]**, and press **OK**.

Update software via USB

- 1 Check the latest software version on www.philips.com/support.
 - Search for your model and click on "Software and drivers".
- 2 Download the software into a USB storage device.
 - ① **Unzip the download, and make sure that the unzipped folder is named "UPG".**
 - ② **Put the "UPG" folder in the root directory.**
- 3 Connect the USB storage device to the  (USB) connector on this player.
- 4 Press **▲**, and select **[Setup]**.
- 5 Select **[Advanced]** > **[Software update]** > **[USB]**.
 - ↳ If an upgrade media is detected, you are prompted to start the update.
- 6 Follow the instructions on the TV screen to update the software.
 - ↳ When the update is complete, this player automatically turns off and on again.



Caution

- Do not turn off the power or remove the USB storage device when the software update is in progress because you might damage this player.

4 Optional placement

The design of this product allows you to place this product in the following ways:

- Horizontal placement on the tabletop.
- Vertical placement on the tabletop.
- Wall mount

You may simply place this product horizontally on the tabletop.

Vertical placement

You may place this product vertically on the tabletop. See the section of the quick start guide in this user manual for placement illustration.

- 1) Assemble the supplied brackets.
- 2) Fix the assembled bracket to this product.

Wall mount



Note

- Before wall mounting, make sure the wall can support the weight of this product.
- For wall mounting, this product must be securely attached to the wall in accordance with the installation instructions. Improper wall mounting may result in accident, injury or damage. If you have any query, contact Consumer Care in your country.

You may mount this product on the wall. See the section of the quick start guide in this user manual for placement illustration.

- 1) Fix the supplied bracket to this product.
- 2) Drill two holes on the wall, then secure the dowels and screws in the holes.
- 3) Hang this product on the wall.

5 Product specifications

Note

- Specifications and design are subject to change without notice.

Region code

This player can play discs with the following region codes.

DVD	Blu-ray	Countries
		Asia Pacific, Taiwan, Korea
		

Media formats

- BD-Video, BD 3D
- DVD-Video, DVD+R/+RW, DVD-R/-RW, DVD+R/-R DL (Dual Layer)
- VCD/SVCD
- Audio CD, CD-R/CD-RW, MP3 media, WMA media, JPEG files
- DivX (Ultra)/DivX Plus HD media, MKV media
- USB storage device

File formats

- Audio:
 - .aac, .mka, .mp3, .wma, .wav, .m4a, .flac, .ogg
- Video:
 - .avi, .divx, .mp4, .m4v, .ts, .mov, .mkv, .m2ts, .mpg, .mpeg, .3gp
- Picture: .jpg, .jpeg, .gif, .png

Audio formats

This product supports the following audio files.

Extension	Container	Audio codec	Bit rate	
.mp3	MP3	MP3	Up to 320 kbps	
.wma	ASF	WMA	Up to 192 kbps	
.aac	AAC	AAC, HE-AAC	Up to 192 kbps	
.wav	WAV	PCM	27,648 Mbps	
.m4a	MKV	AAC	192 kbps	
		ALAC	Up to 192kHz sampling rate	
.mka	MKA	PCM	27,648 Mbps	
		AC-3	640kbps	
		DTS core	1.54 Mbps	
		MPEG	912 kbps	
		MP3	Up to 320 kbps	
		WMA	Up to 192 kbps	
		AAC, HE-AAC	Up to 192 kbps	
.flac	FLAC	FLAC	Up to 24 bit per sample	
.ogg	OGG	Vorbis	Variable bit rate, maximum block size 4096	
			FLAC	Up to 192kHz sampling rate
			OGGPCM	No limitation
		MP3	Upto 320 kbps	

Video formats

If you have a high definition TV, this product allows you to play your video files with:

- Resolution: 1920 x 1080 pixels at
- Frame rate: 6 ~ 30 frames per second.

.avi files in AVI container (or .ts files in TS container)

Audio codec	Video codec	Bit rate
PCM, AC-3, DTS core, MP3, WMA, DD+	DivX 3.11, DivX 4.x, DivX 5.x, DivX 6.x	10 Mbps max
	MPEG 1, MPEG 2	40 Mbps
	MPEG 4 SP / ASP	38.4 Mbps
	H.264/ AVC up to HiP@5.1	25 Mbps
	WMV9	45 Mbps

.divx files in AVI container

Audio codec	Video codec	Bit rate
PCM, AC-3, DTS core, MP3, WMA, DD+	DivX 3.11, DivX 4.x, DivX 5.x, DivX 6.x	10 Mbps max

.mp4 or .m4v files in MP4 container

Audio codec	Video codec	Bit rate
AC-3, MPEG, MP3, AAC, HE-AAC, DD+	MPEG 1, MPEG 2	40 Mbps
	MPEG 4 ASP	38.4 Mbps
	H.264/ AVC up to HiP@5.1	25 Mbps

.mov files in MOV container

Audio codec	Video codec	Bit rate
AC-3, MPEG, MP3, AAC, HE-AAC	MPEG 1, MPEG 2	40 Mbps
	MPEG 4 ASP	38.4 Mbps
	H.264/ AVC up to HiP@5.1	25 Mbps

.mkv files in MKV container

Audio codec	Video codec	Bit rate
PCM, AC-3, DTS core, MPEG, MP3, WMA, AAC, HE- AAC, DD+, FLAC	DivX Plus HD	30 Mbps
	MPEG 1, MPEG 2	40 Mbps
	MPEG 4 ASP	38.4 Mbps
	H.264/ AVC up to HiP@5.1	25 Mbps
	WMV9	45 Mbps

.m2ts files in MKV container

Audio codec	Video codec	Bit rate
PCM, AC-3, DTS core, MPEG, MP3, WMA, AAC, HE- AAC, DD+	MPEG 1, MPEG 2	40 Mbps
	MPEG 4 ASP	38.4 Mbps
	H.264/ AVC up to HiP@5.1	25 Mbps

Audio codec	Video codec	Bit rate
	WMV9	45 Mbps

.mpg and .mpeg files in PS container

Audio codec	Video codec	Bit rate
PCM, DTS core, MPEG, MP3	MPEG 1, MPEG 2	40 Mbps

.3gp files in 3GP container

Audio codec	Video codec	Bit rate
AAC, HE-AAC	MPEG 4 ASP	38.4 Mbps
	H.264/AVC up to HiP@5.1	25 Mbps max

Video

- Signal system: PAL / NTSC
- HDMI output: 480i/576i, 480p/576p, 720p, 1080i, 1080p, 1080p/24Hz

Audio

- HDMI output
- Sampling frequency:
 - MP3: 32 kHz, 44.1 kHz, 48 kHz
 - WMA: 44.1 kHz, 48 kHz
- Constant bit rate:
 - MP3: 112 kbps - 320 kbps
 - WMA: 48 kbps - 192 kbps

USB

- Compatibility: Hi-Speed USB (2.0)
- Class support: USB Mass Storage Class
- File system: FAT16, FAT32
- USB port: 5V \pm , 500mA
- Support HDD (a portable hard disc drive): an external power source may be needed.

Main unit

- Power supply:
 - Model (Philips branded AC power adapter): NU010A120080
 - Input: 100-240 V~, 50/60 Hz 0.2 A
 - Output: 12 V \pm , 0.8 A
- Power consumption in standby mode: < 0.5 W
- Dimensions (w x h x d): 210 x 52.5 x 210 (mm)
- Net Weight: 0.75 kg

Operating Temperature & Humidity

- 0°C to 45°C, 5% to 90% Humidity for all climates.

Storage Temperature & Humidity

- -40 °C to 70 °C, 5% to 95%

Accessories

- Remote control and batteries
- User manual
- HDMI cable
- 2 brackets and 2 screws

Laser

- Laser Type (Diode): AlGaInN (BD), AlGaInP (DVD/CD)
- Wave length: 398nm to 413nm (BD), 645nm to 664nm (DVD), 770nm to 800nm(CD)
- Output power: 1.7mW (BD), 0.19mW(DVD), 0.25mW (CD)

6 Troubleshooting



Warning

- Risk of electric shock. Never remove the casing of the player.

To keep the warranty valid, never try to repair the player yourself.

If you have problems using this player, check the following points before you request service. If you still have a problem, register your player and get support at www.philips.com/support. If you contact Philips, you will be asked for the model and serial number of this player. The model number and serial number are on the back of this player.

Write the numbers here:

Model No. _____

Serial No. _____

Main unit

The buttons on this player do not work.

- Disconnect this player from the power supply for a few minutes, and then reconnect.

Picture

No picture.

- Make sure that the TV is switched to the correct source input for this player.

No picture on HDMI connection.

- Make sure that the HDMI cable is not faulty. If it is faulty, replace with a new HDMI cable.
- On the remote control, press  and then press "731" (numeric buttons) to recover picture display. Or wait for 10 seconds for auto recovery.

- If this player is connected to an unauthorized display device with an HDMI cable, the audio and video signals may not be output.

The disc does not play high-definition video.

- Make sure that the disc contains high-definition video.
- Make sure that the TV supports high-definition video.

Sound

No sound on HDMI connection.

- You may not hear any sound from the HDMI output if the connected device is non-HDCP compliant or only DVI-compatible.

No secondary audio output for Picture-in-Picture feature.

- When **[Bitstream]** under the **[HDMI audio]** menu is selected, interactive sound like secondary sound for Picture-in-Picture feature is muted. De-select **[Bitstream]**.

Play

Cannot play a disc.

- Clean the disc.
- Make sure that the disc is correctly loaded.
- Make sure that this player supports the disc. See "Specifications".
- Make sure that this player supports the region code of the DVD or BD.
- For DVD±RW or DVD±R, make sure that the disc is finalized.

Cannot play DivX video files.

- Make sure that the DivX video file is complete.
- Make sure that the video file name extension is correct.

DivX subtitles do not display correctly.

- Make sure that the subtitle file has the same name as the DivX video file.
- Make sure that the subtitle file has an extension name supported by this player (.srt, .sub, .txt, .ssa, or .smi).

Cannot read the contents of a connected USB storage.

- Make sure that the format of the USB storage device is compatible with this player.
- Make sure that the file system on the USB storage device is supported by this player.
- For a USB HDD (a portable hard disc drive), an external power source may be needed.

'No entry' or 'x' sign is displayed on the TV.

- The operation is not possible.

EasyLink feature does not work.

- Make sure that this player is connected to the Philips brand EasyLink TV, and the EasyLink option is turned on (see "Use your Blu-ray disc/ DVD player" > "Use Philips EasyLink").

Cannot access BD-Live features.

- Make sure that this player is connected to the network (see "Use your Blu-ray disc/ DVD player" > "Set up a network").
- Make sure that the network installation is made (see "Use your Blu-ray disc/ DVD player" > "Set up a network").
- Make sure that the Blu-ray disc supports BD-Live features.
- Clear memory storage (see "Change settings" > "Advanced options (BD-Live security, clear memory...)").

Network

Network is not found.

- Make sure that the network is correctly connected (see "Use your Blu-ray disc/ DVD player" > "Set up a network").
- Make sure that the network installation is made (see "Use your Blu-ray disc/ DVD player" > "Set up a network").
- Check the router connection (refer to the user manual for the router).

Internet speed is slow.

- You need a high speed Internet connection for your router.

3D videos

Cannot see 3D effects

- Make sure that 3D output is turned on (see "Use your Blu-ray disc/ DVD player" > "Play a Blu-ray 3D video").
- Make sure that the disc title being played is Blu-ray 3D compliant.
- Make sure that the TV is 3D and HDMI compliant, and the TV is set to 3D mode (refer to the TV's user manual).
- Make sure that the 3D glasses are activated (refer to the TV's user manual).



“Blu-ray 3D™” and “Blu-ray 3D™” logo are trademarks of Blu-ray Disc Association.



HDMI, and HDMI logo and High-Definition Multimedia Interface are trademarks or registered trademarks of HDMI licensing LLC in the United States and other countries.



Dolby and the double-D symbol are registered trademarks of Dolby Laboratories.



This DivX Certified® device has passed rigorous testing to ensure it plays DivX® video.

To Play purchased DivX movies, first register your device at vod.divx.com. Find your registration code in the DivX VOD section of your device setup menu. DivX Certified® to play DivX® and DivX Plus® HD (H.264/MKV) video up to 1080p HD, including premium content. DivX®, DivX Certified®, DivX Plus® HD and associated logos are trademarks of DivX, LLC and are used under license.



For DTS patents, see <http://patents.dts.com>. Manufactured under license from DTS Licensing Limited. DTS, the Symbol, & DTS and the Symbol together are registered trademarks, and DTS 2.0+Digital Out is a trademark of DTS, Inc. © DTS, Inc. ALL Rights Reserved.



BONUSVIEW™ ‘BD LIVE™’ and ‘BONUSVIEW™’ are trademarks of Blu-ray Disc Association.



‘DVD Video’ is a trademark of DVD Format/Logo Licensing Corporation.



Oracle and Java are registered trademarks of Oracle and/or its affiliates. Other names may be trademarks of their respective owners.

Language Code

Abkhazian	6566	Inupiaq	7375	Pushto	8083
Afar	6565	Irish	7165	Russian	8285
Afrikaans	6570	Íslenska	7383	Quechua	8185
Amharic	6577	Italiano	7384	Raeto-Romance	8277
Arabic	6582	Ivrit	7269	Romanian	8279
Armenian	7289	Japanese	7465	Rundi	8278
Assamese	6583	Javanese	7486	Samoan	8377
Avestan	6569	Kalaallisut	7576	Sango	8371
Aymara	6589	Kannada	7578	Sanskrit	8365
Azerhijani	6590	Kashmiri	7583	Sardinian	8367
Bahasa Melayu	7783	Kazakh	7575	Serbian	8382
Bashkir	6665	Kernewek	7587	Shona	8378
Belarusian	6669	Khmer	7577	Shqip	8381
Bengali	6678	Kinyarwanda	8287	Sindhi	8368
Bihari	6672	Kirghiz	7589	Sinhalese	8373
Bislama	6673	Komi	7586	Slovensky	8373
Bokmål, Norwegian	7866	Korean	7579	Slovenian	8376
Bosanski	6683	Kuanyama; Kwanyama	7574	Somali	8379
Brezhoneg	6682	Kurdish	7585	Sotho; Southern	8384
Bulgarian	6671	Lao	7679	South Ndebele	7882
Burmese	7789	Latina	7665	Sundanese	8385
Castellano, Español	6983	Latvian	7686	Suomi	7073
Catalán	6765	Letzeburgesch;	7666	Swahili	8387
Chamorro	6772	Limburgan; Limburger	7673	Swati	8383
Chechen	6769	Lingala	7678	Svenska	8386
Chewa; Chichewa; Nyanja	7889	Lithuanian	7684	Tagalog	8476
中文	9072	Luxembourgish;	7666	Tahitian	8489
Chuang; Zhuang	9065	Macedonian	7775	Tajik	8471
Church Slav; Slavonic	6785	Malagasy	7771	Tamil	8465
Chuvash	6786	Magyar	7285	Tatar	8484
Corsican	6779	Malayalam	7776	Telugu	8469
Česky	6783	Maltese	7784	Thai	8472
Dansk	6865	Manx	7186	Tibetan	6679
Deutsch	6869	Maori	7773	Tigrinya	8473
Dzongkha	6890	Marathi	7782	Tonga (Tonga Islands)	8479
English	6978	Marshallese	7772	Tsonga	8483
Esperanto	6979	Moldavian	7779	Tswana	8478
Estonian	6984	Mongolian	7778	Türkçe	8482
Euskara	6985	Nauru	7865	Türkmen	8475
Ελληνικά	6976	Navaho; Navajo	7886	Twi	8487
Faroese	7079	Ndebele, North	7868	Uighur	8571
Français	7082	Ndebele, South	7882	Ukrainian	8575
Frysk	7089	Ndonga	7871	Urdu	8582
Fijian	7074	Nederlands	7876	Uzbek	8590
Gaelic; Scottish Gaelic	7168	Nepali	7869	Vietnamese	8673
Galleghan	7176	Norsk	7879	Volapuk	8679
Georgian	7565	Northern Sami	8369	Walloon	8765
Gikuyu; Kikuyu	7573	North Ndebele	7868	Welsh	6789
Guarani	7178	Norwegian Nynorsk;	7878	Wolof	8779
Gujarati	7185	Occitan; Provençal	7967	Xhosa	8872
Hausa	7265	Old Bulgarian; Old Slavonic	6785	Yiddish	8973
Herero	7290	Oriya	7982	Yoruba	8979
Hindi	7273	Oromo	7977	Zulu	9085
Hiri Motu	7279	Ossetian; Ossetic	7983		
Hrwatski	6779	Pali	8073		
Ido	7379	Panjabi	8065		
Interlingua (International)	7365	Persian	7065		
Interlingue	7365	Polski	8076		
Inuktitut	7385	Português	8084		



Specifications are subject to change without notice

© 2016 Koninklijke Philips N.V. All rights reserved.

Trademarks are the property of Koninklijke Philips N.V. or their respective owners.

BDP3290B_98_UM_V1.0

