

USER'S MANUAL



UNINTERRUPTIBLE POWER SUPPLY (UPS)

**SLC TWIN PRO2**

**4.. 20 kVA**

**SALICRU**

## General index

### 1. INTRODUCTION.

1.1. ACKNOWLEDGEMENT LETTER.

### 2. INFORMATION FOR SAFETY.

2.1. USING THIS MANUAL.

2.1.1. Conventions and used symbols.

### 3. QUALITY AND STANDARD GUARANTEE.

3.1. DECLARATION OF THE MANAGEMENT.

3.2. STANDARD.

3.2.1. First and second environment.

3.2.1.1. First environment.

3.2.1.2. Second environment.

3.3. ENVIRONMENT.

### 4. PRESENTATION.

4.1. VIEWS.

4.1.1. Views of the equipment.

4.2. PRODUCT DEFINITION.

4.2.1. Nomenclature.

4.3. OPERATING PRINCIPLE.

4.3.1. Main features.

4.4. OPTIONS.

4.4.1. Isolation transformer.

4.4.2. External manual bypass manual.

4.4.3. Communication card.

4.4.3.1. Integration into IT networks by means of the SNMP adaptor.

4.4.3.2. RS485 Modbus.

4.4.3.3. Dry contacts.

### 5. INSTALLATION.

5.1. EQUIPMENT RECEPTION.

5.1.1. Reception, unpacking and contents.

5.1.2. Storage.

5.1.3. Unpacking.

5.1.4. Transport till its location.

5.1.5. Location, immobilising and considerations.

5.1.5.1. Location for single units.

5.1.5.2. Location for parallel systems.

5.1.5.3. Immobilising the equipment.

5.1.5.4. Preliminary considerations, before connecting the equipment.

5.1.5.5. Preliminary considerations for batteries and their protections before connecting the equipment.

5.1.5.6. Connection parts.

5.2. CONNECTION.

5.2.1. Connection of the input terminals to AC power supply.

5.2.2. Connection of load/s to the output terminals or output 1.

5.2.3. Connection of the load/s to the output terminals 2 (TWIN/3 PRO2 from 8 to 20 kVA only).

5.2.4. Connection with the external battery module and extended back up times.

5.2.5. AC power supply for the battery charger built in the battery module.

5.2.6. Connection of the main protective earth  and bonding earth .

5.2.7. EPO terminals (Emergency Power Off).

5.2.8. Terminals for digital Input and Output.

5.2.9. Terminals for the manual bypass auxiliary contact.

5.2.10. Parallel connection.

5.2.10.1. Introduction to the redundancy.

5.2.10.2. Parallel installation and operating.

5.2.11. Communication port.

5.2.11.1. RS232 and USB ports.

5.2.12. Intelligent slot to insert the communication card.

5.2.13. Software.

5.2.14. Considerations before commissioning with the loads.

### 6. OPERATING.

6.1. COMMISSIONING.

6.1.1. Checking before commissioning.

6.2. START UP AND SHUTDOWN OF THE UPS.

6.2.1. UPS start up with AC mains present.

6.2.2. UPS start up with no AC mains (Cold start).

6.2.3. UPS shutdown with AC mains present.

6.2.4. UPS shutdown with no AC mains.

6.3. MANUAL BYPASS SWITCH (MAINTENANCE).

6.3.1. Shifting to maintenance bypass.

6.3.2. Shifting to normal mode.

6.4. PARALLEL SYSTEM OPERATING

6.5. HOW UPGRADE THE PARALLEL SYSTEM WITH A NEW UPS OR DOWNGRADE TO SINGLE MODE.

6.6. HOW TO REPLACE A FAULTY UPS FROM THE PARALLEL SYSTEM.

## **7. CONTROL PANEL WITH LCD.**

- 7.1. CONTROL PANEL.
- 7.2. TABLE 6 SHOWS THE INDIVIDUAL FUNCTION OF EACH ONE OF THEM OR THEIR INTERACTION WITH OTHERS, AS REGARDS TO THE UPS STATUS. LED FUNCTIONS.
  - 7.2.1. Acoustic alarms.
  - 7.2.2. Messages shown in the LCD.
- 7.3. MEANING OF THE ABBREVIATIONS DISPLAYED IN THE LCD OF THE CONTROL PANEL.
- 7.4. SETTINGS IN THE LCD CONTROL PANEL.
  - 7.4.1. Setting menu views, depending on the parameter 1 code.
- 7.5. OPERATING MODES / STATUS DESCRIPTION.
- 7.6. WARNING CODES.
- 7.7. ERROR O FAULT CODES.
- 7.8. WARNING INDICATORS.

## **8. MAINTENANCE, WARRANTY AND SERVICE.**

- 8.1. BATTERY MAINTENANCE.
  - 8.1.1. Notes to replace and install the batteries.
- 8.2. UPS TROUBLE SHOOTING GUIDE.
  - 8.2.1. Troubleshooting guide.
- 8.3. WARRANTY CONDITIONS.
  - 8.3.1. Warranty terms.
  - 8.3.2. Out of scope of supply.
- 8.4. TECHNICAL SERVICE NETWORK.

## **9. ANNEXES.**

- 9.1. GENERAL TECHNICAL FEATURES.
- 9.2. GLOSARIO.

## 1. INTRODUCTION.

### 1.1. ACKNOWLEDGEMENT LETTER.

We would like to thank you in advance for the trust you have placed in us by purchasing this product. Read this instruction manual carefully in order to be familiarized with its contents, because, as much as you know and understand the equipment the highest will be your satisfaction and safety levels and their features will be optimized too.

We remain at your entire disposal for any further information or any query you should wish to make.

Yours sincerely.

### SALICRU

- The equipment here described **can cause important physical damages due to wrong handling**. This is why, the installation, maintenance and/or fixing of itself must be done by our staff or qualified **personnel exclusively**.
- Although we have made every effort to guarantee a complete and accurate information in this user's manual, we are not responsible for any errors or omissions that may exist.

The images included in this document are mere illustrations and they could not represent the part of the equipment exactly, therefore they are not contractual. Nevertheless, differences that could exist will be alleviated or solved with the correct labelling of the equipment.

- According to our policy of constant evolution, **we reserve the right to modify the specifications, operating or described actions in this document without forewarning**.

**Any reproduction, copy or third party concession, modification or partial or in whole translations** of this manual or document, in any format or media, **is prohibited without the previous written authorization of our firm**, being reserved the full and exclusive ownership right over it.

## 2. INFORMATION FOR SAFETY.

### 2.1. USING THIS MANUAL.

The documentation of any standard equipment can be downloaded from our website by the client ([www.salicru.com](http://www.salicru.com)).

- Those equipments «supplied by power cord with plug», this is the website to get the user's manual and the **«Safety instructions»** EK266\*08.
- Those equipments «with perm connection», hardwired, can be supplied together with a CD-ROM or Pen Drive, which includes any information needed for its erection and commissioning, including the **«Safety instructions»** EK266\*08.

Before doing any action over the equipment regarding installation or commissioning, change of location, setting or handling, read them carefully.

This user's manual is intended to provide information regarding the safety and to give explanations about the procedures for the installation and operating of the equipment. Read them carefully and follow the stated steps in the established order.



**Compliance as regards to «Safety instructions» is mandatory, being the user the legal responsible** regarding to its observance and application.

The equipments are delivered duly labelled for the correct identification of any their parts, which combined with the instructions described in this user's manual, allows the end-user to make any operating of both installation and commissioning, in an easy and ordered way without doubt.

Finally, once the equipment is commissioned and in operation, it is recommended to keep the downloaded documentation from the WebSite, or the CD-ROM or Pen Drive in a safe place and with easy access, for further questions that could arise.

The following terms are used in the document indistinctly to be referred to:

- **«SLC TWIN PRO2, TWIN PRO2, TWIN, PRO2, equipment, unit o UPS»**.- Uninterruptible Power Supply.  
Depending on the context of the sentence, it can be referred either to the own equipment or to the equipment with batteries, although all is assembled in one cabinet or metallic enclosure.
- **«Batteries or accumulators»**.- Group or set of elements that store the electron flow through electrochemical means.
- **«T.S.S.»**.- Technical Service & Support.
- **«client, fitter, operator or end-user»**.- are used indistinctly and by extension, to be referred to the fitter and/or operator which will make the corresponding actions, being responsible the same person about the actions to take on behalf of himself.

#### 2.1.1. Conventions and used symbols.

Some symbols can be used and shown in the equipment and/or in the description of this user's manual.

For more information, see section 1.1.1 of EK266\*08 document as regards to **«Safety instructions»**.

### 3. QUALITY AND STANDARD GUARANTEE.

#### 3.1. DECLARATION OF THE MANAGEMENT.

Our target is the client's satisfaction, therefore this Management has decided to establish a Quality and Environmental policy, by means of installation a Quality and Environmental Management System that becomes us capable to comply the requirements demanded by the standard **ISO 9001** and **ISO 14001** and by our Clients and concerned parts too.

Likewise, the enterprise Management is committed with the development and improvement of the Quality and Environmental Management System, through:

- The communication to all the company about the importance of satisfaction both in the client's requirements and in the legal and regulations.
- The Quality and Environmental Policy diffusion and the fixation of the Quality and Environment targets.
- To carry out revisions by the Management.
- To provide the needed resources.

#### 3.2. STANDARD.

The SLC TWIN PRO2 product is designed, manufactured and commercialized in accordance with the standard **EN ISO 9001** of Quality Management Systems. The **CE** marking shows the conformity to the EEC Directive by means of the application of the following standards:

- **2014/35/EU**. - Low Voltage Directive [LVD].
- **2014/30/EU**. - Electromagnetic Compatibility [EMC].
- **2011/65/EU**. - Restriction of Hazardous Substances in electrical and electronic equipment [RoHS].

In accordance with the specifications of the harmonized standards. Standards as reference:

- **EN-IEC 62040-1**. Uninterruptible power supply [UPS]. Part 1-1: General and safety requirements for UPS's used in accessible areas by end users..
- **EN-IEC 60950-1**. IT equipments. Safety. Part 1: General requirements.
- **EN-IEC 62040-2**. Uninterruptible power supply [UPS]. Part 2: EMC requirements.



The manufacturers responsibility is excluded in the event of any modification or intervention in the product by the customer's side.



#### **ADVERTENCIA!:**

SLC TWIN PRO2 4.. 20 kVA. This is a category C3 UPS product. This is a product for commercial and industrial application in the second environment; installation restrictions or additional measures may be needed to prevent disturbances

The use of this equipment is not suitable for life support applications, where the failure of it can leave out of service the life support device or could affect to its safety or effectiveness. Likewise, it is not recommended its use in those medical applications, commercial transport, nuclear power stations and other applications or

loads, where the failure of this product can reverse in personal injuries and material damages.



Declaration of conformity CE of the product is at the client disposal under previous request to our headquarters offices.

#### 3.2.1. First and second environment.

The following examples of environment cover the majority of UPS installations.

##### 3.2.1.1. First environment.

Environment that includes residential, commercial and light industrial premises directly connected without intermediate transformers to a public low-voltage mains supply.

##### 3.2.1.2. Second environment.

Environment that includes all commercial, light industry and industrial establishments other than those directly connected to a low-voltage mains that supplies buildings used for residential purposes.

#### 3.3. ENVIRONMENT.

This product has been designed to respect the environment and has been manufactured in accordance with the standard **ISO 14001**.

#### **Equipment recycling at the end of its useful life:**

Our company commits to use the services of authorised societies and according to the regulations, in order to treat the recovered product at the end of its useful life (contact your distributor).

#### **Packaging:**

To recycle the packaging, follow the legal regulations in force, depending on the particular standard of the country where the equipment is installed.

#### **Batteries:**

The batteries mean a serious danger for health and environment. The disposal of them must be done in accordance with the standards in force.

## 4. PRESENTATION.

### 4.1. VIEWS.

#### 4.1.1. Views of the equipment.

Figures from 1 to 3 show the equipment illustrations according to the format of the case and its power rate. Nevertheless, as the product is in constant evolution, some discrepancies or slight contradictions can arise. In case of any doubt, the labelling in the own equipment will always prevail

**i** In the nameplate of the equipment, the most important parameters and features can be checked. Proceed with the installation accordingly.

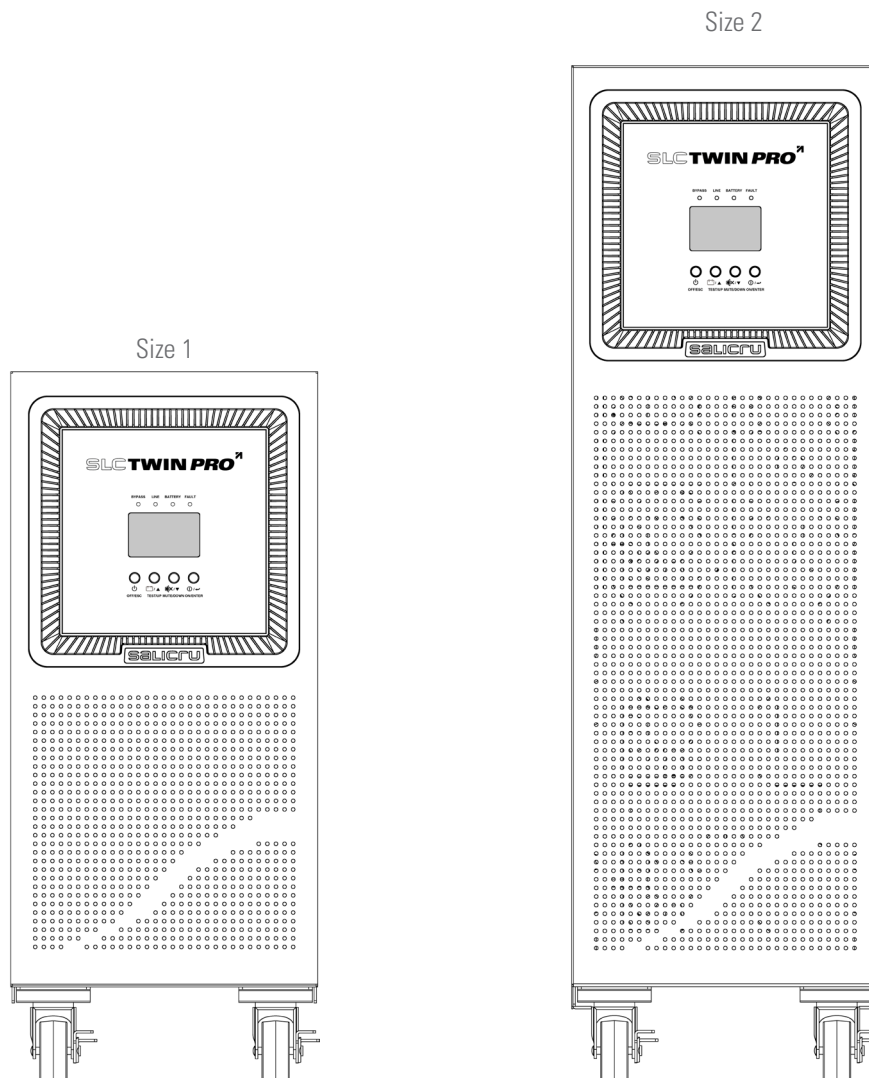

Standard and B1, from 4 to 10 kVA. Single phase input and output.  
 Standard and B1, from 8 to 10 kVA. Three phase input and single phase output.  
 B1, from 15 and 20 kVA. Three phase input and single phase output.

Standard, 15 and 20 kVA. Three phase input and single phase output.

Fig. 1. Front view for 4 to 20 kVA equipments.

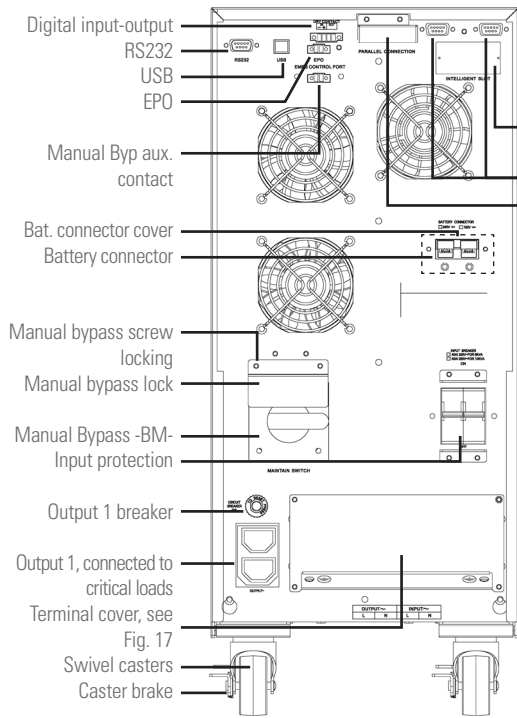

Standard and B1, from 4 to 10 kVA. Single phase input and output.

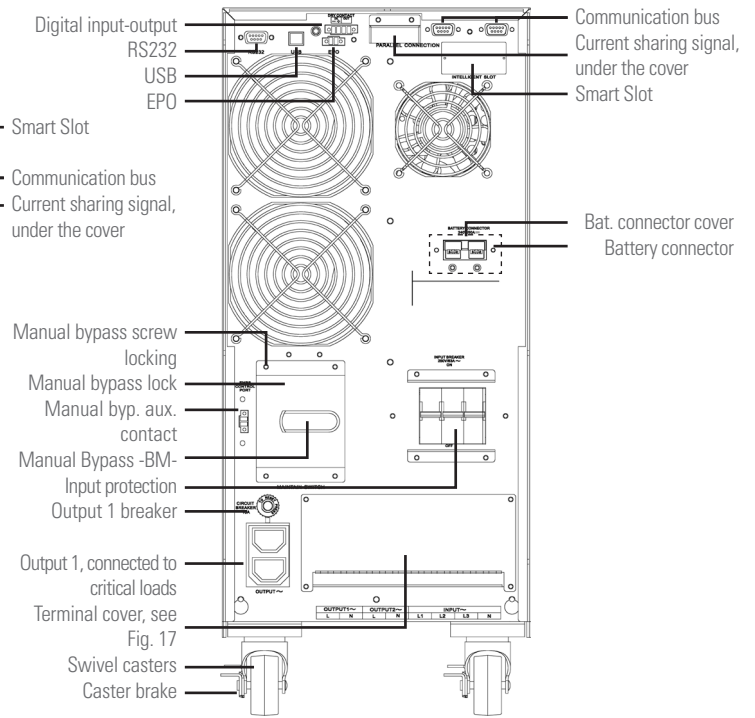

Standard and B1, from 8 to 10kVA. Three phase input and single phase output.

**i** -BM- letters means Manual Bypass.

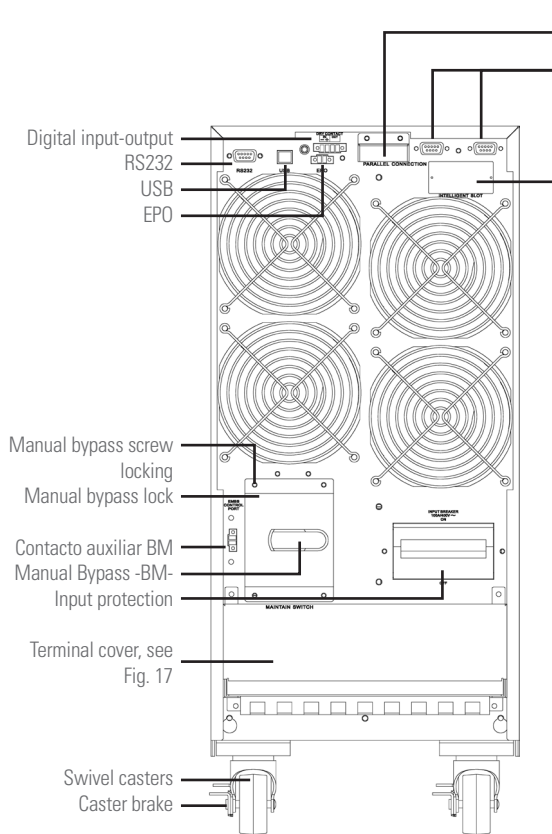

B1, from 15 and 20 kVA. Three phase input and single phase output.

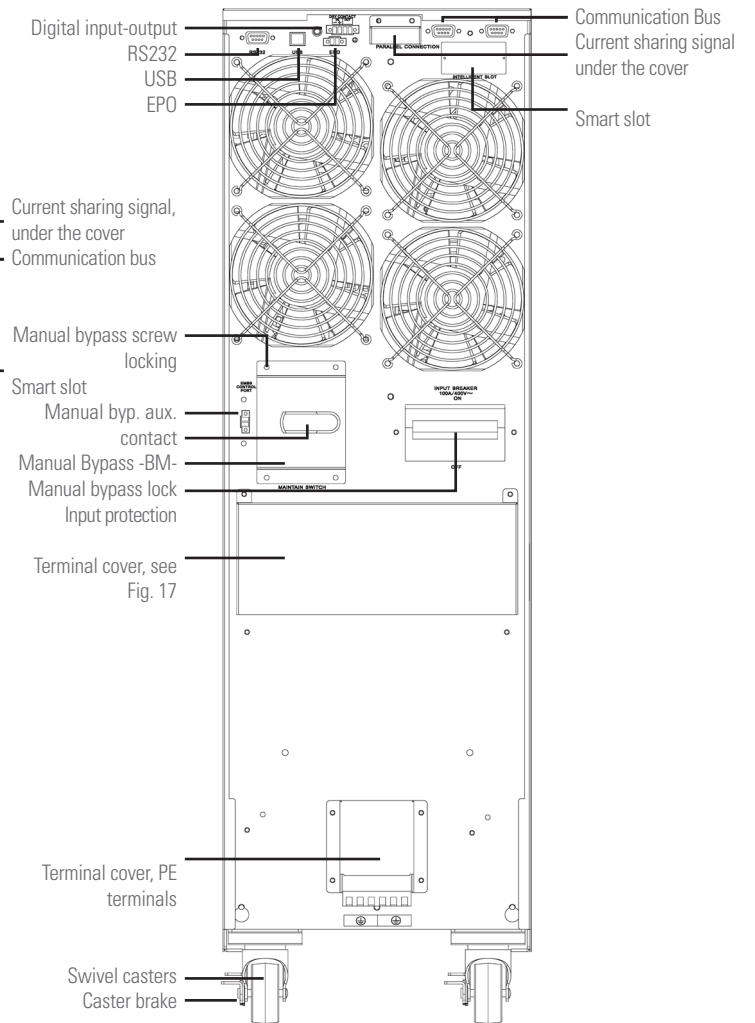

Standrd from 15 and 20 kVA. Three phase input and single phase output.

Fig. 2. Rear view for 4 to 20 kVA models.



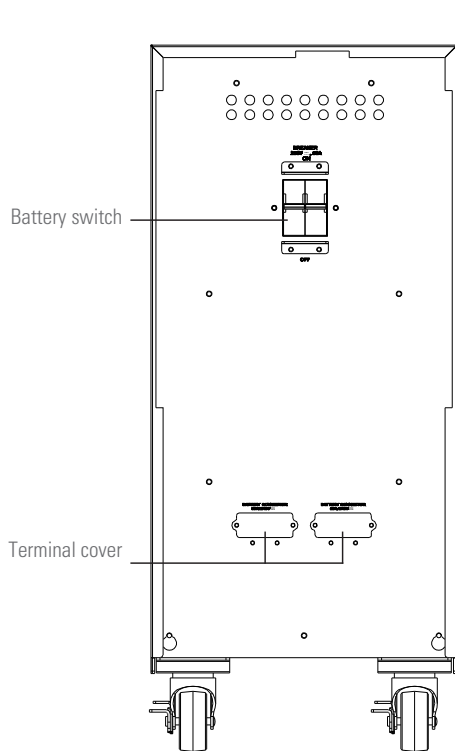

Battery module, size 1, with 2x20 batteries and 50 A protection.

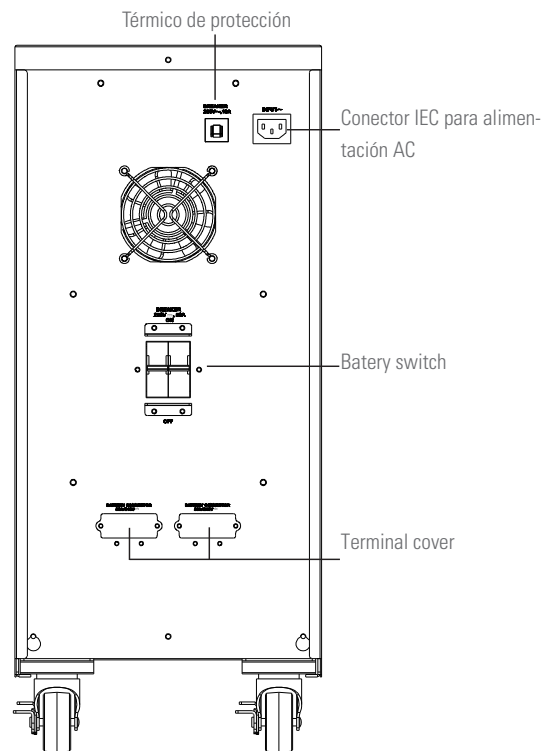

Battery module, size 1, with 3x20 batteries and 50 A protection.

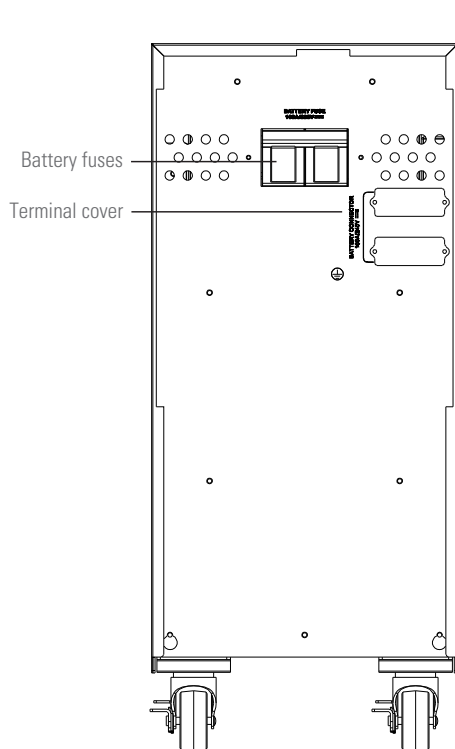

Battery module, size 1, with 2x20 batteries and 100 A protection.

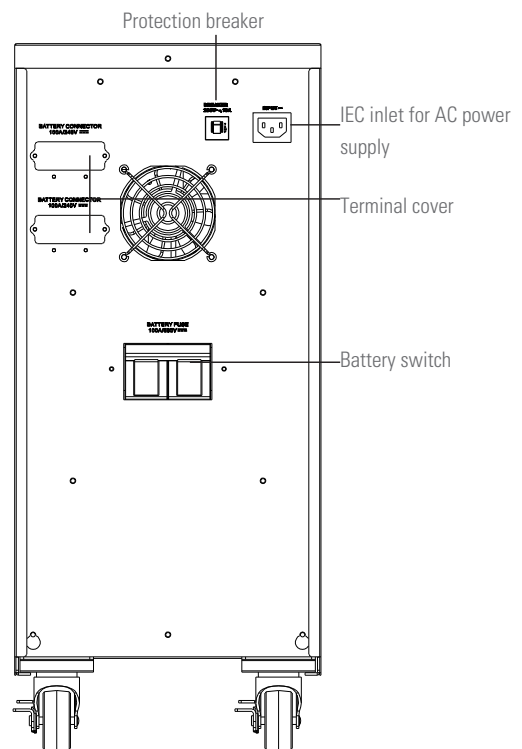

Battery module, size 1, with 3x20 batteries and 100 A protection.

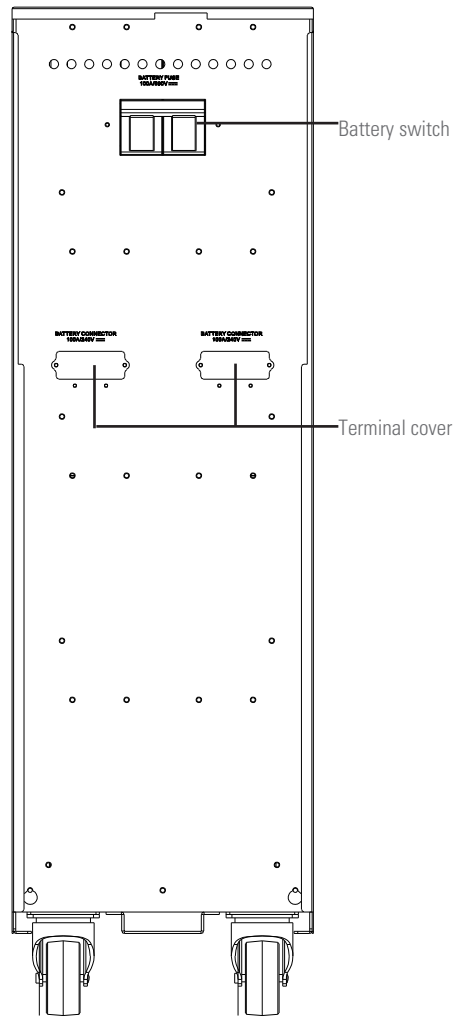

*Battery module, size 2 with 4x20 batteries  
and 100 A protection*

*Fig. 3. Rear view of the battery module.*

## 4.2. PRODUCT DEFINITION.

### 4.2.1. Nomenclature.

SLC-8000-TWIN/3 PRO2 B1 WCO 0/AB147 208/208V EE521925

|             |   |
|-------------|---|
| EE521925    | Particular specifications of the client.                                    |
| 208V        | Output voltage if it is not 220/230/240V AC.                                |
| 208V        | Input voltage if it is not 220/230/240V AC.                                 |
| 147         | Last three characters of the battery code.                                  |
| AB          | Family of the battery according to Salicru's code.                          |
| 0/          | Equipment with no batteries but with the needed accessories to fit them in. |
| CO          | "Made in Spain" marking in the UPS and packaging (custom issues).           |
| W           | Neutral equipment brand.  |
| B0          | No batteries and no space to install them.                                  |
| B1          | External batteries to the UPS enclosure and extra charger.                  |
| TWIN PRO2   | Single phase input - output configuration.                                  |
| TWIN/3 PRO2 | Three phase input / single phase output equipment.                          |
| 8000        | Power in VA.  |
| SLC         | Brand acronym.  |
| CF          | Frequency converter (equipment with no batteries).                          |

MOD BAT TWIN PRO2 2x3AB147 3x40A WCO EE521925

|           |   |
|-----------|---|
| EE*       | Particular specifications of the client.  |
| CO        | "Made in Spain" marking in the UPS and packaging (custom issue).                  |
| W         | Neutral equipment brand.  |
| 40A       | Protection size.  |
| 3x        | Quantity of fuses in parallel. Omitted for only one.                              |
| 147       | Last three characters of the battery code.  |
| AB        | Family of the battery according to Salicru's code..                               |
| 3         | Quantity of batteries in one string.  |
| 2x        | Quantity of strings in parallel. Omitted for only one.                            |
| 0/        | Battery module with no batteries, but with the needed accessories to fit them in. |
| TWIN PRO2 | Battery module series.  |
| MOD BAT   | Battery module.   |



#### Note concerning batteries:

B0 and B1 acronyms, stated in the nomenclature are related with the batteries:

- B0 The equipment is supplied with no batteries and no accessories (screws and electrical cables). Batteries belong to the client and they will be installed externally to the UPS enclosure. Under request, it is possible to supply these accessories, which are needed to interconnect them with the own the equipment.
- B1 Equipment with extra battery charger. The UPS is supplied with no batteries and no accessories

(screws and electrical cables). Under request, it is possible to supply these accessories, which are needed to interconnect them with the own the equipment.

Those equipments requested with no batteries, their purchasing, installation and connection will be borne by the client and **under his responsibility**.

Data concerning batteries in respect of quantity, capacity and voltage are stated in the battery label stucked beside the nameplate of the equipment, **respect this data and their polarity strictly** when connecting them.

### 4.3. OPERATING PRINCIPLE.

This manual describes the commissioning and operating of the Uninterruptible Power Supplies -UPS- from SLC TWIN PRO2 series as equipments that can operate in parallel or single configurations, without needing a centralised bypass. The UPS's from SLC TWIN PRO2 series assure an optimal protection for any critical load, keeping the power supply to the loads inside the stated parameters, with either no break in case of mains failure nor fluctuations. The wide range of available models (from 4kVA up to 20kVA), allows adapting the model to the end-user needs.

Thanks to the used technology, PWM (Pulse Width Modulation) and the double conversion, the UPS's from SLC TWIN PRO2 series are compact, cold, silent and with high efficiency. The double conversion principle cancels any fluctuations from the electrical mains. A rectifier converts the alternating current from mains in to direct current, and it keeps the optimal charge level to the batteries and at the same time feeds the inverter; the inverter generates a alternating current sinewave, which is ready to feed the loads constantly. In case of power outage at the UPS input, the batteries supply the energy to the inverter.

The UPS design and manufacturing from SLC TWIN PRO2 series has been done in accordance with the international standards.

These equipments allow their upgrading by connecting additional equipments of the same power rate in parallel, in order to get redundancy -i.e.: N+1- or increasing the power of the system.

Therefore, this series has been designed to maximize the availability of the critical loads in order to protect them against voltage fluctuations, power outages and blackouts, which are present in the energy distribution lines. This is the main aim of the UPS's from de SLC TWIN PRO2 series.

This manual applies to the standardised models stated in Tab. 1.

#### 4.3.1. Main features.

- True on-line technology of double conversion and independent output frequency from mains.
- Output power factor 1 in single phase input equipments and 0.9 in three phase input ones. Pure sinewave shape, suitable for almost all type of loads.
- Input power factor > 0.99 and high efficiency (> 0.94 for single phase input or > 0.92 for three phase input). So, it is got a high economy saving and lower installation cost -wiring-, as well as low input current distortion, so the perturbances to mains are reduced.
- Great adaptability to the worst conditions of input mains. Wide input voltage range, frequency range and wave shape, so it is avoided the excessive use of the battery, which has limited energy.
- Available battery charger up to 8 A in order to decrease the battery recharge time.
- Parallel redundant N+X connection, in order to increase the reliability and flexibility. 3 equipments in parallel as maximum.
- Selectable of the High Efficiency Mode > 0.97 -ECO-MODE-. Energy saving, which means economic saving for the end-user.

- Possibility to start it up with no mains or discharged batteries. Be careful, with this last point, because the back up time will be reduced, as much as they are more discharged.
- The smart battery management technology is very useful to extend the lifetime of the batteries and to optimise their recharging time.
- RS232 or USB communication ports as standard.
- Digital input to start up-shutdown the equipment.
- Digital output for «Error or fault».
- Remote emergency power off -EPO-.
- User-friendly interface between user and equipment by means of the control panel with LCD and LED.
- Optional available cards to improve the communication capabilities.

| Model                      | Type                              | Input/output topology             |                       |                       |
|----------------------------|-----------------------------------|-----------------------------------|-----------------------|-----------------------|
| SLC-4000-TWIN PRO2         | Standard                          | Single phase in/out               |                       |                       |
| SLC-5000-TWIN PRO2         |                                   |                                   |                       |                       |
| SLC-6000-TWIN PRO2         |                                   |                                   |                       |                       |
| SLC-8000-TWIN PRO2         |                                   |                                   |                       |                       |
| SLC-10000-TWIN PRO2        |                                   |                                   |                       |                       |
| SLC-15000-TWIN PRO2        |                                   |                                   |                       |                       |
| SLC-20000-TWIN PRO2        |                                   | Three phase in / Single phase out |                       |                       |
| SLC-8000-TWIN/3 PRO2       |                                   |                                   |                       |                       |
| SLC-10000-TWIN/3 PRO2      |                                   |                                   |                       |                       |
| SLC-15000-TWIN/3 PRO2      |                                   |                                   |                       |                       |
| SLC-20000-TWIN/3 PRO2      | No batteries                      | Single phase in/out               |                       |                       |
| SLC-4000-TWIN PRO2 (B0)    |                                   |                                   |                       |                       |
| SLC-5000-TWIN PRO2 (B0)    |                                   |                                   |                       |                       |
| SLC-6000-TWIN PRO2 (B0)    |                                   |                                   |                       |                       |
| SLC-8000-TWIN PRO2 (B0)    |                                   |                                   |                       |                       |
| SLC-10000-TWIN PRO2 (B0)   |                                   |                                   |                       |                       |
| SLC-15000-TWIN PRO2 (B0)   |                                   | Three phase in / Single phase out |                       |                       |
| SLC-20000-TWIN PRO2 (B0)   |                                   |                                   |                       |                       |
| SLC-8000-TWIN/3 PRO2 (B0)  |                                   |                                   |                       |                       |
| SLC-10000-TWIN/3 PRO2 (B0) |                                   |                                   |                       |                       |
| SLC-15000-TWIN/3 PRO2 (B0) |                                   |                                   |                       |                       |
| SLC-20000-TWIN/3 PRO2 (B0) |                                   |                                   |                       |                       |
| SLC-4000-TWIN PRO2 (B1)    |                                   |                                   | Extended back up time | Single phase in / out |
| SLC-5000-TWIN PRO2 (B1)    |                                   |                                   |                       |                       |
| SLC-6000-TWIN PRO2 (B1)    |                                   |                                   |                       |                       |
| SLC-8000-TWIN PRO2 (B1)    |                                   |                                   |                       |                       |
| SLC-10000-TWIN PRO2 (B1)   |                                   |                                   |                       |                       |
| SLC-15000-TWIN PRO2 (B1)   |                                   |                                   |                       |                       |
| SLC-20000-TWIN PRO2 (B1)   | Three phase in / Single phase out |                                   |                       |                       |
| SLC-8000-TWIN/3 PRO2 (B1)  |                                   |                                   |                       |                       |
| SLC-10000-TWIN/3 PRO2 (B1) |                                   |                                   |                       |                       |
| SLC-15000-TWIN/3 PRO2 (B1) |                                   |                                   |                       |                       |
| SLC-20000-TWIN/3 PRO2 (B1) |                                   |                                   |                       |                       |

Tab. 1. Standardized models.

## 4.4. OPTIONS.

Depending on the selected configuration, the equipment can include any of the following options:

### 4.4.1. Isolation transformer.

The isolation transformer, provides a galvanic isolation that allows isolating the output from input completely and/or even change the neutral regime.

The fact of having an electrostatic shield between the primary and secondary windings of the transformer provides a high attenuation level of the electrical noise.

Physically, the isolation transformer can be located at the input or output of the UPS, depending on the particular specifications of the installation (equipment power supply and/or loads, type of loads,...).

In parallel systems, it is not possible to operate with separate isolation transformers for each UPS. So it is necessary to have only one transformer for the complete parallel system of the suitable power rate.

In any case, it will always be supplied as a separate item to the own UPS enclosure.

### 4.4.2. External manual bypass manual.

The purpose of this option is to isolate electrically the equipment from mains and critical loads with no break. Therefore the maintenance or reparation tasks can be done in the equipment with no breaks in the power supply of the protected system and at the same time undue risks to the technical staff are avoided. The basic difference, between this option and the integrated manual bypass in the own UPS enclosure is its better operability, because it allows the total disconnection of the UPS from the installation.

### 4.4.3. Communication card.

In the rear side of the UPS there is a slot, which allows inserting any of the following communication cards.

#### 4.4.3.1. Integration into IT networks by means of the SNMP adaptor.

The large-scale IT systems based in LANs and WANs, which integrates servers with different operating systems, must include an easy control by the management of the system. This feature is get by the use of the SNMP adaptor, which is accepted by the main manufacturers of software and hardware.

The connection of the UPS with the SNMP is internal, meanwhile the connection between the SNMP and the IT network is done by means of a RJ45 10 base connector.

#### 4.4.3.2. RS485 Modbus.

Many times, the large-scale IT systems based in LANs and WANs require communication by means of a industrial standard protocol with any part or component integrated inside the IT network.

One of the most used industrial protocols in the market is the MODBUS protocol. The SLC TWIN PRO2 series is ready to be integrated in this kind of environments either by means of the

“SNMP mini card” adaptor or the RS485 Modbus card which is described in the documentation of the optional.

#### 4.4.3.3. Dry contacts.

- As an option, the UPS has a dry contact card, which provides digital signals, with maximum applicable voltage and current of 240 V AC or 30 V DC and 1A.
- This port provides a dialogue between the equipment and other machines or devices, thanks to the supplied dry contacts, which includes a terminal strip located in the own card, with only one common terminal for all of them. All the dry contacts are normally opened, preset from factory, being able to set them independently, according to the information supplied with the option.
- The most common use of these type of ports is to provide the needed information to the closing file software.
- For information, contact with our **T.S.S.** or our closest distributor.

## 5. INSTALLATION.

-  Read and respect the Safety Information, described in section 2 of this document. The fact of ignoring any of the indications described in it, can cause serious accidents or very serious injuries to the persons in the vicinities in direct contact, as well as damages to the equipment and/or loads connected to itself.
- A part from the own user's manual of the equipment, the CD-ROM or Pen Drive contents other documents, which have to be consulted and followed strictly.
- Unless otherwise indicated, any action, indications, notes and other ones are applicable to the equipments, never mind if they belong to a parallel system or not.

### 5.1. EQUIPMENT RECEPTION.

-  It is dangerous to handle the equipment over the pallet with no caution, because it could tip over or cause serious injuries to the operators due to the impact of the fall and/or entrapment. Pay attention to section 1.2.1. from Safety Instructions -EK266\*08- regarding handling, moving and location of the equipment.
- Use the most suitable medium to move the UPS meanwhile it is still packaged, by means of pallet jack or forklift.
- Any equipment handling will be done keeping in mind the weights and technical features of the model, stated in section «9. Annexes».

#### 5.1.1. Reception, unpacking and contents.

- Reception. Check the following:
  - Data in the labelling of the packaging are the same as the stated in the purchase order. Once the UPS is unpacked, check previous data with the nameplate of the equipment.  
In case of discrepancies, make the non-conformity as soon as possible by quoting the serial number of the equipment and the delivery note reference.
  - No damage during transport (packaging and impact indicator correct).  
Otherwise, follow the stated protocol in the labelling beside the impact indicator, located in the packaging.
- Unpacking.
  - To check the contents, the packaging must be removed.  
 Complete the unpacking procedure according to section 5.1.3.
- Contents.
  - The own equipment.
  - User's manual in IT support: [CD-ROM] or [Pen Drive].
  - 1 communication cable.
  - 2 cables for parallel connection, current bus and control signal.
  - 1 female connector to connect into the external EPO. It includes an isolated cable as a «bridge» mode to close the circuit (already fitted in).
- Once the reception is finalised, it is better to pack the UPS again till its commissioning in order to protect it against possible mechanical impacts, dust, dirt, etc...
- The equipment packaging has wooden pallet, cardboard or wooden enclosure depending on the requirements, ex-

panded polystyrene corners, plastic bag and polyethylene wrap, all of them are recyclable materials. When they have to be disposed proceed in accordance with the laws in force.

It is advised to keep the packaging, for 1 year at least.

#### 5.1.2. Storage.

- The storage of the equipment will be done in a dry and cool room, protected from rain, dust, water jets or chemical agents. It is advisable to keep each equipment and battery unit inside their original packaging, because they have been designed to assure the maximum protection during transport and storage.
-  Those equipments, which include Pb-Ca batteries, the recharging period of time according to the storage temperature, stated in Tab. 2 from EK266\*08 document, must be respected. Otherwise the warranty will be cancelled.
- After this period of time, connect the equipment with the batteries unit, if any, and start it up according to the instructions described in this user's manual and charge them for 12 hours.  
In parallel systems, to charge only the batteries, it is not needed to make the connection among the equipments. Proceed as complete single equipments to charge them.
- Later on, shutdown the equipment, disconnect it and pack the UPS and batteries in their original packaging again, by writing down the new recharging battery date in any document or over the own packaging as a record mode.
- Do not store the devices, where the temperature exceeds over 50° C or below -15° C, because the electrical features of the batteries can be affected.

#### 5.1.3. Unpacking.

- The equipment packaging has wooden pallet, cardboard or wooden enclosure depending on the requirements, expanded polystyrene corners [EPS] or polyethylene foam [EPE], plastic bag and polyethylene wrap, all of them are recyclable materials. When they have to be disposed proceed in accordance with the laws in force.  
It is advised to keep the packaging, in case it was to be used in future.
- Equipments with single phase input TWIN PRO2 or three phase input TWIN/3 PRO2 up to 10 kVA.
  - To unpack the equipment follow the sequence from figure 4 to 7 (cut the wraps of the cardboard enclosure and remove it from the top as it was a cover or in case of wooden packaging, dismantle it with the needed tools; remove the corners and plastic bag. The UPS will be naked over the pallet.
  - With the help of one or two people in each side of the UPS, download it from the wooden pallet.

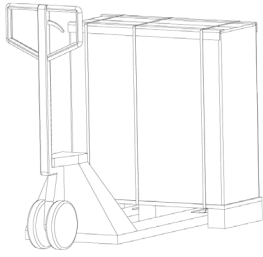

Fig. 4.

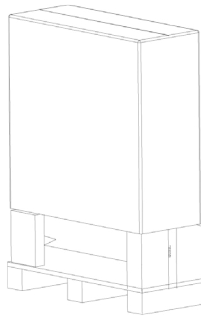

Fig. 5.

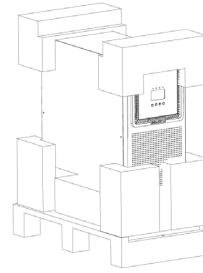

Fig. 6.

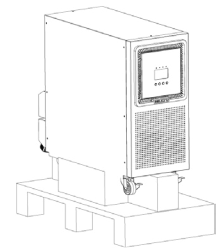

Fig. 7.

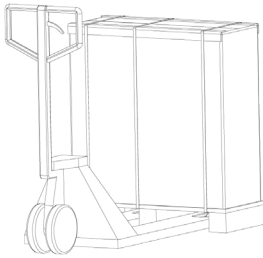

Fig. 8.

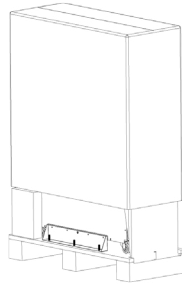

Fig. 9.

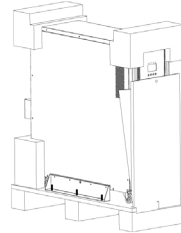

Fig. 10.

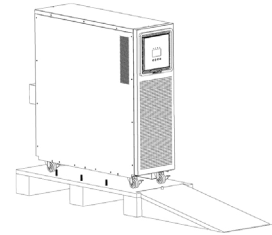

Fig. 11.

- Equipments with three phase input TWIN/3 PRO2
  - ❑ To unpack the equipment, follow the sequence of figures 8 to 10 (cut the wraps of the cardboard enclosure and remove it from the top as it was a cover or in case of wooden packaging use the needed tools; remove the corners and plastic bag. The UPS will be naked over the pallet.
  - ❑ The equipment is fixed to the wooden pallet by means of metallic support with «L» shape (stabilising support), fixed at each side of the equipment.
  - ❑ Remove the screws that fix the equipment to the pallet by means of the support [see Fig. 12 and 13].
  - ⚠ Before downloading the equipment from the pallet, the stabilising supports have to be removed first, otherwise they will make difficult the downloading procedure and they will be bent when impacting with the wooden ramp, being able to cause damages to the own structure of the equipment.
  - ❑ Put the ramp as figure 11 shows and download the equipment from the pallet.

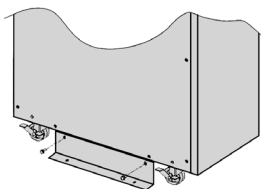

Fig. 12.

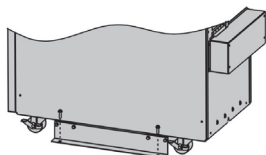

Fig. 13.

#### 5.1.4. Transport till its location.

- All the equipments have four casters (with mechanical lock), so it is easy to move it till its right location once it is unpacked. Nevertheless, if the reception area is far from the installation location, it is recommended to move the UPS by means of a pallet jack or the most suitable transport medium, keeping in mind the distance between both points. In case of long distances, it is recommended to move the equipment with its packaging till the installation location and finally unpack it there.

#### 5.1.5. Location, immobilising and considerations.

##### 5.1.5.1. Location for single units.

- As an example, Fig. 14 shows the typical case depending on the model. The equipment based on one single phase (UPS with batteries fitted in) and UPS with the batteries in a separate case or extended back up times.
  - ❑ For a correct cooling, the space around the equipment must be free of obstacles. Respect the minimum distances stated in Tab. 1 from section 1.2.1 of the document EK266\*08 (Safety Instructions), where the figures of each dimension A, B, C and D are stated according to the power rate of each equipment. For the battery cases, keep the same distances as the same UPS enclosure.
  - ❑ It is recommended to leave 75 cm additional free in each side, for the possible tasks of the **(T.S.S.)** or the needed power cable length to facilitate the movement of the equipment to the front.

For extended back up times, with more than one case, it is recommended to put one at each side of the equipment and in case of a higher quantity proceed in the same way alternately.

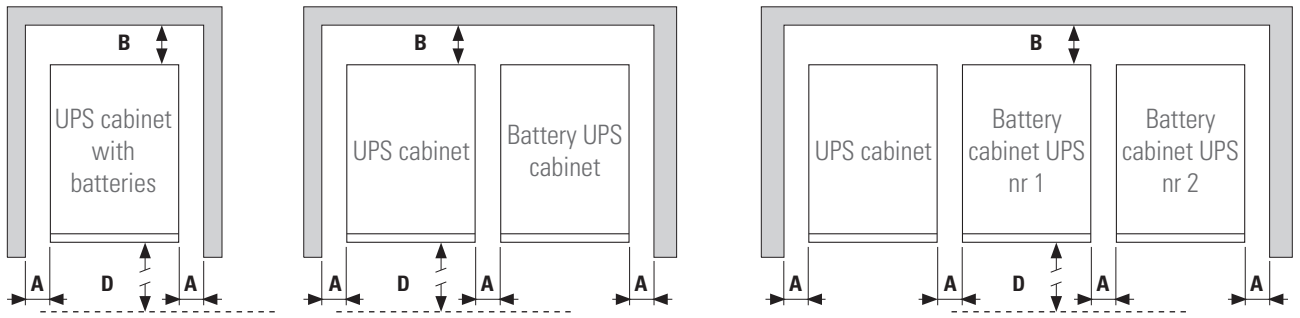

Fig. 14. Minimum distances for a correct UPS cooling.

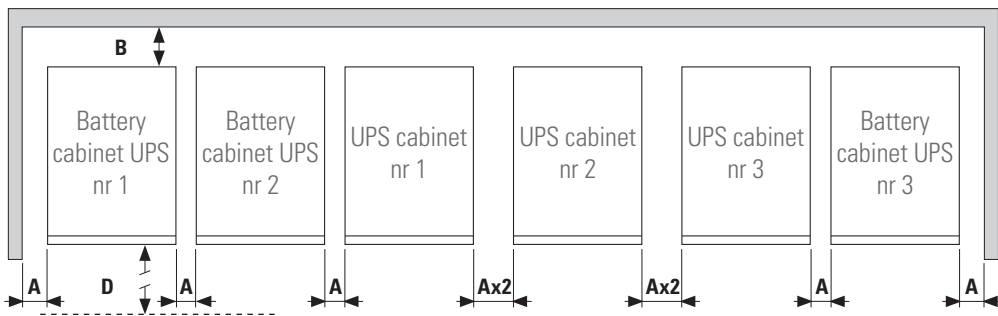

Fig. 15. Minimum distances for a correct UPS system cooling.

#### 5.1.5.2. Location for parallel systems.

- As an example of three equipments in parallel, Fig. 15 shows them with their battery case. For systems with two equipments in parallel and/or more battery modules proceed accordingly in the same way. Likewise, obviate the illustration of the battery modules when they are not available. The numbering of the equipments in Fig. 15 doesn't have any purpose less than number each unit in the illustration.
- For a correct cooling, the space around equipment must be free of obstacles. Respect the minimum distances stated in Tab. 1 from section 1.2.1 of the document EK266\*08 (Safety Instructions), where the figures of each dimension A, B, C and D are stated according to the power rate of each equipment. For the battery cases, keep the same distances as the UPS enclosure.

#### 5.1.5.3. Immobilising the equipment.

- The equipment has casters with brakes. Once the equipment is placed in its final location, to immobilise the equipment is recommended to lock them.

#### 5.1.5.4. Preliminary considerations, before connecting the equipment.



- In the description of this manual, there is reference to connect terminals and manoeuvring switches, which are only available in some models or equipments with extended back up times. Ignore those operations related with your

unit in case it does not have them.

- Regarding the installation instructions of a single equipment or parallel system, follow and respect them.
- The switchgear or external manual bypass panel:
  - At least, the installation will have one protection for the short-circuit in the power supply line of the UPS.
  - For single equipments, it is recommended to install an external manual bypass panel, equipped with input, output and manual bypass protections.
  - For parallel systems, **it is essential** to install a switchgear or manual bypass panel. The switches of the panel must allow isolating one UPS from the system, in case of any failure and allow feeding the loads with the rest ones, either during the preventive maintenance tasks or during the failure and its reparation.
- An external manual bypass panel for a single unit or parallel system can be purchased under request. Also, it can be manufactured by yourself by keeping in mind the version and configuration of the available equipment or system and the attached documentation in the CD-ROM or el Pen Drive as regards to «Recommended installation diagram».
-  The documentation delivered together with this user's manual and/or CD-ROM or Pen Drive, includes information regarding the «Recommended installation diagram» for each input and output configuration. This documentation shows the wiring circuit diagrams, as well as the protection and cross cable sizes that are connected to the equipment, considering the nominal voltage. All the figures are calculated for a **total maximum cable length of 30 m** between the switchgear panel, equipment and loads.
  - For longer lengths, correct the cross cable sections in







accordance with the Regulations or standards of the country, in order to avoid dropping voltages.

- ❑ In the own documentation and for each configuration, it is available the information for «N» equipments in parallel, as well as the features of the «Backfeed protection».
-  In parallel systems, the length and cross cable section that connect the switchgear or manual bypass panel with each UPS must be the same for all of them, with no exception.
- The cross cable section must be always according to the size of the own terminals of the switches, in such way that the wire is embraced properly, in order to guarantee an optimal contact between both parts.
- The data in the nameplate of the equipment states the nominal current only, as the safety standard EN-IEC 62040-1 states. To calculate the input current, it has been considered the power factor and the own efficiency of the equipment.  
The overload conditions are considered as a non-permanent and exceptional operating mode, so it will not be kept in mind when sizing the protections. Do not connect devices to the UPS terminals or outlets that could overload it, like motors.
-  TWIN/3 PRO2 models (three phase input and single phase output), the input current of R phase and Neutral is higher than the other two lines/phases when the UPS works on bypass mode (loads supplied from mains directly). Pay attention to the nameplate data to size the two corresponding cables.
- In case of adding peripheral parts at the UPS or parallel system input or output, like transformers or autotransformers, the stated currents in their own nameplates must be also considered, in order to use the suitable cross cable section, by respecting the Local and/or National Low Voltage Electrotechnical Regulation.
- When a UPS or parallel system, as standard, as an option or installed by yourself, at the input line or at the output or in both, include a galvanic isolation transformer, a Residual Current Device must be installed at its output, in order to protect against electrical shocks and indirect contacts, because its intrinsic feature of isolation will prevent the tripping of the protections fitted in the primary winding of the transformer.
- As a reminder, all the isolation transformers installed or supplied from factory has the output neutral connected to the protective earth by means of a cable bridge between the neutral and PE terminals. In case of requiring an isolated output neutral, remove this cable bridge, by taking the stated cautions in the local and/or national low voltage regulations.
-  This equipment is ready to be installed in grids with power distribution systems TT, TN-S, TN-C or IT, keeping in mind the particular features of each neutral regime and the electrical regulations of the destination country.
- The switches, RCD and circuit breaker of a three phase input equipment connected to an IT power distribution system must break the NEUTRAL apart from the three phases.
- TWIN PRO2 has a terminal strip to install an external emergency power off button -EPO-. Only one device has to be

fitted in, in order to break the energy to the loads in any operating mode.

#### 5.1.5.5. Preliminary considerations for batteries and their protections before connecting the equipment.

- All the standard UPSs include batteries in the same enclosure, less those models called B0 and B1. For the standard UPSs, the battery protection is done by internal fuses and they are not accessible by the end-user.  
Also, the battery modules have protection and in this case they are doubled. Once are internal by means of fuses and not accessible by the end-user and the second ones by means of a two poles circuit breaker or fuses.
-  IMPORTANT FOR THE SAFETY: In case of installing the batteries by yourself, the battery set must have a two poles circuit breaker or fuses switch, with the size stated in Tab. 2.
- Inside the battery module there are DANGEROUS VOLTAGES with the risk of electrical shock it involves, so it is classified as RESTRICTED ACCESS AREA.
-  Do not handle the battery fuse holder or circuit breaker switch when the equipment is turned ON. These switches **cannot be turned ON/OFF with load**.
-  When the power supply to the equipment or parallel system is broken and it is foreseen an out of service of the equipment for long time, the equipment must be shutdown completely.
-  The battery circuit is not isolated from the input voltage. So, dangerous voltages can be found between the battery terminals and the earth. Check that there is not any kind of voltage, before doing any action over the terminals.

#### 5.1.5.6. Connection parts.



- Any electrical connection of the equipment is done through the rear side of the equipment:
  - ❑ Input and output connection terminals. Remove the fixing screws of the protection cover and the own cover, to have access to the terminals.
  - ❑ Connect the UPS with the battery modules. Depending on the power rate of the UPS, it has a connector or terminals.
    - Equipment and battery module with connector. Remove the screws and the «BATTERY CONNECTOR» cover. These covers will not be put back again, keep them.
    - Equipment with battery terminals. They are beside the AC power terminals.
    - Battery module with terminals. Remove the screws and protection cover.
  - ❑ Communication connectors:
    - DB9 type for RS232.
    - USB type for communication as a peripheral.
    - Digital input and output.
    - Terminal strip for external EPO button.
    - Auxiliary contact for manual bypass switch.
  - ❑ Control connections for parallel systems, by DB15 connectors and analogical signal for current sharing. Remove the screws and the protection cover to have access to them.

- Slot to insert one of the optional communication cards. Remove the fixing screws and the plastic cover to allow its inserting.
-  When finalising the connection tasks, the cover or covers and their fixing screws will be put back before commissioning the equipment, in order to avoid accidents due to direct contacts.
- It is recommended the use of crimping pin terminal in all the cable ends connected to terminals, in particular the power ones (input, output and batteries).
- Check the correct torque in the screws of the terminals.

## 5.2. CONNECTION.

- The terminal protection cover leaves a slot for the cable entering to the power terminal strip. The cover and/or enclosure frame has drills that allows fixing the connection cables in order to avoid unexpected cable pulling due to the consequences that it could have.

### 5.2.1. Connection of the input terminals to AC power supply.

-  As this is an equipment with protection against electrical shocks of class I, it is essential to connect the main protective earth cable . Connect this cable to the terminal before supplying voltage to the input terminals.
- Pay attention to the «Recommended installation» document in section 5.1.5.4., which states the cross cable section, protection size and features, etc, ...

- In accordance with the EN-IEC 62040-1 safety standard the installation must have an automatic «Backfeed protection» system, i.e.: a contactor, which prevents power supply or dangerous energy at the UPS input during a power outage [see Fig. 16].

The standard applies to single or three phase input equipments as well as both single units and UPSs in a parallel systems.

-  Do not connect any line between the «Backfeed protection» and UPS, because the safety standard would not be met.
- Warning labelling must be placed in all the primary power switches, installed far from the equipment, in order to warn the electrical maintenance staff about the presence of a UPS in the electrical circuit.

The labelling will include the following text or an equivalent one:

**Before operating in the circuit.**

- Isolate the Uninterruptible Power Supply (UPS).
- Check that the voltage among the terminals, PE included.

 **Risk of UPS voltage backfeed.**

- Connect the input cables to the respective power terminal strip depending on the available equipment [see Fig. 17]. For parallel systems, it will be needed to repeat the connections that go from the switchgear panel to each equipment.

#### □ **Connection to a single phase input:**

Connect the power supply cables to the R and N input terminals, **by respecting the phase rotation of the neutral and phase** stated in the labelling of the equipment and this manual. Otherwise it can be damaged.

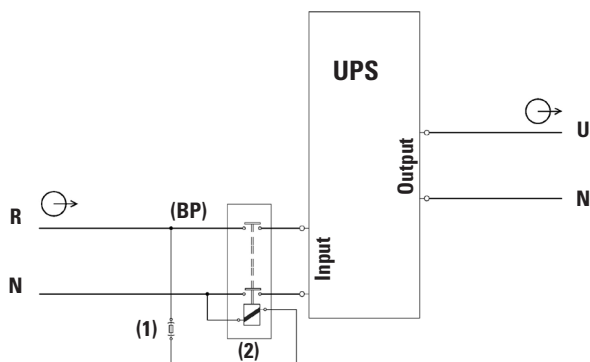

«Backfeed protection» connection for TWIN PRO2.

(BP) Automatic «Backfeed protection» system, external to the UPS (EN-IEC 62040-1).

(1) General purpose fuse or fuses with size 600V AC and 1A of type F.

(2) Two or four poles contactor of 400V AC with minimum distance among the contacts of 1.4 mm and 230V AC coil, with minimum current size of the stated one in the UPS nameplate.

 For parallel systems, each equipment must have its own "Backfeed protection" separately.

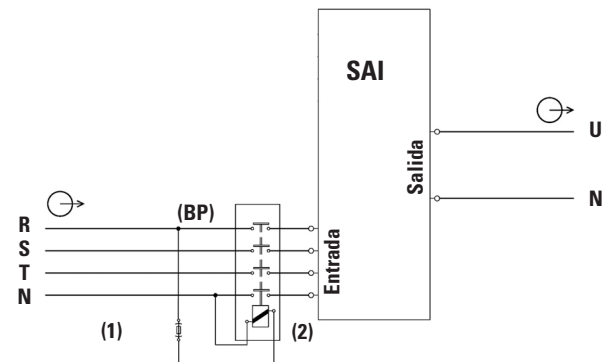

Conexión «Backfeed protection» para TWIN/3 PRO2.

Fig. 16. «Backfeed protection» circuit diagram.

In 15 and 20 kVA equipment, the R phase cable will be connected to the plate and the neutral cable to terminal N.

- ❑ **Connection to a three phase input:**  
Connect the power supply cables to the R, S T and N input terminals, **by respecting the phase rotation of the phases and neutral** stated in the labelling of the equipment and this manual. Otherwise it can be damaged.

In case of discrepancies between the labelling and the instructions of this manual, the first ones will always prevail.

## 5.2.2. Connection of load/s to the output terminals or output 1.

- ⚡ As this is an equipment with protection against electrical shocks of class I, it is essential to connect the main protective earth cable (⚡). Connect this cable to the terminal before supplying voltage to the input terminals.
- Pay attention to the «Recommended installation» document in section 5.1.5.4., which states the cross cable section, protection size and features, etc. ...
- Connect the loads to the output power terminals or output 1, U and N, **by respecting the rotation of the phase and neutral** stated in the labelling of the equipment and this manual [see Fig. 17]. Otherwise the UPS and/or load/s can be damaged.
- For parallel systems, it will be needed to repeat the connections that go from the switchgear panel to each equipment. In case of discrepancies between the labelling and the instructions of this manual, the first ones will always prevail.
- As regards to the output protection to be fitted in the switchgear or manual bypass panel, it is recommended to split the output power into four different lines. Each one of them will have a circuit breaker sized to the suitable figure. This type of energy distribution at the output will allow that in case of tripping one of them due to a problem in one of the connected loads in that line, will not affect to the other ones. Because the rest of loads will have their power supply continuously, because the only protection that will trip will be the affected one by the short-circuit in their loads.
- The single phase input equipments up to 10 kVA, apart from the power terminal strip, also has two IEC outlets protected by a 10 A breaker.  
These outlets are connected in parallel with the output terminals, so it is important to pay attention to the following consideration:

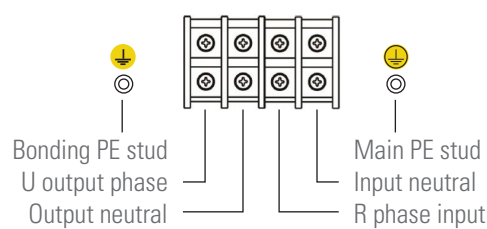

(\*) **Special features of these terminals according to models:**  
Not available in models of up to 10 kVA.  
Not useful in models of 15 and 20 kVA III / II standard.  
Implied connection in models of 15 and 20 kVA III / II B1.

TWIN PRO2 4.. 10 kVA power terminal strip

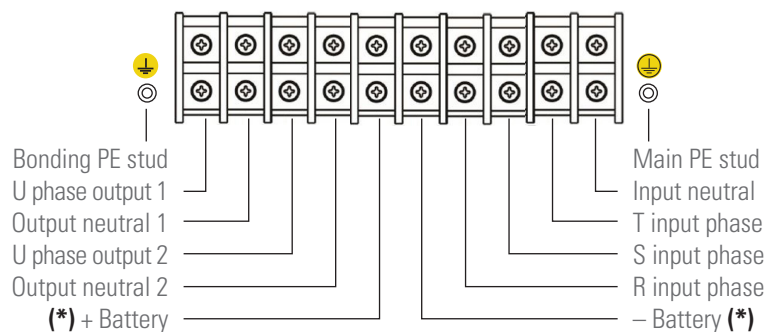

TWIN/3 PRO2 8.. 20 kVA power terminal strip

Fig. 17. Power terminal strip.

- ❑ **i** The size of the output protection stated in the recommended installation document, is done for the loads connected at the output power terminals. This protection will be adapted by the fitter or end-user to the installation in case part of the power is connected to the IEC outlets, otherwise it is possible that the input of the UPS will not trip, although the overload alarm in the UPS is triggered.

## 5.2.3. Connection of the load/s to the output terminals 2 (TWIN/3 PRO2 from 8 to 20 kVA only).

- Models from 8 to 20 kVA with three phase input has a second set of output power terminals labelled as output 2, which supply voltage from the same source of output 1, from the inverter or static bypass.  
By means of the control panel the output 2 can be set as Non-critical loads (set to «On»).
- ⚠ When setting the output 2 to Non-critical loads, the back up time is reserved for the most critical loads, which are connected to output 1, by breaking the power supply of the output 2 during power outages.
- **i** The size of the output protection stated in the recommended installation document, is the sum of both output 1 and 2, which does not exceed the power rate of the UPS in any case.
  - ❑ In case of using both terminal strips, the installer or end-user will fit the suitable protection at each output, otherwise the input protection of the equipment could trip, apart from triggering the overload alarm.
- In parallel systems check that the Output 2 is set to the same figure in all of them, in order to avoid problems.
- Connect the loads to the output power terminals 2, U and N, **by respecting the rotation of the phase and neutral** stated in the labelling of the equipment and this manual [see Fig. 17]. Otherwise the UPS and/or load/s can be damaged.

### 5.2.4. Connection with the external battery module and extended back up times.

- ⚡ As this is an equipment with protection against electrical shocks of class I, it is essential to connect the main protective earth cable (⚡). Connect this cable to the terminal before supplying voltage to the input terminals.
- ⚡ Respect the instructions stated in this section and those ones referred to the batteries in the EK266\*08 safety instructions, section 1.2.3, because risk of electrical shock exists, which can cause even the death.
- ⚡ Before starting the connection procedure between the battery module or modules and the equipment, check that the UPS input switch and the battery protection in the module or modules are turned « Off».
- ⚡ The battery module has been designed for its equipment. Do not modify the battery capacity or quantity that makes it.  
Also, it exists risk of electrical or electrocution shock due to the high internal DC voltage, which can cause serious injuries for the health and life.
- Do not connect the battery modules between them or with UPSs with different DC voltage (figure stated in the rear side of each equipment).
- Tab. 3 states the physical connection between the UPS and the battery module or modules.

| Model                 | Batteries<br>( $U_{bat. block} \times N^{\circ} = U_{nominal} / U_{floating}$ ) | Two poles switch |             |
|-----------------------|---|------------------|-------------|
|                       |   | DC voltage(V)    | Current (A) |
| SLC-4000-TWIN PRO2    | (12 V x 20) = 240 V / 275 V   | 440              | 20          |
| SLC-5000-TWIN PRO2    |   |                  | 25          |
| SLC-6000-TWIN PRO2    |   |                  | 32          |
| SLC-8000-TWIN PRO2    |   |                  | 40          |
| SLC-10000-TWIN PRO2   |   |                  | 50          |
| SLC-15000-TWIN PRO2   |   |                  | 63          |
| SLC-20000-TWIN PRO2   |   |                  | 100         |
| SLC-8000-TWIN/3 PRO2  |   |                  | 40          |
| SLC-10000-TWIN/3 PRO2 |   |                  | 50          |
| SLC-15000-TWIN/3 PRO2 |   |                  | 63          |
| SLC-20000-TWIN/3 PRO2 |   |                  | 100         |

Tab. 2. Features of the protection to install in the battery set belonging to the end-user.

- All the standard UPSs include batteries in the same enclosure, less those models called B0 and B1. For the standard UPSs, the battery protection is done by internal fuses and they are not accessible by the end-user.  
Also, the battery modules have protection and in this case they are doubled. Once are internal by means of fuses and not accessible by the end-user and the second ones by means of a two poles circuit breaker or fuses
- ⚡ **IMPORTANT FOR THE SAFETY:** In case of installing the batteries by yourself, the battery set must have a two poles circuit breaker or fuses switch, with the size stated in Tab. 2.
- The connection of the UPS with the battery module will be done with the supplied cable bundle. First connect one

cable end to the UPS terminals or connector and then the other cable end to the battery module terminal or connector. See Fig. 18, as an example.

- ❑ Equipments with connectors, there is not any possibility of wrong polarity connection.
- ⚡ For the equipments with terminals, respect the polarity and the colour of the cables (red for positive, black for negative and green-yellow for PE) stated in the labelling of each module and this manual.
- When more than one battery module for the UPS is supplied, the connection among them will be in parallel.

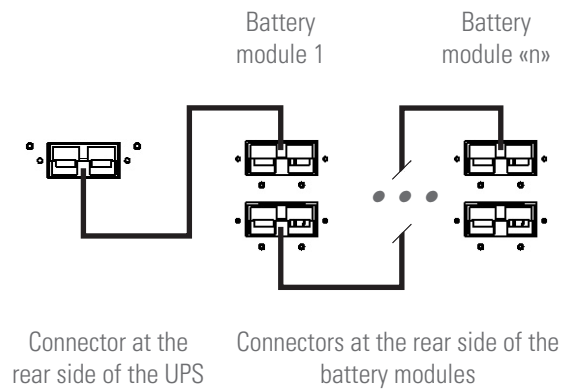

Fig. 18. Example of connection between a UPS and battery modules with connectors.

- In extended back up times, to make easier the connection between the UPS and the battery modules in parallel, all the battery modules have two connectors or terminal strips.
- Models with terminals, the polarity and colour of the cables (red for positive and black for negative) must always be respected.
- ⚡ Each battery module is totally independent for each equipment. **It is completely prohibited to connect two equipments to the same battery module.**







| Model                 | Connection mode with the batteries |                                |
|-----------------------|------------------------------------|--------------------------------|
|                       | In the UPS                         | In the external battery module |
| SLC-4000-TWIN PRO2    | Connector                          |                                |
| SLC-5000-TWIN PRO2    |                                    |                                |
| SLC-6000-TWIN PRO2    |                                    |                                |
| SLC-8000-TWIN PRO2    |                                    |                                |
| SLC-10000-TWIN PRO2   |                                    |                                |
| SLC-8000-TWIN/3 PRO2  |                                    |                                |
| SLC-10000-TWIN/3 PRO2 | Terminal strip                     | Connector                      |
| SLC-15000-TWIN PRO2   |                                    |                                |
| SLC-20000-TWIN PRO2   |                                    |                                |
| SLC-15000-TWIN/3 PRO2 |                                    |                                |
| SLC-20000-TWIN/3 PRO2 |                                    |                                |

Tab. 3. Connection between the UPS and battery module or modules.

### 5.2.5. AC power supply for the battery charger built in the battery module.

- Some battery modules have an additional charger, which means making some additional work. They can be identified, because they include an IEC male connector, circuit breaker and cooling grid
- Together with the module, it is supplied a power cord with an IEC female connector in one end and Schuko plug in the other end.
- The installation must have a wall outlet, schuko type, protected by a circuit breaker of 6 A, in order to feed the charger with 230 V AC.
- Those equipments with more than one battery module of this type, each one of them must have the Schuko wall outlet with its corresponding protection.
- Insert the cable into the IEC connector of the battery module and the schuko plug into the wall outlet of 230 V AC.

### 5.2.6. Connection of the main protective earth and bonding earth .

-  As this is an equipment with protection against electrical shocks of class I, it is essential to connect the main protective earth cable . Connect this cable to the terminal before supplying voltage to the input terminals.
- Make sure that all the loads connected to the UPS are only connected to its bonding earth stud . The fact of not limiting the connection this bonding earth of the load or loads and battery module or modules to this **single point**, will break backfeed loops of earth that will decrease the quality of the energy supplied.
- Those terminals labelled as bonding earth , are joined among them to the main protective earth stud  and to the ground of the equipment.
-  Never and under no circumstances disconnect the protective earth cable from the building and/or UPS.

### 5.2.7. EPO terminals (Emergency Power Off).

- The UPSs has two terminals to install a remote Emergency Power Off button -EPO-.
- The equipment is delivered from factory with the EPO circuit closed -NC-. So, the UPS will break the output when the emergency power off button opens the circuit:
  - Or by removing the own female connector from the equipment, because this connector includes a cable as a bridge mode, which closes the electrical circuit [see Fig. 19-A].
  - Or when pressing the external button, which belongs to the end-user and it is installed between the terminals of the connector [see Fig. 19-B]. The connection of the button will be normally closed -NC-, so it will open the electrical circuit when pressing it.
- By means of the communication software, the inverse function can be set.  
Less particular cases, it is better to not use this type of connection, because in case of one of the cables were cut, the EPO will not break the output voltage.

On the other hand, the use of the normally closed contact, the cut cable would be detected immediately, because the power supply to the loads would be broken.

- To restore the normal operating of the UPS, it is needed to insert the connector with the cable as a bridge mode again in the equipment or deactivate the EPO button. The equipment will be turned ON automatically.

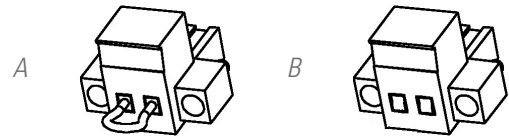



Fig. 19. Connector for the external EPO.

### 5.2.8. Terminals for digital Input and Output.

- The equipment has a terminal strip of four terminals for a digital input and output [see Fig. 20].
  - The «Start up-Shutdown» digital input. When the equipment is turned ON, when applying a voltage between 5 and 12 V DC, it is shutdown.
    -  The static bypass is enabled from factory. In this situation, when the inverter is shutdown the output terminals will supply voltage through the internal static bypass. Disable the bypass function through the control panel, when it is required to break the output when the shutdown order has been triggered.
  - Error or fault dry contact. Any error or fault of the UPS will trigger the digital output (-NO- dry contact of 24V DC 1A). (ATTENTION to the applied voltage and current to the contact).

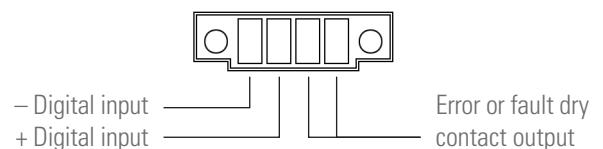





Fig. 20. Digital input and output connector.

### 5.2.9. Terminals for the manual bypass auxiliary contact.

- The manual bypass switch of the equipment has a micro-switch located under its mechanical lock. This contact is normally opened and it is extended till a terminal strip located in the rear side of the equipment [see Fig. 21] and internally connected with the own UPS control.
- The manual bypass panels supplied under request, they include a terminal strip with two terminals connected in parallel with the normally opened auxiliary contact of the manual bypass switch of the own panel. The auxiliary contacts of the manual bypass are advanced to its closing.
- The connection between the auxiliary contact of the panel and the UPS or UPSs must be in parallel. Therefore, in case any of the auxiliary contacts closes the circuit will trigger



the command to shutdown the inverter, so the equipment will supply output voltage through the static bypass, unless it is disabled by means of the control panel, which in that case would break the load feeding.

-  In parallel systems, the manual bypass switch of the switchgear panel will have a terminal strip for each equipment. **Under no circumstances** joint the contacts of the different UPSs among them, because the ground of the UPS control would be joined.
-  In case of buying the manual bypass panel from other sources, check that it has the stated auxiliary contact and connect it to the terminal strip of the UPS or UPSs in parallel systems. The auxiliary contact type must be advanced to its closing.
-  As safety measures, it is **ESSENTIAL**, to connect the terminals strips of the UPS, and even for the loads, with the ones of the manual bypass panel with the same function. Therefore, it will be avoided any wrong handling of the manual bypass switch/es when the UPS or UPSs are turned ON, which could cause a total or partial failure of the installation and/or loads.

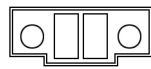

Fig. 21. Auxiliary contact connector of the UPS manual bypass.

## 5.2.10. Parallel connection.

### 5.2.10.1. Introduction to the redundancy.

N+X is usually the most reliable power structure. N means the minimum quantity of equipments that the total load needs; X means the quantity of redundant equipments, that is to say, the quantity of faulty UPSs that the system can allow at the same time. As higher is the X, the more reliable will be the system. For those situations, where the reliability is the most important, N+X will be the optimal mode.

Up to 3 equipments can be connected in parallel to set a shared output and redundant in power.

### 5.2.10.2. Parallel installation and operating.

-  The communication line -COM- means a low safety voltage circuit. To preserve the quality of them, they must be installed separate from other lines with dangerous voltages (energy distribution line).

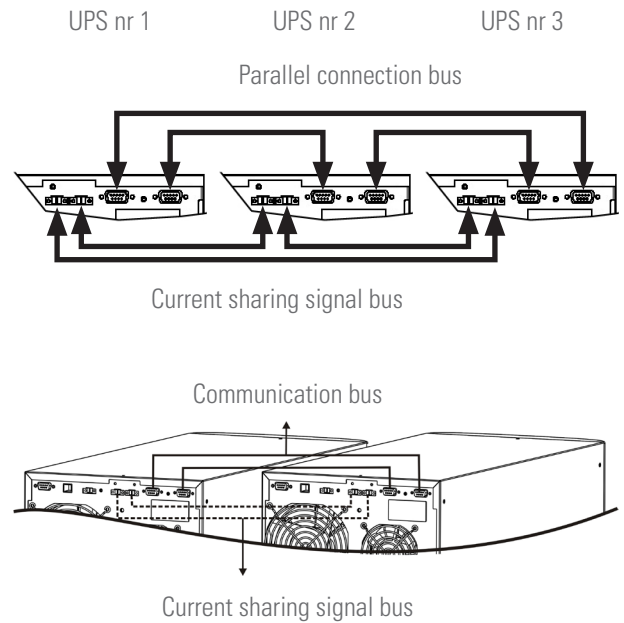

Fig. 22. Connection of the communication bus and current sharing signal.

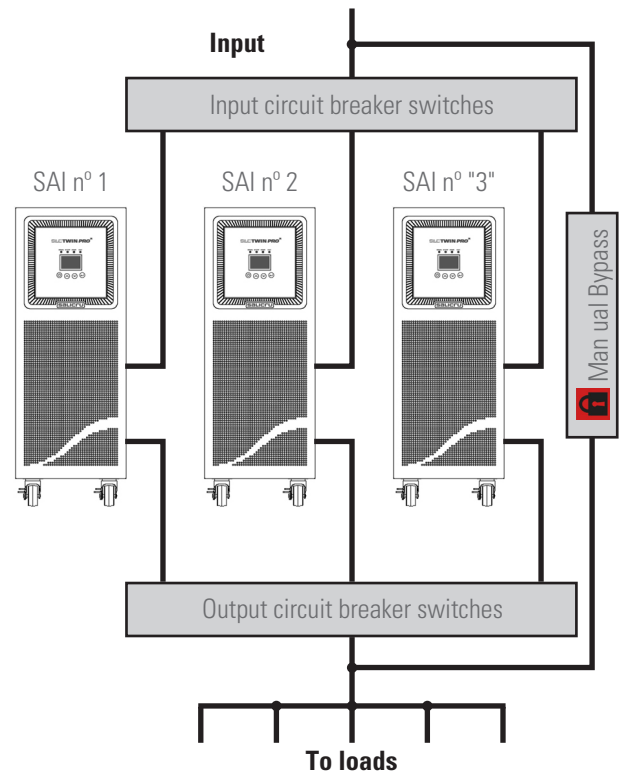

Fig. 23. Parallel UPS installation with a switchgear panel with manual bypass.

- **Parallel connection bus.** Use the 15 pins DB15 connectors and shielded cable bundle to joint 3 equipments maximum. Each bundle has a male and female connectors at its end, which have to be connected between two correlative equipments. It is essential to close the loop of the parallel bus among the equipments.

The length of the parallel cable is 1.5 metres and it can't be extended under no circumstances, due to the risk of interferences that it would mean.

Fig. 22 shows an installation of two equipments in parallel. For three UPSs proceed in the same way to close the communication bus and current sharing circuits.

- **Bus connection of the signal of current.** Joint the equipments, by using the cable bundle with connectors in both ends and connecting them in the connectors of both correlative equipments as Fig. 22 shows. Finally, close the bus loop between the last and first equipment.

The length of the cable is 1.5 metres and it can't be extended under no circumstances, due to the risk of interferences that it would mean.

Fig. 22 shows an installation of two equipments in parallel. For three UPSs proceed in the same way to close the communication bus and current sharing circuits.

- Parallel installations must have a switchgear panel with separate input and output protections for each UPS, apart from a manual bypass switch with mechanical lock, see Fig. 23. For more information, about the descriptions referred to the manual bypass and the indications of the «Recommended installation» see section 5.1.5.4.
- Respect the stated procedures in the previous sections, for the input and output connections of each equipment.
- For those equipments with extended back up time, respect the stated procedures for the battery modules, which are described in the previous sections.

 In parallel systems, where the length and cross section of the cables that go from the switchgear panel to each UPS and from the UPS to the switchgear panel will be the same for all them, with no exception.

In the worst conditions, the following deviations must be strictly respected:

- When the distance between the parallel UPSs and the switchgear panel is less than 20 metres, the length difference among the input and output cables of each equipment must be lower than 20%.
- When the distance between the parallel UPSs and the switchgear panel is over 20 metres, the length difference among the input and output cables of each equipment must be lower than 10%.

## 5.2.11. Communication port.

### 5.2.11.1. RS232 and USB ports.

-  The communication line -COM- means a low safety voltage circuit. To preserve the quality of them, they must be installed separate from other lines with dangerous voltages (energy distribution line).
- The RS232 and USB interface are used by the monitoring software and firmware updating.
- It is not possible to use both ports (RS232 and USB) at the same time.
- Tab. 4 shows the pin-out of the RS232 signal in the DB9 female connector. The RS232 is a serial data port, so an important amount of information can be sent through a communication cable of 3 wires.
- The USB communication port is compatible with the USB 1.1 protocol for the monitoring software.

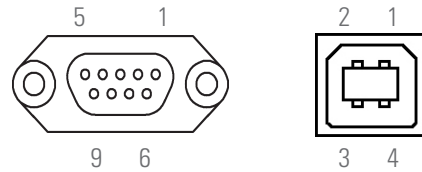

Fig. 24. DB9 connectors for RS232 and USB.

| Pin # | Ref.  | Description                    | Input / Output |
|-------|-------|--------------------------------|----------------|
| 2     | RS232 | TXD (serial data transmission) | Output         |
| 3     | RS232 | RXD (serial data reception)    | Input          |
| 5     | RS232 | RS232 ground signal            | GND            |

Tab. 4. DB9 connector pinout, RS232.

## 5.2.12. Intelligent slot to insert the communication card.

- Different communication cards can be inserted into the slot:
  - Programmable dry contacts.
  - SNMP adaptor.
  - RS485 Modbus adaptor.
- Each option card is supplied with its own particular documentation. Read it before installing them.

### Installation.

- Remove the protection cover from the slot of the equipment.
- Take the corresponding card and insert it into the reserved slot. Make sure that it is well connected, to do it the resistance that own connector faces when it inserted into the slot has to be overcome.
- Make the needed connections of the terminal strips or connectors depending on each case.
- Put the new protection cover supplied with the option cards and fix it by means of the same screws that previously fixed the original one.
- For more information, contact with our **T.S.S.** or our nearest distributor.

## 5.2.13. Software.

- **Download the free software - Viewpower.**

Viewpower is a UPS monitoring software, which has a user friendly interface for monitoring and control. This software, in case of power outage provides an auto Shutdown for a system based on several computers. With this software, the end-users can monitor and control any UPS hosted in the same IT network, by means of the communication port (RS232 or USB), no matter the distance among them.

- **Installation procedure:**

- Go to the website: <http://support.salicru.com>
- Choose the operating system that you need and follow the instructions described in the website to download the software.

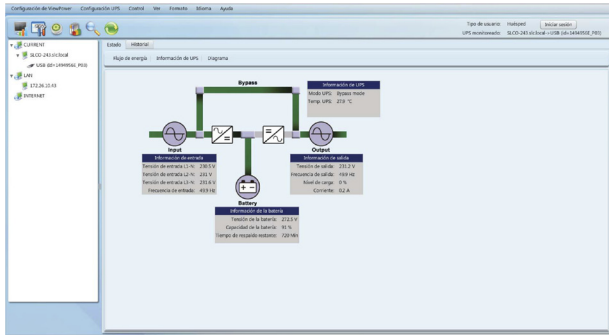



Fig. 25. Screen shot of the main screen of ViewPower monitoring software.

#### 5.2.14. Considerations before commissioning with the loads.

-  It is recommended to charge the batteries for 12 hours at least before using the UPS for first time.
  - To do it, supply the input of the equipment and turn the input switch «On». The battery charger will be automatically started up.
  - For battery modules.  
Those models with extended back up times with one or more battery modules, the fuse or battery switch has to be turned «On» too.
- Although the equipment can work without charging the batteries for stated 12 h, the risk of a long power outage for the first operating hours must be evaluated, because the back up time of the UPS will be lower.
- Do not start up the equipment and loads before section 6 states it.  
Nevertheless, when it is started up, it will be done gradually, in order to avoid possible issues, at least in the first UPS start up.
- In case of connecting inductive loads with high consumption, apart from the sensitive loads, like laser printers or CRT monitors; their worst inrush current will be kept in mind in order to avoid blocking the equipment.  
Depending on the equipment, for this type of loads, which are considered NON-CRITICAL, the equipment has a programmable terminal strip. Depending on the setting of that terminal strip, the power supply will be broken or not in case of power outage.



## 6. OPERATING.



### 6.1. COMMISSIONING.

#### 6.1.1. Checking before commissioning.

- Make sure that all connections have done properly with the correct torque, by respecting the labelling of the equipment and the instructions of section 5.
- Check that the UPS switch and battery module or modules are turned «Off».
- Make sure that all the loads are turned «Off».
-  Shutdown the loads before starting up the UPS and turn on the loads one by one when the UPS is started up only. Before shutting down the UPS, check that all the loads are turned «Off» and out of service.
- It is very important to proceed in the established order.
- See figures 1 to 3 for UPS views.
- Fig. 23 shows a conceptual switchgear panel with manual bypass for a parallel system, which illustrates only one equipment by adapting the quantity of switches.

### 6.2. START UP AND SHUTDOWN OF THE UPS.

#### 6.2.1. UPS start up with AC mains present.

- Check that the power supply connection is correct.
- Supply AC voltage to the equipment (turn the input switch from switchgear or manual bypass panel to «On». In case the panel includes output switch turn it «On» too.
- Turn the battery switch «On» (models B0 and B1).
- Turn the input switch of the UPS «On».
-  The output terminals will be supplied through the internal static bypass of the equipment. The fan or fans, depending on the model, will be turned on. Next the main start screen will be displayed after the initial equipment test.
- Press over the start up  key for more than 0.5 seconds, the acoustic alarm will beep for 1 sec. and the UPS will be started up.
- After a few seconds, the UPS will be on «Normal mode». If the input AC voltage is wrong, the UPS will shift to «Battery mode», with no break in the power supply to the output terminal strip.
- Start up the load or loads, without exceeding the nominal power rate of the equipment.



#### 6.2.2. UPS start up with no AC mains (Cold start).

- If the switchgear panel is available turn the input and output switches «On».
- Turn the battery switch «On» (models B0 and B1).
- Turn the input switch of the UPS «On».
- Press over the start up  key for more than 0.5 seconds, the acoustic alarm will beep for 1 sec. and the UPS will be started up. The fan or fans, depending on the model, will be turned on. Next the main start screen will be displayed after the initial equipment test.

It is necessary to press the 'ON' button for a second time, about 5 to 7 seconds after the first press, for longer than 0.5 seconds.

- After a few seconds, the UPS will be on «Battery mode», so it has to be considered: their charge level, the remaining back up time and the risk that means to operate on this operating mode. If the AC mains is restored, the UPS will shift to «Normal mode», with no break at the power supply of the output terminals.
- Start up the load or loads, without exceeding the nominal power rate of the equipment.

#### 6.2.3. UPS shutdown with AC mains present.

- Shutdown the load or loads.
- Press the  key for more than 0.5 seconds to shutdown the inverter. The acoustic alarm will be for 1 sec. The equipment will shift to «Bypass mode».
-  The output terminals will be supplied through the internal static bypass stage of the equipment.
- To break the UPS output voltage, turn «Off» the input switch of the UPS or turn «Off» the input and output protections located in the switchgear distribution panel. After a few seconds, the LCD panel is off and the equipment will be out of service.

#### 6.2.4. UPS shutdown with no AC mains.



- Shutdown the load or loads.
- Press the  key for more than 0.5 seconds to shutdown the inverter. The acoustic alarm will beep for 1 sec. The equipment will break the power supply of the output terminals. After a few seconds, the LCD panel is off and the equipment will be out of service.
- To leave the equipment completely isolated, turn the input and output switches from switchgear panel «Off».



### 6.3. MANUAL BYPASS SWITCH (MAINTENANCE).

The internal manual bypass in the SLC TWIN PRO2 UPS is very useful, but a wrong handling can cause irreversible consequences for both UPS and connected loads. Therefore, it is important to respect the manoeuvring on the switches as it is described in the following sections.



In case of mains failure, it is not possible to operate on this mode.

#### 6.3.1. Shifting to maintenance bypass.

- The procedure to shift from normal mode to maintenance bypass is the same for single unit and parallel system, less in the quantity of actions to make:
  -  In case of handling the switches in the different order as the stated, **it will break the power supply to the loads and even can cause damage to the UPSs.**
  - For a single equipment.
    - Press the start up  key for than 0.5 sec. in order to shutdown the inverter. The acoustic alarm will beep 1 sec. The equipment will shift to «Bypass mode».





- ❑ For a parallel system.
  - Press the start up  key for than 0.5 sec. in all UPSs in order to shutdown the inverter. The acoustic alarm will beep 1 sec. The equipments of the parallel system will shift to «Bypass mode».
- ❑ Shift the equipment or equipments to manual bypass as follows:
  1. Remove the mechanical lock from bypass manual switch from switchgear panel and turn it «On».
  2. Remove the manual bypass switch cover, located in the rear side of the UPS and turn it to «BYPASS» position.  
In parallel systems proceed in the same way in all the equipments.
- ❑  Keep in mind that on «Bypass mode» or with the manual bypass switch on «BYPASS» position, the loads will remain exposed to the voltage and frequency fluctuations from mains, blackouts and power outages, so it was possible choose a day with the lowest failure probability (days with no fluctuations, days with no storms,...) and speed up the process.
- ❑ Turn the input circuit breaker switch of the equipment to «Off».  
In parallel systems proceed in the same way in all the equipments.
- ❑ Turn all the input and output circuit breakers of the switchgear panel to «Off».  
The system is completely shutdown and out of service and loads are supplied by means of the manual bypass switchgear panel.  
Make the needed maintenance tasks.

### 6.3.2. Shifting to normal mode.

- The procedure to shift from maintenance bypass to normal mode is the same for single unit and parallel system, less in the quantity of actions to make:
  - ❑  In case of handling the switches in the different order as the stated, **it will break the power supply to the loads and even can cause damage to the UPSs.**
  - ❑ Turn the input and output circuit breaker switches from switchgear panel to «On».
  - ❑ Turn the input switch of the own equipment to «On».  
In parallel systems proceed in the same way in all the equipments.
  - ❑ Turn the manual bypass switch, located in the rear side of each equipment to «UPS» position and put back their protection covers.  
In parallel systems proceed in the same way in all the equipments.
  - ❑ Turn the manual bypass switch of the switchgear panel to «Off» and put back its mechanical lock.
  - ❑  In order to avoid wrong handling, the mechanical lock, protection covers of the manual bypass and their fixing screws have to put back.
  - ❑ For a single equipment.
    - Press the start up  key for more than 0.5 sec, the acoustic alarm will beep 1 sec. The equipment will start up.

- ❑ For a parallel system.
  - Press the start up  key for more than 0.5 sec. in all UPSs and each one of them will be started up, finally the parallel system will be on «Normal mode».
- ❑ Load or loads are protected by the parallel system again.

## 6.4. PARALLEL SYSTEM OPERATING

- To operate with parallel systems, in order to avoid problems, check that the output 2 of each UPS is set to the same parameter in all of them.
- The operating described hereafter, is for equipments with the standard setting preset from factory.
- Check that the load or loads and/or the output circuit breaker switches are turned «Off».
- Turn the input circuit breaker switches from switchgear panel or manual bypass to «On» and the own input switches in each UPS too.  
The UPSs supply AC voltage by means of their internal static bypass of each unit. Check if any alarm has been triggered in the LCD panel. Measure the output voltage at the output terminals of each UPS separately, in order to check if the voltage difference is lower than 1 V among them. In case the voltage difference is higher than 1 V, check the wiring and the previous installation instructions.
- If the difference voltage is lower than 1 V, press over the start up  key for more than 0.5 seconds in all UPSs and each one of them will be started up and all the UPSs will shift to «Normal mode».  
Measure the output voltage at the output terminals of each UPS separately, in order to check if the voltage difference is lower than 0.5 V among them. In case the voltage difference is higher than 1 V, the UPSs must be set (contact with the **T.S.S.**).
- Continue with the procedure if everything is correct only. Press the start up  key for than 0.5 sec. in all UPSs and each one of them will be shutdown.  
Turn all the output switches from switchgear or manual bypass panel to «On». The output terminals of the switchgear panel will be supplied by means of the internal static bypass of the equipment.
- Press the start up  key for more than 0.5 sec. in all UPSs and each one of them will be started up and all the UPSs will shift to «Normal mode».
- Start up the load or loads.
-  Do not leave one of the UPSs with no neutral connection as regard to the rest one. The neutral of all UPSs must be joined among them, either through the input or through the output. Do not open the input and output circuit breakers of the switchgear panel of one UPS at the same when the parallel system is turned On, otherwise the UPS can be damaged and the loads will be shutdown.



## 6.5. HOW UPGRADE THE PARALLEL SYSTEM WITH A NEW UPS OR DOWNGRADE TO SINGLE MODE.

- To do this manoeuvring, the parallel system must have a manual bypass panel for a parallel system.  
In case of not having it, it has to be foreseen a complete

shutdown of the system and loads connected to it.

- The steps here stated are to add an equipment in a parallel system of two units. To upgrade a single unit to a parallel system of two equipments proceed in the same way.
- The switchgear panel will have the corresponding input and output switches for each UPS apart from the manual bypass one. Otherwise it will be needed to adapt the panel or purchase a new one, if it has not been foreseen previously.
- Due that the own parallel bus communication has to be changed in order to integrate the new UPS into the parallel system (cable bundle with DB15 connectors), it will be needed to shift the power supply of the loads to manual bypass.



Proceed as follows:

- ❑ Press the start up  key for than 0.5 sec. in all UPSs in order to shutdown the inverter. The acoustic alarm will beep 1 sec. The equipments of the parallel system will shift to «Bypass mode».
- ❑ Transfer the equipments to manual bypass as follows:
  1. Remove the mechanical lock of the manual bypass switch from switchgear panel and turn it «On».
  2. Remove the protection cover of the manual bypass switch, which is located in the rear side of the equipment. Put all the manual bypass switches from UPS to «BYPASS» position.
- ❑  Keep in mind that on «Bypass mode» or with the manual bypass switch on «BYPASS» position, the loads will remain exposed to the voltage and frequency fluctuations from mains, blackouts and power outages, so if it was possible choose a day with the lowest failure probability (days with no fluctuations, days with no storms,...) and speed up the process.
- ❑ Turn the own input circuit breaker switches of each equipment to «Off».
- ❑ Turn all the input and output switches from switchgear panel to «Off».
- Before adding the new TWIN PRO2 UPS to the system, make the needed steps, in order to leave it in the same situation as the rest ones (input switch turned «Off» and manual bypass switch with no cover and turned to «BYPASS»).
- Add the new UPS to the system, by attending the procedure stated in section 5.2.10.2, for the parallel connection.
- Disconnect the communication bus between the first and last equipment, and reconnect it by including the new UPS. It is compulsory to close the loop of the communication bus for its correct operating.  
Carry out the same operation for the current signal bus.
- Turn the input circuit breaker switch of each UPS from switchgear panel to «On».
- Turn the input circuit breaker switches from each UPS to «On».  
Turn the internal manual bypass switch of each UPS to UPS position.  
The output switches of each UPS from switchgear panel must be turned off.  
Put the locking cover of the manual bypass switch of each UPS.  
The UPSs supplies output voltage by means of the internal static bypass of each unit. Check if any alarm has been

triggered in the LCD panel in any UPS. Measure the output voltage a the output terminals of each UPS separately, in order to check if the voltage difference is lower than 1 V among them. In case the voltage difference is higher than 1 V, check the wiring and the previous installation instructions.

- If the difference voltage is lower than 1 V, press over the start up  key for more than 0.5 seconds in all UPSs and each one of them will be started up and all the UPSs will shift to «Normal mode».

Measure the output voltage a the output terminals of each UPS separately, in order to check if the voltage difference is lower than 0.5 V among them In case the voltage difference is higher than 1 V, the UPSs must be set (contact with the **T.S.S.**).

- Continue with the procedure if everything is correct only. Press the start up  key for than 0.5 sec. in all UPSs and each one of them will be shutdown.  
Turn all the output switches from switchgear or manual bypass panel to «On». The output terminals of the switchgear panel will be supplied by means of the internal static bypass of the equipment, the same voltage as the manual bypass line
- Turn the manual bypass switch from switchgear panel to «Off» and put the mechanical lock back to avoid possible accidents.
-  To avoid inappropriate manoeuvring, it is better to put back the mechanical lock and the manual bypass covers and their fixing screws.
- Press the start up  key for more than 0.5 sec. in all UPSs and each one of them will be started up and all the UPSs will shift to «Normal mode».
- The load or loads are protected by the parallel system again.

## 6.6. HOW TO REPLACE A FAULTY UPS FROM THE PARALLEL SYSTEM.

- The steps to follow for replacing a UPS in a parallel system based on two or three equipments are exactly the same as to upgrade the system, less bridging the gaps of the type of action to make. Proceed as it is described in section 6.4.

## 7. CONTROL PANEL WITH LCD.

### 7.1. CONTROL PANEL.

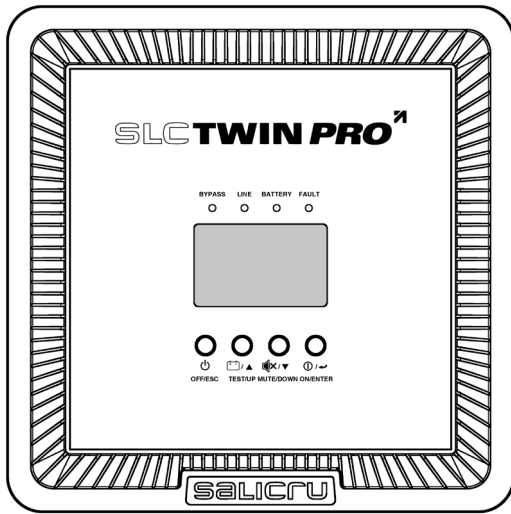

Fig. 26. Control panel view.

| Button                                    | Description   |
|---|---|
| /<br>«ON / ENTER»                         | ON. Press this key for more than 0.5 sec. to start up the UPS [inverter of the equipment].<br>ENTER. Press this key to confirm a selection in the setting menu.                               |
| <br>«OFF / ESC»                           | OFF. Press this key for more than 0.5 sec. to shutdown the equipment, when the equipment is started up previously.<br>ESC. Press this key to escape and go back to the previous setting menu. |
| /<br>«TEST / UP»                          | TEST. Press this key for more than 0.5 sec. to make a battery test when the equipment works on AC or FC (*).<br>UP. Press this key to show the next setting menu screen.                      |
| /<br>«MUTE / DOWN»                        | ALARM SILENT. Press it for more than 0.5 sec. to silent the acoustic alarm (see section 6.2.3.2).<br>DOWN. Press this key to show the previous setting menu screen.                           |
| /  +  /<br>«TEST / UP» +<br>«MUTE / DOWN» | UP + DOWN. Press both keys simultaneously for more than 1 sec. to enter and escape from setting menu.   |

(\*) **CF.** Operating mode as Frequency Converter. With this operating mode the static bypass is disabled.

Tab. 5. Control panel keypad functions.

- The UPS has a control panel, which has the following parts:
  - Four buttons with the functions described in table 5.
  - A backlight LCD with the messages displayed as text or graphics form, with black letter and blue backgrounds.

- Four led indicators, which provides the following information:
  - Bypass (**yellow**).
  - Line (**green**).
  - Battery (**yellow**).
  - Fault (**red**).

7.2. TABLE 6 SHOWS THE INDIVIDUAL FUNCTION OF EACH ONE OF THEM OR THEIR INTERACTION WITH OTHERS, AS REGARDS TO THE UPS STATUS. LED FUNCTIONS.

| UPS status     | Leds   |      |         |       |
|----------------|--------|------|---------|-------|
|                | Bypass | Line | Battery | Fault |
| UPS ON         | ●      | ●    | ●       | ●     |
| No output mode | ○      | ○    | ○       | ○     |
| Bypass mode    | ●      | ○    | ○       | ○     |
| AC mode        | ○      | ●    | ○       | ○     |
| Battery mode   | ○      | ○    | ●       | ○     |
| FC mode        | ○      | ●    | ○       | ○     |
| ECO mode       | ●      | ●    | ●       | ○     |
| Battery test   | ●      | ●    | ○       | ○     |
| Fault          | ○      | ○    | ○       | ●     |

●: Led permanent lighting.

○: Led off.

Tab. 6. Led optical indicators function.

#### 7.2.1. Acoustic alarms.

| Description       | Modulation or alarm tone | Silent |
|-------------------|--------------------------|--------|
| <b>UPS status</b> |                          |        |
| Bypass mode       | Beep every 2 minutes.    | Yes    |
| Battery mode      | Beep every 4 seconds.    |        |
| Fault             | Continuous.              |        |
| <b>Warning</b>    |                          |        |
| Overload          | 2 Beeps every second.    | Yes    |
| Other             | Beep every 1 second.     |        |
| <b>Faults</b>     |                          |        |
| All               | Continuous.              | Yes    |

Tab. 7. Acoustic alarms. Condition and modulation or tone.

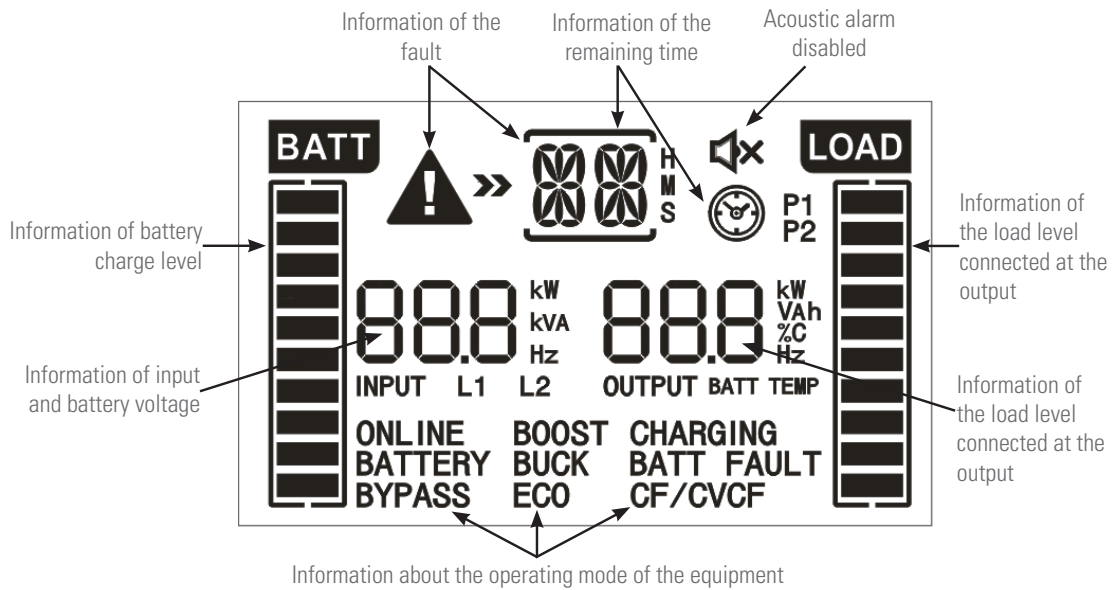

Fig. 27. Control panel with LCD.

### 7.2.2. Messages shown in the LCD.

| Display   | Function  |
|---|---|
| <b>Information of the back up time.</b>                       |   |
|   | It states the remaining back up time in analogical clock mode.  |
|   | It states the remaining back up time in a digital clock mode.<br>H.- Hours, M.- Minutes, S.- Seconds.   |
| <b>Information of the fault.</b>                              |   |
|   | As a warning mode indicates that there is a fault.  |
|   | Numerical code from setting menu. See table 9 from section 7.5.   |
| <b>Information of the acoustic alarm.</b>                     |   |
|   | It indicates that the acoustic alarm has been disabled.   |
| <b>Information of the output voltages.</b>                    |   |
|   | It indicates the output voltage or output frequency.<br>V AC.- output voltage, Hz.- Output frequency.   |
| <b>Information of the load level connected to the output.</b> |   |
|   | It indicates the load connected at the output in %, by means of four segments, which are equivalent to the following proportion: 0-25 %, 26-50 %, 51-75 % and 76-100 %. |
| <b>Information of the programmable outputs</b>                |   |
| <b>P1</b>   | It indicates that the programmable outputs are activated.   |
| <b>Information about the operating mode of the equipment.</b> |   |
| <b>BATTERY</b>  | It indicates that the equipment is supplying output voltage from the battery (battery mode).  |

|  |   |
|--|---|
| <b>BYPASS</b>  | It indicates that the equipment is activated in ECO mode.   |
| <b>ECO</b>   | It indicates that the equipment is supplying output voltage by means of the bypass (ECO mode).  |
| <b>ONLINE</b>  | It indicates that the inverter is working.  |
| <b>P1</b>  | It indicates that the output is activated.  |
| <b>Information of the battery charge level.</b>      |   |
|  | It indicates the battery charge level in %, by means of four segments, which are equivalent to the following proportion: 0-25 %, 26-50 %, 51-75 % and 76-100 %. |
|  | It indicates that the battery is not connected.   |
|  | It indicates that the battery voltage is low.   |
| <b>Information of the input and battery voltage.</b> |   |
|  | It indicates the input voltage, input frequency or battery voltage. V AC.- Input voltage, V DC.- Battery voltage, Hz.- Input frequency.                         |

Tab. 8. Indications shown in the LCD of the control panel.

### 7.3. MEANING OF THE ABBREVIATIONS DISPLAYED IN THE LCD OF THE CONTROL PANEL.

| Code | LCD message | Meaning                             |
|------|-------------|-------------------------------------|
| ENA  | ENA         | Enabled.                            |
| DIS  | dis         | Disabled.                           |
| ATO  | ATO         | Automatic.                          |
| BAT  | BAT         | Battery.                            |
| NCF  | NCF         | Normal mode (not available for FC). |
| CF   | CF          | Frequency converter mode.           |
| SUB  | SUB         | Down.                               |
| ADD  | ADD         | Up.                                 |
| ON   | ON          | Start up.                           |
| OFF  | OFF         | Shutdown.                           |
| FBD  | Fbd         | Not allowed.                        |
| OPN  | OPN         | Allowed.                            |
| RES  | RES         | Reserved.                           |
| N.L  | N.L         | Neutral lost.                       |
| CHE  | CHE         | Checking.                           |
| OP.V | OP.V        | Output voltage                      |
| PAR  | PAR         | Parallel, 001 is the first one.     |
| EPO  | EP          | Emergency power off.                |
| FR   | FR          | Frequency.                          |
| OPL  | OPL         | Load percentage.                    |
| R    | R           | Phase R.                            |
| S    | S           | Phase S.                            |
| T    | T           | Phase T.                            |

Tab. 9. Abbreviations shown in the LCD.

### 7.4. SETTINGS IN THE LCD CONTROL PANEL.

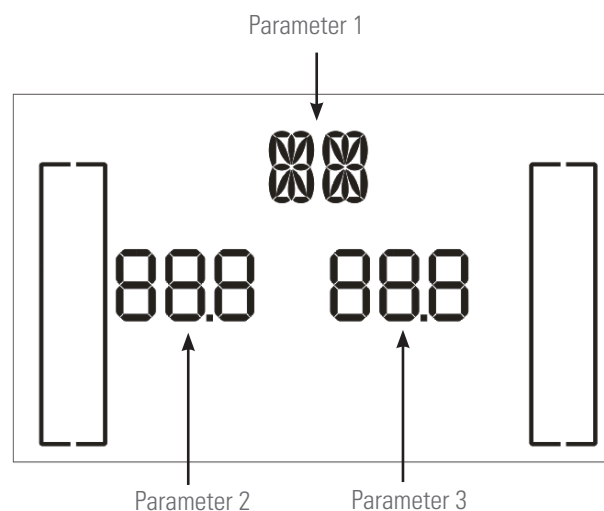

Fig. 28. Parameter layout in the LCD panel.

- Parameter 1: Code of setting menu. Consult table 9 for its description.
- Parameter 2 and 3 are the options of the figures for each setting menu.

**i** Select the «Down» or «Up» keys to change the menu or parameters.

**i** Any parameter setting is only saved when the UPS is shutdown on normal mode and internal or external batteries are connected, depending on the case. (It is understood as shutdown on normal mode to turn off the input circuit breaker switch when the equipment is on bypass or no voltage -depending if the static bypass is enabled or disabled-).

| Code   | Description  |   | Bypass mode/ No output mode  | AC mode | ECO mode | FC mode | Battery mode | Battery test |
|--------|--|---|------------------------------|---------|----------|---------|--------------|--------------|
|        | TWIN PRO2  | TWIN/3 PRO2                                       |                              |         |          |         |              |              |
| 01     | Output voltage.                                    |   | YES                          | -       | -        | -       | -            | -            |
| 02     | Output frequency.                                  |   | YES                          | -       | -        | -       | -            | -            |
| (*) 03 | Bypass voltage range.                              |   | YES                          | -       | -        | -       | -            | -            |
| (*) 04 | Bypass frequency range.                            |   | YES                          | -       | -        | -       | -            | -            |
| 05     | Enable / disable ECO mode.                         |   | YES                          | -       | -        | -       | -            | -            |
| (*) 06 | ECO mode voltage range.                            |   | YES                          | -       | -        | -       | -            | -            |
| (*) 07 | ECO mode frequency range.                          |   | YES                          | -       | -        | -       | -            | -            |
| 08     | Bypass mode setting.                               |   | YES                          | YES     | -        | -       | -            | -            |
| 09     | Maximum battery discharge time setting.-           |   | YES                          | YES     | YES      | YES     | YES          | YES          |
| 10     | Reserved.  | --  | Reserved for future options. |         |          |         |              |              |
|        | -  | Programmable output setting.                      | YES                          | YES     | YES      | YES     | YES          | YES          |
| 11     | Reserved.  | -   | Reserved for future options. |         |          |         |              |              |
|        | -  | Programmable level shutdown.                      | YES                          | YES     | YES      | YES     | YES          | YES          |
| 12     | Start-up without batteries (HOT STANDBY FUNCTION). | -   | YES                          | YES     | YES      | YES     | YES          | YES          |
|        | -  | Reservedo /Neutral lost.                          | YES                          | YES     | YES      | YES     | YES          | YES          |
| (*) 13 | Battery voltage setting.                           |   | YES                          | YES     | YES      | YES     | YES          | YES          |
| (*) 14 | Charger voltage setting.                           |   | YES                          | YES     | YES      | YES     | YES          | YES          |
| (*) 15 | Inverter voltage setting.                          | -   | -                            | YES     | -        | YES     | YES          | -            |
| (*) 16 | Output voltage setting.                            |   | -                            | YES     | -        | YES     | YES          | -            |
| 17     | External MOD BAT setting.                          | -   | YES                          | -       | -        | -       | -            | -            |
|        | -  | Input phase shifting.                             | SI                           |         |          |         |              |              |
| 18     | -  | Battery capacity and quantity of strings setting. | SI                           |         |          |         |              |              |
| 19     |  | Back up time setting.                             | SI                           |         |          |         |              |              |

**(\*) WARNING with regard to codes from 3, 4, 6, 7, 13, 14, 15 and 16!:**



DEPENDING ON THE FIRMWARE VERSION OF THE EQUIPMENT, THE ORIGINAL FACTORY SETTINGS CAN BE CHANGED. DO NOT CHANGE THEM, BECAUSE DEPENDING ON THE SETTING THE UPS, LOADS OR BOTH COULD BE DAMAGED.

Tab. 10. Code list for parameter 1. Description and setting depending on the operating mode.

7.4.1. Setting menu views, depending on the parameter 1 code.

- **Code 01 (TWIN PRO2, TWIN/3 PRO2).** Output voltage.

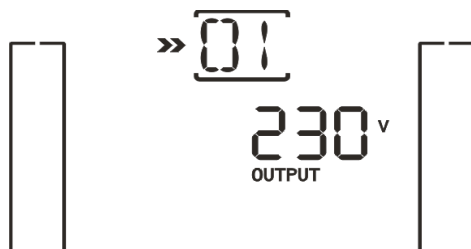

Fig. 29.

- Parameter 3 setting: Output voltage. It is possible to select one of the following output voltage figures, phase to neutral value:

– 208, 220, 230 or 240 V.

- **Code 02 (TWIN PRO2, TWIN/3 PRO2).** Output frequency.

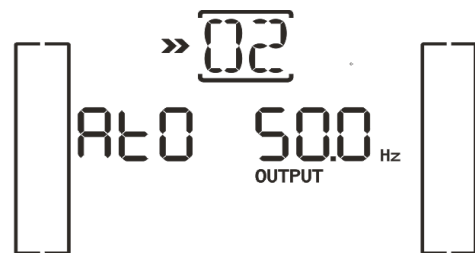

Fig. 30.

- Parameter 2 setting: Output frequency. It is possible to select one of the following figures:
  - 50 Hz, 60 Hz or ATO.
  - When ATO is selected, the output frequency is automatic



set to the frequency input detection, when the equipment is supplied from mains.

If the frequency is between 46 and 54 Hz, the output frequency will be set to 50 Hz and if it is between 56 and 64 Hz, it will be set to 60 Hz. The preset parameter from factory is ATO.

- Parameter 3 setting: Frequency mode. Output frequency setting on FC mode or no FC mode. Two options can be selected:
  - FC. Set the UPS as FC mode. With this option activated, the output frequency is set to 50 or 60 Hz depending on the parameter 2 selection. The input frequency range can be from 46 to 64 Hz.
  - NCF. Set the UPS to normal mode [No FC mode]. With this option activated, the output frequency is set to 50 or 60 Hz synchronised with the input frequency depending on the selection in parameter 2 and its range. If the parameter 2 selection is set to 50 or 60 Hz, it will shift to battery mode (to supply the loads), when the frequency is not between 46 and 54 Hz or 56 and 64 Hz respectively.



Fig. 31.

(\*) If parameter 2 is set to ATO, then the parameter 3 shows the current frequency.

-   **Code 03 (TWIN PRO2, TWIN/3 PRO2).** Bypass voltage range.



Fig. 32.

- Parameter 2 setting: It states the minimum acceptable voltage limit for bypass. The setting range is from 110 to 209 V and the preset factory figure is 110 V.
- Parameter 3 setting: It states the maximum acceptable voltage limit for bypass. The setting range is from 231 to 276 V and the preset factory figure is 264 V.

-   **Code 04 (TWIN PRO2, TWIN/3 PRO2).** Bypass frequency range.

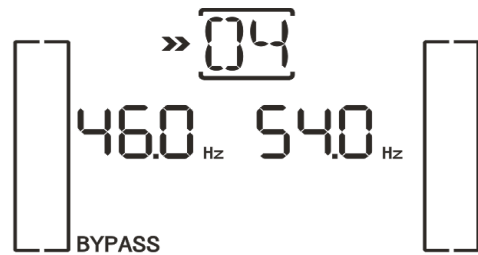

Fig. 33.

- Parameter 2 setting: Minimum limit of the acceptable input frequency range.
  - For nominal 50 Hz, the setting range is from 46 to 49 Hz.
  - For nominal 60 Hz, the setting range is from 56 to 59 Hz. The preset factory figures are 46 / 56Hz, for 50 and 60Hz respectively.
- Parameter 3 setting: Maximum limit of the acceptable input frequency range.
  - For nominal 50 Hz, the setting range is from 51 to 54 Hz.
  - For nominal 60 Hz, the setting range is from 61 to 64 Hz. The preset factory figures are 54 / 64Hz, for 50 and 60Hz respectively.

- **Code 05 (TWIN PRO2, TWIN/3 PRO2).** ECO mode, enabled / disabled.



Fig. 34.

- Parameter 3 setting: Enable or disable the ECO mode.
  - DIS. ECO mode disabled.
  - ENA. ECO mode enabled.
 If the ECO mode is disabled, the voltage and frequency ranges can be set, although it does not have so much sense because the own operating mode is disabled.

-   **Code 06 (TWIN PRO2, TWIN/3 PRO2).** ECO mode voltage range.



Fig. 35.



- ❑ Parameter 2 setting: Low voltage threshold for ECO mode. The regulation range is between -5 and -10 % of the nominal voltage.
- ❑ Parameter 3 setting: High voltage threshold for ECO mode. The regulation range is between +5 and +10 % of the nominal voltage.

-   **Code 07 (TWIN PRO2, TWIN/3 PRO2).** ECO mode frequency range.



Fig. 36.

- ❑ Parameter 2 setting: The low frequency threshold in ECO mode. The regulation range is between -5 and -10 % of the nominal frequency.
  - setting range from 46 to 49, for 50 Hz nominal .
  - setting range from 56 to 58, for 60 Hz nominal.
 The preset factory figures are 48 / 58 Hz, for 50 and 60Hz respectively.
- ❑ Parameter 3 setting: The high frequency threshold in ECO mode. The regulation range is between +5 and +10 % of the nominal frequency.
  - setting range from 51 to 54, for 50 Hz nominal .
  - setting range from 62 to 64, for 60 Hz nominal.
 The preset factory figures are 52 / 62 Hz, for 50 and 60Hz respectively.

- **Code 08 (TWIN PRO2, TWIN/3 PRO2).** Bypass mode setting.



Fig. 37.

- ❑ Parameter 2 setting.
  - OPN. Bypass allowed. When selecting this option, the UPS will operate on bypass mode, but depending on the bypass setting, if it is enable or disable (parameter 3).
  - FBD. When selecting this option, it is not allowed the bypass mode operating under no circumstances.
- ❑ Parameter 3 setting.:
  - ENA. Bypass enable. When selecting this option, the bypass mode is enabled.
  - DIS. Bypass disabled. When selecting this option, the automatic bypass is allowed but not the manual bypass shifting.

Bypass shifting is understood as that one that the end-users make it over the own UPS. I.e.: when pressing the OFF key at the front of the equipment when it is on normal mode, then the load is shifted to the static bypass.

- **Code 09 (TWIN PRO2, TWIN/3 PRO2).** Maximum battery discharge time setting.



Fig. 38.

- ❑ Parameter 3 setting:
  - DIS, default value. It disables the maximum battery discharge time of the batteries, so the back up time will depend on the capacity of themselves.
  - 000 ~ 999. It states the maximum back up time. The UPS will be automatically shutdown once the time is exceeded. In some III / II models and according to firmware version it may be set to 990 minutes [16.5 h] instead of DIS.

- **Code 10 (TWIN PRO2).** Reserved.



Fig. 39.

- ❑ Reserved for future options.

- **Code 10 (TWIN/3 PRO2).** Programmable output setting

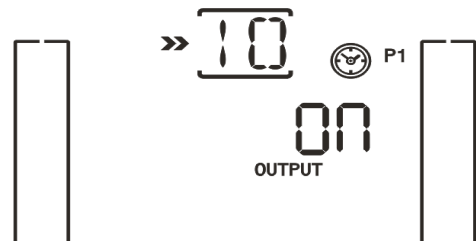

Fig. 40.

- ❑ Parameter 3 setting: Set the programmable output. It is allowed to select one of the following three options:
  - ON: the programmable output is activated permanently.
  - OFF: the programmable output is deactivated. Nevertheless, if the UPS is re-start up, this setting will

change automatically to "ATO" selection.

- ATO: the programmable output is automatically activated or deactivated, depending on the status of the battery or load. The programmable output will be shutdown either when the battery voltage is lower than the entered value or the shutdown is done. When the input mains is restored, the output will be activated automatically. In case of overload, the programmable output will be shutdown automatically. If the last situation would happen 3 times in less than 30 minutes, the programmable output will be shutdown till be activated manually.

- **Code 11 (TWIN PRO2).** Reserved.



Fig. 41.

- Reserved for future options.

- **Code 11 (TWIN/3 PRO2).** Programmable output shutdown.



Fig. 42.

- Parameter 2 setting: 001.  
Setting for shutdown time of the programmable output.
- Parameter 3 setting: Time to shutdown, stated in minutes.  
Setting range is from 0 and 300. When the setting time is achieved, the programmable output will be shutdown. The preset factory value is 30 minutes.



Fig. 43.

- Parameter 2 setting: 002.  
Setting for voltage shutdown of the programmable output.
- Parameter 3 setting: Shutdown voltages in V.  
The setting range is from 11,2 to 13,6 V. If the battery

voltage is lower than the entered figure, the programmable output will be shutdown. The preset factory figure is 11,2 V.

- **Code 12 (TWIN PRO2).** Hot standby function enable / disable.

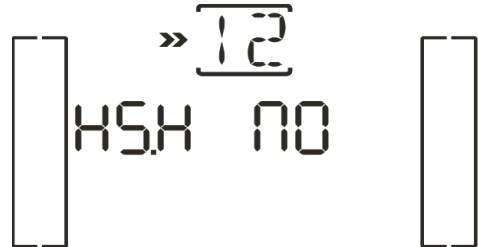

Fig. 44.

- Parameter 2 setting: HS.H
  - Enabling or disabling the Hot standby function.
- Parameter 3 setting:
  - YES: The Hot standby function is enabled after mains is restored even with no batteries connected to the UPS.
  - NO: The Hot standby function is disabled. The UPS operates on normal mode. It will not be re-started up if the batteries are not connected to the UPS.

- **Code 12 (TWIN/3 PRO2).** Neutral lost detection. By default, AUTO.

In case of neutral lost, this screen will change to input neutral lost during its checking, option CHE.



Fig. 45.

- Parameter 2 setting.
  - It is displayed when the option input neutral lost is selected. It is not allowed to be set by the end-user.
- Parameter 3 setting:
  - In this screen the end-user can check if the input neutral is connected or not.

-   **Code 13 (TWIN PRO2, TWIN/3 PRO2).** Battery voltage calibration.

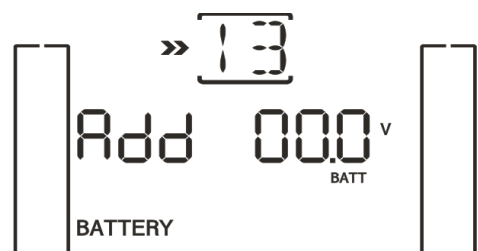



Fig. 46.

- Parameter 2 setting.
  - Select «Add» or «Sub» to set the battery voltage to the real figure.
- Parameter 3 setting:
  - The voltage range is from 0 to 9,9 V and the preset factory figure is 0 V.

-   **Code 14 (TWIN PRO2, TWIN/3 PRO2).** Charger voltage setting.

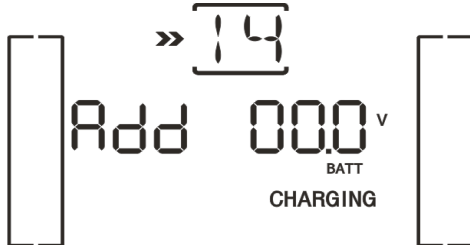



Fig. 47.

- Parameter 2 setting.
  - It can be selected «Add» or «Sub» to set the charger voltage.
- Parameter 3 setting:
  - Voltage range is from 0 to 9.9 V and the preset factory figure is 0 V.

 Before doing any voltage setting, check that the batteries are disconnected before setting the charger voltage.

The setting must be according to the battery specifications.

-   **Code 15 (TWIN PRO2).** Inverter voltage setting.



Fig. 48.

- Parameter 2 setting.
  - Select «Add» or «Sub» to set the inverter voltage.
- Parameter 3 setting:
  - The voltage range is from 0 to 9.9 V and the preset factory figure is 0 V.

-   **Code 15 (TWIN/3 PRO2).** Inverter voltage setting.



Fig. 49.

- Parameter 2 setting.
  - Select «Add» or «Sub» to set the inverter voltage.
- Parameter 3 setting:
  - The voltage range is from 0 to 6 V and the preset factory figure is 0 V

-   **Code 16 (TWIN PRO2, TWIN/3 PRO2).** Output voltage setting.

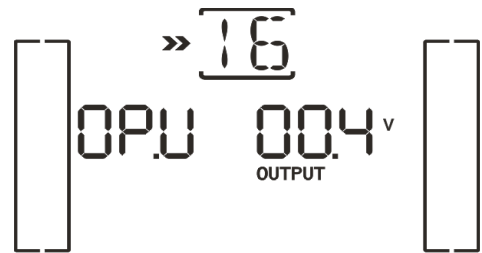



Fig. 50.

- Parameter 3 setting:
  - It is displayed the measured internal output voltage figure. It can be set by pressing the Up or Down keys according to an external voltmeter. The calibration will be effective once the Enter key has been pressed. The calibration range limit is +/-9V. This function is usually used in parallel systems.

**WARNING with regard to codes from 13 to 16!:**

  DEPENDING ON THE FIRMWARE VERSION OF THE EQUIPMENT, THE ORIGINAL FACTORY SETTINGS CAN BE CHANGED. DO NOT CHANGE THEM, BECAUSE DEPENDING ON THE SETTING THE UPS, LOADS OR BOTH COULD BE DAMAGED.

- **Code 17 (TWIN PRO2).** External MOD BAT setting.



Fig. 51.

- Parameter 3 setting: Set the quantity of the external MOD BAT.
  - 0-7: The setting allow figures between 0-7. The preset factory figure is 0
- **Code 17 (TWIN/3 PRO2).** Input phase shifting enable / disable.

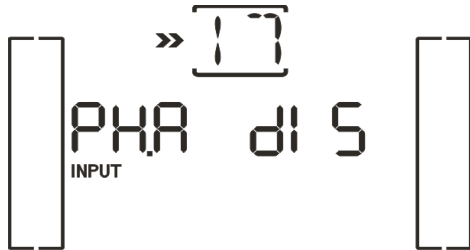

Fig. 52.

- Parameter 3 setting: Enabling / Disabling phase shifting function. It is possible to selected between two options:
  - DIS: phase shifting is disabled. Pay attention to the phase rotation of the phases by respecting the labelling of the equipment -R, S, T-.
  - ENA: phase shifting is enabled. It makes possible to connect the phases without respecting their rotation. This option will be selected, when the three input terminals -R, S, T- are supplied with the same phase (single phase mains).
- **Code 18 (TWIN/3 PRO2).** Battery capacity and MOD BAT quantity setting.

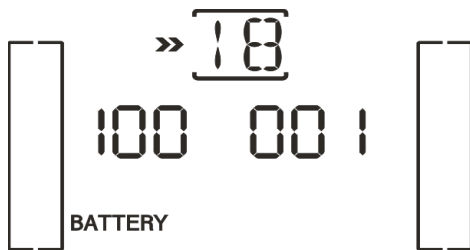

Fig. 53.

- Parameter 2 setting.
  - It allows setting the battery capacity.
- Parameter 3 setting:
  - It allows setting the MOD BAT quantity.
- **Code 19 (TWIN/3 PRO2).** Back up time setting.

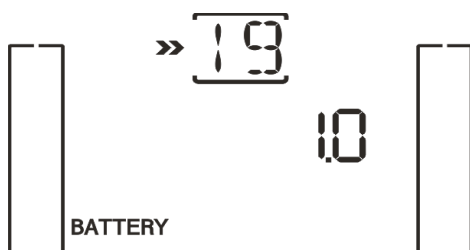

Fig. 54.

- Parameter 3 setting:
  - It allows setting the back up time to the preset factory figure or other ones.

## 7.5. OPERATING MODES / STATUS DESCRIPTION.

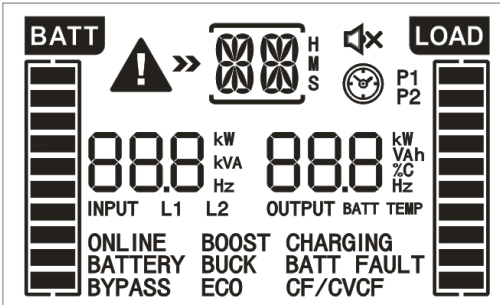

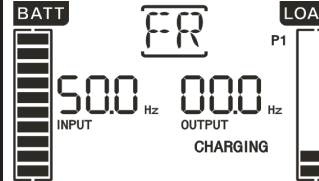
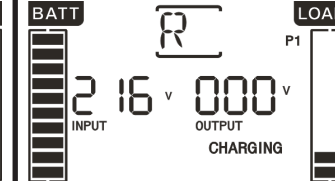

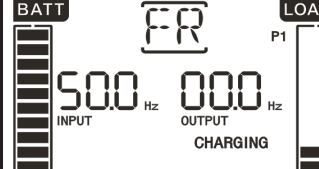
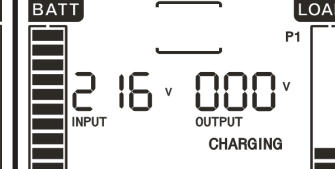

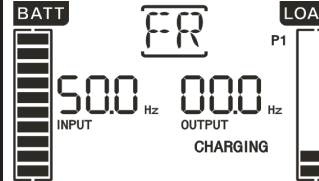
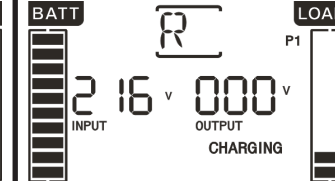

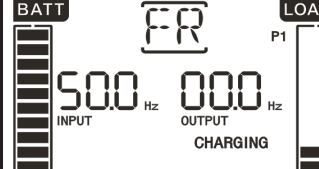
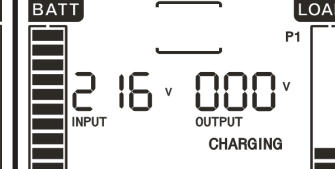

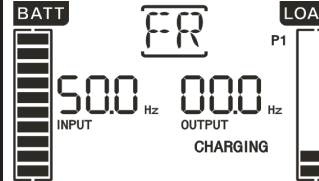
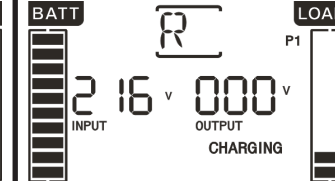

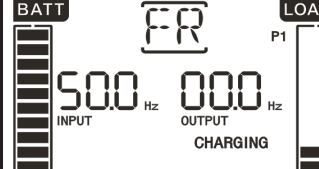
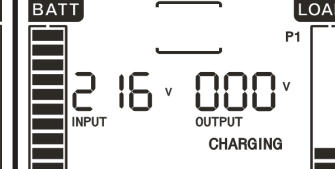

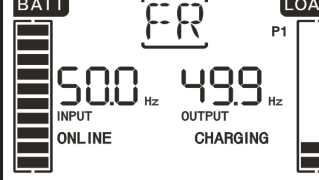
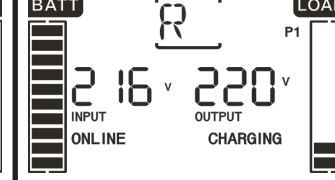
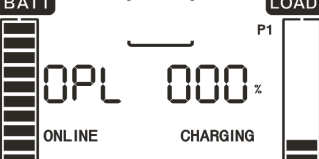
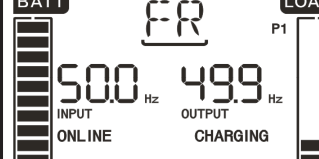
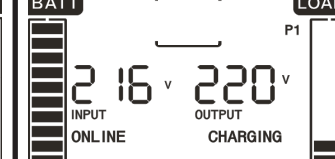

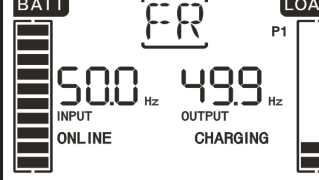
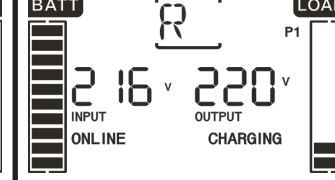
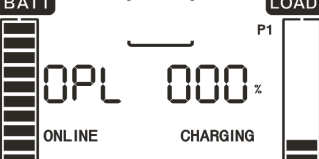
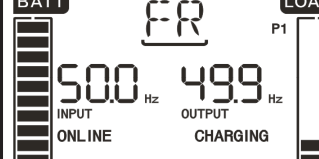
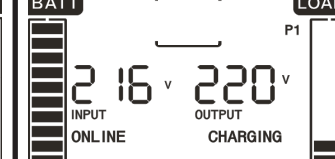

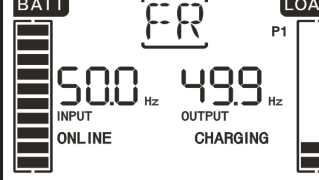
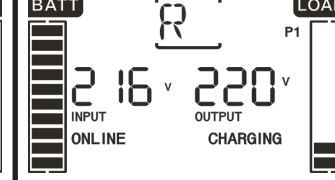
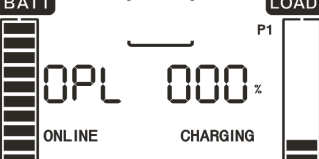
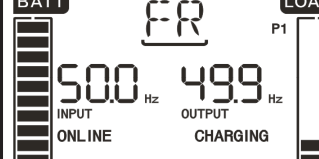
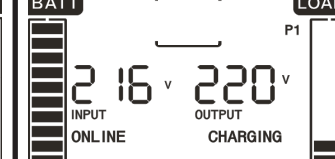
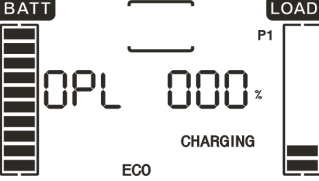
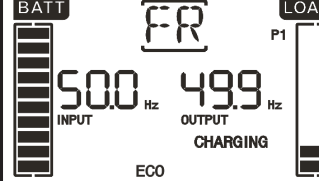
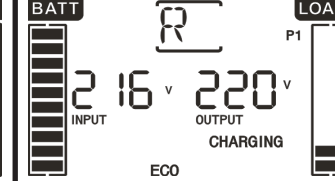

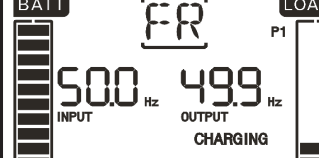
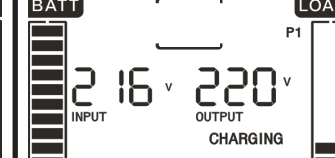
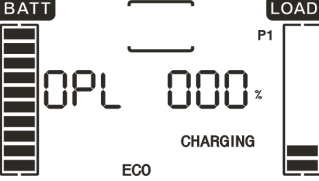
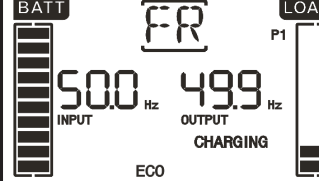
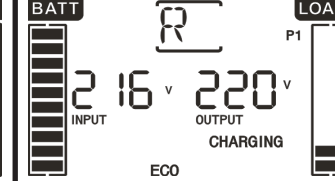

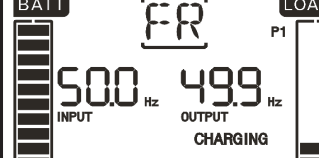
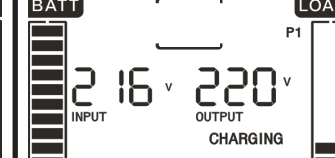
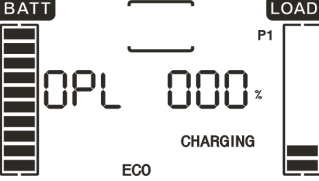
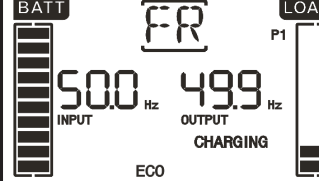
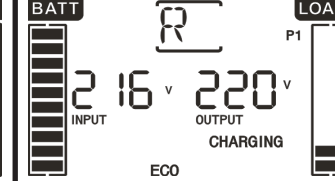

Table 10 shows the displayed screens in the LCD of the control panel [status] for all the operating modes.

1. If the UPS is on normal mode, there will be five screens for the following measurements: three phases to neutral input voltages [R, S, T], input frequency, output frequency and output load.
2. Those parallel systems, which are properly set, instead of displaying the parameter 2, it will be displayed the «PAR» acronym and parameter 3 will be displayed the number of the UPS corresponding to the equipment in the parallel system. «MASTER» UPSs will be assigned by default as «001» and the slaves as «002» and «003» respectively. The assigned numbers can change during their operation.



Fig. 55. Parallel system screen.

**Operating mode / status**

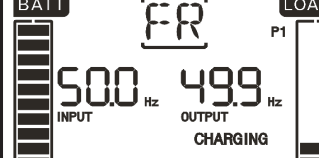
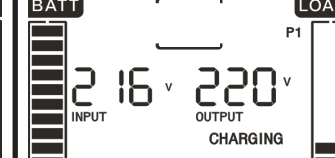
|   |  |  |   |  |   |   |  |   |
|---|--|--|---|--|---|---|--|---|
| <p>UPS start up</p>   | <p>Description.</p>  | <p>When starting up the UPS, it is displayed this screen for a few seconds in order initialize the CPU and system.</p>   |   |  |   |   |  |   |
| <p>No output mode</p>   | <p>Description.</p>  | <p>If the bypass voltage / frequency are out of range or the bypass is disabled (or not allowed), the UPS will shift to no output mode with the inverter on or when shutdown it. The UPS does not supply output voltage. The acoustic alarm beeps every two minutes .-</p> <table border="1" data-bbox="438 638 1460 1030"> <tr> <td data-bbox="438 638 774 840"> <p>TWIN/3</p>  </td> <td data-bbox="774 638 1109 840"> <p>TWIN/3</p>  </td> <td data-bbox="1109 638 1460 840"> <p>TWIN/3</p>  </td> </tr> <tr> <td data-bbox="438 840 774 1030"> <p>TWIN</p>  </td> <td data-bbox="774 840 1109 1030"> <p>TWIN</p>  </td> <td data-bbox="1109 840 1460 1030"> <p>TWIN</p>  </td> </tr> </table> | <p>TWIN/3</p>    | <p>TWIN/3</p>    | <p>TWIN/3</p>    | <p>TWIN</p>   | <p>TWIN</p>   | <p>TWIN</p>   |
| <p>TWIN/3</p>    | <p>TWIN/3</p>    | <p>TWIN/3</p>   |   |  |   |   |  |   |
| <p>TWIN</p>     | <p>TWIN</p>     | <p>TWIN</p>    |   |  |   |   |  |   |
| <p>AC mode</p>  | <p>Description.</p>  | <p>If the input voltage is inside the range, the UPS will supply sinewave and stable AC energy to the load or loads, and batteries will be charged .</p> <table border="1" data-bbox="438 1108 1460 1489"> <tr> <td data-bbox="438 1108 774 1310"> <p>TWIN/3</p>  </td> <td data-bbox="774 1108 1109 1310"> <p>TWIN/3</p>  </td> <td data-bbox="1109 1108 1460 1310"> <p>TWIN/3</p>  </td> </tr> <tr> <td data-bbox="438 1310 774 1489"> <p>TWIN</p>  </td> <td data-bbox="774 1310 1109 1489"> <p>TWIN</p>  </td> <td data-bbox="1109 1310 1460 1489"> <p>TWIN</p>  </td> </tr> </table>  | <p>TWIN/3</p>  | <p>TWIN/3</p>  | <p>TWIN/3</p>  | <p>TWIN</p>  | <p>TWIN</p>  | <p>TWIN</p>  |
| <p>TWIN/3</p>  | <p>TWIN/3</p>  | <p>TWIN/3</p>   |   |  |   |   |  |   |
| <p>TWIN</p>    | <p>TWIN</p>    | <p>TWIN</p>   |   |  |   |   |  |   |
| <p>ECO mode</p>   | <p>Description.</p>  | <p>If the input voltage is inside the range and the ECO mode is activated, the UPS supplies output voltage through its bypass (energy saving).</p> <table border="1" data-bbox="438 1568 1460 1948"> <tr> <td data-bbox="438 1568 774 1769"> <p>TWIN/3</p>  </td> <td data-bbox="774 1568 1109 1769"> <p>TWIN/3</p>  </td> <td data-bbox="1109 1568 1460 1769"> <p>TWIN/3</p>  </td> </tr> <tr> <td data-bbox="438 1769 774 1948"> <p>TWIN</p>  </td> <td data-bbox="774 1769 1109 1948"> <p>TWIN</p>  </td> <td data-bbox="1109 1769 1460 1948"> <p>TWIN</p>  </td> </tr> </table>  | <p>TWIN/3</p>  | <p>TWIN/3</p>  | <p>TWIN/3</p>  | <p>TWIN</p>  | <p>TWIN</p>  | <p>TWIN</p>  |
| <p>TWIN/3</p>  | <p>TWIN/3</p>  | <p>TWIN/3</p>   |   |  |   |   |  |   |
| <p>TWIN</p>    | <p>TWIN</p>    | <p>TWIN</p>   |   |  |   |   |  |   |

| Operating mode / status |  |
|-------------------------|--|
|                         | <p>Description. When the output frequency is selected as FC in parameter 3 from code 02 of setting menu, the inverter supplies a constant output frequency (50 or 60 Hz). Therefore, the UPS does not supply output voltage from bypass, but batteries will be charged.</p>  |
| FC mode                 | <p>TWIN/3</p>  |
|                         | <p>TWIN</p>  |
|                         | <p>Description. When the input voltage / frequency are not inside their preset ranges or there is a power outage, the UPS supplies the loads from batteries for a limited time, which will depend on their capacity, also the acoustic alarm beeps every 4 sec..</p>   |
| Battery mode            | <p>TWIN/3</p>  |
|                         | <p>TWIN</p>  |
|                         | <p>Description. When the input voltage is inside the preset range and the bypass is enabled, when the UPS is shutdown, the equipment shifts to bypass mode. The acoustic alarm beeps every two minutes.</p>  |
| Bypass mode             | <p>TWIN/3</p>  |
|                         | <p>TWIN</p>  |
|                         | <p>Description. If the UPS is on AC or FC modes, when pressing the «TEST» key for more than 0.5 sec.. The acoustic buzzer will beep as an informative mode and the battery test is started. In the energy flow diagram of the LCD panel, the line between the input and the inverter icon blinks with a dashed line. This test is very useful to check the battery status.</p> |
| Battery test            | <p>TWIN/3</p>  |
|                         | <p>TWIN</p>  |

| Operating mode / status |  |
|-------------------------|--|
|                         | Description. When the UPS detects an error or fault, the inverter will be blocked. And the fault code will be displayed in the LCD panel and the icon  will light. Table 13 shows the error or fault codes and their description. |
| Error or fault status   | TWIN/3   |
|                         | TWIN   |

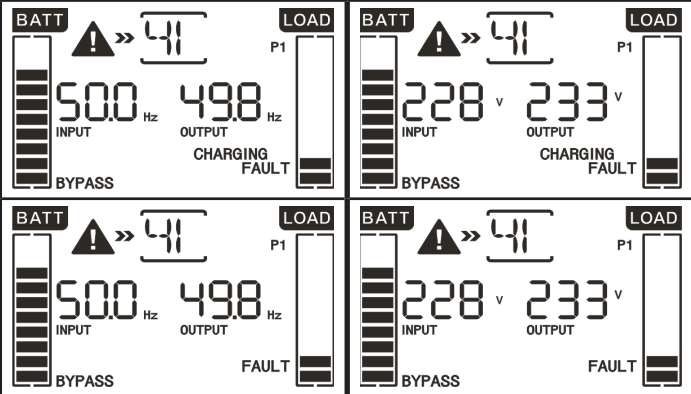

Tab. 11. Operating modes.

## 7.6. WARNING CODES.

| Code | Warning description |   |
|------|---------------------|---|
|      | TWIN                | TWIN/3  |
| 01   |                     | Battery disconnected.   |
| 02   | -                   | Input neutral lost or L2/L3 input fuse blown.                                 |
| 04   | -                   | Input phases out of range   |
| 05   | -                   | Bypass phase fault.   |
| 07   |                     | Battery overcharged.  |
| 08   |                     | Low battery.  |
| 09   |                     | Output overload.  |
| 0A   |                     | Fan failure.  |
| 0B   |                     | EPO activated.  |
| 0D   |                     | Over temperature.   |
| 0E   |                     | Charger fault.  |
| 10   |                     | L1 input fuse blown.  |
| 21   |                     | Output voltages of the equipments connected in parallel are different         |
| 22   |                     | Bypass voltages of the equipments connected in parallel are different.        |
| 33   |                     | After 3 overloads in less than 30 minutes, the equipment is blocked on bypass |
| 34   | -                   | Unbalanced converter current  |
| 35   | -                   | Battery fuse blown  |
| 36   | -                   | Unbalanced inverter current   |
| 3A   |                     | Maintenance switch cover opened   |
| 3B   | -                   | Phase shifting function failure   |
| 3C   | -                   | Unbalanced input mains  |
| 3D   |                     | Bypass not available  |
| 3E   | Start up fault      | -   |

Tab. 12. Warning code.







## 7.7. ERROR O FAULT CODES.

| Code | Error or fault description |                                    |
|------|----------------------------|------------------------------------|
|      | TWIN                       | TWIN/3                             |
| 01   |                            | DC bus start up fault.             |
| 02   |                            | DC bus overvoltage.                |
| 03   |                            | DC bus undervoltage.               |
| 04   |                            | Unbalanced DC bus.                 |
| 06   | -                          | Converter overcurrent              |
| 11   |                            | Inverter soft start fault          |
| 12   |                            | High inverter voltage              |
| 13   |                            | Low inverter voltage               |
| 14   |                            | Inverter output short-circuited    |
| 1A   |                            | Negative output power fault.       |
| 21   |                            | Battery thyristor short-circuited. |
| 24   |                            | Inverter relay short-circuited.    |

|    |  |   |
|----|--|---|
| 29 | -  | Battery fuse blown when running on battery mode |
| 31 | Canbus communication fault                     | -   |
| 35 | -  | Parallel communication failure                  |
| 36 | Unbalanced output current in a parallel system | Short-circuited output                          |
| 41 |  | Over temperature                                |
| 42 | CPU communication fault                        | -   |
| 43 |  | Output overload                                 |
| 46 | -  | UPS fault                                       |
| 60 | Inverter over current                          | -   |
| 63 | Wrong inverter wave shape                      | -   |
| 6A | Battery start up fault                         | -   |
| 6B | PFC current fault when running on battery mode | -   |
| 6C | Too fast DC bus voltage change                 | -   |

Tab. 13. Error or fault code.

## 7.8. WARNING INDICATORS.

| Code                          | Icon (blinking)   | Acoustic alarm      |
|-------------------------------|---|---------------------|
| Low battery voltage.          |  | Beep every 1 sec.   |
| Overload                      |  | Beep twice x 1 sec. |
| Disconnected battery          |  | Beep every 1 sec.   |
| Battery overcharged           |  | Beep every 1 sec.   |
| Activated EPO.                |  | Beep every 1 sec.   |
| Fan failure / Overtemperature |  | Beep every 1 sec.   |
| Charger fault                 |  | Beep every 1 sec.   |

Tab. 14. Warning indicators.



## 8. MAINTENANCE, WARRANTY AND SERVICE.

### 8.1. BATTERY MAINTENANCE.

- Pay attention to any safety instructions stated in EK266\*08 manual section 1.2.3 referred to batteries.
- The useful lifetime of the batteries depends on the ambient temperature and other factors like the quantity of charging and discharging cycles and the deep discharges done. Its design lifetime is between 3 and 5 years if the ambient temperature is between 10 and 20 °C. Under request, other typology and/or design lifetime batteries can be supplied.
- The UPS from **SLC TWIN PRO2** series only needs a minimum maintenance. The used batteries in standard models are lead acid, sealed, VRLA and maintenance free. The only requirement is to charge them regularly in order to extend their lifetime.  
Meanwhile, the UPS is connected to mains, started up or not, it will keep the batteries charged and will guarantee a protection against overcharge and over discharge.

#### 8.1.1. Notes to replace and install the batteries.

- In case of replacing any interlink wire, purchase original parts through the authorised distributors or service centres in order to avoid over heating or sparks due to the risk that would entail the use of not enough size.
- Do not short both battery poles + and -, exists risk of electrocution or fire.
- Make sure that there is not any voltage before handling the batteries. The battery circuit is not isolated from the input, so dangerous voltages between battery and earth can exist.

- Although the input circuit breaker is turned off, the internal parts of the UPS are still connected to the batteries, so dangerous voltages are present.  
So, before doing any maintenance or reparation, the internal battery fuse must be removed and/or the connectors between them and the own UPS too.  
As the battery circuit is not isolated from the input, so dangerous voltages between battery and earth or ground (any metallic part of the cabinet, supports and accessories included) can exist.
- Batteries have dangerous voltages. The maintenance and battery replacement must be done by qualified personnel and familiarized with them. No other persons must manipulate them.

### 8.2. UPS TROUBLE SHOOTING GUIDE.





If the UPS doesn't work properly, check the information displayed in the LCD panel.



Try to solve the problems by following the steps described in table 15. If the problem persists, consult with our Technical Service and Support **T.S.S.**

When necessary contact with our Technical Service and Support **T.S.S.**, and provide the following information:

- UPS model and serial number.
- Date of the problem.
- Complete description of the problem, including the information supplied by the LCD or leds or alarm status.
- Power supply condition, type of load and load percentage, ambient temperature, cooling conditions.
- Battery information (capacity and quantity) and if the equipment is a **(B0)** or **(B1)**.
- Other informations considered as important.

#### 8.2.1. Troubleshooting guide.

| Symptom  | Possible cause   | Solution   |
|--|--|--|
| Neither alarms nor indications in the LCD panel and normal mains voltage.  | The input cables are not connected properly.   | Check if the input cables are firmly connecte to mains.  |
| The  icon and  warning code blink in the LCD panel and the acoustic alarm beep every second. | EPO function is activated.   | Close the EPO circuit to deactivate it.  |
| The  icon and <b>BATT FAULT</b> message blink in the LCD panel and the acoustic alarm beep every second.  | The internal or external battery are not properly connected.   | Check if all the batteries are properly connected.   |
| The  and  icons blink in the LCD panel and the acoustic alarm beep twice every second.       | The UPS is overloaded.   | Remove/shutdown the exceeding loads connected at the UPS output.   |
|  | The UPS is overloaded. The connected devices to the UPS are directly supplied from mains through the internal Bypass.          | Remove/shutdown the exceeding loads connected at the UPS output.   |
|  | After several overloads, the UPS is blocked on Bypass mode. The connected devices to the UPS are supplied directly from mains. | First remove/shutdown the exceeding loads connected at the UPS output. Then shutdown the UPS and reboot it . |

| Symptom   | Possible cause   | Solution  |
|---|--|---|
| Code fault 43 is displayed. The  icon lights in the LCD panel and the acoustic alarm beeps continuously. | The UPS has been overloaded for long time and their equipment is blocked. The UPS is shutdown automatically.   | Remove/shutdown the exceeding loads connected at the UPS output and reboot it.  |
| Code fault 14 is displayed, the acoustic alarm beeps continuously .   | The UPS is automatically shutdown due a short-circuit at its output.   | Check the output wiring and/or connected devices to its output are short-circuited.   |
| One of the following codes are displayed in the LCD panel 01, 02, 03, 04, 11, 12, 13, 14,1A, 21, 24, 35, 36, 41, 42 or 43 and the acoustic alarm beeps continuously.                      | An internal fault has occurred. Two possible situations:<br>1. The load is still supplied, but through the UPS bypass.<br>2. The load is not supplied. | Contact with the distributor.   |
| The back up time is lower than the expected   | Batteries are not fully charged  | Charge the batteries for 7 hours at least and then check their capacity. If the problem persists, contact with the distributor. |
|   | Batteries are damaged  | Contact with the distributor to replace the battery.  |
| The  icon and the <b>TEMP</b> message blink in the LCD panel and the acoustic alarm beeps every second.  | The fan is blocked or it does not work ; or the UPS temperature is very high.  | Check the fans and contact with the distributor .   |

Tab. 15. Troubleshooting guide.

### 8.3. WARRANTY CONDITIONS.

#### 8.3.1. Warranty terms.

The warranty conditions for this product can be found in our website, register the product in it. It is recommended to do it as soon as possible in order to include it in the database of our Technical Service and Support (**T.S.S.**). Among other advantages, it will be easier to make any proceeding, in case it was needed an intervention from **T.S.S.**.

#### 8.3.2. Out of scope of supply.

**Our company** is not forced by the warranty in case it is detected that the defect was caused by wrong use, negligence, not suitable installation and/or checking, reparation by non-authorized personnel, accident, fire, lightning or any other cause far from the foreseen use. In all these cases, no compensation will be covered by damaged or injuries.

### 8.4. TECHNICAL SERVICE NETWORK.

The coverage, both national and international, of the Technical Service and Support (**T.S.S.**), can be found in our website.

## 9. ANNEXES.

### 9.1. GENERAL TECHNICAL FEATURES.

| Models:   | TWIN PRO  |       |       |       |         |   | TWIN3 PRO  |         |        |           |         |
|---|---|-------|-------|-------|---------|---|--|---------|--------|-----------|---------|
| Available powers (kVA / kW) (**)                                  | 4 / 4   | 5 / 5 | 6 / 6 | 8 / 8 | 10 / 10 | 15 / 13.5                                   | 20 / 18  | 8 / 7.2 | 10 / 9 | 15 / 13.5 | 20 / 18 |
| Technology  | On-line double conversion, PFC, double DC bus                       |       |       |       |         |   |  |         |        |           |         |
| <b>Rectifier</b>  |   |       |       |       |         |   |  |         |        |           |         |
| Input typology  | Single phase  |       |       |       |         |   | Three phase  |         |        |           |         |
| Quantity of wires   | 3 wires - Phase R (L) + Neutral (N) and PE                          |       |       |       |         |   | 5 wires - 3 Phases R (L1), S (L2), T (L3) + Neutral (N) and PE |         |        |           |         |
| Nominal voltage   | 208 / 220 / 230 / 240 V AC  |       |       |       |         | 220 / 230 / 240 V AC                        | 3 x 360 / 3 x 380 / 3 x 400 / 3 x 415 V AC                     |         |        |           |         |
| Input voltage range with 100 % load                               | 176.. 276 V AC  |       |       |       |         |   | 3 x 305.. 478 V AC   |         |        |           |         |
| Input voltage range with 50 % load                                | 110.. 300 V AC  |       |       |       |         |   | 3 x 190.. 520 V AC   |         |        |           |         |
| Voltage range of transference:                                    | At full load  |       |       |       |         |   |  |         |        |           |         |
| - Low mains voltage   | 176 V AC (±3 %)   |       |       |       |         |   | 305 V AC (± 3 %)   |         |        |           |         |
| - Low mains voltage returned                                      | 186 V AC (±3 %)   |       |       |       |         |   | 322 V AC (± 3 %)   |         |        |           |         |
| - High mains voltage  | 276 V AC (±3 %)   |       |       |       |         |   | 478 V AC (± 3 %)   |         |        |           |         |
| - High mains voltage returned                                     | 266 V AC (±3 %)   |       |       |       |         |   | 460 V AC (± 3 %)   |         |        |           |         |
| Frequency   | 50 / 60 Hz (autosensing)  |       |       |       |         |   |  |         |        |           |         |
| Input frequency range   | ± 4 Hz (46.. 54 / 56.. 64 Hz)                                       |       |       |       |         |   |  |         |        |           |         |
| Power factor  | > 0.99 (at full load)   |       |       |       |         |   |  |         |        |           |         |
| <b>Inverter</b>   |   |       |       |       |         |   |  |         |        |           |         |
| Technology  | PWM   |       |       |       |         |   |  |         |        |           |         |
| Wave shape  | Pure sinewave   |       |       |       |         |   |  |         |        |           |         |
| Nominal voltage   | 208 / 220 / 230 / 240 V AC  |       |       |       |         | 220 / 230 / 240 V AC                        |  |         |        |           |         |
| Output voltage accuracy   | ± 1 %   |       |       |       |         |   |  |         |        |           |         |
| Voltage THD with linear load                                      | < 1 %   |       |       |       |         |   | < 2 %  |         |        |           |         |
| Voltage THD with non-linear load                                  | < 4 %   |       |       |       |         |   | < 5 %  |         |        |           |         |
| Frequency   | With mains , synchronised with nominal input (46.. 54 / 56.. 64 Hz) |       |       |       |         |   |  |         |        |           |         |
|   | Free running, battery mode 50 / 60 ±0.1 Hz                          |       |       |       |         | Free running, battery mode 50 / 60 ±0.05 Hz |  |         |        |           |         |
| Slew rate   | 1 Hz/sec.   |       |       |       |         |   |  |         |        |           |         |
| Power factor  | 1 (by default)  |       |       |       |         |   | 0.9 (by default)   |         |        |           |         |
| Permissible load power factor                                     | 0.5.. 1 lagging   |       |       |       |         |   |  |         |        |           |         |
| Transfer time, inverter to battery                                | 0 ms.   |       |       |       |         |   |  |         |        |           |         |
| Transfer time, inverter to bypass                                 | 0 ms.   |       |       |       |         |   |  |         |        |           |         |
| Transfer time, inverter to ECO                                    | 0 ms.   |       |       |       |         |   |  |         |        |           |         |
| Transfer time, ECO to inverter                                    | < 10 ms.  |       |       |       |         |   |  |         |        |           |         |
| Efficiency at full load, on normal mode with battery 100% charged | > 93 %  |       |       |       |         |   | > 90 %   |         |        |           |         |
| Efficiency at full load, on ECO mode                              | > 99 %  |       |       |       |         |   | > 96 %   |         |        |           |         |
| Overload on normal mode   | 100.. 110 %, 10 min.  |       |       |       |         |   |  |         |        |           |         |
|   | > 110.. 130 %, 60 sec.  |       |       |       |         |   |  |         |        |           |         |
|   | > 130 %, 1 sec.   |       |       |       |         |   |  |         |        |           |         |
| Overload on battery mode  | 100.. 110 %, 30 sec.  |       |       |       |         |   |  |         |        |           |         |
|   | > 110.. 130 %, 10 sec.  |       |       |       |         |   |  |         |        |           |         |
|   | > 130 %, 1 sec.   |       |       |       |         |   |  |         |        |           |         |
| Crest factor  | 3:1   |       |       |       |         |   |  |         |        |           |         |
| Quantity of parallel equipments                                   | Up to 3 UPSs  |       |       |       |         |   |  |         |        |           |         |
| <b>Static Bypass</b>  |   |       |       |       |         |   |  |         |        |           |         |
| Type  | Hybrid (thyristors in antiparallel + relay)                         |       |       |       |         |   |  |         |        |           |         |
| Nominal voltage   | 208 / 220 / 230 / 240 V AC  |       |       |       |         | 220 / 230 / 240 V AC                        |  |         |        |           |         |
| Nominal frequency   | 50 / 60 Hz ±4 Hz  |       |       |       |         |   |  |         |        |           |         |
| Overload  | < 130 %, constant   |       |       |       |         |   |  |         |        |           |         |
|   | > 130 %, 60 sec.  |       |       |       |         |   |  |         |        |           |         |
| <b>Batteries</b>  |   |       |       |       |         |   |  |         |        |           |         |
| Voltage / capacity  | 12 V DC / 7 Ah  |       |       |       |         | 12 V DC / 9 Ah                              |  |         |        |           |         |
| Quantity of batteries per string / set voltage                    | 20 / 240 V DC   |       |       |       |         |   |  |         |        |           |         |
| Quantity of battery strings                                       | 1   |       |       |       | 2       |   | 1  |         | 2      |           |         |
| Low battery voltage, battery block / string                       | 11.4 V DC / 228 V DC  |       |       |       |         |   |  |         |        |           |         |

| Models:                                      | TWIN PRO   |       |       |       |         |   |         | TWIN/3 PRO   |        |   |         |  |
|--|--|-------|-------|-------|---------|---|---------|--|--------|---|---------|--|
| Available powers (kVA / kW) (**)             | 4 / 4  | 5 / 5 | 6 / 6 | 8 / 8 | 10 / 10 | 15 / 13.5                                   | 20 / 18 | 8 / 7.2  | 10 / 9 | 15 / 13.5                                   | 20 / 18 |  |
| <b>Internal battery charger</b>              |  |       |       |       |         |   |         |  |        |   |         |  |
| Type of load                                 | I / U (Constant current / constant voltage)                        |       |       |       |         |   |         |  |        |   |         |  |
| Constant current / constant voltage          | 1/2/4 A depending on the model / 273 V DC (13.65 V DC bat. block.) |       |       |       |         | 2/4/6/8 A / 288 V DC (14.4 V DC bat. block) |         | 1/2/4 A depending on the model / 273 VDC (13.65 V DC bat. block) |        | 2/4/6/8 A / 288 V DC (14.4 V DC bat. block) |         |  |
| Floating voltage, battery block / string     | 13,65 V CC / 273 V CC  |       |       |       |         | 13,65 V CC / 288 V CC                       |         | 13,65 V CC / 273 V CC  |        | 13,65 V CC / 288 V CC                       |         |  |
| Maximum charge current                       | 4 A  |       |       |       |         | 8 A   |         | 4 A  |        | 8 A   |         |  |
| Recharging time                              | 7 hours at 90%   |       |       |       |         | 9 hours at 90%                              |         |  |        |   |         |  |
| Voltage / temperature compensation           | - 20 mV / °C per battery from 25 °C                                |       |       |       |         |   |         |  |        |   |         |  |
| <b>Internal battery charger, option (B1)</b> |  |       |       |       |         |   |         |  |        |   |         |  |
| Maximum charge current                       | 4 A  |       |       |       |         | 8 A   |         | 4 A  |        | 8 A   |         |  |
| <b>Generals</b>                              |  |       |       |       |         |   |         |  |        |   |         |  |
| Communication ports                          | RS232 -DB9- and USB, mutually exclusive                            |       |       |       |         |   |         |  |        |   |         |  |
| Monitoring software                          | Viewpower (free download)  |       |       |       |         |   |         |  |        |   |         |  |
| Noise level at 1 m.                          | < 58 dB  |       |       |       |         | < 60 dB                                     |         | < 58 dB  |        | < 60 dB                                     |         |  |
| Operating temperature                        | 0.. 40 °C  |       |       |       |         |   |         |  |        |   |         |  |
| Storage temperature                          | 0.. 35 °C  |       |       |       |         |   |         |  |        |   |         |  |
| Storage temperature with no batteries        | - 15.. + 60 °C   |       |       |       |         |   |         |  |        |   |         |  |
| Operating altitude                           | 2.400 m a.s.l.   |       |       |       |         |   |         |  |        |   |         |  |
| Relative humidity                            | 0.. 95 % non-condensing  |       |       |       |         |   |         |  |        |   |         |  |
| Protection degree                            | IP20   |       |       |       |         |   |         |  |        |   |         |  |
| Dimensions -Depth x Width x Height- (mm)     | 592 x 250 x 576  |       |       |       |         | 815 x 250 x 826                             |         | 592 x 250 x 576  |        | 815 x 250 x 826                             |         |  |
| Dimensions -Depth x Width x Height- (mm) B1  | 592 x 250 x 576  |       |       |       |         |   |         |  |        |   |         |  |
| Weight (kg) -Standard equipment-             | 81   | 82    | 83    | 84    | 85      | 164   | 166     | 84   | 85     | 164   | 166     |  |
| Weight (kg) -Equipment B0-                   | 14   | 15    | 16    | 26    | 28      | 37  | 38      | 27   | 28     | 37  | 38      |  |
| Weight (kg) -Equipment B1-                   | 16   | 17    | 18    | 29    | 30      | 37  | 38      | 29   | 30     | 37  | 38      |  |
| Safety                                       | EN-IEC 62040-1; EN-IEC 60950-1                                     |       |       |       |         |   |         |  |        |   |         |  |
| Electromagnetic compatibility (EMC)          | EN-IEC 62040-2   |       |       |       |         |   |         |  |        |   |         |  |
| Marking                                      | CE   |       |       |       |         |   |         |  |        |   |         |  |
| Quality System                               | ISO 9001 and ISO 140001  |       |       |       |         |   |         |  |        |   |         |  |

(\*\*) As frequency converter, the supplied power will be 70 % of the nominal one.

Tab. 16. General technical specifications.

## 9.2. GLOSARIO.

- **AC.-** Se denomina corriente alterna (abreviada CA en español y AC en inglés) a la corriente eléctrica en la que la magnitud y dirección varían cíclicamente. La forma de onda de la corriente alterna más comúnmente utilizada es la de una onda senoidal, puesto que se consigue una transmisión más eficiente de la energía. Sin embargo, en ciertas aplicaciones se utilizan otras formas de onda periódicas, tales como la triangular o la cuadrada.
- **Bypass.-** Manual o automáticamente, se trata de la unión física entre la entrada de un dispositivo eléctrico con su salida.
- **DC.-** La corriente continua (CC en español, en inglés DC, de Direct Current) es el flujo continuo de electrones a través de un conductor entre dos puntos de distinto potencial. A diferencia de la corriente alterna (CA en español, AC en inglés), en la corriente continua las cargas eléctricas circulan siempre en la misma dirección desde el punto de mayor potencial al de menor. Aunque comúnmente se identifica la corriente continua con la corriente constante (por ejemplo la suministrada por una batería), es continua toda corriente que mantenga siempre la misma polaridad.
- **DSP.-** Es el acrónimo de Digital Signal Processor, que significa Procesador Digital de Señal. Un DSP es un sistema basado en un procesador o microprocesador que posee un juego de instrucciones, un hardware y un software optimizados para aplicaciones que requieran operaciones numéricas a muy alta velocidad. Debido a esto es especialmente útil para el procesamiento y representación de señales analógicas en tiempo real: en un sistema que trabaje de esta forma (tiempo real) se reciben muestras (samples en inglés), normalmente provenientes de un conversor analógico/digital (**ADC**).
- **Factor de potencia.-** Se define factor de potencia, f.d.p., de un circuito de corriente alterna, como la relación entre la potencia activa, P, y la potencia aparente, S, o bien como el coseno del ángulo que forman los factores de la intensidad y el voltaje, designándose en este caso como  $\cos \phi$ , siendo  $\phi$  el valor de dicho ángulo.
- **GND.-** El término tierra (en inglés GROUND, de donde proviene la abreviación GND), como su nombre indica, se refiere al potencial de la superficie de la Tierra.
- **Filtro EMI.-** Filtro capaz de disminuir de manera notable la interferencia electromagnética, que es la perturbación que ocurre en un receptor radio o en cualquier otro circuito eléctrico causada por radiación electromagnética proveniente de una fuente externa. También se conoce como EMI por

sus siglas en inglés (ElectroMagnetic Interference), Radio Frequency Interference o RFI. Esta perturbación puede interrumpir, degradar o limitar el rendimiento del circuito

- **IGBT.-** El transistor bipolar de puerta aislada (IGBT, del inglés Insulated Gate Bipolar Transistor) es un dispositivo semiconductor que generalmente se aplica como interruptor controlado en circuitos de electrónica de potencia. Este dispositivo posee la características de las señales de puerta de los transistores de efecto campo con la capacidad de alta corriente y voltaje de baja saturación del transistor bipolar, combinando una puerta aislada FET para la entrada e control y un transistor bipolar como interruptor en un solo dispositivo. El circuito de excitación del IGBT es como el del MOSFET, mientras que las características de conducción son como las del BJT.
- **Interface.-** En electrónica, telecomunicaciones y hardware, una interfaz (electrónica) es el puerto (circuito físico) a través del que se envían o reciben señales desde un sistema o subsistemas hacia otros
- **kVA.-** El voltampere es la unidad de la potencia aparente en corriente eléctrica. En la corriente directa o continua es prácticamente igual a la potencia real pero en corriente alterna puede diferir de ésta dependiendo del factor de potencia.
- **LCD.-** LCD (Liquid Crystal Display) son las siglas en inglés de Pantalla de Cristal Líquido, dispositivo inventado por Jack Janning, quien fue empleado de NCR. Se trata de un sistema eléctrico de presentación de datos formado por 2 capas conductoras transparentes y en medio un material especial cristalino (cristal líquido) que tienen la capacidad de orientar la luz a su paso.
- **LED.-** Un LED, siglas en inglés de Light-Emitting Diode (diodo emisor de luz) es un dispositivo semiconductor (**diodo**) que emite luz casi monocromática, es decir, con un espectro muy angosto, cuando se polariza en directa y es atravesado por una corriente eléctrica. El color, (longitud de onda), depende del material semiconductor empleado en la construcción del diodo, pudiendo variar desde el ultravioleta, pasando por el espectro de luz visible, hasta el infrarrojo, recibiendo éstos últimos la denominación de IRED (Infra-Red Emitting Diode).
- **Magnetotérmico.-** Un interruptor magnetotérmico, o disyuntor magnetotérmico, es un dispositivo capaz de interrumpir la corriente eléctrica de un circuito cuando ésta sobrepasa ciertos valores máximos.
- **Modo On-Line.-** En referencia a un equipo, se dice que está en línea cuando está conectado al sistema, se encuentra operativo, y normalmente tiene su fuente de alimentación conectada.
- **Inversor.-** Un inversor, también llamado ondulator, es un circuito utilizado para convertir corriente continua en corriente alterna. La función de un inversor es cambiar un voltaje de entrada de corriente directa a un voltaje simétrico de salida de corriente alterna, con la magnitud y frecuencia deseada por el usuario o el diseñador.
- **Rectificador.-** En electrónica, un rectificador es el elemento o circuito que permite convertir la corriente alterna en corriente continua. Esto se realiza utilizando diodos rectificadores, ya sean semiconductores de estado sólido, válvulas al vacío o válvulas gaseosas como las de vapor de mercurio. Dependiendo de las características de la alimentación en corriente alterna que emplean, se les clasifica

en monofásicos, cuando están alimentados por una fase de la red eléctrica, o trifásicos cuando se alimentan por tres fases. Atendiendo al tipo de rectificación, pueden ser de media onda, cuando solo se utiliza uno de los semiciclos de la corriente, o de onda completa, donde ambos semiciclos son aprovechados.

- **Relé.-** El relé o relevador (del francés relais, relevo) es un dispositivo electromecánico, que funciona como un interruptor controlado por un circuito eléctrico en el que, por medio de un electroimán, se acciona un juego de uno o varios contactos que permiten abrir o cerrar otros circuitos eléctricos independientes.
- **SCR.-** Abreviatura de «Rectificador Controlado de Silicio», comúnmente conocido como Tiristor: dispositivo semiconductor de 4 capas que funciona como un conmutador casi ideal.
- **THD.-** Son las siglas de «Total Harmonic Distortion» o «Distorsión armónica total». La distorsión armónica se produce cuando la señal de salida de un sistema no equivale a la señal que entró en él. Esta falta de linealidad afecta a la forma de la onda, porque el equipo ha introducido armónicos que no estaban en la señal de entrada. Puesto que son armónicos, es decir múltiplos de la señal de entrada, esta distorsión no es tan disonante y es menos fácil de detectar.



A series of horizontal dotted lines for writing, starting from the first line below the symbol and continuing down the page.





# SALICRU

Avda. de la Serra 100  
08460 Palautordera

**BARCELONA**

Tel. +34 93 848 24 00

Fax +34 93 848 22 05

services@salicru.com

**SALICRU.COM**



The Technical Service and Support (T.S.S.) network, Commercial network and warranty information are available in website:

**[www.salicru.com](http://www.salicru.com)**

#### **Product Range**

Uninterruptible Power Supplies (UPS)

Lighting Flow Dimmer-Stabilisers

DC Power Systems

Static Inverters

Photovoltaic Inverters

Voltage stabilisers



@salicru\_SA



[www.linkedin.com/company/salicru](http://www.linkedin.com/company/salicru)

