

PHILIPS

4K Ultra HD
Blu-ray™ Player

BDP7302



Register your product and get support at

www.philips.com/welcome

User Manual

For further assistance, call the customer support service in your country.

To obtain assistance, contact Philips Customer Care Center;

In the U.S.A., Canada, Puerto Rico, or the U.S.

Virgin Islands; **1-866-202-5960**

CONTENTS

INTRODUCTION	3	NETWORK SERVICES	44
Safety instruction	3	Before using network services	44
Included accessories	6	Information on network services	44
FEATURES	7	Deactivate the network services	44
Features	7	LIST OF SETTINGS	45
Version information	9	SETUPS	49
Symbols used in this owner's manual	9	Network connection	49
FUNCTIONAL OVERVIEW	10	EasyLink (HDMI CEC)	54
Top / front panel	10	HDMI video resolution	55
Rear panel	10	Parental controls	56
Remote control	11	Software update	57
Guide to on-screen display	13	Voice guide	58
CONNECTIONS	14	Restore default settings	59
HDMI video /audio connection	14	TROUBLESHOOTING	60
HDMI audio output	19	SPECIFICATIONS	64
Connection to the network	20	NETWORK SERVICE DISCLAIMER	65
BEFORE YOU START	22	MAINTENANCE	66
Initial setup	22	TRADEMARK INFORMATION	67
INFORMATION ON PLAYBACK	24	GLOSSARY	69
Information on playback	24	IMPORTANT HEALTH AND SAFETY	
Guide to file list	27	INFORMATION FOR 3D TELEVISIONS	71
How to insert a disc	28	LIMITED WARRANTY	72
BASIC PLAYBACK	29		
Playing back a disc	29		
4K, 4K HDR or Dolby Vision playback	31		
Playing back an Ultra HD Blu-ray™ disc	32		
Playing back a Blu-ray 3D™ disc	33		
Playing back content from a USB memory stick	34		
Using the title / disc / pop menu	35		
SPECIAL PLAYBACK	36		
Fast forward / fast reverse	36		
Slow forward playback	36		
Frame by frame playback	36		
Repeat playback	37		
Shuffle / random playback	37		
Slide show	37		
PiP (BONUSVIEW™) setting	38		
Enjoying BD-Live™ discs using Internet	38		
Title / chapter search	39		
Track / file search	39		
Time search	40		
Number select search	40		
Switching subtitles	41		
Switching audio soundtrack	42		
Switching camera angles	43		
Noise reduction	43		
Closed caption	43		

1. INTRODUCTION

1.1. Safety instruction

Register online at www.philips.com/welcome today to get the most benefits from your purchase.

Registering your model with Philips makes you eligible for all of the valuable benefits listed below, so don't miss out. Register online at www.philips.com/welcome to ensure:



* Product Safety Notification

By registering your product, you'll receive notification - directly from the manufacturer - in the rare case of a product recall or safety defect.

* Additional Benefits

Registering your product guarantees that you'll receive all of the privileges to which you're entitled, including special money-saving offers.

Know these
safety symbols

	CAUTION RISK OF ELECTRIC SHOCK DO NOT OPEN	AVIS RISQUE DE CHOC ÉLECTRIQUE NE PAS OUVRIR.	
CAUTION: TO REDUCE THE RISK OF ELECTRIC SHOCK, DO NOT REMOVE COVER (OR BACK). NO USER-SERVICEABLE PARTS INSIDE. REFER SERVICING TO QUALIFIED SERVICE PERSONNEL.			



The lightning flash with arrowhead symbol, within an equilateral triangle, is intended to alert the user to the presence of uninsulated "dangerous voltage" within the product's enclosure that may be of sufficient magnitude to constitute a risk of electric shock to persons.



The exclamation point within an equilateral triangle is intended to alert the user to the presence of important operating and maintenance (servicing) instructions in the literature accompanying the appliance.

WARNING: TO REDUCE THE RISK OF FIRE OR ELECTRIC SHOCK, DO NOT EXPOSE THIS APPARATUS TO RAIN OR MOISTURE. APPARATUS SHALL NOT BE EXPOSED TO DRIPPING OR SPLASHING AND NO OBJECTS FILLED WITH LIQUIDS, SUCH AS VASES, SHALL BE PLACED ON THE APPARATUS.

CAUTION: To prevent electric shock, match wide blade of plug to wide slot, fully insert.

ATTENTION: Pour éviter les chocs électriques, introduire la lame la plus large de la fiche dans la borne correspondante de la prise et pousser jusqu'au fond.

The symbol for CLASS II (Double Insulation)

The important note and rating are located on the rear or bottom of the cabinet.

For Customer Use

Please write the model and serial number of your unit (located on the cabinet) in the space below for future reference.

Model No. _____

Serial No. _____

PHILIPS

For fastest support visit us online at www.philips.com/support for chat and self service solutions.

IMPORTANT SAFETY INSTRUCTIONS

1. Read these instructions.
2. Keep these instructions.
3. Heed all warnings.
4. Follow all instructions.
5. Do not use this apparatus near water.
6. Clean only with dry cloth.
7. Do not block any ventilation openings. Install in accordance with the manufacturer's instructions.
8. Do not install near any heat sources such as radiators, heat registers, stoves, or other apparatus (including amplifiers) that produce heat.
9. Do not defeat the safety purpose of the polarized or grounding-type plug. A polarized plug has two blades with one wider than the other. A grounding type plug has two blades and a third grounding prong. The wide blade or the third prong are provided for your safety. If the provided plug does not fit into your outlet, consult an electrician for replacement of the obsolete outlet.
10. Protect the power cord from being walked on or pinched particularly at plugs, convenience receptacles, and the point where they exit from the apparatus.
11. Only use attachments/accessories specified by the manufacturer.
12. Use only with the cart, stand, tripod, bracket, or table specified by the manufacturer, or sold with the apparatus. When a cart is used, use caution when moving the cart / apparatus combination to avoid injury from tip-over.
13. Unplug this apparatus during lightning storms or when unused for long periods of time.
14. Refer all servicing to qualified service personnel. Servicing is required when the apparatus has been damaged in any way, such as power-supply cord or plug is damaged, liquid has been spilled or objects have fallen into the apparatus, the apparatus has been exposed to rain or moisture, does not operate normally, or has been dropped.



FCC WARNING

This equipment may generate or use radio frequency energy. Changes or modifications to this equipment may cause harmful interference unless the modifications are expressly approved in the manual. The user could lose the authority to operate this equipment if an unauthorized change or modification is made.

RADIO-TV INTERFERENCE

This equipment has been tested and found to comply with the limits for a Class B digital device, pursuant to Part 15 of the FCC Rules. These limits are designed to provide reasonable protection against harmful interference in a residential installation. This equipment generates, uses, and can radiate radio frequency energy and, if not installed and used in accordance with the instructions, may cause harmful interference to radio communications. However, there is no guarantee that interference will not occur in a particular installation. If this equipment does cause harmful interference to radio or television reception, which can be determined by turning the equipment off and on, the user is encouraged to try to correct the interference by one or more of the following measures:

1. Reorient or relocate the receiving antenna.
2. Increase the separation between the device and the receiver.
3. Connect the device into an outlet on a circuit different from that to which the receiver is connected.
4. Consult the dealer or an experienced radio / TV technician for help.

Disconnect the mains plug (the AC plug) to shut the unit off when trouble is found or when not in use. The mains plug (the AC plug) shall remain readily available. To completely turn off the unit, you must unplug the mains (AC) power cord.

CAN ICES-3 (B)/NMB-3(B)

CAUTION: Danger of explosion if battery is incorrectly replaced. Replace only with the same or equivalent type.

WARNING: Batteries (Battery pack or battery installed) shall not be exposed to excessive heat such as sunshine, fire or the like.

LASER SAFETY

This apparatus is classified as a CLASS 1 LASER PRODUCT.

This apparatus employs a laser. Only a qualified service person should remove the cover or attempt to service this apparatus, due to possible eye injury.

CLASS 1 LASER PRODUCT
PRODUIT LASER DE CLASSE 1

CAUTION: Use of controls or adjustments or performance of procedures other than those specified herein may result in hazardous radiation exposure.

IMPORTANT COPYRIGHT INFORMATION

Unauthorized copying, broadcasting, public performance and lending of discs are prohibited. This item incorporates copy protection technology that is protected by U.S. patents and other intellectual property rights of Rovi Corporation. Reverse engineering and disassembly are prohibited.

Never use a gas duster on this unit.

The gas trapped inside of this unit may cause ignition and explosion.

Do not place the unit on furniture that is capable of being tilted by a child and an adult leaning, pulling, standing or climbing on it. A falling unit can cause serious injury or even death.

In order to avoid interruption of ventilation, this unit should not be placed in built-in equipment such as a book cabinet, rack, etc., and the vents of this unit should not be covered with anything such as a tablecloth, curtain, newspaper, etc. Make sure to leave a space of 5.9 inches (15cm) or more around this apparatus.

When installing this unit in a temperate environment, avoid a place with rapid temperature changes.

This unit should not be used in a tropical environment as it has not been evaluated under such conditions.

No objects should be placed directly on or under this unit, especially lighted candles or other flaming objects.

The following FCC/IC RSS applies to the Wireless LAN adapter included in this product.

FCC Caution: Any changes or modifications not expressly approved by the party responsible for compliance could void the user's authority to operate this equipment.

This transmitter must not be co-located or operating in conjunction with any other antenna or transmitter.

This device complies with Industry Canada license-exempt RSS standard(s). Operation is subject to the following two conditions: (1) this device may not cause interference and (2) this device must accept any interference, including interference that may cause undesired operation of the device.

5150-5250 MHz band is restricted to indoor operations only.

High-power radars are allocated as primary users (i.e. priority users) of the bands 5250-5350 MHz and 5650-5850 MHz and that these radars could cause interference and/or damage to LE-LAN devices.

Compliance with IC requirement RSS-210 A9.4.4

Data transmission is always initiated by software, which is the passed down through the MAC, through the digital and analog baseband, and finally to the RF chip. Several special packets are initiated by the MAC. These are the only ways the digital baseband portion will turn on the RF transmitter, which it then turns off at the end of the packet. Therefore, the transmitter will be on only while one of the aforementioned packets is being transmitted. In other words, this device automatically discontinue transmission in case of either absence of information to transmit or operational failure.

To avoid the hazards of electrical shock and fire

Do not handle the power cord with wet hands.

Do not pull on the power cord when disconnecting it from an AC outlet. Grasp it by the plug.

Do not put your fingers or objects into the unit.

Location and handling

Do not install the unit in direct sunlight, near strong magnetic fields or in a place subject to dust or strong vibration. Avoid a place with drastic temperature changes.

Install the unit in a horizontal and stable position. Do not place anything directly on top or bottom of the unit.

Depending on your external devices, noise or disturbance of picture and/or sound may be generated if the unit is placed too close to them. In this case, please ensure enough space between external devices and the unit.

Depending on the environment, the temperature of this unit may increase slightly. This is not a malfunction.

Be sure to remove the disc and unplug the AC power cord from the outlet before carrying the unit.

Dew condensation warning

Dew condensation may form inside the unit in the following conditions. If so, do not use this unit at least for a few hours until its inside gets dry.

- The unit is moved from a cold place to a warm place.
- Under conditions of high humidity.
- After heating a cold room.

Notice

Specifications are subject to change without notice. Trademarks are the property of Koninklijke Philips N.V. or their respective owners. P&F USA reserves the right to change products at any time without being obliged to adjust earlier supplies accordingly. The material in this manual is believed adequate for the intended use of the system. If the product, or its individual modules or procedures, are used for purposes other than those specified herein, confirmation of their validity and suitability must be obtained. P&F USA warrants that the material itself does not infringe any United States patents. No further warranty is expressed or implied. P&F USA cannot be held responsible for any errors in the content of this document, or for any problems as a result of the content in this document. Errors reported to P&F USA will be adapted and published on the P&F USA support website as soon as possible.

Warranty

No components are user serviceable. Do not open or remove covers to the inside of the product. Repairs may only be done by Service Centers and official repair shops. Failure to do so shall void any warranty, stated or implied. Any adjustments or assembly procedures not recommended or authorized in this manual, or any operation expressly prohibited in this manual shall void the warranty.

Important

Registering your model with Philips makes you eligible for all of the valuable benefits listed below, so don't miss out. Register online at www.philips.com/support to ensure:

Product safety notification

By registering your product you receive notification - directly from the manufacturer - in the rare case of a product recall or safety defect.

Additional benefits of product ownership

Registering your product guarantees that you receive all of the privileges to which you're entitled, including special money-saving offers.

For further assistance

For further assistance, call the customer support service in your country.

To obtain assistance in the U.S.A., Canada, Puerto Rico, or the U.S. Virgin Islands, contact Philips Customer Care Center at 1-866-202-5960

Environmental care

The packaging of this product is intended to be recycled. Contact your local authorities for information about how to recycle the packaging.

For Product recycling information, please visit - www.recycle.philips.com

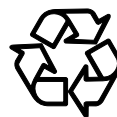

Disposal of used batteries

The batteries included do not contain the heavy metals mercury and cadmium, however in certain localities, disposing batteries with household waste is not permitted. Please ensure you dispose of batteries according to local regulations.

1.2. Included accessories

- Quick Start Guide
- Remote control (NC282UH)
- Batteries (AAA, 1.5V x 2)

2. FEATURES

2.1. Features

Ultra HD Blu-ray™ disc

You can enjoy Ultra HD Blu-ray™ disc which is capable of storing twice more data than a conventional Blu-ray Disc™.

Blu-ray Disc™

You can enjoy Blu-ray Disc™ which is capable of storing five times more data than a conventional DVD.

BD-Java

With some Blu-ray™ discs which contain Java applications, you can enjoy interactive functions such as games or interactive menus.

DVD upscaling for enhanced picture quality

Your current DVD will look even better than before thanks to video upscaling. Upscaling will increase the resolution of standard definition DVD to high definition up to 1080p over an HDMI connection. The picture will be less jagged and more realistic for a near high definition experience.

Enjoy your content on different kinds of media

Full backwards compatibility with DVD, CD and USB memory stick ensures that you can continue to enjoy your current audio-video collection. Additionally, you can enjoy AVCHD (for DVD-RW/-R only) / video files / photo files / music files.

Listen to rich multi-channel surround sound

Multi-channel surround sound, which realizes real-to-life sound and makes you feel that you are really there.

Easy and simple connection to your HDTV via HDMI

Connect this unit to your HDTV with one single HDMI (High-Definition Multimedia Interface) cable. It is recommended to use a High Speed HDMI cable for better compatibility. The high definition video output signal will be transferred to your HDTV without conversion to analog signals, so you will get excellent picture and sound quality, completely free from noise.

EasyLink (HDMI CEC)

This unit supports HDMI CEC, which allows integrated system control over an HDMI cable and is part of the HDMI standard. This function may not work properly on some devices.

PiP (BONUSVIEW™)

Some BD-Videos have the PiP function which enables you to display the secondary video in the primary video. You can call up the secondary video by pressing [OPTIONS] whenever the scene contains a secondary video.

BD-Live™

BD-Live™ (BD-ROM version 2 Profile 2.0) that allows interactive functions to be used when this unit is connected to the Internet in addition to the BONUSVIEW™ function. The various functions differ depending on the disc.

Pop menu

Some BD-Videos have a pop menu which is a navigation. Some BD-Videos have a pop menu which is a navigation menu that can be called up and be operated on the TV screen without interrupting playback. You can call up the pop menu by pressing [POP MENU]. Contents in the pop menu vary depending on the disc.

HDMI 24p output (Ultra HD Blu-ray™ disc / Blu-ray Disc™)

This unit is equipped with the feature which can provide smooth movement during playback of film originated material with a frame rate of 24 frames per second with progressive. (Available only when the display device is connected with an HDMI cable.) Refer to “HDMI video resolution” on page 55.

BT.2020

BT.2020 is a color gamut standard enhanced from BT.709 adopted for the existing HDTV and Blu-ray Disc™. This new standard fulfills the color range expected for 4K / 8K ultra high definition televisions (UHDTV) which is capable of reproducing 99.9 percent of the colors in nature.

HDR10

HDR10 is an image standard adopted for Ultra HD Blu-ray™ (UHD BD / 4K Blu-ray™) and its color depth is 10 bit which is capable of depicting contrast 4 times more detailed than the existing SDR (8 bit). This technology allows viewers to enjoy pictures with clarity and more natural colors.

Deep Color

Deep Color reduces posterization (color banding) effect of the playback image.

Playing back 4K, 4K HDR or Dolby Vision

This unit is equipped with the function to reproduce 4K, 4K HDR or Dolby Vision. (Video enhancement: progressive scan, video upscaling, BT.2020 / BT.709, HDR to SDR conversion, HDR 10, deep color) page 31.

Playing back contents from a USB memory stick

You can play back photo files / music files / video files stored on a USB memory stick. BD-ROM discs sometimes store picture-in-picture commentary, subtitles or other extras on a USB memory stick for use during playback with the BD-Video.

Playing back AVCHD files

This unit supports playback of AVCHD format files (new format for high definition video camcorders) recorded on a disc / SD memory card using USB card reader. Your high definition personal archive is playable in HD quality.

x.v.Color

This unit supports playback of video contents on discs recorded with “x.v.Color” technology. To watch this video content with the “x.v.Color” space, a TV or other display device supporting both video image reproduction using “x.v.Color” standard and capability of manual switching of its color space setting is required. Please refer to the User Manual of your display device for further information.

Enjoy content stored on home media servers

This unit allows you to play music files, video files, and view photo files stored on home media servers connected to your home network.

Netflix

With this unit, you can enjoy movies and TV episodes streamed instantly from Netflix via the Internet. In order to use this feature, you must visit www.netflix.com/ on your PC and become a Netflix member.

(This feature is available only in the United States.)

YouTube™

This unit enables you to access YouTube™.

On your TV screen, you can enjoy a large number of video clips streamed from YouTube™.

Digital Rights Management

This product contains technology subject to certain intellectual property rights of Microsoft.

Use or distribution of this technology outside of this product is prohibited without the appropriate license(s) from Microsoft.

Auto standby

20 minutes after the screen saver starts, this unit will be placed in standby mode.

2.2. Version information













“Version info” screen provides information about this unit’s software version.

You can also download the latest software from the Philips website and update it yourself if it is newer than the version currently on your unit. The current version of software on your unit can be seen on the “Version info” screen. To access “Version info”, follow the procedure below.

1. Press [**⬆️**(HOME)].
2. Use [**▲** / **▼** / **◀** / **▶**] to select “Setup”, then press [**OK**].
3. Use [**▲** / **▼**] to select “Advanced”, then press [**OK**].
4. Use [**▲** / **▼**] to select “Version info”, then press [**OK**].

2.3. Symbols used in this owner’s manual

To specify which media type each function is applicable to, a combination of the symbols shown below will be depicted next to that function’s explanation.

Symbol	Description
	Description refers to Ultra HD Blu-ray™
	Description refers to BD-Video
	Description refers to DVD-Video
	Description refers to DVD-RW/-R in VR mode
	Description refers to Audio CD / DTS-CD
	Description refers to DVD-RW/-R with AVCHD files
	Description refers to BD-RE/-R, DVD-RW/-R, CD-RW/-R and USB memory stick with photo files.
	Description refers to BD-RE/-R, DVD-RW/-R, CD-RW/-R and USB memory stick with music files.
	Description refers to H.264/H.265 (.mp4/.mov), MPEG2 (TS/PS) (.mpg/.mpeg/.m2ts/.mts/.ts), VOB (.vob), VP9/VP8 (.webm) video files.
	Description refers to video files on the Home Media Server
	Description refers to music files on the Home Media Server
	Description refers to photo files on the Home Media Server

If you do not find any of the symbols listed above under the function heading, the operation is applicable to all media types.

3. FUNCTIONAL OVERVIEW

3.1. Top / front panel

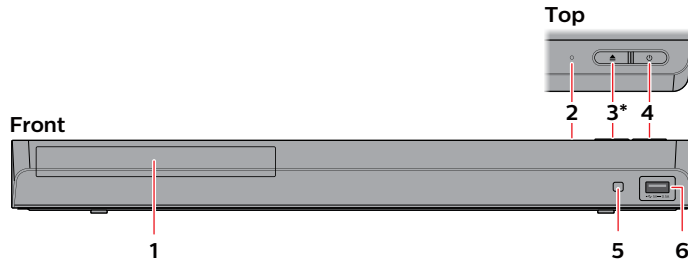

*) The unit can also be turned on by pressing this button.

- | | |
|---------------------------|---------------------------|
| 1. Disc tray | 4. ⏻ (POWER) button |
| 2. Power-on indicator | 5. Infrared sensor window |
| 3. ▲ (OPEN/CLOSE) button* | 6. USB input |

⚠ Caution

- Do not connect any device other than USB memory stick or USB card reader into the USB input. (e.g. PC, external HDD, digital camera, keyboard, mouse, etc.)
- When connecting a USB memory stick, connect it directly to the USB input. Do not use a USB extension cable.

3.2. Rear panel

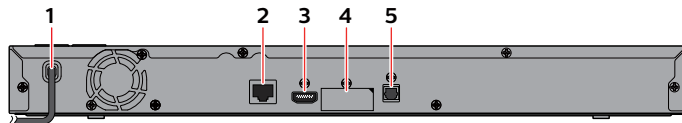

- | | |
|------------------|--------------------------|
| 1. AC power cord | 4. HDMI OUT (AUDIO) jack |
| 2. LAN terminal | 5. OPTICAL jack |
| 3. HDMI OUT jack | |

⚠ Caution

- Do not touch the inner pins of the jacks on the rear panel. Electrostatic discharge may cause permanent damage to the unit.
- This unit does not have a TV RF modulator.

3.3. Remote control

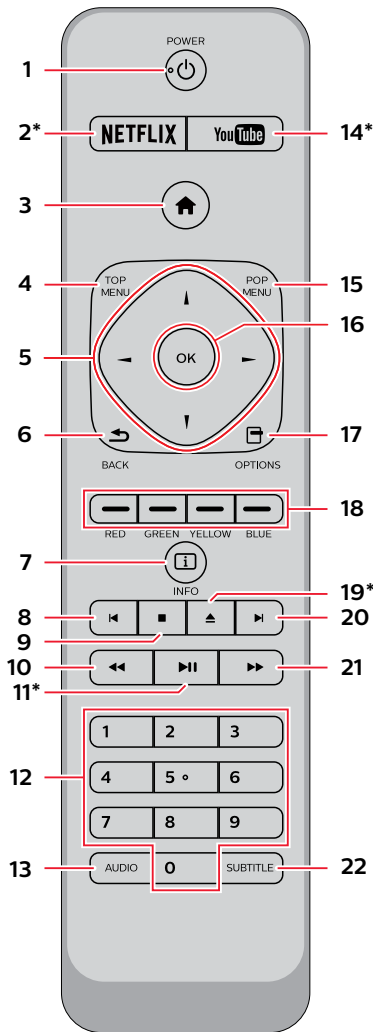

*) The unit can also be turned on by pressing these buttons.

1. **⏻ (POWER) button**
 - Press to turn on the unit, or to switch the unit into standby mode. (To completely turn off the unit, you must unplug the AC power cord.)
2. **NETFLIX button***
 - Press to launch Netflix.
3. **🏠 (HOME) button**
 - Press to display the home menu.
4. **TOP MENU**
Ultra HD Blu-ray™, Blu-ray Disc™:
Press to display the top menu.
DVD: Press to display the title menu.
5. **▲ / ▼ / ◀ / ▶ buttons**
 - Press to select items or settings.
6. **BACK button**
 - Press to return to the previously displayed menu or screen function.

7. **INFO button**
 - Press to display the information display.
8. **⏮ (SKIP) button**
 - During playback, press once to return to the beginning of the current title, chapter, track or file.
 - During playback, press twice to return to the previous title, chapter, track or file.
 - During photo playback, press to return to the previous file.
9. **■ (STOP) button**
 - Press to stop playback.
10. **⏮ (REVERSE) button**
 - During playback, press to fast reverse the playback.
11. **▶▶ (PLAY/PAUSE) button***
 - Press to start playback or resume playback.
 - Press to pause playback.
12. **Number buttons**
 - Press to select a chapter during playback.
13. **AUDIO button**
 - Press to select the audio channel (such as audio languages) on a disc.
14. **YouTube button***
 - Press to launch YouTube™.
15. **POP MENU**
Blu-ray Disc™: Press to display the pop menu.
DVD: Press to display the disc menu.
Photo/Music files: During playback, press to display the file list.
16. **OK button**
 - Press to confirm or select menu items.
17. **OPTIONS button**
 - During playback, press to display the play menu.
18. **RED / GREEN / YELLOW / BLUE buttons**
 - Press to activate shortcut keys on some BD-video functions.
19. **▲ (OPEN/CLOSE) button***
 - Press to open or close the disc tray.
20. **⏮ (SKIP) button**
 - During playback, press to skip to the next chapter, track or file.
 - When playback is in pause mode, press to forward the playback picture by picture.
21. **▶▶ (FORWARD) button**
 - During playback, press to fast forward the playback.
 - When playback is in pause, press to slow forward the playback.
22. **SUBTITLE button**
 - Press to select subtitles on a disc.

Note

- Use the included remote control. Remote-control operation on any other remote control, such as a universal remote control, is not guaranteed.
- Make sure the component code on your universal remote control is set to our brand. Refer to the instruction book accompanying your remote control for more details.

■ Installing the batteries in the remote control

Install 2 AAA (1.5V) batteries matching the polarity indicated inside battery compartment of the remote control.

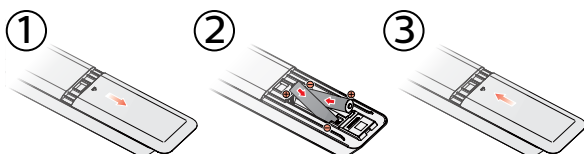

Caution

Incorrect use of batteries can result in hazards such as leakage and bursting. Please follow the guidelines below:

- Lithium or ni-cad and ni-mh rechargeable batteries are not recommended to use for remote control.
- Do not mix different types of batteries such as alkaline and standard (carbon-zinc).
- Do not mix new and old batteries together.
- Do not use different kinds of batteries together. Although they may look similar, different batteries may have different voltages.
- Make sure that the + and - ends of each battery match the indications in the battery compartment.
- Remove batteries from battery compartment, when the remote is not going to be used for a month or more.
- When disposing of used batteries, please comply with governmental regulations or environmental public rules that apply in your country or area.
- Do not recharge, short-circuit, heat, burn or disassemble batteries.

■ Using the remote control

Remote control usage guidelines:

- Make sure that there are no obstacles between the remote control and the infrared sensor window on the unit.
- Remote operation may become unreliable if strong sunlight or fluorescent light is shining on the infrared sensor window of the unit.
- Remote controls of different devices can interfere with each other. Avoid using a remote control from another device which is located close to the unit.
- Replace the batteries when you notice a fall-off in the operating range of the remote control.
- The maximum operable ranges from the unit are as follows.

- Line of sight:

approx. 23 feet (7 m)

- Either side of the center:

approx. 16 feet (5 m) within 30°

- Above:

approx. 16 feet (5 m) within 15°

- Below:

approx. 10 feet (3 m) within 30°

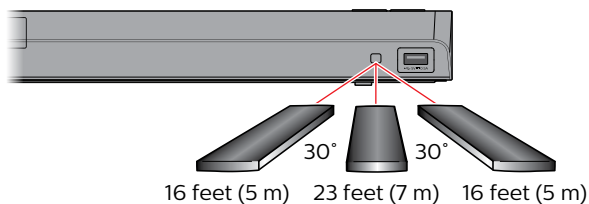

3.4. Guide to on-screen display

■ Home menu

When you turn on the unit, the home menu will appear automatically. Otherwise, press [**HOME**].

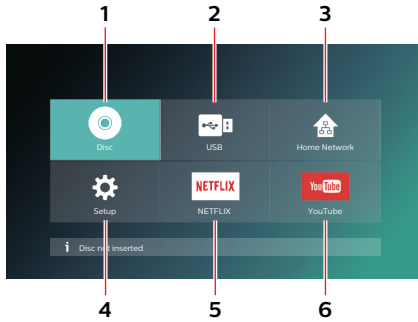

- 1. "Disc": Initiates playback of inserted disc, displays thumbnails of tracks / files.
- 2. "USB": Displays thumbnails of tracks / files on the connected USB memory stick.
- 3. "Home Network": Accesses the home network menu.
- 4. "Setup": Accesses the setup menu
- 5. "NETFLIX": Accesses NETFLIX
- 6. "YouTube": Accesses YouTube

■ Setup menu

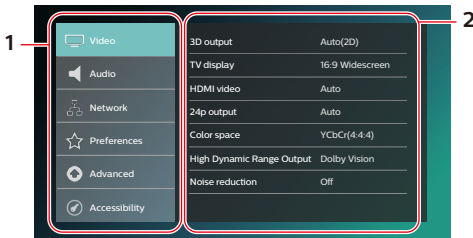

- 1. **Category**
- 2. **Menu / Options:** Displays options for the highlighted item on the left whenever available

■ Play menu

During playback, press [**OPTIONS**] to display the play menu.

(e.g.) Blu-ray Disc™

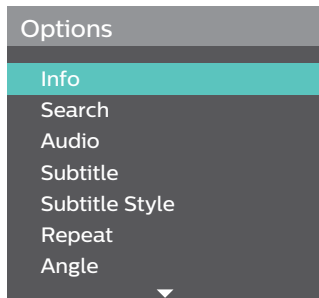

4. CONNECTIONS

There are four ways to connect this unit. Refer to the following instructions to connect this unit to your TV.

- When you change the connections, all devices should be turned off.
- When making connections with external devices, please refer to their user manuals for additional setup help.
- This unit supports a TV up to 1080i, 1080p, 4K resolution.
- This unit is not required for analog audio connection.

4.1. HDMI video /audio connection

Method 1 ▶ Page 15

■ Connecting the unit directly to a TV

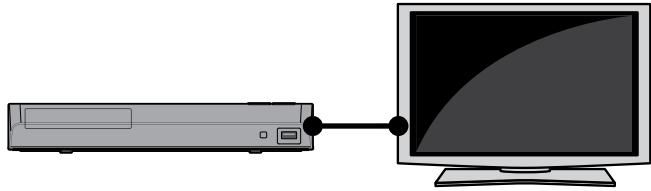

Method 2 ▶ Page 15

■ Connecting with the HDMI OUT and HDMI OUT (AUDIO) Jacks

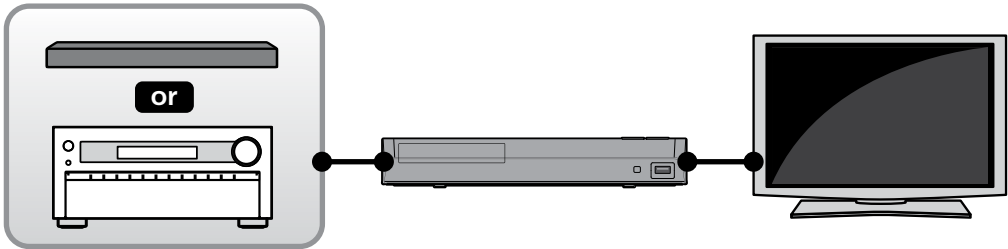

Method 3 ▶ Page 16

■ Connecting the unit through a soundbar or AV receiver

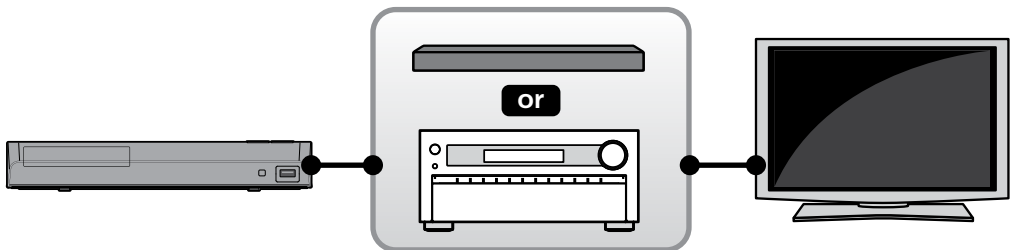

Method 4 ▶ Page 17

■ Connection to a TV and a non-4K compatible soundbar or AV receiver

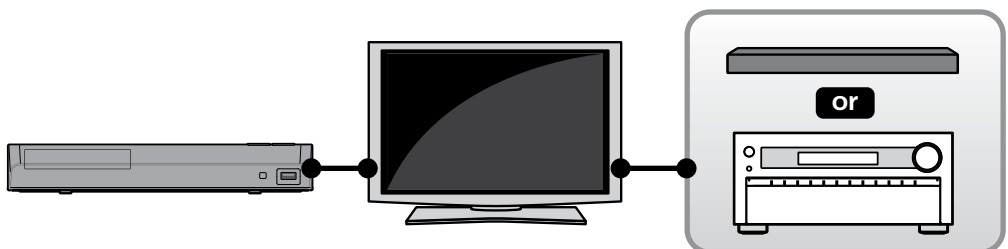

continued on next page

Method 1

■ Connecting the unit directly to a TV

With this connection method, the video and audio are output from the TV.

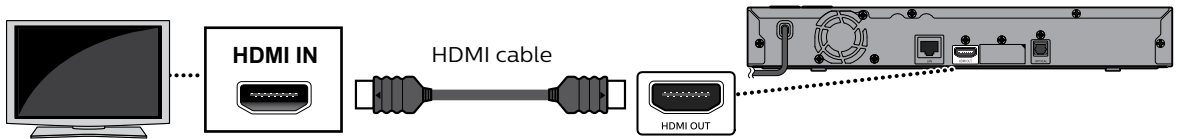

ⓘ Note

- For 4K, 4K HDR or Dolby Vision playback, please your TV supports 4K, 4K HDR or Dolby Vision input.
- The HDMI port on the TV accepts 4K, 4K HDR or Dolby Vision signal. You have set the correct setting in the TV menu for the TV to accept and display 4K, 4K HDR or Dolby Vision signals.
- Use an 18 Gbps high-speed HDMI cable which supports 4K, 4K HDR or Dolby Vision when you connect to TV.
- If you have questions regarding the capabilities and settings of your TV, please contact their manufacturer.

Method 2

■ Connecting with the HDMI OUT and HDMI OUT (AUDIO) Jacks

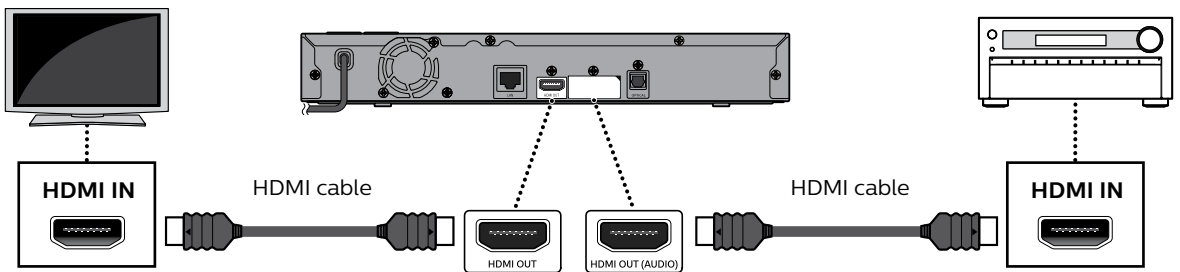

■ Connecting with the HDMI OUT and Optical OUT Jacks

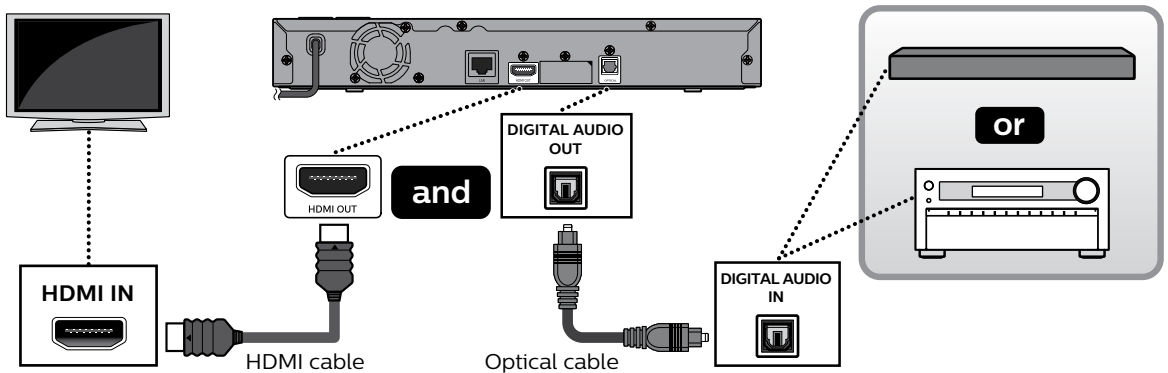

ⓘ Note

- When using the optical out jack on this unit, the sound outputs from your TV's speaker and the AV receiver simultaneously. If you want to mute the sound of your TV, set "HDMI audio" to "Off" on this unit. For more information, refer to "LIST OF SETTINGS" on page 45.
- With this connection, the **HDMI OUT** jack only outputs video, and the **HDMI OUT (AUDIO)** jack only outputs audio.
- The EasyLink function is only available for the **HDMI OUT** jack.
- In order for Ultra HD Blu-ray™ content playback to work on this unit, a 4K/HDR compatible display device and AV receiver/amplifier must be connected to this unit. Otherwise, the audio will not be output.
- In order for 3D content playback to work on this unit, a 3D compatible display device and AV receiver/amplifier must be connected to this unit. Otherwise, the audio will not be output.
- If you have questions regarding the capabilities and settings of your TV or AV receiver, please contact their manufacturer(s).
- When "Voice Guide" is set to on:
 - The "Voice Guide" setting will be turned off when the "HDMI audio" or "Digital audio" setting is set to "Bitstream" or "Re-encode".
 - Turning off the "HDMI audio" or "Digital audio" setting will not affect the "Voice Guide" setting.

continued on next page

Method 3

■ Connecting the unit through a soundbar or AV receiver

With this connection method, the video is output from the TV, and the sound is output from the soundbar or AV receiver.

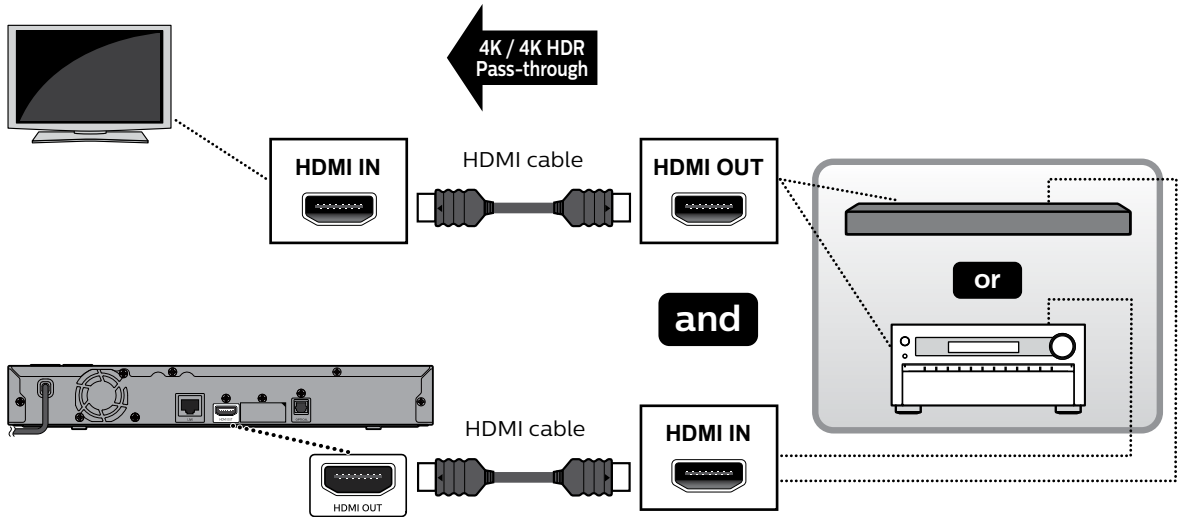

ⓘ Note

- For 4K, 4K HDR or Dolby Vision playback, please your TV supports 4K, 4K HDR or Dolby Vision input.
- Use an 18 Gbps high-speed HDMI cable which supports 4K, 4K HDR or Dolby Vision when you connect to TV.
- If you have questions regarding the capabilities and settings of your TV or AV receiver, please contact their manufacturer(s).
- When "Voice Guide" is set to on:
 - The "Voice Guide" setting will be turned off when the "HDMI audio" or "Digital audio" setting is set to "Bitstream" or "Re-encode".
 - Turning off the "HDMI audio" or "Digital audio" setting will not affect the "Voice Guide" setting.

Method 4

■ Connection to a TV and a non-4K compatible soundbar or AV receiver

Connect as follows if your AV receiver or soundbar is not 4K-compatible.

With this connection method, the video is output from the TV, and the sound is output from the AV receiver or soundbar.

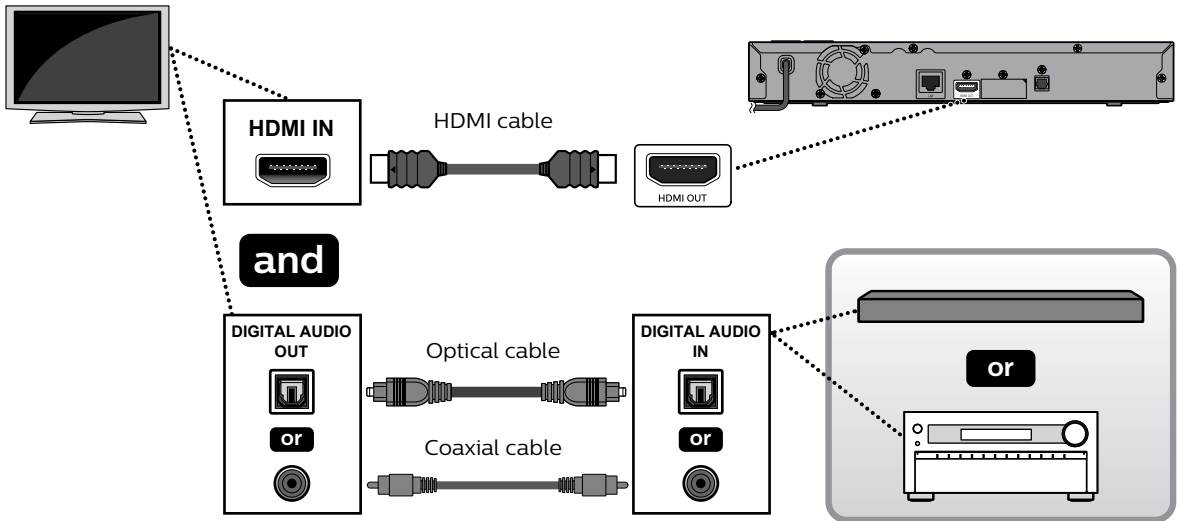

ⓘ Note

- For 4K, 4K HDR or Dolby Vision playback, please your TV supports 4K, 4K HDR or Dolby Vision input.
- Use an 18 Gbps high-speed HDMI cable which supports 4K, 4K HDR or Dolby Vision when you connect to TV.
- If you have questions regarding the capabilities and settings of your TV or AV receiver, please contact their manufacturer(s).
- When “Voice Guide” is set to on:
 - The “Voice Guide” setting will be turned off when the “HDMI audio” or “Digital audio” setting is set to “Bitstream” or “Re-encode”.
 - Turning off the “HDMI audio” or “Digital audio” setting will not affect the “Voice Guide” setting.

In order to play 4K, 4K HDR or Dolby Vision content, this unit must be connected to a 4K/60p/4:4:4 and Ultra HD Blu-ray™ HDR compliant device.

- For 4K/60p/4:4:4, an 18Gbps high-speed HDMI cable is required.

Required TV specifications	Playback content		Recommended settings				Video signals from the unit		
			HDMI video resolution	HDMI Color space	24p output	High Dynamic Range output	Output resolution	Frame rate / Color space	Color depth
Up to 4K 60p 4:4:4	BD-Video	24p	Auto	YCbCr (4:4:4)	Auto	Auto	4K	24p/4:4:4	12 bit
		24p						24p/4:4:4	12 bit
	60p	60p/4:2:2						12 bit	
	Ultra HD Blu-ray™	24p			Off			60p/4:2:2	12 bit
		24p						60p/4:2:2	12 bit
	60p	60p/4:2:2						12 bit	
Up to 4K 60p 4:2:0	BD-Video	24p	Auto	YCbCr (4:4:4)	Auto	Auto	4K	24p/4:4:4	8 bit
		24p						24p/4:2:2	12 bit
	60p	60p/4:2:0						8 bit	
	Ultra HD Blu-ray™	24p			Off			60p/4:2:0	8 bit
		24p						60p/4:2:0	8 bit
	60p	60p/4:2:0						8 bit	
Up to 4K 24p/30p	BD-Video	24p	Auto	YCbCr (4:4:4)	Auto	Auto	4K	24p/4:4:4	8 bit
		24p						24p/4:4:4	8 bit
	60p	30p/4:4:4						8 bit	
	Ultra HD Blu-ray™	24p			Off			30p/4:4:4	8 bit
		24p						30p/4:4:4	8 bit
	60p	30p/4:4:4						8 bit	

- Ultra HD Blu-ray™ content is created in 4K resolution.
- TVs supporting 4K60p are compatible with HDCP 2.2.
- When playing back 4K Ultra HD Blu-ray™ discs with HDR, if you set Color space to RGB or High Dynamic Range output to SDR, this unit will not output HDR.

ⓘ Note

- If this unit is connected to an HDCP incompatible display device, video will not be displayed properly.
- Use a certified HDMI cable (an HDMI cable with the HDMI logo) for this connection. High-Speed HDMI cable (also known as HDMI category 2 cable) is recommended for better compatibility.
- In order for Ultra HD Blu-ray™ video playback, connect this unit to a 4K, 4K HDR or Dolby Vision compatible display device using an 18 Gbps high-speed HDMI cable.
- In order for Blu-ray 3D™ video playback, connect this unit to a 3D compatible display device using a 3D compatible HDMI cable.
- Do not tilt the HDMI connector when inserting it into the HDMI port, and make sure the shapes of the HDMI port and the HDMI cable's connector match.



4.2. HDMI audio output

Media	Source	HDMI audio			Digital audio		
		Bitstream	LPCM	Re-encode	Bitstream	LPCM	Re-encode
BD	Dolby Digital	Dolby Digital	Multi LPCM	Dolby Digital	Dolby Digital	2ch PCM	Dolby Digital
	Dolby Digital Plus	Dolby Digital Plus	Multi LPCM	Dolby Digital Plus(*1)	Dolby Digital	2ch PCM	Dolby Digital
	Dolby TrueHD	Dolby TrueHD	Multi LPCM	Dolby TrueHD(*1)	Dolby Digital	2ch PCM	Dolby Digital
	DTS	DTS	Multi LPCM	DTS	DTS	2ch PCM	DTS
	DTS-HD High Resolution	DTS-HD High Resolution	Multi LPCM	DTS-HD High Resolution(*3)	DTS	2ch PCM	DTS
	DTS-HD Master Audio	DTS-HD Master Audio	Multi LPCM	DTS-HD Master Audio(*3)	DTS	2ch PCM	DTS
	LPCM	Multi LPCM	Multi LPCM	Multi LPCM(*1)	2ch PCM	2ch PCM	2ch PCM(*1)
DVD	Dolby Digital	Dolby Digital	Multi LPCM	Dolby Digital	Dolby Digital	2ch PCM	Dolby Digital
	DTS	DTS	Multi LPCM	DTS	DTS	2ch PCM	DTS
	MPEG	Multi LPCM	Multi LPCM	Multi LPCM	2ch PCM	2ch PCM	2ch PCM
	PCM	Multi LPCM	Multi LPCM	Multi LPCM	2ch PCM	2ch PCM	2ch PCM
Audio CD	LPCM	2ch PCM	2ch PCM	2ch PCM	2ch PCM	2ch PCM	2ch PCM
DTS-CD	DTS	DTS	Multi LPCM	DTS	DTS	2ch PCM	DTS
AVCHD	Dolby Digital	Dolby Digital	Multi LPCM	Dolby Digital	Dolby Digital	2ch PCM	Dolby Digital
	LPCM	Multi PCM	Multi PCM	Multi PCM	2ch PCM	2ch PCM	2ch PCM
Audio file	MP3/FLAC/WAV/Vorbis/ALAC/AIFF/Monkey's Audio	2ch PCM	2ch PCM	2ch PCM	2ch PCM	2ch PCM	2ch PCM
	AAC	AAC(*4)	2ch PCM	AAC(*4)	AAC(*4)	2ch PCM	AAC(*4)
Netflix	Dolby Digital Plus	Dolby Digital Plus	Multi LPCM	Dolby Digital Plus	Dolby Digital Plus	2ch PCM	Dolby Digital
	HE-AAC	AAC	2ch PCM	AAC	AAC	2ch PCM	AAC
YouTube	HE-AAC	AAC	2ch PCM	AAC	AAC	2ch PCM	AAC

*1) When there is the secondary audio and/or interactive audio, it will be output in Dolby Digital.

*2) Only core substream will be decoded.

*3) When there is the secondary audio and/or interactive audio, it will be output in DTS.

*4) AAC Raw only supports the source with sample rate between 32kHz and 48kHz.

4.3. Connection to the network

By connecting this unit to the Internet, you can update software via the Internet and access BD-Live™ and other Network Services such as Netflix and YouTube™.

- Software Update: For more information, refer to “Software update” on page 57.
- BD-Live™: For more information, refer to “Enjoying BD-Live™ discs using Internet” on page 38.
- Netflix / YouTube™ : For more information, refer to “Information on network services” on page 44.

ⓘ Note

- A wired connection is the preferred method of connecting this unit to the Internet, especially while performing a Software update of this unit via the Internet. It also provides a more stable connection while streaming HD video versus Wireless LAN. Wireless LAN performance could be unstable if there are other devices near this unit which also operate in the same frequency spectrum.

■ Network connection (wired)

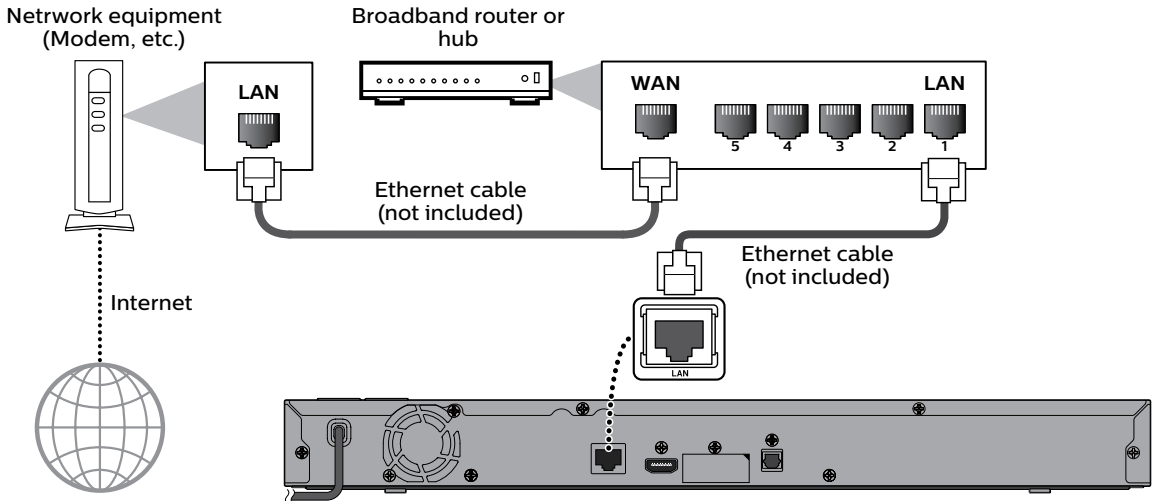

⚠ Caution

- Do not insert any cable other than an ethernet cable to the LAN terminal to avoid damaging the unit.
- Do not connect your PC directly to the LAN terminal of this unit.

ⓘ Note

- When you connect an ethernet cable from a router with internet access to this unit, it will automatically configure network settings. (You do not need to manually configure network settings unless particular settings are required.) However, when switching from wireless to wired, “Wired” in the setup needs to be selected.
- If your modem does not have router functions, connect a wired router.
- If your modem has router functions but there is no vacant port, add a switch / hub.
- Please purchase shielded ethernet cables at your local store and use them when you connect to network equipment.

■ Network connection (wireless)

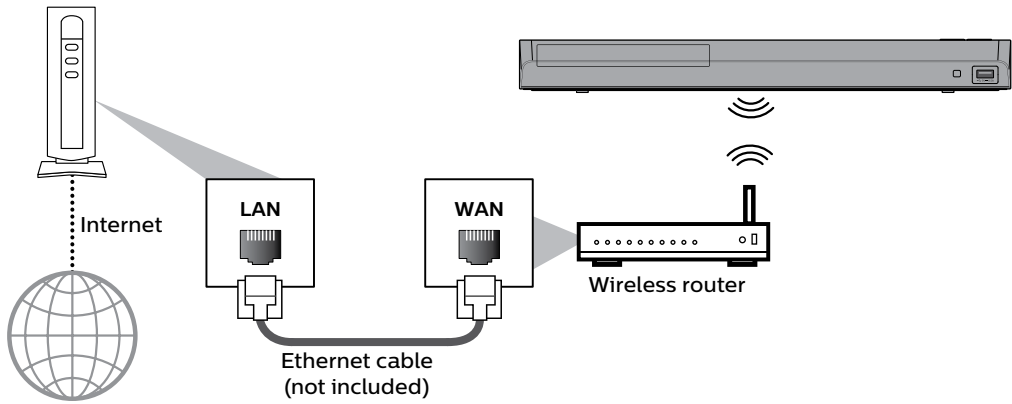

ⓘ Note

- If using the wireless connection, refer to “Network configuration (wireless)” on page 52 to configure network settings.
- For a wireless router, use a router that supports IEEE 802.11 a/b/g/n/ac specifications. (“ac” is preferred type for a faster stable operation of the wireless network.)
- This unit supports infrastructure mode when using a wireless router.
- This unit does not support ad-hoc mode.
- Other radio devices or obstacles may cause interference to the wireless network connection.
- If you are experiencing signal issues with your wireless connection, please confirm that your wireless router is placed close enough to the unit.

5. BEFORE YOU START

5.1. Initial setup

After you have completed all of the connections to your TV, review the steps below.

1. Press [**⏻(POWER)**] to turn on the unit.
2. Turn on your TV.
3. Language setup screen will appear. Use [**▲ / ▼**] to select your language, then press [**OK**].

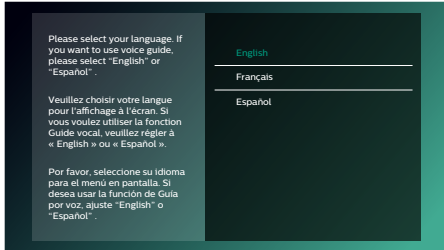

4. Voice guide setup screen will appear. Use [**▲ / ▼**] to select “On” or “Off”, then press [**OK**].
5. Quick start setup screen will appear. Use [**▲ / ▼**] to select “On” or “Off”, then press [**OK**].
6. Auto software update setup screen will appear. Use [**▲ / ▼**] to select “On” or “Off”, then press [**OK**].
7. Network service setup screen will appear. Use [**▲ / ▼**] to select “Set up now” or “Skip”, then press [**OK**].
 - If you select “Set up now”, the “Please select the connection method” screen will appear. See step 8 below.
 - If you select “Skip”, the home menu screen will appear.
8. Select connection method will appear. Use [**▲ / ▼**] to select “Wired” or “Wireless”, then press [**OK**].

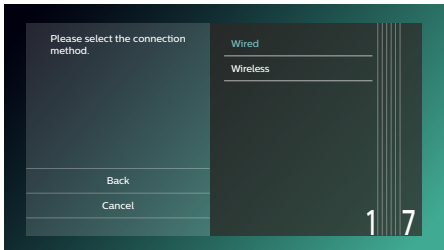

- If you select “Wired”, the network setup screen will appear. See step 9 below.
 - If you select “Wireless”, refer to “Network configuration (wireless)” on page 52 to configure network settings.
9. Network setup screen will appear. Use [**▲ / ▼**] to select “Auto setup” or “Manual setup”, then press [**OK**].

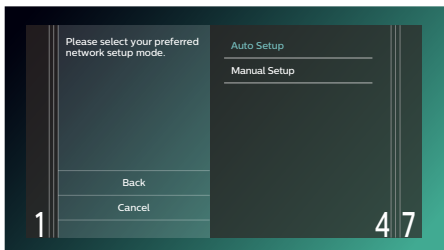

- If you select “Auto setup”, network setting will automatically be performed.
- If you select “Manual setup”, refer to step 7 - 14 in “Manual setup” on page 51.

■ How to reset the OSD language







You can reset the OSD language if you selected the wrong language.

1. Press [**▲**(HOME)] to display the home menu.
2. Use [**▲** / **▼** / **◀** / **▶**] to select “”, then press [OK].
 - This item is “Setup” (English) / “Installation” (French) / “Instalación” (Spanish).
 - From here on, please select one of the following items you can find on screen:
3. Use [**▲** / **▼**] to select “Preferences” (English) / “Préférences” (French) / “Preferencias” (Spanish), then press [OK].
4. Use [**▲** / **▼**] to select “Menu language” (English) / “Langage du menu” (French) / “Menú Idioma” (Spanish), then press [OK].
5. Use [**▲** / **▼**] to select your desired language, then press [OK].
6. If the items that were set are displayed in your desired language, then press [**▲**(HOME)] to exit.

6. INFORMATION ON PLAYBACK

6.1. Information on playback

■ Playable discs and files

Playable discs	Logos
Blu-ray Disc™ - Ultra HD Blu-ray™ - BD-video - Blu-ray 3D™ Disc - Blu-ray 3D™ only Disc - BD-RE* (ver. 2.1) (Recorded in BDMV format) - BD-R* (ver. 1.1 / 1.2 / 1.3) (Recorded in BDMV format) (Unfinalized disc may not be played back.)	
DVD-video	
DVD-RW	
DVD-R	
CD-DA (audio CD)	
CD-RW	
CD-R	
DTS-CD	-

* Due to the intentional progression of the Blu-ray Disc™ format by its standard setting authority, the company cannot guarantee or warrant the playability of future extensions of the Blu-ray Disc™ format with this product.

Playable files	Media
AVCHD	DVD-RW/-R SD memory card using USB card reader
JPEG / PNG / GIF / MP3 / FLAC / AAC / WAV / Vorbis / AIFF / Monkey's Audio / ALAC / H.264 / H.265 / MPEG2 (TS/PS) / VOB / VP9 / VP8	BD-RE/-R DVD-RW/-R CD-RW/-R USB memory stick
Readable device	Playable files / data
USB memory stick	Video files, photo files, music files, Picture-in-Picture commentary, subtitles or other extras for some BD-ROM

ⓘ Note

- This unit may not be able to play back discs recorded on PC's or other recorders.

continued on next page

■ Recommended specifications

Photo file

JPEG (.jpg/.jpeg)

PNG (.png)

GIF (.gif)

Music file

MP3 (.mp3)

Sampling frequency: up to 48kHz
Bit rate: up to 320kbps

FLAC (.flac)

Sampling frequency: up to 192kHz
Bit rate: up to 16.2Mbps

AAC (.m4a)

Sampling frequency: up to 98kHz
Bit rate: up to 320kbps

WAV (.wav)

Sampling frequency: up to 192kHz
Bit rate: up to 36Mbps

Vorbis (.ogg)

Sampling frequency: up to 96kHz

AIFF (.aif)

Sampling frequency: up to 192kHz
Bit rate: up to 36Mbps

Monkey's Audio (.ape)

Sampling frequency: up to 192kHz
Bit rate: up to 1Mbps

Home Network - PCM

Sampling frequency: up to 44.1, 48 kHz

Video file

H.264/H.265

MPEG2 (TS/PS)

VOB

VP9

VP8

AVCHD

AVCHD (.m2ts)

AVCHD (.mts / .m2t)

ⓘ Note for AVCHD

- This unit cannot play back stand-alone AVCHD files written to a DVD or copied to an SD memory card. The DVD or SD memory card containing AVCHD files must have a proper file and folder's structure meeting AVCHD format specifications. Please use AVCHD compliant device / software to burn or copy AVCHD files to DVD or SD memory card. (Please refer to user manuals of your device / software for more information.)

ⓘ Note

- Regardless of the file type, some files may be unplayable due to their incompatible file structure.

Caution / Note for USB memory stick

⚠ Caution

- Do not try to open or modify the USB memory stick.
- Do not touch the terminal surface with your fingers or any metals.

ⓘ Note

- This unit supports USB memory stick with FAT16 / FAT32 file system.
- This unit does not support NTFS file system.
- Please keep the USB memory sticks in their cases when you are not using them.
- Some USB memory sticks may not work with this unit.
- This unit can read SD memory cards using a USB card reader.
 - Readable cards: SD memory card (8 MB - 2 GB) SDHC memory card (4 GB - 32 GB)
miniSD memory card (16 MB - 2 GB) miniSDHC memory card (4 GB - 8 GB)
microSD memory card (256 MB - 2 GB) microSDHC memory card (4 GB - 16 GB)
 - Readable files: AVCHD / JPEG / PNG / GIF / MP3 / FLAC / AAC / WAV /
Vorbis / AIFF / Monkey's Audio
- Depending on a USB card reader, connected card or device may not be recognized.

■ Unplayable media and files

The following discs will not be played back on this unit.

- CD-ROM
- DVD-RAM
- DVD-audio
- HD DVD
- SDXC memory card
- unfinalized disc
- BD-RE (ver. 2.1) (Recorded in BDAV format)
- BDXL™
- Blu-ray Disc™ / DVD / CD / USB memory stick / SD memory card containing DivX® files
- Blu-ray Disc™ / USB memory stick that contains AVCHD files
- Blu-ray Disc™ / DVD hybrid disc (played back as a BD-video only)
- DVD-RW/-R recorded in non compatible recording format
- Super Audio CD - Only the sound on the CD layer can be heard. The sound on the high-density Super Audio CD layer cannot be heard.
- Playability of dual discs is not guaranteed.
- This unit cannot play back the disc contents protected by Windows Media™ Digital Rights Management (DRM).
- CD-I (compact disc-interactive)
- VSD (video single disc)
- video CD
- SVCD
- microSDXC memory card
- BD-RE (ver. 1.0)
- BD-R (ver. 1.1 / 1.2 / 1.3) (Recorded in BDAV format)

■ Region codes

This unit has been designed to play back BD-video with region “A” and DVD-video with region “1” or “ALL”. You cannot play back BD-video or DVD-video that is labeled for other regions.

Look for the symbols on your BD-video or DVD-video. If these region symbols do not appear on your BD-video or DVD-video, you cannot play back the disc on this unit. The letter or number inside the globe refers to region of the world. BD-video or DVD-video discs labeled for a specific region can only be played back on players with the same region code.

BD-video



DVD-video



⊖ Note

- Ultra HD Blu-ray™ discs have no region codes.

■ Hint for disc playback

The contents of a disc are generally divided into sections or folders (group of titles / files) as shown below.

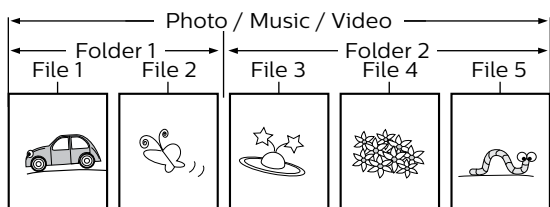
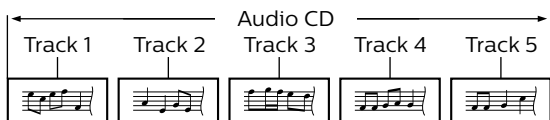
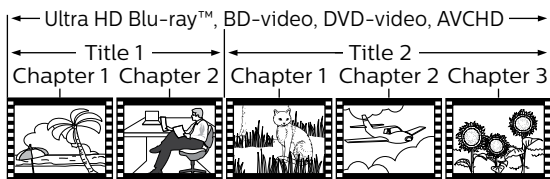

■ Description for icons

[] : group (folder) icon

[] : music file icon

[] : photo file icon

[] : AVCHD / video file icon

- "Folders" refers to the group of files.

- "Track" refers to the contents recorded on the audio CD.

- "Files" refers to the contents on a disc which are recorded in AVCHD or JPEG / PNG / GIF / MP3 / FLAC / AAC / WAV / Vorbis / AIFF / Monkey's Audio file format.

⊖ Note

- Unrecognizable characters will not be displayed.

6.2. Guide to file list

■ Photo file list



1. Folder
2. Photo thumbnail
3. Page(s)
4. Operation guide

■ Music file list

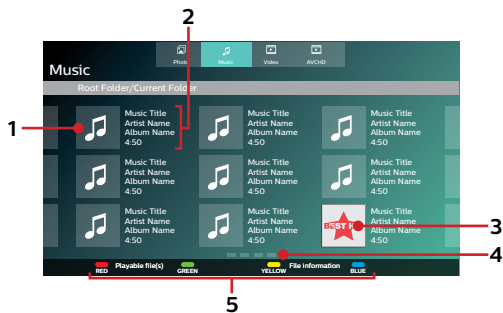

1. Music file
2. Summary information on the file (when available)
3. Cover art (when available)
4. Page(s)
5. Operation guide

■ Video file list

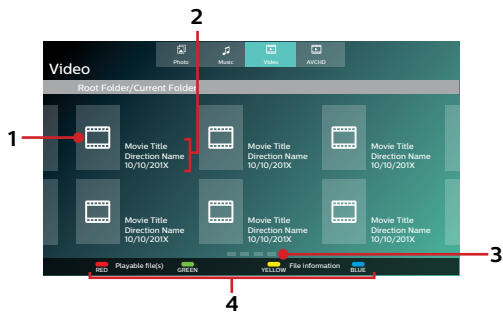

1. Video file
2. Summary information on the file (when available)
3. Page(s)
4. Operation guide

■ DVD-VR title list

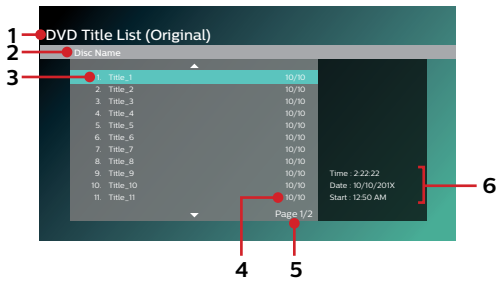

1. DVD title (Original or Playlist)
2. Disc name
3. Title
4. Recording date
5. Page
6. Recording length of the selected title / recording date / recording start time

■ How to navigate through the file list

- Use [**▲** / **▼** / **◀** / **▶**] to move the highlighted item. Press [**BACK**] to move back to the previous directory.
- If the list has multiple pages, you can switch pages using [**⏪** / **⏩**(SKIP)].
- To access files in a folder, select the desired folder, then press [**OK**].
- Press [**🏠**(HOME)] to exit.

6.3. How to insert a disc

1. Press [**▲**(OPEN/CLOSE)] to open the disc tray.
2. Place the disc on the disc tray with its label side facing up.
3. Press [**▲**(OPEN/CLOSE)] to close the disc tray.
 - It may take a while to load the disc.

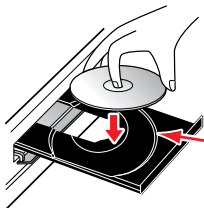

Align the disc to the disc tray guide.

7. BASIC PLAYBACK

7.1. Playing back a disc



1. Insert a disc (refer to “How to insert a disc” on page 28).

- For Blu-ray Disc™ / DVD / AVCHD / audio CD or a disc containing only one type of file, playback will start automatically. If not, press **[▶II(PLAY/PAUSE)]**.
- When photo / music / video files are contained on the disc, the file list will be displayed.
- Some discs may show a title or a disc menu. In this case, refer to “Using the title / disc / pop menu” on page 35.
- “BD-ROM Data (USB) Check” message may be displayed while loading a Blu-ray Disc™. In such cases, connect a USB memory stick first, then insert the disc. Refer to “Enjoying BD-Live™ discs using Internet” on page 38.

(e.g.) File list: Music

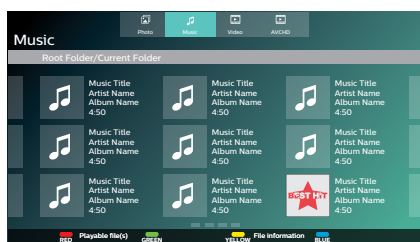

- File list will be displayed.
2. Use **[▲ / ▼ / ◀ / ▶]** to select a media tab (photo / music / video / AVCHD), then press **[OK]**.
 3. Use **[▲ / ▼ / ◀ / ▶]** to select a file to play, then press **[OK]**.

To Skip to the next title / chapter / track / file:

Press **[▶(SKIP)]**.

To Skip to the previous title / chapter / track / file:

Press **[◀(SKIP)]**.

To Pause playback:

Press **[▶II(PLAY/PAUSE)]**.

To Return to normal playback:

Press **[▶II(PLAY/PAUSE)]**.

To stop playback:

Press **[■(STOP)]**.

- Playback will be in resume-on-stop mode.

■ Resume-on-stop mode



While the disc icon is selected on the home screen, pressing [OK] or [▶II(PLAY/PAUSE)] will resume playback. Pressing [OK] while the message "To playback from the beginning, press [OK]." is displayed will start playback from the beginning of the currently selected title.



While the disc icon is selected on the home screen, pressing [OK] or [▶II(PLAY/PAUSE)] will resume playback. Pressing [OK] while the message "To playback from the beginning, press [OK]." is displayed will start playback from the beginning of the first track on the Audio CD.



When you press [▶II(PLAY/PAUSE)] or [OK] next time, the playback will start from the point where it has been stopped.

⊖ Note



- Playback will also stop and the home menu will appear when you press [⬆(HOME)].
- For BD-Java application, the resume-on-stop may not be available.
- For BD / DVD / AVCHD / Audio CD, except for photo / music / video files, resume-on-stop mode remains in effect even after power is turned off. It will be canceled once the disc is ejected.
- Discs containing AVCHD and photo / music / video files will be played back as AVCHD.
- CDs/DVDs containing FLAC (.flac), WAV (.wav), AIFF (.aif), or video files with high frequency and large quantization bit rates may not play properly.
- With regard to the multi-border BD-RE/-R, additionally recorded sections cannot be recognized.
- With regard to the multi-border DVD-RW/-R, additionally recorded sections may not be recognized.

⊖ Note for photo playback

- For photo files except GIF files, every press of [◀ / ▶] will turn the image by 90 degrees when an image is displayed.
- Some unplayable folders or files may be listed due to the recording status.
- High-resolution photo files take longer to be displayed.
- Progressive JPEG files (JPEG files saved in progressive format) cannot be played back on this unit.
- Interlaced GIF files over 7 Mb cannot be played back on this unit.

7.2. 4K, 4K HDR or Dolby Vision playback

In order for 4K, 4K HDR or Dolby Vision playback, make sure the following before you start:

- | | | |
|--|--|--|
| <p>TV</p>  <ul style="list-style-type: none">• Your TV supports 4K, 4K HDR or Dolby Vision input.• Your TV has an HDMI port that accepts 4K, 4K HDR or Dolby Vision signal.• Your TV is enabled to display 4K, 4K HDR or Dolby Vision image. | <p>HDMI Cable</p>  <ul style="list-style-type: none">• An 18 Gbps high-speed HDMI cable that supports 4K, 4K HDR or Dolby Vision is used to connect the TV and the player. | <p>Blu-ray Disc™</p>  <ul style="list-style-type: none">• The Blu-ray™ title to play contains 4K, 4K HDR or Dolby Vision content. |
|--|--|--|

Note

- When connecting this unit to a TV through an AV receiver, make sure that the AV receiver supports 4K, 4K HDR or Dolby Vision pass-through.

How to confirm if the current signal is for 4K, 4K HDR or Dolby Vision

During playback, pressing [INFO] displays the current video input and output signal on the top of the screen.

<p>Playback media information</p> <p>1 2 3 4</p>	<p>Output video signal information</p> <p>2 3 4</p>
---	--



The screenshot shows the INFO menu with the following information:

- Playback media information:**
 - 1. Title: 001 / 010
 - 2. Chapter: 001 / 029
 - 3. Disc: 4K / 24Hz / Dolby Vision
 - 4. (Empty)
- Output video signal information:**
 - 2. Output: 4K / 24Hz / Dolby Vision
 - 3. (Empty)
 - 4. (Empty)

Additional details from the screenshot: A video player interface showing a forest scene, a progress bar at 00:21:34, and a total duration of 02:05:08.

1. Playback media
2. Video resolution
3. Video frame rate
4. Dynamic range information

Note

- If the current video signal is not displayed, perform “Software update” so that it will be displayed. For more information, refer to “Software update” on page 57.
- When you update the software, the following settings will be changed.
 - “HDMI video” is set to “Auto”
 - “High Dynamic Range output” is set to “Dolby Vision” if “Auto” is selected. (The setting will be kept if “SDR” is selected.)
- If you have questions regarding the capabilities and settings of your TV or AV receiver, please contact their manufacturer(s).
- Refer to your TV’s manual if additional settings need to be changed to enable 4K, 4K HDR or Dolby Vision playback.
- Playback is possible when connecting this unit to a 4K, 4K HDR or Dolby Vision-incompatible TV (conventional 2K High-Definition TV of 720p/1080i/1080p resolutions). The picture quality, however, is not 4K, 4K HDR or Dolby Vision best quality.
- 4K output is not possible when “HDMI video” on this unit is set to “480p”, “720p”, “1080i”, or “1080p”.
- 4K HDR output is not possible when “HDMI video” on this unit is set to other than “Auto” or “4K”, or when “High Dynamic Range output” is set to “SDR”.
- For playback media information, “Video resolution” is shown as “-” instead when resolution is under “480p” or “480i”.
“Video frame rate” and “Dynamic range information” are shown as “-” instead when the signal is not detected.

7.3. Playing back an Ultra HD Blu-ray™ disc



This unit can play back Ultra HD Blu-ray™ discs. In order to view Ultra HD Blu-ray™ videos, you need to have the following:

- **4K/60p (Color space 4:4:4) and HDCP 2.2 compatible device.**
- **HDR compatible device**
- **18 Gbps high-speed HDMI cable**
- **Ultra HD Blu-ray™ disc**

1. Connect this unit to a 4K/60p (4:4:4) compatible TV using an 18 Gbps high-speed HDMI cable.

- Refer to “HDMI video /audio connection” on page 14.

2. Insert an Ultra HD Blu-ray™ disc.

- Refer to “How to insert a disc” on page 28.

3. Playback may start automatically. If not, press

[▶II(PLAY/PAUSE)].

- Some discs may show a title or a disc menu. In this case, refer to “Using the title / disc / pop menu” on page 35.

To pause playback:

Press **[▶II(PLAY/PAUSE)].**

To return to normal playback:

Press **[▶II(PLAY/PAUSE)].**

To stop playback:

Press **[■ (stop)].**

Playback will be in resume-on-stop mode, and the background screen will appear.

■ **Resume-on-stop mode**

When you press **[▶II(PLAY/PAUSE)]** next time, the playback will start from the point where it has been stopped.

ⓘ **Note**

- If this unit is connected to a non-HDCP 2.2 compatible device, HDR signals will be dynamically converted and output in 2K resolution. Some discs may not be played correctly.
- If this unit is connected to a non-4K/60p (Color space 4:2:0) compatible device, and a 60p video is played, HDR signals will be dynamically converted and output.
- If this unit is connected to a non-4K/60p compatible device, HDR signals will be dynamically converted.
- If this unit is connected to a non-HDR compatible device, HDR signals will be dynamically converted and output. Some discs may output images in 2K resolution or may not be played correctly.
- When you update the software, you can play at the optimum image quality Dolby Vision corresponding content. Refer to “4K, 4K HDR or Dolby Vision playback” on page 31.

7.4. Playing back a Blu-ray 3D™ disc



This unit can play back Blu-ray 3D™ discs which contain stereoscopic 3D video. In order to view Blu-ray 3D™ videos, you need to have the following:

- **3D capable TV**
- **3D compatible HDMI cable**
- **3D glasses**
- **Blu-ray 3D™ disc or Blu-ray 3D™ only disc**

1. **Connect this unit to a 3D-compatible TV using a 3D-compatible HDMI cable.**
 - Refer to “HDMI video /audio connection” on page 14.
2. **Insert a Blu-ray 3D™ disc or a Blu-ray 3D™ only disc.**
 - Refer to “How to insert a disc” on page 28.
3. **Playback may start automatically. If not, press [▶II(PLAY/PAUSE)].**
 - Some discs may show a title or a disc menu. In this case, refer to “Using the title / disc / pop menu” on page 35.

To pause playback:

Press [▶II(PLAY/PAUSE)].

To return to normal playback:

Press [▶II(PLAY/PAUSE)].

To stop playback:

Press [■ (stop)].

Playback will be in resume-on-stop mode, and the background screen will appear.

■ **Resume-on-stop mode**

When you press [▶II(PLAY/PAUSE)] next time, the playback will start from the point where it has been stopped.

⚠ **Caution**

- Watching 3D videos may cause headache, dizziness or tiredness. To avoid such consequences, do not watch 3D videos for a long period of time.
- Watching 3D videos is not recommended for the following people:
 - People who are susceptible to motion sickness
 - Children from walking age to seven years
 - Pregnant woman

For more information, refer to “IMPORTANT HEALTH AND SAFETY INFORMATION FOR 3D TELEVISIONS” on page 71.

ⓘ **Note**

- For more information, refer to the 3D TV’s manual.
- When “3D Blu-ray disc™ playback” is set to “3D Playback” and your TV is not 3D capable, playback of Blu-ray 3D™ discs will revert to 2D depending on the disc.
- For some Blu-ray 3D™ only discs, playback in 2D mode is not possible.

7.5. Playing back content from a USB memory stick



You can play back photo files (JPEG, PNG, GIF), music files (MP3, FLAC, AAC, WAV, Vorbis, AIFF, Monkey's Audio, ALAC), video files (H.264, H.265, MPEG2 (TS/PS), VOB, VP9, VP8) stored on a USB memory stick. With the USB memory stick, you can also enjoy the following functions:

- Special additional contents for BD-ROM.

(For more information about the special additional contents, refer to the instruction book that came with the disc.)

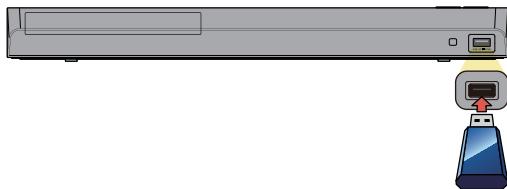

1. Connect a USB memory stick.

- This unit will automatically recognize the content type in the media, and display the file list.

(e.g.) File list: Music

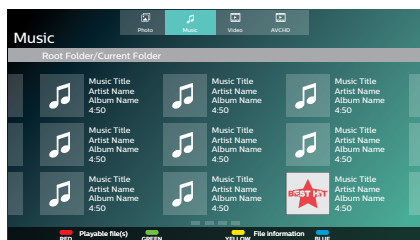

2. Use [**▲** / **▼** / **◀** / **▶**] to select a media tab (photo / music / video / AVCHD), then press [**OK**].

3. Use [**▲** / **▼** / **◀** / **▶**] to select a file to play, then press [**OK**].

⚠ Caution

- Do not disconnect the USB memory stick or switch the unit to standby mode while content on the USB memory stick is being accessed. It may result in malfunction or loss of the stick's data.
- If you connect a USB memory stick or SD memory card via a USB card reader or USB hub, BD-ROM data will be written onto the first connected card or device. Connecting a USB memory stick directly to this unit is recommended.
- Occasionally, SD memory cards / Micro SD memory cards will not be recognized when using certain adapters. In such cases, try a different USB adapter.

📌 Note

- During playback, press [**POP MENU**] or [**STOP**] to go back to the file list.
- The resume information will be cleared when;
 - the USB memory stick is disconnected.
 - the unit is switched to standby mode.
- If a folder / file name contains an unrecognizable character, the character will not be displayed.
- This unit can read photo files (JPEG, PNG, GIF), music files (MP3, FLAC, AAC, WAV, Vorbis, AIFF, Monkey's Audio, ALAC), video files (H.264, H.265, MPEG2 (TS/PS), VOB, VP9, VP8), and AVCHD on an SD memory card by using a USB card reader.

7.6. Using the title / disc / pop menu



Some BD-videos, DVD-videos or AVCHD files may contain a title menu which describes the contents of the disc, or a disc menu which guides you through the available functions on the disc.

- With such discs, a title menu or a disc menu may appear automatically when you insert the disc. Otherwise, press **[TOP MENU]** or **[POP MENU]** to call up the menu. Refer to the disc's manual on how to navigate through the Menu.

Note

- Menus vary among discs. Refer to the information accompanying the disc for details.
- **[TOP MENU]** or **[POP MENU]** may not work with some discs.

8. SPECIAL PLAYBACK

8.1. Fast forward / fast reverse



1. During playback, press [▶▶(FORWARD)] repeatedly for fast forward.
During playback, press [◀◀(REVERSE)] repeatedly for fast reverse.
2. Press [▶II(PLAY/PAUSE)] to return to normal playback.

ⓘ Note

- For Ultra HD Blu-ray™ Disc, Blu-ray Disc™, DVD, DVD-VR, AVCHD, Audio CD, music, video files, speed changes at 5 different levels.
- For Audio CD and music files, fast forward / fast reverse search between different tracks/files are not available.

8.2. Slow forward playback



1. During playback, press [▶II(PLAY/PAUSE)]. Then press [▶▶(FORWARD)].
Every time you press [▶▶(FORWARD)], the playback speed changes at 4 different levels.
2. Press [▶II(PLAY/PAUSE)] to return to normal playback.

ⓘ Note

- Slow reverse is not available.

8.3. Frame by frame playback



1. In pause mode, press [▶I(SKIP)] repeatedly.
Every time you press [▶I(SKIP)], playback will advance one step at a time.
2. Press [▶II(PLAY/PAUSE)] to return to normal playback.

ⓘ Note

- Frame by frame reverse is not available.

8.4. Repeat playback

Available repeat functions vary depending on the disc.

1. During playback, press [OPTIONS] to display the play menu.
2. Use [▲ / ▼] to select “Repeat” then press [OK].
3. Use [▲ / ▼] to select the desired repeat mode.

REPEAT MODE	AVAILABLE MEDIA
Chapter repeat The current chapter will be played back repeatedly.	
Title repeat The current title will be played back repeatedly.	
Track repeat The current track or file will be played back repeatedly.	
All repeat All content in the media will be played back repeatedly.	

4. Press [OPTIONS] to exit.

Note

- The repeat setting will be cancelled when you stop playback.

8.5. Shuffle / random playback

Available shuffle and random functions vary depending on the disc.

1. During playback, press [OPTIONS] to display the play menu.
2. Use [▲ / ▼] to select “Mode”, then press [OK].
3. Use [▲ / ▼] to select the desired playback mode, then press [OK].

SHUFFLE / RANDOM MODE	AVAILABLE MEDIA
Shuffle playback Plays all songs or photo / music files in the current folder one at a time in Random order.	
Random playback Plays all songs or photo / music files in the current folder repeatedly in random order.	

4. Press [OPTIONS] to exit.

8.6. Slide show



1. Follow steps 1 and 2 in “Playing back a disc” on page 29.
2. Open the folder which contains the desired photo files.
3. Use [▲ / ▼] to select a desired file to be played back, then press [▶II(PLAY/PAUSE)] or [OK].
 - An image will be played back from the selected file.
4. Press [■(STOP)] to stop playback.

Note

- Large-size photo files take time to load before being displayed on the screen.

8.7. PiP (BONUSVIEW™) setting



Some BD-videos have the PiP function which enables you to display the secondary video in the primary video.

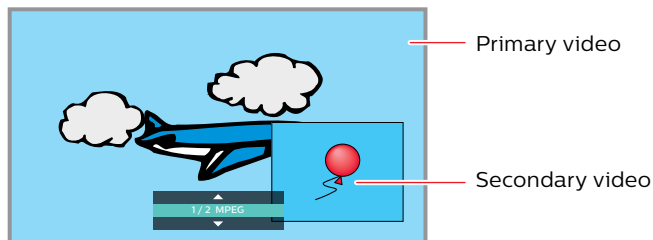

1. During playback, press **[OPTIONS]** to display the play menu.
2. Use **[▲ / ▼]** to select “PiP” then press **[OK]**.
 - PiP information will appear.
3. Use **[▲ / ▼]** to select the secondary video you want to show.
 - The secondary video will be displayed with secondary audio.
4. Press **[OPTIONS]** to exit.
 - To select the secondary audio output, refer to “Switching audio soundtrack” on page 42.

Note

- Secondary video may not be displayed all the time, depending on the scene, it may or may not be available for display.

8.8. Enjoying BD-Live™ discs using Internet



You can enjoy BD-Live™ which enables you to use interactive features when the unit is connected to the Internet.

Examples of BD-Live™ features:

- Online access to additional content such as movie trailers, subtitles, BD-Java applications, etc.
- While downloading, special video data may be played back.
 - Service and functions differ depending on the disc. Follow the instructions given by the disc when using the BD-Live™ function.
 - Connect a USB memory stick with at least 1 GB of available memory before using BD-Live™ features on a Blu-ray Disc™.
 - Do not disconnect the USB memory stick while using BD-Live™ features.

Note

- You must connect the unit to the Internet and set up necessary settings in order to use BD-Live™.
- For the network connection, refer to “Connection to the network” on page 20.
- For the network setup, refer to “Network connection” on page 49.
- For certain discs, “BD-Live access level” under “Network” under “Setup” may need to be changed.
- Depending on your connection environment, it may take a few moments to connect to the Internet or the Internet may not be connected. Refer to “TROUBLESHOOTING” on page 60.
- Some discs with BD-Live™ function require memory when playing back the content. If you cannot play back a disc with BD-Live™ function, connect a USB memory stick (1GB or more of available memory).
- Not all BD-Video discs have a BD-Live™ content. To enjoy the BD-Live™ features, please use discs with a BD-Live™ content.

Note for AACS online

- The player or disc ID may be sent to the content provider when playing back a disc with BD-Live™ function.
- If you save your viewing history on the server by using these ID's, you will be introduced to other similar movies.
- You can save game score histories.

8.9. Title / chapter search



■ Using [◀(SKIP)] / [▶(SKIP)]

1. During playback, press [▶(SKIP)] to skip the current title or chapter and move to the next.

The title or chapter will move forward one at a time.

- If there is no chapter in a title, the current title may be skipped.

To go back to the beginning of the current title or chapter, press [◀(SKIP)].

Press [◀(SKIP)] repeatedly to go to the previous title or chapter. The title or chapter may move backward one at a time.

■ Using “Search”

1. During playback, press [OPTIONS] to display the play menu.
2. Use [▲ / ▼] to select “Search”, then press [OK].
3. Use [▲ / ▼] to select “Title” or “Chapter”, then press [OK].

(e.g.) Blu-ray Disc™



4. Use [▲ / ▼ / ◀ / ▶] to select the title / chapter number, then press [OK].

Playback will start from the beginning of the title / chapter.

⊖ Note

- As for BD-video, how it performs is strongly determined by the disc, and may not perform as described.
- For DVD, title search can be performed on the Home menu by pressing [OPTIONS] while in stop mode or resume-on-stop mode.

8.10. Track / file search



■ Using [◀(SKIP)] / [▶(SKIP)]

1. During playback, press [▶(SKIP)] to skip the current track or file and move to the next.

The track / file will move forward one at a time. To go back to the beginning of the current track / file, press [◀(SKIP)].

Press it repeatedly to go to the previous track / file. The track / file will move backward one at a time.

- For photo files, press [◀(SKIP)] once to go to the previous file.

■ Using “Search”

1. During playback, press [OPTIONS] to display the play menu.
2. Use [▲ / ▼] to select “Search”, then press [OK].
 - For photo files, skip to step 4.
3. Use [▲ / ▼] to select “Track”, then press [OK].
4. Use [▲ / ▼ / ◀ / ▶] to select the track number, then press [OK].

Playback will start from the beginning of the track.

8.11. Time search



1. During playback, press **[OPTIONS]** to display the play menu.
2. Use **[▲ / ▼]** to select “Search”, then press **[OK]**.
3. Use **[▲ / ▼]** to select Time Search, then press **[OK]**.
 - Blu-ray Disc™ / DVD-Video / AVCHD: “Title Time” or “Chapter Time”.
 - Audio CD: “Track Time” or “Disc Time”.(e.g.) Blu-ray Disc™



4. Enter the time count you want to jump to.
 - Use **[▲ / ▼ / ◀ / ▶]** to enter the time count, then press **[OK]**.Playback will start from the desired time entered.

8.12. Number select search



Some BD-videos and DVD-videos or AVCHD files have button menus to jump to each button displayed scene. During playback the scenes which have the button menu, you can enter the button number by using the number select menu.

1. During playback, press **[OPTIONS]** to display the play menu.
2. Use **[▲ / ▼]** to select “Number Select”, then press **[OK]**.
(e.g.) Blu-ray Disc™



- For BD-Java, a single-digit number select menu is displayed.
 - For DVD, a double-digit number select menu is displayed.
 - For BD-videos and AVCHD files, the number select menu is displayed even if there is no button menu in the scene.
3. Use **[▲ / ▼]** to enter the number you want to jump to.
 - To move to the digit you wish to change, press **[◀ / ▶]**.
 4. After all digits are entered, press **[OK]**.
 - Playback of the selected scene will start.

Note

- As for the BD-video, how it performs is strongly determined by the disc, and may not perform as described.

8.13. Switching subtitles



Some video materials may have subtitles in one or more languages. For commercially available discs, the supported languages can be found on the disc case. Follow the steps below to switch the subtitle language during playback.

■ Using [OPTIONS]

1. During playback, press [OPTIONS] to display the play menu.
2. Use [▲ / ▼] to select “Subtitle”, then press [OK].
3. Use [▲ / ▼] to select your desired subtitle, then press [OK].
(e.g.) Blu-ray Disc™



4. Press [OPTIONS] to exit.

■ Subtitle Style

For Blu-ray™ discs, the text style can be changed if subtitle Style is available.

1. During playback, press [OPTIONS] to display the play menu.
2. Use [▲ / ▼] to select “Subtitle Style”, then press [OK].
3. Use [▲ / ▼] to select your desired style, then press [OK].
4. Press [OPTIONS] to exit.

⊖ Note

- Some discs will only allow you to change the subtitles from the disc menu or pop menu. Press [TOP MENU] or [POP MENU] to display the disc menu or pop menu.
- If the disc has no subtitle language or subtitle style, “X” will appear if you press [▲ / ▼].
- During playback of the secondary video, the primary subtitle setting is not available except when there is no subtitle for the secondary video.

8.14. Switching audio soundtrack



When playing back video material recorded with two or more soundtracks (these are often in different audio languages or audio formats), you can switch between them during playback.

■ Using [AUDIO]

1. During playback, press [AUDIO].
 - Pressing [AUDIO] repeatedly switches the audio.
(e.g.) Blu-ray Disc™



- For Blu-ray™ discs, [AUDIO] is only available in primary audio.

■ Using [OPTIONS]

1. During playback, press [OPTIONS] to display the play menu.
2. Use [▲ / ▼] to select “Audio”, then press [OK].
3. Use [▲ / ▼] to select your desired audio, then press [OK].
(e.g.) Blu-ray Disc™



4. Press [OPTIONS] to exit.

■ Secondary Audio

For Blu-ray™ discs, the audio in PiP can be switched. (Refer to “PiP (BONUSVIEW™) setting” on page 38.)

1. During playback, press [OPTIONS] to display the play menu.
2. Use [▲ / ▼] to select “Secondary Audio”, then press [OK].
3. Use [▲ / ▼] to select your desired audio, then press [OK].
4. Press [OPTIONS] to exit.

⊖ Note

- Secondary audio will not be output when secondary video is not displayed or when the HDMI setting for audio output is set to “Bitstream”. (For some Blu-ray™ discs, secondary audio will be output even when secondary video is off.)
- Sound mode cannot be changed during playback of discs not recorded in multiple audio mode.
- Some discs allow changing the audio language setting from disc menu. (Operation varies depending on the discs. Refer to the Manual accompanying the disc.)
- [AUDIO] may not work on some discs with multiple audio streams or channels (e.g. DVDs that allow changing audio setting on the disc menu).
- If the disc has no audio language, “X” will appear if you press [▲ / ▼] or [AUDIO].

8.15. Switching camera angles



Some BD-videos and DVD-videos contain scenes which have been shot simultaneously from various angles. You can change the camera angle when  appears on the TV screen.

1. During playback, press [OPTIONS] to display the play menu.
2. Use [▲ / ▼] to select “Angle”, then press [OK].
3. Use [▲ / ▼] to select your desired angle.
4. Press [OPTIONS] to exit.

Note

- If “Angle icon” setting is set to “Off”,  will not appear on the TV screen.

8.16. Noise reduction



Reduces the noise of the playback picture.

1. Use [▲ / ▼ / ◀ / ▶] to select “Setup” in the home menu, then press [OK].
2. Use [▲ / ▼] to select “Video”, then press [OK].
3. Use [▲ / ▼] to select “Noise reduction”, then press [OK].
4. Use [▲ / ▼] to select your desired setting, then press [OK].
5. Press [ (HOME)] to exit.

8.17. Closed caption



Closed Caption displays subtitles in synchronization with the video.

1. During playback, press [OPTIONS] to display the play menu.
2. Use [▲ / ▼] to select “CC Select”, then press [OK].
3. Use [▲ / ▼] to select your desired stream, then press [OK].
4. Press [OPTIONS] to exit.

Note

- Configure the closed caption display settings (font color, size, style, etc.) in the “Setup” → “Accessibility”. Refer to page 48.

9. NETWORK SERVICES

9.1. Before using network services

Please follow the instructions below before.

1. Connect this unit to the Internet.
 - Refer to “Connection to the network” on page 20.
2. Configure necessary network connection settings.
 - Refer to “Network connection” on page 49.
3. In the home menu, use [**▲** / **▼** / **◀** / **▶**] to select your desired network service, then press [**OK**].
4. Press [**⬆️**(HOME)] to exit.

Note

- Pressing [**Netflix**] / [**YouTube**] allows you to directly access the corresponding network service.
- Terms of Use will be displayed for the first-time use of each network service. Confirm it, then press [**OK**].

9.2. Information on network services

For detailed information on the third-party Internet services, please visit each service provider's website:

Netflix : <http://www.Netflix.com>

YouTube™: <http://www.YouTube.com>

Note

- If you watch 4K, 4K HDR or Dolby Vision contents, set to “Video” → “High Dynamic Range output” → “Auto” or “Dolby Vision”. For more information, refer to “LIST OF SETTINGS” on page 45.
- Not all programs are supported 4K, 4K HDR or Dolby Vision.
- If you have a problem with watching 4K, 4K HDR or Dolby Vision, refer to “TROUBLESHOOTING” on page 63.

9.3. Deactivate the network services

Netflix / YouTube™ can be deactivated in Setup.

1. Press [**⬆️**(HOME)] to access the home menu.
2. Use [**▲** / **▼** / **◀** / **▶**] to select “Setup”, then press [**OK**].
3. Use [**▲** / **▼**] to select “Network”, then press [**OK**].
4. Use [**▲** / **▼**] to select “Deactivation”, then press [**OK**].
 - The corresponding network service will be deactivated.
 - When selecting a network service (either “Netflix” or “YouTube”) at the rightmost and pressing [**OK**],
 - a pop-up screen will be displayed.
 - Select “OK”, then press [**OK**] and press [**OK**] again to clear your ID and password.
 - Please be aware that deactivating the network service on this unit does not withdrawal from membership of Netflix.

Caution

- Some features may require an always-on broadband internet connection, firmware update and/or a minimum bandwidth. Internet services vary by location.

P&F USA Inc. / P&F MEXICANA, S.A.de C.V. do not warrant access to the portal or to any of the services, content, software and advertising.

P&F USA Inc. / P&F MEXICANA, S.A. de C.V. or third party content/service providers may, in their sole discretion, add or remove access to any specific services, content, software and advertising at any time. Although P&F USA Inc. / P&F MEXICANA, S.A. de C.V. will strive to provide a good selection of services, content or software, P&F USA Inc. / P&F MEXICANA, S.A. de C.V. do not warrant continued access to any specific services, and content or software.

10. LIST OF SETTINGS

In “Setup”, you can customize various kinds of settings as you prefer. Refer to the following instructions to navigate through the setup menu.

1. Press [**▲**(HOME)] to access the home menu.
2. Use [**▲** / **▼** / **◀** / **▶**] to select “Setup”, then press [**OK**].
3. Use [**▲** / **▼**] to select the desired category, then press [**OK**].
4. Use [**▲** / **▼**] to move up and down the list to select menus / options.
5. To make a selection or to access options of an item, select the desired item, then press [**OK**].
 - To go back to the previous screen, press [**BACK**].
6. Press [**▲**(HOME)] to exit.

Refer to the following table for the types of settings you can customize. The item highlighted in gray is the default setting.

Category	Menus / Options			
Video	3D output	Auto(**)		
		2D		
	TV display	4:3 Normal		
		4:3 Crop		
		16:9 Widescreen		
		16:9 Squeeze		
	HDMI video	Auto	1080i	
		480p	1080p	
		720p	4K	
	24p output	Auto		
		Off		
	Color space	YCbCr(4:4:4)		
		YCbCr(4:2:2)		
		RGB		
High Dynamic Range output	Auto			
	SDR			
	Dolby Vision*			
Noise reduction	Off			
	Low			
	Medium			
	High			
Audio	Night mode	Auto		
		On		
		Off		
	HDMI audio	Bitstream		
		LPCM		
		Re-encode		
		Off		
	Digital audio	Bitstream		
		LPCM		
		Re-encode		
		Off		
	PCM downsampling	48K		
		96K		
192K				

*)“Dolby Vision” can be selected after performing “Software update”.
For more information, refer to “Software update” on page 57.

Category	Menus / Options		
Network	Network installation	Start	
		Connection Test	
	View network settings		
	View Wireless settings		
	BD-Live access level	Allow	
		Limited Allow	
		Prohibit	
	Digital Rights Mgmt		
	Terms of Use		
	Netflix ESN		
	Unit Name		
	Wake-on-LAN	On	
		Off	
Deactivation	Netflix		
	YouTube		
Preferences	Menu language	Auto(XXX)	
		English	
		Français	
		Español	
	Audio	Bulgarian	Italian
		Chinese	Japanese
		Czech	Korean
		Danish	Norwegian
		Dutch	Polish
		English	Portuguese
		Finnish	Romanian
		French	Russian
		German	Slovak
		Greek	Spanish
		Hungarian	Swedish
		Icelandic	Turkish
		Irish	More
		Subtitle	Off
	Bulgarian		Japanese
	Chinese		Korean
	Czech		Norwegian
	Danish		Polish
	Dutch		Portuguese
	English		Romanian
	Finnish		Russian
	French		Slovak
	German		Spanish
	Greek		Swedish
	Hungarian		Turkish
	Icelandic		More
Irish			

Category	Menus / Options		
Preferences	Disc menu	Bulgarian	Italian
		Chinese	Japanese
		Czech	Korean
		Danish	Norwegian
		Dutch	Polish
		English	Portuguese
		Finnish	Romanian
		French	Russian
		German	Slovak
		Greek	Spanish
		Hungarian	Swedish
		Icelandic	Turkish
		Irish	More
		Parental controls	Off
	8 [Adult]		3 [PG]
	7 [NC-17]		2 [G]
	6 [R]		1 [Kid Safe]
	5 [PGR]		
	Change password		
	Screen saver	On	
		Off	
	Angle icon	On	
		Off	
EasyLink	On		
	Off		
One Touch Play	On		
	Off		
One Touch Standby	On		
	Off		
Advanced	Software update	Disc	
		Network	
		USB	
	Automatically check for latest software	On	
		Off	
	Quick Start mode	On	
		Off	
	Version info		
	Restore default settings	Reset AV settings	
		Erase unit BD-ROM data	
		Erase USB BD-ROM data	
		Reset network settings	
	Reset All settings		
OSS			
Accessibility	Voice Guide	On	
		Off	
	Voice Guide volume	Loud	
		Medium	
		Soft	
	Voice Guide speed	Fast	
		Normal	
		Slow	
	Voice Guide pitch	High	
		Medium	
		Low	
	Voice Guide verbosity	Detailed	
		Basic	

continued on next page

Category	Menus / Options		
Accessibility	CC style	Auto	
		Custom	
	CC font color	Default	Blue
		White	Yellow
		Black	Magenta
		Red	Cyan
		Green	
	CC font size	Default	
		Standard	
		Small	
		Large	
	CC font style	Default	
		Monospaced with serifs	
		Proportionally spaced with serifs	
		Monospaced without serifs	
		Proportionally spaced without serifs	
		Casual	
		Cursive	
	CC font opacity	Solid	
		Translucent	
		Transparent	
	CC font outline	Default	Uniform
		None	Left drop shadowed
		Raised	Right drop shadowed
		Depressed	
	CC font outline color	White	Blue
		Black	Yellow
		Red	Magenta
		Green	Cyan
	CC background color	Default	Blue
		White	Yellow
		Black	Magenta
Red		Cyan	
Green			
CC background opacity	Solid		
	Translucent		
	Transparent		
CC window color	Default	Blue	
	White	Yellow	
	Black	Magenta	
	Red	Cyan	
	Green		
CC window opacity	Solid		
	Translucent		
	Transparent		

Note

- In order to enable the voice guide function, the OSD language needs to be set to English or Spanish. Voice guide is not available in French.
- There may be grayed-out (unselectable) items while the unit is in resume-on-stop mode.

Unselectable items:

Video settings: TV display (when aspect ratio of the content cannot be changed)

Accessibility: All CC settings

Audio settings: All settings

Preferences: Audio/Subtitle/Disc menu/Parental controls/Change password

Advanced settings: Restore default setting

In order to configure these settings, exit resume-on-stop mode by pressing [**■ (STOP)**] when the home menu screen is displayed.

11. SETUPS

11.1. Network connection

🏠(HOME) → “Setup” → “Network” → “Network installation”

Perform the network connection setup in order to use network features, such as BD-Live™, Netflix, YouTube™, and the network update function.

■ Connection test

After you enable a network connection or change network settings, always perform the connection test to check to see if the connection is correctly made.

1. Use [▲ / ▼ / ◀ / ▶] to select “Setup” in the home menu, then press [OK].
2. Use [▲ / ▼] to select “Network”, then press [OK].
3. Use [▲ / ▼] to select “Network installation”, then press [OK].
4. Use [▲ / ▼] to select “Connection Test”, then press [OK].
 - Connection test will automatically start. The test result will appear right after the test finishes.
5. After the test results display, press [OK].

ⓘ Note

- If the connection test passes, you are ready to use BD-Live™, Netflix, YouTube™, and the Network update function, using the Internet without making any additional settings.
- If the connection test fails, you may need to check your router settings and make sure the physical connection is secure. If you need the MAC address of this unit to complete your router settings, you can view it in “View network setting”.
- When connecting this unit directly to a modem for the first time or connecting it to a modem which was previously connected to any other network device (e.g. a router, PC, etc.), you may have to power cycle the modem (unplug the modem’s and/or router’s AC power cord from its AC outlet for 30 seconds and then plug it back in), this may reset the settings in the modem. If you have a telephone/internet modem with your cable service then you may have to use its reset button or remove the backup battery to reset this type of modem.
- If the connection test fails, this unit is not connected to the Internet. In this case, you cannot use the network features, such as BD-Live™, Netflix, YouTube™, and the network update function. Please confirm router settings or contact your ISP (Internet Service Provider) for troubleshooting assistance.

■ Network configuration (wired)

Auto setup

In order to make a wired connection, connect an ethernet cable from a router with Internet access. A network will automatically be established.

- In order to confirm that this unit is connected to the Internet, perform “Connection test” (refer to page 49).
- In order to switch from wireless connection to wired, perform the following steps:

1. Connect an ethernet cable from a router with internet access.
2. Use [▲ / ▼ / ◀ / ▶] to select “Setup” in the home menu, then press [OK].
3. Use [▲ / ▼] to select “Network”, then press [OK].
4. Use [▲ / ▼] to select “Network installation”, then press [OK].
5. Use [▲ / ▼] to select “Start”, then press [OK].
6. Use [▲ / ▼] to select “Wired”, then press [OK].
7. Use [▲ / ▼] to select “Auto setup”, then press [OK].
 - Network setting will automatically be performed.
8. The following screen will be displayed. Select “Finish”, then press [OK] to complete the settings.

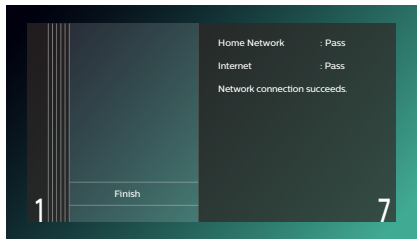

Manual setup

In the following cases, configure each setting as necessary.

- When connection test failed with auto setting.
 - When instructed by your Internet service provider to make specific settings in accordance with your network environment.
1. Use [▲ / ▼ / ◀ / ▶] to select “Setup” in the home menu, then press [OK].
 2. Use [▲ / ▼] to select “Network”, then press [OK].
 3. Use [▲ / ▼] to select “Network installation”, then press [OK].
 4. Use [▲ / ▼] to select “Start”, then press [OK].
 5. Use [▲ / ▼] to select “Wired”, then press [OK].
 6. Use [▲ / ▼] to select “Manual setup”, then press [OK].
 7. Use [▲ / ▼] to select the desired setting (IP Address / Subnet Mask / Default Gateway / Primary DNS / Secondary DNS), then press [OK].
 - The range of input numbers is between 0 and 255.
 - Use [◀ / ▶] to move between input fields. Use [▲ / ▼] changes the number by 1. If you want to exit this setting, press [BACK].
 8. When all items are entered, use [▲ / ▼ / ◀ / ▶] to select “Continue”, then press [OK].
 9. Use [▲ / ▼] to select “Yes” or “No” for proxy server, then press [OK].
 - If you use a proxy server, select “Yes” then press [OK] to go to the next step.
 - If you do not use a proxy server, select “No” then press [OK] to go to step 13.
 10. “Proxy Address” setting screen will appear. Enter a proxy address using the cursor buttons, the color keys, and [OK].
 11. Press [RED] to go to the “Proxy Port” setting screen.
 - If you Use [▲ / ▼ / ◀ / ▶] to select “Done” then press [OK] instead of [RED], you can go to the “Proxy Port” setting screen.
 12. Use [▲ / ▼ / ◀ / ▶] to change the proxy port number, then press [OK].
 13. Connection test confirmation screen will appear. Select “Yes”, then press [OK] to start the connection test. The test result will appear right after the connection test finishes.
 14. The following screen will be displayed. Select “Finish”, then press [OK] to complete the settings.

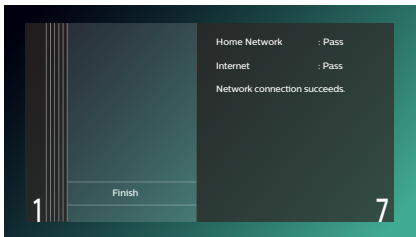

Note

- Enter an IP address after checking the specifications of your router.
- If an IP address is unknown, check the IP address of other devices (e.g. PC connected with a LAN cable). Then, in the fourth cell to the right, assign a different number from those other devices.
- Enter the DNS addresses provided by your Internet service provider.
- If the DNS address is unknown, check the DNS address of other devices (e.g. PC connected via LAN cable) and assign the same DNS address.
- The range of input numbers for the port number is between 0 and 65535. (This number must be no greater than 65535.)
- For proxy port, certain ports might be closed, blocked or unusable depending on your network environment.
- When the settings are changed, the network connection may be disabled depending on the device.

■ Network configuration (wireless)

If you connect this unit to a wireless network, select “Wireless” and configure necessary settings. Please make a note of your SSID (Service Set Identifier – wireless network name) and its security key* before proceeding with the setup.

*) “Easy Connect” cannot be used when the security protocol is set to “WEP”.

Easy Connect

PBC (Push Button Configuration)

You can set up a wireless connection quickly.

(“PBC” is only available when your router supports it. For details, please refer to the user manual of your wireless router.)

Please confirm your wireless router has a PBC* (Push Button Configuration) button.

1. Use [▲ / ▼ / ◀ / ▶] to select “Setup” in the home menu, then press [OK].
2. Use [▲ / ▼] to select “Network”, then press [OK].
3. Use [▲ / ▼] to select “Network installation”, then press [OK].
4. Use [▲ / ▼] to select “Start”, then press [OK].
5. Use [▲ / ▼] to select “Wireless”, then press [OK].
6. Use [▲ / ▼] to select “Easy Connect”, then press [OK].
7. Use [▲ / ▼] to select “Push Button Method”, then press [OK].

Then within 2 minutes push the PBC* (Push Button Configuration) button on your wireless router.

*) PBC button may be called differently on your wireless router.

• The unit will automatically start the connection test. The test result will appear right after the test finishes.

8. The following screen will be displayed. Select “Finish”, then press [OK] to complete the settings.

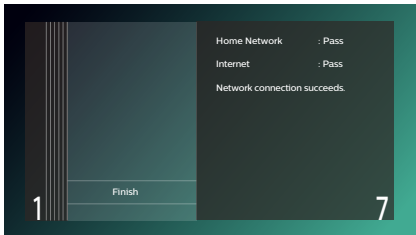

⊖ Note

“Easy Connect” cannot be used when the security mode of your access point is set to “WEP”.

Please try either method below:

- Connect the unit to the access point using “Auto setup” or “Manual setup” mode.
- Change the access point’s security mode from “WEP*” to AES + TKIP.

*) “WEP” is not recommended to be used due to its “Major security flaws”. Change the security protocol on the wireless router to AES + TKIP mode.

(For access point configuration, please consult the user manual of your wireless router or manufacturer.)

Auto scan

1. Follow steps 1 to 5 in “Easy Connect” on page 52.
2. Use [▲ / ▼] to select “Auto Scan”, then press [OK].
 - This unit will automatically start searching for nearby wireless networks.
3. The search result will be displayed. Use [▲ / ▼] to select an appropriate SSID, then press [OK].
 - If you select an SSID with “🔒” in the security column, press [OK] and move on to step 4.
 - If you select an SSID without “🔒” (no security) in the security column, select “Continue” and press [OK], then move on to step 6.
4. The security key (WEP / AES + TKIP Key) entry screen will appear. Enter the security password (WEP / AES + TKIP Key) of the selected wireless network using cursor buttons, [OK], and color keys, then press [RED] to confirm the password.
 - If you do not know the security key (WEP / AES + TKIP Key) for your wireless network, please confirm the sticker on the router.
 - The security key (WEP / AES + TKIP Key) entries are case-sensitive.
 - If you Use [▲ / ▼ / ◀ / ▶] to select “Done” then press [OK] instead of [RED], you can confirm the password.
5. Use [▲ / ▼] to select “Continue”, then press [OK].
6. Use [▲ / ▼] to select “Auto setup” or “Manual setup”, then press [OK].
 - If you select “Auto setup”, follow step 7 in “Auto setup” on page 50.
 - If you select “Manual setup”, follow steps 7 to 14 in “Manual setup” on page 51.

Note

- The internal wireless LAN supports following specifications:
 - Wireless standards: IEEE 802.11 a/b/g/n/ac
 - Frequency: 2.4 GHz + 5GHz
 - Security protocol: WEP* / AES + TKIP
- *) “WEP” is not recommended to be used due to its “Major security flaws”. Change the security protocol on the wireless router to AES + TKIP mode.

Manual entry

Set up the connection to the wireless router manually by entering the SSID.
In the following cases, select “Manual setup” to set each setting as necessary.

- When connection test failed with the setting of “Auto setup”.
1. Follow steps 1 to 5 in “Easy Connect” on page 52.
 2. Use [▲ / ▼] to select “Manual Entry”, then press [OK].
 3. SSID entry screen will appear. Enter the SSID using the cursor buttons, [OK], and the color keys, then press [RED].
 - If you use [▲ / ▼ / ◀ / ▶] to select “Done” then press [OK] instead of [RED], you can confirm the password.
 4. Security mode selection screen will appear. Use [▲ / ▼] to select the desired security mode, then press [OK].
 - If you select “None”, please go to step 6.
 5. The security key (WEP / AES + TKIP Key) entry screen will appear. Enter the security password (WEP / AES + TKIP Key) of the selected wireless network using cursor buttons, [OK], and color keys, then press [RED] to confirm the password.
 - If you do not know the security key (WEP / AES + TKIP Key) for your wireless network, please confirm the sticker on the router.
 - The security key (WEP / AES + TKIP Key) entries are case-sensitive.
 - If you use [▲ / ▼ / ◀ / ▶] to select “Done” then press [OK] instead of [RED], you can confirm the password.
 6. Use [▲ / ▼] to select “Continue”, then press [OK].
 7. Use [▲ / ▼] to select “Auto setup” or “Manual setup”, then press [OK].
 - If you select “Auto setup”, follow step 7 in “Auto setup” on page 50.
 - If you select “Manual setup”, follow steps 3 to 14 in “Manual setup” on page 51.

11.2. EasyLink (HDMI CEC)

🏠(HOME) → “Setup” → “Preferences” → “EasyLink”

EasyLink(HDMI CEC) allows integrated system control over HDMI and is part of the HDMI standard. This function may not work properly depending on the device connected to the unit. When “EasyLink” setting is set to “On” the functions listed below will be available.

■ One touch play

When the buttons below are pressed then operations are performed on this unit, the TV will automatically be turned on and switched to the appropriate video source Input.

Buttons for one touch play:

- [▲(OPEN/CLOSE)], [▶II(PLAY/PAUSE)], [◀(SKIP)], [▶I(SKIP)], [🏠(HOME)] (on the remote control)
- [TOP MENU], [POP MENU] (on the remote control when the a disc is inserted in the unit)

■ One touch standby

This unit will automatically be turned off after the connected HDMI CEC compatible display device is turned off.

■ System information

Get & set menu language

The unit recognizes the OSD language set on the TV and automatically sets the same language as the player menu language (OSD menu language) for this unit. Go to “Menu language” under “Preferences” on page 46 to see available languages.

- Feature is available only when “Auto” is selected in the setup menu “Menu language” section in “Setup” while connected via an HDMI cable.

11.3. HDMI video resolution

🏠(HOME) → “Setup” → “Video” → “HDMI video”

Set the resolution of the video signal being output from the HDMI OUT jack. You can select the desired video resolution among the settings listed below: “Auto”, “480p”, “720p”, “1080i”, “1080p”, “4K”.

Actual output resolution:

Setting in “HDMI video”	Source						
	720 x 480 (30i)	1280 x 720 (60p)	1920 x 1080 (30i)	1920 x 1080 (24p)	1920 x 1080 (60p)	3840 x 2160 (24p)	3840 x 2160 (60p)
Auto	The highest resolution supported by your display device will be in effect automatically.						
480p	720x480 (60p)	720x480 (60p)	720x480 (60p)	720x480 (60p)	720x480 (60p)	720x480 (60p)	720x480 (60p)
1080i	1920x1080 (60i)	1920x1080 (60i)	1920x1080 (60i)	1920x1080 (24p)	1920x1080 (60i)	1920x1080 (24p)	1920x1080 (60i)
1080p	1920x1080 (60p)	1920x1080 (60p)	1920x1080 (60p)	1920x1080 (24p)	1920x1080 (60p)	1920x1080 (24p)	1920x1080 (60p)
4K	3840x2160 (60p)	3840x2160 (60p)	3840x2160 (60p)	3840x2160 (24p)	3840x2160 (60p)	3840x2160 (24p)	3840x2160 (60p)

- The resolution listed in the above chart will be enabled on this unit when the “24p output” is set to “Auto”.

ⓘ Note

- The selected resolution must also be supported by your display device.
- Even if “HDMI video” is set to “4K”, the video of a non-4K compatible Blu-ray Disc™ will be output in the video resolution that is specified by the disc and supported by the display device.
- If your TV and the unit are connected by a DVI cable and if “Auto” is selected, “480p” will be automatically in effect.
- Refer also to your TV’s manual.
- When connected to an HDCP incompatible display device, the picture will not be displayed properly.
- The audio signals from the HDMI OUT jack (including the sampling frequency, the number of channels and bit length) may be limited by the connected device.
- Among the display devices that support HDMI, some do not support audio output (for example, projectors). While connected to a device such as a projector, audio will not be output from the HDMI OUT jack.
- When this unit’s HDMI OUT jack is connected to a DVI-D compatible display device(s) (HDCP compatible) with an HDMI-DVI converter cable, the signals are output in digital RGB.
- HDMI video resolution does not work during BD-Video playback.
- When playing back a Frame Sequential 3D disc, video resolution of output picture will depend on contents on the disc. (“HDMI video” setting is not applicable for Frame Sequential 3D discs.)
- When “HDMI video” is set to “480p”, Sub HDMI will only output in 480p.

Copyright protection system

To play back the digital video images of a BD-video or DVD-video via an HDMI connection, it is necessary that both the player and the display device (or an AV receiver / amplifier) support a copyright protection system called HDCP (high-bandwidth digital content protection system). HDCP is copy protection technology that comprises data encryption and authentication of the connected AV device. This unit supports HDCP. Please read the operating instructions of your display device (or an AV receiver / amplifier) for more information. Note that 4K content viewing requires an HDCP 2.2 compatible TV and cables.

11.4. Parental controls

Some BD-videos or DVD-videos feature parental lock levels. Playback will stop if the ratings of the content exceed the levels you set on the player, it will require you to enter a password before the disc will play back. This feature prevents your children from viewing inappropriate material.

■ Change password

🏠(HOME) → "Setup" → "Preferences" → "Change password"

1. Use [▲ / ▼] to select "Setup" in the home menu, then press [OK].
2. Use [▲ / ▼] to select "Preferences", then press [OK].
3. Use [▲ / ▼] to select "Change password", then press [OK].
4. Enter your 4-digit password.
 - The default value is "0000".
 - Use [▲ / ▼] to enter the first digit of your Password, then press [▶].
 - When 4-digit numbers are entered, press [OK].
5. Set a new password.
 - Use [▲ / ▼] to enter numbers, then use [◀ / ▶] to move the input field. When 4-digit numbers are entered, press [OK].
 - Record your new password, in case you forget it.
6. Re-enter the same new 4-digit password in the same way as step 4.
7. Press [🏠(HOME)] to exit.

To temporarily disable parental lock:

Some discs allow you to temporarily disable parental lock. When you try to play them back, the password entry screen will be displayed.

Follow the instruction which appears on the TV screen to disable parental lock.

■ Rating level

🏠(HOME) → "Setup" → "Preferences" → "Parental controls"

1. Use [▲ / ▼ / ▶ / ◀] to select "Setup" in the home menu, then press [OK].
2. Use [▲ / ▼] to select "Preferences", then press [OK].
3. Use [▲ / ▼] to select "Parental controls", then press [OK].
4. Enter your 4-digit password.
 - Use [▲ / ▼] to enter the first digit of your password, then press [▶].
 - When 4-digit numbers are entered, press [OK].
5. Use [▲ / ▼] to select your desired level, then press [OK].
6. Press [🏠(HOME)] to exit.

	RATING EXPLANATIONS
Off	"Parental controls" is inactive; all discs can be played back.
8 [Adult]	BD / DVD software of any grades (adult / general / children) can be played back.
7 [NC-17]	Content unsuitable for ages 17 and under is blocked.
6 [R]	Restricted; under 18.
5 [PGR]	Parental guidance recommended.
4 [PG-13]	Unsuitable for children under 13.
3 [PG]	Parental guidance suggested.
2 [G]	General audience.
1 [Kid Safe]	Suitable for children.

11.5. Software update

 (HOME) → “Setup” → “Advanced” → “Software update”

This unit lets you update the software yourself using a software update disc or USB memory stick, or via the Internet.

The available discs are below:

- BD-RE/-R
- DVD-RW/-R
- CD-RW/-R

■ Disc / USB memory stick update

You can update the software by using a disc or USB memory stick.

Prepare a blank disc or USB memory stick for software update:

Navigate to www.philips.com/support, and download the latest version software to a blank disc or USB memory stick using a PC by following the directions described on the website.

- Use a blank disc or USB memory stick, download one software per disc or USB memory stick. Write the software in the root directory of the disc or USB memory stick.
- For more details on how to download the software, please refer to the website.

1. Insert the disc or connect the USB memory stick for software update.

- If a disc is inserted, the file list screen will appear. Press  (HOME).
- After connecting a USB memory stick, wait 10–20 seconds, then move on to step 2.

2. Use [/ / /] to select “Setup” in the home menu, then press [OK].

3. Use [/] to select “Advanced”, then press [OK].

4. Use [/] to select “Software update”, then press [OK].

5. Use [/] to select “Disc” or “USB”, then press [OK].

- This unit now starts loading the update file, then Installs it. Update will take a while. Leave the unit until it automatically restarts.

6. After Updating finishes, this unit will restart automatically. Remove the disc or USB memory stick from this unit.

⚠ Caution

- Please do not unplug the AC power cord, eject the disc or disconnect the USB memory stick or press [ (POWER)] to turn the unit to standby mode while performing a “Disc / USB Update”.

ⓘ Note

- Software update will not change any of the current settings.

■ Network update

You can update the software of this unit via the Internet if it is connected to the Internet.

1. Follow steps 2 to 4 in “Disc / USB memory stick update” on this page.

2. Use [/] to select “Network”, then press [OK].

- The unit will connect to the server, then check for the latest software version.

3. Software version confirmation screen will appear. Press [OK].

- Downloading of the latest software will start. (Download may take some time.)
After completing the download, update will start.

4. After updating finishes, this unit will restart automatically.

⚠ Caution

- Please **Do Not Unplug** the AC Power cord, ethernet cable, wireless modem / router, or press [ (POWER)] to turn the unit to standby mode while using “Network Update”.

ⓘ Note

- In order to update the software via the Internet, you must connect the unit to the Internet and Set up necessary Settings.
- For the network connection, refer to “Connection to the network” on page 20.
- For the network setup, refer to “Network connection” on page 49.
- Software update will not change any of the current settings.

11.6. Voice guide

 (HOME) → “Setup” → “Accessibility”

Menus to configure various settings for the voice guide function.

1. Use [**▲** / **▼** / **◀** / **▶**] to select “Setup” in the home menu, then press [**OK**].
2. Use [**▲** / **▼**] to select “Accessibility”, then press [**OK**].
3. Use [**▲** / **▼**] to select the desired setting, then press [**OK**].

“Voice Guide”:

Turns on/off the voice guide function.

“Voice Guide volume”:

Configures the volume of the voice.

“Voice Guide speed”:

Configures the speech rate.

“Voice Guide pitch”:

Configures the voice pitch.

“Voice Guide verbosity”:

Configures whether to read detailed information on the current item/operation.

4. Use [**▲** / **▼**] to select the desired setting, then press [**OK**].
5. Press [**⬆** (HOME)] to exit.

 **Note**

- In order to enable the voice guide function, the OSD language needs to be set to English or Spanish. Voice guide is not available in French.
- When voice guide is set to on, the HDMI audio and digital audio settings are fixed to LPCM.
- Voice Guide is not available with YouTube™.
- While the Voice Guide function is enabled, operations may slow down.
- When this unit is in resume-on-stop mode, the “Voice Guide” setting item is grayed-out and is not configurable. In order to configure “Voice Guide”, remove the disc to exit resume-on-stop mode or press [**■** (STOP)] when the home menu screen is displayed.

11.7. Restore default settings

 (HOME) → “Setup” → “Advanced” → “Restore default settings”

Menus to reset player settings.

1. Use [**▲** / **▼** / **◀** / **▶**] to select “Setup” in the home menu, then press [**OK**].
2. Use [**▲** / **▼**] to select “Advanced”, then press [**OK**].
3. Use [**▲** / **▼**] to select “Restore default settings”, then press [**OK**].
4. Use [**▲** / **▼**] to select the desired setting, then press [**OK**].

“Reset AV settings”:

All the settings except for “Parental controls” and “Network installation” settings will be reset to default.

“Erase unit BD-ROM data”:

Clears the data saved for the BD-ROM contents, such as BD-ROM game scores, on this player.

“Erase USB BD-ROM data” (Only available when a USB memory stick is connected):

Clears supplemental data for BD-ROM playback, such as subtitle data, from the USB memory stick.

“Reset network settings”:

Resets the network installation settings menu to the default.

“Reset All settings”:

Resets this unit to its factory default settings.

5. Use [**◀** / **▶**] to select “OK”, then press [**OK**].
6. Confirmation message will appear. Press [**OK**] to complete the setting.

 **Caution**

- Do not remove the USB memory stick while executing “Erase USB BD-ROM data”. It will damage the USB memory stick.

 **Note**

- “Restore default settings” cannot be performed while a BD-V / DVD-V / AVCHD / Audio CD disc is inserted in this unit, and this unit is in resume-on-stop mode.
- Reset AV settings does not clear the password, the parental settings, or the network installation settings.
- Reset AV settings clears the BD-Live access level and the unit name settings. Also, each net app will be deactivated.
- Reset network settings only clears the network installation settings (connection settings).

12. TROUBLESHOOTING

Problem	Tip
No power.	Check the AC power cord, if it is properly connected.
	Try another power outlet.
	Unplug the AC power cord, and wait for about 5-10 seconds. Plug it back in and attempt to power on the unit.
No sound or picture.	Make sure both the TV and Blu-ray Disc™ player are turned on.
	Confirm the connections to the TV are made properly as shown in the “CONNECTIONS” on page 14.
	Check to see whether the connected TV or another device supports HDCP. (This unit will not output a video signal unless the other device supports HDCP.)
4K, 4K HDR or Dolby Vision signal does not output.	Confirm that the unit is connected to a 4K, 4K HDR or Dolby Vision-compatible TV.
	Confirm that the HDMI cable from the unit is connected to an HDR-compatible HDMI port on the TV.
	Confirm that the 4K, 4K HDR or Dolby Vision settings on the TV are enabled.
	If the unit is connected via a soundbar or AV receiver that device might be blocking the 4K, 4K HDR or Dolby Vision signal. Connect the unit directly to a 4K, 4K HDR or Dolby Vision-compatible TV.
	If Dolby Vision signal is not detected on this unit, it may be solved by software update. Refer to “Software update” on page 57.
No reaction to the remote control.	Reduce the distance to infrared sensor window.
	Confirm that the player’s AC power cord is plugged into a power outlet.
	Check the batteries in the remote control and make sure they are inserted properly by + or - symbols.
	Please check IR signal. Refer to “IR signal check” on page 66.
No Audio / video signal on the display device via HDMI cable.	If the unit is connected to a non-certified HDMI device, the audio / video signal will not output to that device.
	Make sure the display device is on the correct input / video source.
	Perform an HDMI hotplug: Disconnecting the HDMI cable from the display device, turn on both devices, and replug the HDMI cable back in.
	Check with the TV manufacturer, if there are any software updates available for the TV.
	Check to see if the HDMI cable is a certified version.
No high-definition video signal on the TV screen.	Does the disc contain high-definition video? High-definition video is only available when the disc contains it.
	Does the TV support high-definition video? High-definition video is only available when the TV supports it.
Distorted picture.	Sometimes a small amount of picture distortion may appear. This is not a malfunction.
Completely distorted picture or black / white picture with Blu-ray Disc™ / DVD.	Make sure the disc is compatible with this unit.
No sound or distorted sound.	Adjust the volume.
	Check to see if the speakers are connected correctly.
	Check the HDMI connection.
	Make sure the HDMI cable is not plugged into an HDMI-DVI adapter or projector which does not handle digital sound.
	Check the settings in the “Audio” menu.
Cannot mute Voice Guide	Configure the Voice Guide display settings in the “Setup” → “Accessibility” → “Voice Guide” → “Off”. Refer to “Voice guide” on page 58.
Picture freezes momentarily during disc playback.	Check the disc for fingerprints / scratches and clean with a soft cloth wiping from the center to the outer edge.

continued on next page

Problem	Tip
Cannot play back a disc.	Make sure that the disc is playable on this unit.
	Check the region code of the disc. This unit supports the following region codes. – Blu-ray Disc™: “A” – DVD: “ALL” or “1”
	For DVD-RW/-R, make sure that the disc is finalized.
	Clean the disc.
	Is the disc a newer title? This problem may be solved by software update. Refer to “Software update” on page 57.
“BD-ROM Data(USB) Check” message appears when attempting to play a Blu-ray Disc™.	Connect a USB memory stick first, then insert the Blu-ray Disc™. – When this unit starts loading a Blu-ray Disc™, it will check the USB memory stick to which BD-Live™ contents will be saved.
A music/photo file does not play.	Confirm that the file type is supported. Refer to page 25 for the compatible file extensions.
	The file may be corrupted. Check to see if it is playable on a PC or other devices.
No return to start-up screen when disc is removed.	Soft reset this unit by turning it off for 30 seconds, then on again.
 will appear on the TV screen.	The operation is not possible.
The unit does not respond to some operating commands during playback.	The operations may be prohibited by the disc. Refer to the instructions for the disc.
The unit cannot read Blu-ray Disc™ / DVD / CD.	Condensation? (Let the unit sit and dry for 1 or 2 hours)
	Check to see if the disc is compatible with this unit. (Refer to page 24.)
	Wipe dirt off the disc from the center to the outside or replace the disc. Refer to “Cleaning discs” on page 66.
Scene shooting Angle does not switch.	Angles cannot be switched for Blu-ray Disc™ / DVD which do not contain multiple angles. In some cases multiple angles are only recorded for specific scenes.
Playback does not start when a title is selected.	Check the settings in “Parental controls” menu.
Error message appears when I select “Auto” in the “Menu language”.	Make sure that the unit is connected to a TV that is compatible with HDMI CEC and the “EasyLink” is set to “On”.
	This error message may appear when your TV's OSD language is not supported by this unit.
Cannot play back AVCHD file.	This unit cannot play back stand-alone AVCHD files (*.m2ts, *.mts or *.m2t) written to a DVD. The DVD containing AVCHD files must have a proper file and folder structure meeting AVCHD format specifications. Please use AVCHD compliant device / software to burn or copy AVCHD files to DVD. (Please refer to user manuals of the device / software for more information.)
The capacity of the USB memory stick decreased.	Data may be written on the USB memory stick when a BD-video uses the virtual package feature while a USB memory stick is connected to the unit.
Cannot play back a MPEG-2 video and audio from the USB memory stick.	MPEG-2 is not compatible with this unit.
Cannot read the contents on the USB memory stick.	The USB memory stick is not compatible with this unit or the contents may be damaged.
	Try and turn off the unit, then turn it back on.
Cannot play back BD-Video.	Connect a USB memory stick (256MB or more of available memory) which is formatted on this unit. Some discs require memory when playing back content.
	Do not disconnect the USB memory stick during playback.
Cannot load a Blu-ray Disc™ (stuck in “Loading...” mode) and cannot Open the disc tray to eject the disc.	Unplug unit from AC outlet for 20 seconds. Plug unit back in and press the [▲(OPEN/CLOSE)] on the unit to eject the disc.

continued on next page

Problem	Tip
Cannot read a USB memory stick.	The format of the USB memory stick is not compatible with this unit. If the USB memory stick has been formatted on a PC or another device, the file system may be incompatible with this unit. This unit supports the FAT16 / FAT32 file systems.
Cannot play back photo files from a disc.	Make sure that the disc was recorded in the UDF, ISO9660 or JOLIET format.
Cannot find a photo file.	Make sure that the file extension is .jpg (.JPG) / .jpeg (.JPEG) / .png (.PNG) or .gif (.GIF) .
Cannot play back music files from a disc.	Make sure that the disc was recorded in the UDF, ISO9660 or JOLIET format. Confirm that the bitrate and sampling frequency are compatible with this unit. (Refer to page 25)
Cannot find a music file.	Make sure that the file extension is either MP3 / FLAC / AAC / WAV /Vorbis / AIFF / Monkey's Audio for music files.
Music files play choppy.	CDs / DVDs containing FLAC (.flac) / WAV (.wav) files with high frequency and large quantization bit rates may not play properly. In such cases, copy the music files to a Blu-ray Disc™ or USB memory stick, then try playing.
How do I switch to view a currently airing TV program?	Stop playback and press the source button on your TV or TV's remote to switch to a TV channel.
How do I have my Bluetooth-compatible speakers output the audio?	The unit does not support Bluetooth.
No audio signal from surround system of the audio system.	Make sure the audio system is turned on. Check the Input mode on the audio system if it is on the correct channel. Check if the surround system is compatible with either Bitstream or LPCM. If not sure, please check the user manual or contact the surround manufacturer. Once confirmed, check the setting in the "Setup" of this unit. Increase the volume level of the surround system.
Cannot connect to the Internet although the connection test passes.	Make sure that the ethernet cable is properly connected to the modem and router. Confirm that another device, such as a PC, can connect to the Internet.
Cannot connect to the network.	Check to see if the modem and router have power turned on. Make sure that the ethernet cable is properly connected to the modem and router. Confirm if the Internet light is showing activity (light blinking) on the modem and router. Check network settings on the unit. Turn off this unit and the modem and router (if it has a power button), then unplug their AC cords. After 30 seconds, plug them back in and turn the devices back on. If you have a telephone / internet modem with your cable service, then you may have to use its reset button or remove the Backup battery to reset this type of modem. Now wait for the lights to show activity and try reconnecting. Check the cable connection to the router when connecting with an ethernet cable. Confirm "View network settings" in the setup. Turn on the DHCP function on the router. Confirm that the LAN cable is connected properly.

Problem	Tip
Cannot use "Easy Connect" to connect to the access point.	If the access point's security mode is set to "WEP", change the setting to "AES + TKIP", then try "Easy Connect" again. Refer to "🚫 Note" on page 52. (For access point configuration, please consult its user manual or manufacturer.)
	Connect the unit to the access point using "Auto setup" or "Manual setup" mode.
Cannot use the wireless connection.	Once you have activated the wireless connection please wait 30 seconds for the connection to be established after turning on the unit, before trying to access network features such as BD-Live™ and third-party network services.
Cannot connect to the network while my PC is connected to the network.	Check the content of your Internet service contract to see if your Internet Service Provider prevents multiple terminals connecting at the same time.
You are not sure if the unit is connected to the Internet.	Perform the connection test. (refer to page 49)
Cannot use the BD-Live™ function or Internet data does not download properly.	Confirm that this unit is successfully connected to the Internet.
	Confirm the BD-Live access level setting in the setup.
	Connect a USB memory stick before inserting a disc. The USB memory stick must have 1GB or more free space.
	Confirm that the USB memory stick is properly connected to this unit. Make sure that the USB memory stick connected to this unit is not write-protected.
How do I make certain that I am able to watch 4K resolution?	Several conditions must be satisfied to enjoy Netflix and YouTube™ in 4K resolution. <ul style="list-style-type: none"> - You must have a Netflix and YouTube™ account that supports 4K output. - You must make certain that your settings for content streaming allow for Ultra HD resolution. - You must make certain that your internet speed will allow Ultra HD (4K). At least 7GB per hour for 4K. - You actually need to select content that is recorded in 4K. Not all Netflix or YouTube™ videos are recorded in 4K.
Cannot add network services.	On this unit, the network services of Netflix and YouTube™ are only available.
Cannot use Netflix service.	Check to see if the network connection is properly made.
	Visit www.Netflix.com on your PC and become a Netflix member.
The picture quality of Netflix streaming movie is poor.	Check your Internet connection speed.
	Contact your Internet Service Provider. (You may need to improve the broadband speed.)
Netflix streaming movie often stops or starts buffering during playback.	Contact your Internet Service Provider. (You may need to improve the broadband speed.)
Can not use the YouTube™ service.	Check to see if the network connection is properly made.
No sound with YouTube™.	If this unit is connected to an AAC-compliant device, the sound may not be output. In such cases, configure as follows: "Setup" → "Audio" → "HDMI audio" → "LPCM".
The picture quality of the YouTube™ video is poor.	You may experience frequent buffering, distorted pictures or no picture at all depending on your network environment and internet traffic.
	The picture and sound quality differ depending on the Internet Service Provider.

🚫 Note

- Do not attempt to repair the Blu-ray Disc™ player yourself. This may cause severe injury, irreparable damage to your Blu-ray Disc™ player and void your warranty.
- Please have your Blu-ray Disc™ player model and serial number available before contacting us. These numbers are available on the cabinet, as well as on the packaging.

13. SPECIFICATIONS

General

Signal system	NTSC Color
Power requirements	120 V AC, 60 Hz
Power consumption	19 W (standby: 0.4 W)
Dimensions (width x height x depth)	17.0 x 1.9 x 8.2 inches
Weight	1.7 kg. (3.75 lbs)
Operating temperature	41°F (5°C) to 95°F (35°C)
Operating humidity	Less than 80 % (no condensation)

Terminals

USB input

TYPE A

HDMI OUT port

HDMI jack Video: 480p, 720p, 1080i, 1080p, 1080p24, 4K/Audio

HDMI OUT (Audio) port

HDMI jack Audio

LAN terminal 10BASE-T / 100BASE-TX

Wireless LAN (Internal) IEEE 802.11 a/b/g/n/ac

Note

- The specifications and design of this product are subject to change without notice.

14. NETWORK SERVICE DISCLAIMER

Content and services made available through this product are transmitted by third parties by means of networks and transmission facilities over which Company has no control and third party services may be terminated or interrupted at any time, and Company makes no representation or warranty that any content or service will remain available for any period of time. Without limiting the generality of this disclaimer, Company expressly disclaims any responsibility for any interruption or suspension of any content or service made available through this product. Company is not responsible for customer service related to the content and services. Any question or request for service relating to the content or services should be made directly to the respective content and service providers.

THIRD PARTY CONTENT AND SERVICES MADE AVAILABLE THROUGH THIS PRODUCT ARE PROVIDED "AS IS." COMPANY DOES NOT WARRANT CONTENT OR SERVICES SO PROVIDED, FOR ANY PURPOSE WHATSOEVER. COMPANY EXPRESSLY DISCLAIMS ANY WARRANTIES, EXPRESS OR IMPLIED INCLUDING WITHOUT LIMITATION, WARRANTIES OF MERCHANTABILITY OR FITNESS FOR A PARTICULAR PURPOSE, ACCURACY, VALIDITY, TIMELINESS, LEGALITY, SUITABILITY, OR QUALITY OF ANY CONTENT OR SERVICE MADE AVAILABLE THROUGH THIS PRODUCT.

IN NO EVENT SHALL COMPANY BE LIABLE FOR, ANY DAMAGES, WHETHER ARISING IN CONTRACT OR TORT, INCLUDING WITHOUT LIMITATION, ANY DIRECT, INDIRECT, INCIDENTAL, SPECIAL OR CONSEQUENTIAL DAMAGES, LOST PROFITS, ATTORNEY FEES, EXPENSES, OR ANY OTHER DAMAGES ARISING OUT OF, OR IN CONNECTION WITH, ANY CONTENT (OR ANY INFORMATION CONTAINED THEREIN) OR SERVICE PROVIDED TO THE USER OR ANY THIRD PARTY, EVEN IF ADVISED OF THE POSSIBILITY OF SUCH DAMAGES.

All content and services accessible through this product belong to third parties and are protected by copyright, patent, trademark and/or other intellectual property rights. Such content and services are provided solely for the User's personal noncommercial use. User may not use any content or services in a manner that has not been authorized by the content owner or service provider. Without limiting the foregoing, unless expressly authorized by the applicable content owner or service provider, you may not modify, copy, republish, upload, post, transmit, translate, sell, create derivative works, exploit, or distribute in any manner or medium any content or services made available through this product.

P&F USA Inc. / P&F MEXICANA, S.A.de C.V. do not warrant access to the portal or to any of the services, content, software and advertising.

P&F USA Inc. / P&F MEXICANA, S.A. de C.V. or third party content/service providers may, in their sole discretion, add or remove access to any specific services, content, software and advertising at any time. Although P&F USA Inc. / P&F MEXICANA, S.A. de C.V. will strive to provide a good selection of services, content or software, P&F USA Inc. / P&F MEXICANA, S.A. de C.V. do not warrant continued access to any specific services, and content or software.

15. MAINTENANCE

■ Servicing

- Please refer to relevant topics in “TROUBLESHOOTING” on page 60 before returning the product.
- If this unit becomes inoperative, do not try to correct the problem by yourself. There are no user-serviceable parts inside. Eject the disc (if possible), disconnect the USB memory stick (if connected to the unit), place the unit into standby mode, unplug the AC power plug, and please contact: 1-866-202-5960 or visit : www.philips.com/support

■ Cleaning the cabinet

- Wipe the front panel and other exterior surfaces of the unit with a soft cloth.
- Never use a solvent, thinner, benzene or alcohol to clean the unit. Do not spray insecticide liquid near the unit. Such chemicals may discolor the surface or damage the unit.

■ Cleaning discs

- When a disc becomes dirty, clean it with a cleaning cloth. Wipe the disc from the center to outside. Do not wipe in a circular motion.
- Do not use solvents such as benzene, thinner, commercially available cleaners, detergent, abrasive cleaning agents or antistatic spray intended for analog records.

■ Cleaning the disc lens

- If this unit still does not perform properly although you referred to relevant sections and “TROUBLESHOOTING” in this user manual, the laser optical pickup unit may be dirty. Consult your dealer or an authorized service center for inspection and cleaning of the laser optical pickup unit.

■ Disc handling

- Handle the discs so that fingerprints and dust do not adhere to the surfaces of the discs.
- Always store the disc in its protective case when it is not used.
- Note that discs with special shapes (heart-shaped discs, octagonal discs, etc.) cannot be played back on this unit. Do not attempt to play such discs, as they may damage the unit.

■ IR signal check

If the remote control does not work properly, you can test IR signal using a digital camera (including a cellphone with a built-in camera) to see if the remote control sends out the infrared signal.

1. Turn on the digital camera.
 2. Direct a digital camera to the remote control, then press and hold any button on the remote control.
- If infrared light appears on the digital camera display, the remote control is working.



⊖ Note

- Some cameras have an IR filter and will not display the IR signal.

16. TRADEMARK INFORMATION



“Blu-ray Disc™”, “Blu-ray” and “Blu-ray Disc™” logo are trademarks of the Blu-ray Disc Association.



“Ultra HD Blu-ray™” and “Ultra HD Blu-ray™” logo are trademarks of the Blu-ray Disc Association.



“BD-Live™” and “BD-Live™” logo are trademarks of the Blu-ray Disc Association.



“BONUSVIEW™” and “BONUSVIEW™” logo are trademarks of the Blu-ray Disc Association.



ENABLED BY SOFTWARE UPDATE

Manufactured under license from Dolby Laboratories. Dolby, Dolby Audio, Dolby Vision, and the double-D symbol are trademarks of Dolby Laboratories.

Dolby Vision enabled by software update. Please visit www.philips.com and check the product page to see if the latest update enables Dolby Vision on this product.



Java and all Java based trademarks and logos are trademarks or registered trademarks of Oracle and/or its affiliates.



For DTS patents, see <http://patents.dts.com>. Manufactured under license from DTS Licensing Limited. DTS, DTS-HD, the Symbol, & DTS and the Symbol together are registered trademarks, and DTS-HD Master Audio | Essential is a trademark of DTS, Inc. © DTS, Inc. All Rights Reserved.



The terms HDMI and HDMI High-Definition Multimedia Interface, and the HDMI Logo are trademarks or registered trademarks of HDMI Licensing LLC in the United States and other countries.



“x.v.Color” and “x.v.Color” logo are trademarks of Sony Corporation.



 is a trademark of DVD Format/Logo Licensing Corporation.



“AVCHD 3D/Progressive” and the “AVCHD 3D/Progressive” logo are trademarks of Panasonic Corporation and Sony Corporation.



Netflix is available in certain countries. Streaming membership required. More information at www.netflix.com.



YouTube and the YouTube logo are trademarks of Google Inc.

continued on next page

THIS PRODUCT IS LICENSED UNDER THE AVC PATENT PORTFOLIO LICENSE FOR THE PERSONAL AND NON-COMMERCIAL USE OF A CONSUMER TO (i) ENCODE VIDEO IN COMPLIANCE WITH THE AVC STANDARD ("AVC VIDEO") AND/OR (ii) DECODE AVC VIDEO THAT WAS ENCODED BY A CONSUMER ENGAGED IN A PERSONAL AND NON-COMMERCIAL ACTIVITY AND/OR WAS OBTAINED FROM A VIDEO PROVIDER LICENSED TO PROVIDE AVC VIDEO. NO LICENSE IS GRANTED OR SHALL BE IMPLIED FOR ANY OTHER USE. ADDITIONAL INFORMATION MAY BE OBTAINED FROM MPEG LA, L. L. C. SEE [HTTP://WWW.MPEGLA.COM](http://www.mpegla.com)

THIS PRODUCT IS LICENSED UNDER THE VC-1 PATENT PORTFOLIO LICENSE FOR THE PERSONAL AND NON-COMMERCIAL USE OF A CONSUMER TO (i) ENCODE VIDEO IN COMPLIANCE WITH THE VC-1 STANDARD ("VC-1 VIDEO") AND/OR (ii) DECODE VC-1 VIDEO THAT WAS ENCODED BY A CONSUMER ENGAGED IN A PERSONAL AND NON-COMMERCIAL ACTIVITY AND/OR WAS OBTAINED FROM A VIDEO PROVIDER LICENSED TO PROVIDE VC-1 VIDEO. NO LICENSE IS GRANTED OR SHALL BE IMPLIED FOR ANY OTHER USE. ADDITIONAL INFORMATION MAY BE OBTAINED FROM MPEG LA, L.L.C. SEE [HTTP://WWW.MPEGLA.COM](http://www.mpegla.com)

17. GLOSSARY

AACS

Advanced Access Content System (AACS) is the content protection scheme used with Blu-ray™ discs.

Analog audio

An electrical signal that directly represents sound. Compare this to digital audio which can be an electrical signal, but is an indirect representation of sound. See also “Digital audio”.

Aspect ratio

The width of a TV screen relative to its height. Conventional TVs are 4:3 (in other words, the TV screen is almost square); widescreen models are 16:9 (the TV screen is almost twice as wide as its height).

AVCHD

AVCHD is a new format for high definition video camcorders which can record and play high-resolution HD images.

Blu-ray Disc™

Blu-ray Disc™ is a next generation optical video disc which is capable of storing much more data than a conventional DVD. The large capacity makes it possible to benefit from the features such as high-definition videos, multi-channel surround sounds, interactive menus and so on.

Chapter

Just as a book is split up into several chapters, a title on a BD-video or DVD-video is usually divided into chapters. See also “Title”.

Cinavia™

Cinavia Notice

This product uses Cinavia technology to limit the use of unauthorized copies of some commercially-produced film and videos and their soundtracks. When a prohibited use of an unauthorized copy is detected, a message will be displayed and playback or copying will be interrupted.

More information about Cinavia technology is provided at the Cinavia Online Consumer Information Center at <http://www.cinavia.com>

To request additional information about Cinavia by mail, send a postcard with your mailing address to: Cinavia Consumer Information Center, P.O. Box 86851, San Diego, CA, 92138, USA.

This product incorporates proprietary technology under license from Verance Corporation and is protected by U.S. Patent 7,369,677 and other U.S. and worldwide patents issued and pending as well as copyright and trade secret protection for certain aspects of such technology.

Cinavia is a trademark of Verance Corporation. Copyright 2004-2017 Verance Corporation. All rights reserved by Verance. Reverse engineering or disassembly is prohibited.

Digital audio

An indirect representation of sound by numbers. During recording, the sound is measured at discrete intervals (44,100 times a second for CD audio) by an analog-to-digital converter, generating a stream of numbers. On playback, a digital-to-analog converter generates an analog signal based on these numbers. See also “Sampling frequency” and “Analog audio”.

Dolby Digital

The system to compress digital sound developed by Dolby Laboratories. It offers you sound of stereo (2ch) or multi-channel audio.

Dolby Digital Plus

Dolby Digital Plus is the next generation digital audio compression technology developed as an extension to Dolby Digital. Blu-ray Disc™ supports 7.1 multi-channel surround sound output.

Dolby TrueHD

Dolby TrueHD is a lossless coding technology developed for next generation optical discs. Blu-ray Disc™ supports 7.1 multi-channel surround sound output.

DTS® (Digital Theater System)

DTS® is a multi channel surround sound system. You can enjoy movie dynamic and realistic sound like movie theater. DTS surround sound technologies were developed by DTS, Inc.

DTS-HD®

DTS-HD® is a lossless coding technology developed as an extension of the original DTS Coherent Acoustics format. Blu-ray Disc™ supports 7.1 multi-channel surround sound output.

HDMI (High-Definition Multimedia Interface)

A digital interface between an audio and video Source. It can transmit component video, audio, and control signal with one cable connection.

JPEG (Joint Photographic Experts Group)

JPEG is a method of compressing still picture files. You can copy JPEG files on BD-RE/-R, DVD-RW/-R, CD-RW/-R, or USB memory stick from a computer and play back the files on this unit.

Local storage

A storage area of sub contents for playing virtual packages on BD-video.

PCM (Pulse Code Modulation)

The most common system of encoding digital audio, found on CD and DAT. Excellent quality, but requires a lot of data compared to formats such as Dolby Digital and MPEG audio. For compatibility with digital audio recorders (CD, MD and DAT) and AV amplifiers with digital inputs, this unit can convert Dolby Digital, DTS, and MPEG audio to PCM. See also “**Digital audio**”.

Region code

Regions associate discs and players with particular areas of the world. This unit will only play back discs that have compatible region codes. You can find the region code of your unit by looking on the rear panel. Some discs are compatible with more than one region (or all regions).

Sampling frequency

The rate which sound is measured by a specified interval to turn into digital audio data. The numbers of sampling in one second defines as sampling frequency. The higher the rate, the better the sound quality.

Title

A collection of chapters on BD-video or DVD-video. See also “**Chapter**”.

Track

Audio CD uses Tracks to divide up the content of a disc. The BD-video or DVD-video equivalent is called a chapter. See also “**Chapter**”.

x.v.Color

“x.v.Color” is a promotion name given to the products that have the capability to realize a wide color space based on the xvYCC specifications and is a trademark of Sony Corporation.

18. IMPORTANT HEALTH AND SAFETY INFORMATION FOR 3D TELEVISIONS

Read the following information before viewing 3D television images.

CAUTION NOTICE:

1. Ambient fluorescent lighting may cause a flickering effect and direct sunlight may adversely affect the operation of your 3D glasses.
2. DO NOT place your television near open stairwells, balconies or other objects as viewing in 3D images may cause disorientation for some viewers resulting in falls, tripping or walking into objects.
3. If you experience (1) altered vision; (2) lightheadedness; (3) dizziness; (4) involuntary movements such as eye or muscle twitching; (5) confusion; (6) nausea; (7) loss of awareness; (8) convulsions; (9) cramps; and/or (10) disorientation, immediately stop watching 3D images and consult your doctor.
4. Parents should regularly monitor their children concerning the above symptoms as children and teenagers may be more likely to experience these symptoms more frequently than adults. Watching 3D television is not recommended for children under the age of 6 as their visual system is not yet fully developed.
5. Prolonged viewing of 3D images might cause discomfort, dizziness, eye strain, headaches or disorientation.

WARNING NOTICE:

1. Some viewers may experience an epileptic seizure or stroke when exposed to certain flashing images or lights contained in certain television pictures or video games. If you or any of your family has a history of epilepsy or stroke, please consult your doctor before viewing 3D images.
2. DO NOT watch 3D television if you are pregnant, elderly, sleep-deprived, suffering from serious medical conditions, in poor physical condition or under the influence of alcohol.
3. Sitting too close to the screen for an extended period of time may damage your eyesight. The ideal distance should be at least three times the height of the TV screen and at the viewer's eyes level.
4. Wearing the 3D glasses for any reason other than viewing 3D television (as general spectacles, sunglasses, protective goggles, etc.) may physically harm you or weaken your eyesight.
5. If you experience any discomfort while viewing 3D images, stop and do not immediately engage in any potentially hazardous activity such as driving a car until your symptoms have disappeared. If your symptoms persist, do not resume watching 3D images without consulting your doctor.

LIMITED WARRANTY ONE (1) YEAR

WARRANTY COVERAGE:

This warranty obligation is limited to the terms as set forth below.

WHO IS COVERED:

This product warranty is issued to the original purchaser or the person receiving the product as a gift against defects in materials and workmanship as based on the date of original purchase ("Warranty Period") from an Authorized Dealer. The original sales receipt showing the product name and the purchase date from an authorized retailer is considered such proof.

WHAT IS COVERED:

This warranty covers new products if a defect in material or workmanship occurs and a valid claim is received within the Warranty Period. At its option, the company will either (1) repair the product at no charge, using new or refurbished replacement parts, or (2) exchange the product with a product that is new or which has been manufactured from new, or serviceable used parts and is at least functionally equivalent or most comparable to the original product in current inventory, or (3) refund the original purchase price of the product.

Replacement products or parts provided under this warranty are covered against defects in materials and workmanship from the date of the replacement or repair for ninety (90) days or for the remaining portion of the original product's warranty, whichever provides longer coverage for you. When a product or part is exchanged, any replacement item becomes your property and the replaced item becomes company property. When a refund is given, your product becomes company property.

Note: Any product sold and identified as refurbished or renewed carries a ninety (90) day limited warranty.

Replacement product can only be sent if all warranty requirements are met. Failure to follow all requirements can result in delay.

WHAT IS NOT COVERED - EXCLUSIONS AND LIMITATIONS:

This Limited Warranty applies only to new company manufactured products that can be identified by the trademark, trade name, or logo affixed to it. This Limited Warranty does not apply to any hardware product or any software, even if packaged or sold with the product, as manufacturers, suppliers, or publishers may provide a separate warranty for their own products packaged with the bundled product.

The company is not liable for any damage to or loss of any programs, data, or other information stored on any media contained within the product, or other additional product or part not covered by this warranty. Recovery or reinstallation of programs, data or other information is not covered under this Limited Warranty.

This warranty does not apply (a) to damage caused by accident, abuse, misuse, neglect, misapplication, or non-

supplied product, (b) to damage caused by service performed by anyone other than company approved Authorized Service Location, (c) to a product or a part that has been modified without written company permission, or (d) if any serial number has been removed or defaced, or (e) product, accessories or consumables sold "AS IS" without warranty of any kind by including refurbished product sold "AS IS" by some retailers.

This Limited Warranty does not cover:

- Shipping charges to return defective product.
- Labor charges for installation or setup of the product, adjustment of customer controls on the product, and installation or repair of antenna/signal source systems outside of the product.
- Product repair and/or part replacement because of improper installation or maintenance, connections to improper voltage supply, power line surge, lightning damage, retained images or screen markings resulting from viewing fixed stationary content for extended periods, product cosmetic appearance items due to normal wear and tear, unauthorized repair or other cause not within the control of the company.
- Damage or claims for products not being available for use, or for lost data or lost software.
- Damage from mishandled shipments or transit accidents when returning product.
- A product that requires modification or adaptation to enable it to operate in any country other than the country for which it was designed, manufactured, approved and/or authorized, or repair of products damaged by these modifications.
- A product used for commercial or institutional purposes (including but not limited to rental purposes).
- Product lost in shipment and no signature verification receipt can be provided.
- Failure to operate per Owner's Manual.

TO OBTAIN ASSISTANCE...

Contact Customer Care Center at:

1-866-202-5960

REPAIR OR REPLACEMENT AS PROVIDED UNDER THIS WARRANTY IS THE EXCLUSIVE REMEDY FOR THE CONSUMER, WITH THE ISSUING COMPANY NOT LIABLE FOR ANY INCIDENTAL OR CONSEQUENTIAL DAMAGES FOR BREACH OF ANY EXPRESS OR IMPLIED WARRANTY ON THIS PRODUCT. EXCEPT TO THE EXTENT PROHIBITED BY APPLICABLE LAW, ANY IMPLIED WARRANTY OF MERCHANTABILITY OR FITNESS FOR A PARTICULAR PURPOSE ON THIS PRODUCT IS LIMITED IN DURATION TO THE DURATION OF THIS WARRANTY.

Some states do not allow the exclusions or limitation of incidental or consequential damages, or allow limitations on how long an implied warranty lasts, so the above limitations or exclusions may not apply to you.

License

P&F USA, Inc. hereby offers to deliver, upon request, a copy of the complete corresponding source code for the copyrighted open source code packages, on an "AS IS" basis, used in this product for which such offer is requested by the respective licenses. This offer is valid up to three years after the product purchase to anyone in receipt of this information. To obtain source code, please contact P&F USA, Inc. You should write to Funai Service Corporation OSS Request, 1880 Braselton Hwy, Suite 118 #5012 Lawrenceville, GA 30043. P&F USA, Inc. disclaims any and all warranties and representations with respect to such software and related source code including quality, reliability, usability, and accuracy, and further disclaim all express, implied, statutory or otherwise, including without limitation, any implied warranties of title, non-infringement, merchantability, or fitness for a particular purpose. P&F USA, Inc. shall not be liable to make any corrections to the open source software or source code or to provide any support or assistance with respect to it. P&F USA, Inc. disclaims any and all liability arising out of or in connection with the use of this software and/or source code.

This warranty gives you specific legal rights. You may have other rights which vary from state/province to state/province.

Funai Service Corporation Support, 1880 Braselton Hwy, Suite 118 #5012, Lawrenceville, GA 30043



P&F USA, Inc.
1880 Braselton Hwy, Suite 118 #5012 Lawrenceville,
GA 30043

P&F Mexicana, S.A. de C.V.
Av. La Palma No. 6, Col. San Fernando La Herradura.
Huixquilucan, Edo. de México. C.P. 52787

This product has been manufactured by and is sold
under the responsibility of P&F USA, Inc., and P&F
USA, Inc. is the warrantor in relation to this product.

The Philips trademark and the Philips Shield Emblem
are registered trademarks of Koninklijke Philips N.V.
used under license.

EGC22UL
★★★★