

Gebrauchsanweisung

Instructions for use

Mode d'emploi

Gebruiksaanwijzing

Istruzioni per l'uso



Brugsanvisning

Bruksanvisning

Käyttöohje

Manual de utilização

Instrucciones para el uso



Οδηγίες χρήσης

Instrukcje użytkowania

Használati utasítás

Инструкция за употреба



Návod k použití

Návod na použitie

Instrucțiuni de utilizare

Инструкции по эксплуатации

Whirlpool

SENSING THE DIFFERENCE

Precautions and general recommendations	4
Reference guide	6
Options and display description	7
First time use	8
Daily check	9
Daily use	11
How to load the racks	12
Maintenance and care	14
What to do if...	16

Precautions and general recommendations

1. Packing

The packaging materials are 100% recyclable and marked with the recycling symbol .

2. Removing the packaging and inspecting the contents

After unpacking, make sure that the dishwasher is undamaged and that the door closes correctly. If in doubt, contact a qualified technician or your local retailer.

3. Before using the dishwasher for the first time

- The appliance is designed to operate with a minimum ambient temperature of 5°C.
- This dishwasher has been tested by the manufacturer to ensure it functions correctly. Such testing may leave slight drips/water marks which will disappear with the first wash.

4. Energy and water savings

- Do not rinse crockery under running water.
- Always fully load the dishwasher before running it or select the “Half load/Multizone” option (if available).
- If ecological energy sources are available such as solar panel heating, heat pumps or centralised heating systems, the appliance may be connected to the hot water mains up to a maximum temperature of 60°C. Make sure the water inlet hose is of the correct type (“70°C Max” or “90°C Max”).

5. Child safety

- Keep the packaging materials out of the reach of children.
- Children must not be allowed to play with the dishwasher.
- Store the detergent, rinse aid and salt out of the reach of children.

6. Safety warnings

- This appliance can be used by children aged from 8 years and above and persons with reduced physical, sensory or mental capabilities or lack of experience and knowledge if they have been given supervision or instruction concerning use of the appliance in a safe way and understand the hazards involved. Children shall not play with the appliance. Cleaning and user maintenance shall not be made by children without supervision.
- Do not operate the appliance in the open air.
- Do not store flammable materials in close proximity to the appliance.
- The water in the appliance is not potable.
- Do not use solvents inside the appliance: risk of explosion!
- Be careful when the door is open: risk of tripping!
- The open appliance door can only support the weight of the loaded rack when pulled out. Do not rest objects on the open door or sit or stand on it.
- Sharp items that might cause injury (e.g. knives), must be placed in the cutlery basket with the sharp end facing downwards. Long-handled utensils must be arranged horizontally in the upper rack, with the sharp end facing away from the front of the appliance.
- Before cleaning or carrying out maintenance, disconnect the mains plug and turn off the water tap; also disconnect in the event of any malfunction.
- Repairs and technical modifications must be carried out exclusively by a qualified technician.

- The appliance is not intended to be used without decorative plate. Please ensure that appliance after installation always have decorative plate.
- Use special gloves at the assembling of appliance.
- During use, the access to the rear wall should be limited in a sustainable manner such as approaching the device to the wall or furniture board.
- Keep packaging materials out of the reach of children.
- Children must not be allowed to play with the appliance.
- Store the detergent, rinse aid and salt out of the reach of children.

7. Resistance to frost

If the appliance is placed in surroundings exposed to the risk of frost, it must be drained completely. Turn off the water tap, remove the inlet and outlet hoses, and let all the water drain away. Make sure there is at least 1 kg of dissolved regeneration salt in the salt reservoir, to protect the appliance from temperatures of up to -20°C. When the program resumes, an error message may be indicated (see chapter “What to do if...”).

“F6 E1” - the appliance must remain at an ambient temperature of min. 5°C for at least 24 hours.

After eliminating these faults, RESET the appliance (see chapter “What to do if...”).

8. Disposal

- The appliance is manufactured using recyclable materials. If you decide to scrap the dishwasher, it must be disposed of in compliance with local waste disposal regulations. Make it unusable by cutting off the power cord. To prevent situations of potential danger to children (e.g. danger of suffocation), break the lock of the door so that it can no longer be closed.
- This appliance is marked according to the European directive 2012/19/EU on Waste Electrical and Electronic Equipment (WEEE). By ensuring that this appliance is scrapped suitably, you can help prevent potentially damaging consequences for the environment and health. Unsuitable disposal of an appliance of this type as household waste could have detrimental effects on the environment.



The symbol  on the appliance, or on documentation enclosed with the appliance, indicates that this product must not be treated as household waste, but must be delivered to the nearest collection centre for the recycling of electrical and electronic appliances. Disposal must be carried out in accordance with local environmental regulations for waste disposal. For further information on the treatment, recovery and recycling of this appliance, contact your competent local authority, the collection service for household waste or the shop where you purchased the appliance.

EC Declaration of conformity

This appliance has been designed, constructed and distributed in compliance with the safety requirements of EC Directives: 2006/95/EC, 2004/108/EC, 93/68/EEC and 2011/65/EU (RoHS Directive).

The guarantee is not applicable if faults are caused by incorrect use of the appliance.

We reserve the right to make technical modifications.

Dishwasher capacity: 13 place settings

Reference guide

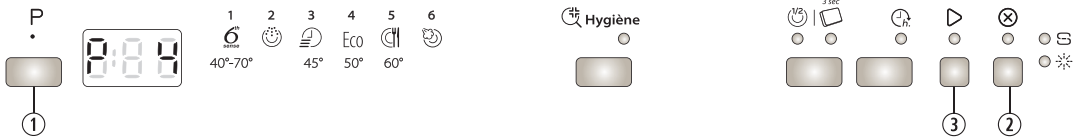

1. PROGRAMS SELECTION BUTTON

Push “P” button (repeatedly) until selected program number is shown on the display (P1...Px) see “Table of programs” below.

2. CANCEL/OFF BUTTON

Push this button to switch off the control panel.

If pressed when a program is running it cancels the program ongoing draining water for 1 minute (0:01 is shown into the display).

If pressed when the dishwasher is switched off, it drains any possible liquids from dishwasher (1 minute process).

3. START/RESUME BUTTON

Push this button to start the selected program: the indicator lights up and goes off at the end of the program.

When the door is opened during a washing cycle, the cycle is temporarily paused: the Start indicator blinks.

To resume the cycle close the door and push Start button again.

Table of programs				Detergent	Consumption			Drying Phase	
Programs	Loading instructions		Available options		Litres	kWh	Minutes ¹⁾		
P1	Sensor	40-70°C	Recommended program for routine washes, with dried-on food.	Delay Hygiene 1/2 Load	X	7-15	1.00-1.70	70-172	Full
P2	Pre-Wash	cold	Crockery to be washed later.	Delay	—	4.0	0.01	14-16	NO
P3	Rapid	45°C	Lightly soiled crockery, with no dried-on food.	Delay	X	11.0	0.85	30-50	NO
P4	Eco	Eco ²⁾ 50°C	Normally soiled crockery. Standard program, the most efficient in terms of its combined energy and water consumption.	Delay Hygiene 1/2 Load	X	10.0	0.922	250	Full
P5	Daily	60°C	Normally to heavily soiled crockery.	Delay Hygiene 1/2 Load	X	11.0	1.30	80-95	Full
P6	Steam		Program including steam action dedicated for heavily soiled crockery, pots and pans. Soaking or hand pretreatment is no longer needed.	Delay Hygiene	X	14.5	1.75	180-190	Full

1) Program data obtained in conformity with European standard EN 50242, obtained under normal conditions (without any options) and may vary depending on conditions. Differences of up to 20 minutes are possible with sensor programs as a result of the appliance’s automatic calibration system.

2) Reference program for energy label in compliance with EN 50242 regulations. - Note for Testing Institutes: for detailed information on the EN/Standard loading comparison test and other tests, contact the following address: “contact@whirlpool.com”.

Power consumption in Left-on mode: 1.50 W / Off-mode: 0.50 W

Options and display description

BEFORE USING THE APPLIANCE FOR THE FIRST TIME CAREFULLY READ THIS QUICK REFERENCE GUIDE AND THE ASSEMBLY INSTRUCTIONS!

THE CONTROL PANEL OF THIS DISHWASHER ACTIVATES PUSHING ANY BUTTON EXCEPT CANCEL/OFF BUTTON.

FOR ENERGY SAVING THE CONTROL PANEL DEACTIVATES AUTOMATICALLY AFTER 30 SECONDS IF NO CYCLE HAS STARTED.

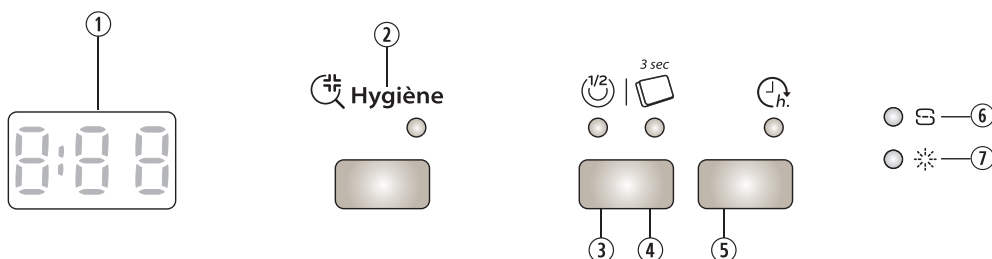

1. WASH TIME DISPLAY

Indicated the cycle duration and the remaining time (h:min). With “Delayed start” selected it indicates the time remaining until program start (h.00) - below 1h (0:min).

If “Fx Ey” messages appears on the display, see chapter “What to do if...”.

2. HYGIENE

This function activates an antibacterial rinse at the end of the wash cycle, guaranteeing a further reduction of bacteria. Press the button to activate or deactivate the function.

This function can be used with the programs indicated in the table of programs. The dishwasher door must be kept shut for the entire duration of the program in order to guarantee reduction of bacteria. If the door is opened the indicator lamp starts flashing.

3. 1/2 LOAD BUTTON

Half load cycle can be used for the upper or lower rack.

Select the required program then press the “Half Load” button - the light comes on.

Turns off at the end of the program.

The “Half Load” option can be used with the programs indicated in the table of programs.

4. TABLET SETTING

This setting allows to optimize the cycle performances according to the type of detergent used. Push the Tablet button for 3 seconds (until the indicator lights up) if you are using the combined detergents in tablet (rinse aid, salt and detergent in 1 dose). If you are using powder detergent or gel detergent, the Tablet indicator on the control panel has to be off.

5. DELAYED START BUTTON

Push the button (repeatedly) to delay the start of the program – delay indicator turns on.

Adjustable from 1 to 24 hours. With each press of the button, the delay increases by one hour and after "h 24" returns to "h 00". When this option is selected the delay indicator turns on. Then press the START button. The dishwasher will start after the set time.

6. SALT INDICATOR

When lit (at the end of the cycle), the salt reservoir needs to be refilled.

7. RINSE AID INDICATOR

When lit (at the end of the cycle), the rinse aid dispenser needs to be refilled.

First time use

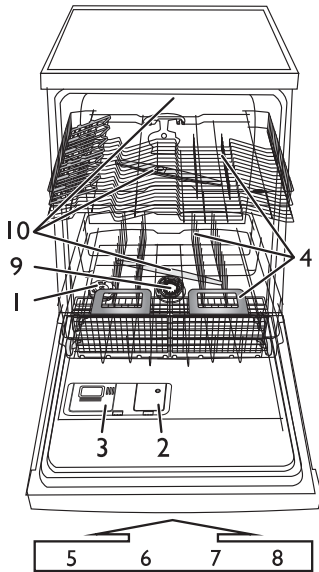

1. salt reservoir
2. rinse aid dispenser
3. detergent dispenser
4. racks system
- 5, 6, 7, 8. available functions on the panel
9. filters
10. spray arms



How to set water hardness in order to always assure the best cleaning results

Water hardness should be set only before the first wash or if water hardness has been changed.

- Press and hold together **Program** and  buttons for minimum 3 seconds.
- The current water hardness setting will be visible on the display.
- Press the **Program** button to increase setting. Value range goes from 1 to 7 (when the level reaches 7, the next press of the start button will set the level back to 1).
- Wait 30 seconds (control panel switches off) or press **Start/Resume** button to save setting.

 Water hardness level is factory set for medium-hard water (level 4).

Detergents

-  When powder or gel detergent is used, regeneration salt must be added and water hardness level must be set as indicated in the table on the right.
-  Also, when tablets which include salt functionality are used, regeneration salt still must be added.

1. Ask your water supply company what the water hardness is...				2. ...enter this value on your dishwasher	SALT required
German degrees °dH	French degrees °fH	English degrees °eH	Water hardness level	Insert value is shown in the display	
0 - 5	0 - 9	0 - 6.3	Soft	1	YES
6 - 10	10 - 18	7 - 12.6	Medium	2	
11 - 15	19 - 27	13.3 - 18.9	Average	3	
16 - 21	28 - 37	19.6 - 25.9	Medium-hard	4	
22 - 28	38 - 50	26.6 - 35	Hard	5	
29 - 35	51 - 63	35.7 - 44.1	Very hard	6	
36 - 50	64 - 90	44.8 - 62.4	Extremely hard	7	

Daily check

Filling the salt reservoir

Dissolve limescale (not necessary if water hardness level is set to “soft 1”!)

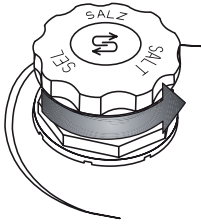

Visual indicator (depending on the model).
Unscrew cap.

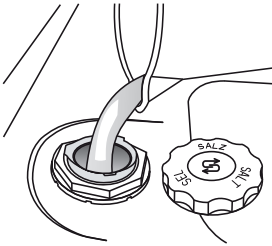

Fill the salt reservoir with water before the first wash only.

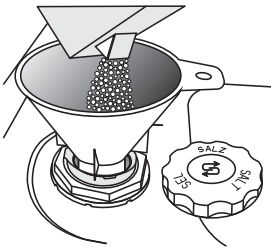

Add salt (never add detergent!) min. 0.8 kg / max. 1kg.

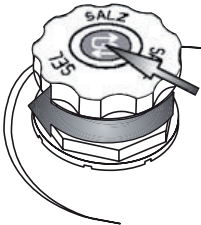

Screw on the cap. Salt residual around the cap need to be removed. Some salt reservoir have a level indicator integrated in the cap (see to the right how to check).

 Once regeneration salt is added, immediately start a wash program (the “Pre-wash” program alone is not sufficient).

Residual saline solution or grains of salt can lead to deep-down corrosion, irreparably damaging the stainless steel components.

The guarantee is not applicable if faults are caused by such circumstances.

 The salt level indicator lamp may remain lit at the end of several wash cycles. If the water hardness is set to level 1 (soft), no salt is required and salt indicator lamp will remain off.

(depending on the model)

Salt indicator on the control panel

 The indicator lamp lights up when SALT NEEDS TO BE ADDED.

Salt indicator on the salt reservoir cap

 green: OK.

 clear: NEEDS TO BE ADDED

Before first use, run the appliance with detergent and without loading.

Adding rinse aid (not necessary when you use tablets). How to adjust the rinse aid dosage regulator

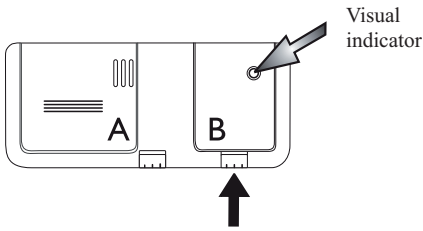

If required, open the cover **B** (press the dedicated button).

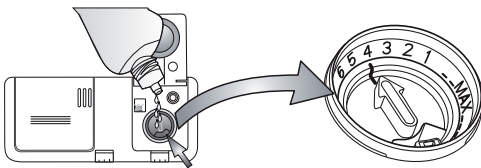

Add rinse aid to the max. line ~150 ml

The rinse aid dosage can be adjusted to the detergent used.

The lower the setting, the less rinse aid is dispensed (factory setting: position 4).

Press the button to open the cover **B**. Using a coin or similar object, turn the arrow to the desired setting. After adjusting the rinse aid setting, shut the cover again.

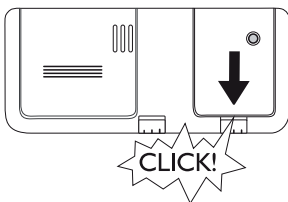

i Check the rinse aid indicator to check the level into the dispenser.

(depending on the model)

Rinse aid indicator on the control panel

 The indicator lamp lights up when RINSE AID NEEDS TO BE ADDED.

Rinse aid indicator on the dispenser

 dark OK.

 clear: NEEDS TO BE ADDED

! Only use rinse aids recommended for use in domestic dishwashers. Immediately wipe away any rinse aid spilt accidentally. This prevents the formation of excess suds which can cause a fault function of the appliance.

i If there are streaks: reduce the dosage by turning the dial to a lower setting (1-3). If crockery is not perfectly dry: increase the dosage by turning the dial to a higher setting (5-6). Plastic dishes have more difficulty drying and a higher rinse aid setting will not improve the situation.

i Detergents with rinse aid incorporated may be effective only with longer programs. In the case of shorter programs, detergent residue may be a problem (if necessary, use powder detergent). Detergents with rinse aid incorporated tend to form excess suds.

Daily use

Adding detergent

Use only detergent specifically for dishwashers in accordance with the supplier's recommendations

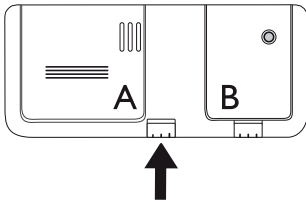

Open the cover A (press the dedicated button).

Only fill the detergent dispenser prior to starting a wash program.

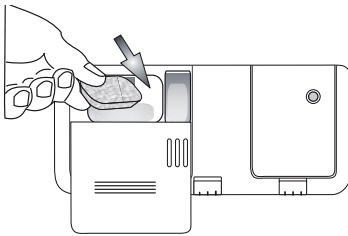

Insert detergent: **Tablet / powder / gel** into the big chamber.

Please look for the recommendation of the detergent manufacturer on the packaging of the detergent product.

Use only one tablet per one cycle, only placed in detergent dispenser.

Some type of tablets could not dissolve completely during the short programs (Rapid, Fragile, Handwash); placing the tablet on the tub bottom can help dissolving and washing.

Shut the cover by pressing dedicated ribs.

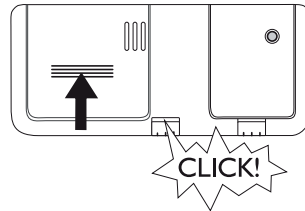

How to load the racks

UPPER RACK - depending on the model

A - Adjustable flaps (2 or 4): in horizontal position for cups/long utensils/stemmed glasses.

Rotate the flap clockwise and hook on rack.

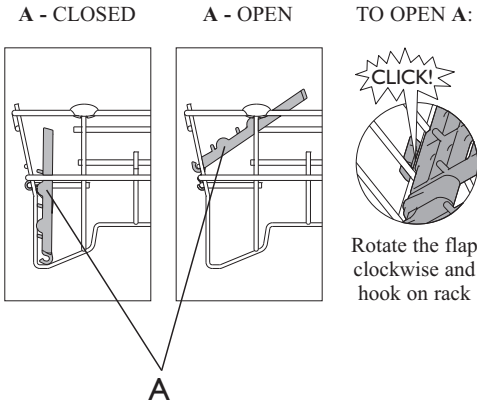

B - Cutlery basket: can be placed in the upper rack when the “Half load/Multizone” option is selected. The **Grid (F)** should be removed.

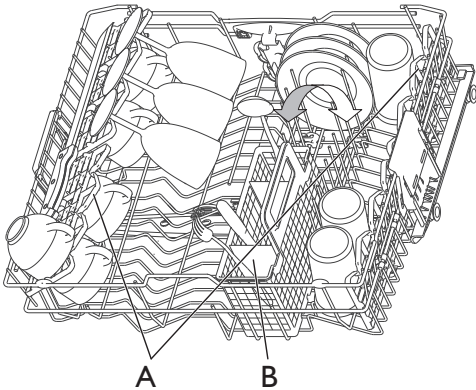

How to adjust upper rack height (if available).

It could be useful to lift up the upper rack to have more space in lower rack or bring it down to load long stem glasses.

- Grasp and take out the two lateral handles (**C**) (they must be on the same level) and lift up or take down the upper rack.

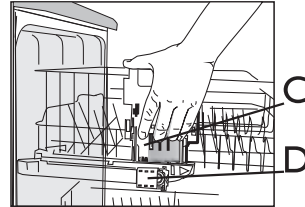

How to remove the upper rack (if available)

It could be useful to remove the upper rack to load bulky items in the lower rack.

- Open the two retainers (**D**) to take off the upper rack (when the upper rack is in place the retainers must always be closed).

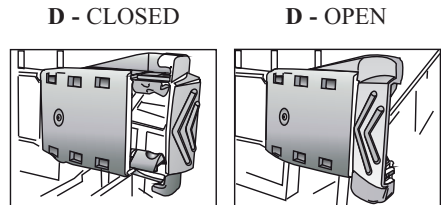

LOWER RACK - depending on the model

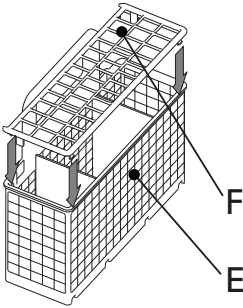

E - Cutlery Basket.

F - Grid: helps to keep the cutlery separate for better washing results.

G - Vertical plate holders: they can be folded down to load pot.

H - Lateral support with foldable flaps (if available): shelves can be used to hold long tools or cups onto.

THE LATERAL SUPPORT CAN BE REMOVED: Pull the support to the front of the basket and lift to remove it.

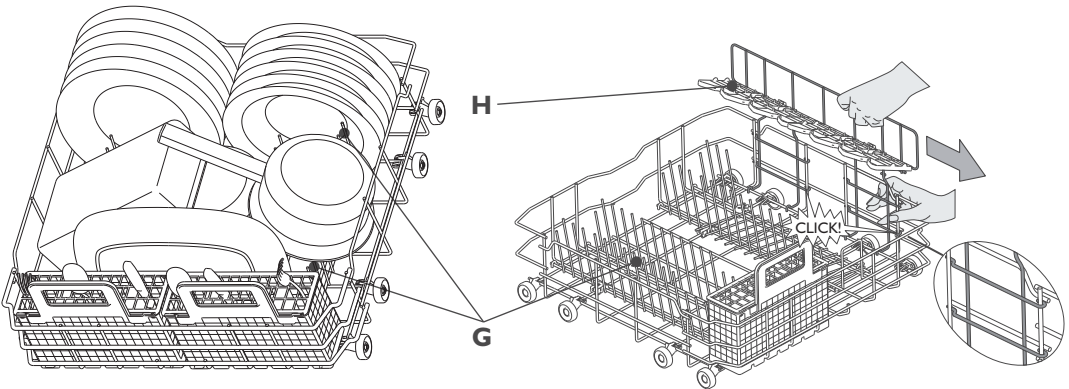

Arrange crockery so that water does not collect in cavities, ensuring that the spray arms turn freely. Only use dishwasher-proof crockery and dishes. Do not use the dishwasher for washing wooden items, aluminium, tin, silver cutlery or decorated crockery (unglazed). In the baskets, dishes (e.g. plates, bowls, pots) must be placed in a correct way to let water flow down!

Switching on the appliance. Press any button (except CANCEL/Off button) to switch on the control panel and start programming.

Select program

Overview of programs

The max. possible number of programs is illustrated in the chapter “Chart”. The corresponding programs for your appliance can be found on the panel



Choose program according to the attached table of programs.

Duration of the program depends on the external conditions in the apartment, temperature and pressure etc.

For hygienic reasons it is recommended to run at least once per month a high-temperature cycle (e.g. Intensive 65). It will help to keep the appliance clean, fully functional and avoid odours.

Wash cycle

The dishwasher door must be closed and the water tap open.

To pause the program (e.g. if you want to insert an item):

- Open the door with caution (the program pauses) and insert the item/s, (**beware of HOT steam!**).
- Close the door and press the **START** button again to restart the cycle (the program resumes the cycle from where it was interrupted).

To Cancel the program on running:

- Press the **CANCEL/Off** button.
- (Water drains for up to 1 minute then the appliance switches off).

To change the program in progress:

- Press the **CANCEL/Off** button to cancel the program on running.
- (Water drains for up to 1 minute then the appliance switches off).
- Press any button except **CANCEL/Off** button to switch on the appliance.
- Select a new program.
- Press the **START** button.

Switching off the appliance. Everything OK...

After the program is completed appliance turns into **Standby** mode automatically. All indicator lamps switch off.

Exercise caution when opening the door: beware of hot steam.

Unload the appliance starting from the lower rack in order to avoid any residual drips of water falling onto crockery below.

Maintenance and care

Filters

Check and clean if necessary

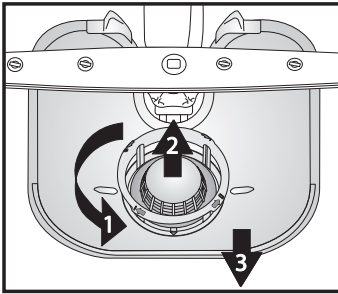

Unscrew microfilter (1), remove it (2) and remove fine sieve (3)...

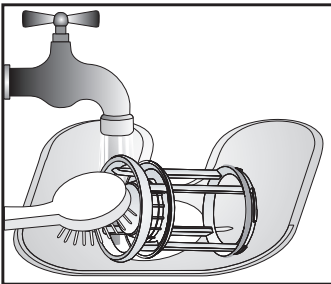

Rinse under running water...

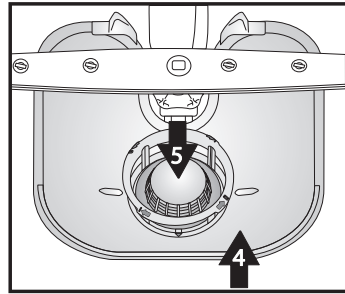

Insert.

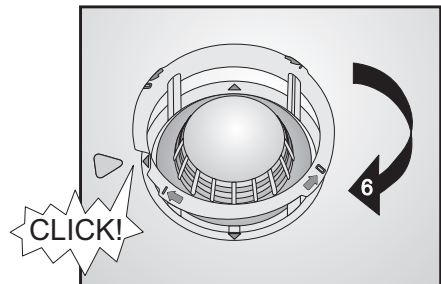

Screw on microfilter NOTE MARK!

Rectifying minor faults yourself...

Spray arms

Remove blockages/deposits.

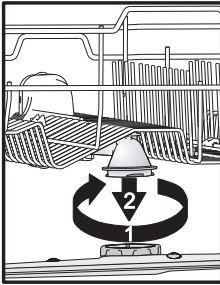

Unscrew and remove upper arm...

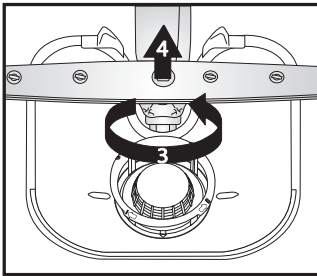

Unscrew and remove lower arm...

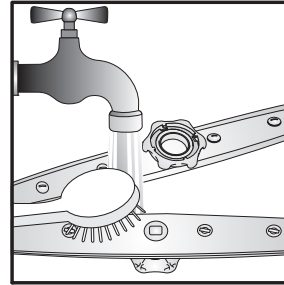

Clean spray nozzles under running water
(use toothpicks if necessary)...

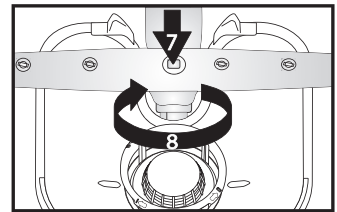
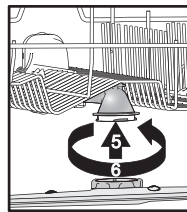

Insert and screw on upper and lower arms tightly.

What to do if...



If a fault occurs, before contacting the After-sales Service, make the following checks to try and remedy the problem. Most faults can be remedied by taking the following courses of action, quickly restoring normal appliance operation.

The appliance...	Possible causes...	Solutions...
salt indicator is lit	<ul style="list-style-type: none"> Salt reservoir is empty. (After refill the salt indicator may remain lit at the end of several wash cycles). 	<ul style="list-style-type: none"> Refill reservoir with salt. Adjust water hardness.
rinse aid indicator is lit	<ul style="list-style-type: none"> Rinse aid dispenser is empty. 	<ul style="list-style-type: none"> Refill dispenser with rinse aid
...is not working/will not start	<ul style="list-style-type: none"> The appliance must be switched on. 	<ul style="list-style-type: none"> Check the household circuit fuse if there is no power supply.
	<ul style="list-style-type: none"> The dishwasher door doesn't close. 	<ul style="list-style-type: none"> Check if the dishwasher's door is closed.
	<ul style="list-style-type: none"> "Delayed start" option is ON. 	<ul style="list-style-type: none"> Check whether the "Delayed start" option (if available) has been selected. If it has, the appliance will only start once the set time has elapsed. If necessary, RESET the appliance by pressing CANCEL or start the cycle immediately by pressing START.
...shows "F6 E7" or "F6 E1" or "H2O"	<ul style="list-style-type: none"> Water tap closed. 	<ul style="list-style-type: none"> The water tap must be open.
	<ul style="list-style-type: none"> Water pressure too low. 	<ul style="list-style-type: none"> The water tap must be fully open during water inlet (minimum capacity: 0.5 litres per minute).
	<ul style="list-style-type: none"> Bent water inlet hose or clogged inlet filters. 	<ul style="list-style-type: none"> The water inlet hose must not be bent and the relative inlet filter in the water tap connector must not be dirty or clogged.
...shows "F6 E3" / "F6 EC" / wash program ended too early (dishes are dirty and wet)	<ul style="list-style-type: none"> Dirty or clogged filters or spray arms. 	<ul style="list-style-type: none"> Clean the filters and spray arms.
	<ul style="list-style-type: none"> Too little water in the dishwasher's water system. 	<ul style="list-style-type: none"> Concave items (e.g. bowls, cups) must be arranged facing downwards in the rack.
	<ul style="list-style-type: none"> Drain hose incorrectly fitted. 	<ul style="list-style-type: none"> The drain hose must be fitted correctly (for high mounted appliances, leave min. 200-400 mm from the lower edge of the appliance) - see Assembly instructions.
	<ul style="list-style-type: none"> High level of foam inside. 	<ul style="list-style-type: none"> Repeat without detergent or wait until foam disappears.
...shows "F8 E1"	<ul style="list-style-type: none"> Dirty filters. 	<ul style="list-style-type: none"> Clean the filters.
	<ul style="list-style-type: none"> Kinked drain hose. 	<ul style="list-style-type: none"> The drain hose must not be kinked.
	<ul style="list-style-type: none"> Syphon hose connection closed. 	<ul style="list-style-type: none"> The closure disk of the syphon hose connection must be removed.
...shows other fault display "Fx Ey" is lit	<ul style="list-style-type: none"> Appliance has technical defect. 	<ul style="list-style-type: none"> Call factory customer service (state fault display). Close the water tap.

After taking the above course of action, the fault message must be reset. In the majority of cases the fault is thus eliminated.

- RESET:**
- Press the **Cancel/Off** button.
 - Close the door.
 - Water drains automatically for up to 1 minute.
 - The appliance is now ready to be restarted.

Crockery and cutlery...	Possible causes...	Solutions...
...are not perfectly clean/have food residues	<ul style="list-style-type: none"> • Too little space between dishes (incorrect arrangement of the concave items in the rack). 	<ul style="list-style-type: none"> • Arrange crockery so that items do not touch each other. Concave items (e.g. bowls, cups) must be arranged facing downwards in the rack.
	<ul style="list-style-type: none"> • Too little detergent; detergent too old or incorrectly stored. 	<ul style="list-style-type: none"> • If necessary, use more detergent, observing the manufacturer's indications as regards dosage. Always store detergent in a dry place and do not store it for excessively long periods of time.
	<ul style="list-style-type: none"> • Temperature not high enough for heavily soiled crockery. 	<ul style="list-style-type: none"> • For heavily soiled crockery, select a wash program with a higher temperature (see table of programs).
	<ul style="list-style-type: none"> • Loading of the dishwasher using lower and upper rack at the same time with "Half load/Multizone" option. 	<ul style="list-style-type: none"> • If you select the "Half load/Multizone" option (if available), remember to load only the upper rack or only the lower rack to increase washing power and thus obtain optimum wash results.
	<ul style="list-style-type: none"> • Clogged spray arms, dirty filters or not fitted correctly. 	<ul style="list-style-type: none"> • The spray arms must not be clogged, the filters must not be dirty and must be fitted correctly (see "Maintenance and care").
	<ul style="list-style-type: none"> • Spray arms stuck impeded by crockery or cutlery. 	<ul style="list-style-type: none"> • The spray arms must be able to turn freely and must not be impeded by crockery or cutlery.
...have deposits: regeneration salt residue	<ul style="list-style-type: none"> • Water too hard. 	<ul style="list-style-type: none"> • In areas with very hard water, more regeneration salt needs to be added (see "How to set water hardness").
	<ul style="list-style-type: none"> • Salt reservoir cap open. 	<ul style="list-style-type: none"> • Close the salt reservoir cap properly.
	<ul style="list-style-type: none"> • Not enough rinse aid. 	<ul style="list-style-type: none"> • If you use a combined action detergent, try adding more rinse aid.
...are not dry	<ul style="list-style-type: none"> • Plastic containers dry badly. 	<ul style="list-style-type: none"> • Synthetic materials do not dry well; if wet at end of cycle, wipe dry.
	<ul style="list-style-type: none"> • Clean dishes left in dishwasher for a long time after end of cycle (e.g. when using "Delayed start" option). 	<ul style="list-style-type: none"> • In this situation, the presence of drops of water on dishes and on the sides of the dishwasher is normal. Try releasing the door 5 minutes before removing the dishes.
	<ul style="list-style-type: none"> • Incorrect arrangement of the concave items in the rack. 	<ul style="list-style-type: none"> • Arrange crockery so that water does not collect in cavities.
	<ul style="list-style-type: none"> • Incorrect dosage the rinse aid. 	<ul style="list-style-type: none"> • Increase the dosage of rinse aid (see "Adding rinse aid").
	<p>Rapid program selected.</p>	<ul style="list-style-type: none"> • The Rapid program 40°C / 45°C is intended for quickly washing lightly soiled dishes. If used for a full load of medium/heavily soiled dishes, the dishes may not dry completely. If so, select a standard-length program. For best results, open the door after the end of the program and wait 15 minutes before unloading the dishwasher.

Crockery and cutlery...	Possible causes...	Solutions...
...have discoloured plastic parts	<ul style="list-style-type: none"> • Tomato/Carrot juice. 	<ul style="list-style-type: none"> • Tomato sauce, for example, can lead to discolouring of plastic parts. Powder detergent is recommended as it allows slightly higher doses to be used for improved whitening. Programs with higher wash temperatures should be used.
...opaque glasses, etc.	<ul style="list-style-type: none"> • Dishes unsuitable for washing in dishwashers (porcelain). 	<ul style="list-style-type: none"> • Only use dishwasher-proof crockery and dishes.
...removable deposits on glasses	<ul style="list-style-type: none"> • Usage of incorrect programs for glasses. 	<ul style="list-style-type: none"> • Dishes should be put together, to avoid touching each other. Do not put glassware together in baskets. Use suitable program for glass.
...glasses not sparkling	<ul style="list-style-type: none"> • Not conform of glasses to washing in dishwashers (porcelain). 	<ul style="list-style-type: none"> • Some kinds of glass cannot be washed in the dishwasher.
...permanent deposits on glasses	<ul style="list-style-type: none"> • Rainbow effect. 	<ul style="list-style-type: none"> • This phenomenon is irreversible. We recommend in future: • Change the control of system of dosage of softener. • Be careful – follow recommended detergent dosage. • For combined action tablets see detergent producer’s recommendations.
...tea cups darken and dirt does not disappear after washing in dishwasher	<ul style="list-style-type: none"> • Theine present in black tea. 	<ul style="list-style-type: none"> • In case of tea stains to enhance bleaching add one teaspoon of baking soda together with detergent into detergent dispenser.
...rust marks	<ul style="list-style-type: none"> • Pre-wash program not used. 	<ul style="list-style-type: none"> • Salty or acidic food residues can cause rust marks even on stainless steel cutlery. To avoid this, always use the pre-wash program if the dishes are to be washed later.
...other marks	<ul style="list-style-type: none"> • Rinse aid dosage too low. 	<ul style="list-style-type: none"> • In the presence of marks, increase the rinse aid dosage (see “Adding rinse aid”). • If you use a combined action detergent, possibly add more rinse aid.
...streaks	<ul style="list-style-type: none"> • Rinse aid dosage too high. 	<ul style="list-style-type: none"> • In the presence of streaks, reduce the rinse aid dosage (see “Adding rinse aid”). • If you use a combined action detergent which includes rinse aid, do not add any additional rinse aid.
...suds	<ul style="list-style-type: none"> • Unsuitable dosage of detergent/rinse aid. 	<ul style="list-style-type: none"> • Only use the amount of detergent/rinse aid required, since excessive amounts can lead to excess suds.

Disconnect the mains plug

If, after carrying out the above checks, the fault persists, disconnect the mains plug and turn off the water tap. Contact the After-sales Service (see warranty).

Before contacting our After-Sales Service, take note of the following:

- the description of the fault,
- the appliance type and model,
- the service code (the number indicated on the adhesive rating plate) inside the door on the right-hand side:

SERVICE 0000 000 00000





400010789741

F



04/15