



> PRINT > COPY > SCAN > FAX

ECOSYS M8124cidn  
ECOSYS M8130cidn

# OPERATION GUIDE



# Preface

Thank you for purchasing this machine.

This Operation Guide is intended to help you operate the machine correctly, perform routine maintenance, and take simple troubleshooting measures as needed so that the machine can always be used in the optimum condition.

Please read the Operation Guide before using the facsimile. Keep it close to the facsimile for easy reference.

## We recommend the use of our own brand supplies.

Please use our genuine toner containers, which have passed rigorous quality control testing.

The use of non-genuine toner containers may cause failure.

We will not be liable for any damages caused by the use of third party supplies in this machine.

A label is affixed to our genuine supplies, as shown below.

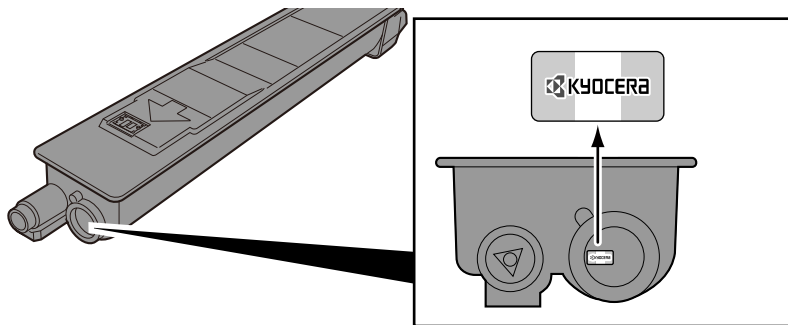

## Checking the Equipment's Serial Number

The equipment's serial number is printed in the location shown in the figure.

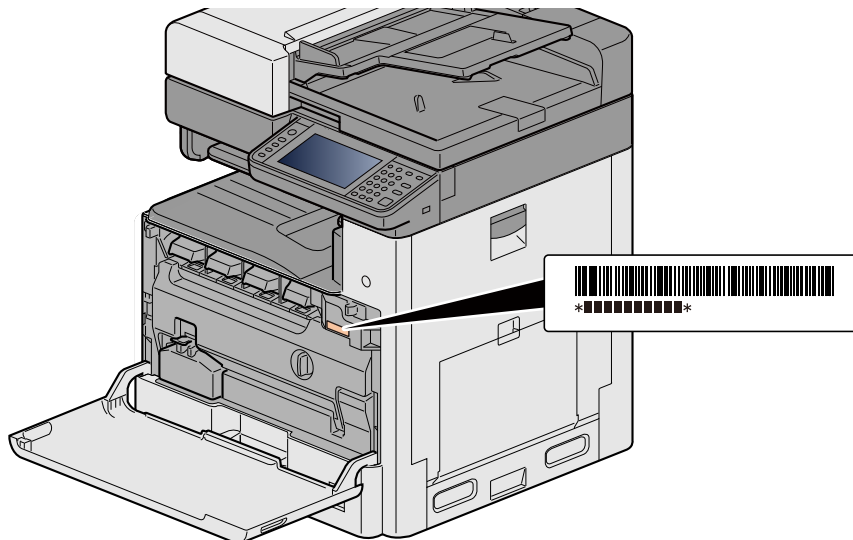

You'll need the equipment's serial number when contacting your Service Representative. Please check the number before contacting your Service Representative.

# Contents

Preface .....	i
Contents .....	ii
Menu Map .....	X
[Copy] .....	X
[Send] .....	xii
[Custom Box] (Store File, Printing, Send) .....	xiv
[Job Box] .....	xvii
[Removable Memory] (Store File, Printing Documents) .....	xvii
[FAX] .....	xx
[Sub Address Box] .....	xxi
[Polling Box] .....	xxi
[FAX Memory RX Box] .....	xxii
[Status/ Job Cancel] .....	xxii
[System Menu] .....	xxiii
Overview .....	xli
Machine Features .....	xlvi
Color and Image Quality Functions .....	xlvi
Basic Color Modes .....	xlvi
Adjusting Image Quality and Color .....	xlvii
Guides Provided with the Machine .....	xlviii
About the Operation Guide (this Guide) .....	I
Structure of the guide .....	I
Conventions Used in This Guide .....	li

## **1 Safety Precautions ..... 1-1**

Safety Conventions in This Guide .....	1-2
Environment .....	1-3
Precautions for Use .....	1-4
Laser Safety (Europe) .....	1-5
SAFETY OF LASER BEAM (USA) .....	1-6
Safety Instructions Regarding the Disconnection of Power .....	1-7
Compliance and Conformity .....	1-8
Other precautions (for users in California, the United States) .....	1-8
Warranty (the United States and Canada) .....	1-9
Legal Restriction on Copying/Scanning .....	1-10
EN ISO 7779 .....	1-10
EK1-ITB 2000 .....	1-10
Legal Information .....	1-10
Energy Saving Control Function .....	1-17
Automatic 2-Sided Print Function .....	1-18
Resource Saving Paper .....	1-19
Environmental benefits of "Power Management" .....	1-20
Energy Star (ENERGY STAR®) Program .....	1-21
Wireless Connection (Mexico only) .....	1-22
Security Precautions when Using Wireless LAN (If equipped) .....	1-23
Limited Use of This Product (If equipped) .....	1-24

## **2 Installing and Setting up the Machine ..... 2-1**

Part Names (Machine Exterior) .....	2-3
Part Names (Connectors/Interior) .....	2-5
Part Names (With Optional Equipments Attached) .....	2-6
Connecting the Machine and Other Devices .....	2-7
Connecting cable .....	2-9
Connecting LAN Cable .....	2-9
Connecting USB Cable .....	2-9
Connecting the Power Cable .....	2-9

Power On/Off .....	2-10
Power On .....	2-10
Power Off .....	2-10
Default Settings of the Machine .....	2-11
Setting Date and Time .....	2-12
Network settings .....	2-13
Configuring the Wired Network .....	2-13
Wireless Network Settings .....	2-15
Setting Wi-Fi Direct .....	2-19
Setting NFC .....	2-21
Energy Saver function .....	2-22
Low Power Mode .....	2-22
Energy Saver Recovery Level .....	2-22
Sleep .....	2-23
Auto Sleep .....	2-23
Sleep Rules (models for Europe) .....	2-23
Sleep Level (Energy Saver) (models except for Europe) .....	2-24
Quick Setup Wizard .....	2-25
Installing Software .....	2-27
Software on DVD (Windows) .....	2-27
Installing Software in Windows .....	2-28
Uninstalling the Software .....	2-34
Installing Software on a Mac Computer .....	2-35
Setting TWAIN Driver .....	2-37
Setting WIA Driver .....	2-39
Installing the WSD Driver .....	2-40
Strengthening the Security by the Administrator .....	2-41
Command Center RX .....	2-42
Accessing Command Center RX .....	2-42
Changing Security Settings .....	2-43
Changing Device Information .....	2-44
Setting SMTP and E-mail .....	2-45
Migrating the Address Book .....	2-49
Backing Up Address Book Data to PC .....	2-49
Writing Address Book Data to the Machine .....	2-51
Application .....	2-54
Installing Applications .....	2-54
Uninstalling Applications .....	2-55

### **3 Preparation before Use ..... 3-1**

Using the Operation Panel .....	3-3
Assigning a Function to a Function Key .....	3-4
Using the Operation Panel .....	3-6
Display the Home screen .....	3-6
Display for Device Information .....	3-11
Functions key .....	3-11
Displaying Keys That Cannot be Configured .....	3-12
Using the [Enter] Key .....	3-12
Using the [Quick No. Search] Key .....	3-13
Help Screen .....	3-13
Login/Logout .....	3-14
Login .....	3-14
Simple Login .....	3-15
Logout .....	3-15
Check the counter .....	3-16
Loading paper .....	3-17
Precaution for Loading Paper .....	3-17
Selecting the paper feeder unit .....	3-18
Loading in the Cassettes 1 (to 3) .....	3-19

Preparation for Sending a Document to a Shared Folder in a PC .....	3-22
Making a note of the computer name and full computer name .....	3-22
Making a note of the user name and domain name .....	3-23
Configuring Shared Folder Access Permissions .....	3-23
Creating a Shared Folder, Making a Note of a Shared Folder .....	3-24
Sharing File and Printers .....	3-27
Configuring Windows Firewall Settings .....	3-28
Adding a Destination .....	3-32
Adding a Destination (Address Book) .....	3-32
Changing an Address Book Destination .....	3-36
Deleting an Address Book Destination .....	3-37
Assigning a Destination to a One Touch Key .....	3-37
Editing One Touch Key .....	3-38
Deleting the Destination to the One Touch Key .....	3-39
Using Command Center RX to Add Destinations to the Address Book .....	3-40
Recalling Frequently Used Functions (Favorites) .....	3-41
Adding to Favorites in Wizard Mode .....	3-42
Adding to Favorites in Program Mode .....	3-43
Executing Favorites in Wizard Mode .....	3-44
Executing Favorites in Program Mode .....	3-45
Editing a Favorite .....	3-45
Deleting a Favorite .....	3-45
Registering Shortcuts (Copy, Send, and Document Box Settings) .....	3-46
Adding Shortcuts .....	3-46
Edit the shortcut .....	3-46
Deleting a Shortcut .....	3-47
Using Document Boxes .....	3-48
What is Custom Box? .....	3-48
What is Job Box? .....	3-48
What is Removable Memory Box? .....	3-49
The F Code Box, Polling Box, and FAX Memory Receive Box are for storing FAX data. 3-49	
Using Machine Operations to Create a New Custom Box .....	3-49
Using Command Center RX to Create a New Custom Box .....	3-51
Edit the custom box. ....	3-52
Deleting Custom Box .....	3-53

**4            Operation on PC ..... 4-1**

Printer Driver Print Settings Screen .....	4-2
Displaying the Printer Driver Help .....	4-4
Changing the Default Printer Driver Settings .....	4-5
Printing from PC .....	4-6
Printing on Standard Sized Paper .....	4-6
Printing on Non-standard Sized Paper .....	4-7
Canceling Printing from a Computer .....	4-10
Storing Data in Machine Memory and Printing Data in Machine Memory .....	4-11
On the computer, specify the document box and save the job .....	4-11
Using Command Center RX to Print a Job Stored in a Custom Box .....	4-12
Monitoring the Printer Status (Status Monitor) .....	4-14
Accessing the Status Monitor .....	4-14
Exiting the Status Monitor .....	4-14
Status Monitor Display .....	4-14
Printing Progress Tab .....	4-15
Paper Tray Status Tab .....	4-15
Toner Status Tab .....	4-15
Alert Tab .....	4-16
Status Monitor Context Menu .....	4-16
Status Monitor Notification Settings .....	4-17

<b>5</b>	<b>Operation on the Machine .....</b>	<b>5-1</b>
	Place the Originals. ....	5-3
	Placing Originals on the Platen .....	5-3
	Loading Originals in the Document Processor .....	5-4
	Loading Paper in the Multi Purpose Tray .....	5-7
	Using Applications .....	5-10
	Activating Applications .....	5-10
	Deactivating Applications .....	5-11
	Copying .....	5-12
	Copying .....	5-12
	Interrupt Copy .....	5-13
	Canceling Jobs .....	5-13
	Frequently-Used Sending Method .....	5-14
	Sending Scanned Document via E-mail .....	5-14
	Sending to a Shared Folder on a Computer [SMB] .....	5-16
	Sending to an Folder on an FTP Server [FTP] .....	5-18
	Scanning with a TWAIN/WIA Compatible Application .....	5-19
	Useful Sending Method .....	5-21
	Executing WSD Scan .....	5-21
	Using File Management Utility to Scan an Original Document .....	5-22
	Sending to Different Types of Destinations (Multi Sending) .....	5-23
	Sending to the E-mail address of the Logged In User .....	5-23
	Using a FAX Server to Send (FAX Server Send) .....	5-24
	Canceling Scanning .....	5-26
	Destination Operations .....	5-27
	Choosing from the Address Book .....	5-27
	Choosing from the External Address Book .....	5-29
	Choosing from the One Touch Key .....	5-29
	Choosing from the Speed Dial .....	5-30
	Checking and Editing Destinations .....	5-30
	Confirmation Screen of Destinations .....	5-30
	Recall .....	5-31
	How to Use the FAX Function .....	5-32
	Basic Operation for Document Box .....	5-33
	Box List Operations .....	5-33
	Document List Operations .....	5-33
	Custom Box Operations .....	5-34
	Saving Scanned Documents to a Custom Box .....	5-34
	Moving Documents in Custom Box .....	5-34
	Copying Documents in Custom Box into Other Boxes .....	5-35
	Copying Documents in Custom Box to Removable Memory .....	5-35
	Joining Documents in Custom Box .....	5-36
	Deleting Documents in Custom Box .....	5-37
	Sending Documents in a Custom Box .....	5-37
	Sending Documents in Custom Box to E-mail Address of Logged in user. ....	5-38
	Scanning Document Stored in a Custom Box .....	5-39
	Printing Data Saved on the Machine .....	5-40
	Printing Documents from Private Print Box .....	5-40
	Deleting the Documents Stored in the Private Print Box .....	5-40
	Printing Document from Stored Job Box .....	5-41
	Deleting the Documents Stored in the Stored Job Box .....	5-41
	Printing Document from Quick Copy Box .....	5-42
	Deleting the Documents Stored in the Quick Copy Box .....	5-42
	Printing Document from Proof and Hold Box .....	5-43
	Deleting the Documents Stored in the Proof and Hold Box .....	5-43
	Printing Documents in Custom Box .....	5-43
	Printing from the Handheld Device .....	5-45
	Printing by AirPrint .....	5-45
	Printing by Google Cloud Print .....	5-45
	Printing by Mopria .....	5-45

Printing with Wi-Fi Direct .....	5-45
Printing with NFC .....	5-46
Operating Using Removable USB Memory .....	5-47
Saving Documents to USB Memory (Scan to USB) .....	5-47
Check the USB Memory Information .....	5-48
Removing USB Memory .....	5-48
Printing from Removable USB Memory .....	5-49

**6           Advanced Setting of Functions ..... 6-1**

Icons in This Chapter .....	6-2
[ID Card Copy] .....	6-3
[Original Size] .....	6-4
[Paper Selection] .....	6-5
[Mixed Size Originals] .....	6-7
[Original Orientation] .....	6-9
[Collate/Offset] .....	6-10
[Staple] .....	6-12
[Paper Output] .....	6-15
[Density] .....	6-16
[Original Image] .....	6-17
[EcoPrint] .....	6-18
[Color Selection] .....	6-19
[Color Balance] .....	6-20
[Hue Adjustment] .....	6-21
[Sharpness] .....	6-22
[Contrast] .....	6-23
[Background Density Adj.] .....	6-24
[Saturation] .....	6-25
[Prevent Bleed-through] .....	6-26
[Zoom] .....	6-27
[Combine] .....	6-29
[Margin] .....	6-31
[Duplex] .....	6-32
[Continuous Scan] .....	6-35
[Auto Image Rotation] .....	6-36
[Job Finish Notice] .....	6-37
[File Name Entry] .....	6-38
[Priority Override] .....	6-39
[Skip Blank Page] .....	6-40
[2-sided/Book Original] .....	6-41
[Sending Size] .....	6-42
[File Format] .....	6-43
[File Separation] .....	6-48
[Scan Resolution] .....	6-49
[E-mail Subject/Body] .....	6-50
[FTP Encrypted TX] .....	6-51
[Delete after Printed] .....	6-52
[Delete after Transmitted] .....	6-53
[Storing Size] .....	6-54
[Long Original] .....	6-55
[Encrypted PDF Password] .....	6-56
[JPEG/TIFF Print] .....	6-57
[XPS Fit to Page] .....	6-58
[Erase Shadowed Areas] .....	6-59

**7           Managing Jobs, Consumables, and Devices ..... 7-1**

Checking a Job Status .....	7-2
Available Status Screens .....	7-2

Displaying the Status Screen .....	7-2
Status Display .....	7-3
Print Job Status Screen .....	7-3
Send Job Status Screen .....	7-4
Store Job Status Screen .....	7-5
Scheduled Job Status Screen .....	7-5
Checking Detailed Information of Jobs .....	7-6
Checking Job Histories .....	7-7
Available Job History Screens .....	7-7
Displaying the Job History Screen .....	7-7
Checking the Detailed Information of Histories .....	7-8
Sending the Log History .....	7-8
Job Operation .....	7-9
Pausing and Resuming a Job .....	7-9
Canceling a Job .....	7-9
Device/Communication .....	7-10
Checking the Remaining Amount of Toner and Paper (Paper/Supplies) .....	7-12

## **8 System Menu ..... 8-1**

Operation Method .....	8-2
[Quick Setup Wizard] .....	8-3
[Language] .....	8-4
[Report] .....	8-5
[Counter] .....	8-8
[Cassette/MP Tray Settings] .....	8-9
[Common Settings] .....	8-11
[Home] .....	8-23
[Copy] .....	8-24
[Send] .....	8-25
[Document Box] .....	8-26
[FAX] .....	8-27
[Application] .....	8-28
[Internet] .....	8-29
[Address Book/One Touch] .....	8-30
[User Login/Job Accounting] .....	8-31
[Printer] .....	8-32
[System/Network] .....	8-35
[Date/Timer/Energy Saver] .....	8-60
[Adjustment/Maintenance] .....	8-63

## **9 User Authentication and Accounting (User Login, Job Accounting) 9-1**

Overview of User Login Administration .....	9-3
Managing the Job Account from PC .....	9-4
Enabling User Login Administration .....	9-5
Setting User Login Administration .....	9-6
Authentication Security .....	9-6
Adding a User (Local User List) .....	9-7
Change the user properties .....	9-11
Managing User Printing .....	9-13
Managing the Users to Use TWAIN for Scanning .....	9-14
Managing the Users to Use WIA for Scanning .....	9-15
Managing the Users to Send Faxes from a PC .....	9-16
Local Authorization Settings .....	9-17
Group Authorization Settings .....	9-17
Guest Authorization Set .....	9-20
Obtain NW User Property .....	9-22
Simple Login Settings .....	9-23
ID Card Settings .....	9-26



PIN Code Authorization .....	9-26
Using User Login Administration .....	9-28
Login/Logout .....	9-28
User Login/Job Accounting .....	9-29
Enabling Job Accounting .....	9-30
Job Accounting Access .....	9-30
Setting an account. [Local] .....	9-31
Adding an Account [Accounting List] .....	9-31
Restricting the Use of the Machine .....	9-32
Setting Processing When the Limit is Exceeded .....	9-33
Editing an Account .....	9-33
Deleting an Account .....	9-34
Managing the Account Printing Status .....	9-34
Job Accounting for Scan Using TWAIN .....	9-35
Job Accounting for Scan Using WIA .....	9-36
Job Accounting for the FAX Transmitted from a Computer .....	9-37
Using JOB Accounting .....	9-39
Configuring the Job Accounting Default Settings .....	9-39
Counting by Paper Size .....	9-40
Counting the Number of Pages Printed .....	9-41
Print Accounting Report .....	9-43
Setting the Counting Method for the Copier/Printer .....	9-44
Login/Logout (Job Accounting) .....	9-44
Setting Unknown Number Processing Method .....	9-46
Setting Unknown ID Job Processing .....	9-46
Registering User Property for an Unknown ID User .....	9-46

**10 Maintenance ..... 10-1**

Regular Maintenance .....	10-2
Cleaning Glass Platen .....	10-2
Cleaning Slit Glass .....	10-2
Consumable Replacement and Replenishment .....	10-4
Toner Container Replacement .....	10-4
Waste Toner Box Replacement .....	10-7
Loading Paper .....	10-9
Staple Cartridge Replacement (Document Finisher) .....	10-10

**11 Troubleshooting ..... 11-1**

General Troubles .....	11-2
Solving Malfunctions .....	11-2
Machine Operation Trouble .....	11-3
Printed Image Trouble .....	11-6
Color printing trouble .....	11-9
Responding to Messages .....	11-10
Responding to Send Error .....	11-22
Adjustment/Maintenance .....	11-25
Overview of Adjustment/Maintenance .....	11-25
Color Registration Procedure .....	11-25
Calibration .....	11-30
Perform the laser scanner cleaning. ....	11-30
Tone Curve Adjustment .....	11-30
Drum Refresh .....	11-32
Clearing Paper Jams .....	11-33
Jam Location Indicators .....	11-33
Remove any jammed paper in the Multipurpose Tray .....	11-34
Remove any jammed paper in Right Cover 1 .....	11-35
Remove any jammed paper in Cassette 1, 2 and 3 .....	11-36
Remove any jammed paper in Right Cover 2, 3 .....	11-37

Remove any jammed paper in the Document Finisher .....	11-39
Remove any jammed paper in the Bridge Unit .....	11-40
Remove any jammed paper in the Document Processor .....	11-41
Clearing a Staple Jam .....	11-43
Clearing a staple jam of the Document Finisher .....	11-43

**12 Appendix ..... 12-1**

Optional Equipment .....	12-2
Overview of Optional Equipment .....	12-2
Optional Applications .....	12-11
Starting Application Use .....	12-11
Checking Details of Application .....	12-12
Character Entry Method .....	12-13
Entry Screens .....	12-13
Entering Characters .....	12-14
Paper .....	12-16
Paper Specifications .....	12-16
Paper Appropriate Paper .....	12-16
Special Paper .....	12-19
Specifications .....	12-23
Machine .....	12-23
Copy Functions .....	12-25
Printer Functions .....	12-26
Scanner Functions .....	12-26
Document Processor .....	12-27
Paper Feeder (500-sheet) .....	12-27
Paper Feeder (500-sheet x 2) .....	12-27
Document Finisher .....	12-27
Glossary .....	12-29
Index .....	Index-1

# Menu Map

This is a list of menus displayed on the touch panel. Depending on the settings, some menus may not be displayed. Some menu names may differ from their reference titles.

## [Copy]

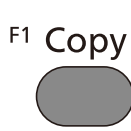

or

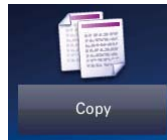

Function key	Description	Reference Page
<b>Paper Selection</b>	Select the cassette or multi-purpose tray that contains the required paper size.	<a href="#">6-5</a>
<b>Zoom</b>	Adjust the zoom to reduce or enlarge the image.	<a href="#">6-27</a>
<b>Density</b>	Adjust density.	<a href="#">6-16</a>
<b>Duplex</b>	Produces two-sided copies. You can also create single-sided copies from two-sided originals.	<a href="#">6-32</a>
<b>Combine</b>	Combines 2 or 4 original sheets into 1 printed page.	<a href="#">6-29</a>
<b>Color Selection</b>	Select the color mode setting.	<a href="#">6-20</a>

Functions	Description	Reference Page
<b>Collate/Offset</b>	Offset the output by set or page.	<a href="#">6-10</a>
<b>ID Card Copy</b>	Use this when you want to copy a driver's license or an insurance card. When you scan the front and back of the card, both sides will be combined and copied onto a single sheet.	<a href="#">6-3</a>
<b>Original Sizes</b>	Specify the original size to be scanned.	<a href="#">6-4</a>
<b>Original Orientation</b>	Select the orientation of the original document top edge to scan correct direction.	<a href="#">6-9</a>
<b>Mixed Size Originals</b>	Scans all sheets in the document processor, even if they are of different sizes.	<a href="#">6-7</a>
<b>Paper Output</b>	Specify the output tray.	<a href="#">6-15</a>
<b>Staple</b>	Staples the finished documents.	<a href="#">6-12</a>
<b>Original Image</b>	Select original image type for best results.	<a href="#">6-17</a>
<b>EcoPrint</b>	EcoPrint saves toner when printing.	<a href="#">6-18</a>
<b>Hue Adjustment</b>	Adjust the color (hue) of images.	<a href="#">6-21</a>
<b>Color Balance</b>	Adjust the strength of cyan, magenta, yellow, and black.	<a href="#">6-20</a>
<b>Sharpness</b>	Adjusts the sharpness of image outlines.	<a href="#">6-22</a>
<b>Contrast</b>	You can adjust the contrast between light and dark areas of the image.	<a href="#">6-23</a>

Functions	Description	Reference Page
<b>Background Density Adjustment</b>	Removes dark background from originals, such as newspapers.	<a href="#">6-24</a>
<b>Prevent Bleed-through</b>	Hides back side image bleed-through when scanning a thin paper original.	<a href="#">6-26</a>
<b>Skip Blank Page</b>	When there are blank pages in a scanned document, this function skips the blank pages and scans only pages that are not blank.	<a href="#">6-40</a>
<b>Saturation</b>	Adjust the color saturation of the image.	<a href="#">6-25</a>
<b>Margin</b>	Add margins (white space). In addition, you can set the margin width and the back page margin.	<a href="#">6-31</a>
<b>Erase Shadowed Areas</b>	When scanning with the document processor open, erase the extra shaded area.	<a href="#">6-59</a>
<b>Continuous Scan</b>	Scans a large number of originals in separate batches and then produce as one job.	<a href="#">6-35</a>
<b>Auto Image Rotation</b>	Automatically rotates the image 90 degrees when the sizes of the original and the loaded paper matches but the orientations are different.	<a href="#">6-36</a>
<b>Job Finish Notice</b>	Sends E-mail notice when a job is complete.	<a href="#">6-37</a>
<b>File Name Entry</b>	Adds a file name.	<a href="#">6-38</a>
<b>Priority Override</b>	Suspends the current job and gives a new job top priority.	<a href="#">6-39</a>

# [Send]

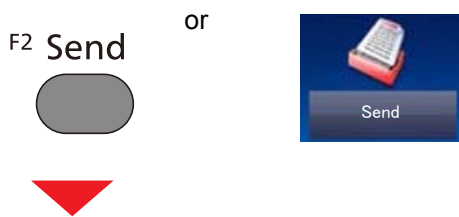

Function key	Description	Reference Page
<b>One Touch Key</b>	Assign a new destination (contact or group) to an one touch key.	<a href="#">3-37</a>
<b>Address Book</b>	Select a destination registered in the Address Book.	<a href="#">5-27</a>
<b>External Address Book</b>	Select a destination registered in the external address book.	Command Center RX User Guide
<b>E-mail</b>	Sending Scanned Document via E-mail.	<a href="#">5-14</a>
<b>Folder</b>	You can store the scanned document into the desired shared folder on a computer.	<a href="#">5-16</a> <a href="#">5-18</a>
<b>FAX</b>	Sending Scanned Document via E-mail.	FAX Operation Guide
<b>FAX Server</b>	You can send a scanned document through a fax server.	FAX Operation Guide
<b>WSD Scan</b>	WSD Scan saves images of originals scanned on this machine as files on a WSD-compatible computer (WSD Scan).	<a href="#">5-21</a>

Functions	Description	Reference Page
<b>Color Selection</b>	Select the color mode setting.	<a href="#">6-19</a>
<b>File Format</b>	Specify the image file format. Image quality level can also be adjusted.	<a href="#">6-43</a>
<b>Original Size</b>	Specify the original size to be scanned.	<a href="#">6-4</a>
<b>Original Orientation</b>	Select the orientation of the original document top edge to scan correct direction.	<a href="#">6-9</a>
<b>Mixed Sized Originals</b>	Scans all sheets in the document processor, even if they are of different sizes.	<a href="#">6-7</a>
<b>2-sided/Book Original</b>	Select the type and binding of originals.	<a href="#">6-41</a>
<b>Sending Size</b>	Select size of image to be sent.	<a href="#">6-42</a>
<b>File Separation</b>	Creates several files by dividing scanned original data page by page, and sends the files.	<a href="#">6-48</a>
<b>Scan Resolution</b>	Select fineness of scanning resolution.	<a href="#">6-49</a>
<b>Density</b>	Adjust density using 9 levels.	<a href="#">6-16</a>
<b>Original Image</b>	Select original image type for best results.	<a href="#">6-17</a>

Functions	Description	Reference Page
<b>Sharpness</b>	Adjusts the sharpness of image outlines.	<a href="#">6-22</a>
<b>Contrast</b>	You can adjust the contrast between light and dark areas of the image.	<a href="#">6-23</a>
<b>Background Density Adjustment</b>	Removes dark background from originals, such as newspapers.	<a href="#">6-24</a>
<b>Prevent Bleed-thru</b>	Hides back side image bleed-through when scanning a thin paper original.	<a href="#">6-26</a>
<b>Skip Blank Page</b>	When there are blank pages in a scanned document, this function skips the blank pages and scans only pages that are not blank.	<a href="#">6-40</a>
<b>FAX TX Resolution</b>	Select fineness of images when sending FAX.	FAX Operation Guide
<b>Zoom</b>	Adjust the zoom to reduce or enlarge the image.	<a href="#">6-27</a>
<b>Continuous Scan</b>	Scans a large number of originals in separate batches and then produce as one job.	<a href="#">6-35</a>
<b>File Name Entry</b>	Adds a file name.	<a href="#">6-38</a>
<b>E-mail Subject/Body</b>	Adds subject and body when sending a document.	<a href="#">6-50</a>
<b>Long Original</b>	Reads long-sized original documents using a document processor.	<a href="#">6-55</a>
<b>Job Finish Notice</b>	Sends E-mail notice when a job is complete.	<a href="#">6-37</a>
<b>FTP Encrypted TX</b>	Encrypts images when sending via FTP.	<a href="#">6-51</a>
<b>FAX Delayed Transmission</b>	Set a send time.	FAX Operation Guide
<b>FAX Direct Transmission</b>	Sends FAX directly without reading original data into memory.	FAX Operation Guide
<b>FAX Polling RX</b>	Dial the destination and receive documents for Polling Transmission stored in the polling box.	FAX Operation Guide

## [Custom Box] (Store File, Printing, Send)

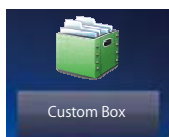

### [Store File]

Function key	Description	Reference Page
<b>2-sided/Book Original</b>	Select the type and binding of originals.	<a href="#">6-41</a>
<b>Scan Resolution</b>	Select fineness of scanning resolution.	<a href="#">6-49</a>
<b>Density</b>	Adjust density using 9 levels.	<a href="#">6-16</a>
<b>File Name Entry</b>	Adds a file name.	<a href="#">6-38</a>
<b>Color Selection</b>	Select the color mode setting.	<a href="#">6-19</a>

Functions	Description	Reference Page
<b>Original Size</b>	Specify the original size to be scanned.	<a href="#">6-4</a>
<b>Original Orientation</b>	Select the orientation of the original document top edge to scan correct direction.	<a href="#">6-9</a>
<b>Mixed Sized Originals</b>	Scans all sheets in the document processor, even if they are of different sizes.	<a href="#">6-7</a>
<b>Storing Size</b>	Select size of image to be stored.	<a href="#">6-54</a>
<b>Original Image</b>	Select original image type for best results.	<a href="#">6-17</a>
<b>Sharpness</b>	Adjusts the sharpness of image outlines.	<a href="#">6-22</a>
<b>Contrast</b>	You can adjust the contrast between light and dark areas of the image.	<a href="#">6-23</a>
<b>Background Density Adjustment</b>	Removes dark background from originals, such as newspapers.	<a href="#">6-24</a>
<b>Prevent Bleed-thru</b>	Hides back side image bleed-through when scanning a thin paper original.	<a href="#">6-26</a>
<b>Skip Blank Page</b>	When there are blank pages in a scanned document, this function skips the blank pages and scans only pages that are not blank.	<a href="#">6-40</a>
<b>Zoom</b>	Adjust the zoom to reduce or enlarge the image.	<a href="#">6-27</a>
<b>Continuous Scan</b>	Scans a large number of originals in separate batches and then produce as one job.	<a href="#">6-35</a>
<b>Job Finish Notice</b>	Sends E-mail notice when a job is complete.	<a href="#">6-37</a>

**[Print]**

Function key	Description	Reference Page
<b>Paper Selection</b>	Select the cassette or multi-purpose tray that contains the required paper size.	<a href="#">6-5</a>
<b>Collate/Offset</b>	Offset the output by set or page.	<a href="#">6-10</a>
<b>2-sided</b>	Print a document to 1-sided or 2-sided sheets.	<a href="#">6-41</a>
<b>Delete after Printed</b>	Automatically delete a document from the box once printing is complete.	<a href="#">3-50</a>

Functions	Description	Reference Page
<b>Paper Output</b>	Specify the output tray.	<a href="#">6-15</a>
<b>Staple</b>	Staples the finished documents.	<a href="#">6-12</a>
<b>Margin</b>	Add margins (white space). In addition, you can set the margin width and the back page margin.	<a href="#">6-31</a>
<b>Priority Override</b>	Suspends the current job and gives a new job top priority.	<a href="#">6-39</a>
<b>File Name Entry</b>	Adds a file name.	<a href="#">6-38</a>
<b>Job Finish Notice</b>	Sends E-mail notice when a job is complete.	<a href="#">6-37</a>
<b>EcoPrint</b>	EcoPrint saves toner when printing.	<a href="#">6-18</a>



**[Send]**

Function key	Description	Reference Page
<b>One Touch Key</b>	Assign a new destination (contact or group) to an one touch key.	<a href="#">3-37</a> <a href="#">5-29</a>
<b>Address Book</b>	Select a destination registered in the Address Book.	<a href="#">5-27</a>
<b>External Address Book</b>	Select a destination registered in the external address book.	Command Center RX User Guide
<b>E-mail</b>	Sending Scanned Document via E-mail.	<a href="#">5-14</a>
<b>Folder</b>	You can store the scanned document into the desired shared folder on a computer.	<a href="#">5-16</a> <a href="#">5-18</a>
<b>FAX</b>	Sending Scanned Document via E-mail.	FAX Operation Guide
<b>FAX Server</b>	You can send a scanned document through a fax server.	FAX Operation Guide

Functions	Description	Reference Page
<b>File Format</b>	Specify the image file format. Image quality level can also be adjusted.	<a href="#">6-43</a>
<b>File Separation</b>	Creates several files by dividing scanned original data page by page, and sends the files.	<a href="#">6-48</a>
<b>Resolution</b>	Select fineness of scanning resolution.	<a href="#">6-49</a>
<b>FAX TX Resolution</b>	Select fineness of images when sending FAX.	FAX Operation Guide
<b>File Name Entry</b>	Adds a file name.	<a href="#">6-38</a>
<b>E-mail Subject/Body</b>	Adds subject and body when sending a document.	<a href="#">6-50</a>
<b>Job Finish Notice</b>	Sends E-mail notice when a job is complete.	<a href="#">6-37</a>
<b>FTP Encrypted TX</b>	Encrypts images when sending via FTP.	<a href="#">6-51</a>
<b>FAX Delayed Transmission</b>	Set a send time.	FAX Operation Guide
<b>Delete after Transmitted</b>	Automatically deletes a document from the box once transmission is complete.	<a href="#">6-53</a>

## [Job Box]



Function key	Description	Reference Page
<b>Private Print/Stored Job</b>	In Private Printing, you can specify that a job is not to be printed until you operate the machine. In Stored Job, the print data sent from the application is saved to the machine.	<a href="#">5-40</a> <a href="#">5-41</a>
<b>Quick Copy/Proof and Hold</b>	Quick Copy feature facilitates additional prints of a document already printed. The Proof and Hold feature produces only a single proof print of multiple-print job and holds printing of the remaining copies.	<a href="#">5-42</a> <a href="#">5-43</a>

## [Removable Memory] (Store File, Printing Documents)

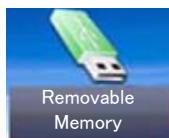

### [Store File]

Function key	Description	Reference Page
<b>File Format</b>	Specify the image file format. Image quality level can also be adjusted.	<a href="#">6-43</a>
<b>2-sided/Book Original</b>	Select the type and binding of originals.	<a href="#">6-41</a>
<b>Scan Resolution</b>	Select fineness of scanning resolution.	<a href="#">6-49</a>
<b>Density</b>	Adjust density using 9 levels.	<a href="#">6-16</a>
<b>File Name Entry</b>	Adds a file name.	<a href="#">6-38</a>
<b>Color Selection</b>	Select the color mode setting.	<a href="#">6-19</a>

Functions	Description	Reference Page
<b>Original Size</b>	Specify the original size to be scanned.	<a href="#">6-4</a>
<b>Original Orientation</b>	Select the orientation of the original document top edge to scan correct direction.	<a href="#">6-9</a>

Functions	Description	Reference Page
<b>Mixed Sized Originals</b>	Scans all sheets in the document processor, even if they are of different sizes.	<a href="#">6-7</a>
<b>Storing Size</b>	Select size of image to be stored.	<a href="#">6-54</a>
<b>Original Image</b>	Select original image type for best results.	<a href="#">6-17</a>
<b>Sharpness</b>	Adjusts the sharpness of image outlines.	<a href="#">6-22</a>
<b>Contrast</b>	You can adjust the contrast between light and dark areas of the image.	<a href="#">6-23</a>
<b>Background Density Adjustment</b>	Removes dark background from originals, such as newspapers.	<a href="#">6-24</a>
<b>Prevent Bleed-thru</b>	Hides back side image bleed-through when scanning a thin paper original.	<a href="#">6-26</a>
<b>Skip Blank Page</b>	When there are blank pages in a scanned document, this function skips the blank pages and scans only pages that are not blank.	<a href="#">6-40</a>
<b>Zoom</b>	Adjust the zoom to reduce or enlarge the image.	<a href="#">6-27</a>
<b>Continuous Scan</b>	Scans a large number of originals in separate batches and then produce as one job.	<a href="#">6-35</a>
<b>Long Original</b>	Reads long-sized original documents using a document processor.	<a href="#">6-55</a>
<b>Job Finish Notice</b>	Sends E-mail notice when a job is complete.	<a href="#">6-37</a>
<b>File Separation</b>	Creates several files by dividing scanned original data page by page, and sends the files.	<a href="#">6-48</a>

**[Print]**

Function key	Description	Reference Page
<b>Paper Selection</b>	Select the cassette or multi-purpose tray that contains the required paper size.	<a href="#">6-5</a>
<b>Collate/Offset</b>	Offsets the output by page or set.	<a href="#">6-10</a>
<b>2-sided</b>	Print a document to 1-sided or 2-sided sheets.	<a href="#">6-34</a>
<b>Color Selection</b>	Select the color mode setting.	<a href="#">6-19</a>

Functions	Description	Reference Page
<b>Paper Output</b>	Specify the output tray.	<a href="#">6-15</a>
<b>Staple</b>	Staples the finished documents.	<a href="#">6-12</a>
<b>Margin</b>	Add margins (white space). Set the margin width. In addition, you can set the margin width and the back page margin.	<a href="#">6-31</a>
<b>EcoPrint</b>	EcoPrint saves toner when printing.	<a href="#">6-18</a>
<b>Job Finish Notice</b>	Sends E-mail notice when a job is complete.	<a href="#">6-37</a>
<b>File Name Entry</b>	Adds a file name.	<a href="#">6-38</a>
<b>Priority Override</b>	Suspends the current job and gives a new job top priority.	<a href="#">6-39</a>
<b>Encrypted PDF Password</b>	Enter the preassigned password to print the PDF data.	<a href="#">6-56</a>
<b>JPEG/TIFF Print</b>	Select the image size when printing JPEG or TIFF files.	<a href="#">6-57</a>
<b>XPS Fit to Page</b>	Reduces or enlarges the image size to fit to the selected paper size when printing XPS file.	<a href="#">6-58</a>

# [FAX]

F3 FAX or

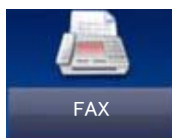

Function key	Description	Reference Page
<b>On Hook</b>	Select to use the speaker of the main unit without using the handset.	FAX Operation Guide
<b>Direct</b>	Sends FAX directly without reading original data into memory.	
<b>Recall</b>	When you want to send the fax to the same receiving system, select [Recall], and you can call the receiving system you dialed on the destination list.	
<b>Add Dest.</b>	Enter the other party number using the numeric keypad.	
<b>Address Book</b>	Select a destination registered in the Address Book.	
<b>One Touch Key</b>	Select the destination using the One Touch Keys.	
<b>External Address Book</b>	When selecting [On] for Dest. Check before Send, the confirmation screen of destinations appears after pressing the [Start] key.	Command Center RX User Guide

Functions	Description	Reference Page
<b>Original Size</b>	Specify the original size to be scanned.	FAX Operation Guide
<b>Original Orientation</b>	Select the orientation of the original document top edge to scan correct direction.	
<b>2-sided/Book Original</b>	Select the type and binding of originals.	
<b>FAX TX Resolution</b>	Select fineness of images when sending FAX.	
<b>Density</b>	Adjust density using 9 levels.	
<b>Original Image</b>	Select the image quality according to the original image type.	
<b>Continuous Scan</b>	Scans a large number of originals in separate batches and then produce as one job.	
<b>File Name Entry</b>	Adds a file name.	
<b>Long Original</b>	Reads long-sized original documents using a document processor.	
<b>Job Finish Notice</b>	Sends E-mail notice when a job is complete.	
<b>FAX Delayed Transmission</b>	Set a send time.	
<b>FAX Direct Transmission</b>	Sends FAX directly without reading original data into memory.	
<b>FAX Polling RX</b>	Dial the destination and receive documents for Polling Transmission stored in the polling box.	

## [Sub Address Box]

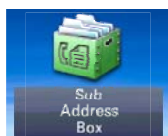

Function key	Description	Reference Page
<b>Sub Address Box</b>	Operate the sub address box.	FAX Operation Guide

## [Polling Box]

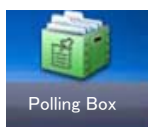

Function key	Description	Reference Page
<b>Polling Box</b>	Operate the polling box.	FAX Operation Guide

## [FAX Memory RX Box]



Function key	Description	Reference Page
FAX Memory RX Box	Operate the fax memory RX box.	FAX Operation Guide

## [Status/ Job Cancel]



or

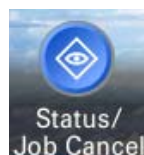

Function key	Description	Reference Page
Print Job Status	Displays the Print Job Status screen.	<a href="#">7-3</a>
Send Job Status	Displays the Send Job Status screen.	<a href="#">7-4</a>
Store Job Status	Displays the Store Job Status screen.	<a href="#">7-5</a>
Scheduled Job	Sending Job FAX using Delayed transmission	<a href="#">7-5</a>
Print Job Log	Displays the Printing Job Log screen.	<a href="#">7-7</a>
Sending Job Log	Displays the Sending Job Log screen.	<a href="#">7-7</a>
Storing Job Log	Displays the Storing Job Log screen.	<a href="#">7-7</a>
FAX Job Log	Displays the FAX Job Log screen.	FAX Operation Guide
Scanner	Displays the original scanning status or error information.	<a href="#">7-10</a>
Printer	Displays error information, queued or printing status.	<a href="#">7-10</a>
FAX Memory RX Box	Configure settings for FAX Memory RX Box.	FAX Operation Guide
FAX	The information such as sending/receiving and dialing is displayed. Also, you can stop sending/receiving FAX.	FAX Operation Guide
Toner Status	Remaining amount of toner. And you can check the status of waste toner box.	<a href="#">7-12</a>
Paper Status	You can check the size, orientation, type, and remaining amount of paper in each paper source.	<a href="#">7-12</a>

Function key	Description	Reference Page
Removable Memory	Displays usage, capacity of the USB memory connected to the machine.	<a href="#">7-10</a>
USB Keyboard	The status of the optional USB Keyboard is displayed.	<a href="#">7-11</a>
Bluetooth Keyboard	The status of the Bluetooth Keyboard is displayed.	—
Staple	Checking remaining staple.	<a href="#">7-12</a>
Network Connection Status	The network connection status appears.	<a href="#">7-11</a>
Option Network Connection Status	The connection status of an optional network interface kit appears.	<a href="#">7-11</a>
Wi-Fi Direct	The connection status of the Wi-Fi Direct is displayed.	<a href="#">7-11</a>
Wireless Network	The connection status of the Wireless Network Interface Kit is displayed.	<a href="#">7-11</a>
Wi-Fi	The connection status of the Wi-Fi is displayed.	<a href="#">7-11</a>
SSD	Displays the status of optional SSD.	<a href="#">7-11</a>
NFC	Displays the NFC connection status.	<a href="#">7-11</a>

## [System Menu]

System Menu / Counter



or

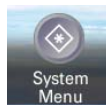

## Quick Setup Wizard

System Menu Settings	Description	Reference Page
FAX Setup	Configures fax settings in a wizard format.	FAX Operation Guide
Energy Saver Setup	Configures energy saving settings in a wizard format.	<a href="#">2-25</a>
Network Setup	Configures network settings in a wizard format.	<a href="#">2-25</a>

## Language

System Menu Settings	Description	Reference Page
Language	Set the language to use for the touch panel display.	<a href="#">8-4</a>



## Report

System Menu Settings		Description	Reference Page
<b>Report Print reports to check the machine settings, status, and history. Settings for printing reports can also be configured .</b>	<b>Report Print</b>	<b>Status page</b>	Prints the status page, allowing you to check the information including current settings, available memory space, and optional equipment installed. <a href="#">8-5</a>
		<b>Font List</b>	Prints the font list, allowing you to check the font samples installed in the machine. <a href="#">8-5</a>
		<b>Network Status</b>	Prints the network status, allowing you to check the information including network interface firmware version, network address and protocol. <a href="#">8-5</a>
		<b>Service Status</b>	More detailed information is available than on the Status Page. Service personnel usually print the service status pages for maintenance purpose. <a href="#">8-5</a>
		<b>Accounting Report</b>	Print Accounting Report. <a href="#">8-5</a>
		<b>Sub Address Box List</b>	Printing a Sub Address Box List. FAX Operation Guide
		<b>FAX List(Index)</b>	You can print the list of destinations (Index) registered in the Address Book. FAX Operation Guide
		<b>FAX List(No.)</b>	You can print the list of destinations (FAX Number) registered in the Address Book. FAX Operation Guide
		<b>Outgoing FAX Report</b>	The Outgoing FAX Report is printed as a report. FAX Operation Guide
		<b>Incoming FAX Report</b>	The latest incoming FAX information is printed as a report. FAX Operation Guide
		<b>Optional Network Status</b>	Print Report Optional Network Status. <a href="#">8-6</a>
<b>Admin Report Settings</b>	<b>Outgoing FAX Report</b>	Print Outgoing FAX Report. FAX Operation Guide	
	<b>Incoming FAX Report</b>	Print Incoming FAX Report. FAX Operation Guide	

System Menu Settings			Description	Reference Page
Report Print reports to check the machine settings, status, and history. Settings for printing reports can also be configured .	Result Report Setting	Send Result Report	Automatically print a report of transmission result when a transmission is complete.	<a href="#">8-6</a>
		FAX RX Result Report	When a fax is received, you can be notified by receipt result report.	FAX Operation Guide
		Job Finish Notice Setting	Attaches sent images to job finish notices.	FAX Operation Guide
	Sending Log History	Sending Log History	You can also send the log history to the specified destinations manually.	<a href="#">8-7</a>
		Auto Sending	The job log reaches the set number of items, this function automatically sends the log history to the specified destinations whenever a set number of jobs has been logged.	<a href="#">8-7</a>
		Destination	Set the destination to which log histories are sent. Only E-mail address can be set.	<a href="#">8-7</a>
		Job Log Subject	Set the subject automatically entered when sending log histories by E-mail.	<a href="#">8-7</a>
		Personal Information	Select whether to include personal information in the job log.	<a href="#">8-7</a>

## Counter

System Menu Settings		Description	Reference Page
Counter	Printed Pages	Check the number of sheets printed and printed coverage.	<a href="#">3-16</a>
	Scanned Pages	Check the number of sheets scanned.	<a href="#">3-16</a>

## User Property

System Menu Settings	Description	Reference Page
User Property	User properties can be changed. Types of user properties that could be changed may be different depending on user access privilege.	<a href="#">9-11</a>

## Cassette/MP Tray Settings

System Menu Settings	Description	Reference Page
Cassette 1 (to 3)	Select type of paper in Cassette 1 (to 3).	<a href="#">8-9</a>
Multi Purpose Tray	Select type of paper in multi purpose tray.	<a href="#">8-10</a>

## Common Settings

System Menu Settings		Description	Reference Page
<b>Default Screen</b>		Select the screen appearing right after start-up (default screen).	<a href="#">8-11</a>
<b>Sound</b>	<b>Buzzer</b>	Set options for buzzer sound during the machine operations.	<a href="#">8-11</a>
	<b>FAX Speaker Volume</b>	Adjust the volume of the speaker.	FAX Operation Guide
	<b>FAX Monitor Volume</b>	Adjust the volume of the monitor.	
<b>Original Settings</b>	<b>Custom Original Size</b>	Set up frequently-used custom original size.	<a href="#">8-12</a>
	<b>Auto Detect Original Size</b>	Set the original sizes for the device to detect automatically.	
<b>Paper Settings</b>	<b>Custom Paper Size</b>	Set up frequently-used custom paper size.	<a href="#">8-13</a>
	<b>Media Type Setting</b>	Select weight for each media type.	<a href="#">8-14</a>
	<b>Default Paper Source</b>	Select the default paper source from Cassette 1-3 and multi purpose tray.	<a href="#">8-13</a>
	<b>Paper Selection</b>	Set the default paper selection.	<a href="#">8-13</a>
	<b>Media for Auto (Color)</b>	Select a default media type (Color) for auto paper selection when [Auto] is selected of Paper Selection.	<a href="#">8-13</a>
	<b>Media for Auto (B&amp;W)</b>	Select a default media type (Black and White) for auto paper selection when [Auto] is selected of Paper Selection.	<a href="#">8-13</a>
	<b>Special Paper Action</b>	When printing on the special paper, such as Prepunched, Preprint, and Letterhead, select whether or not to adjust the paper orientation to the original orientation.	<a href="#">8-14</a>
	<b>Show Paper Setup Message</b>	Set whether to display the confirmation screen for the paper setting when a new paper is set for each cassette.	<a href="#">8-14</a>

System Menu Settings		Description	Reference Page
Function Defaults	File Format	Set the default type of the files.	<a href="#">8-16</a>
	Original Orientation	Set the original orientation defaults.	<a href="#">8-16</a>
	Collate/Offset	Set the defaults for Collate/Offset.	<a href="#">8-16</a>
	File Separation	Select the default file separation setting.	<a href="#">8-16</a>
	Scan Resolution	Select the default scanning resolution.	<a href="#">8-16</a>
	Color Selection (Copy)	Set the default color mode setting (at copy).	<a href="#">8-16</a>
	Color Select.(Send/Store)	Set the default color mode (send/store) setting.	<a href="#">8-16</a>
	Original Image (Copy)	Set the default original document type for copying.	<a href="#">8-16</a>
	Original Image (Sending/Storing)	Set the default original document type for sending/storing.	<a href="#">8-16</a>
	Backgrnd Density (Copy)	Set the default Backgrnd Density.	<a href="#">8-16</a>
	BackgrndDens.(Send/Store)		<a href="#">8-16</a>
	EcoPrint	Select the EcoPrint default.	<a href="#">8-16</a>
	Prevent Bleed-thru (Copy)	Set the default value for preventing bleed-through (Copy).	<a href="#">8-16</a>
	Prevent Bleed(Send/Store)		<a href="#">8-16</a>
	Skip Blank Page (Copy)	Select the default Skip Blank Page settings (Copy).	<a href="#">8-16</a>
	Skip Blank Page (Send/Store)		<a href="#">8-16</a>
	FAX TX Resolution	Select the default scanning resolution.	FAX Operation Guide
	Zoom	Set the zoom defaults.	<a href="#">6-27</a>
	Margin	Set the default margin.	<a href="#">6-31</a>
	Erase Shadowed Areas	Set the default Erase Shadowed Areas setting.	<a href="#">8-17</a>
	Continuous Scan (Copy)	Set the continuous scan defaults.	<a href="#">6-35</a>
	Continuous Scan (FAX)	Set the continuous scan defaults.	FAX Operation Guide
	Continuous Scan (Send/Store)	Set the continuous scan defaults.	<a href="#">6-35</a>
	Auto Image Rotation	Select the default Auto Image Rotation setting.	<a href="#">8-24</a>
File Name Entry	Set an automatically entered name (default) for jobs.	<a href="#">6-38</a>	
E-mail Subject/Body	Set the subject and body automatically entered (default subject and body) when sending the scanned originals by E-mail.	<a href="#">6-50</a>	
FTP Encrypted TX	Set the document encryption default at send.	<a href="#">6-51</a>	

System Menu Settings		Description	Reference Page	
Function Defaults	JPEG/TIFF Print	Select the image size (resolution) when printing JPEG or TIFF file.	<a href="#">6-57</a>	
	XPS Fit to Page	Set the default value for the XPS fit to page function.	<a href="#">6-58</a>	
	Detail Settings	Image Quality	Select the default PDF/TIFF/JPEG/XPS file quality.	<a href="#">8-18</a>
		PDF/A	Select the default PDF/A setting.	<a href="#">8-18</a>
		High Comp. PDF Image	Select the default quality setting for high compressed PDF files.	<a href="#">8-18</a>
		OCR Text Recognition	Set the default OCR Text Recognition.	<a href="#">8-18</a>
		Primary OCR Language	Set the default language of the text to be extracted.	<a href="#">8-18</a>
		OCR Output Format	Set the default OCR Output Format.	<a href="#">8-18</a>
		Detect Items to Skip (Copy)	Select the default Detect Items to Skip (Copy) setting.	<a href="#">8-18</a>
		Detect Items to Skip (Send/Store)	Select the default Detect Items to Skip (Send/Store) setting.	<a href="#">8-18</a>
Paper Output		Select the output tray respectively for copy jobs, print jobs from Document Box, computers, and FAX RX data.	<a href="#">8-18</a>	
Preset Limit		Restrict the number of copies that can be made at one time.	<a href="#">8-18</a>	
Error Handling	Duplexing Error	Set what to do when duplex printing is not possible for the selected paper sizes and media types.	<a href="#">8-19</a>	
	Finishing Error	Set alternative actions when finishing (Staple/Offset) is not available for the selected paper size or media type.	<a href="#">8-19</a>	
	No Staple Error	Set what to do when staples run out during printing.	<a href="#">8-19</a>	
	Stapling Limit Error	Set what to do when stapling capacity is exceeded during printing.	<a href="#">8-19</a>	
	Paper Mismatch Error	Set what to do when the selected paper size or type does not match paper size or type loaded in the specified paper source while printing from the computer by specifying the cassette or multi-purpose tray.	<a href="#">8-19</a>	
	Inserted Paper Mismatch	Set what to do when it is detected that the cassette paper size setting does not match the actual paper size that is fed.	<a href="#">8-19</a>	
Color Toner Empty Action		Select whether printing is prohibited or the Print in Black and White setting is used for printing once the color toner runs out.	<a href="#">8-19</a>	
Measurement		Select inch or metric for the unit for paper dimensions.	<a href="#">8-20</a>	
Low Toner Alert		Set the amount of remaining toner to notify the administrator when to order a toner when the toner is running low.	<a href="#">8-20</a>	

System Menu Settings	Description	Reference Page
<b>Keyboard Layout</b>	Change the layout of the touch panel keyboard used to enter characters.	<a href="#">2-10</a>
<b>USB Keyboard Type</b>	Select the type of USB keyboard that you want to use.	<a href="#">2-10</a>
<b>Offset Documents by Job</b>	Select whether to offset documents by Job.	<a href="#">8-20</a>
<b>Offset One Page Documents</b>	Set whether one-page documents are sorted.	<a href="#">8-21</a>
<b>Display Status/Log</b>	Set the display method of the Status/Log.	<a href="#">8-21</a>
<b>Function key</b>	Configure settings for function key on the operation panel.	<a href="#">8-21</a>
<b>Show Power Off Message</b>	Set the mode whether display a confirmation message in power supply off.	<a href="#">8-21</a>
<b>Layout for ID Card Copy</b>	Set the print position of the scanned image when copying the ID card.	<a href="#">8-22</a>

## Home

System Menu Settings	Description	Reference Page
<b>Customize Desktop</b>	Specify the function icons to display on the desktop.	<a href="#">3-8</a>
<b>Customize Taskbar<sup>*1</sup> or taskbar screen<sup>*2</sup></b>	Specify the task icons to display on the taskbar.	<a href="#">3-8</a>
<b>Wallpaper</b>	Configure the wallpaper of the Home screen.	<a href="#">3-8</a>

\*1 ECOSYS M8130cidn

\*2 ECOSYS M8124cidn

## Copy

System Menu Settings	Description	Reference Page
<b>Auto Paper Selection</b>	If [Auto] is selected for Paper Selection, set the paper size selection method when the zoom changes.	<a href="#">8-24</a>
<b>Auto % Priority</b>	When a paper source of different size from the original is selected, select whether automatic zoom (reduce/zoom) is performed.	<a href="#">8-24</a>
<b>Paper Size for Small Original</b>	Specify the paper size to be used for a case where the original is too small to be detected in the Auto Paper Selection mode.	<a href="#">8-24</a>
<b>Original Size of Undetected Original</b>	Set the original size of an undetected original.	<a href="#">8-24</a>
<b>Reserve Next Priority</b>	Specify whether the default screen appears when a subsequent copy job is reserved while printing is in progress.	<a href="#">8-24</a>
<b>Auto Image Rotation Action</b>	Set whether the image is rotated when the orientation of the document to be printed is different from the orientation of the paper.	<a href="#">8-24</a>

## Send

System Menu Settings	Description	Reference Page
<b>Dest. Check before Send</b>	Select whether to display the confirmation screen of destinations after pressing the [Start] key when performing sending jobs.	<a href="#">8-25</a>
<b>Entry Check for New Dest.</b>	When adding new destination, select whether to display the entry check screen to check the entered destination.	<a href="#">8-25</a>
<b>Send and Forward</b>	<b>Forward</b>	Select whether to forward the original. <a href="#">8-25</a>
	<b>Destination</b>	Set the destination to which the original is forwarded. <a href="#">8-25</a>
<b>Color TIFF Compression</b>	Select the compression method for sending the color documents in the TIFF format. <a href="#">8-25</a>	
<b>Default Screen</b>	Set the default screen displayed when you select the [Send] key. <a href="#">8-25</a>	
<b>New Destination Entry</b>	Select whether to permit direct entry of destination. <a href="#">8-25</a>	
<b>Recall</b>	Select whether to permit usage of [Recall] on the Send screen. <a href="#">8-25</a>	
<b>Broadcast Transmission</b>	Set whether to enable broadcast. <a href="#">8-25</a>	
<b>OCR Text Recognition Action</b>	Configure settings for OCR Text Recognition Action. <a href="#">8-25</a>	

## Document Box

System Menu Settings	Description	Reference Page
<b>Custom Box</b>	Configure settings for Custom Box. <a href="#">8-26</a>	
<b>Sub Address Box</b>	Configure settings for Sub Address Box. FAX Operation Guide	

System Menu Settings		Description	Reference Page
Job Box	Quick Copy Job Retention	To maintain free space on the box, you can set the maximum number of stored jobs.	<a href="#">8-26</a>
	Deletion of Job Retention	This setting specifies that documents, such as Private Printing, Quick Copying, or Proof and Hold Printing, saved temporarily in the job box are automatically deleted after they have been saved for a set time.	<a href="#">8-26</a>
	Storage Media	Select which storage media to use.	<a href="#">8-26</a>
Polling Box		Configure settings for Polling Box.	FAX Operation Guide
FAX Memory RX Box		Configure settings for FAX Memory RX Box.	Command Center RX User Guide

## FAX

System Menu Settings	Description	Reference Page
FAX	Settings related to the fax function can be configured.	FAX Operation Guide

## Application

System Menu Settings	Description	Reference Page
Application	Configure settings for Application.	<a href="#">8-28</a>



## Internet

System Menu Settings	Description	Reference Page
Internet	Set the proxy for connection to the Internet from an application.	<a href="#">8-29</a>

## Address Book/One Touch

System Menu Settings	Description	Reference Page	
Address Book/One Touch	Address Book	Configure settings for address book. <a href="#">3-32</a>	
	One Touch Key	Configure settings for One Touch Key. <a href="#">3-37</a>	
	Address Book Defaults	Sort	Select the default sort setting of the address for the address book. <a href="#">8-30</a>
		Address Book Type	This procedure can be used to filter (narrow down) the types of destination listed when the address book is displayed. <a href="#">8-30</a>
	Edit Restriction	Address Book	Restrict editing of the address book. <a href="#">8-30</a>
		One Touch Key	Restrict editing of the One Touch Key. <a href="#">8-30</a>
	Print List	You can print the list of destinations registered in the Address Book. FAX Operation Guide	

## User Login/Job Accounting

System Menu Settings			Description	Reference Page	
User Login/ Job Accounting	User Login Setting	User Login Administration	This enables user login administration.	<a href="#">9-5</a>	
		Local User List	You can register, edit and delete users.	<a href="#">9-7</a>	
		ID Card Settings	Keyboard Login	When ID card authentication is enabled, select whether or not login by keyboard is allowed.	<a href="#">9-26</a>
			Additional Authentication	Select whether or not to require password entry after authenticating by ID card.	<a href="#">9-26</a>
		PIN Code Authorization		Select whether or not to use PIN Code Authorization.	<a href="#">9-26</a>
		Simple Login Settings	Simple Login	Select whether or not simple login is enabled.	<a href="#">9-23</a>
			Simple Login Setup	Register users to use simple login.	<a href="#">9-23</a>
		Local Authorization		Select whether or not to use Local Authorization.	<a href="#">9-17</a>
		User Account Lockout Settings	Lockout	Select whether or not account lockout policy is enabled.	<a href="#">9-6</a>
			Lockout Policy	Specify the conditions and the extent to which the account lockout is applied.	<a href="#">9-6</a>
			Locked out Users List	Displays a list of locked out users.	<a href="#">9-6</a>
		Group Authorization Set.	Group Authorization	Set restrictions of the machine usage by each individual group registered in the authentication server.	<a href="#">9-17</a>
			Group List	Register the groups that are restricted the machine usage.	<a href="#">9-18</a>
		Guest Authorization Set.	Guest Authorization	When User Login Administration is enabled, set the functions that guest users who cannot log in to the machine are allowed to use.	<a href="#">9-20</a>
			Guest Property	Register guest user information and functions that are restricted.	<a href="#">9-20</a>
		Obtain NW User Property		Set the required information to obtain the network user property from the LDAP server.	<a href="#">9-22</a>

System Menu Settings		Description	Reference Page
User Login/ Job Accounting	Job Accounting Setting	Job Accounting	Enable job accounting. <a href="#">9-30</a>
		Job Accounting Access	Set the job accounting access. <a href="#">9-30</a>
		Print Accounting Report	The total pages counted of all relevant accounts can be printed as an accounting report. <a href="#">9-43</a>
		Total Job Accounting	Counting the Number of Pages Printed Total Accounting. <a href="#">9-43</a>
		Each Job Accounting	This counts the number of pages for each account and resets the counts by account. <a href="#">9-43</a>
		Accounting List	You can register, edit or delete accounts. <a href="#">9-46</a>
	Default Setting	Apply Limit	This specifies how the machine behaves when the counter has reached the limit of restriction. <a href="#">9-39</a>
		Copier/Printer Count method	You can select the management method for the number of pages used for the copier and printer, either combined or individually. <a href="#">9-39</a>
		Counter Limit	When you add a new account, you can change the default restrictions on the number of sheets used. <a href="#">9-39</a>
		Count by Paper Size	This counts the number of pages by paper size. <a href="#">9-39</a>
Unknown User Settings		This specifies the behavior for handling the jobs sent with unknown or unsend login user names or User ID. <a href="#">9-46</a>	

## Printer

System Menu Settings		Description	Reference Page
Printer	<b>Emulation</b>	Select the emulation for operating this machine by commands oriented to other types of printers.	<a href="#">8-32</a>
	<b>Color Setting</b>	You can choose whether reports are printed in color or black and white.	<a href="#">8-32</a>
	<b>EcoPrint</b>	EcoPrint saves toner when printing.	<a href="#">8-32</a>
	<b>Override A4/Letter</b>	Select whether to treat A4 size and Letter, which are similar in size, as the same size when printing.	<a href="#">8-32</a>
	<b>Duplex</b>	Select binding orientation for duplex mode.	<a href="#">8-32</a>
	<b>Copies</b>	Set the default number of copies, from 1 to 999.	<a href="#">8-32</a>
	<b>Orientation</b>	Set the default orientation, [Portrait] or [Landscape].	<a href="#">8-32</a>
	<b>Wide A4</b>	Turn this to on to increase the maximum number of characters that can be printed in a line for an A4 page (80 characters at 10 pitch) and Letter size page (80 characters at 10 pitch).	<a href="#">8-32</a>
	<b>Form Feed Timeout</b>	When the preset timeout passes, the machine automatically prints paper. Set this waiting time.	<a href="#">8-32</a>
	<b>LF Action</b>	Set the line feed action when the machine receives the line feed code (character code 0AH).	<a href="#">8-32</a>
	<b>CR Action</b>	Set the character return action when the machine receives the character return code (character code 0DH).	<a href="#">8-33</a>
	<b>Job Name</b>	Set whether the job name set in the printer driver is displayed.	<a href="#">8-33</a>
	<b>User Name</b>	Set whether the user name set in the printer driver is displayed.	<a href="#">8-33</a>
	<b>MP Tray Priority</b>	If paper is set in the MP Tray then it is possible for priority to be given to that MP tray in the paper feed.	<a href="#">8-33</a>
	<b>Paper Feed Mode</b>	While printing from the computer, select how to feed paper when the paper source and type are specified.	<a href="#">8-33</a>
	<b>Auto Cassette Change</b>	Select the following actions when the paper runs out in the paper source while printing.	<a href="#">8-33</a>
	<b>Resolution</b>	Set the resolution used for printing.	<a href="#">8-33</a>
	<b>KIR</b>	Select the default KIR (smoothing) setting.	<a href="#">8-33</a>
	<b>Gloss Mode</b>	Glossiness of printed matter can be increased.	<a href="#">8-34</a>
	<b>Printing Job Terminator</b>	Set the condition to be regarded as the job end if the print job has not been processed to the end due to the usage environment or for other reasons.	<a href="#">8-34</a>

## System/Network

System Menu Settings		Description	Reference Page	
System/ Network	Network	<b>Host Name</b>	Check the host name of the machine. <a href="#">8-35</a>	
		<b>Wi-Fi Direct Settings</b>	Select whether to use Wi-Fi Direct. <a href="#">8-35</a>	
		<b>Wi-Fi Settings</b>	Select whether to use Wi-Fi Settings. <a href="#">8-36</a>	
		<b>Wired Network Settings</b>	<b>TCP/IP Setting</b>	Select whether to use TCP/IP Protocol. <a href="#">8-41</a>
			<b>LAN Interface</b>	Specify the settings for the LAN interface to be used. <a href="#">8-43</a>
		<b>Bonjour</b>	<b>Protocol Settings</b>	Select whether to use Bonjour. <a href="#">8-43</a>
			<b>Available Network (Wi-FiDirect)</b>	Select whether or not Wi-FiDirect is enabled. <a href="#">8-43</a>
			<b>Available Network (Wi-Fi)</b>	Select whether or not Wi-Fi is enabled. <a href="#">8-43</a>
			<b>Available Network (Wired Network)</b>	Select whether or not Wired Network is enabled. <a href="#">8-43</a>
		<b>IPSec</b>		Select whether to use IPSec. <a href="#">8-43</a>
		<b>Protocol Settings</b>	<b>NetBEUI</b>	Selects whether to receive documents using NetBEUI. <sup>*1</sup> <a href="#">8-44</a>
			<b>LPD</b>	Selects whether to receive documents using LPD. <sup>*1</sup> <a href="#">8-44</a>
			<b>SMTP (E-mail TX)</b>	Select whether to send E-mail using SMTP. <a href="#">8-44</a>
			<b>POP3 (E-mail RX)</b>	Select whether to receive E-mail using POP3. <a href="#">8-44</a>
			<b>FTP Client (Transmission)</b>	Select whether to send documents using FTP. <a href="#">8-44</a>
			<b>FTP Server (Reception)</b>	Select whether to receive documents using FTP. <sup>*1</sup> <a href="#">8-44</a>
			<b>SMB Client (Transmission)</b>	Select whether to send documents using SMB. <a href="#">8-44</a>
			<b>WSD Scan</b>	Select whether to use WSD Scan. <sup>*1</sup> <a href="#">8-45</a>
			<b>WSD Print</b>	Set whether to use our proprietary web services. <sup>*1</sup> <a href="#">8-45</a>

System Menu Settings			Description	Reference Page	
System/ Network	Network	Protocol Settings	<b>DSM Scan</b>	Select whether to use DSM scan.	<a href="#">8-45</a>
			<b>LDAP</b>	Select whether to use LDAP.	<a href="#">8-45</a>
			<b>SNMP</b>	Select whether to communicate using SNMP. *1	<a href="#">8-45</a>
			<b>SNMPv3</b>	Select whether to communicate using SNMPv3. *1	<a href="#">8-45</a>
			<b>HTTP</b>	Select whether to communicate using HTTP. *1	<a href="#">8-46</a>
			<b>HTTPS</b>	Select whether to communicate using HTTPS., *1*2	<a href="#">8-46</a>
			<b>IPP</b>	Selects whether to receive documents using IPP. *1	<a href="#">8-46</a>
			<b>IPP over SSL</b>	Selects whether to receive documents using IPP over SSL. *1*2	<a href="#">8-47</a>
			<b>RAWPort</b>	Selects whether to receive documents using RAWPort. *1	<a href="#">8-47</a>
			<b>ThinPrint</b>	Select whether to use ThinPrint.	<a href="#">8-48</a>
			<b>Enhanced WSD</b>	Set whether to use our proprietary web services. *1	<a href="#">8-49</a>
			<b>Enhanced WSD over SSL</b>	Set whether to use our proprietary web services over SSL. *1*2	<a href="#">8-49</a>
			<b>eSCL</b>	Selects whether to receive scanned documents using eSCL. *1	<a href="#">8-49</a>
			<b>eSCL over SSL</b>	Selects whether to receive scanned documents using eSCL over SSL. *1*2	<a href="#">8-50</a>
		Security Settings	<b>SSL</b>	Select whether to use SSL for communication. *3	<a href="#">8-50</a>
			<b>IPP Security</b>	Select the IPP security level. This setup is available when SSL is [On]. *3	<a href="#">8-50</a>
			<b>HTTP Security</b>	Select the HTTP security level. This setup is available when SSL is [On]. *3	<a href="#">8-50</a>
			<b>SMTP Security</b>	Select the communication protocol according to the type of security employed by the SMTP server.	<a href="#">8-50</a>
		Security Settings	<b>POP3 Security (User 1-3)</b>	Select the communication protocol according to the type of security employed by the POP3 server.	<a href="#">8-50</a>
		<b>Ping</b>		Checks if communication with the destination by entering the host name or IP address of the destination is possible.	<a href="#">8-50</a>
		<b>Restart Network</b>		Restarts the network.	<a href="#">8-51</a>
		<b>Proxy</b>		Set the proxy for connection to the Internet from an application.	<a href="#">8-51</a>

System Menu Settings		Description	Reference Page
System/ Network	<b>Optional Network</b>		Configure settings for the Optional Network. <a href="#">8-53</a>
	<b>Wireless Network</b>		Configure settings for the Wireless Network Settings. <a href="#">8-53</a>
	<b>Primary Network (Client)</b>		Select the Network Interface to be used when the machine is connected to a transmission function or external Address Book operated as the client side. <a href="#">8-54</a>
	<b>Interface Block Setting</b> <sup>*3</sup>	<b>USB Host</b>	This locks and protects the USB port (USB host). <a href="#">8-54</a>
		<b>USB Device</b>	This locks and protects the USB interface connector (USB Device). <a href="#">8-54</a>
		<b>USB Storage</b>	This locks and protects the USB memory slot. <a href="#">8-54</a>
		<b>Option Interface (Slot 1 and 2)</b>	This locks and protects the optional interface slots. <a href="#">8-54</a>
	<b>Bluetooth Settings</b>		Set the Bluetooth keyboard. <a href="#">8-55</a>
	<b>Security Level</b>		Specify the security level. <a href="#">8-55</a>
	<b>Restart</b>		Restart the CPU without turning the power switch off. <a href="#">8-55</a>
	<b>RAM Disk Settings</b>		Create a RAM disk and set its capacity. <a href="#">8-56</a>
	<b>Data Security</b>	<b>SSD Initialization</b>	Initialize data saved on an optional SSD. <a href="#">8-57</a>
		<b>Data Sanitization</b>	Return the following information registered in the machine to the factory defaults. <a href="#">8-57</a>
	<b>OCR Dictionary Installation</b>		Install the OCR Dictionary. <a href="#">8-58</a>
	<b>Optional Function</b>		You can use the optional applications installed on this machine. <a href="#">8-58</a>
	<b>Remote Services Settings</b>		Select whether to use Remote Services Settings. <a href="#">8-59</a>
<b>FAX Server Settings</b>	<b>FAX Server</b>	Select whether to use FAX Server. <a href="#">8-59</a>	
	<b>Address Settings</b>	Set a prefix, suffix, and domain added to Destination <a href="#">8-59</a>	
	<b>File Format</b>	Select the default file setting. <a href="#">8-59</a>	
	<b>Address Book Defaults</b>	Set an external Address Book to be used. <a href="#">8-59</a>	
<b>NFC</b>		Configure NFC settings. <a href="#">8-59</a>	

\*1 The setting will be changed after restarting the device or network.

\*2 In "Security Settings", set "Restart Network" to [On].

\*3 After changing the setting, restart the network or turn the machine OFF and then ON.

➔ [Changing Device Information \(2-44\)](#)

➔ [\[TCP/IP Setting\] \(8-41\)](#)

## Date/Timer/Energy Saver

System Menu Settings		Description	Reference Page
Date/ Timer/ Energy Saver	<b>Date/Time</b>	Set the date and time for the location where you use the machine.	<a href="#">8-60</a>
	<b>Date Format</b>	Select the display format of year, month, and date.	<a href="#">8-60</a>
	<b>Time Zone</b>	Set the time difference from GMT.	<a href="#">8-60</a>
	<b>Auto Panel Reset</b>	If no jobs are run for a certain period of time, automatically reset settings and return to the default setting.	<a href="#">8-60</a>
	<b>Panel Reset Timer</b>	If you select [On] for Auto Panel Reset, set the amount of time to wait before Auto Panel Reset.	<a href="#">8-60</a>
	<b>Low Power Timer</b>	Set amount of time before entering the Low Power mode.	<a href="#">8-60</a>
	<b>Sleep Rules</b>	Select whether to use the Sleep mode for the following functions individually.	<a href="#">8-60</a>
	<b>Sleep Timer</b>	Set amount of time before entering Sleep.	<a href="#">8-61</a>
	<b>Energy Saver Recovery Level</b>	Select the method of recovery from energy saver.	<a href="#">8-61</a>
	<b>Auto Error Clear</b>	In the Auto Error Clear mode, automatically clear the error after a set amount of time elapses.	<a href="#">8-61</a>
	<b>Error Clear Timer</b>	If you select [On] for Auto Error Clear, set the amount of time to wait before automatically clearing errors.	<a href="#">8-61</a>
	<b>Interrupt Clear Timer</b>	Set the period after which the machine reverts to Normal mode when it has been set to Interrupt Copy mode and then left unused.	<a href="#">8-62</a>
	<b>Unusable Time</b>	This feature sets a time period during which the machine will not control received faxes.	FAX Operation Guide
	<b>Ping Timeout</b>	Set the time until timeout occurs when [Ping] is executed in "System/Network".	<a href="#">8-62</a>



## Adjustment/Maintenance

System Menu Settings			Description	Reference Page
Adjustment/Maintenance	Density Adjustment	Copy	Adjust copy density.	<a href="#">8-63</a>
		Send/Box	Adjust scan density when sending or storing the data in Document Box.	<a href="#">8-63</a>
		FAX	Adjust overall scan density when sending a FAX to be darker or lighter.	FAX Operation Guide
	Sharpness Adjustment	Copy	Sharpen or blur overall image outlines of text/fine lines during copying.	<a href="#">8-63</a>
		Send/Box	Adjust sharpness of the text/fine line when sending the scanned images to the specified destination or storing them in the Document Box.	<a href="#">8-63</a>
	Contrast	Copy	Increases or decreases the overall contrast of copies.	<a href="#">8-63</a>
		Send Box	Increases or decreases the overall contrast when documents are sent or saved in a document box.	<a href="#">8-63</a>
	Background Density Adjustment	Copy (Auto)	Darkens or lightens overall background density adjustment during copying.	<a href="#">8-63</a>
		Send Box (Auto)	Darkens or lightens overall background density when sending images or storing them in the Document Box.	<a href="#">8-63</a>
	Toner Save Level (EcoPrint)	Copy	Select the default Toner Save Level (EcoPrint) at the time of copying.	<a href="#">8-63</a>
		Printer	Select the default Toner Save Level (EcoPrint) at the time of the printing.	<a href="#">8-63</a>
	Auto Color Correction		This setting allows you to adjust the detection level used by the machine to determine whether the original is color or black and white in Auto Color Selection Mode.	<a href="#">8-63</a>
	Correcting Black Lines		Correct fine lines (streaks caused by contamination), which may appear on the image, when the document processor is used.	<a href="#">8-64</a>
	Display Brightness		Set the brightness of the touch panel.	<a href="#">8-64</a>
	Color Registration		Use this function to correct the color position of each of cyan, magenta and yellow to correct color drift.	<a href="#">8-64</a>
	Tone Curve Adjustment		Perform this function to ensure consistency with the original tone.	<a href="#">8-64</a>
	Drum Refresh		Remove image blur and white dots from the printout.	<a href="#">11-30</a>
Auto Drum Refresh		Set the execution duration of auto drum refresh.	<a href="#">11-32</a>	
Calibration		Adjust color drift and hue of printed images.	<a href="#">8-64</a>	
Laser Scanner Cleaning		Remove vertical white lines from the printout.	<a href="#">8-64</a>	

# Overview

This machine provides standard copy and print functions, and a scanned image can be sent to an E-mail recipient as an attachment or to a computer on the same network. On products with a FAX function, it is also possible to use the fax function.

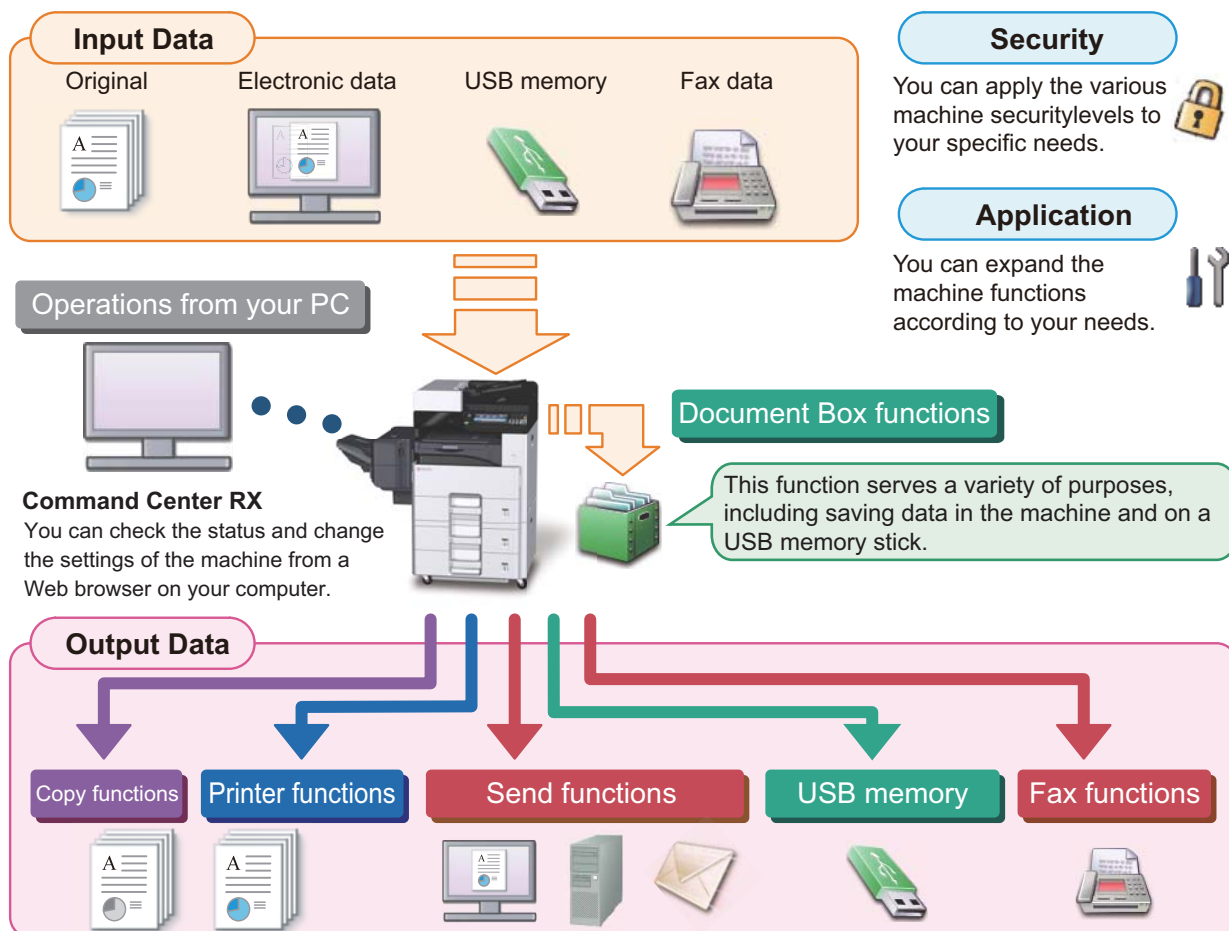

## NOTE



- **For each of the functions, refer to the following:**
  - Security: ➔ [Strengthen security \(xliv\)](#)
  - Application: ➔ [Application \(2-54\)](#)
  - Command Center RX: ➔ [Command Center RX \(2-42\)](#): Command Center RX User Guide
  - Document Box Function: ➔ [Using Document Boxes \(3-48\)](#)
  - Copy Function: ➔ [Copying \(5-12\)](#)
  - Printer Function: ➔ [Printing from PC \(4-6\)](#)
  - Transmission Function: ➔ [Frequently-Used Sending Method \(5-14\)](#)
  - USB Memory: ➔ [Saving Documents to USB Memory \(Scan to USB\) \(5-47\)](#)
  - FAX function: FAX Operation Guide
- **Please read this information before using your machine.**
  - ➔ [Safety Precautions \(1-1\)](#)
- **To prepare the device for use, including setting up cable connections and installing software, refer to the following.**
  - ➔ [Installing and Setting up the Machine \(2-1\)](#)
- **To learn how to load paper, set up shared folders, and add addresses to the address book, refer to the following.**
  - ➔ [Preparation before Use \(3-1\)](#)

# Machine Features

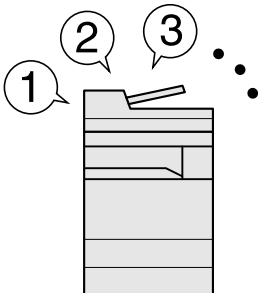
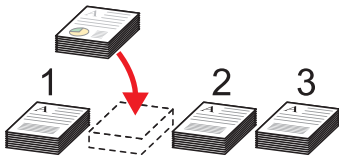

The machine is equipped with many useful functions.

➔ [Advanced Setting of Functions \(6-1\)](#)

Here are some examples.

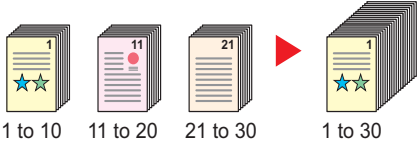
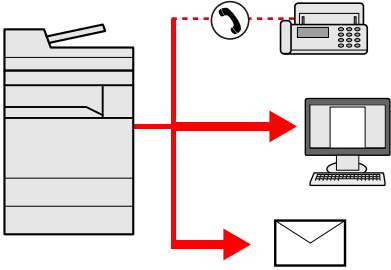
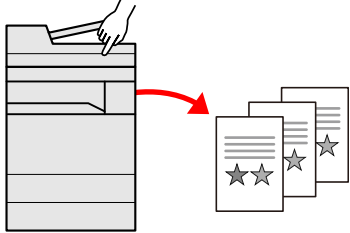
Optimize your office workflow		
<p><b>Access to frequently used functions with just one touch (Favorites)</b></p>  <p>You can preset frequently used functions. Once you register frequently used settings as favorite, you can call up the settings easily. Using this favorite brings the same results even if operated by another person.</p> <p>➔ <a href="#">Recalling Frequently Used Functions (Favorites) (3-41)</a></p>	<p><b>Interrupt other running jobs and execute your copy job immediately Inter (Interrupt Copy)</b></p>  <p>You can interrupt other running jobs and execute your copy job immediately.</p> <p>When other users are copying a large number of sheets, this function allows you to interrupt those jobs and make your copies immediately. When the interruption copy ends, the machine resumes the paused print jobs.</p> <p>➔ <a href="#">Interrupt Copy (5-13)</a></p>	<p><b>Scan originals of different sizes at a time (Mixed Size Originals)</b></p>  <p>It is useful when preparing conference materials.</p> <p>You can set the different sized originals at one time so you don't need to reset the originals regardless of size.</p> <p>➔ <a href="#">[Mixed Size Originals] (6-7)</a></p>

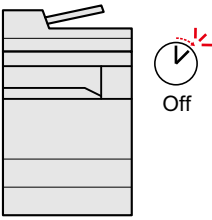
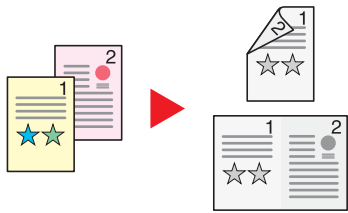
Optimize your office workflow		
<p><b>Scan a large number of originals in separate batches and produce as one job (Continuous Scan)</b></p>  <p>It is useful when preparing many-page handouts.</p> <p>When a large number of originals cannot be placed in the document processor at one time, the originals can be scanned in separate batches and then copied or sent as one job.</p> <p>➔ <a href="#">[Continuous Scan] (6-35)</a></p>	<p><b>Send one time with multiple sending options (Multi Sending)</b></p>  <p>You can send a same document to the multiple destinations using a different method.</p> <p>You can specify multiple destinations of different send methods such as E-mail, SMB, and Fax.</p> <p>You can reduce your workflow by sending a job at once.</p> <p>➔ <a href="#">Sending to Different Types of Destinations (Multi Sending) (5-23)</a></p>	<p><b>Save frequently used documents in the machine (Document Box)</b></p>  <p>You can save the frequently used document in the machine and print it when needed.</p> <p>➔ <a href="#">Using Document Boxes (3-48)</a></p>

Save energy and cost		
<p><b>Save energy as needed</b> (Energy Saver function)</p>  <p>The machine is equipped with an Energy Saver function that automatically goes to Sleep Mode. ➔ <a href="#">Energy Saver function (2-22)</a></p>	<p><b>Reduce paper use</b> (Paper Saving Printing)</p>  <p>You can print originals on both sides of the paper. You can also print multiple originals onto one sheet. ➔ <a href="#">[Combine] (6-29)</a> ➔ <a href="#">[Duplex] (6-32)</a></p>	<p><b>Skip blank pages when printing</b> (Skip Blank Page)</p>  <p>When there are blank pages in a scanned document, this function skips the blank pages and prints only pages that are not blank. ➔ <a href="#">[Skip Blank Page] (6-40)</a></p>

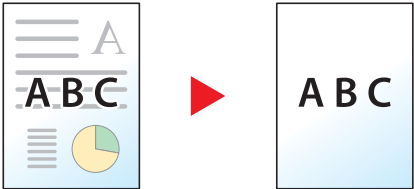
Create attractive documents
<p><b>Prevent image bleed-through</b> (Prevent Bleed-through)</p>  <p>Hides background colors and image bleedthrough ➔ <a href="#">[Prevent Bleed-through] (6-26)</a> when scanning thin original.</p>

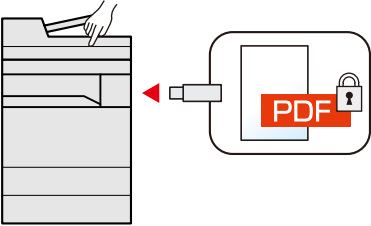
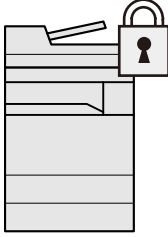
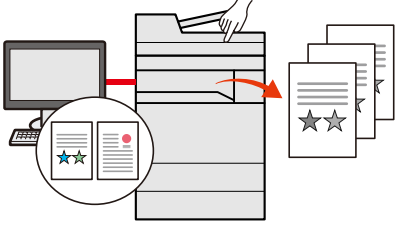

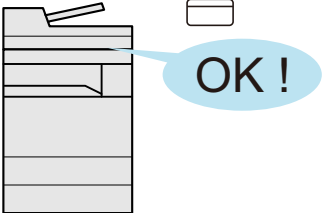
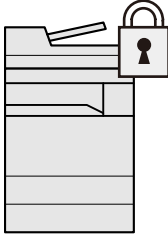
Strengthen security		
<p><b>Password-protect a PDF file</b> (PDF Encryption Functions)</p>  <p>Use the PDF format's password security options to restrict document viewing, printing and editing.</p> <p>➔ <a href="#">[Encrypted PDF Password] (6-56)</a></p>	<p><b>Protecting the Data on an SSD</b> (Encryption/Overwrite Deletion)</p>  <p>You can overwrite the unnecessary data that remains on the SSD automatically. To prevent an external leakage, the machine is able to encrypt data before writing it to the SSD.</p> <p>➔ <a href="#">[Data Security] (8-57)</a></p>	<p><b>Prevent loss of finished documents</b> (Private Print)</p>  <p>Temporarily saving print jobs in the main unit document box and outputting them when in front of the device can prevent documents from being taken by others.</p> <p>➔ <a href="#">[Printing Documents from Private Print Box (5-40)]</a></p>

Strengthen security	
<p><b>Log in by ID card</b> (Card Authentication Kit)</p>  <p>You can log in simply by touching an ID card. You don't need to enter your user name and password.</p> <p>➔ <a href="#">[Card Authentication Kit(B) &lt;Card Authentication Kit&gt; (12-3)]</a></p>	<p><b>Strengthen security (Settings for Administrator)</b></p>  <p>Various functions are available for administrators to strengthen security.</p> <p>➔ <a href="#">[Strengthening the Security by the Administrator (2-41)]</a></p>

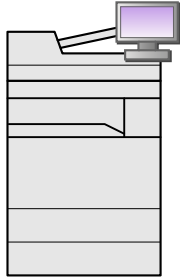
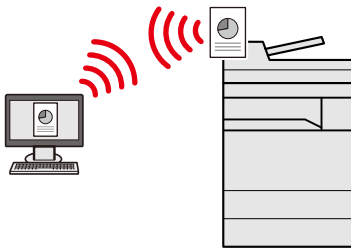
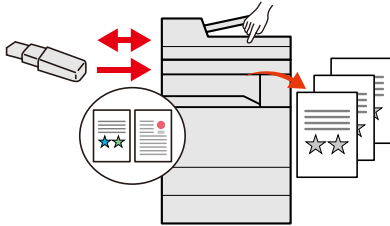
**Use functions more efficiently**

<p><b>Expand functions as necessary (Applications)</b></p>  <p>The functionality of the machine can be expanded by installing applications. Applications that help you perform your daily more efficiently such as a scan feature and an authentication feature are available.</p> <p>➔ <a href="#">Installing Applications (2-54)</a></p>	<p><b>Install the machine without concerning the network cables (Wireless Network)</b></p>  <p>If there is a wireless LAN environment, it is possible to install the unit without worrying about the network wiring.</p> <p>➔ <a href="#">Wireless Network Settings (2-15)</a>          ➔ <a href="#">Setting Wi-Fi Direct (2-19)</a>          ➔ <a href="#">Setting NFC (2-21)</a></p>	<p><b>Use USB memory</b></p>  <p>It is useful when you need to print documents outside your office or you cannot print documents from your PC. You can print the document from the USB memory by plugging it directly into the machine.</p> <p>Original scanned at the machine can be saved in the USB memory also.</p> <p>➔ <a href="#">Printing from Removable USB Memory (5-49)</a></p>
---	--	---

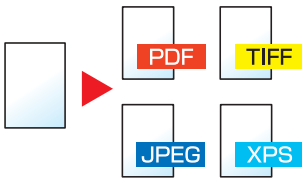
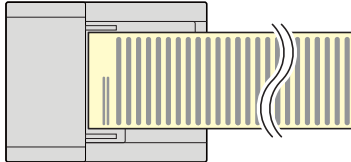



**Use functions more efficiently**

<p><b>Specify image file format (File Format)</b></p>  <p>You can select the various file formats when sending/storing images.</p> <p>➔ <a href="#">[File Format] (6-43)</a></p>	<p><b>Scan the long originals (Long Original)</b></p>  <p>You can scan the long originals such as Contract and Data log.</p> <p>➔ <a href="#">[Long Original] (6-55)</a></p>	<p><b>Perform remote operation (Command Center RX)</b></p>  <p>You can access to the machine remotely to print, send or download data. Administrators can configure the machine behavior or management settings.</p> <p>➔ <a href="#">Command Center RX (2-42)</a></p>
---	---	---

# Color and Image Quality Functions

The machine is equipped with various color and image quality functions. You can adjust the scanned image as desired.

## Basic Color Modes













Color mode	Description	Reference image		Reference page
		Before	After	
<b>Auto Color</b>	Automatically recognizes whether a document being scanned is color or black & white.			<a href="#">6-19</a>
<b>Full Color</b>	Scans a document in full color.			<a href="#">6-19</a>
<b>Grayscale</b>	Scans a document in grayscale.			<a href="#">6-19</a>
<b>Black &amp; White</b>	Scans a document in black & white.			<a href="#">6-19</a>

For details on modes that can be selected when sending/storing, refer to the information below.

➔ [\[Color Selection\] \(6-19\)](#)

## Adjusting Image Quality and Color

To adjust the image quality or color of an image, use the following functions.

I want to...	Sample image		Function	Reference Page
	Before	After		
<b>Adjust the color precisely.</b>				
Adjust the density.			Density	<a href="#">6-16</a>
<b>Adjust the image quality precisely</b>				
Emphasize or blur the image outline. Example: Emphasize the image outlines			Sharpness	<a href="#">6-22</a>
Adjust the difference between dark and light parts of the image.			Contrast	<a href="#">6-23</a>
Darken or lighten the background (the area with no texts or images) of a document. Example: Lightening the background			Background Density Adjustment	<a href="#">6-24</a>
Prevent bleed-through in 2-sided originals.			Prevent Bleed-thru	<a href="#">6-26</a>
<b>Adjust the scanned image</b>				
Decrease the file size and produce the characters clearly.			File Format [High Comp. PDF]	<a href="#">6-43</a>



# Guides Provided with the Machine

The following guides are provided with the machine. Refer to each guide as needed.

The contents of the guides are subject to change without notice for the purpose of improvement of machine performance.

## Printed guides

Start using the machine quickly



### Quick Guide

Explains how to use basic functions of the machine, how to use convenient features, how to perform routine maintenance, and what to do when problems occur.

For safe use of the machine



### Safety Guide

Provides safety and cautionary information for installation environment and use of the machine. Be sure to read this guide before using the machine.

### Safety Guide (ECOSYS M8124cidn/ECOSYS M8130cidn)

Indicates the space required for machine installation, and describes the cautionary labels and other safety information. Be sure to read this guide before using the machine.

## Guides (PDF) on the DVD (Product Library)

Use the machine thoughtfully



### Machine's Operation Guide (this Guide)

Explains how to load paper and perform copy, print and scan operations, and indicates default settings and other information.

Use the fax functions



### FAX Operation Guide

Explains how to use the fax function.

Use the ID card



### Card Authentication Kit (B) Operation Guide

Explains how to perform authentication using the ID card.

Strengthen security



### Data Security Kit (E) Operation Guide

Explains how to introduce and use the Data Security kit (E), and how to overwrite and encrypt data.

Easily register machine information and configure settings



### Command Center RX User Guide

Explains how to access the machine from a Web browser on your computer to check and change settings.

Print data from a computer



### Printer Driver User Guide

Explains how to install the printer driver and use the printer function.

Directly print a PDF file



### KYOCERA Net Direct Print Operation Guide

Explains how to print PDF files without launching Adobe Acrobat or Reader.

Monitor the machine and printers on the network



### KYOCERA Net Viewer User Guide

Explains how to monitor your network printing system (the machine) with KYOCERA Net Viewer.

**Scan images and  
save with information**



**File Management Utility User Guide**

Explains how to use File Management Utility to set various parameters and send and save scanned documents.

**Adjust the print or  
scan position**



**PRESCRIBE Commands Command Reference**

Describes the native printer language (PRESCRIBE commands).

**PRESCRIBE Commands Technical Reference**

Describes the PRESCRIBE command functions and control for each type of emulation.

Install the following versions of Adobe Reader to view the manuals on the DVD.

Version 8.0 or later

# About the Operation Guide (this Guide)

## Structure of the guide

This Operation Guide contains the following chapters.

Chapter		Description
1	<b>Safety Precautions</b>	Provides precautions regarding use of the machine and trademark information.
2	<b>Installing and Setting up the Machine</b>	This chapter provides information for the administrator of this machine, such as part names, cable connection, and software installation.
3	<b>Preparation before Use</b>	Explains preparations and settings that are required in order to use the machine, such as how to use the operation panel, how to log in and log out, how to load paper, how to create an address book, etc.
4	<b>Operation on PC</b>	Explains functions that are available when the machine is used as a printer.
5	<b>Operation on the Machine</b>	Explains the basic procedures for using the machine, such as placing originals, making copies, sending documents, and using document boxes.
6	<b>Advanced Setting of Functions</b>	Explains convenient functions that are available on the machine.
7	<b>Managing Jobs, Consumables, and Devices</b>	Explains how to check the status of a job and the job history, and how to cancel jobs being printed or waiting to print. Also explains how to check paper and toner levels, how to check the device status, and how to cancel fax transmission.
8	<b>System Menu</b>	Explains System Menu and how it relates to the operation of the machine.
9	<b>User Authentication and Accounting (User Login, Job Accounting)</b>	Explains user login and job accounting.
10	<b>Maintenance</b>	Explains daily maintenance procedures, and how to replace and replenish consumables.
11	<b>Troubleshooting</b>	Explains what to do when toner runs out, an error is displayed, or a paper jam or other problem occurs.
12	<b>Appendix</b>	Provides information on media types and paper sizes, and gives a glossary of terms. Explains how to enter characters, and lists the specifications of the machine.

# Conventions Used in This Guide

Adobe Reader XI is used as an example in the explanations below.

Click an item in the Table of Contents to jump to the corresponding page.

Click to move from the current page to the previously displayed page. This is convenient when you want to return to the page from which you jumped to the current page.

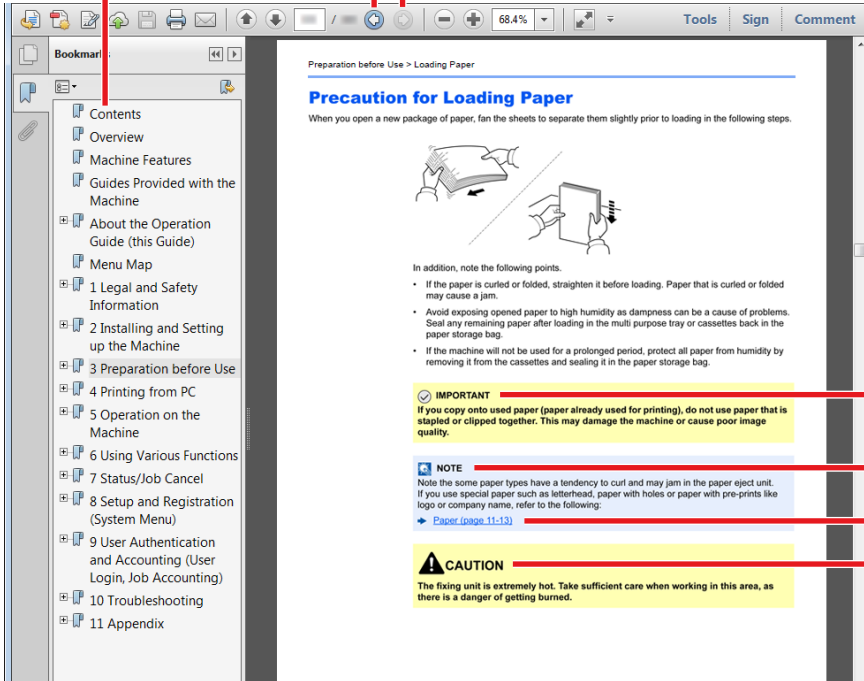

**IMPORTANT**  
Indicates operational requirements and restrictions to operate the machine correctly, and avoid damage to the machine or property.

**NOTE**  
Indicates supplemental explanations and reference information for operations.

[Refer to](#)  
Click the underlined text to jump to the corresponding page.

**CAUTION**  
Indicates that personal injury or mechanical damage may result from insufficient attention to or incorrect compliance with the related points.

**NOTE**

The items that appear in Adobe Reader vary depending on how it is used. If the Table of Contents or tools do not appear, refer to Adobe Reader Help.

Certain items are indicated in this guide by the conventions described below.

Convention	Description
[Word]	Indicates keys and buttons.
"Regular"	Indicates a message or setting.







## Conventions used in procedures for operating the machine

In this Operation Guide, continuous operation of the keys on the touch panel is as follows:

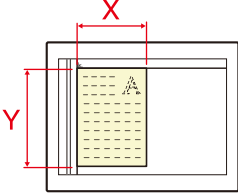
Actual procedure	Procedure indicated in this guide
Press the [System Menu / Counter] key ▼ Select [∨] ▼ Select [Common Settings] ▼ Select [Sound]	[System Menu / Counter] key > [Common Settings] > [Sound]

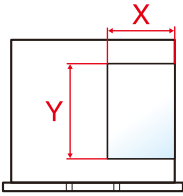
## Size and Orientation of Originals and Paper

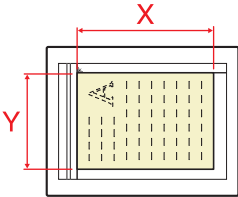
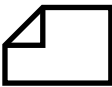
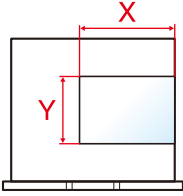
Original sizes and paper sizes such as A4, B5, and Letter can be used in both the horizontal and vertical orientations. To distinguish the orientations when these sizes are used, "R" is added to sizes used in the horizontal orientation. In addition, the following icons are used to indicate original and paper placement orientations on the touch panel.

Orientation		Setting Position (X=Length, Y=Width)	Icons on the touch panel	Indicated size in this Guide*1
Vertical	Original			A4, B5, Letter
	Paper			
Horizontal	Original			A4-R, B5-R, Letter-R
	Paper			

\*1Original/paper sizes that can be used vary depending on the function and source tray. For details, refer to the following:

➔ [Machine \(12-23\)](#)

# 1 Safety Precautions

This chapter explains the following topics:

Safety Conventions in This Guide .....	1-2
Environment .....	1-3
Precautions for Use .....	1-4
Laser Safety (Europe) .....	1-5
SAFETY OF LASER BEAM (USA) .....	1-6
Safety Instructions Regarding the Disconnection of Power .....	1-7
Compliance and Conformity .....	1-8
Other precautions (for users in California, the United States) .....	1-8
Warranty (the United States and Canada) .....	1-9
Legal Restriction on Copying/Scanning .....	1-10
EK1-ITB 2000 .....	1-10
Legal Information .....	1-10
Energy Saving Control Function .....	1-17
Automatic 2-Sided Print Function .....	1-18
Resource Saving - Paper .....	1-19
Environmental benefits of "Power Management" .....	1-20
Energy Star (ENERGY STAR®) Program .....	1-21
Wireless Connection (Mexico only) .....	1-22
Security Precautions when Using Wireless LAN (If equipped) .....	1-23
Limited Use of This Product (If equipped) .....	1-24

# Safety Conventions in This Guide

The sections of this guide and parts of the machine marked with symbols are safety warnings meant to protect the user, other individuals and surrounding objects, and ensure correct and safe usage of the machine. The symbols and their meanings are indicated below.



**WARNING:** Indicates that serious injury or even death may result from insufficient attention to or incorrect compliance with the related points.



**CAUTION:** Indicates that personal injury or mechanical damage may result from insufficient attention to or incorrect compliance with the related points.

## Symbols

The  symbol indicates that the related section includes safety warnings. Specific points of attention are indicated inside the symbol.



... [General warning]



... [Warning of high temperature]

The  symbol indicates that the related section includes information on prohibited actions. Specifics of the prohibited action are indicated inside the symbol.



... [Warning of prohibited action]



... [Disassembly prohibited]

The  symbol indicates that the related section includes information on actions which must be performed. Specifics of the required action are indicated inside the symbol.



... [Alert of required action]



... [Remove the power plug from the outlet]



... [Always connect the machine to an outlet with a ground connection]

Please contact your service representative to order a replacement if the safety warnings in this Operation Guide are illegible or if the guide itself is missing (fee required).

## Note

An original which resembles a bank note closely may not be copied properly in some rare cases because this machine is equipped with a counterfeiting prevention function.

## Environment

The service environmental conditions are as follows:

<b>Temperature</b>	10 to 32.5 °C
<b>Humidity</b>	10 to 80%

Avoid the following locations when selecting a site for the machine.

- Avoid locations near a window or with exposure to direct sunlight.
- Avoid locations with vibrations.
- Avoid locations with drastic temperature fluctuations.
- Avoid locations with direct exposure to hot or cold air.
- Avoid poorly ventilated locations.

If the floor is delicate against casters, when this machine is moved after installation, the floor material may be damaged.

During copying, some ozone is released, but the amount does not cause any ill effect to one's health. If, however, the machine is used over a long period of time in a poorly ventilated room or when making an extremely large number of copies, the smell may become unpleasant. To maintain the appropriate environment for copy work, it is suggested that the room be properly ventilated.



# Precautions for Use

## Cautions when handling consumables



Do not attempt to incinerate parts which contain toner. Dangerous sparks may cause burns.

Keep parts which contain toner out of the reach of children.

If toner happens to spill from parts which contain toner, avoid inhalation and ingestion, as well as contact with your eyes and skin.

- If you do happen to inhale toner, move to a place with fresh air and gargle thoroughly with a large amount of water. If coughing develops, contact a physician.
- If you do happen to ingest toner, rinse your mouth with water and drink 1 or 2 cups of water to dilute the contents of your stomach. If necessary, contact a physician.
- If you do happen to get toner in your eyes, flush them thoroughly with water. If there is any remaining tenderness, contact a physician.
- If toner does happen to get on your skin, wash with soap and water.

Do not attempt to force open or destroy parts which contain toner.

## Other precautions

Return the exhausted toner container and waste toner box to your dealer or service representative. The collected toner container and waste toner box will be recycled or disposed in accordance with the relevant regulations.

Store the machine while avoiding exposure to direct sunlight.

Store the machine in a place where the temperature stays below 40 °C while avoiding sharp changes of temperature and humidity.

If the machine will not be used for an extended period of time, remove the paper from the cassette and the Multi Purpose (MP) Tray, return it to its original package and reseal it.

## Laser Safety (Europe)

Laser radiation could be hazardous to the human body. For this reason, laser radiation emitted inside this machine is hermetically sealed within the protective housing and external cover. In the normal operation of the product by user, no radiation can leak from the machine.

This machine is classified as Class 1 laser product under IEC/EN 60825-1:2014.

Caution: Performance of procedures other than those specified in this manual may result in hazardous radiation exposure.

Regarding CLASS 1 laser products, information is provided on the rating label.



# SAFETY OF LASER BEAM (USA)

## 1. Safety of laser beam

This machine has been certified by the manufacturer to Class 1 level under the radiation performance standards established by the U.S.DHHS (Department of Health and Human Services) in 1968. This indicates that the product is safe to use during normal operation and maintenance. The laser optical system, enclosed in a protective housing and sealed within the external covers, never permits the laser beam to escape.

## 2. The CDRH Act

A laser-product-related act was implemented on Aug. 2, 1976, by the Center for Devices and Radiological Health (CDRH) of the U.S. Food and Drug Administration (FDA). This act prohibits the sale of laser products in the U.S. without certification, and applies to laser products manufactured after Aug. 1, 1976. The label shown below indicates compliance with the CDRH regulations and must be attached to laser products marketed in the United States. On this machine, the label is on the right.

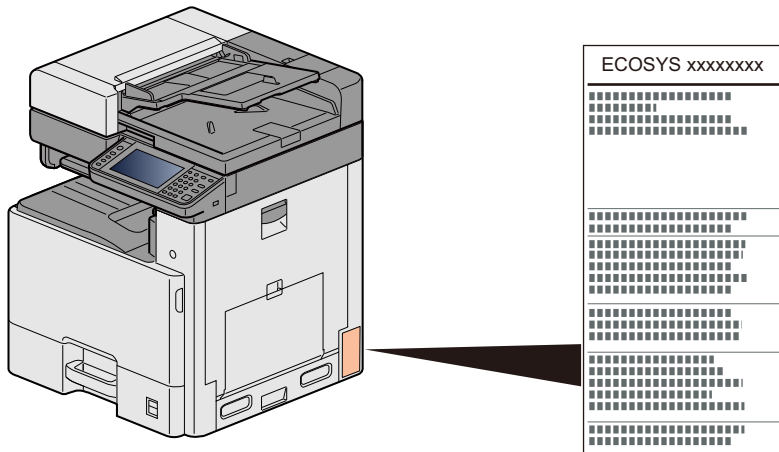

## 3. Maintenance

For safety of the service personnel, follow the maintenance instructions in the other section of this manual.

## 4. Safety switch

The power to the laser unit is cut off when the front cover is opened.

## Safety Instructions Regarding the Disconnection of Power

Caution: The power plug is the main isolation device! Other switches on the equipment are only functional switches and are not suitable for isolating the equipment from the power source.

Attention: Le débranchement de la fiche secteur est le seul moyen de mettre l'appareil hors tension. Les interrupteurs sur l'appareil ne sont que des interrupteurs de fonctionnement: ils ne mettent pas l'appareil hors tension.

# Compliance and Conformity

Hereby, KYOCERA Document Solutions Inc. declares that the radio equipment type ECOSYS M8124cidn and ECOSYS M8130cidn are in compliance with Directive 2014/53/EU.

The full text of the EU declaration of conformity is available at the following internet address:

<https://www.kyoceradocumentsolutions.eu/index/service/dlc.html>

Module name	Software Ver.	Frequency band in which the radio equipment operates:	Maximum radio-frequency power transmitted in the frequency band in which the radio equipment operates:
IB-51(option)	2.2.6	2.4GHz	100mW
IB-36(option)	2014.12	2.4GHz	100mW

This equipment has been tested and found to comply with the limits for a Class B digital device, pursuant to Part 15 of the FCC Rules.

These limits are designed to provide reasonable protection against harmful interference in a residential installation. This equipment generates, uses and can radiate radio frequency energy and, if not installed and used in accordance with the instructions, may cause harmful interference to radio communications. However, there is no guarantee that interference will not occur in a particular installation. If this equipment does cause harmful interference to radio or television reception, which can be determined by turning the equipment off and on, the user is encouraged to try to correct the interference by one or more of the following measures:

- Reorient or relocate the receiving antenna.
- Increase the separation between the equipment and receiver.
- Connect the equipment into an outlet on a circuit different from that to which the receiver is connected.
- Consult the dealer or an experienced radio/TV technician for help.
- The use of a non-shielded interface cable with the referenced device is prohibited.

CAUTION - The changes or modifications not expressly approved by the party responsible for compliance could void the user's authority to operate the equipment.

This device complies with Part 15 of FCC Rules.

Operation is subject to the following two conditions; (1) this device may not cause harmful interference, and (2) this device must accept any interference received, including interference that may cause undesired operation.

This device complies with Industry Canada licence-exempt RSS standard(s). Operation is subject to the following two conditions: (1) this device may not cause interference, and (2) this device must accept any interference, including The above statements are valid only in the United States of America and Can interference that may cause undesired operation of the device.

The antenna(s) used for this transmitter must be installed to provide a separation distance of at least 20 cm from all persons and must not be co-located or operating in conjunction with any other transmitter.

1059B-2R6A0881 is the module's certification number.

The above statements are valid only in the United States of America and Canada.

NOTE - Use shielded interface cables.

## Other precautions (for users in California, the United States)

Perchlorate Material - special handling may apply. See [www.dtsc.ca.gov/hazardouswaste/perchlorate](http://www.dtsc.ca.gov/hazardouswaste/perchlorate).

## Warranty (the United States and Canada)

### ECOSYS M8130cidn/ECOSYS M8124cidn COLOR MULTIFUNCTIONAL PRODUCT LIMITED WARRANTY

KYOCERA Document Solutions America, Inc. and KYOCERA Document Solutions Canada, Ltd. (both referred to as "KYOCERA") warrant the Customer's new Color Multifunctional Product (referred to as "MFP"), and the new accessories installed with the initial installation of the MFP, against any defects in material and workmanship for a period of one year, or 200,000 copies/prints from date of installation, whichever first occurs. In the event the MFP or an accessory is found to be defective within the warranty period, KYOCERA's only obligation and the Customer's exclusive remedy shall be replacement of any defective parts. KYOCERA shall have no obligation to furnish labor.

This warranty is valid only for the original retail purchaser (referred to as the "Customer") of a new KYOCERA MFP in the United States of America or Canada, based upon the country of purchase.

In order to obtain performance of this warranty, the Customer must immediately notify the Authorized KYOCERA Dealer from whom the product was purchased. If the KYOCERA Dealer is not able to provide service, write to KYOCERA at the address below for the name and address of the Authorized KYOCERA Dealer in your area, or check KYOCERA's website at [www.kyoceradocumentsolutions.com](http://www.kyoceradocumentsolutions.com) for KYOCERA Document Solutions America, Inc. or [www.kyoceradocumentsolutions.ca](http://www.kyoceradocumentsolutions.ca) for KYOCERA Document Solutions Canada, Ltd.

This warranty does not cover MFPs or accessories which: (a) have become damaged due to operator negligence, misuse, accidents, improper storage or unusual physical or electrical stress, (b) have used parts or supplies which are not genuine KYOCERA brand parts or supplies, (c) have been installed or serviced by a technician not employed by KYOCERA or an Authorized KYOCERA Dealer, or (d) have had the serial number modified, altered, or removed.

This warranty gives the Customer specific legal rights. The Customer may also have other rights, which vary from state to state, or province to province. Neither the seller, nor any other person, is authorized to extend the time period or expand this warranty on behalf of KYOCERA.

THIS WARRANTY IS MADE IN LIEU OF ALL OTHER WARRANTIES AND CONDITIONS, EXPRESS OR IMPLIED, AND KYOCERA SPECIFICALLY DISCLAIMS ANY IMPLIED WARRANTY OR CONDITION OF MERCHANTABILITY OR FITNESS FOR A PARTICULAR PURPOSE. THIS WARRANTY SHALL NOT EXTEND TO, AND KYOCERA SHALL NOT BE LIABLE FOR, ANY INCIDENTAL OR CONSEQUENTIAL DAMAGES WHICH MAY ARISE OUT OF THE USE OF, OR INABILITY TO USE, THE MFP.

#### **KYOCERA Document Solutions America, Inc.**

225 Sand Road,  
Fairfield, New Jersey 07004-0008, USA

#### **KYOCERA Document Solutions Canada, Ltd.**

6120 Kestrel Rd., Mississauga, ON L5T 1S8,  
Canada

## Legal Restriction on Copying/Scanning

It may be prohibited to copy/scan copyrighted material without permission of the copyright owner.

Copying/Scanning the following items is prohibited and may be penalized by law. It may not be limited to these items. Do not knowingly copy/scan the items that are not to be copied/scanned.

- Paper money
- Bank note
- Securities
- Stamp
- Passport
- Certificate

Local laws and regulations may prohibit or restrict copying/scanning of other items not mentioned above.

## EN ISO 7779

Maschinenlärminformations-Verordnung 3. GPSGV, 06.01.2004: Der höchste Schalldruckpegel beträgt 70 dB (A) oder weniger gemäß EN ISO 7779.

## EK1-ITB 2000

Das Gerät ist nicht für die Benutzung im unmittelbaren Gesichtsfeld am Bildschirmarbeitsplatz vorgesehen. Um störende Reflexionen am Bildschirmarbeitsplatz zu vermeiden, darf dieses Produkt nicht im unmittelbaren Gesichtsfeld platziert werden.

## Legal Information

Copying or other reproduction of all or part of this guide without the prior written consent of Copyright owner is prohibited.

### Regarding Trade Names

- PRESCRIBE and ECOSYS are registered trademark of Kyocera Corporation.
- KPDL is a trademark of Kyocera Corporation.
- Microsoft, Windows, Windows Vista, Windows Server, Internet Explorer, Excel and PowerPoint are registered trademarks or trademarks of Microsoft Corporation in the U.S.A. and/or other countries.
- PCL is a trademark of Hewlett-Packard Company.
- Adobe Acrobat, Adobe Reader and PostScript are trademarks of Adobe Systems, Incorporated.
- Ethernet is a registered trademark of Xerox Corporation.
- IBM and IBM PC/AT are trademarks of International Business Machines Corporation.
- AppleTalk, Bonjour, Macintosh, and Mac OS are trademarks of Apple Inc., registered in the U.S. and other countries.
- All European language fonts installed in this machine are used under licensing agreement with Monotype Imaging Inc.
- Helvetica, Palatino and Times are registered trademarks of Linotype GmbH.
- ITC Avant Garde Gothic, ITC Bookman, ITC ZapfChancery and ITC ZapfDingbats are registered trademarks of International Typeface Corporation.
- ThinPrint is a trademark of Cortado AG in Germany and other countries.

- UFST™ MicroType® fonts by Monotype Imaging Inc. are installed in this machine.
- This machine contains the software having modules developed by Independent JPEG Group.
- This product contains NetFront Browser of ACCESS CO., LTD.
- ACCESS, ACCESS logo and NetFront are trademarks or registered trademarks of ACCESS CO., LTD. in the United States, Japan and other countries.
- © 2011 ACCESS CO., LTD. All rights reserved.
- Java is a registered trademark of Oracle and/or its affiliates.
- iPad, iPhone and iPod touch are trademarks of Apple Inc., registered in the U.S. and other countries.
- AirPrint and the AirPrint logo are trademarks of Apple Inc.
- iOS is a trademark or registered trademark of Cisco in the U.S. and other countries and is used under license by Apple Inc.
- Google and Google Cloud Print™ are trademarks and/or registered trademarks of Google Inc.
- Mopria™ is registered trademarks of Mopria™ Alliance.
- Wi-Fi and Wi-Fi Direct are trademarks and/or registered trademarks of Wi-Fi Alliance.



All other brands and product names are registered trademarks or trademarks of their respective companies. The designations ™ and ® will not be used in this Operation Guide.

## GPL/LGPL

This product contains GPL (<http://www.gnu.org/licenses/gpl.html>) and/or LGPL (<http://www.gnu.org/licenses/lgpl.html>) software as part of its firmware. You can get the source code, and you are permitted to copy, redistribute and modify it under the terms of GPL/LGPL.

## OpenSSL License

Copyright (c) 1998-2006 The OpenSSL Project. All rights reserved.

Redistribution and use in source and binary forms, with or without modification, are permitted provided that the following conditions are met:

1. Redistributions of source code must retain the above copyright notice, this list of conditions and the following disclaimer.
2. Redistributions in binary form must reproduce the above copyright notice, this list of conditions and the following disclaimer in the documentation and/or other materials provided with the distribution.
3. All advertising materials mentioning features or use of this software must display the following acknowledgment: This product includes software developed by the OpenSSL Project for use in the OpenSSL Toolkit. (<http://www.openssl.org/>)”
4. The names “OpenSSL Toolkit” and “OpenSSL Project” must not be used to endorse or promote products derived from this software without prior written permission. For written permission, please contact [openssl-core@openssl.org](mailto:openssl-core@openssl.org).
5. Products derived from this software may not be called “OpenSSL” nor may “OpenSSL” appear in their names without prior written permission of the OpenSSL Project.
6. Redistributions of any form whatsoever must retain the following acknowledgment: “This product includes software developed by the OpenSSL Project for use in the OpenSSL Toolkit (<http://www.openssl.org/>)”



THIS SOFTWARE IS PROVIDED BY THE OpenSSL PROJECT "AS IS" AND ANY EXPRESSED OR IMPLIED WARRANTIES, INCLUDING, BUT NOT LIMITED TO, THE IMPLIED WARRANTIES OF MERCHANTABILITY AND FITNESS FOR A PARTICULAR PURPOSE ARE DISCLAIMED. IN NO EVENT SHALL THE OpenSSL PROJECT OR ITS CONTRIBUTORS BE LIABLE FOR ANY DIRECT, INDIRECT, INCIDENTAL, SPECIAL, EXEMPLARY, OR CONSEQUENTIAL DAMAGES (INCLUDING, BUT NOT LIMITED TO, PROCUREMENT OF SUBSTITUTE GOODS OR SERVICES; LOSS OF USE, DATA, OR PROFITS; OR BUSINESS INTERRUPTION) HOWEVER CAUSED AND ON ANY THEORY OF LIABILITY, WHETHER IN CONTRACT, STRICT LIABILITY, OR TORT (INCLUDING NEGLIGENCE OR OTHERWISE) ARISING IN ANY WAY OUT OF THE USE OF THIS SOFTWARE, EVEN IF ADVISED OF THE POSSIBILITY OF SUCH DAMAGE.

## Original SSLeay License

Copyright (C) 1995-1998 Eric Young (eay@cryptsoft.com) All rights reserved.

This package is an SSL implementation written by Eric Young (eay@cryptsoft.com). The implementation was written so as to conform with Netscapes SSL.

This library is free for commercial and non-commercial use as long as the following conditions are adhered to. The following conditions apply to all code found in this distribution, be it the RC4, RSA, lhash, DES, etc., code; not just the SSL code. The SSL documentation included with this distribution is covered by the same copyright terms except that the holder is Tim Hudson (tjh@cryptsoft.com).

Copyright remains Eric Young's, and as such any Copyright notices in the code are not to be removed.

If this package is used in a product, Eric Young should be given attribution as the author of the parts of the library used.

This can be in the form of a textual message at program startup or in documentation (online or textual) provided with the package.

Redistribution and use in source and binary forms, with or without modification, are permitted provided that the following conditions are met:

1. Redistributions of source code must retain the copyright notice, this list of conditions and the following disclaimer.
2. Redistributions in binary form must reproduce the above copyright notice, this list of conditions and the following disclaimer in the documentation and/or other materials provided with the distribution.
3. All advertising materials mentioning features or use of this software must display the following acknowledgement:  
This product includes cryptographic software written by Eric Young (eay@cryptsoft.com)  
The word 'cryptographic' can be left out if the routines from the library being used are not cryptographic related :-).
4. If you include any Windows specific code (or a derivative thereof) from the apps directory (application code) you must include an acknowledgement: "This product includes software written by Tim Hudson (tjh@cryptsoft.com)"

THIS SOFTWARE IS PROVIDED BY ERIC YOUNG "AS IS" AND ANY EXPRESS OR IMPLIED WARRANTIES, INCLUDING, BUT NOT LIMITED TO, THE IMPLIED WARRANTIES OF MERCHANTABILITY AND FITNESS FOR A PARTICULAR PURPOSE ARE DISCLAIMED. IN NO EVENT SHALL THE AUTHOR OR CONTRIBUTORS BE LIABLE FOR ANY DIRECT, INDIRECT, INCIDENTAL, SPECIAL, EXEMPLARY, OR CONSEQUENTIAL DAMAGES (INCLUDING, BUT NOT LIMITED TO, PROCUREMENT OF SUBSTITUTE GOODS OR SERVICES; LOSS OF USE, DATA, OR PROFITS; OR BUSINESS INTERRUPTION) HOWEVER CAUSED AND ON ANY THEORY OF LIABILITY, WHETHER IN CONTRACT, STRICT LIABILITY, OR TORT (INCLUDING NEGLIGENCE OR OTHERWISE) ARISING IN ANY WAY OUT OF THE USE OF THIS SOFTWARE, EVEN IF ADVISED OF THE POSSIBILITY OF SUCH DAMAGE.

The licence and distribution terms for any publically available version or derivative of this code cannot be changed. i.e. this code cannot simply be copied and put under another distribution licence [including the GNU Public Licence.]

## Monotype Imaging License Agreement

1. Software shall mean the digitally encoded, machine readable, scalable outline data as encoded in a special format as well as the UFST Software.
2. You agree to accept a non-exclusive license to use the Software to reproduce and display weights, styles and versions of letters, numerals, characters and symbols (Typefaces) solely for your own customary business or personal purposes at the address stated on the registration card you return to Monotype Imaging. Under the terms of this License Agreement, you have the right to use the Fonts on up to three printers. If you need to have access to the fonts on more than three printers, you need to acquire a multiuser license agreement which can be obtained from Monotype Imaging. Monotype Imaging retains all rights, title and interest to the Software and Typefaces and no rights are granted to you other than a License to use the Software on the terms expressly set forth in this Agreement.
3. To protect proprietary rights of Monotype Imaging, you agree to maintain the Software and other proprietary information concerning the Typefaces in strict confidence and to establish reasonable procedures regulating access to and use of the Software and Typefaces.
4. You agree not to duplicate or copy the Software or Typefaces, except that you may make one backup copy. You agree that any such copy shall contain the same proprietary notices as those appearing on the original.
5. This License shall continue until the last use of the Software and Typefaces, unless sooner terminated. This License may be terminated by Monotype Imaging if you fail to comply with the terms of this License and such failure is not remedied within thirty (30) days after notice from Monotype Imaging. When this License expires or is terminated, you shall either return to Monotype Imaging or destroy all copies of the Software and Typefaces and documentation as requested.
6. You agree that you will not modify, alter, disassemble, decrypt, reverse engineer or decompile the Software.
7. Monotype Imaging warrants that for ninety (90) days after delivery, the Software will perform in accordance with Monotype Imaging-published specifications, and the diskette will be free from defects in material and workmanship. Monotype Imaging does not warrant that the Software is free from all bugs, errors and omissions. The parties agree that all other warranties, expressed or implied, including warranties of fitness for a particular purpose and merchantability, are excluded.
8. Your exclusive remedy and the sole liability of Monotype Imaging in connection with the Software and Typefaces is repair or replacement of defective parts, upon their return to Monotype Imaging. In no event will Monotype Imaging be liable for lost profits, lost data, or any other incidental or consequential damages, or any damages caused by abuse or misapplication of the Software and Typefaces.
9. Massachusetts U.S.A. law governs this Agreement.
10. You shall not sublicense, sell, lease, or otherwise transfer the Software and/or Typefaces without the prior written consent of Monotype Imaging.
11. Use, duplication or disclosure by the Government is subject to restrictions as set forth in the Rights in Technical Data and Computer Software clause at FAR 252-227-7013, subdivision (b)(3)(ii) or subparagraph (c)(1)(ii), as appropriate. Further use, duplication or disclosure is subject to restrictions applicable to restricted rights software as set forth in FAR 52.227-19 (c)(2).
12. You acknowledge that you have read this Agreement, understand it, and agree to be bound by its terms and conditions. Neither party shall be bound by any statement or representation not contained in this Agreement. No change in this Agreement is effective unless written and signed by properly authorized representatives of each party. By opening this diskette package, you agree to accept the terms and conditions of this Agreement.

## Knopflerfish License

This product includes software developed by the Knopflerfish Project.

<http://www.knopflerfish.org>

Copyright 2003-2010 The Knopflerfish Project. All rights reserved.

Redistribution and use in source and binary forms, with or without modification, are permitted provided that the following conditions are met:

- Redistributions of source code must retain the above copyright notice, this list of conditions and the following disclaimer.

- Redistributions in binary form must reproduce the above copyright notice, this list of conditions and the following disclaimer in the documentation and/or other materials provided with the distribution.
- Neither the name of the KNOPFLERFISH project nor the names of its contributors may be used to endorse or promote products derived from this software without specific prior written permission.

THIS SOFTWARE IS PROVIDED BY THE COPYRIGHT HOLDERS AND CONTRIBUTORS "AS IS" AND ANY EXPRESS OR IMPLIED WARRANTIES, INCLUDING, BUT NOT LIMITED TO, THE IMPLIED WARRANTIES OF MERCHANTABILITY AND FITNESS FOR A PARTICULAR PURPOSE ARE DISCLAIMED. IN NO EVENT SHALL THE COPYRIGHT OWNER OR CONTRIBUTORS BE LIABLE FOR ANY DIRECT, INDIRECT, INCIDENTAL, SPECIAL, EXEMPLARY, OR CONSEQUENTIAL DAMAGES (INCLUDING, BUT NOT LIMITED TO, PROCUREMENT OF SUBSTITUTE GOODS OR SERVICES; LOSS OF USE, DATA, OR PROFITS; OR BUSINESS INTERRUPTION) HOWEVER CAUSED AND ON ANY THEORY OF LIABILITY, WHETHER IN CONTRACT, STRICT LIABILITY, OR TORT (INCLUDING NEGLIGENCE OR OTHERWISE) ARISING IN ANY WAY OUT OF THE USE OF THIS SOFTWARE, EVEN IF ADVISED OF THE POSSIBILITY OF SUCH DAMAGE.

## Apache License (Version 2.0)

Apache License

Version 2.0, January 2004

<http://www.apache.org/licenses/>

### TERMS AND CONDITIONS FOR USE, REPRODUCTION, AND DISTRIBUTION

#### 1. Definitions.

“License” shall mean the terms and conditions for use, reproduction, and distribution as defined by Sections 1 through 9 of this document.

“Licensor” shall mean the copyright owner or entity authorized by the copyright owner that is granting the License.

“Legal Entity” shall mean the union of the acting entity and all other entities that control, are controlled by, or are under common control with that entity. For the purposes of this definition, “control” means (i) the power, direct or indirect, to cause the direction or management of such entity, whether by contract or otherwise, or (ii) ownership of fifty percent (50%) or more of the outstanding shares, or (iii) beneficial ownership of such entity.

“You” (or “Your”) shall mean an individual or Legal Entity exercising permissions granted by this License.

“Source” form shall mean the preferred form for making modifications, including but not limited to software source code, documentation source, and configuration files.

“Object” form shall mean any form resulting from mechanical transformation or translation of a Source form, including but not limited to compiled object code, generated documentation, and conversions to other media types.

“Work” shall mean the work of authorship, whether in Source or Object form, made available under the License, as indicated by a copyright notice that is included in or attached to the work (an example is provided in the Appendix below).

“Derivative Works” shall mean any work, whether in Source or Object form, that is based on (or derived from) the Work and for which the editorial revisions, annotations, elaborations, or other modifications represent, as a whole, an original work of authorship. For the purposes of this License, Derivative Works shall not include works that remain separable from, or merely link (or bind by name) to the interfaces of, the Work and Derivative Works thereof.

“Contribution” shall mean any work of authorship, including the original version of the Work and any modifications or additions to that Work or Derivative Works thereof, that is intentionally submitted to Licensor for inclusion in the Work by the copyright owner or by an individual or Legal Entity authorized to submit on behalf of the copyright owner. For the purposes of this definition, “submitted” means any form of electronic, verbal, or written communication sent to the Licensor or its representatives, including but not limited to communication on electronic mailing lists, source code control systems, and issue tracking systems that are managed by, or on behalf of, the Licensor for the purpose of discussing and improving the Work, but excluding communication that is conspicuously marked or otherwise designated in writing by the copyright owner as “Not a Contribution.”

“Contributor” shall mean Licensor and any individual or Legal Entity on behalf of whom a Contribution has been received by Licensor and subsequently incorporated within the Work.

2. Grant of Copyright License. Subject to the terms and conditions of this License, each Contributor hereby grants to You a perpetual, worldwide, non-exclusive, no-charge, royalty-free, irrevocable copyright license to reproduce, prepare Derivative Works of, publicly display, publicly perform, sublicense, and distribute the Work and such Derivative Works in Source or Object form.
3. Grant of Patent License. Subject to the terms and conditions of this License, each Contributor hereby grants to You a perpetual, worldwide, non-exclusive, no-charge, royalty-free, irrevocable (except as stated in this section) patent license to make, have made, use, offer to sell, sell, import, and otherwise transfer the Work, where such license applies only to those patent claims licensable by such Contributor that are necessarily infringed by their Contribution(s) alone or by combination of their Contribution(s) with the Work to which such Contribution(s) was submitted. If You institute patent litigation against any entity (including a cross-claim or counterclaim in a lawsuit) alleging that the Work or a Contribution incorporated within the Work constitutes direct or contributory patent infringement, then any patent licenses granted to You under this License for that Work shall terminate as of the date such litigation is filed.
4. Redistribution. You may reproduce and distribute copies of the Work or Derivative Works thereof in any medium, with or without modifications, and in Source or Object form, provided that You meet the following conditions:
  - (a) You must give any other recipients of the Work or Derivative Works a copy of this License; and
  - (b) You must cause any modified files to carry prominent notices stating that You changed the files; and
  - (c) You must retain, in the Source form of any Derivative Works that You distribute, all copyright, patent, trademark, and attribution notices from the Source form of the Work, excluding those notices that do not pertain to any part of the Derivative Works; and

(d) If the Work includes a “NOTICE” text file as part of its distribution, then any Derivative Works that You distribute must include a readable copy of the attribution notices contained within such NOTICE file, excluding those notices that do not pertain to any part of the Derivative Works, in at least one of the following places: within a NOTICE text file distributed as part of the Derivative Works; within the Source form or documentation, if provided along with the Derivative Works; or, within a display generated by the Derivative Works, if and wherever such third-party notices normally appear. The contents of the NOTICE file are for informational purposes only and do not modify the License. You may add Your own attribution notices within Derivative Works that You distribute, alongside or as an addendum to the NOTICE text from the Work, provided that such additional attribution notices cannot be construed as modifying the License.

You may add Your own copyright statement to Your modifications and may provide additional or different license terms and conditions for use, reproduction, or distribution of Your modifications, or for any such Derivative Works as a whole, provided Your use, reproduction, and distribution of the Work otherwise complies with the conditions stated in this License.

5. **Submission of Contributions.** Unless You explicitly state otherwise, any Contribution intentionally submitted for inclusion in the Work by You to the Licensor shall be under the terms and conditions of this License, without any additional terms or conditions. Notwithstanding the above, nothing herein shall supersede or modify the terms of any separate license agreement you may have executed with Licensor regarding such Contributions.
6. **Trademarks.** This License does not grant permission to use the trade names, trademarks, service marks, or product names of the Licensor, except as required for reasonable and customary use in describing the origin of the Work and reproducing the content of the NOTICE file.
7. **Disclaimer of Warranty.** Unless required by applicable law or agreed to in writing, Licensor provides the Work (and each Contributor provides its Contributions) on an “AS IS” BASIS, WITHOUT WARRANTIES OR CONDITIONS OF ANY KIND, either express or implied, including, without limitation, any warranties or conditions of TITLE, NON-INFRINGEMENT, MERCHANTABILITY, or FITNESS FOR A PARTICULAR PURPOSE. You are solely responsible for determining the appropriateness of using or redistributing the Work and assume any risks associated with Your exercise of permissions under this License.
8. **Limitation of Liability.** In no event and under no legal theory, whether in tort (including negligence), contract, or otherwise, unless required by applicable law (such as deliberate and grossly negligent acts) or agreed to in writing, shall any Contributor be liable to You for damages, including any direct, indirect, special, incidental, or consequential damages of any character arising as a result of this License or out of the use or inability to use the Work (including but not limited to damages for loss of goodwill, work stoppage, computer failure or malfunction, or any and all other commercial damages or losses), even if such Contributor has been advised of the possibility of such damages.
9. **Accepting Warranty or Additional Liability.** While redistributing the Work or Derivative Works thereof, You may choose to offer, and charge a fee for, acceptance of support, warranty, indemnity, or other liability obligations and/or rights consistent with this License. However, in accepting such obligations, You may act only on Your own behalf and on Your sole responsibility, not on behalf of any other Contributor, and only if You agree to indemnify, defend, and hold each Contributor harmless for any liability incurred by, or claims asserted against, such Contributor by reason of your accepting any such warranty or additional liability.

END OF TERMS AND CONDITIONS

APPENDIX: How to apply the Apache License to your work.

To apply the Apache License to your work, attach the following boilerplate notice, with the fields enclosed by brackets “[]” replaced with your own identifying information. (Don't include the brackets!) The text should be enclosed in the appropriate comment syntax for the file format. We also recommend that a file or class name and description of purpose be included on the same “printed page” as the copyright notice for easier identification within third-party archives.

Copyright [yyyy] [name of copyright owner]

Licensed under the Apache License, Version 2.0 (the “License”); you may not use this file except in compliance with the License. You may obtain a copy of the License at

<http://www.apache.org/licenses/LICENSE-2.0>

Unless required by applicable law or agreed to in writing, software distributed under the License is distributed on an “AS IS” BASIS, WITHOUT WARRANTIES OR CONDITIONS OF ANY KIND, either express or implied. See the License for the specific language governing permissions and limitations under the License.

## Energy Saving Control Function

The device comes equipped with a Low Power Mode where energy consumption is reduced after a certain amount of time elapses since the device was last used, as well as a Sleep where printer and fax functions remain in a waiting state but power consumption is still reduced to a minimum when there is no activity with the device within a set amount of time.

➔ [Low Power Mode \(2-22\)](#)

➔ [Sleep \(2-23\)](#)

## Automatic 2-Sided Print Function

This device includes 2-sided printing as a standard function. For example, by printing two 1-sided originals onto a single sheet of paper as a 2-sided print, it is possible to lower the amount of paper used.

➔ [\[Duplex\] \(6-32\)](#)

Printing in duplex mode reduces paper consumption and contributes to the conservation of forest resources. Duplex mode also reduces the amount of paper that must be purchased, and thereby reduces cost. It is recommended that machines capable of duplex printing be set to use duplex mode by default.

## Resource Saving - Paper

For the preservation and sustainable use of forest resources, it is recommended that recycled as well as virgin paper certified under environmental stewardship initiatives or carrying recognized ecolabels, which meet EN 12281:2002\* or an equivalent quality standard, be used.

This machine also supports printing on 64 g/m<sup>2</sup> paper. Using such paper containing less raw materials can lead to further saving of forest resources.

EN12281:2002 "Printing and business paper - Requirements for copy paper for dry toner imaging processes"

Consult your dealer or service representative for recommended paper types.



## Environmental benefits of "Power Management"

To reduce power consumption when idle, this machine is equipped with a power management function that automatically activates energy-saving mode when the machine is idle for a certain period of time. Although it takes the machine a slight amount of time to return to READY mode when in energy-saving mode, a significant reduction in energy consumption is possible. It is recommended that the machine be used with the activation time for energy-saving mode set to the default setting.

## Energy Star (ENERGY STAR®) Program



We have determined as a participating company in the International Energy Star Program that this product is compliant with the standards laid out in the International Energy Star Program.

## Wireless Connection (Mexico only)

The operation of this equipment is subject to the following two conditions:

(1) it is possible that this equipment or device may not cause harmful interference, and (2) this equipment or device must accept any interference, including interference that may cause undesired operation.

## Security Precautions when Using Wireless LAN (If equipped)

Wireless LAN allows information to be exchanged between wireless access points instead of using a network cable, which offers the advantage that a WLAN connection can be established freely within an area in which radio waves can be transmitted.

On the other hand, the following problems may occur if security settings are not configured, because radio waves can pass through obstacles (including walls) and reach everywhere within a certain area.

### Secretly Viewing Communication Contents

A third person with malicious objectives may intentionally monitor radio waves and gain unauthorized access to the following communication contents.

- Personal information including ID, passwords, and credit card numbers
- Contents of email messages

### Illegal Intrusion

A third party with malicious intent may gain unauthorized access to personal or company networks and conduct the following illegal actions.

- Extracting personal and confidential information (information leak)
- Entering into communication while impersonating a specific person and distributing unauthorized information (spoofing)
- Modifying and retransmitting intercepted communications (falsification)
- Transmitting computer viruses and destroying data and systems (destruction)

Wireless LAN cards and wireless access points contain built-in security mechanisms to address these problems and to reduce the possibility of these problems occurring by configuring the security settings of wireless LAN products when the product is used.

We recommend that customers take responsibility and use their judgment when configuring the security settings and that they ensure that they fully understand the problems that can occur when the product is used without configuring the security settings.

## Limited Use of This Product (If equipped)

- Radio waves transmitted from this product may affect medical equipment. When using this product in a medical institution or in the vicinity of medical instruments, either use this product according to the instructions and precautions provided by the administrator of the institution or those provided on the medical instruments.
- Radio waves transmitted from this product may affect automatic control equipment including automatic doors and fire alarms. When using this product in the vicinity of the automatic control equipment, use this product according to the instructions and precautions provided on the automatic control equipment.
- If this product is used in devices that are directly related to service including airplanes, trains, ships, and automobiles or this product is used in applications requiring high reliability and safety to function and in devices requiring accuracy including those used in disaster prevention and crime prevention and those used for various safety purposes, please use this product after considering the safety design of the entire system including adoption of a failsafe design and redundancy design for reliability and safety maintenance of the entire system. This product is not intended for use in applications requiring high reliability and safety including aerospace instruments, trunk communication equipment, nuclear power control equipment, and medical equipment; hence, the decision as to whether to use this product in these applications needs to be fully considered and determined.

# 2 Installing and Setting up the Machine

This chapter explains the following topics:

Part Names (Machine Exterior) .....	2-3
Part Names (Connectors/Interior) .....	2-5
Part Names (With Optional Equipments Attached) .....	2-6
Connecting the Machine and Other Devices .....	2-7
Connecting cable .....	2-9
Connecting LAN Cable .....	2-9
Connecting USB Cable .....	2-9
Connecting the Power Cable .....	2-9
Power On/Off .....	2-10
Power On .....	2-10
Power Off .....	2-10
Default Settings of the Machine .....	2-11
Setting Date and Time .....	2-12
Network settings .....	2-13
Configuring the Wired Network .....	2-13
Wireless Network Settings .....	2-15
Setting Wi-Fi Direct .....	2-19
Setting NFC .....	2-21
Energy Saver function .....	2-22
Low Power Mode .....	2-22
Energy Saver Recovery Level .....	2-22
Sleep .....	2-23
Auto Sleep .....	2-23
Sleep Rules (models for Europe) .....	2-23
Sleep Level (Energy Saver) (models except for Europe) .....	2-24
Quick Setup Wizard .....	2-25
Installing Software .....	2-27
Software on DVD (Windows) .....	2-27
Installing Software in Windows .....	2-28
Uninstalling the Software .....	2-34
Installing Software on a Mac Computer .....	2-35
Setting TWAIN Driver .....	2-37
Setting WIA Driver .....	2-39
Installing the WSD Driver .....	2-40
Strengthening the Security by the Administrator .....	2-41
Command Center RX .....	2-42
Accessing Command Center RX .....	2-42
Changing Security Settings .....	2-43
Changing Device Information .....	2-44
Setting SMTP and E-mail .....	2-45
Migrating the Address Book .....	2-49
Backing Up Address Book Data to PC .....	2-49
Writing Address Book Data to the Machine .....	2-51
Application .....	2-54
Installing Applications .....	2-54

Uninstalling Applications ..... 2-55

## Part Names (Machine Exterior)

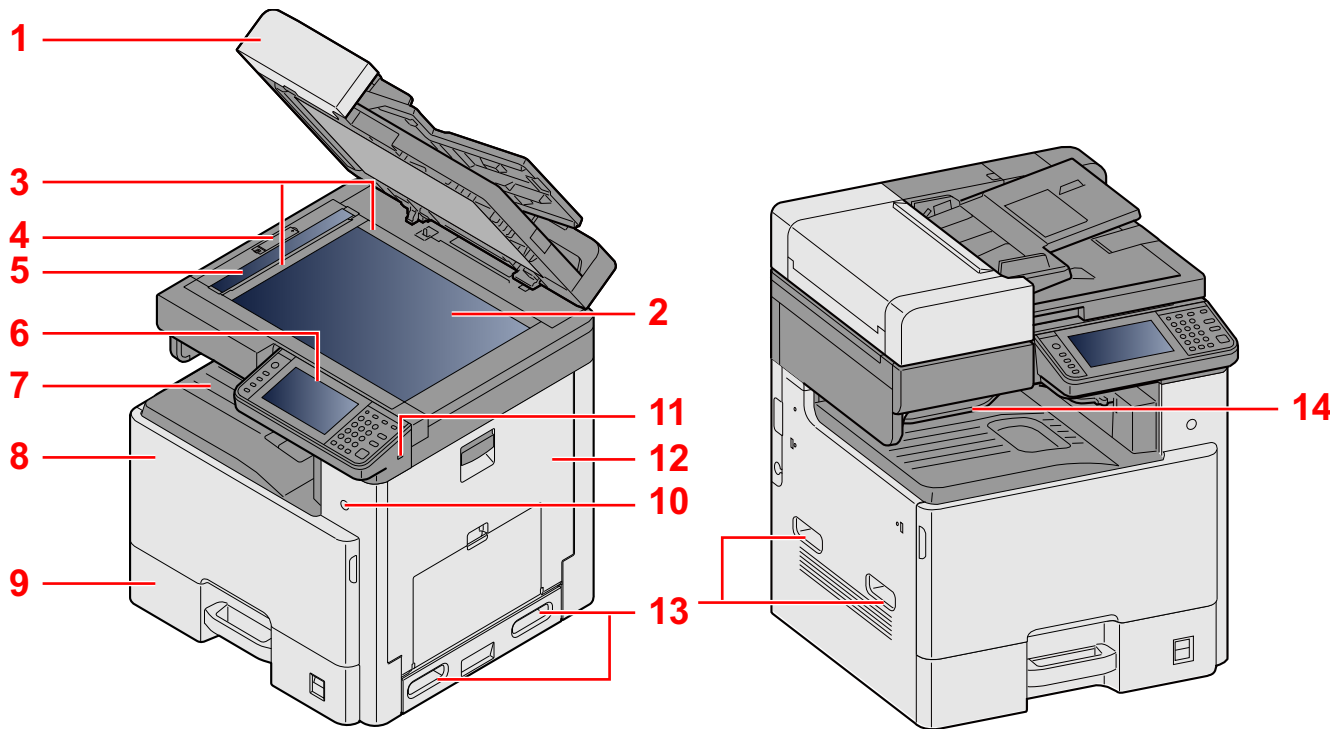

- 1 Document Processor
- 2 Platen
- 3 Original Size Indicator Plates
- 4 Optical Lock Cover
- 5 Slit Glass
- 6 Operation Panel
- 7 Inner Tray
- 8 Front Cover
- 9 Cassette 1
- 10 Power Switch
- 11 USB Memory Slot (A1)
- 12 Right Cover 1
- 13 Handles
- 14 Job Separator Tray



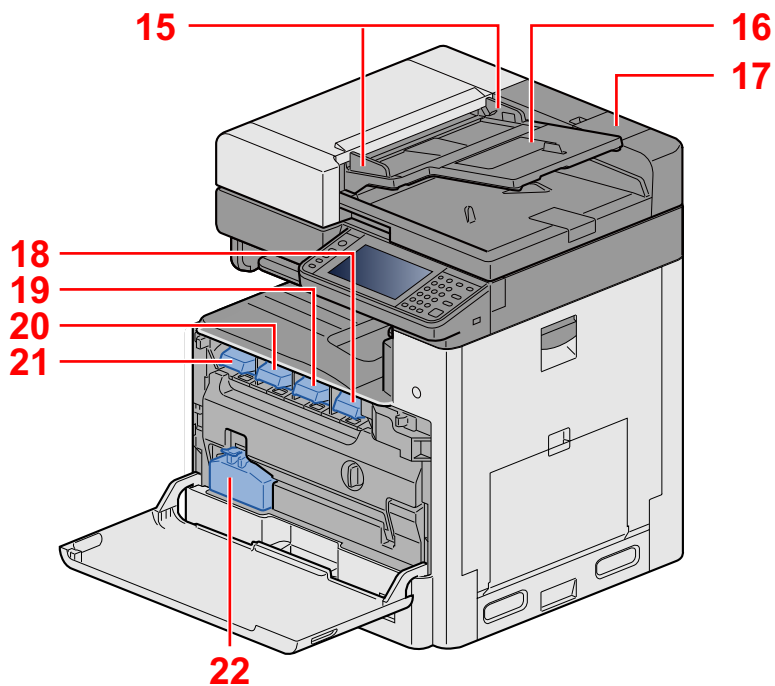

- 15 Original width guides
- 16 Original table
- 17 Cleaning Cloth Compartment
- 18 Toner Container (Black)
- 19 Toner Container (Magenta)

- 20 Toner Container (Cyan)
- 21 Toner Container (Yellow)
- 22 Waste Toner Box

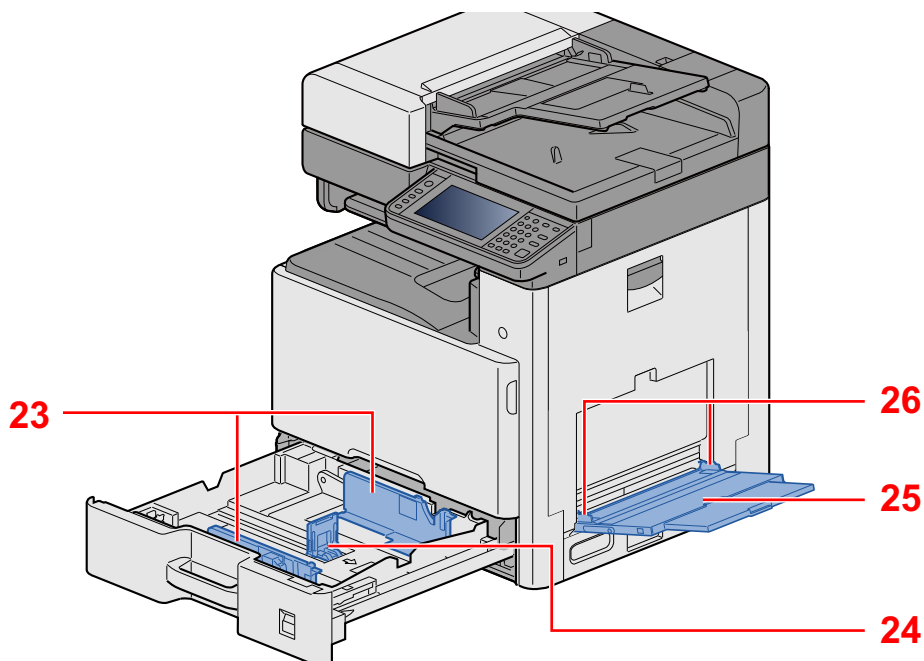

- 23 Paper Width Guide
- 24 Paper Length Guide
- 25 Multi Purpose Tray
- 26 Paper Width Guide

## Part Names (Connectors/Interior)

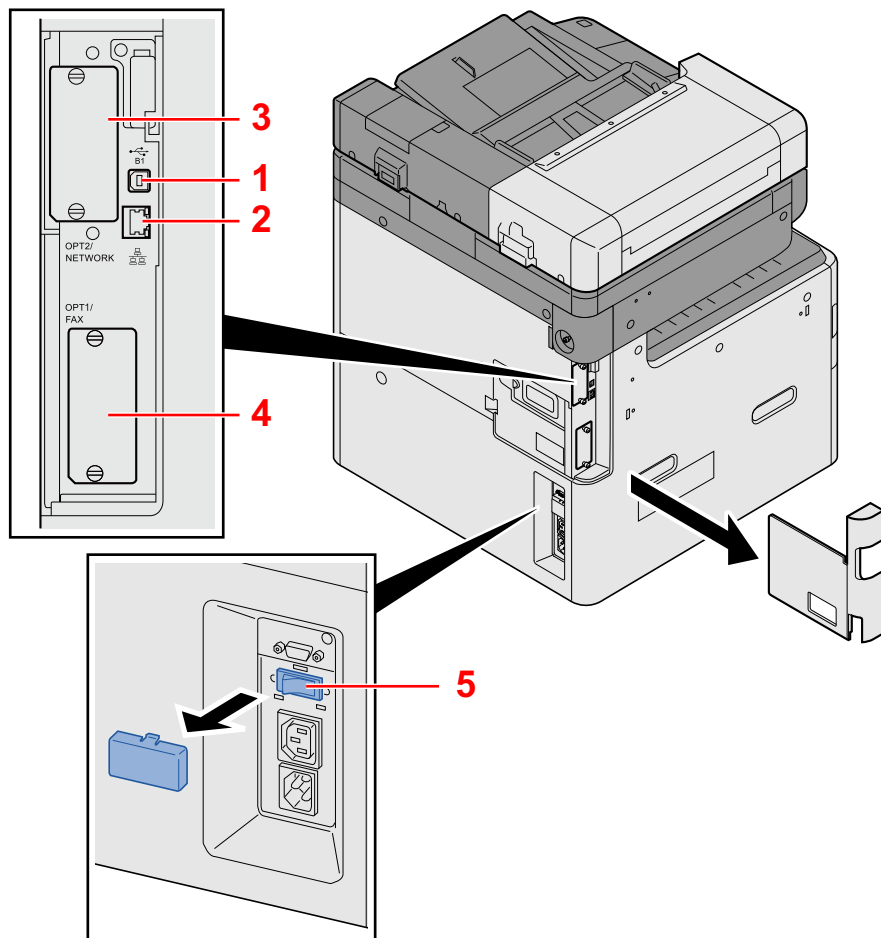

- 1 USB Interface Connector (B1)
- 2 Network Interface Connector
- 3 Option Interface Slot 2
- 4 Option Interface Slot 1
- 5 Cassette Heater switch

## Part Names (With Optional Equipments Attached)

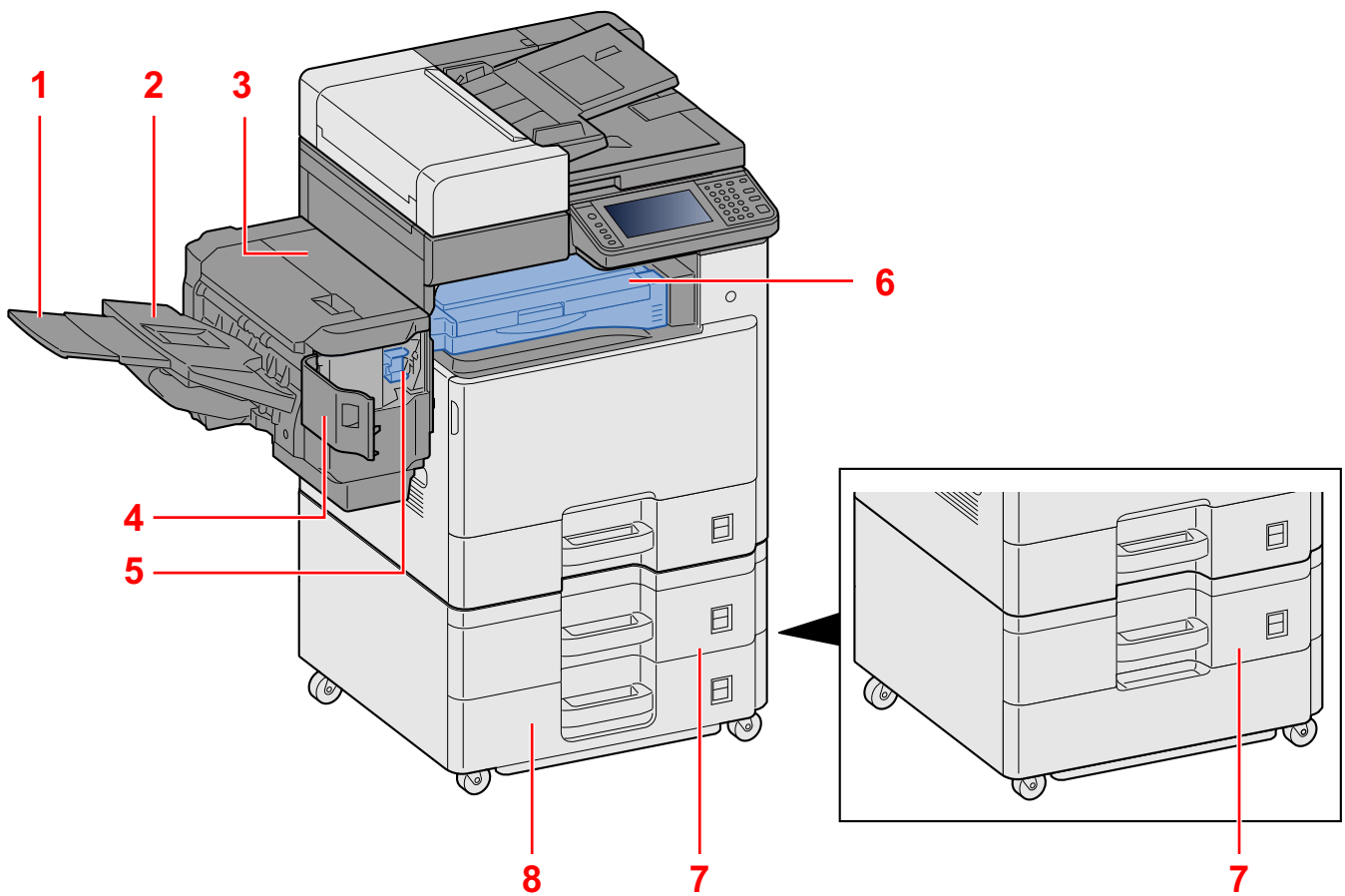

- 1 Support Tray
- 2 Finisher Tray
- 3 Top cover
- 4 Staple Cover
- 5 Staple Cartridge Holder
- 6 Bridge Unit Cover
- 7 Cassette 2
- 8 Cassette 3

# Connecting the Machine and Other Devices

Prepare the cables necessary to suit the environment and purpose of the machine use.

## When Connecting the Machine to the PC via USB

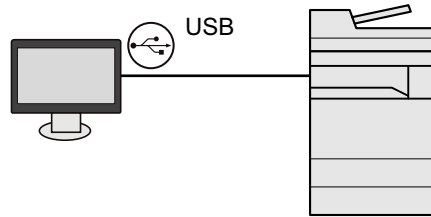

## When Connecting the Machine to the PC or Tablet by network cable, Wi-Fi, or Wi-Fi direct

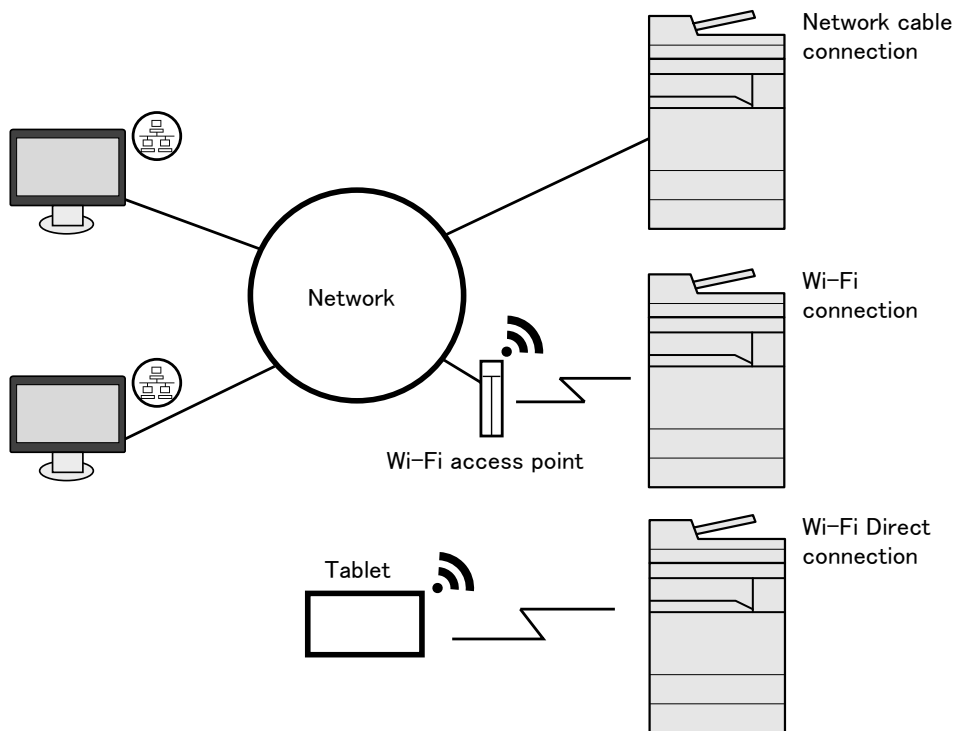

### NOTE

If you are using wireless LAN, refer to the following.

➔ [Wireless Network Settings \(2-15\)](#)

## Cables that Can Be Used

Connection Environment	Function	Necessary Cable
Connect a LAN cable to the machine.	Printer/Scanner/Network FAX <sup>*1</sup>	LAN cable (10BASE-T, 100BASE-TX, 1000BASE-T)
Connect a USB cable to the machine.	Printer	USB 2.0 compatible cable (Hi-Speed USB compliant, Max. 5.0 m)

\*1 Only on products with the fax function installed. For more information on using the Network FAX, refer to the FAX Operation Guide.



### IMPORTANT

Using a cable other than a USB 2.0 compatible cable may cause failure.

# Connecting cable

## Connecting LAN Cable

### 1 Connect the cable to the machine.

- 1 Connect the LAN cable to the network interface connector.

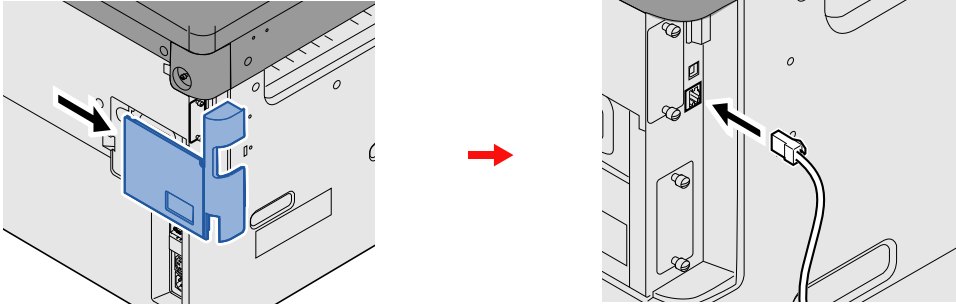

- 2 Connect the other end of the cable to the hub.

### 2 Configuring Network Settings

→ [Network settings \(2-13\)](#)

## Connecting USB Cable

### 1 Connect the cable to the machine.

- 1 Connect the USB cable to the USB interface connector located on the left side of the body.

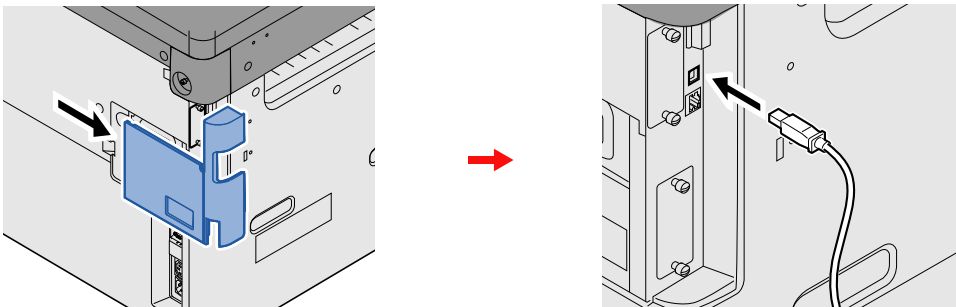

- 2 Connect the other end of the cable to the PC.

## Connecting the Power Cable

### 1 Connect the cable to the machine.

Connect one end of the supplied power cable to the machine and the other end to a power outlet.

 **IMPORTANT**

Only use the power cable that comes with the machine.

# Power On/Off

## Power On

- 1 Turn the power switch on.

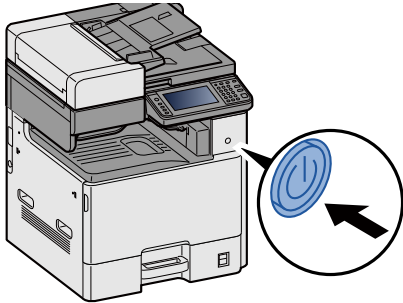

## Power Off

- 1 Turn the power switch off.

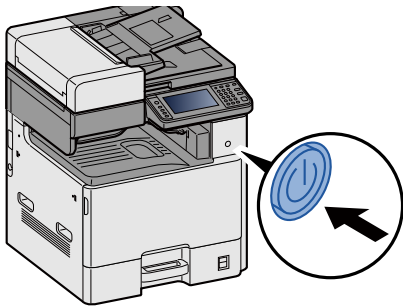

- 2 Select [Yes] in the confirmation screen.

It takes a few minutes for power off.



### CAUTION

If this machine will be left unused for an extended period (e.g. overnight), turn it off at the main power switch. If the machine will not be used for an even longer period of time (e.g. vacation), remove the power plug from the outlet as a safety precaution.



### IMPORTANT

- If using the products equipped with the fax function, note that turning the machine off at the main power switch disables fax transmission and reception.
- Remove paper from the cassettes and seal it in the paper storage bag to protect it from humidity.

## Default Settings of the Machine

Before using this machine, configure such settings as date and time, network configuration, and energy saving functions as needed. The Machine Setup Wizard is launched when the equipment is turned on for the first time after being installed. Also, configure the following settings if necessary.



### NOTE

The default settings of the machine can be changed in System Menu.

For settings that are configurable from System Menu, refer to the following:

▶ [System Menu \(8-1\)](#)



# Setting Date and Time

Follow the steps below to set the local date and time at the place of installation.

When you send an E-mail using the transmission function, the date and time as set here will be printed in the header of the E-mail message. Set the date, time and time difference from GMT of the region where the machine is used.



## NOTE

To make changes after this initial configuration, refer to the following:

➔ [\[Date/Timer/Energy Saver\] \(8-60\)](#)

The correct time can be periodically set by obtaining the time from the network time server.

➔ [Command Center RX User Guide](#)

## 1 Display the screen.

[System Menu / Counter] key > [Date/Timer/Energy Saver]

## 2 Configure the settings.

Select and set in the order [Time Zone] > [Date/Time] > [Date Format]

Item	Description
<b>Time Zone</b>	Set the time difference from GMT. Choose the nearest listed location from the list. If you select a region that utilizes summer time, configure settings for summer time.
<b>Date/Time</b>	Set the date and time for the location where you use the machine. If you perform Send as E-mail, the date and time set here will be displayed on the header. <b>Value:</b> Year (2000 to 2037), Month (1 to 12), Day (1 to 31), Hour (00 to 23), Minute (00 to 59), Second (00 to 59)
<b>Date Format</b>	Select the display format of year, month, and date. The year is displayed in Western notation. <b>Value:</b> Month/Day/Year, Day/Month/Year, Year/Month/Day

# Network settings

## Configuring the Wired Network

The machine is equipped with network interface, which is compatible with network protocols such as TCP/IP (IPv4), TCP/IP (IPv6), NetBEUI, and IPSec. It enables network printing on the Windows, Macintosh, UNIX and other platforms. Set up TCP/IP (IPv4) to connect to the Windows network.

The configuration methods are as follows

Configuration Method	Description	Reference Page
Configuring the Connection from the Operation Panel on This Machine	Use Quick Setup Wizard when configuring the network in a wizard-style screen, without setting individually in System menu.	<a href="#">Quick Setup Wizard (2-25)</a>
Configuring Connections on the Web Page	For the equipped network interface, the connection can be set by using Command Center RX. For the optional IB-50, the connection can be set by using the dedicated Web page.	Command Center RX User Guide IB-50 Operation Guide
Setting the Connection by Using the Setup Utility of IB-50	This is the setup tool included in the CD of IB-50. You can use it on Windows.	IB-50 Operation Guide

For other network settings, refer to the following:

➔ [\[Network\] \(8-35\)](#)

### NOTE

If user login administration is enabled, you can only change the settings by logging in with administrator privileges.

If user login administration is disabled, the user authentication screen appears. Enter a login user name and password, and select [Login].

The factory default login user name and login password are set as shown below.

Login user name

ECOSYS M8124cidn:2400, ECOSYS M8130cidn:3000

Login Password

ECOSYS M8124cidn:2400, ECOSYS M8130cidn:3000

### NOTE

Ask your network administrator for the IP address in advance, and have it ready when you configure this setting.

The following cases, set the IP address of DNS server on the Command Center RX.

- When using the host name with "DHCP" setting set to [Off]
- When using the DNS server with IP address that is not assigned by DHCP automatically

Setting the IP Address of the DNS Server, refer to the following:

➔ [Command Center RX User Guide](#)

## 1 Display the screen.

[System Menu / Counter] key > [System/Network] > Enter a login user name and password > [Login] > [Network] > [Wired Network Settings] > [TCP/IP Settings] > [IPv4 Settings]

## 2 Configure the settings.

### When using DHCP server

[DHCP]: [On]

### When setting the static IP address

[DHCP]: [Off]

[IP Address]: Enter the address.

[Subnet Mask]: Enter the subnet mask in decimal representation (0 to 255).

[Default Gateway]: Enter the address.

[Auto-IP]: [Off]



#### NOTE

When using the Auto-IP, enter "0.0.0.0" in IP Address.



#### IMPORTANT

After changing the setting, restart the network from System Menu, or turn the machine OFF and then ON.

➔ [\[Restart Network\] \(8-51\)](#)

# Wireless Network Settings

When the optional Wireless Network Interface Kit (IB-36 and IB-51) is installed on the machine and the connection settings are configured, it is possible to print in a wireless network (wireless LAN) environment.

The configuration methods are as follows

Configuration Method	Description	Reference Page
Configuring the Connection from the Operation Panel on This Machine	Use Quick Setup Wizard when configuring the network in a wizard-style screen, without setting individually in System menu.	<a href="#">Quick Setup Wizard (2-25)</a>
	Use Wi-Fi Settings or Wireless Network to configure the network in details from System menu.	<a href="#">[Wi-Fi Settings] (8-36)</a> <a href="#">[Wireless Network] (8-53)</a>
Setting the Connection by Using the Wi-Fi Setup Tool	This is the tool included in the Product Library. You can configure the connection according to the instructions provided by the wizard.	<a href="#">Setting the Connection by Using the Wi-Fi Setup Tool (2-15)</a>
Configuring Connections on the Web Page	For the IB-36, the connection can be set from the Command Center RX.	Command Center RX User Guide
	For the IB-51, the connection can be set by using the dedicated web page.	IB-51 Operation Guide
Setting the Connection by Using the Setup Utility of IB-51	This is the setup tool included in the CD of IB-51. You can use it on both Windows and Mac OS.	IB-51 Operation Guide



## NOTE

- The Wireless Network Interface Kit (IB-36) is an option for some models and the Wireless Network Interface Kit (IB-51) is a standard option. Contact your dealer or our sales or service representative for detail.
- ➔ [IB-36 <Wireless Network Interface Kit> \(12-3\)](#)
- ➔ [IB-51 <Wireless Network Interface Kit> \(12-10\)](#)
- When you want to switch to the network interface other than Wired (default) after installing an optional Network Interface Kit (IB-50) and a Wireless Interface Kit (IB-36 or IB-51), select the desired setting on "Primary Network (Client)".
- ➔ [\[Primary Network \(Client\)\] \(8-54\)](#)

## Setting the Connection by Using the Wi-Fi Setup Tool

To send the Wi-Fi settings configured in the Wi-Fi Setup Tool to the machine, connect the computer or handheld device with the machine locally. The connection methods are wired connection via LAN cable and wireless LAN connection (Wi-Fi Direct).



## NOTE

- To use Wi-Fi Direct, confirm that the Wi-Fi Direct is enabled (Wi-Fi Direct is set to [On]) and Restart Network from the operation panel, before your computer will be connected to this machine with Wi-Fi Direct.
- To use a wired LAN cable directly connected to the machine, the Auto-IP (Link-local) address will be assigned to the machine and the computer. This machine applies Auto-IP as the default settings.
- Configure the settings on the operation panel if your computer supports WPS.

[\[Wi-Fi Settings\] \(8-36\)](#)

[\[Wireless Network\] \(8-53\)](#)

## Wired Connection by Using LAN Cable

### 1 Connect the machine with a computer.

- 1 Connect the machine with a computer via LAN cable when the machine is powered on.
- 2 Turn on the computer.  
IP address (link local address) of the machine and computer is generated automatically.

### 2 Insert the DVD.

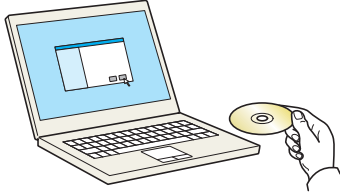

#### NOTE

- Installation on Windows must be done by a user logged on with administrator privileges.
- If the "Welcome to the Found New Hardware Wizard" dialog box displays, select [Cancel].
- If the auto run screen is displayed, click [Run setup.exe].
- If the user account management window appears, click [Yes (Allow)].

### 3 Display the screen.

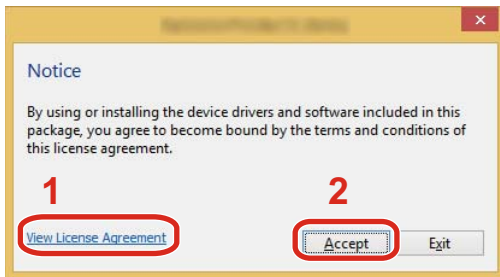

- 1 Click [View License Agreement] and read the License Agreement.
- 2 Click [Accept].

### 4 Select [Maintenance].

### 5 [Wi-Fi Setup Tool] > [OK]

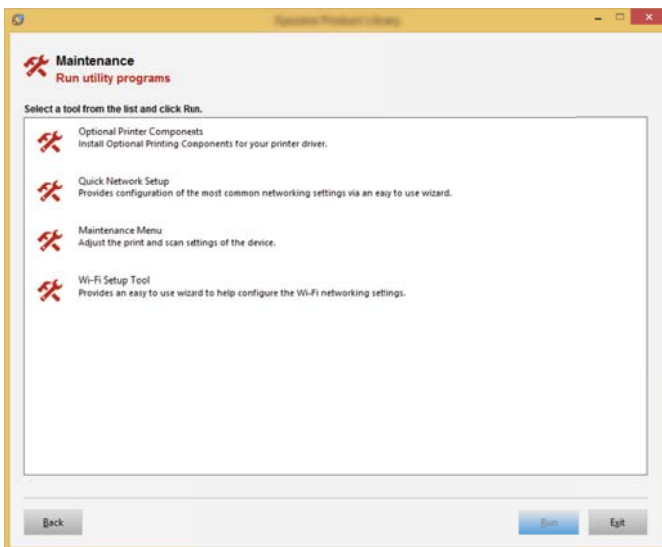

## 6 Configure the settings.

1 [Do not use automatic configuration] > [Next] > [Next]

2 [Use LAN cable] > [Next] > [Next]

3 [Easy setup] > [Next]

The machine is detected.



### NOTE

- Only one machine can be searched using Wi-Fi Setup Tool. It may take times to search the machine.
- If the machine is not detected, select [Advanced setup] > [Next]. Select [Express] or [Custom] as device discovery method and specify the IP address or host name to search the machine.

4 Select the machine > [Next].

5 Select [Use the device settings.] on [Authentication mode], and enter [Login User Name] and [Login Password] > [Next]. The login user name and password are both Admin.

6 Configure the communication settings > [Next].

7 Change the settings of access point as necessary > [Next].

The network is configured.

### Wireless LAN Connection by Using Wi-Fi Direct

#### 1 Display the screen.

[System Menu / Counter] key > [System/Network] > Enter a login user name and password > [Login] > [Network] > [Wi-Fi Direct Settings] > [Wi-Fi Direct]

#### 2 Configure the settings.

[On] > [OK]

#### 3 Restart the network.

[System Menu / Counter] key > [System/Network] > [Network] > [Restart Network]

#### 4 Connect a computer or a handheld device with the machine.

[Setting Wi-Fi Direct \(2-19\)](#)

## 5 Insert the DVD.

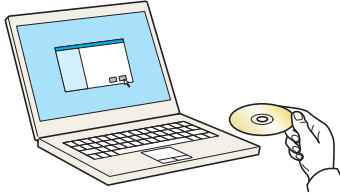

### NOTE

- Installation on Windows must be done by a user logged on with administrator privileges.
- If the "Welcome to the Found New Hardware Wizard" dialog box displays, select [Cancel].
- If the auto run screen is displayed, click [Run setup.exe].
- If the user account management window appears, click [Yes (Allow)].

## 6 Display the screen.

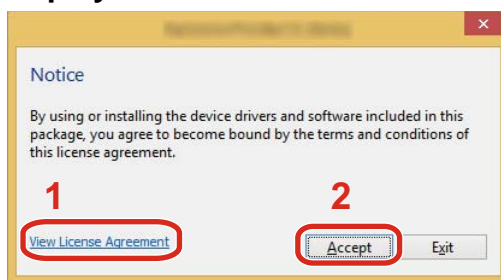

- 1 Click [View License Agreement] and read the License Agreement.
- 2 Click [Accept].

## 7 Select [Maintenance].

## 8 [Wi-Fi Setup Tool] > [OK]

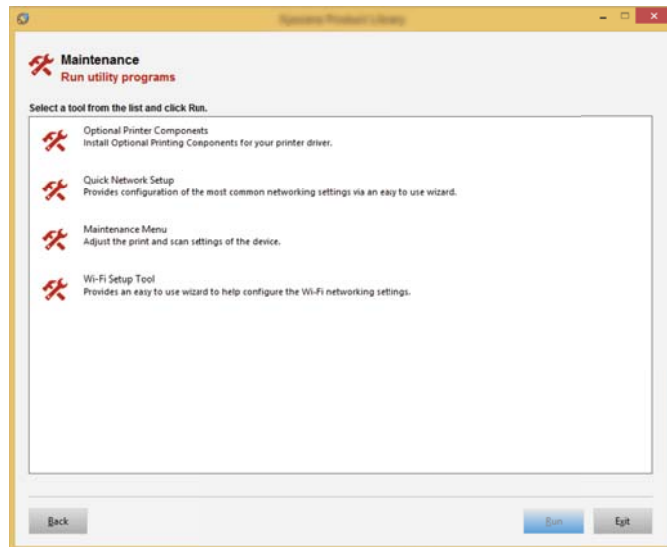

## 9 Configure the settings.

- 1 [Do not use automatic configuration] > [Next] > [Next]
- 2 [Wi-Fi Direct] > [Next] > [Next]
- 3 [Advanced setup] > [Next]  
Select [Express] or [Custom] as device discovery method. Specify the IP address or host name to search the machine.
- 4 Select the machine > [Next].

- 5 Select [Use the device settings.] on [Authentication mode], and enter [Login User Name] and [Login Password] > [Next]. The login user name and password are both Admin.
- 6 Configure the communication settings > [Next].
- 7 Change the settings of access point as necessary > [Next].  
The network is configured.

## Setting Wi-Fi Direct

Follow the configuration methods below when printing from the Wi-Fi Direct environment.



### NOTE

To use Wi-Fi Direct, Wireless Network Interface Kit (IB-36) must be installed in the machine.

The Wireless Network Interface Kit (IB-36) is an option for some models. Contact your dealer or our sales or service representative for detail.

➔ [IB-36 <Wireless Network Interface Kit> \(12-3\)](#)

## Configuring the Connection from the Operation Panel on This Machine

### Connecting to Computers or Handheld Devices that Support Wi-Fi Direct

- 1 **Display the screen.**  
[System Menu / Counter] key > [System/Network] > Enter a login user name and password > [Login] > [Network] > [Wi-Fi Direct Settings] > [Wi-Fi Direct]
- 2 **Configure the settings.**  
[On] > [OK]
- 3 **Restart the network.**  
[System Menu / Counter] key > [System/Network] > [Network] > [Restart Network]
- 4 **Specify the machine name from the computer or handheld device.**  
If a confirmation message appears on the operation panel of the machine, select [Yes].  
The network between this machine and the computer or handheld device is configured.

### Connecting to Computers or Handheld Devices that do not Support Wi-Fi Direct

The following procedure is an example for connecting to iOS handheld devices.

- 1 **Display the screen.**  
[System Menu / Counter] key > [System/Network] > Enter a login user name and password > [Login] > [Network] > [Wi-Fi Direct Settings] > [Wi-Fi Direct]
- 2 **Configure the settings.**  
[On] > [OK]
- 3 **Restart the network.**  
[System Menu / Counter] key > [System/Network] > [Network] > [Restart Network]
- 4 **[Home] key > [Wi-Fi Direct] (ECOSYS M8130cidn)**  
[Home] key > [Task Screen] > [Wi-Fi Direct] (ECOSYS M8124cidn)



**5 Note the network name (SSID), IP address, and password.**

**6 Configure the handheld device.**

[Settings] > [Wi-Fi]

Select the network name (SSID) appeared in step 5 from the list.

Enter the password that was provided in step 5 > [Connect]

The network between this machine and the computer or handheld device is configured.

## Configuring the Connection by Using Push Button

When your computer or handheld device does not support Wi-Fi Direct but supports WPS, you can configure the network using push button.

**1 Display the screen.**

[System Menu / Counter] key > [System/Network] > Enter a login user name and password > [Login] > [Network] > [Wi-Fi Direct Settings] > [Wi-Fi Direct]

**2 Configure the settings.**

[On] > [OK]

**3 Restart the network.**

[System Menu / Counter] key > [System/Network] > [Network] > [Restart Network]

**4 [Home] > [Wi-Fi Direct]**

**5 Press the push button on the computer or handheld device and select [Push Button] on the screen of operation panel simultaneously.**

The network between this machine and the computer or handheld device is configured.

 **IMPORTANT**

You can connect up to three handheld devices at the same time using Wi-Fi Direct setting. When the devices that support Wi-Fi Direct are connected, if you want to connect other device, disconnect the already-connected devices from the network. The disconnection methods are as follows:

- Disconnect the network from the computer or handheld computer
- Disconnecting all devices from the network on the operation panel  
Select [Home] > [Wi-Fi Direct] > [Connected Device List] > [Disconnect All]
- Configuring auto disconnecting time from the System menu  
➔ [\[Wi-Fi Direct Settings\] \(8-35\)](#)
- Configuring auto disconnecting time from the Command Center RX  
➔ [Command Center RX User Guide](#)

## Setting NFC

NFC (Near Field Communication) is an international standard for near radio communication that is limited to a data communication distance of 10 cm. Data communication can be performed by simply holding an NFC capable portable terminal near the machine.

The configuration methods are as follows

### Configuring Settings Using a Web Page

Settings can be configured from Command Center RX.

➔ [Command Center RX User Guide](#)

### Configuring the Connection from the Operation Panel on This Machine

NFC settings can be configured from the system menu.

➔ [\[NFC\] \(8-59\)](#)

This section provides an example of how to configure NFC settings from the system menu.

#### 1 Display the screen.

[System Menu / Counter] key > [System/Network] > Enter a login user name and password > [Login] > [Network]  
> [NFC]

#### 2 Configure the settings.

[On] > [OK]

## Energy Saver function

If a certain period of time elapses after the machine is last used, the machine automatically enters Low Power Mode to reduce power consumption. If the machine is not used while in sleep mode, the power automatically turns off.

### Low Power Mode

If the machine is not operated for a certain period of time, the energy saver indicator will light up and the screen will become dark to reduce power consumption. This status is referred to as Low Power Mode.

“Low power.” will be displayed on the screen.

Default preset time: 1 minute (factory default)

If print data is received during Low Power Mode, the machine automatically wakes up and starts printing. Also when fax data arrives while the machine is in Sleep, the machine automatically wakes up and starts printing.

To resume, perform one of the following actions.

- Press any key on the operation panel.
- Touch the touch panel.
- Open the document processor.
- Place originals in the document processor.

The machine will be ready to operate within the following time.

- ECOSYS M8124cidn: within 15.1 seconds
- ECOSYS M8130cidn within 17.6 seconds

Note that ambient environmental conditions, such as ventilation, may cause the machine to respond more slowly.



#### NOTE

If the Low Power Timer is equal to the Sleep Timer, a Sleep mode is preceded.

### Energy Saver Recovery Level

This machine can reduce power consumption when recovering from Energy Saver Mode. For EnergySaver RecoveryLevel, "Full Recovery", "Normal Recovery" or "Power Saving Recovery" can be selected. The factory default is "Normal Recovery".

For more information on Energy Saver Recovery Level settings, refer to the following:

➔ [Quick Setup Wizard \(2-25\)](#)

## Sleep

Select the [Energy Saver] key. Touch panel and all indicators on the operation panel will go out to save a maximum amount of power except the Energy Saver indicator. This status is referred to as Sleep.

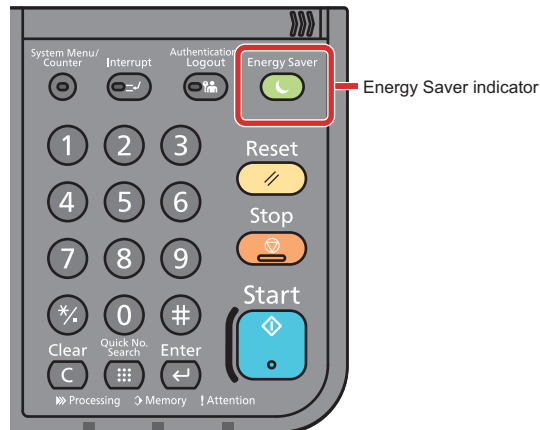

If print data is received during Sleep, the machine automatically wakes up and starts printing. Also when fax data arrives while the machine is in Sleep, the machine automatically wakes up and starts printing.

To resume, perform the following actions.

- Press any key on the operation panel.
- Touch the touch panel.
- Place originals in the document processor.

The machine will be ready to operate within the following time.

- ECOSYS M8124cidn: within 15.1 seconds
- ECOSYS M8130cidn: within 17.6 seconds

Note that ambient environmental conditions, such as ventilation, may cause the machine to respond more slowly.

## Auto Sleep

Auto Sleep automatically switches the machine into Sleep if left idle for a preset time.

The default preset time is 15 minutes.

To change the preset sleep time, refer to the following:

➔ [Quick Setup Wizard \(2-25\)](#)

## Sleep Rules (models for Europe)

You can set whether sleep mode operates for each function. When the machine enters sleep mode, the ID card cannot be recognized.

For more information on Sleep Rules settings, refer to the following:

➔ [Quick Setup Wizard \(2-25\)](#)

## Sleep Level (Energy Saver) (models except for Europe)

For sleep level, you can toggle between the following two modes: Energy Saver mode and Quick Recovery mode. The default setting is Energy Saver mode.

Energy Saver mode reduces power consumption even more than Quick Recovery mode, and allows Sleep Mode to be set separately for each function. The ID card cannot be recognized. To change the preset sleep time, refer to the following:



### NOTE

If the optional network interface kit is installed, Energy Saver cannot be specified.

To resume, select the [Energy Saver] key on the operation panel. If print data is received during Sleep, the machine automatically wakes up and starts printing.

For more information on Sleep Level settings, refer to the following:

➔ [Quick Setup Wizard \(2-25\)](#)

# Quick Setup Wizard

The Machine Setup Wizard is launched when the equipment is turned on for the first time after being installed. Before using this machine, configure such settings as date and time, network configuration, and energy saving functions as needed.

## NOTE

The default settings of the machine can be changed in System Menu.

For settings that are configurable from System Menu, refer to the following:

➔ [System Menu \(8-1\)](#)

The following settings can be configured in a wizard-style screen.

Function	Item	Description
<b>FAX Setup</b>		Configures basic fax settings. FAX functions are available only on products with the fax function installed. ➔ FAX Operation Guide
<b>Energy Saver Setup</b>		Configures energy saver function settings.
	1. Sleep Mode	Sleep Timer Sleep Level (models except for Europe)
	2. Low Power Mode	Low Power Timer
<b>Network Setup</b>	1. Network	Network Selection <sup>*1</sup> Wi-Fi <sup>*2</sup> DHCP <sup>*3</sup> IP Address <sup>*4</sup> Subnet Mask <sup>*4</sup> Default Gateway <sup>*4</sup>

\*1 This function is displayed when the Wireless Network Interface Kit (IB-36) is installed. The Wireless Network Interface Kit is an option for some models. Contact your dealer or our sales or service representatives for detail.

➔ [IB-36 <Wireless Network Interface Kit> \(12-3\)](#)

\*2 This function is displayed when [Network Selection] is set to [Wi-Fi].

\*3 This function is displayed when [Network Selection] is set to [Wired Network].

\*4 This function is displayed when [DHCP] is set to [On].

## NOTE

If the user authentication screen appears, enter your login user name and login password and select [Login].

The factory default login user name and login password are set as shown below.

Login User Name

ECOSYS M8124cidn:2400, ECOSYS M8130cidn:3000

Login Password

ECOSYS M8124cidn:2400, ECOSYS M8130cidn:3000

## 1 Display the screen.

[System Menu / Counter] key > [Quick Setup Wizard]

## 2 Select a function.

## 3 Configure the Custom Box.

Start the wizard. Follow the instructions on the screen to configure settings.

### NOTE

If you experience difficulty configuring the settings, refer to the following:

➔ [Help Screen \(3-13\)](#)

Item	Description
End	Exits the wizard. Settings configured so far are applied.
<< Previous	Returns to the previous item.
Skip >>	Advances to the next item without setting the current item.
Next >	Advances to the next screen.
< Back	Returns to the previous screen.
Finish	Register the settings and exit the wizard.

## Installing Software

Install appropriate software on your PC from the included DVD (Product Library) if you want to use the printer function of this machine or perform TWAIN / WIA transmission or Network FAX transmission from your PC.

### Software on DVD (Windows)

You can use either [Express Install] or [Custom Install] can be selected for the installation method. [Express Install] is the standard installation method. To install components that cannot be installed by [Express Install], use [Custom Install].

For details on installing using [Custom Install], refer to the following:

➔ [Install using \[Custom Install\]. \(2-30\)](#)

Software	Description	Express Install
KX DRIVER	This driver enables files on a computer to be printed by the machine. Multiple page description languages (PCL XL, KPDL, etc.) are supported by a single driver. This printer driver allows you to take full advantage of the features of the machine. Use this driver to create PDF files.	○
KX XPS DRIVER	This printer driver supports the XPS (XML Paper Specification) format developed by Microsoft Corporation.	-
KPDL mini-driver/PCL mini-driver (PCL/KPDL)	This is a Microsoft MiniDriver that supports PCL and KPDL. There are some restrictions on the machine features and option features that can be used with this driver.	
FAX Driver	This makes it possible to send a document created in a computer software application as a fax via the machine.	-
Kyocera TWAIN Driver	This driver enables scanning on the machine using a TWAIN-compliant software application.	○
Kyocera WIA Driver	WIA (Windows Imaging Acquisition) is a function of Windows that enables reciprocal communication between an imaging device such as a scanner and an image processing software application. An image can be acquired using a WIA-compliant software application, which is convenient when a TWAIN-compliant software application is not installed in the computer.	
KYOCERA Net Viewer	This is a utility that enables monitoring of the machine on the network.	
Status Monitor	This is a utility that monitors the printer status and provides an ongoing reporting function.	○
File Management Utility	This makes it possible to send and save a scanned document to a specified network folder.	-
KYOCERA Net Direct Print	This makes it possible to print a PDF file without starting Adobe Acrobat/Reader.	-
FONTS	These are display fonts that enable the machine's built-in fonts to be used in a software application.	○



#### NOTE

- Installation on Windows must be done by a user logged on with administrator privileges.
- The optional FAX Kit is required in order to make use of fax functionality.



## Installing Software in Windows

### Install using [Express Install].

Instructions are based on interface elements as they appear in Windows 8.1. For details on installing using [Custom Install], refer to the following:

➔ [Install using \[Custom Install\]. \(2-30\)](#)

#### 1 Insert the DVD.

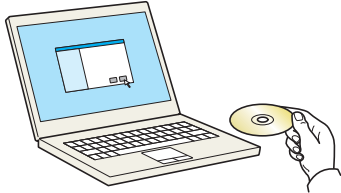

#### NOTE

- Installation on Windows must be done by a user logged on with administrator privileges.
- If the "Welcome to the Found New Hardware Wizard" dialog box displays, select [Cancel].
- If the auto run screen is displayed, click [Run setup.exe].
- If the user account management window appears, click [Yes (Allow)].

#### 2 Display the screen.

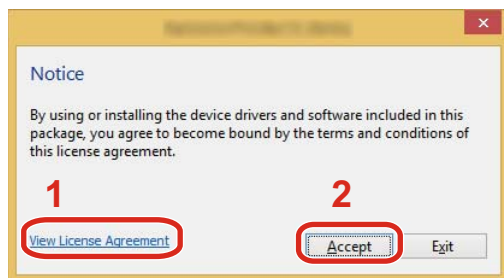

- 1 Click [View License Agreement] and read the License Agreement.
- 2 Click [Accept].

### 3 Select [Express Install].

### 4 Install the software.

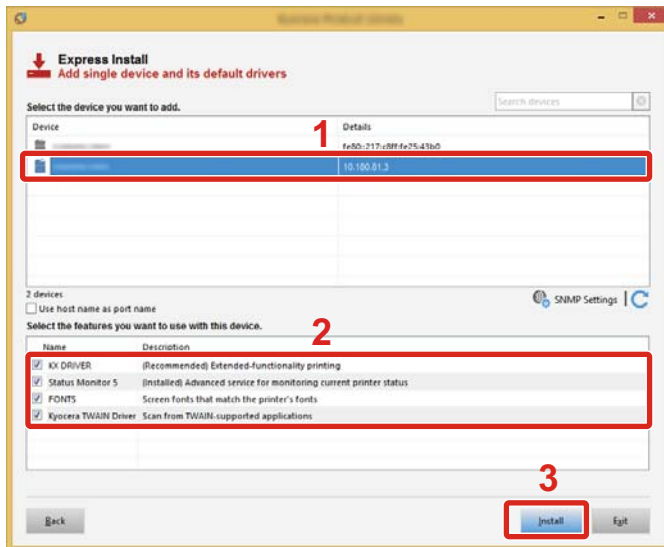

Select the model name of the machine. You can also select [Use host name for port name] and set to use the host name of the standard TCP/IP port. (A USB connection cannot be used.)

When you click [Install], a screen asking for your cooperation with data collection will be displayed. Select one of the answer choices and click [OK].

#### IMPORTANT

If Wi-Fi or Wi-Fi Direct is enabled, be sure to specify the IP address for the port name. Installation may fail if the host name is specified.

#### NOTE

- The machine cannot be detected unless it is on. If the computer fails to detect the machine, verify that it is connected to the computer via a network cable or a USB cable and that it is turned on and click.  (Update).
- If the Windows security window appears, click [Install this driver software anyway].
- To install Status Monitor on versions of Windows prior to Windows 8, it is necessary to install Microsoft .NET Framework 4.0 beforehand.

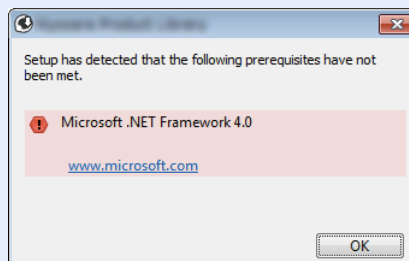

## 5 Finish the installation.

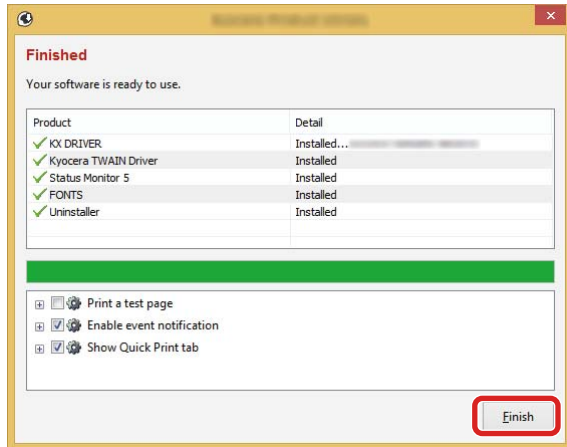

When "Your software is ready to use" appears, you can use the software. To print a test page, click the "Print a test page" checkbox and select the machine.

Click [Finish] to exit the wizard.

If a system restart message appears, restart the computer by following the screen prompts. This completes the printer driver installation procedure.

If you are installing the TWAIN driver, continue by configuring the following:

➔ [Setting TWAIN Driver \(2-37\)](#)

## Install using [Custom Install].

Instructions are based on interface elements as they appear in Windows 8.1.

### 1 Insert the DVD.

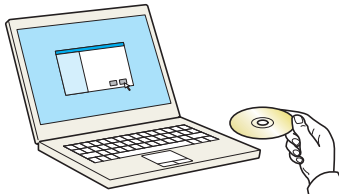

#### NOTE

- Installation on Windows must be done by a user logged on with administrator privileges.
- If the "Welcome to the Found New Hardware Wizard" dialog box displays, select [Cancel].
- If the auto run screen is displayed, click [Run setup.exe].
- If the user account management window appears, click [Yes (Allow)].

### 2 Display the screen.

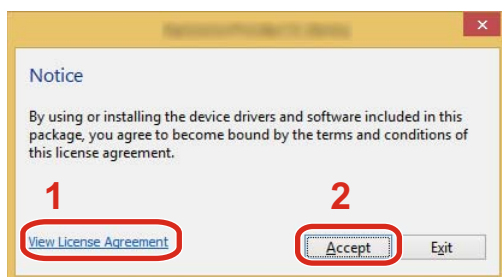

1 Click [View License Agreement] and read the License Agreement.

2 Click [Accept].

### 3 Select [Custom Install].

### 4 Install the software.

1 Select the device to be installed.

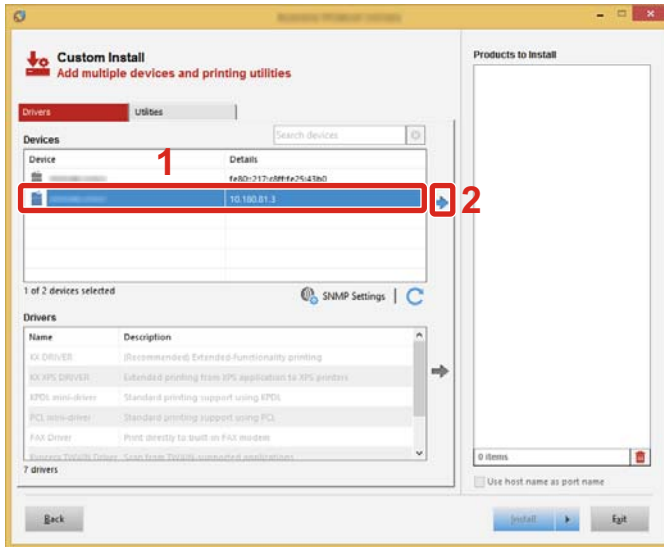

#### IMPORTANT

If Wi-Fi or Wi-Fi Direct is enabled, be sure to specify the IP address for the port name. Installation may fail if the host name is specified.

#### NOTE

- The machine cannot be detected unless it is on. If the computer fails to detect the machine, verify that it is connected to the computer via a network cable and that it is turned on and click (Refresh). Click (Update).
- If the desired printing device does not appear, select [Add custom device] to display the list, and select the desired device.

2 Select the driver to be installed.

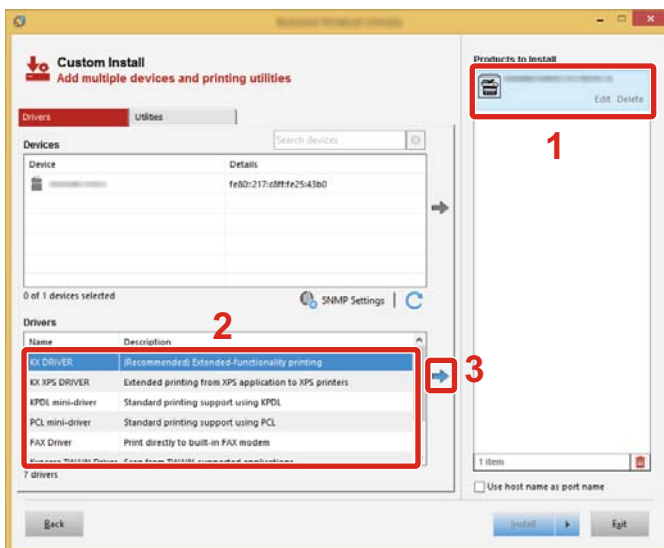

3 Click [Utility] tab and select the utility to be installed.

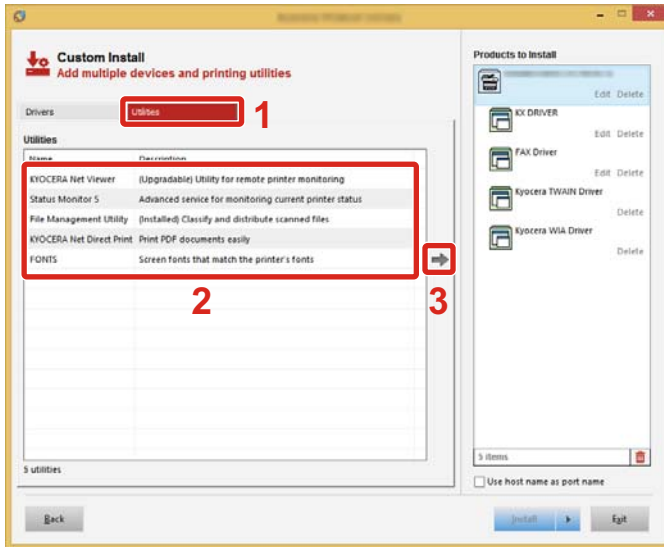

4 Click [Install].

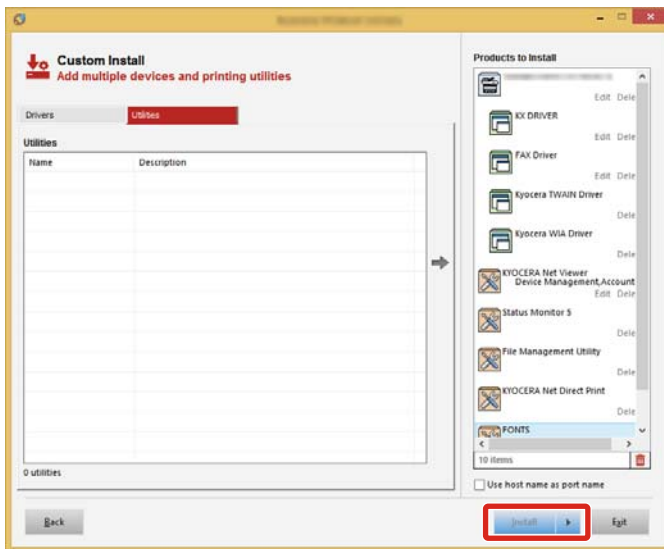

When you click [Install], a screen asking for your cooperation with data collection will be displayed. Select one of the answer choices and click [OK].

**NOTE**

To install Status Monitor on versions of Windows prior to Windows 8, it is necessary to install Microsoft .NET Framework 4.0 beforehand.

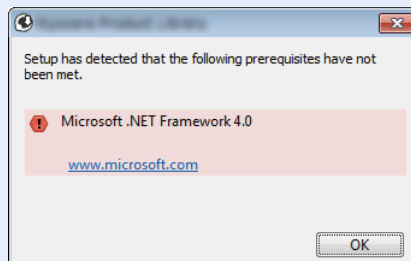

## 5 Finish the installation.

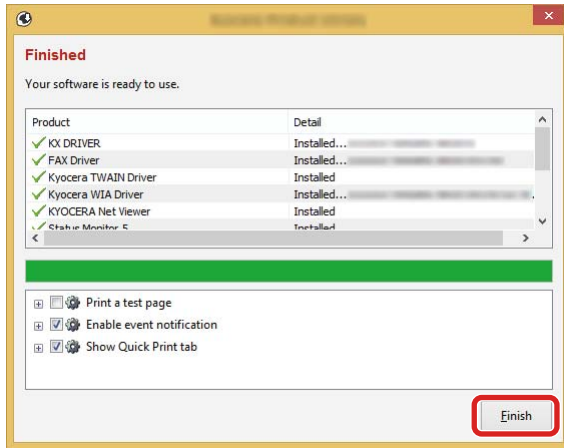

When "Your software is ready to use" appears, you can use the software. To print a test page, click the "Print a test page" checkbox and select the machine.

Click [Finish] to exit the wizard.

If a system restart message appears, restart the computer by following the screen prompts. This completes the printer driver installation procedure.

If you are installing the TWAIN driver, continue by configuring the following:

➔ [Setting TWAIN Driver \(2-37\)](#)

## Uninstalling the Software

Perform the following procedure to delete the Software with Product Library from your computer.

### NOTE

Uninstallation on Windows must be done by a user logged on with administrator privileges.

### 1 Display the screen.

Perform the procedure below on the computer to select the software.

Click [Search] in charms, and enter "Uninstall Kyocera Product Library" in the search box. Select [Uninstall Kyocera Product Library] in the search list. Software Uninstall Wizard appears.

### NOTE

In Windows 7, click [Start] button on the Windows and then select [All Programs], [Kyocera], and [Uninstall Kyocera Product Library] to display the Uninstall Wizard.

### 2 Uninstall the software.

Place a check in the check box of the software to be deleted.

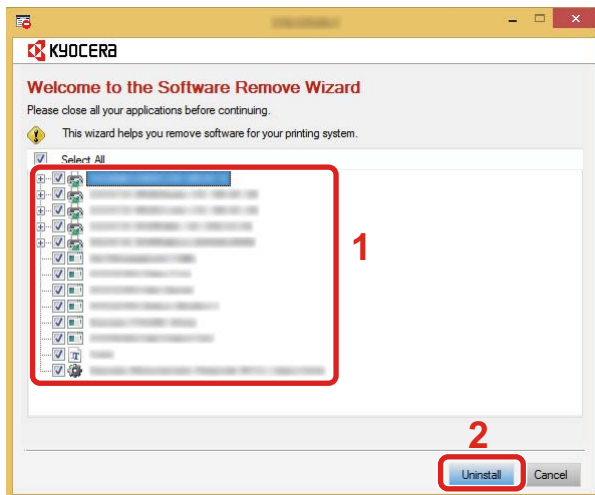

### 3 Finish uninstalling.

If a system restart message appears, restart the computer by following the screen prompts. This completes the software uninstallation procedure.

### NOTE

- The software can also be uninstalled using the Product Library.
- In the Product Library screen, click [Uninstall], and follow the on-screen instructions to uninstall the software.

## Installing Software on a Mac Computer

The machine's printer functionality can be used by a Mac computer.



### NOTE

- Installation on Mac OS must be done by a user logged on with administrator privileges.
- When installing software on a Mac computer, set the machine's emulation to [KPD(L)] or [KPD(L)(Auto)].
- ➔ [\[Printer\] \(8-32\)](#)
- If connecting by Bonjour, enable Bonjour in the machine's network settings.
- ➔ [\[Bonjour\] \(8-43\)](#)
- In the Authenticate screen, enter the name and password used to log in to the operating system.
- When printing via AirPrint, you do not have to install the software.

### 1 Insert the DVD.

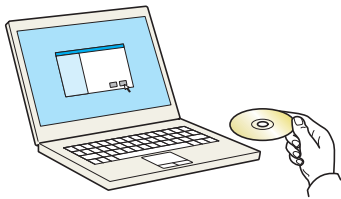

Double-click the [Kyocera] icon.

### 2 Display the screen.

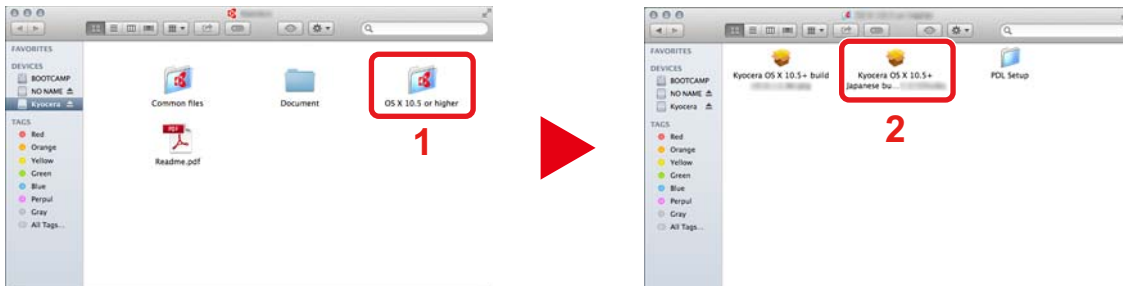

Double-click [ OS X x.x] depending on your Mac OS version.

### 3 Install the software.



Install the printer driver as directed by the instructions in the installation software.

This completes the printer driver installation.

If a USB connection is used, the machine is automatically recognized and connected. If an IP connection is used, the settings below are required.



## 4 Configure the settings.

1 Open System Preferences and add the printer.



2 Select [Default], click the item that appears in "Name" and then select the driver.



### NOTE

When using an IP connection, click [IP] and then enter the host name or IP address. The number entered in "Address" will automatically appear in "Name". Change if needed.

3 Select the options available for the machine.

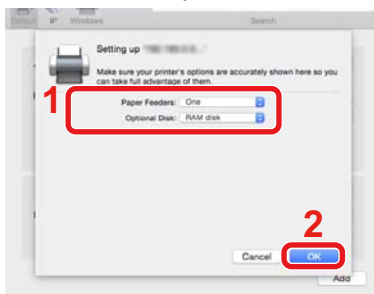

4 The selected printer is added.

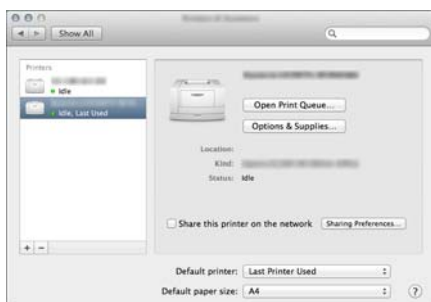

## Setting TWAIN Driver

Instructions are based on interface elements as they appear in Windows 8.1.

### 1 Display the screen.

- 1 Click [Search] in charms, and enter "TWAIN Driver Setting" in the search box. Select [TWAIN Driver Setting] in the search list. TWAIN Driver setting screen appears.

#### NOTE

In Windows 7, select [Start] button on the Windows, [All Programs], [Kyocera] and then [TWAIN Driver Setting].

- 2 Click [Add].

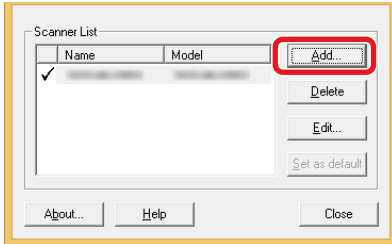

### 2 Configure the settings.

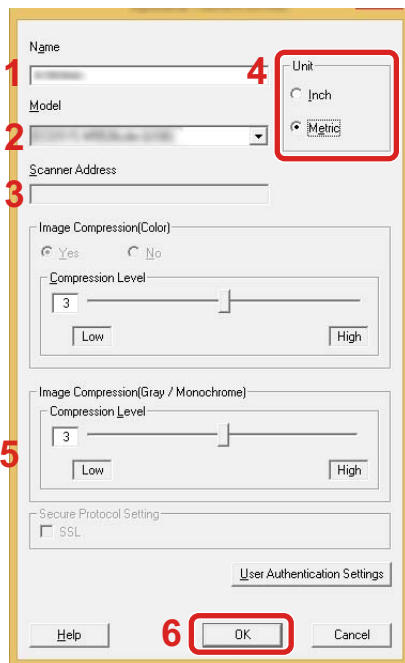

- 1 Enter the machine name.
- 2 Select this machine from the list.
- 3 Enter the machine IP addresses or host name.
- 4 Set units of measurement.
- 5 When using SSL, select the checkbox beside SSL.
- 6 Click [OK].

#### NOTE

When the machine's IP address or host name is unknown, contact Administrator.

### 3 Finish registering.

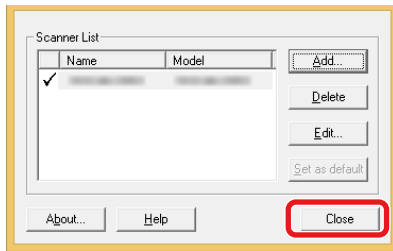

#### NOTE

Click [Delete] to delete the added machine. Click [Edit] to change names.

## Setting WIA Driver

Instructions are based on interface elements as they appear in Windows 8.1.

### 1 Display the screen.

- 1 Click [Search] in desktop charms, and enter "View scanners and cameras" in the search box. Select [View scanners and cameras] in the search list and then the Scanners and Cameras screen appears.

#### NOTE

In Windows 7, click [Start] button on the Windows and enter "Scanner" in [Program and File Search]. Click [View scanners and cameras] in the search list and then the Scanners and Cameras screen appears.

- 2 Select the same name as this machine from WIA Drivers, and click [Properties].

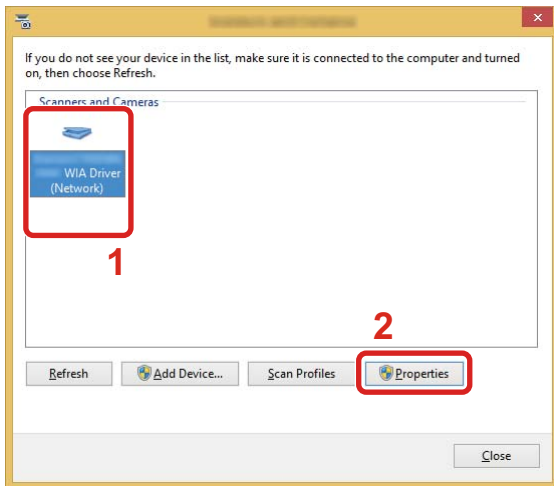

### 2 Configure the settings.

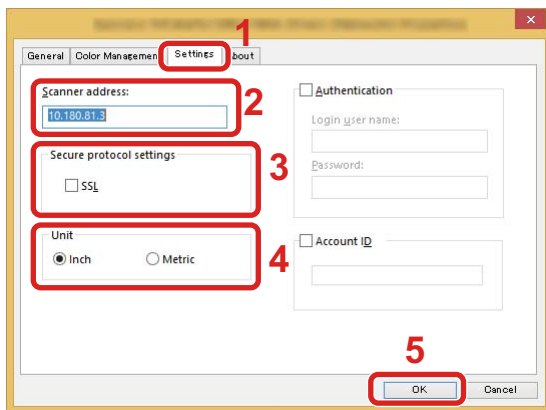

- 1 Click the [Settings] tab.
- 2 Enter the machine IP addresses or host name.
- 3 When using SSL, select the checkbox beside SSL.
- 4 Set units of measurement.
- 5 Click [OK].

## Installing the WSD Driver

### In Windows 8, Windows 8.1, and Microsoft Windows Server 2012

**1 From the desktop charms: [Search] > [Control Panel] > [Devices and Printers].**

**2 Install the driver.**

Click [Add a device]. Select the machine's icon and then click [Next].

When the machine's icon is displayed in "Printers" on the "Devices and Printers" screen, the installation is completed.

### In Windows 7

**1 Display [Network] in the Start menu.**

Click [Start] button on the Windows and then select [Network].

#### NOTE

When [Network] does not appear in the Start menu, perform the following procedure.

- 1 Right-click [Start] and click [Property] in the menu that appears.
- 2 Select the [[Start] menu] tab in the "Task bar and [Start] menu properties" screen, and click [Customize].
- 3 When the "Customize [Start] menu" screen appears, select the "Network" check box and click [OK].

**2 Install the driver.**

Right-click the machine's icon and then click [Install].

#### NOTE

If the "User Account Control" window appears, click [Continue].

If the "Found New Hardware" window appears, click [Cancel].

During the installation, double-click the icon shown on the task bar to display the "Driver Software Installation" screen. When "Your devices are ready to use" is displayed on the [Driver Software Installation] screen, the installation is completed. Installation is complete when "Your devices are ready to use" is displayed on the [Driver Software Installation] screen.

### In Windows 10

**1 In Windows, right-click the start button and then select the following: [Control Panel] > [Devices and Printers].**

**2 Install the driver.**

Click [Add a device]. Select the machine's icon and then click [Next].

When the machine's icon is displayed in "Printers" on the [Devices and Printers] screen, the installation is completed.

# Strengthening the Security by the Administrator

In addition to the information provided in this chapter, the administrator of this machine should check the following, and strengthen the security as needed.

In addition, this machine is equipped with user authentication function, which can be configured to limit the access to this machine to only those who have a registered login name and password.

➔ [User Authentication and Accounting \(User Login, Job Accounting\) \(9-1\)](#)

I want to...	Function Name	Reference page
<b>Restrict the users of the machine.</b>	User Login	<a href="#">9-3</a>
	Authentication Security	<a href="#">9-6</a>
	Auto Panel Reset	<a href="#">8-60</a>
	ID Card Settings <sup>*1</sup>	<a href="#">9-26</a>
<b>Restrict the basic functions that can be used.</b>	Local Authorization	<a href="#">9-17</a>
	Group Authorization Set	<a href="#">9-17</a>
	Guest Authorization Set	<a href="#">9-20</a>
<b>Prevent another user from handling the documents stored in the machine.</b>	Custom Box <sup>*2</sup>	<a href="#">2-1</a>
<b>Prevent the data stored in the machine from being leaked.</b>	Data Overwrite <sup>*3</sup>	Data Security Kit (E) User Guide
	Encrypt <sup>*3</sup>	
	PDF Encryption Functions	<a href="#">6-56</a>
<b>Completely delete the data on the machine before disposing of the machine.</b>	Data Sanitization	<a href="#">8-57</a>
<b>Protect the transmission from interception and wiretapping.</b>	IPP over SSL	<a href="#">8-47</a>
	HTTPS	<a href="#">8-46</a>
	LDAP Security	Command Center RX User Guide
	SMTP Security	<a href="#">8-50</a>
	POP3 Security	<a href="#">8-50</a>
	FTP Encrypted TX	<a href="#">8-17</a>
	Enhanced WSD (SSL)	<a href="#">8-49</a>
	IPSec	<a href="#">8-43</a>
	SNMPv3	<a href="#">8-45</a>

\*1 Optional Card Authentication Kit is required.

\*2 Optional SSD is required.

\*3 Optional Data Security Kit is required.

# Command Center RX

If the machine is connected to the network, you can configure various settings using Command Center RX.

This section explains how to access Command Center RX, and how to change security settings and the host name.

## ➔ Command Center RX User Guide

### NOTE

To fully access the features of the Command Center RX pages, enter the User Name and Password to login. Entering the predefined administrator password allows the user to access all pages, including Document Box, Address Book, and Settings on the navigation menu. The factory default setting for the default user with administrator privileges is shown below. (Upper case and lower case letters are distinguished (case sensitive).)

Login User Name: Admin

Login Password: Admin

Settings that the administrator and general users can configure in Command Center RX are as follows.

Item	Description	Administrator	General User
<b>Device Information</b>	The machine's structure can be checked.	<input type="radio"/>	<input type="radio"/>
<b>Job Status</b>	Displays all job information, including print and scan jobs, storing jobs, scheduled jobs, and job log history.	<input type="radio"/>	<input type="radio"/>
<b>Document Box</b>	Add or delete document boxes, or delete documents within a document box.	<input type="radio"/>	<input type="radio"/> *1
<b>Address Book</b>	Create, edit, or delete addresses and address groups.	<input type="radio"/>	<input type="radio"/> *1
<b>Device Settings</b>	Configure the advanced settings of the machine.	<input type="radio"/>	-
<b>Function Settings</b>	Configure the advanced function settings.	<input type="radio"/>	-
<b>Network Settings</b>	Configure the network advanced settings.	<input type="radio"/>	-
<b>Security Settings</b>	Configure the security advanced settings.	<input type="radio"/>	-
<b>Management Settings</b>	Configure the advanced management settings.	<input type="radio"/>	-

\*1 The logged in user may not be able to configure some settings, depending on the user permissions.

### NOTE

The optional FAX Kit is required in order to make use of fax functionality.

Here, information on the FAX settings has been omitted.

➔ FAX Operation Guide

## Accessing Command Center RX

### 1 Display the screen.

- 1 Launch your Web browser.

- 2 In the address or location bar, enter the machine's IP address or the host name.

Click in the following order to check the machine's IP address and the host name.

[Device Information] in the home screen > [Identification/Wired Network]

Examples: <https://192.168.48.21/> (for IP address)

<https://MFP001> (if the host name is "MFP001")

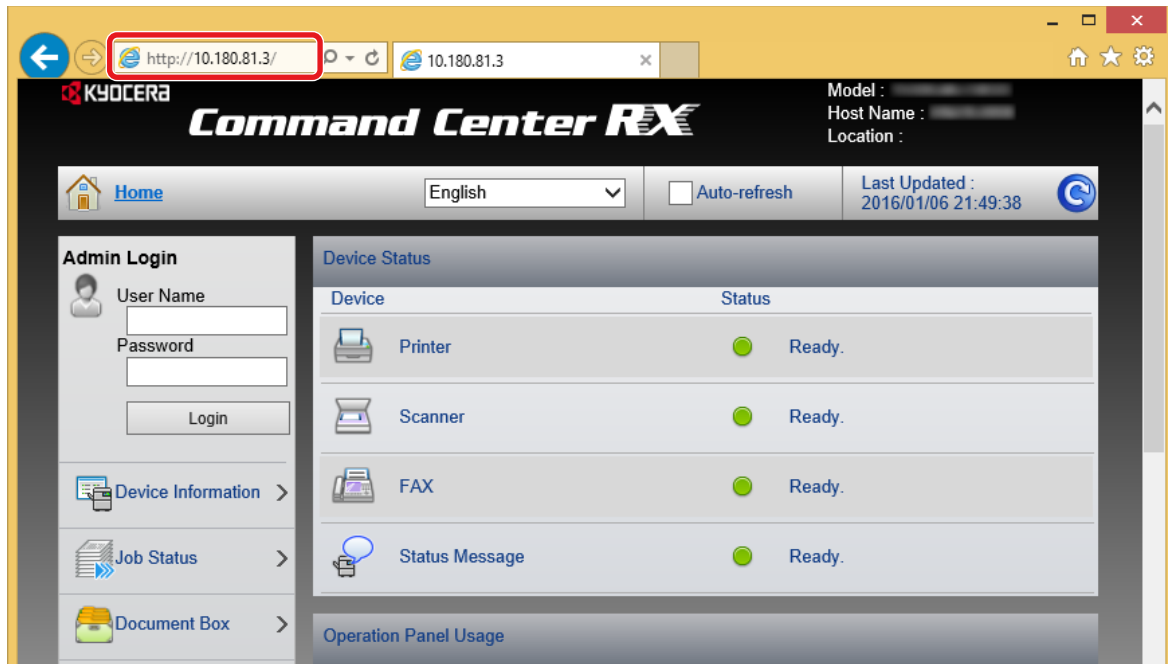

The web page displays basic information about the machine and Command Center RX as well as the current status of the machine.

#### NOTE

If the screen "There is a problem with this website's security certificate." is displayed, configure the certificate.

➔ [Command Center RX User Guide](#)

You can also continue the operation without configuring the certificate.

## 2 Configure the function.

Select a category from the navigation bar on the left of the screen.

#### NOTE

To fully access the features of the Command Center RX pages, enter the User Name and Password to login. Entering the predefined administrator password allows the user to access all pages, including Document Box, Address Book, and Settings on the navigation menu. The factory default setting for the default user with administrator privileges is shown below. (Upper case and lower case letters are distinguished (case sensitive).)

Login User Name: Admin

Login Password: Admin

## Changing Security Settings

### 1 Display the screen.

- 1 Launch your Web browser.



- 2 In the address or location bar, enter the machine's IP address or the host name.  
Click in the following order to check the machine's IP address and the host name.  
[Device Information] in the home screen > [Identification/Wired Network]
- 3 Log in with administrator privileges.

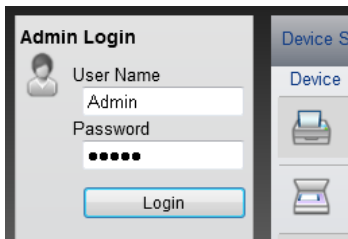

The factory default setting for the default user with administrator privileges is shown below. (Upper case and lower case letters are distinguished (case sensitive).)

Login User Name: Admin

Login Password: Admin

- 4 Click [Security Settings].

## 2 Configure the Security Settings.

From the [Security Settings] menu, select the setting you want to configure.

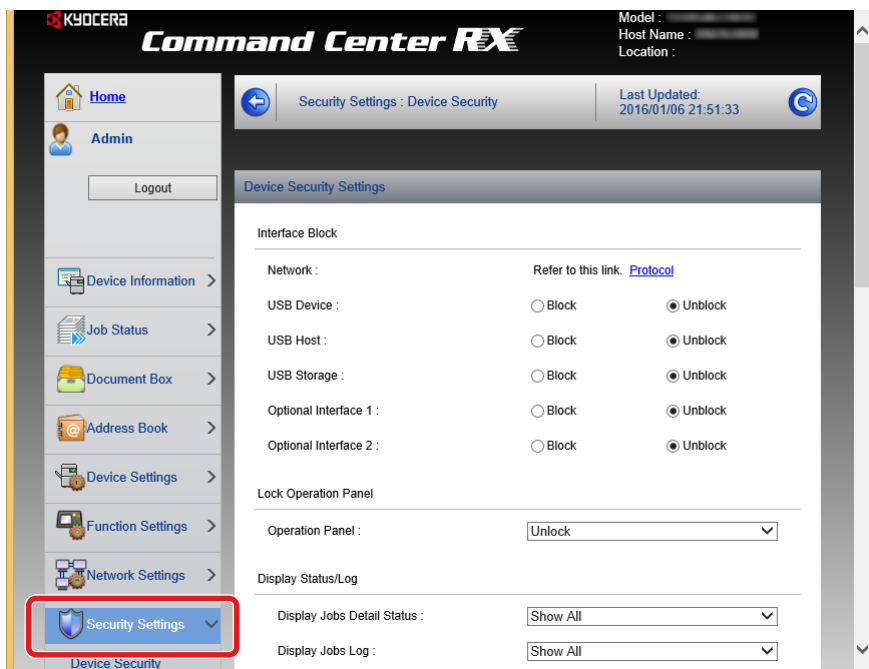

### NOTE

For details on settings related to certificates, refer to the following:

- ▶ Command Center RX User Guide

## Changing Device Information

- 1 Display the screen.
  - 1 Launch your Web browser.

- 2 In the address or location bar, enter the machine's IP address or the host name.  
Click in the following order to check the machine's IP address and the host name.  
[Device Information] in the home screen > [Identification/Wired Network]
- 3 Log in with administrator privileges.

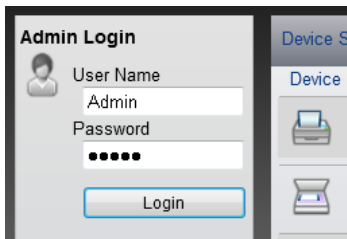

The factory default setting for the default user with administrator privileges is shown below. (Upper case and lower case letters are distinguished (case sensitive).)

Login User Name: Admin

Login Password: Admin

- 4 From the [Device Settings] menu, click [System].

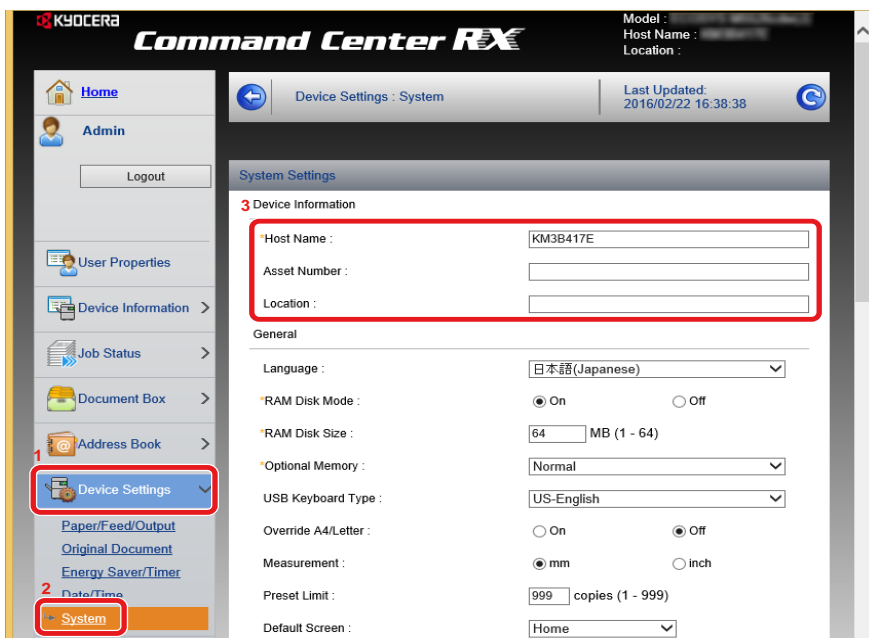

## 2 Specify the host name.

Enter the device information, and then click [Submit].

### ✔ IMPORTANT

After changing the setting, restart the network or turn the machine OFF and then ON.

To restart the network interface card, click [Reset] in the [Management Settings] menu, and then click [Restart Network] in "Restart".

## Setting SMTP and E-mail

By configuring the SMTP settings, it is possible to send the images scanned by the machine as E-mail attachments and to send E-mail notices when jobs have been completed.

To use this function, this machine must be connected to a mail server using the SMTP protocol.

In addition, configure the following.

- SMTP settings  
Item: "SMTP Protocol" and "SMTP Server Name" in "SMTP"
- The sender address when the machine sends E-mails  
Item: "Sender Address" in "E-mail Send Settings"
- The setting to limit the size of E-mails  
Item: "E-mail Size Limit" in "E-mail Send Settings"

## 1 Display the screen.

Display the SMTP Protocol screen.

- 1 Launch your Web browser.
- 2 In the address or location bar, enter the machine's IP address or the host name.  
Click in the following order to check the machine's IP address and the host name.  
[Device Information] in the home screen > [Identification/Wired Network]
- 3 Log in with administrator privileges.

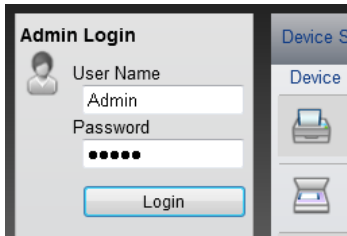

The factory default setting for the default user with administrator privileges is shown below. (Upper case and lower case letters are distinguished (case sensitive).)

Login User Name: Admin

Login Password: Admin

- 4 From the [Network Settings] menu, click [Protocol].

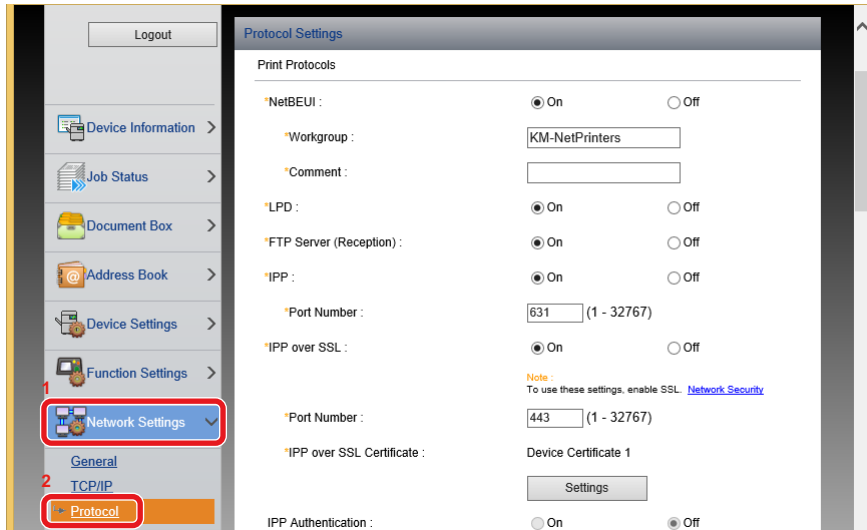

## 2 Configure the Settings.

Set "SMTP (E-mail TX)" to [On] in the "Send Protocols".

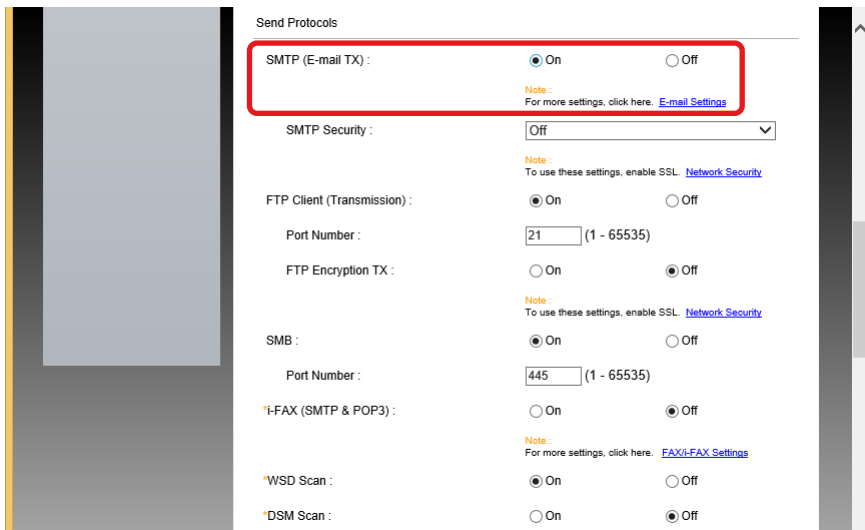

## 3 Display the screen.

Display the E-mail Settings screen.

From the [Function Settings] menu, click [E-mail].

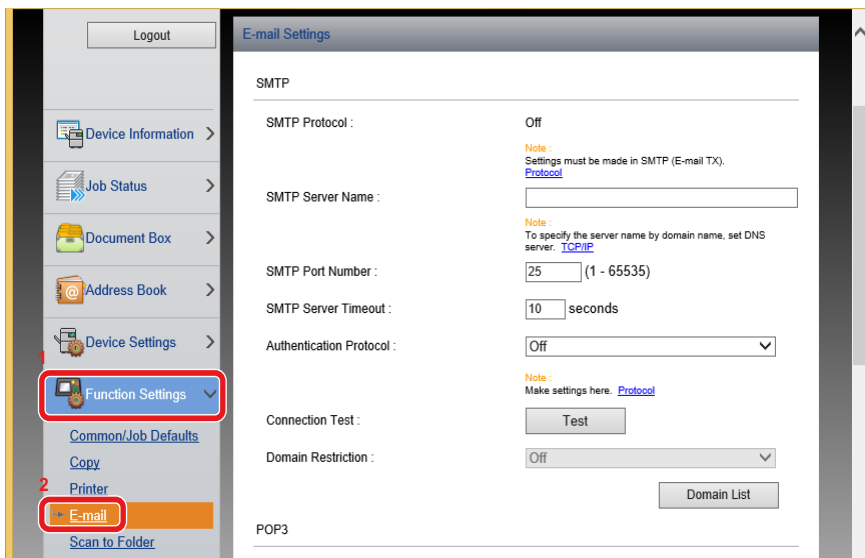

## 4 Configure the Settings.

Enter "SMTP" and "E-mail Send Settings" items.

Description		Description
<b>SMTP</b>		Set to send e-mail from the machine.
	<b>SMTP Protocol</b>	Displays the SMTP protocol settings. Check that "SMTP Protocol" is set to [On]. If [Off] is set, click [Protocol] and set the SMTP protocol to [On].
	<b>SMTP Server Name<sup>*1</sup></b>	Enter the host name or IP address of the SMTP server.
	<b>SMTP Port Number</b>	Specify the port number to be used for SMTP. The default port number is 25.
	<b>SMTP Server Timeout</b>	Enter the timeout period in seconds.
	<b>Authentication Protocol</b>	To use SMTP authentication, enter the user information for authentication.
	<b>SMTP Security</b>	Set SMTP security. Turn on "SMTP Security" in "SMTP (E-mail TX)" on the "Protocol Settings" page.
	<b>Connection Test</b>	Tests to confirm that the settings are correct without sending the e-mail.
	<b>Domain Restriction</b>	To restrict the domains, click the [Domain List] and enter the domain names of addresses to be allowed or rejected. Restriction can also be specified by e-mail address.
<b>POP3</b>	<b>POP3 Protocol</b>	You don't need to set the following items when you only enable the function of sending e-mail from the machine. Set the following items if you want to enable the function of receiving e-mail on the machine. ▶ Command Center RX User Guide
	<b>Check Interval</b>	
	<b>Run once now</b>	
	<b>Domain Restriction</b>	
	<b>POP3 User Settings</b>	
<b>E-mail Send Settings</b>	<b>E-mail Size Limit</b>	Enter the maximum size, in Kilobytes, of E-mail that can be sent. When E-mail size is greater than this value, an error message appears and E-mail sending is cancelled. Use this setting if you have set E-mail Size Limit for SMTP server. If not, enter a value of 0 (zero) to enable E-mail sending regardless of the size limit. Entering 0 (zero) sends the E-mail, regardless of the size limitation.
	<b>Sender Address<sup>*1</sup></b>	Specify the sender address for when the machine sends E-mails. Specify the e-mail address such as an address of the machine administrator, so that a reply or non-delivery report will go to a person rather than to the machine. The sender address must be entered correctly for SMTP authentication. Sender address: Up to 128 characters
	<b>Signature</b>	Enter the signature. The signature is free form text that will appear at the end of the E-mail body. It is often used for further identification of the machine. Signature: Up to 512 characters
	<b>Function Defaults</b>	Change the function default settings in [Common/Job Default Settings] page.

## 5 Click [Submit].

# Migrating the Address Book

By using the machine's utility, you can smoothly migrate address books when the machine is to be replaced.

The Address Book registered on the machine can be backed up or migrated using KYOCERA Net Viewer on the included DVD.

For details on operating the KYOCERA Net Viewer, refer to the following:

➔KYOCERA Net Viewer User Guide

## Backing Up Address Book Data to PC

1 Launch the KYOCERA Net Viewer.

2 Create a backup.

1 Right-click on the model name from which you want to back up the Address Book, and select [Advanced] - [Set multiple devices].

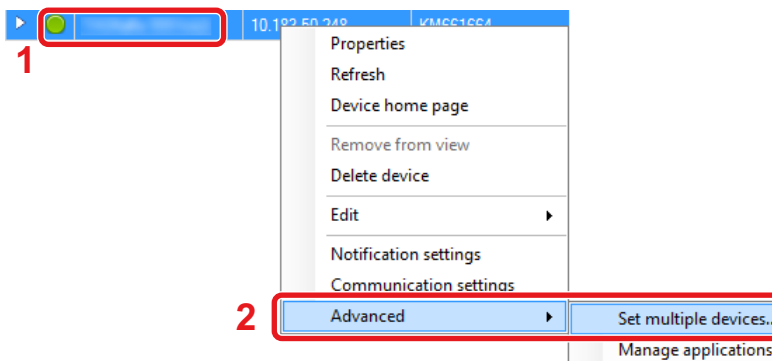

2 Select [Custom Mode] and click [Next].

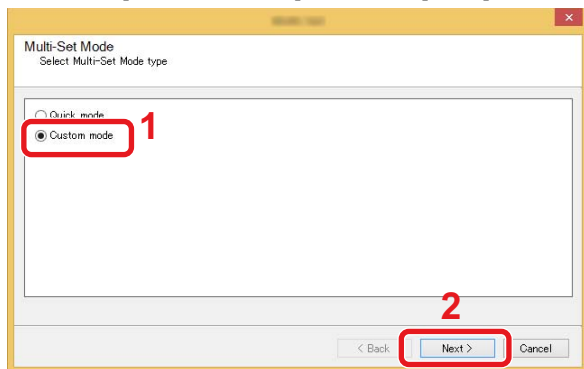

3 Select destination device group and click [Next].

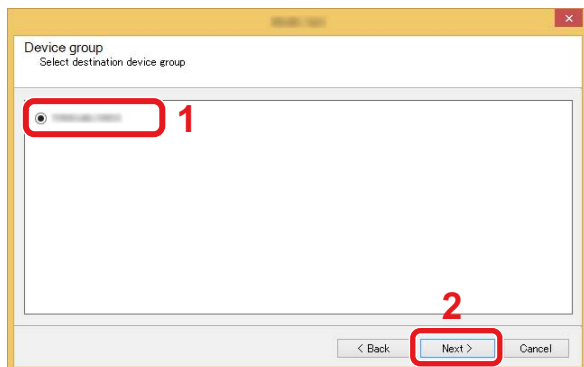

4 Select [Device Address Book] and click [Next].

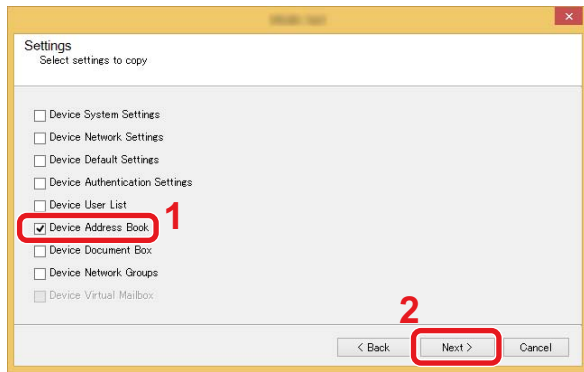

5 Select [Create from device] and remove the checkmark from [Overwrite settings on target device], and then click [Next].

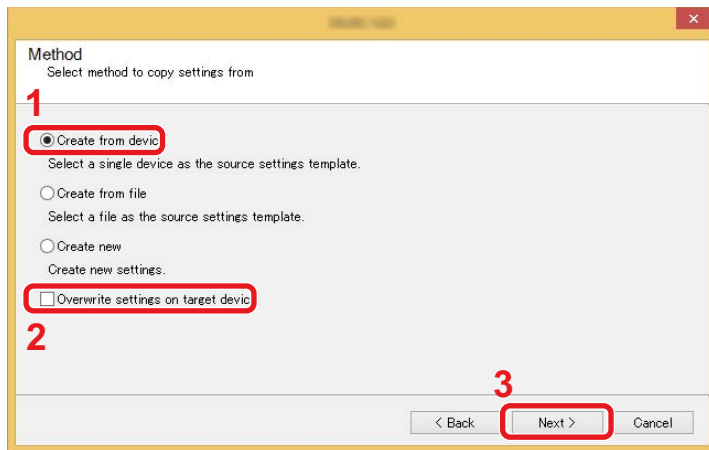

6 Select the model you want to back up, and click [Next].

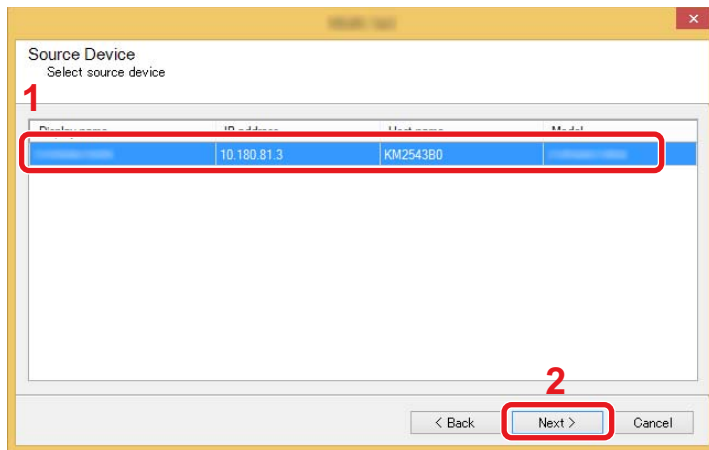

 **NOTE**

If the "Admin Login" screen appears, enter the "Admin Login" and "Login Password", and then click [OK]. The default settings are as follows (Upper case and lower case letters are distinguished (case sensitive)).

Login User Name: Admin

Login Password: Admin

- Click on [Save to file].

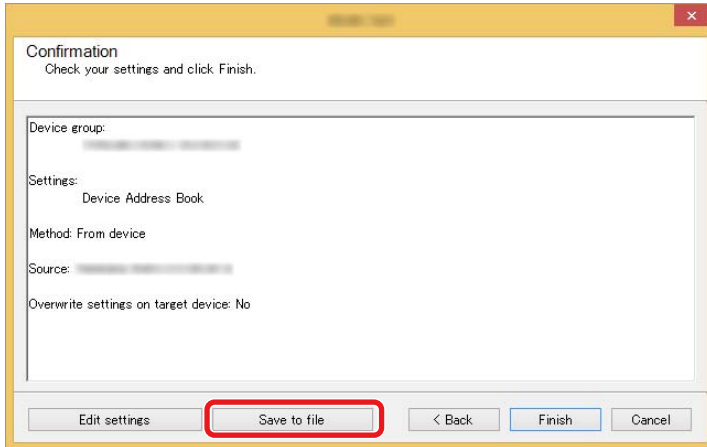

- Specify the location to save the file, enter the file name, and then click [Save]. For "Save as type", make sure to select "XML File".
- After saving the file, always click [Cancel] to close the screen.

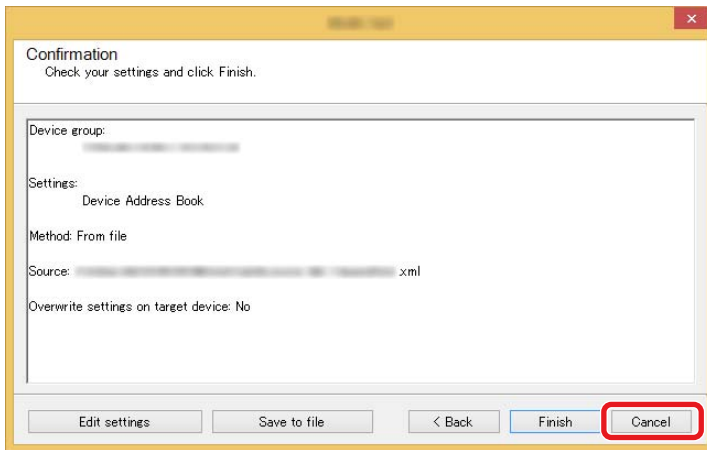

Please note that selecting [Finish] will write the data to the machine's Address Book.

## Writing Address Book Data to the Machine

- Launch the KYOCERA Net Viewer.
- Load the Address Book data.
  - Right-click on the model name to which you want to transfer the Address Book, and select [Advanced] - [Set multiple devices].

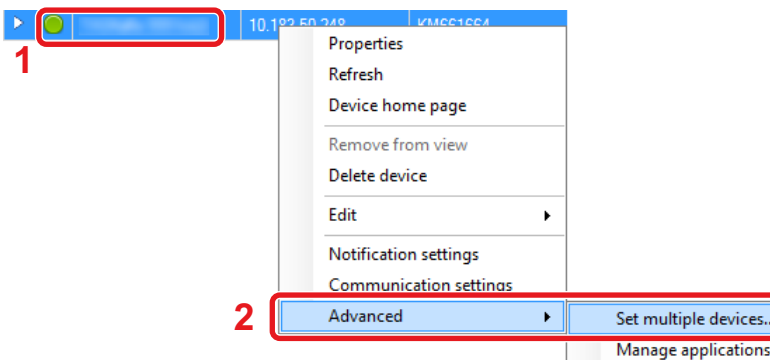



2 Select [Custom Mode] and click [Next].

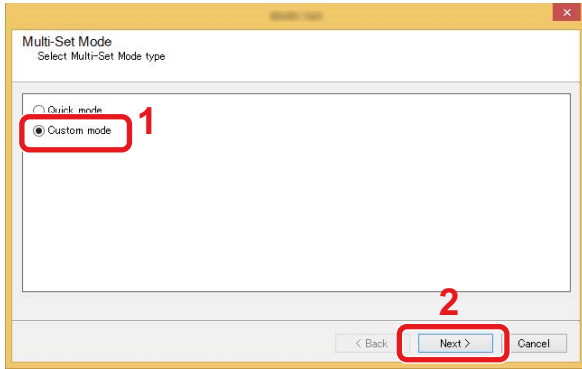

3 Select destination device group and click [Next].

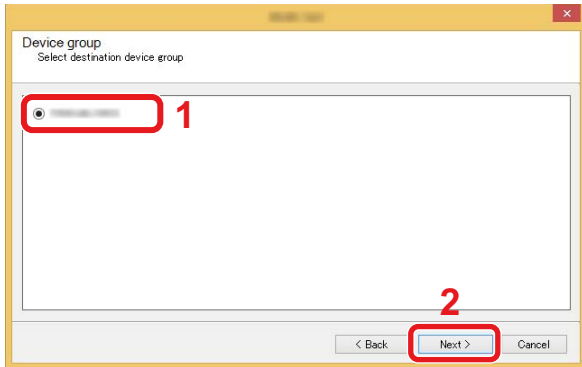

4 Select [Device Address Book] and click [Next].

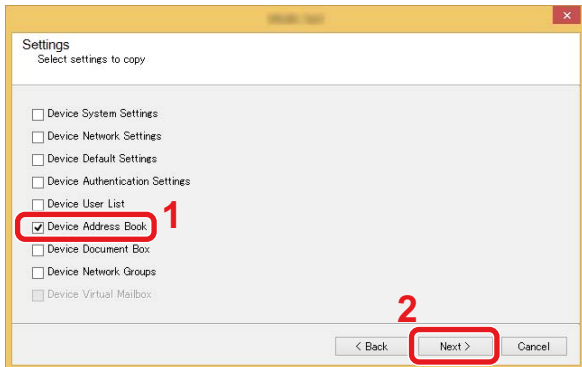

5 Select [Create from file] and remove the checkmark from [Overwrite settings on target device], and then click [Next].

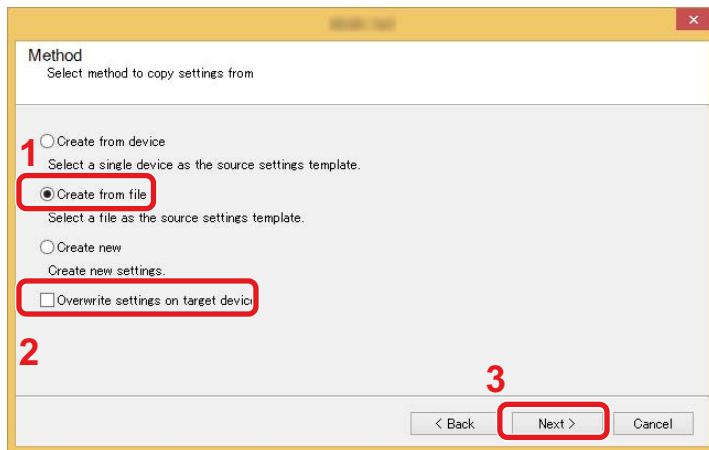

Selecting the [Overwrite settings on target device] checkbox will overwrite the machine's Address Book from entry No.1.

- 6 Click [Browse] and select the backup Address Book file, and then click [Next].

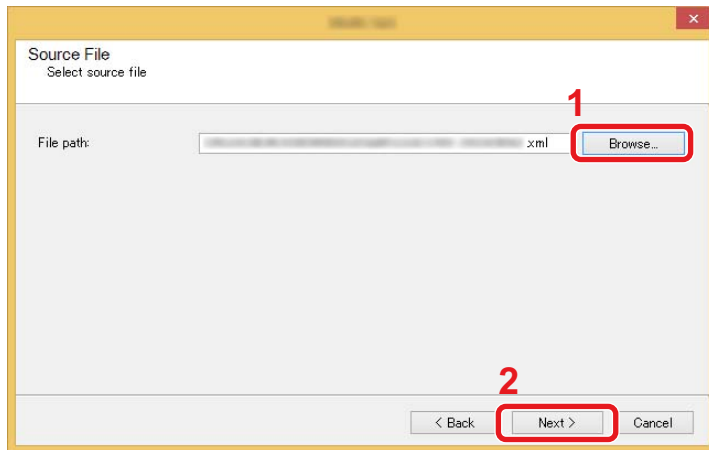

- 7 Click [Finish].

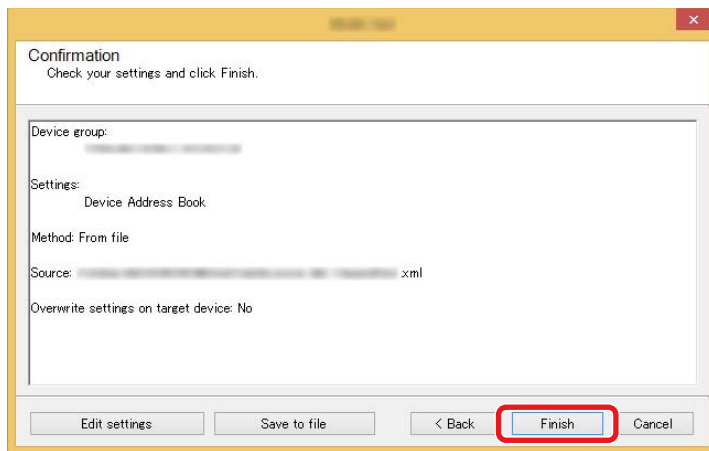

The write process of the Address Book data starts.

- 8 Once the write process is complete, click [Close].

# Application

The functionality of the machine can be expanded by installing applications.

Applications that help you perform your daily more efficiently such as a scan feature and an authentication feature are available.

For details, consult your sales representative or dealer.

## Installing Applications

To use applications, first install the application in the machine and then activate the application.

### NOTE

You can install applications and certificates on the machine. The number of applications you can run may vary according to the type of application.

The procedure is as follows.

### 1 Display the screen.

[System Menu / Counter] key > [Application] > [Application]

### NOTE

If the user authentication screen appears, enter your login user name and login password and select [Login]. For this, you need to log in with administrator privileges.

The factory default login user name and login password are set as shown below.

Login user name

ECOSYS M8124cidn:2400, ECOSYS M8130cidn:3000

Login Password

ECOSYS M8124cidn:2400, ECOSYS M8130cidn:3000

### 2 Install the application.

1 Select [**+**] and/or [Menu] > [Add].

2 Insert the removable memory containing the application to be installed into the USB Memory Slot.

### NOTE

When the message "Removable Memory was recognized. Displaying files. Are you sure?" is displayed, select [No]. If a confirmation message appears on the operation panel of the machine, select [No].

3 Select the application to be installed > [Install]

You can view detailed information on the selected application by selecting [].

4 Select [Yes] to display the removable memory screen.

Installation of the application begins. Depending on the application being installed, the installation may take some time.

Once the installation ends, the original screen reappears.

### NOTE

- To install another application, repeat steps 2-3 and 2-4.
- To remove the removable memory, select [Remove Memory] and wait until the message "Removable Memory can be safely removed." appears. Then remove the removable memory.

## Uninstalling Applications

### 1 Display the screen.

[System Menu / Counter] key > [Application] > [Application]



#### NOTE

If the user authentication screen appears, enter your login user name and login password and select [Login]. For this, you need to log in with administrator privileges.

The factory default login user name and login password are set as shown below.

Login User Name

ECOSYS M8124cidn:2400, ECOSYS M8130cidn:3000

Login Password

ECOSYS M8124cidn:2400, ECOSYS M8130cidn:3000

### 2 Deleting an Application.

1 Select the application you want to delete > [🗑️].

You can view detailed information on the selected application by selecting [🔍].

2 Select [Yes] in the confirmation screen.

# 3 Preparation before Use

This chapter explains the following topics:

Using the Operation Panel .....	3-3
Assigning a Function to a Function Key .....	3-4
Using the Operation Panel .....	3-6
Display the Home screen .....	3-6
Display for Device Information .....	3-11
Functions key .....	3-11
Displaying Keys That Cannot be Configured .....	3-12
Using the [Enter] Key .....	3-12
Using the [Quick No. Search] Key .....	3-13
Help Screen .....	3-13
Login/Logout .....	3-14
Login .....	3-14
Simple Login .....	3-15
Logout .....	3-15
Check the counter .....	3-16
Loading paper .....	3-17
Precaution for Loading Paper .....	3-17
Selecting the paper feeder unit .....	3-18
Loading in the Cassettes 1 (to 3) .....	3-19
Preparation for Sending a Document to a Shared Folder in a PC .....	3-22
Making a note of the computer name and full computer name .....	3-22
Making a note of the user name and domain name .....	3-23
Configuring Shared Folder Access Permissions .....	3-23
Creating a Shared Folder, Making a Note of a Shared Folder .....	3-24
Sharing File and Printers .....	3-27
Configuring Windows Firewall Settings .....	3-28
Adding a Destination .....	3-32
Adding a Destination (Address Book) .....	3-32
Changing an Address Book Destination .....	3-36
Deleting an Address Book Destination .....	3-37
Assigning a Destination to a One Touch Key .....	3-37
Editing One Touch Key .....	3-38
Deleting the Destination to the One Touch Key .....	3-39
Using Command Center RX to Add Destinations to the Address Book .....	3-40
Recalling Frequently Used Functions (Favorites) .....	3-41
Adding to Favorites in Wizard Mode .....	3-42
Adding to Favorites in Program Mode .....	3-43
Executing Favorites in Wizard Mode .....	3-44
Executing Favorites in Program Mode .....	3-45
Editing a Favorite .....	3-45
Deleting a Favorite .....	3-45
Registering Shortcuts (Copy, Send, and Document Box Settings) .....	3-46
Adding Shortcuts .....	3-46
Edit the shortcut .....	3-46
Deleting a Shortcut .....	3-47
Using Document Boxes .....	3-48
What is Custom Box? .....	3-48
What is Job Box? .....	3-48
What is Removable Memory Box? .....	3-49

The F Code Box, Polling Box, and FAX Memory Receive Box are for storing FAX data. ....	3-49
Using Machine Operations to Create a New Custom Box .....	3-49
Using Command Center RX to Create a New Custom Box .....	3-51
Edit the custom box. ....	3-52
Deleting Custom Box .....	3-53

# Using the Operation Panel

ECOSYS M8130cidn

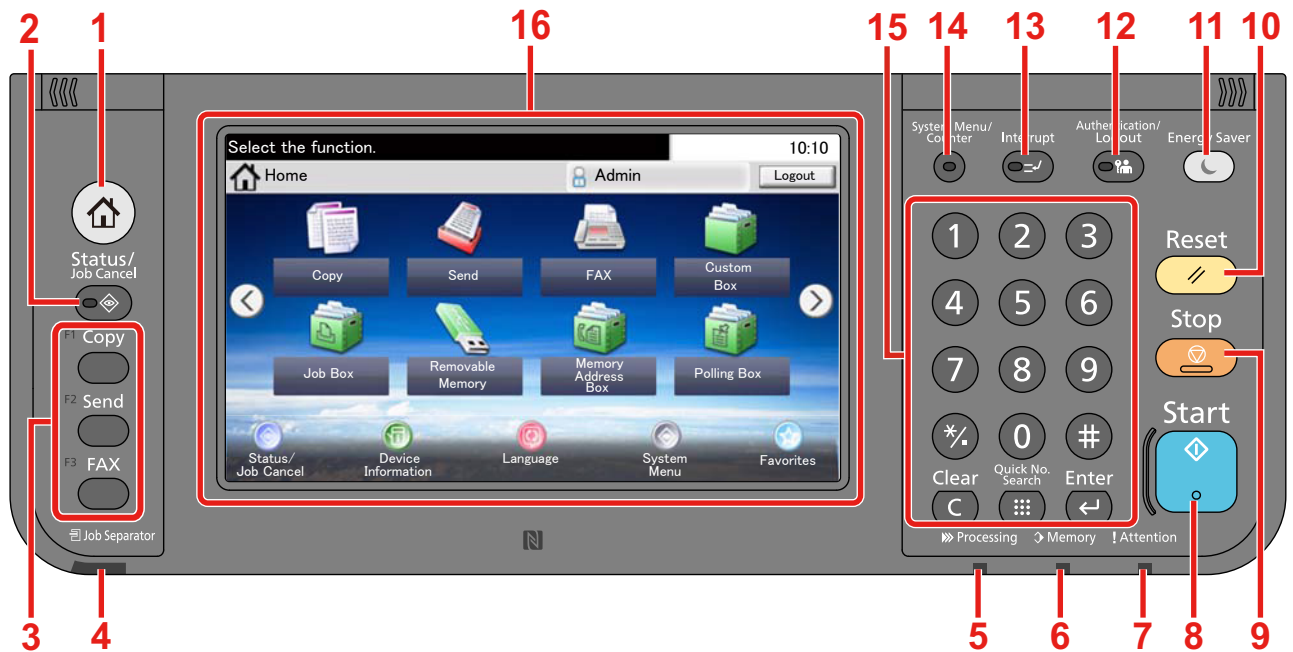

- 1 [Home] key: Displays the Home screen.
- 2 [Status / Job Cancel] key: Displays the Status/Job Cancel screen.
- 3 Function Key: These keys enable various functions and applications, including copy and scan, to be registered.  
➔ Assigning a Function to a Function Key
- 4 [Job Separator] indicator: Lights when there is paper in the job separator tray.
- 5 [Processing] indicator: Blinks while printing or sending/receiving.
- 6 [Memory] indicator: Blinks while the machine is accessing the hard disk, fax memory or USB memory (general purpose item).
- 7 [Attention] indicator: Lights or blinks when an error occurs and a job is stopped.
- 8 [Start] key: Starts copying and scanning operations and processing for setting operations.
- 9 [Stop] key: Cancels or pauses the job in progress.
- 10 [Reset] key: Returns settings to their default states.
- 11 [Energy Saver] key: Puts the machine into Sleep Mode. Recovers from Sleep if in Sleep Mode.
- 12 [Authentication / Logout] key: Authenticates user switching, and exits the operation for the current user (i.e. log out).
- 13 [Interrupt] key: Displays the Interrupt Copy screen.
- 14 [System Menu / Counter] key: Displays the System Menu screen.
- 15 [Numeric Keypad] key: Numeric keys. Enter numbers and symbols.
- 16 Touch Panel: Displays buttons for configuring machine settings.

# Assigning a Function to a Function Key

These keys enable various functions and applications, including copy and scan, to be registered. You can assign a function or application to a function key for easy access to the applicable display screen.

The following functions are allocated to this machine but can be changed and register another function.

- [F1] (Function Key 1): Copy
- [F2] (Function Key 2): Send
- [F3] (Function Key 3): FAX (option)

## 1 Display a screen.

[System Menu / Counter] key > [Common Settings] > [Function Key Assignment]



### NOTE

If the user authentication screen appears, enter your login user name and login password and select [Login]. For this, you need to log in with administrator privileges.

The factory default login user name and login password are set as shown below.

Login user name

ECOSYS M8124cidn:2400, ECOSYS M8130cidn:3000

Login Password

ECOSYS M8124cidn:2400, ECOSYS M8130cidn:3000

## 2 Configure the settings.

- 1 Select the function key whose setting you want to change.



## 2 Select the function you want to assign to the key.

Function	Description	Reference Page
None	No function assigned.	-
Copy	Displays the Copy screen.	<a href="#">5-12</a>
Send	Displays the Send screen.	<a href="#">5-14</a>
FAX Server <sup>*1</sup>	Displays the FAX Server screen.	<a href="#">5-24</a>
FAX <sup>*1</sup>	Displays the FAX screen.	FAX Operation Guide
Custom Box <sup>*2</sup>	Displays the Custom Box screen.	<a href="#">3-48</a>
Job Box	Displays the Job Box screen.	<a href="#">5-40</a>
Removable Memory	Displays the Removable Memory screen.	<a href="#">5-47</a>
Sub Address Box <sup>*1</sup>	Displays the Sub Address Box screen.	FAX Operation Guide
Polling Box <sup>*1</sup>	Operate the polling box.	FAX Operation Guide
Send to Me (E-mail) <sup>*3</sup>	Displays the Send screen. The E-mail address of the logged-in user is set as the destination.	<a href="#">5-23</a>
FAX Memory RX Box <sup>*1</sup>	Displays the FAX Memory RX box screen.	Command Center RX User Guide
Favorites	Calls up the registered program.	<a href="#">3-41</a>
Application Name	Displays the selected applications.	<a href="#">2-54</a>

\*1 Displayed only when the optional fax function is installed.

\*2 Displayed only when an optional SSD is installed.

\*3 Displayed when user login administration is enabled.

# Using the Operation Panel

## Display the Home screen

This screen is displayed by selecting the [Home] key on the operation panel. Selecting an icon will display the corresponding screen.

You can change the icons to display on the Home screen as well as its background.

➔ [Editing the Home Screen \(3-8\)](#)

ECOSYS M8130cidn

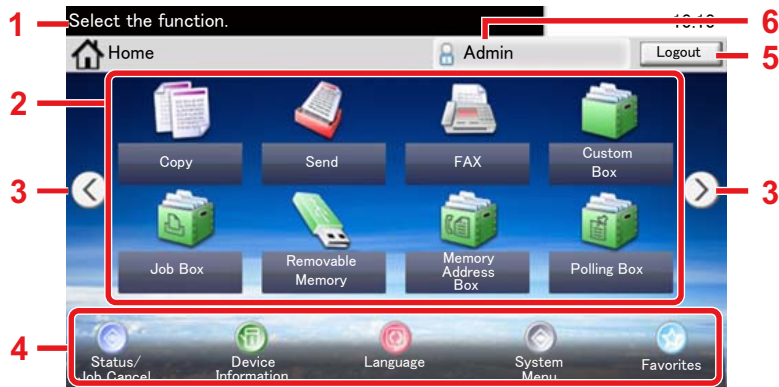

\*The appearance may differ from your actual screen, depending on your configuration and option settings.

Job No.	Item	Description
1	Message	Displays the message depending on the status.
2	Desktop	Displays function. Registered function to favorites are also displayed. Icons that are not displayed on the first page will appear by changing the page.
3	Screen-switching keys	Use these buttons to switch between desktop pages. This is displayed when there are multiple pages.  <div data-bbox="555 1308 687 1344" data-label="Section-Header"> <p> <b>NOTE</b></p> </div> <div data-bbox="552 1352 1495 1420" data-label="Text"> <p>You can also switch views by touching the screen and moving the finger sideways (i.e. swiping).</p> </div> <div data-bbox="692 1442 1353 1832" data-label="Image"> </div>
4	Taskbar	Displays task icons.
5	[Logout]	Logout. This is displayed when user login administration is enabled.
6	Login User Name	Displays the logged-in user name. This is displayed when user login administration is enabled. Selecting "Login User Name" will display the information of the logged-in user.

ECOSYS M8124cidn

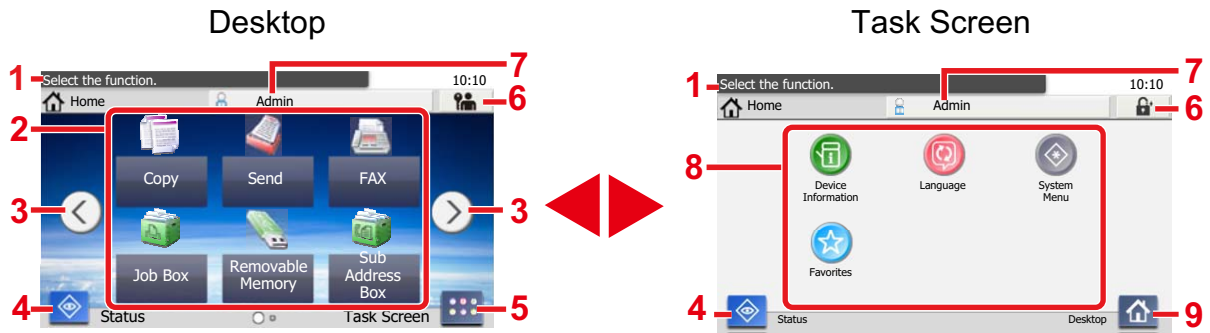

\*The appearance may differ from your actual screen, depending on your configuration and option settings.

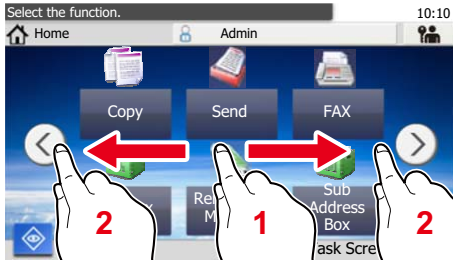
Job No.	Item	Description
1	Message	Displays the message depending on the status.
2	Desktop	Displays function. Registered function to favorites are also displayed. Icons that are not displayed on the first page will appear by changing the page.
3	Screen-switching keys	Use these buttons to switch between desktop pages. This is displayed when there are multiple pages.   <b>NOTE</b> You can also switch views by touching the screen and moving the finger sideways (i.e. swiping).  
4	[Status]	Displays the Status screen. If an error occurs, the icon will show "!". screen appears. Once the error clears, the display will return to normal.
5	[Task Screen]	Displays the Task screen.
6	[Logout]	Logout. This is displayed when user login administration is enabled.
7	Login User Name	Displays the logged-in user name. This is displayed when user login administration is enabled. Selecting "Login User Name" will display the information of the logged-in user.
8	Task Screen	Displays task icons.
9	[Desktop]	Displays the Desktop.

## Editing the Home Screen

You can change the background of the Home screen as well as which icons are displayed.

### 1 Display a screen.

[System Menu / Counter] key > [Home]

#### NOTE

If user login administration is enabled, you can only change the settings by logging in with administrator privileges.

The factory default login user name and login password are set as shown below.

Login user name

ECOSYS M8124cidn:2400, ECOSYS M8130cidn:3000

Login Password

ECOSYS M8124cidn:2400, ECOSYS M8130cidn:3000

### 2 Configure the settings.

The settings below can be configured.

Item	Description
<b>Customize Desktop</b>	Specify the function icons to display on the desktop.* <sup>1</sup> Select [Add]* <sup>3</sup> or [ + ]* <sup>4</sup> to display the screen for selecting the function to display. Select the function to display and then [OK]. Select an icon and [Previous] or [After] to change the display position of the selected icon on the Desktop. To delete an icon from the desktop, select it and then select [Delete]* <sup>3</sup> or [  ]* <sup>4</sup> .
<b>Customize Taskbar</b> * <sup>3</sup>	Specify the task icons to display on the taskbar.* <sup>2</sup>
<b>Task Screen Settings</b> * <sup>4</sup>	These settings specify the function displayed in the lower left of the Home screen and the task icons displayed on the Task screen.* <sup>2</sup>
<b>Wallpaper</b>	Configure the wallpaper of the Home screen. <a href="#">Value</a> : Images 1 to 8

\*1 Displays a maximum of 61 function icons including installed applications and functions that can be used when options are installed.

\*2 The maximum number of task icons that can be displayed are shown below.

ECOSYS M8130cidn:8

ECOSYS M8124cidn:6

\*3 ECOSYS M8130cidn

\*4 ECOSYS M8124cidn

## Available Functions to Display on Desktop

Function	Icon	Description	Reference Page
Copy <sup>*1</sup>		Displays the Copy screen.	<a href="#">5-12</a>
Send <sup>*1</sup>		Displays the Send screen.	<a href="#">5-14</a>
FAX Server		Displays the FAX Server screen.	<a href="#">5-24</a>
FAX <sup>*2</sup>		Displays the FAX screen.	FAX Operation Guide
Custom Box <sup>*3</sup>		Displays the Custom Box screen.	<a href="#">3-48</a>
Job Box <sup>*1</sup>		Displays the Job Box screen.	<a href="#">3-48</a>
Removable Memory <sup>*1</sup>		Displays the Removable Memory screen.	<a href="#">3-49</a>
Polling Box <sup>*2</sup>		Displays the polling box.	FAX Operation Guide
FAX Memory RX Box <sup>*2</sup>		Displays the FAX Memory RX box screen.	FAX Operation Guide
Send to Me (E-mail) <sup>*4</sup>		Displays the Send screen. The E-mail address of the logged-in user is set as the destination.	<a href="#">5-23</a>
Send to Me (E-mail) from Box (E-mail) <sup>*3*4</sup>		Displays the Custom Box screen. The E-mail address of the logged-in user is set as the destination.	<a href="#">5-38</a>
Favorites		Calls up the registered program. The icon will change according to the function of the program.	<a href="#">3-41</a>
Application Name <sup>*5</sup>		Displays the selected applications.	<a href="#">2-54</a>

\*1 Selected at the time of shipment from factory.









\*2 Displayed only on products with the fax function installed.

\*3 Display only when an optional SSD is installed.

\*4 This is displayed when user login administration is enabled.

\*5 The icon of the application appears.

### Displayable Functions on the Taskbar\*\* or Task Screen<sup>\*3</sup>

Function	Icon	Description	Reference Page
Status/Job Cancel		Displays the Status screen. If an error occurs, the icon will show "!". Once the error clears, the display will return to normal.	-
Device Information		Displays the Device Information screen. Allows you to check system and network information, as well as options that are used.	<a href="#">3-11</a>
Language		Displays the Language setting screen in System Menu.	<a href="#">8-4</a>
Paper Settings		Display the paper settings screen.	<a href="#">8-9</a>
Wi-Fi Direct		Configures Wi-Fi Direct settings and displays a list of information about machines that are enabled to use the network.	<a href="#">2-19</a>
System Menu		Displays the System Menu screen.	<a href="#">8-1</a>
Favorites		Displays a list of favorites.	<a href="#">3-41</a>
Outgoing FAX Log <sup>*1</sup>		Displays the Outgoing FAX Log screen.	FAX Operation Guide
Incoming FAX Log <sup>*1</sup>		Displays the Incoming FAX Log screen.	FAX Operation Guide

\*1 Displayed only when the optional fax function is installed.

\*2 ECOSYS M8130cidn

\*3 ECOSYS M8124cidn

## Display for Device Information

Shows device information. Allows you to check system and network information, as well as options that are used.

### 1 Displays the Device Information screen.

For ECOSYS M8130cidn: [Home] key > Task number [Device Information]

For ECOSYS M8124cidn: [Home] key > [Task Screen] > [Device Information]

### 2 Check the device information.

Tab	Display
Identification/Wired Network	You can check ID information such as the model name, serial number, host name and location, and the IP address.
Wi-Fi <sup>*1</sup>	You can check ID information such as the model name, serial number, host name and location, and the IP address.
FAX <sup>*2</sup>	You can check the local fax number, local fax name, local fax ID and other fax information.
Software Version/Capability	You can check the software version and performance.
Option	You can check information on the options that are used.

\*1 Displayed only when the Wireless Network Interface Kit is installed.

The Wireless Network Interface Kit is an option for some models. Contact your dealer or our sales or service representatives for detail.

➔ [IB-36 <Wireless Network Interface Kit> \(12-3\)](#)

\*2 Displayed only when the optional fax function is installed.

## Functions key

### 1 This screen is appears when a function icon is selected.

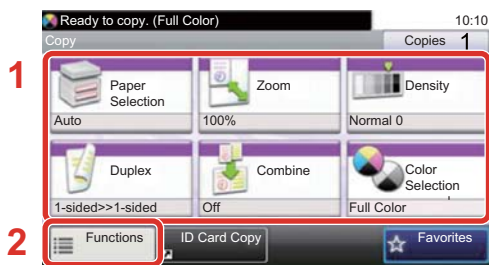

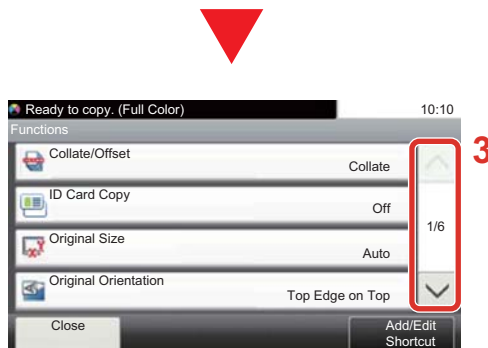

- 1 The function is displayed.
- 2 Selecting [Functions] displays other functions.
- 3 Use [^] and [v] to scroll.



## Displaying Keys That Cannot be Configured

Keys of features that cannot be used due to feature combination restrictions or non-installation of options are in a non-selectable state.

Normal	Grayed out
	 <p data-bbox="710 667 1182 723">In the following cases, the key is grayed out and cannot be selected.</p> <ul data-bbox="710 734 1150 835" style="list-style-type: none"> <li>• Cannot be used in combination with a feature that is already selected.</li> <li>• Use prohibited by user control.</li> </ul>

### NOTE

If a key that you wish to use is grayed out, the settings of the previous user may still be in effect. In this case, select the [Reset] key and try again.

If the key is still grayed out after the [Reset] key is selected, it is possible that you are prohibited from using the function by user control. Check with the administrator of the machine.

## Using the [Enter] Key

The [Enter] key has the same function as keys with the Enter mark (↵), such as the [OK↵] key and the [Close↵] key.

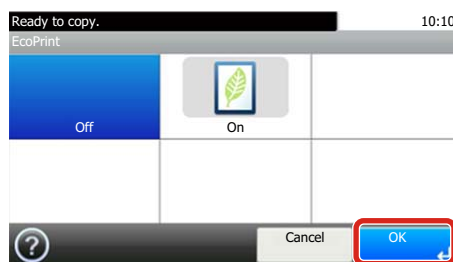



## Using the [Quick No. Search] Key

The [Quick No. Search] key performs the same action as the [Number] displayed on the touch panel. You can use it to specify the speed dial for a transmission destination directly input values using the [# Keys].

For more information on speed dialing, refer to the following:

➔ [Checking and Editing Destinations \(2-4\)](#)



## Help Screen

If you have difficulty operating the machine, you can check how to operate it using the touch panel.

When [?] (Help) is displayed on the touch panel, you can display the Help screen by touching [?] (Help). The Help screen shows explanations of functions and how to use them.

### 1 Display the Paper Selection screen.

➔ [\[Paper Selection\] \(6-5\)](#)

### 2 Display the help screen.



- 1 Shows the help title.
- 2 Displays information about functions and machine operation.
- 3 Closes the Help screen and returns to the original screen.
- 4 Scrolls up and down when the help text cannot be displayed in its entirety on a single screen.

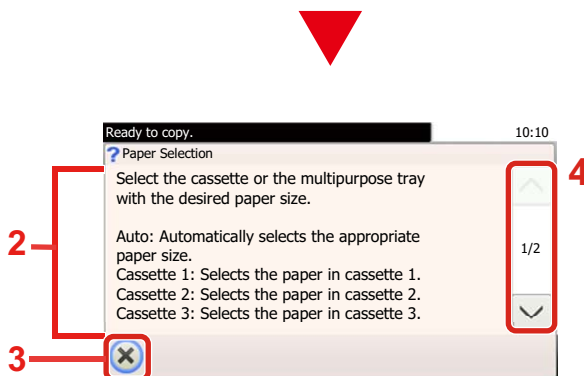

# Login/Logout

If you are setting a function that requires administrator rights, or if user login administration is enabled, you must enter your login user name and login password.

## NOTE

The factory default login user name and login password are set as shown below.

Login user name

ECOSYS M8124cidn:2400, ECOSYS M8130cidn:3000

Login password

ECOSYS M8124cidn:2400, ECOSYS M8130cidn:3000

You will be unable to login if you forget your login user name or login password. In this event, login with administrator privileges and change your login user name or login password.

## Login

### 1 Enter the login user name and login password to login.

- 1 If this screen is displayed during operations, select [Keyboard] of "Login User Name" to enter the login user name.

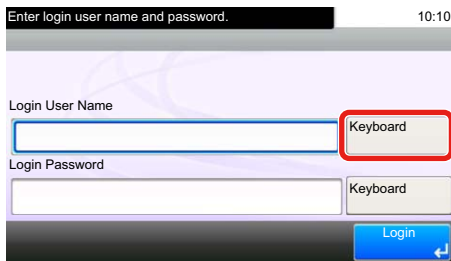

The screenshot shows a login screen with the title "Enter login user name and password." and a time display of "10:10". There are two input fields: "Login User Name" and "Login Password". Each field has a "Keyboard" button next to it, which is highlighted with a red box. At the bottom right, there is a blue "Login" button with a right arrow.

➔ [Character Entry Method \(12-13\)](#)

- 2 [Login Password] > Enter the login password > [OK]

## NOTE

If [Network Authentication] is selected as the user authentication method, authentication destinations are displayed and either [Local] or [Network] can be selected as the authentication destination.

To authenticate by ID card, select [ID Card Login].

### 2 Select [Login].

## Simple Login

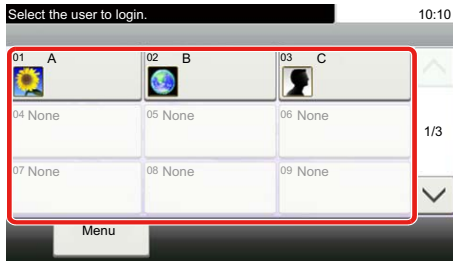

If this screen is displayed during operations, select a user and log in.



### NOTE

If a user password is required, an input screen will be displayed.

➔ [Enabling Simple Login \(9-23\)](#)

## Logout



To logout from the machine, select the [Authentication / Logout] key to return to the login user name/login password entry screen.

Users are automatically logged out in the following circumstances:

- When the machine enters the sleep state.
- When the auto panel reset function is activated.

## Check the counter

### Check the number of sheets printed and scanned.

- 1 Display the screen.  
[System Menu / Counter] key > [Counter]
- 2 Select [Printed Pages] > [Scanned Pages] to check the counter.

### Refer to the printed coverage.

- 1 Check the screen.  
[System Menu / Counter] key > [Counter] > [Printed Pages] > [Print Coverage]
- 2 The selected [Last Page] or [Last Job] data is displayed.  
[Last Page]: The data of the last printed page is displayed.  
[Last Job]: The data of the last printed job is displayed.



#### NOTE

The printing volume as calculated from information indicated on print coverage data will not match on actual printed volume. The actual printing volume varies depending on the usage (printing content, continuous printing frequency, etc.) and environmental factors (temperature and humidity).

## Loading paper

Load paper in the cassettes.

### Precaution for Loading Paper

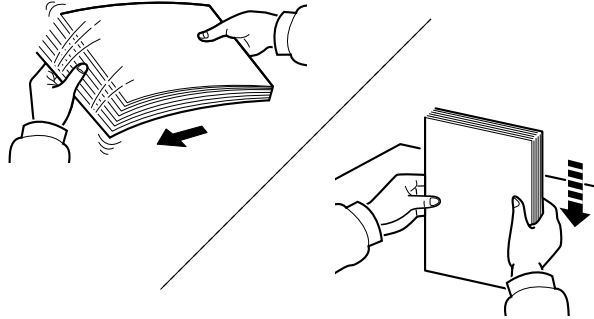

Fan the paper, then tap it on a level surface.

In addition, note the following points.

- If the paper is curled or folded, straighten it before loading. Paper that is curled or folded may cause a jam.
- Avoid exposing opened paper to high humidity as dampness can be a cause of problems. Seal any remaining paper after loading in the multi purpose tray or cassettes back in the paper storage bag.
- Leaving paper in the cassette for a long time may cause a discoloration of paper by heat from the cassette heater.
- If the machine will not be used for a prolonged period, protect all paper from humidity by removing it from the cassettes and sealing it in the paper storage bag.

#### ✔ IMPORTANT

**If you copy onto used paper (paper already used for printing), do not use paper that is stapled or clipped together. This may damage the machine or cause poor image quality.**

#### 📄 NOTE

If you use special paper such as letterhead, paper with holes or paper with pre-prints like logo or company name, refer to the following:

➔ [Paper \(12-16\)](#)

## Selecting the paper feeder unit

Select the paper feeder units according to the size and type of paper.

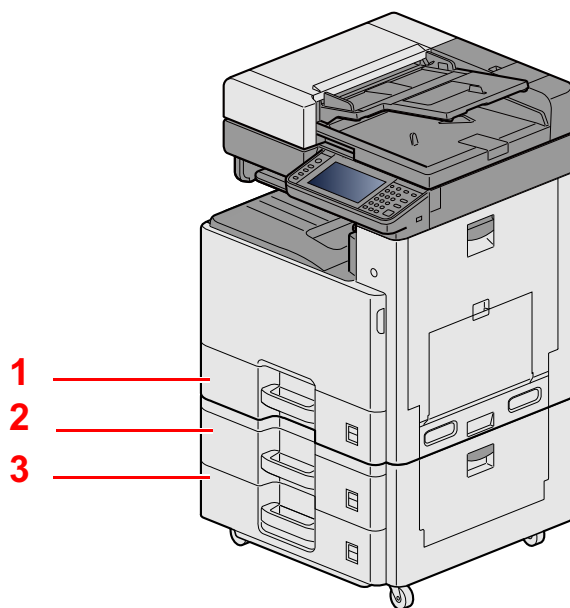

No.	Name	Paper Size	Paper Type	Capacity	Page
1	Cassette 1	A3, A4-R, A4, A5-R, B4, B5-R, B5, Ledger, Letter-R, Letter, Legal, Statement-R, Folio, 216mm×340mm, Officio II, 8K, 16K-R, 16K	Plain, Preprinted, Bond, Recycled, Vellum, Rough, Letterhead, Color, Prepunched, Thick, High Quality, Custom 1 to 8	500 sheets (80 g/m <sup>2</sup> )	<a href="#">Loading in the Cassettes 1 (to 3) (3-19)</a>
2	Cassette 2				
3	Cassette 3				

### NOTE

- The number of sheets that can be held varies depending on your environment and paper type.
- You should not use inkjet printer paper or any paper with a special surface coating. (Such paper may cause paper jams or other faults.)
- For higher quality color printing, use special color paper.

## Loading in the Cassettes 1 (to 3)

- 1 Pull the cassette completely out of the machine.

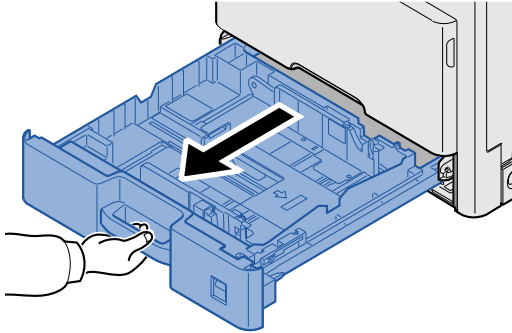

 **NOTE**

Do not pull out more than one cassette at a time.

- 2 Adjust the paper length guide to the paper size required.

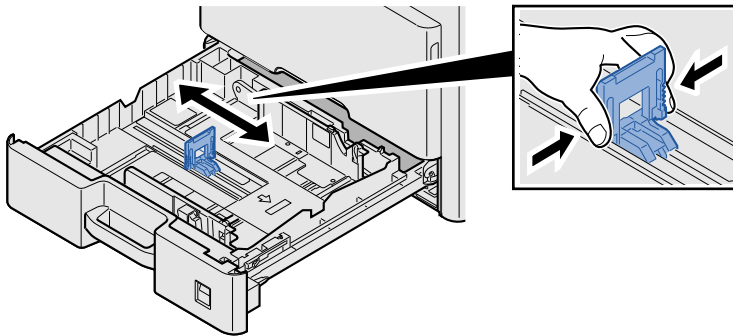

 **NOTE**

To use 11X17" (Ledger) paper, move the paper length guide all the way to the left end and tilt it.

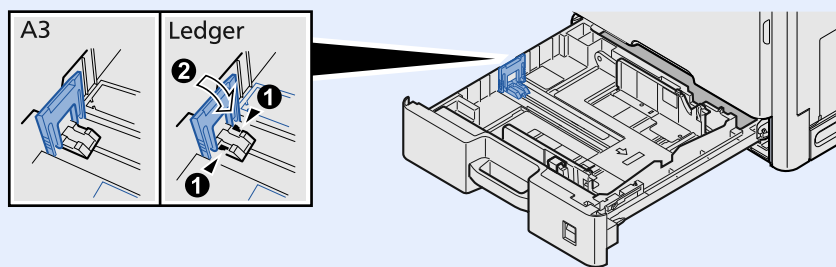

- 3 Adjust the position of the paper width guides located on the left and right sides of the cassette.**

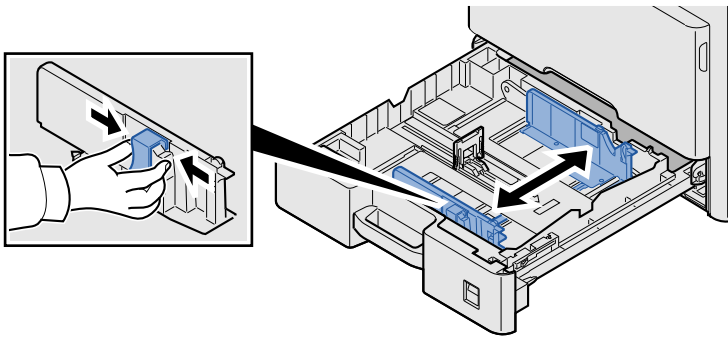

- 4 Load paper.**

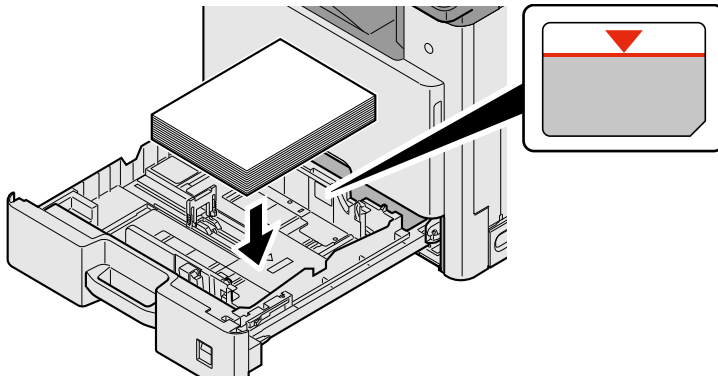

**✔ IMPORTANT**

- Load the paper with the print side facing up.
- After removing new paper from its packaging, fan the paper before loading it in the multi-purpose tray.
- ➔ [Precaution for Loading Paper \(3-17\)](#)
- Before loading the paper, be sure that it is not curled or folded. Paper that is curled or folded may cause paper jams.
- Ensure that the loaded paper does not exceed the level indicator.
- If paper is loaded without adjusting the paper length guide and paper width guide, the paper may skew or become jammed.

- 5 Be sure that the paper length and width guides rest securely against the paper.**

If there is a gap, readjust the guides to fit the paper.

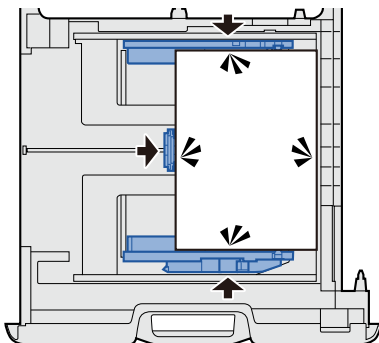



## 6 Insert sheets of the paper size

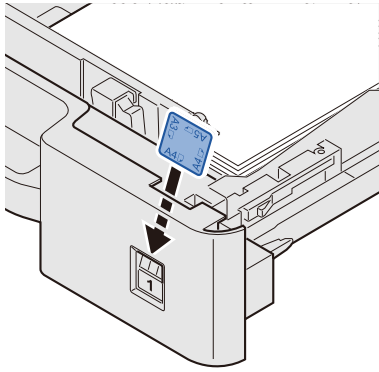

## 7 Gently push the cassette back in.

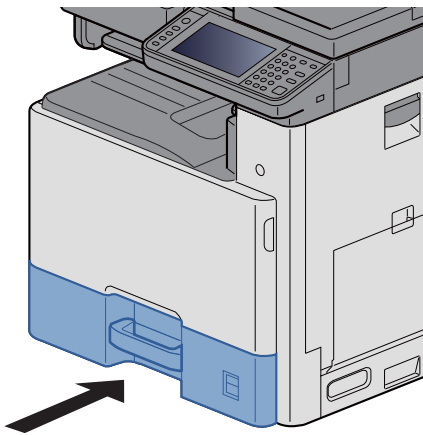

## 8 Display the screen.

[System Menu / Counter] key > [Cassette/MP Tray Settings] > [Cassette 1]

## 9 Configure the settings.

Select the paper size and paper type

➔ [\[Cassette 1 \(to 3\)\] \(8-9\)](#)

### NOTE

- If the size label is required, please contact your dealer or our sales and service representative.
- The paper size can be automatically detected. Refer to the following:

➔ [\[Paper Selection\] \(6-5\)](#)

➔ [\[Cassette 1 \(to 3\)\] \(8-9\)](#)

# Preparation for Sending a Document to a Shared Folder in a PC

Check the information that needs to be set on the machine and create a folder to receive the document on your computer. Screens of Windows 8.1 are used in the following explanation. The details of the screens will vary in other versions of Windows.

## NOTE

Log on to Windows with administrator privileges.

## Making a note of the computer name and full computer name

Check the name of the computer name and full computer name.

### 1 Display the screen.

On the start screen, right-click [PC] and then select [Properties]. Or, right-click the Window icon and select [System].

## NOTE

- In Windows Vista: Windows [Start] button > Right-click [Computer]. > [Properties]
- In Windows 7: Windows [Start] button > [Computer] > [Properties] > [System Properties]
- In Windows 8, select the desktop in the Start screen, right-click [Computer] from [Libraries] on Desktop, and then select [Properties], display "System Properties Screen".
- In Windows 10, right-click the Windows [Start] button and then select [System].

### 2 Check the status.

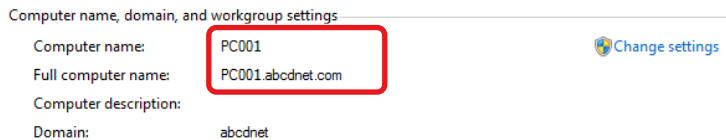

Check the computer name and full computer name.

Screen example:

Computer name: PC4050

Full computer name: pc4050.abcdnet.com

After checking the computer name, click the  [Close] button to close the "System Properties" screen.

## Making a note of the user name and domain name

Check the domain name and user name for logging onto Windows.

### 1 Display the screen.

From the desktop charms, click [Search] and then enter "command prompt" in the search box. In the list of search results, select [Command Prompt].

The Command Prompt window appears.

#### NOTE

- In Windows Vista or Windows 7: Windows [Start] button > [All Programs] (or [Programs]) > [Accessories] > [Command Prompt].
- In Windows 10, right-click the Windows [Start] button and then select [Command Prompt].

### 2 Check the status.

At the Command Prompt, enter "net config workstation" and then press [Enter].

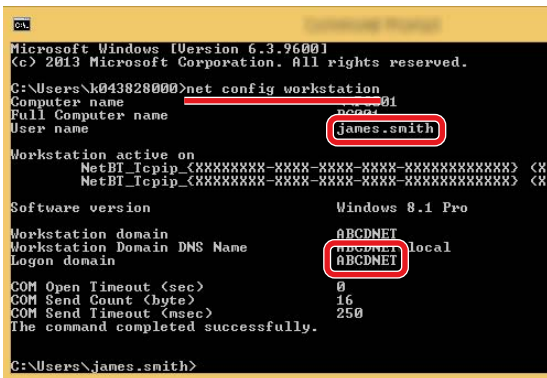

```

Microsoft Windows [Version 6.3.9600]
(c) 2013 Microsoft Corporation. All rights reserved.

C:\Users\j043828000>net config workstation
Computer name                j043828000
Full Computer name          j043828000
User name                   james.smith
Workstation active on
NetBI_Tcpip_{XXXXXXXX-XXXX-XXXX-XXXX-XXXXXXXXXXXX} <XX
NetBI_Tcpip_{XXXXXXXX-XXXX-XXXX-XXXX-XXXXXXXXXXXX} <XX
Software version            Windows 8.1 Pro
Workstation domain          ABCDNET
Workstation Domain DNS Name ABCDNET local
Logon domain                ABCDNET
COM Open Timeout (sec)     0
COM Send Count (byte)      16
COM Send Timeout (msec)    250
The command completed successfully.

C:\Users\james.smith>

```

Check the user name and domain name.

Screen example:

User Name:james.smith

Domain Name: ABCDNET

## Configuring Shared Folder Access Permissions

If there is a workgroup item in System Properties, configure the settings below to limit folder access to a specific user or group.

### 1 Display a screen.

From the desktop charms: [Settings] > [Control Panel] > [Appearance and Personalization] > [Folder Options]

#### NOTE

- In Windows Vista: [Start] > [Control Panel] > [System and Maintenance] > [Appearance and Personalization] > [Folder Options]
- In Windows 7: [Start] > [Control Panel] > [Appearance and Personalization] > [Folder Options]
- In Windows 10: Start up Explorer. > [View] > [Options] > [Folder Options]

## 2 Configure the settings.

After confirming that the [View] tab is displayed, clear the check box next to [Use Sharing Wizard (Recommended)] under "Advanced settings".

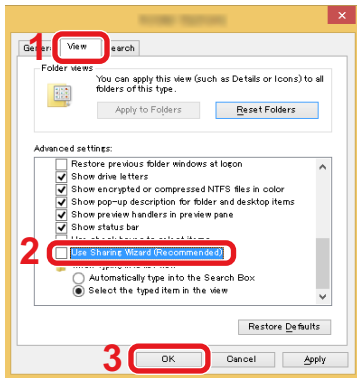

## 3 Click on the [OK] button.

# Creating a Shared Folder, Making a Note of a Shared Folder

Create a "Shared Folder" to receive the document in the destination computer.

### NOTE

If there is a workgroup in System Properties, configure the settings below to limit folder access to a specific user or group.

- 1 Select [Settings] in charms on the Desktop, and then select [Control Panel] > [Appearance and Personalization] > [Folder Options].

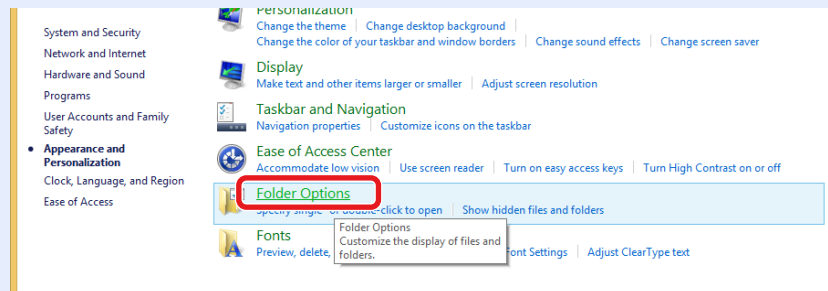

In Windows 7: [Start] > [Control Panel] > [Appearance and Personalization] > [Folder Options]

In Windows 10: Start up Explorer. > [View] > [Options] > [Folder Options]

## 2

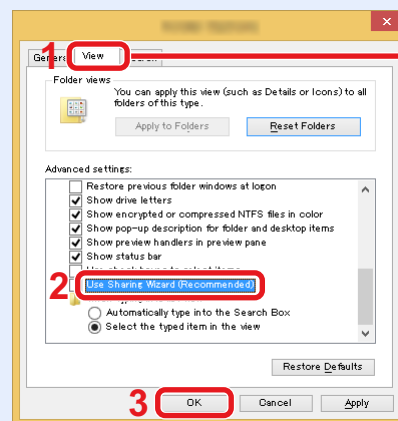

Make sure that the [View] tab is selected.

Remove the checkmark from [Use Sharing Wizard (Recommended)] in "Advanced settings".

## 1 Create a folder.

Create a folder on your computer.

For example, create a folder with the name "scannerdata" on the desktop.

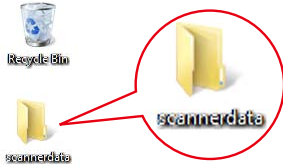

## 2 Configure permission settings.

- 1 Right-click the "scannerdata" folder and click [Share] and [Advanced sharing]. Click the [Advanced Sharing] button.

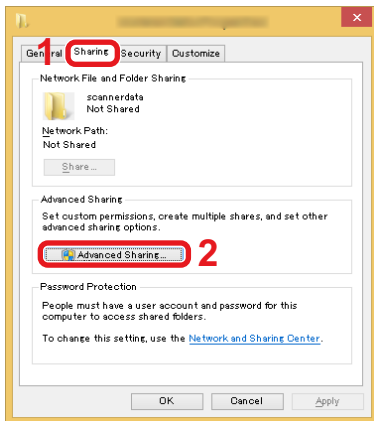

- 2 Select the [Share this folder] checkbox and click the [Permissions] button.

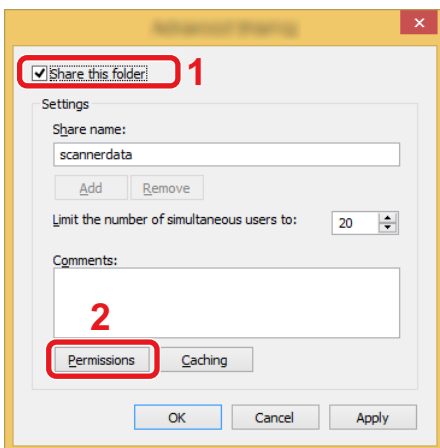

- 3 Make a note of the Share name.

4 Click the [Add] button.

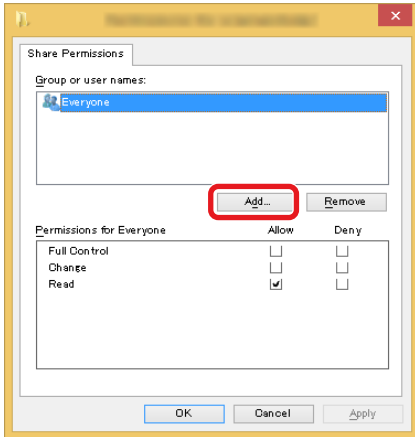

5 Specify the location.

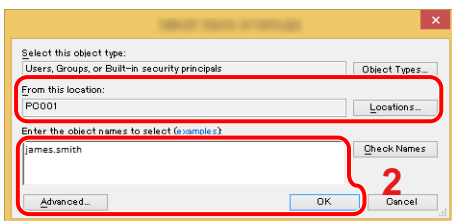

- 1 If the computer name that you made a note of on page is the same as the domain name:  
If the computer name is not shown in "From this location", click the [Locations] button, select the computer name, and click the [OK] button.

Example: pc4050

If the computer name that you made a note of on page is not the same as the domain name:

If the text after the first dot (.) in the full computer name that you made a note of does not appear in "From this location", click the [Locations] button, select the text after the dot (.), and click the [OK] button.

Example: abcdnet.com

► [Making a note of the computer name and full computer name \(3-22\)](#)

- 2 Enter the user name that you made a note of on page in the text box, and click the [OK] button.  
Also the user name can be made by clicking the [Advanced] button and selecting a user.

6 Set the access permission for the user selected.

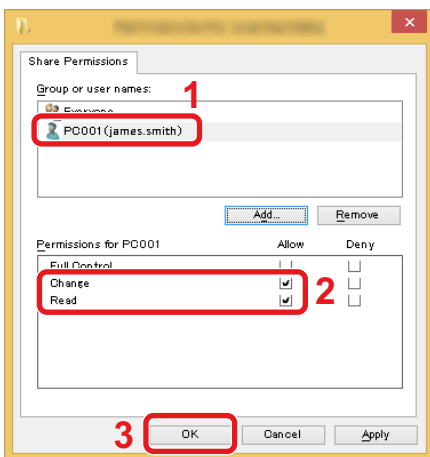

- 1 Select the user you entered.
- 2 Select the [Allow] checkbox of the "Change" and "Read" permissions.
- 3 Click the [OK] button.

**NOTE**

"Everyone" gives sharing permission to everyone on the network. To strengthen security, it is recommended that you select "Everyone" and remove the "Read" [Allow] checkmark.

- 7 Click the [OK] button in the "Advanced Sharing" screen to close the screen.
- 8 Check the details set in the [Security] tab.

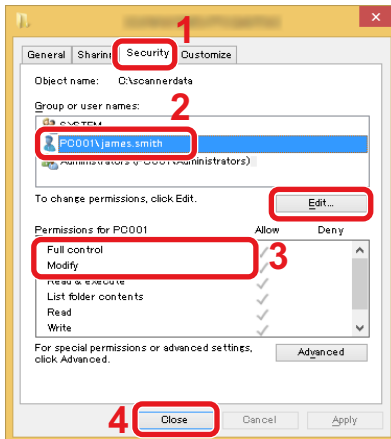

- 1 Select the [Security] tab.
- 2 Select the user you entered.
- 3 If the user does not appear on "Group or user names", click [Edit] button to add user in a similar way of configuration of permission settings.
- 4 Make sure that checkmarks appear on [Allow] checkbox for the "Modify" and "Read & execute" permissions.
- 5 Click the [Close] button.

## Sharing File and Printers

### NOTE

Log on to Windows with administrator privileges.

### 1 Display the screen.

From the desktop charms: [Settings] > [Control Panel] > [System and Security] > [Allow an app through Windows Firewall]

### NOTE

- In Windows Vista, from [Start] button on the Windows, select [Control Panel], [Security], and then [Turn Windows Firewall on or off].
- In Windows 7: [Start] button > [Control Panel] > [System and Security] > [Allow a program through Windows Firewall].

### NOTE

If the User Account Control dialog box appears, click the [Continue] button.

## 2 Select the [File and Printer Sharing] checkbox.

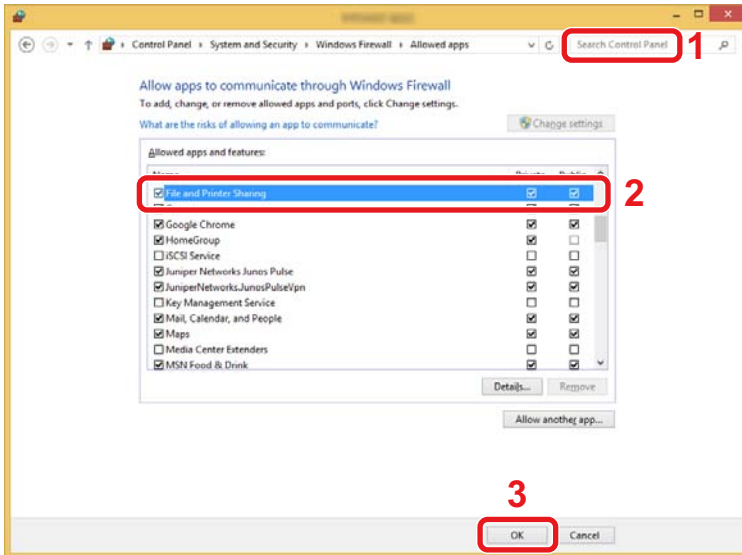

## Configuring Windows Firewall Settings

Permit sharing of files and printers and set the port used for SMB transmission.

### NOTE

Log on to Windows with administrator privileges.

### 1 Display the screen.

In charms on Desktop, click [Settings], [Control Panel], [System and Security], and then [Windows Firewall].

### NOTE

- In Windows Vista, from [Start] button on the Windows, select [Control Panel], [Security], and then [Turn Windows Firewall on or off].
- In Windows 7: [Start] button > [Control Panel] > [System and Security] > [Check firewall status].
- In Windows 8: From the desktop charms: [Settings] > [Control Panel] > [System and Security] > [Windows Firewall].
- In Windows 10: Start up Explorer. > [View] > [Options] > [Folder Options].

### NOTE

If the User Account Control dialog box appears, click the [Continue] button.



## 2 Add a port.

1 Select [Advanced settings].



### NOTE

In Windows Vista: [Exceptions] tab > [Add Port] > Perform procedure 2-5.

2 Select [Inbound Rules].

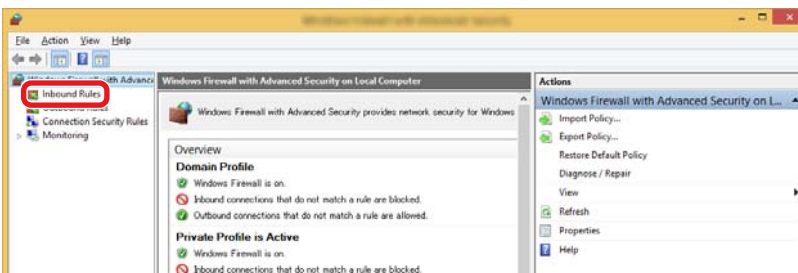

3 Select [New Rules].

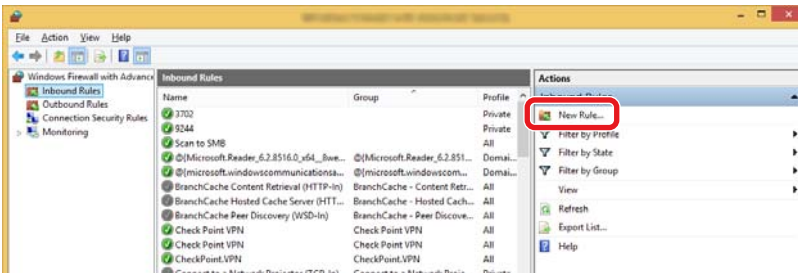

4 Select [Port].

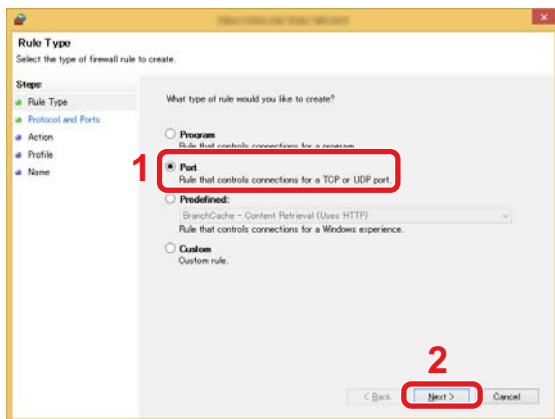

- 5 Select [TCP] as the port to apply the rule to. Then select [Specific local ports] and enter "445" then click [Next].

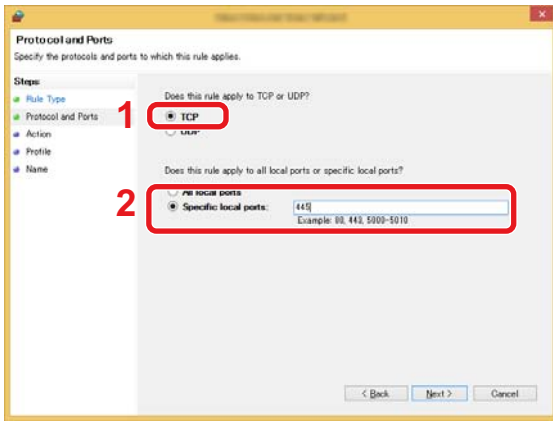

 **NOTE**

In Windows Vista, use "Name" to assign a name to the port to be added (Example: Scan to SMB). Enter "445" in "Port Number". Select [TCP] for "Protocol". After settings are the way you want, click the [OK] button.

- 6 Select [Allow the connection] and click the [Next] button.

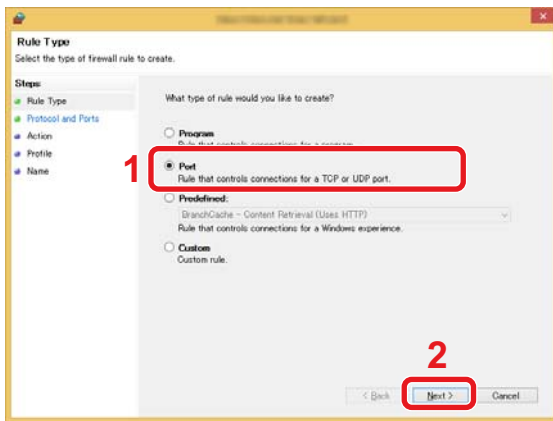

- 7 Make sure all checkboxes are selected and click the [Next] button.

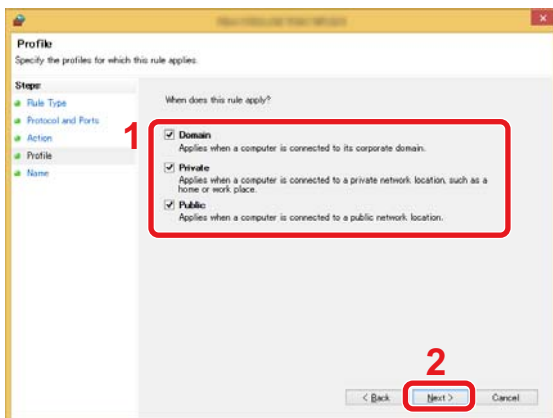

- 8 Enter "Scan to SMB" in "Name" and click [Finish].

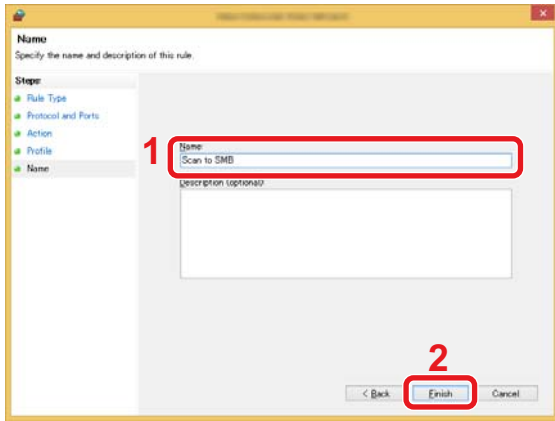

## Adding a Destination

You can assign destinations to the Address Book or One Touch Key, or modify destination assignments. Assigned destinations can be used with Send as E-mail, Send to Folder, and Fax Transmission.

 **NOTE**

Registering and editing of the Address Book can also be done in Command Center RX.

➔ [Using Command Center RX to Add Destinations to the Address Book \(3-40\)](#)

## Adding a Destination (Address Book)

This assigns a new destination to the Address Book. There are two registering methods, contacts and groups. When adding a group, enter the group name and select group members from the Address Book.

 **NOTE**

If registering and editing of the Address Book is restricted to administrators, you can edit the Address Book by logging in with administrator privileges.

➔ [\[Edit Restriction\] \(8-30\)](#)

### Registering a contact address

Each address can include information such as destination name, E-mail address, FTP server folder path, computer folder path, FAX No., etc.

Maximum number of addresses: 200

#### 1 Display a screen.

[System Menu / Counter] key > [Address Book/One Touch] > [Address Book] > [ + ] > [Individual]

#### 2 Add the name.

1 Enter the destination name to be displayed in the address book. > [Next >]

 **NOTE**

The number of characters you can enter is limited.

Maximum number of characters: Up to 32

For details on entering characters, refer to the following:

➔ [Character Entry Method \(12-13\)](#)

### 3 Add the address.

#### E-mail Address

[E-mail Address] > Enter the E-mail address. > [OK]

#### NOTE

You can enter up to 128 characters.

For details on entering characters, refer to the following:

➔ [Character Entry Method \(12-13\)](#)

#### The Folder (SMB) Address

[SMB] > [Host Name], [Path], [Port], [Login User Name] or [Login Password] > [OK]

#### NOTE

For the computer name, share name, domain name, and user name, enter the information that you noted when you created the shared folder.

For details on creating shared folders, refer to the following:

➔ [Preparation for Sending a Document to a Shared Folder in a PC \(3-22\)](#)

The table below explains the items to be entered.

Item	Description	Max. No. of Characters
Host Name	Computer name	64 characters
Path	Share name For example: scannerdata share name\folder name in shared folder share name\folder name in shared folder	128 characters
Port	Port number (Normally 445)	1-65535
Login User Name	If the computer name and domain name are the same: User Name: For example: james.smith If the computer name and domain name are different: Domain name\User name For example: abcdnet\yamada	64 characters
Login Password	Windows login password (Case sensitive.)	64 characters

To search for a folder on a PC on the network and add it, perform the operation below.

[Menu] > [Search Folder from Network] or [Search Folder by Host Name]

If you selected "Search Folder from Network", you can enter the "Domain/Workgroup", and "Host Name" to search PCs on the network for the destination.

If you pressed "Search Folder by Host Name", you can search all PCs on the network for a destination.

A maximum of 500 addresses can be displayed. To display the login user name and login password entry screen, perform the operation below.

On the screen that appears, select the host name (computer name) and then select [Next >].

 **NOTE**

- For details on entering characters, refer to the following:  
➔ [Character Entry Method \(12-13\)](#)
- Search and send are not supported when two-byte characters are used in the host name, domain name, workgroup name, or user name.
- To check the connection to the specified computer, select [Menu] > [Connection Test]. If the connection fails, check the entries you made.

**The Folder (FTP) Address**

[SMB] > [Host Name], [Path], [Port], [Login User Name] or [Login Password] > [OK]

The table below explains the items to be entered.

Item	Description	Max. No. of Characters
Host Name	Host name or IP address of FTP server	64 characters
Path* <sup>1</sup>	Path for the file to be stored For example: \User\ScanData If no path is entered, the file is stored in the home directory.	128 characters
Path	Port number (Normally 21)	1-65535
Login User Name	FTP server login user name	64 characters
Login Password	FTP server login password	64 characters

\*1 When the FTP server is based on Linux/UNIX, the path including the sub-folder is combined by the slash (/) and not the back-slash(\).

 **NOTE**

- For details on entering characters, refer to the following:  
➔ [Character Entry Method \(12-13\)](#)
- To check the connection to the specified FTP server, select [Menu] > [Connection Test]. If the connection fails, check the entries you made.

- 1 If you want to specify an address number, select [Address Number].
- 2 Use [+] / [-] or the numeric keys to enter an address number (001 to 250).  
To have the number assigned automatically, specify 000.

 **NOTE**

- An address number is ID number for a single destination. You can select any available number for groups.
- If you specify an address number that is already in use, an error message will appear and the address will not be added.

- 3 Select [OK].

**4 Check if the destination entry is correct > [Save]**

The destination is added to the Address Book.

## Adding a Group

Compile two or more contacts into a group. Designations in the group can be added at the same time.

Maximum number of groups: 50

### NOTE

Before adding a group in the Address Book, the contacts to be included in the group must be added first. Register one or more individual destinations as needed before proceeding. The number of groups that can be added is described below.

- Destinations: 100
- 5 (total) destinations for FTP and SMB

## 1 Display a screen.

[System Menu] > [Address Book/One Touch] > [Address Book] > [ + ] > [Group]

## 2 Add the name.

- 1 Enter the group name displayed on the Address Book > [Next >]

### NOTE

The number of characters you can enter is limited.

Maximum number of characters: Up to 32

For details on entering characters, refer to the following:

➔ [Character Entry Method \(12-13\)](#)

## 3 Select the members (destinations).

- 1 Select [Member].
- 2 Select [ + ].
- 3 Select destinations (contacts) to add to the group. The selected destinations are indicated by a checkmark in the check box.

### NOTE

Destinations can be sorted or searched by destination name or address number.

➔ [Checking and Editing Destinations \(2-4\)](#)

- 4 Select [OK].  
If you have more destinations to add, repeat Steps 2 to 4.
- 5 Select [End].
- 6 If you want to specify an address number, select [Address Number].

- 7 Use [+] / [-] or the numeric keys to enter an address number (000 to 250).  
For auto assignment, enter 000.

 **NOTE**

- An address number is an ID number for a single destination. You can select any available number for groups.
- If you specify an address number that is already in use, an error message will appear and the group will not be registered.

- 8 Select [OK].

## 4 Check if the selected destination was added to the group > [Save]

Now the group is added to the Address Book.

## Changing an Address Book Destination

Edit and delete the destinations (contacts) you added to the Address Book.

### 1 Display the screen.

- 1 [System Menu / Counter] key > [Address Book/One Touch] > [Address Book]

### 2 Make the changes you want.

 **NOTE**



Destinations can be sorted or searched by destination name or address number.

➔ [Checking and Editing Destinations \(2-4\)](#)

#### Editing a Contact

- 1 Select [- 2 Change "Name", "Address Number" and destination type and address.  
For details on how to edit, refer to the information below.  
➔ [Registering a contact address \(3-32\)](#)
- 3 [Save] > [Yes]  
Register the changed destination.

#### Editing a Group

- 1 Select [- 2 Change "Name" and "Address Number".  
For details on how to edit, refer to the information below.  
➔ [Adding a Group \(3-35\)](#)
- 3 Select [Member].
- 4 To delete a destination from the group, select [- 5 [Save] > [Yes]  
Register the changed destination.



## Deleting an Address Book Destination

Delete the destinations (contacts) you added to the Address Book.

### 1 Display the screen.

- 1 [System Menu / Counter] key > [Address Book/One Touch] > [Address Book]
- 2 Select a destination or group to delete.

#### NOTE

Destinations can be sorted or searched by destination name or address number.

➔ [Checking and Editing Destinations \(2-4\)](#)

### 2 > [Yes]

Delete the contact or group.

## Assigning a Destination to a One Touch Key

Assign a new destination (contact or group) to an one touch key.

Maximum number of assignments: 100

#### NOTE

- Refer to the following for use of One Touch Key.

➔ [Checking and Editing Destinations \(2-4\)](#)

- You can add One Touch keys and change their settings on Command Center RX.

➔ [Using Command Center RX to Add Destinations to the Address Book \(3-40\)](#)

- If only an administrator is allowed to perform One Touch Key registration and editing, login with administration rights is required for editing.

➔ [\[Edit Restriction\] \(8-30\)](#)

➔ [Command Center RX User Guide](#)

### 1 Display the screen.

[System Menu / Counter] key > [Address Book/One Touch] > [One Touch Key]

## 2 Add a One Touch Key.

- 1 Selecting a One Touch Key number (001 to 100) > [ + ] and then selecting the [Quick No. Search] key enables selection using direct entry of a One Touch Key number.

### NOTE

For details on the [Quick No. Search] key, refer to the information below.

➔ [Using the \[Quick No. Search\] Key \(3-13\)](#)

Select a One Touch Key with no registered destination.

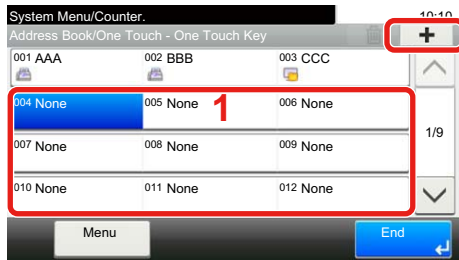

- 2 Select a destination (contact or group) to assign to the One Touch Key.  
Selecting [  ] shows detailed information about the selected destination.

### NOTE

Destinations can be sorted or searched by destination name or address number.

➔ [Checking and Editing Destinations \(2-4\)](#)

- 3 Enter the name of the One Touch Key displayed on the send base screen > [Next >].

### NOTE

The number of characters you can enter is limited.

Maximum number of characters: Up to 24

For details on entering characters, refer to the following:

➔ [Character Entry Method \(12-13\)](#)

- 4 Select [Register].  
The destination is registered to the One Touch Key.

## Editing One Touch Key

Edit the destinations you added to One Touch Key.

### 1 Display the screen.

- 1 [System Menu / Counter] key > [Address Book/One Touch] > One Touch Key]
- 2 Select a One Touch Key number (001 to 100) to edit. For direct entry of a One Touch Key number, select the [Quick No. Search] key.

### 2 Changing the Registered Information.

- 1 [Menu] > [Edit] > [Destination]

- 2 Select a new destination (contact or group). Selecting [  ] shows detailed information about the selected destination.



 **NOTE**

Destinations can be sorted or searched by destination name or address number.

➔ [Checking and Editing Destinations \(2-4\)](#)

- 3 [OK] > [Save] > [Yes]

The destination is registered to the One Touch Key.

## Deleting the Destination to the One Touch Key

Deleting the Destination to the One Touch Key.

### 1 Display the screen.

- 1 [System Menu / Counter] key > [Address Book/One Touch] > One Touch Key
- 2 Select a One Touch Key number (001 to 100) to edit. For direct entry of a One Touch Key number, select the [Quick No. Search] key.

### 2 Delete the Registered Information.

Select: [  ] > [Yes].

The data registered in the One Touch Key is deleted.

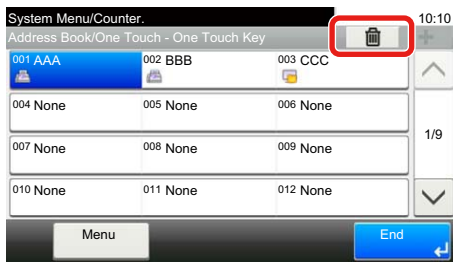

# Using Command Center RX to Add Destinations to the Address Book

You can register destinations to the machine's Address Book, from Command Center RX.

## 1 Display a screen.

- 1 Launch your Web browser.
- 2 In the address or location bar, enter the machine's IP address or the host name.  
Click in the following order to check the machine's IP address and the host name.  
On the MFP Home screen: [Device Information] > [Identification/Network]  
Example 1: https://192.168.48.21/ (for IP address)  
Example 2: https://MFP001 (if the host name is "MFP001")

- 3 Log in with administrator privileges.

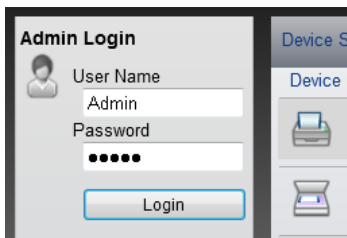

The factory default setting for the default user with administrator privileges is shown below. (Upper case and lower case letters are distinguished (case sensitive).)

Login User Name: Admin

Login Password: Admin

- 4 On the [Address Book] menu, click [Machine Address Book].

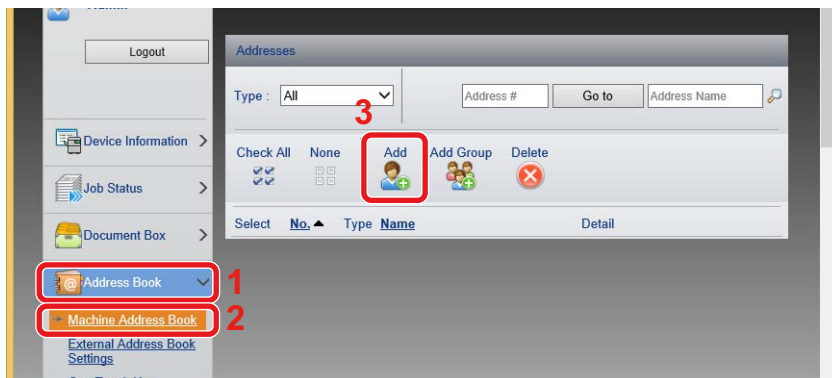

- 5 Click [Add].

## 2 Configure the settings.

- 1 Enter the destination information.  
Enter the information for the destination you want to register. The fields to populate are the same as when registering via operation panel.  
[➔ Adding a Destination \(3-32\)](#)
- 2 Click [Submit].

# Recalling Frequently Used Functions (Favorites)

After you add frequently used functions to Favorites, you can recall them quickly and easily.

You can also name the programs for easy identification when recalling.

Program name	Description	Default Registration
<b>ID Card Copy</b>	Use this when you want to copy a driver's license or an insurance card. When you scan the front and back of the card, both sides will be combined and copied onto a single sheet.	<ul style="list-style-type: none"> <li>• Copy Function</li> <li>• Program Mode</li> </ul> ID Card Copy: [On] Continuous Scan: [On] Original Size: A5-R Paper Selection: Cassette 1 Zoom: [100%]
<b>Paper Saving Copy</b>	Use this to save paper. You can configure page combination and paper saving setting by following the instructions on the screen.	<ul style="list-style-type: none"> <li>• Copy Function</li> <li>• Wizard Mode</li> </ul> Combine: [2 in 1] Original: [1-sided] Duplex: [2-sided] Paper Selection: Cassette 1 Number of Copies: 1
<b>Simple Folder Send (destination entry)</b>	Use this when you want to send an image to any shared folder on a computer or to the FTP folder. You can configure destination, color, and other settings as indicated by the instructions that appear.	<ul style="list-style-type: none"> <li>• Transmission Function</li> <li>• Wizard Mode</li> </ul> Destination: New folder Color: Full Color Document Name Entry: Initial default File Format: [PDF] Continuous Scan: [Off] Scan Resolution: [300 × 300 dpi]
<b>Scan to PC (Address Book)</b>	Use this when you want to send an image to any shared folder on a computer registered in the Address Book or to the FTP folder. You can configure destination, color, and other settings as indicated by the instructions that appear.	<ul style="list-style-type: none"> <li>• Transmission Function</li> <li>• Wizard Mode</li> </ul> Destination: Address Book Color: Full Color Document Name Entry: Initial default File Format: [PDF] Continuous Scan: [Off] Scan Resolution: [300 × 300 dpi]
<b>Simple Mail Send (Destination Entered)</b>	Use this when you want to send an image to any destination E-mail address. You can configure destination, color, and other settings as indicated by the instructions that appear.	<ul style="list-style-type: none"> <li>• Transmission Function</li> <li>• Wizard Mode</li> </ul> Destination: New E-mail address Color: Full Color Document Name Entry: Initial default File Format: [PDF] Continuous Scan: [Off] Scan Resolution: [300 × 300 dpi] E-mail Subject: Initial default Mail Body: Initial default

Program name	Description	Default Registration
<b>Simple E-mail Send (Address Book)</b>	Use this when you want to send an image to any destination E-mail address registered in the Address Book. You can configure destination, color, and other settings as indicated by the instructions that appear.	<ul style="list-style-type: none"> <li>• Transmission Function</li> <li>• Wizard Mode</li> </ul> Destination: Address Book Color: Full Color Document Name Entry: Initial default File Format: [PDF] Continuous Scan: [Off] Scan Resolution: [300 × 300 dpi] E-mail Subject: Initial default Mail Body: Initial default

**NOTE**

Up to 20 functions combining copying and sending can be registered in the program.

You can select a favorite using either of two recall methods and register it.

- Wizard Mode (Selection Dialog): Registered settings are recalled in sequence, so settings are configured by confirming or modifying them.
- Program Mode: Selecting a key that is a favorite immediately recalls the applicable setting.

## Adding to Favorites in Wizard Mode

Here we will provide an example send operation.

### 1 Display a screen.

[Home] key > [Send] > [Favorites]

### 2 Adds Favorites.

1 [Menu] > [Add]

2 Select the job type.

3 Select [Wizard].

4 Select the function to recall > [Next >]

The selected item is shown by the wizard.

**NOTE**

The "Destination Recall Method" selection screen does not appear when the job type is Copy].

5 Enter a name for the favorite. > [Next >]

➔ [Character Entry Method \(12-13\)](#)

- 6 Check the content. Change or add information as needed.

Item	Description
<b>Name</b>	Enter up to 32 characters for the name that appears on the Favorites screen.
<b>Add - Job Type</b>	Shows the type of the selected job.
<b>Number<sup>*1</sup></b>	Enter a number for the favorite. If you specify "00" as the address number, the address is added under the lowest available number.
<b>Owner<sup>*2</sup></b>	Shows the user.
<b>Permission<sup>*2</sup></b>	Specifies whether favorites should be shared with other users.
<b>Destination<sup>*3</sup></b>	Checks a destination.
<b>Functions</b>	Use the Wizard to select the displayed functions.
<b>Function Type</b>	Selects the method used to recall favorites.

\*1 If user login administration is enabled, you can only change settings by logging in with administrator privileges.

\*2 Displayed when user login administration is enabled.

\*3 Displayed when the "Job Type" setting is [Send] or [FAX].

- 7 Select [Register].

This adds the favorite.

- 8 "Do you want to add a new function to the home screen?" screen appears. To display a favorite to the Home screen, select [Yes], specify the location where you want to display the icon of the favorite, and then select [Save].

## Adding to Favorites in Program Mode

If you are planning to select the Program Mode, first configure the copy function, transmission function, FAX function, send destination, and/or other settings to be added to Favorites.

### 1 Display a screen.

1 [Home] key > [Send]

2 This configures send function and/or destination settings to be registered in a program.

3 Select [Favorites].

### 2 Adds Favorites.

1 [Menu] > [Add]

2 Select the job type.

3 Select [Program].

4 Enter a name for the favorite. > [Next >]

➔ [Character Entry Method \(12-13\)](#)

- 5 Check the content. Change or add information as needed.

Item	Description
<b>Name</b>	Enter up to 32 characters for the name that appears on the Favorites screen.
<b>Add - Job Type</b>	Shows the type of the selected job.
<b>Number<sup>*1</sup></b>	Enter a number for the favorite. If you specify "00" as the address number, the address is added under the lowest available number.
<b>Owner<sup>*2</sup></b>	Shows the user.
<b>Permission<sup>*2</sup></b>	Specifies whether favorites should be shared with other users.
<b>Function Format</b>	Selects the method used to recall favorites.

\*1 If user login administration is enabled, you can only change settings by logging in with administrator privileges.

\*2 Displayed when user login administration is enabled.

- 6 Select [Register].

This adds the favorite.

- 7 "Do you want to add a new function to the home screen?" screen appears. To display a favorite to the Home screen, select [Yes], specify the location where you want to display the icon of the favorite, and then select [Save].

## Executing Favorites in Wizard Mode

The procedure for recalling and executing a favorite in Wizard Mode is shown below.

### 1 Recalling the favorite.

- 1 On the Home screen, select [Favorites] or select the key of a favorite.  
If you selected the key of a favorite, that favorite will be recalled. If you selected [Favorites], proceed with the following steps.
- 2 Select the key of the favorite you want to recall.

### 2 This executes the favorite.

- 1 A series of screens will appear, so configure settings and then select [Next >].  
The Transmit Settings dialog box will appear.



#### NOTE

To change a setting, select [< Back] and then make the changes you want.

- 2 Place the originals > [Start] key



## Executing Favorites in Program Mode

Use the procedure below to recall and execute a favorite in Program Mode.

### 1 Recalling the favorite.

- 1 On the Home screen, select [Favorites] or select the key of a favorite.  
If you selected the key of a favorite, that favorite will be recalled. If you selected [Favorites], proceed with the following steps.
- 2 Select the key of the favorite you want to recall.

### 2 This executes the favorite.

- 1 Place the originals > [Start] key

## Editing a Favorite

You can use the procedure in this section to modify favorite numbers, favorite names, and sharing settings.

Use the procedure below to edit favorites.

### 1 Display a screen.

- 1 [Home] key > [Favorites]

### 2 Editing a Favorite.

- 1 [Menu] > [Edit]
- 2 Select the favorite you want to modify.
- 3 Modify the favorite name, favorite number, and/or sharing settings.  
Adding to Favorites in Wizard Mode.
- 4 [Save] > [Yes]

## Deleting a Favorite

You can use the procedure below to delete a favorite.

Use the procedure below to delete a favorite.

### 1 Display a screen.

- 1 [Home] key > [Send] > [Favorites]

### 2 Delete the favorite.

- 1 [Menu] > [Delete]
- 2 Select the favorite you want to delete.
- 3 Select [Yes].

# Registering Shortcuts (Copy, Send, and Document Box Settings)

You can register shortcuts in the Quick Setup screen for easy access to the frequently used functions. The function name displayed by a short cut key can also be modified as required.

## NOTE

You can register up to 2 shortcuts for copying functions, sending functions, and functions set for document box.

## Adding Shortcuts

Shortcut registration is performed on the function list screen. Use the procedure below to register a shortcut.

### 1 Display the screen.

The steps below can be performed while the Copy, Send, FAX, or Document Box screen is displayed.

[Functions] > [Add/Edit Shortcut]

### 2 Adding Shortcuts.

#### 1 Select [Add].

A shortcut consists of the contents described below.

<b>Private Shortcut 1, 2</b>	Shortcuts that can be used by the logged in user only. Shortcuts can be registered only while user login administration is in effect.
<b>Shared Shortcut 1, 2</b>	Shortcuts that can be used by all MFP users. If user login administration is in effect, shortcuts can be registered only when logged in with administrator privileges.

#### 2 Select the setting you want to add.

## NOTE

If you select a shortcut number already registered, the currently registered shortcut can be replaced with a new one.

#### 3 Enter the name. > [Next >].

Up to 24 characters can be entered.

➔ Character Entry Method

#### 4 Select [Register].

The shortcut is registered.

## Edit the shortcut

### 1 Display the screen.

The steps below can be performed while the Copy, Send, FAX, or Document Box screen is displayed.

[Functions] > [Add/Edit Shortcut]

### 2 Edit the shortcut.

#### 1 Select [Edit].

#### 2 Select the shortcut key you want to edit.

3 [Number] or [Name] > Modify settings. > [OK]

4 [Save] > [Yes]

## Deleting a Shortcut

### 1 Display a screen.

The steps below can be performed while the Copy, Send, FAX, or Document Box screen is displayed.

[Functions] > [Add/Edit Shortcut]

### 2 Delete the shortcut.

1 Select [Delete].

2 Select the shortcut you want to delete. > [Yes]

# Using Document Boxes

Document Box is a function for saving print data from a computer and sharing it with multiple users.

The available Document Boxes are as follows: Custom Box, Job Box, Removable Memory Box, F Code Box, Polling Box, and FAX Memory Receive Box.

## What is Custom Box?

Custom Box is a component box which you can create within the Document Box and store data for later retrieval. You can create or delete a Custom Box.

The following operations are possible:

- Printing Documents in Custom Box ([5-43](#))
- Saving Scanned Documents to a Custom Box ([5-34](#))
- Moving Documents in a Custom Box ([5-34](#))
- Joining Documents in a Custom Box ([5-36](#))
- Deleting Documents in a Custom Box ([5-37](#))
- Sending Documents in a Custom Box ([5-37](#))



### NOTE

- To use Custom Box, an optional SSD must be installed in the machine.
  - ▶ [HD-6/7 <Large Capacity Storage: SSD> \(12-6\)](#)
- Main Custom Box operations can also be performed with Command Center RX.
  - ▶ [Command Center RX User Guide](#)

## What is Job Box?

"Job Box" refers collectively to the Private Print, Stored Job Box and Quick Copy/Proof and Hold Box. These Job Boxes cannot be created or deleted by a user.

The four types of Job Box are listed below.

- Private Print Box ([5-40](#))
- Hold Box ([5-41](#))
- Quick Copy Box ([5-42](#))
- Proof and Hold Box ([5-43](#))



### NOTE

- You can set up the machine so that temporary documents in job boxes are automatically deleted.
  - ▶ [Deletion of Job Retention \(8-26\)](#)
- For details on operating [Private Print/Stored Job], [Quick Copy/Proof and Hold], refer to the following.
  - ▶ [Printing Data Saved on the Machine \(5-40\)](#)

## What is Removable Memory Box?

A USB memory stick can be connected to the USB memory slot on the machine to print a saved file. You can print data directly from the USB memory without a PC. Image files scanned using this machine can also be saved to USB memory in the PDF, TIFF, JPEG, XPS, OpenXPS or high compression PDF format (Scan to USB).

## The F Code Box, Polling Box, and FAX Memory Receive Box are for storing FAX data.

Fax Box store the fax data.



### NOTE

The optional FAX Kit is required to use the F Code Box, Polling Box, and FAX Memory Receive Box are for storing FAX data.

➔ FAX Operation Guide

## Using Machine Operations to Create a New Custom Box



### NOTE

- To use Custom Box, an optional SSD must be installed in the machine.
- If user login administration is enabled, you can only change the settings by logging in with administrator privileges.  
The factory default login user name and login password are set as shown below.  
Login user name  
ECOSYS M8124cidn:2400, ECOSYS M8130cidn:3000  
Login Password  
ECOSYS M8124cidn:2400, ECOSYS M8130cidn:3000
- If user login administration is enabled, log in with administrator privileges to perform the following operations. They cannot be performed with user privileges.
  - Creating a box
  - Deleting a box of which owner is another user.

### 1 Display the screen.

1 [Home] key > [Custom Box]

2 [Menu] > [Add]

## 2 Register the Custom Box.

1 Enter the box name. > [Next >]

Enter up to 32 characters as the box name.

➔ [Character Entry Method \(12-13\)](#)

The table below lists the items to be set.

Item	Description
Box Name	Enter a box name consisting of up to 32 characters. ➔ <a href="#">Character Entry Method (12-13)</a>
Box No.	Enter the box number by selecting [+], [-] or number keys. The box number can be from 0001 to 1000. A Custom Box should have a unique number. If you enter 0000, the smallest number available will be automatically assigned.
Owner <sup>*1</sup>	Set the owner of the box. Select the owner from the user list that appears.
Permission <sup>*2</sup>	Select whether to share the box.
Box Password	User access to the box can be restricted by specifying a password to protect the box. Entering a password is not mandatory. Enter the same password of up to 16 characters in both [Password] and [Confirm Password]. This can be set if [Shared] is selected in Permission.
Usage Restriction	The usage for a box can be restricted. To enable a capacity restriction enter a value for the storage capacity of the Custom Box in megabytes by selecting [-], [+] or number keys. Though the limit value changes with the number of Custom Boxes that are created, the maximum range of entered values is from 1 to 30,000 (MB).
Auto File Deletion	Automatically deletes stored documents after a set period of time. Select [On] to enable automatic deletion and then use [+] and [-] or the numeric keys to enter the number of days for which documents are stored. You can enter any number between 1 and 31 (day(s)). To disable automatic file deletion, select [Off].
Free Space	Displays the free space on the box.
Overwrite Setting	Specifies whether or not old stored documents are overwritten when new documents are stored. To overwrite old documents, select [Permit]. To retain old documents, select [Prohibit].
Delete after Print	Automatically delete a document from the box once printing is complete. To delete the document, select [On]. To retain the document, select [Off].

\*1 Displayed when user login administration is enabled.

\*2 Not displayed when "Owner" is set to [No Owner].

2 Select [Register].

A box is created.

## Using Command Center RX to Create a New Custom Box

You can register a custom box from Command Center RX.



### NOTE

To use Custom Box, an optional SSD must be installed in the machine.

## 1 Display the screen.

- 1 Launch your Web browser.
- 2 In the address or location bar, enter the machine's IP address or the host name.  
Click in the following order to check the machine's IP address and the host name.  
On the MFP Home screen: [Device Information] > [Identification/Network]  
Example 1: https://192.168.48.21/ (for IP address)  
Example 2: https://MFP001 (if the host name is "MFP001")
- 3 From the [Document Box] menu, click [Custom Box].

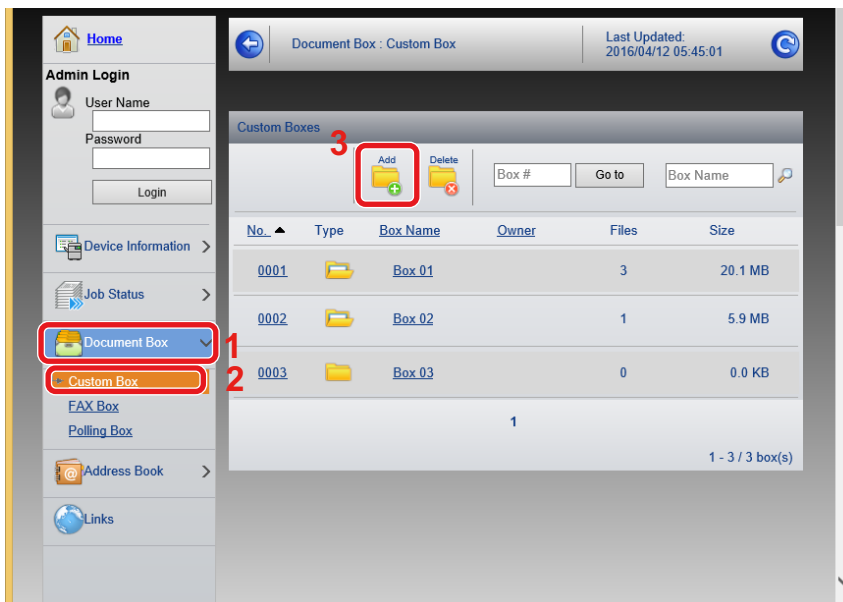

- 4 Click [Add].

## 2 Configure the settings.

- 1 Enter the box details.  
Enter the information for the custom box you want to register. For details on the fields to populate, refer to the following:  
➔ [Command Center RX User Guide](#)
- 2 Click [Submit].

## Edit the custom box.

### 1 Display the screen.

- 1 [Home] key > [Custom Box]

### 2 Edit the custom box.

- 1 [Menu] > [Edit]
- 2 Select the box you want to edit.



#### NOTE

- When you have logged in as a user, you can only edit a box whose owner is set to that user.
- When you have logged in as administrator, you can edit all boxes.

When user login administration is enabled, the settings that can be changed varies depending on the privileges of the logged in user.

Privileges	Settings that can be changed
Administrator	Box Name
	Box No.
	Owner
	Permission
	Box Password
	Usage Restriction
	Auto File Deletion
	Overwrite Setting
	Delete after Print
User	Box Name
	Box Password
	Permission
	Auto File Deletion
	Overwrite Setting
	Delete after Print

For details on each item, refer to the information below.

➔ [Using Machine Operations to Create a New Custom Box \(3-49\)](#)



## Deleting Custom Box

### 1 Display a screen.

- 1 [Home] key > [Custom Box]

### 2 Delete the box.

- 1 [Menu] > [Delete]
- 2 Select the box you want to delete.



#### NOTE

- When you have logged in as a user, you can only delete a box whose owner is set to that user.
- When you have logged in as administrator, you can delete all boxes.

- 3 Select [Yes].

# 4 Operation on PC

This chapter explains the following topics:

Printer Driver Print Settings Screen .....	4-2
Displaying the Printer Driver Help .....	4-4
Changing the Default Printer Driver Settings .....	4-5
Printing from PC .....	4-6
Printing on Standard Sized Paper .....	4-6
Printing on Non-standard Sized Paper .....	4-7
Canceling Printing from a Computer .....	4-10
Storing Data in Machine Memory and Printing Data in Machine Memory .....	4-11
On the computer, specify the document box and save the job .....	4-11
Using Command Center RX to Print a Job Stored in a Custom Box .....	4-12
Monitoring the Printer Status (Status Monitor) .....	4-14
Accessing the Status Monitor .....	4-14
Exiting the Status Monitor .....	4-14
Status Monitor Display .....	4-14
Printing Progress Tab .....	4-15
Paper Tray Status Tab .....	4-15
Toner Status Tab .....	4-15
Alert Tab .....	4-16
Status Monitor Context Menu .....	4-16
Status Monitor Notification Settings .....	4-17

# Printer Driver Print Settings Screen

The printer driver print settings screen allows you to configure a variety of print-related settings.

➔ Printer Driver User Guide

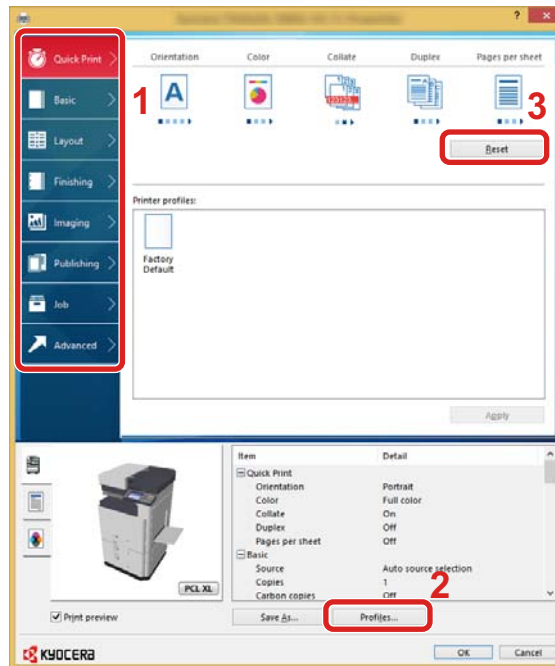

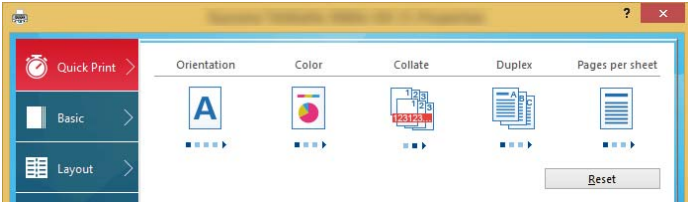
No.	Description
1	<p>[Quick Print] tab Provides icons that can be used to easily configure frequently used functions. Each time you click an icon, it changes to an image resembling the print results and applies the settings.</p>  <p>[Basic] tab This tab groups basic functions that are frequently used. You can use it to configure the paper size, destination, and duplex printing.</p> <p>[Layout] tab This tab lets you configure settings for printing various layouts, including booklet printing, combine mode, poster printing, and scaling.</p> <p>[Finishing] tab This tab lets you configure settings related to finishing of printed media.</p> <p>[Imaging] tab This tab lets you configure settings related to the quality of the print results.</p> <p>[Publishing] tab This tab lets you create covers and inserts for print jobs and put inserts between sheets of OHP film.</p> <p>[Job] tab This tab lets you configure settings for saving print data from the computer to the machine. Regularly used documents and other data can be saved to the machine for easy printing later. Since saved documents can be printed directly from the machine, this function is also convenient when you wish to print a document that you don't want others to see.</p> <p>[Advanced] tab This tab lets you configure settings for adding text pages or watermarks to print data.</p>

2	[Profiles] Printer driver settings can be saved as a profile. Saved profiles can be recalled at any time, so it's a convenient practice to save frequently used settings.
3	[Reset] Click to revert settings to their initial values.

## Displaying the Printer Driver Help

The printer driver includes Help. To learn about print settings, open the printer driver print settings screen and display Help as explained below.

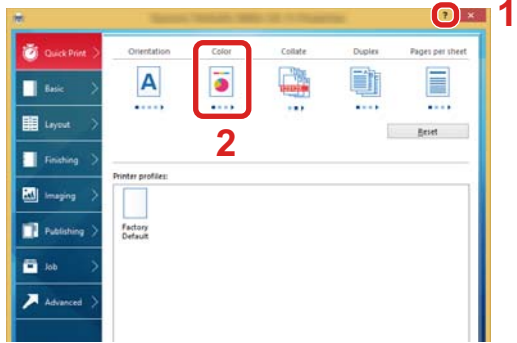

- 1 Click the [?] button in the upper right corner of the screen.
- 2 Click the item you want to know about.



### NOTE

The Help appears, even when you click the item you want to know about and press the [F1] key on your keyboard.

# Changing the Default Printer Driver Settings

The default printer driver settings can be changed. By selecting frequently used settings, you can omit steps when printing. Instructions are based on interface elements as they appear in Windows 8.1.

For the settings, refer to the following:

➔ Printer Driver User Guide

**1** In charms on Desktop, click **[Settings]**, **[Control Panel]**, and then **[Devices and Printers]**.



## NOTE

In Windows 7, click **[Start]** button on the Windows, and then click **[Devices and Printers]**.

**2** Right-click the printer driver icon of the machine, and click the **[Printer properties]** menu of the printer driver.

**3** Click the **[Basic]** button on the **[General]** tab.

**4** Select the default settings and click the **[OK]** button.

# Printing from PC

Follow the steps below to print documents from applications.

This section provides the printing method using the KX DRIVER.

## NOTE

- To print the document from applications, install the printer driver on your computer from the supplied DVD (Product Library).
- In some environments, the current settings are displayed at the bottom of the printer driver.

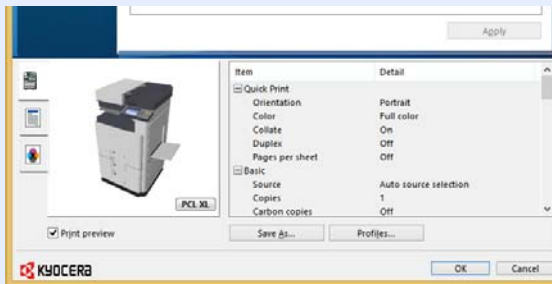

- When printing the cardstock or envelopes, load the cardstock or envelopes in the multi purpose tray before performing the following procedure.

➔ [When you place envelopes or cardstock on the platen \(5-9\)](#)

## Printing on Standard Sized Paper

If you loaded a paper size that is included in the print sizes of the machine, select the paper size on the [Basic] tab of the print settings screen of the printer driver.

## NOTE

On the MFP operation panel, specify the paper size and media type to print.

➔ [\[Cassette/MP Tray Settings\] \(8-9\)](#)

### 1 Display the screen.

Click [File] and select [Print] in the application.

### 2 Configure the settings.

- 1 Select the machine from the "Name" menu and click the [Properties] button.

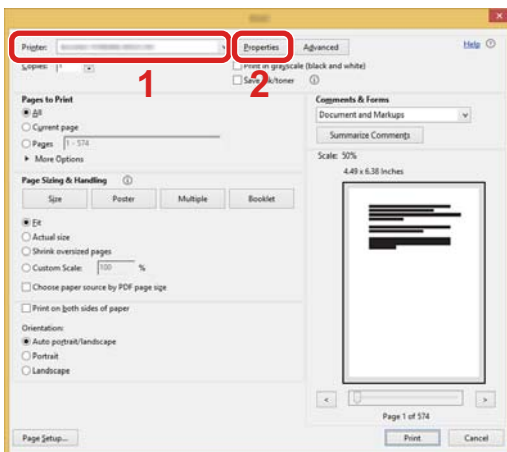

- 2 Select the [Basic] tab.

3 Click "Print size" menu and select the paper size to use for printing.

To load the paper of size that is not included in print sizes of the machine such as cardstock or envelopes, the paper size needs to be registered.

➔ [Printing on Non-standard Sized Paper \(4-7\)](#)

 **NOTE**

If you select [Off] for "Auto Cassette Change", select the paper source that contains the paper you want to use from "Source".

➔ [Auto Cassette Change \(8-33\)](#)

To print on the special paper such as thick paper or transparency, click "Media Type" menu and select the media type.

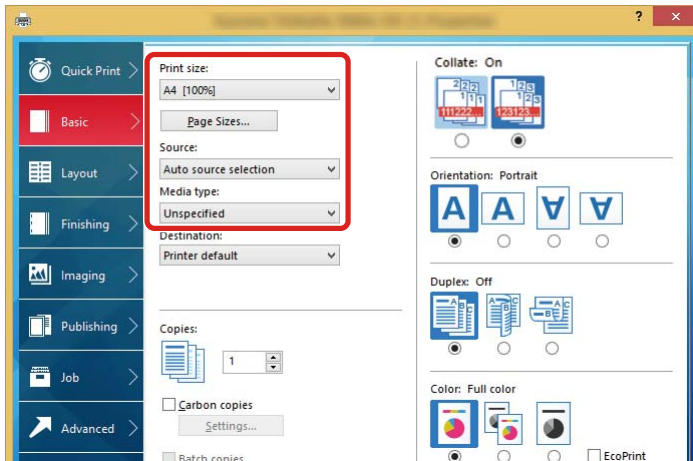

4 Click [OK] button to return to the Print dialog box.

3 **Start printing.**

Click the [OK] button.

## Printing on Non-standard Sized Paper

If you loaded a paper size that is not included in the print sizes of the machine, register the paper size in the [Basic] tab of the print settings screen of the printer driver.

The registered size can be selected from the "Print size" menu. Instructions are based on interface elements as they appear in Windows 8.1.

 **NOTE**

Specify the paper size and media type to print from the operation panel.

➔ [\[Cassette/MP Tray Settings\] \(8-9\)](#)

1 **Display the screen.**

1 In charms on Desktop, click [Settings], [Control Panel], and then [Devices and Printers].

In Windows 7, click [Start] button on the Windows, and then click [Devices and Printers].

2 Right-click the printer driver icon of the machine, and click the [Printer properties] menu of the printer driver.



## 2 Registering.

- 1 Click the [Basic] tab.

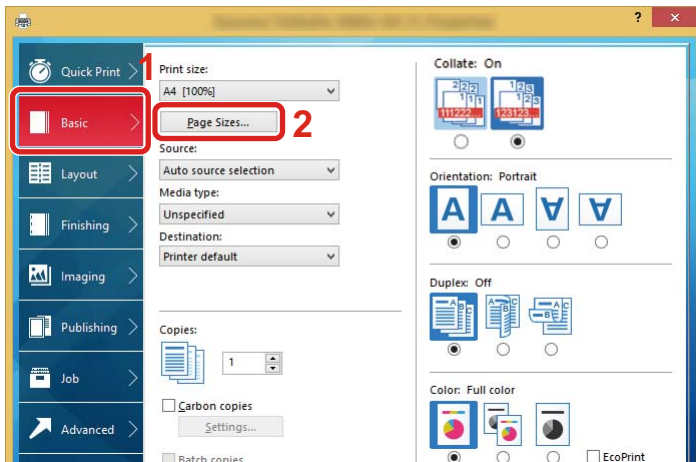

- 2 Click the [Page Sizes...] button.
- 3 Click the [New] button.

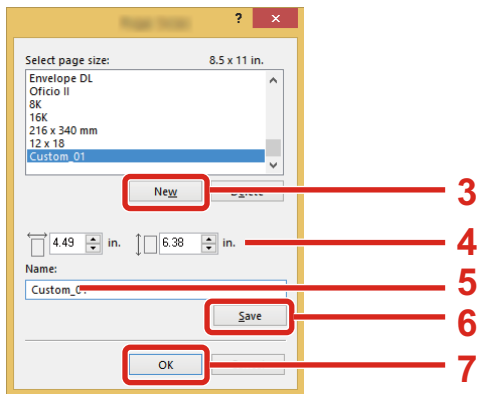

- 4 Enter the paper size.
- 5 Enter the name of the paper.
- 6 Click the [Save] button.
- 7 Click the [OK] button.
- 8 Click the [OK] button.

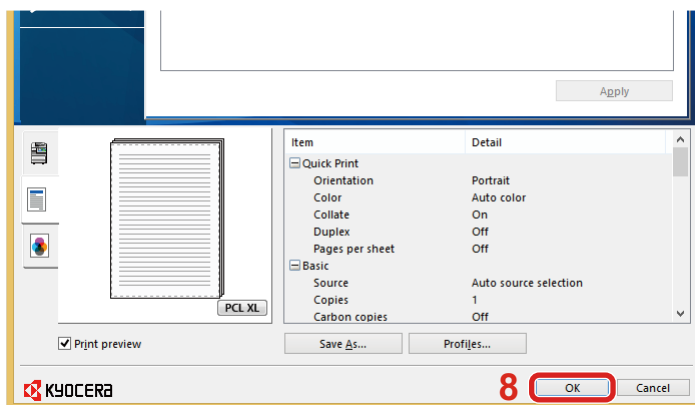

## 3 Display the print settings screen.

Click [File] and select [Print] in the application.

## 4 Select the paper size and type of non-standard size paper.

- 1 On the "Name" menu, select his MFP, and then click the [Properties] button.

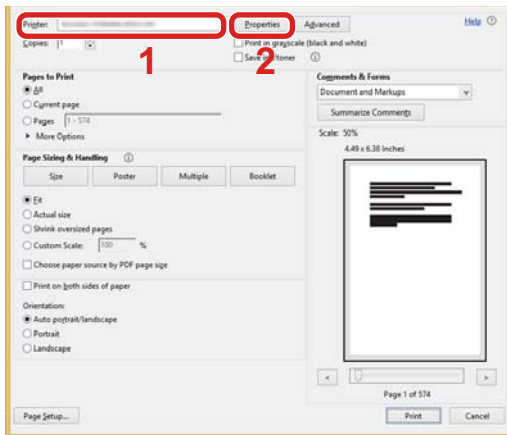

- 2 Select the [Basic] tab.

- 3 Click "Print size" menu and select the paper size registered in step 2.

To print on the special paper such as thick paper or transparency, click "Media Type" menu and select the media type.

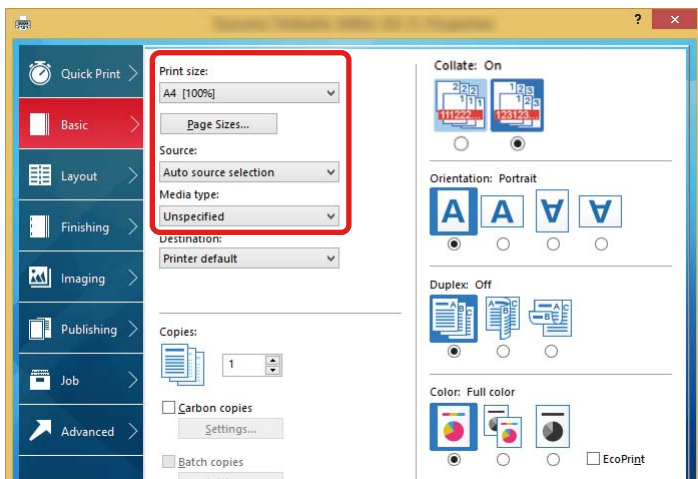

### NOTE

If you loaded a postcard or envelope, select [Cardstock] or [Envelope] in the "Media Type" menu.

- 4 Select the paper source in the "Source" menu.
- 5 Click [OK] button to return to the Print dialog box.

## 5 Start printing.

Click the [OK] button.

## Canceling Printing from a Computer

To cancel a print job executed using the printer driver before the printer begins printing, do the following:



### NOTE

When canceling printing from this machine, refer to the following:

➔ [Canceling Jobs \(5-13\)](#)

- 1** Double-click the printer icon () displayed on the taskbar at the bottom right of the Windows desktop to display a dialog box for the printer.
- 2** Click the file for which you wish to cancel printing and select [Cancel] from the "Document" menu.

# Storing Data in Machine Memory and Printing Data in Machine Memory

You can save the print job into the Custom Box and Job Box of this device and print it as necessary.

➔ [What is Custom Box? \(3-48\)](#)

➔ [What is Job Box? \(3-48\)](#)

The four types of Job Box are listed below.

- Private Print Box ([5-40](#))
- Hold Box ([5-41](#))
- Quick Copy Box ([5-42](#))
- Proof and Hold Box ([5-42](#))



## NOTE

To use Custom Box, an optional SSD must be installed in the machine. Creating a RAM disk makes it possible to print from a Job Box.

If you configure settings in the [Job] tab of the printer driver and then print, the print job will be saved in the Job Box (memory) and printing can be executed at the machine.

Follow the work flow below when using Document Boxes.

- 1 On the computer, specify the document box and save the job ([4-11](#))**
- 2 On the control panel, specify and print the file in the document box ([5-40](#))**

## On the computer, specify the document box and save the job

Use the procedure below to store data in a Job Box.

- 1 Click [File] and select [Print] in the application.**  
The Print dialog box displays.
- 2 Select the machine from the "Name" menu.**
- 3 Click the [Properties] button.**  
The Properties dialog box displays.

- 4 Click the [Job] tab and select the [Job storage (e-MPS)] check box to set the function > [OK].

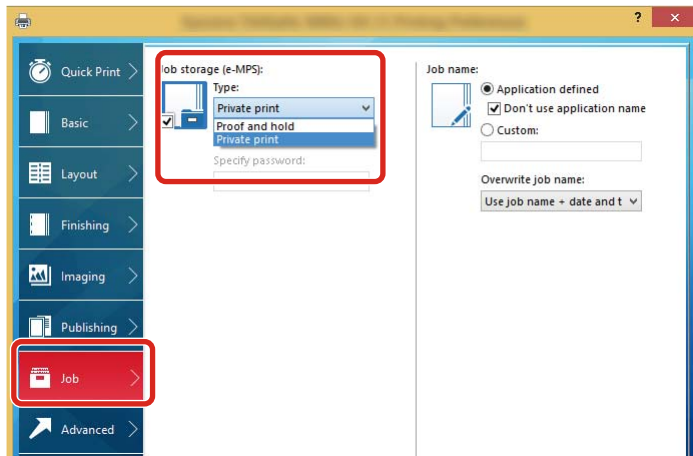

 **NOTE**

For information on how to use the printer driver software, refer to the following:

- ➔ Printer Driver User Guide

- 5 Click the [Print] button.

The print job is stored.

## Using Command Center RX to Print a Job Stored in a Custom Box

A document stored in a Custom Box can be printed from Command Center RX.

- 1 Display the screen.

- 1 Launch your Web browser.
- 2 In the address or location bar, enter the machine's IP address or the host name.  
Click in the following order to check the machine's IP address and the host name.  
[Device Information] in the home screen > [Identification/Wired Network]

3 From the [Document Box] menu, click [Custom Box].

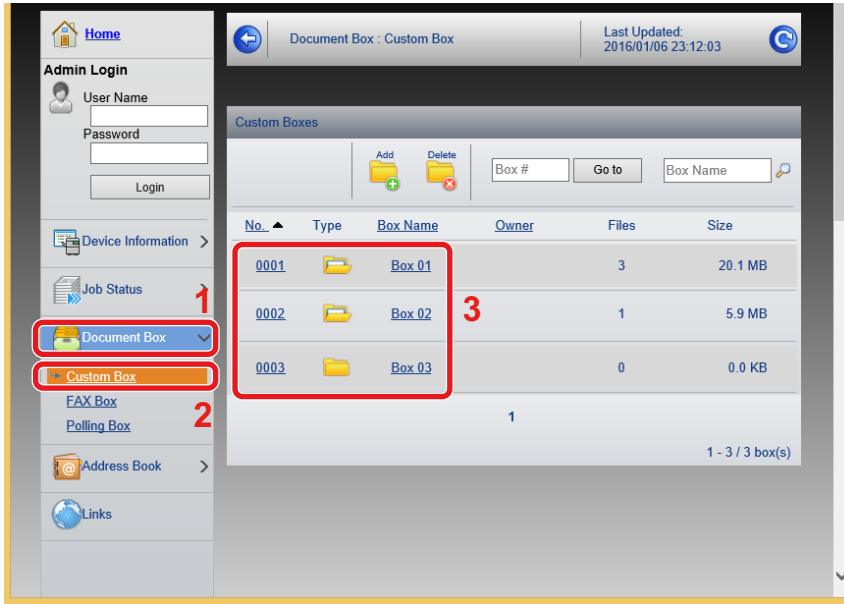

4 Click the number or name of the Custom Box in which the document is stored.

2 Print the document.

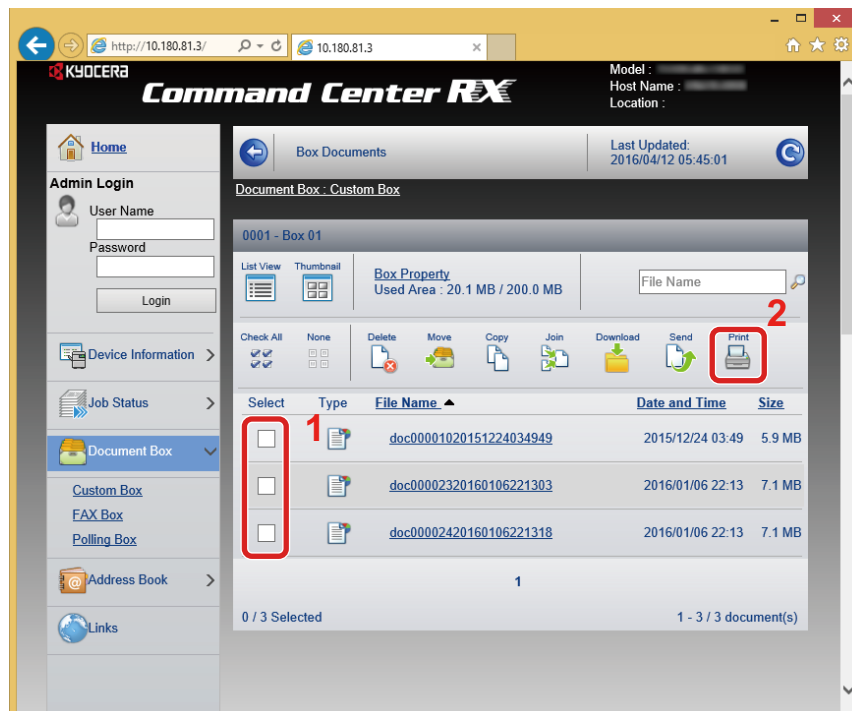

1 Select the document you wish to print.

Select the checkbox of the document to be printed.

2 Click [Print].

3 Configure settings for printing, click [Print].

# Monitoring the Printer Status (Status Monitor)

The Status Monitor monitors the printer status and provides an ongoing reporting function.

## NOTE

When you activate Status Monitor, check the status below.

- KX DRIVER is installed.
- Select [On] for [IP Address] or [Subnet Mask].

➔ [\[Network\] \(8-35\)](#)

## Accessing the Status Monitor

The Status Monitor also starts up when printing is started.

## Exiting the Status Monitor

Use either of the methods listed below to exit the Status Monitor.

- Exit manually:  
Click the settings icon and select Exit in the menu to exit the Status Monitor.
- Exit automatically:  
The Status Monitor automatically shuts down after 7 minutes if it is not being used.

## Status Monitor Display

The status of the printer is displayed using icons. Detailed information is displayed when the Expand button is clicked.

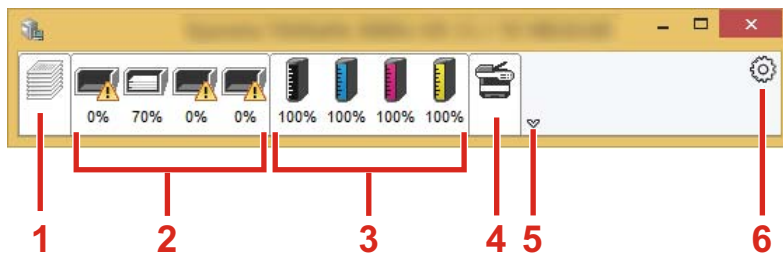

- 1 Printing Progress Tab
- 2 Paper Tray Status Tab
- 3 Toner Status Tab
- 4 Alert Tab
- 5 Expand button
- 6 Settings icon

Detailed information is displayed by clicking on each icon tab.

## Printing Progress Tab

The status of the print jobs is displayed.

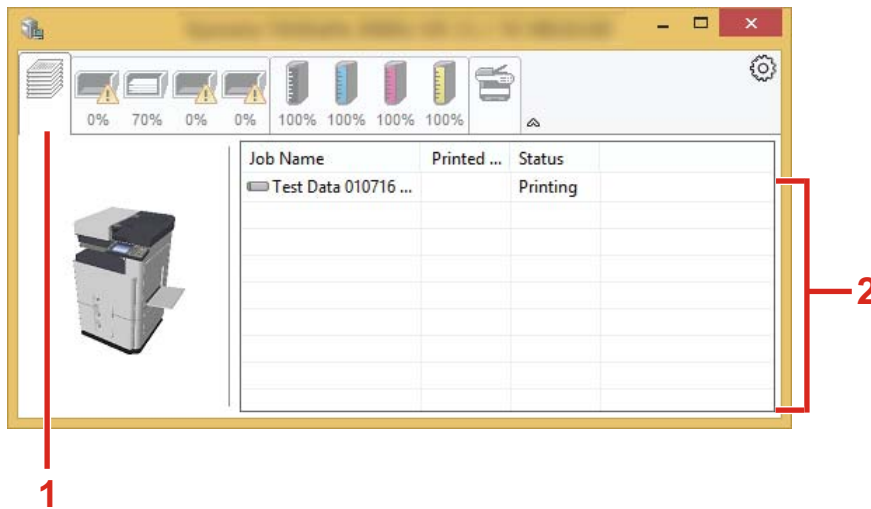

- 1 Status icon
- 2 Job list

Select a job on the job list and it can be canceled using the menu displayed with a right-click.

## Paper Tray Status Tab

Information is displayed about the paper in the printer and about the amount of paper remaining.

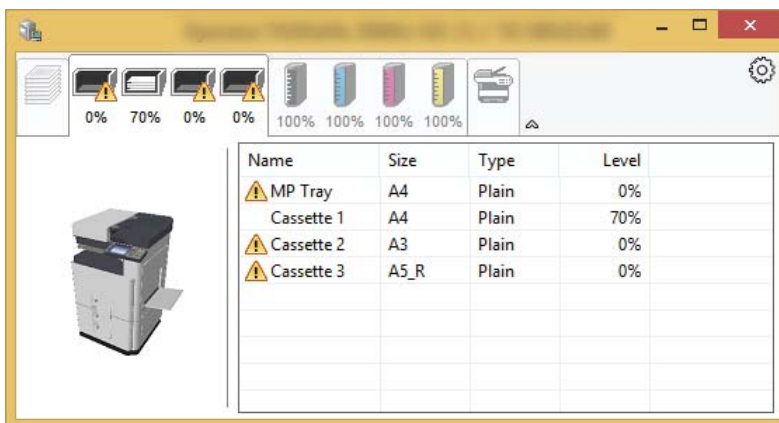

## Toner Status Tab

The amount of toner remaining is displayed.

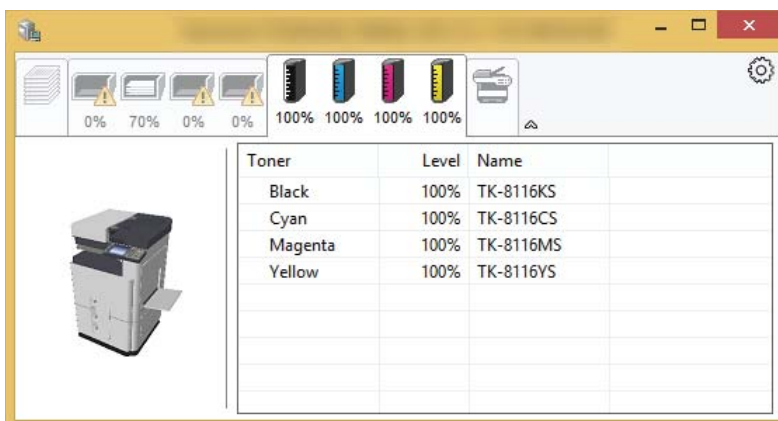



## Alert Tab

If an error occurs, a notice is displayed using a 3D image and a message.

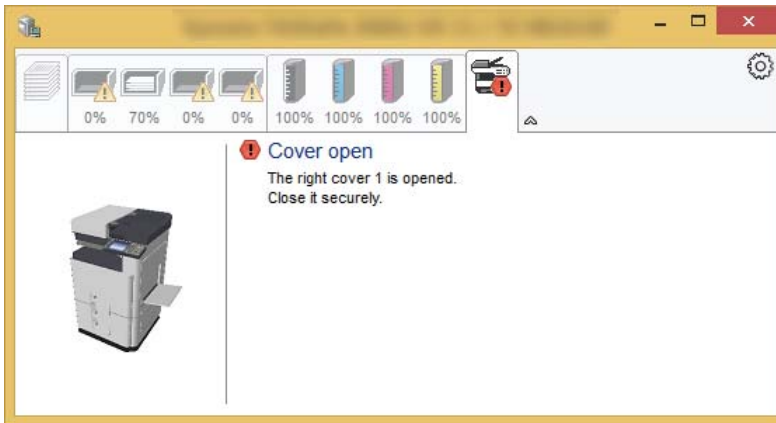

## Status Monitor Context Menu

The following menu is displayed when the settings icon is clicked.

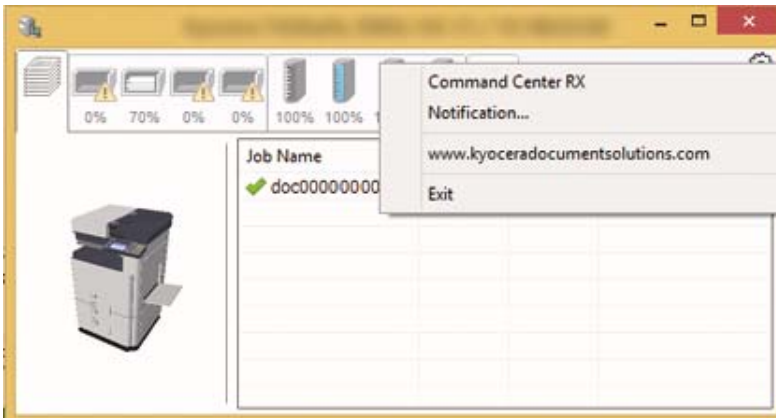

- Command Center RX  
If the printer is connected to a TCP/IP network and has its own IP address, use a web browser to access the Command Center RX to modify or confirm the network settings. This menu is not displayed when using USB connection.  
➔ [Command Center RX User Guide](#)
- Notification...  
This sets the display of the Status Monitor.  
➔ [Status Monitor Notification Settings \(4-17\)](#)
- www.kyoceradocumentsolutions.com  
Open our website.
- Exit  
Exits the Status Monitor.

## Status Monitor Notification Settings

The Status Monitor settings and event list details are displayed.

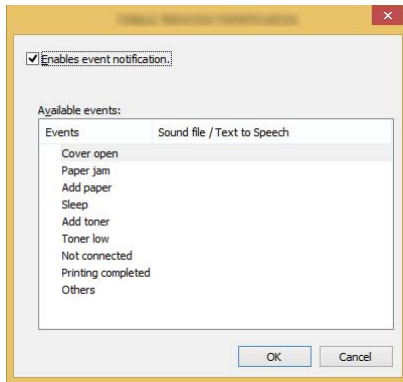

Select whether notification is performed when an error in the event list occurs.

- 1 Select Enable event notification.**  
If this setting is set to Off, then the Status Monitor will not start up even when printing is executed.
- 2 Select an event to use with the text to speech function in Available events.**
- 3 Click Sound file / Text to Speech column.**  
Click the browse (...) button to notify the event by sound file.

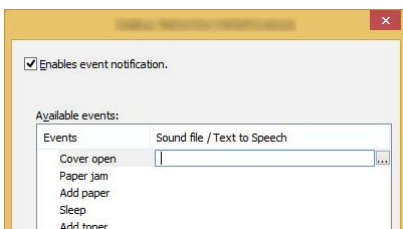

### NOTE

The available file format is WAV.

When customizing the message texts to read on the screen aloud, enter the texts in the text box.

# 5 Operation on the Machine

This chapter explains the following topics:

Place the Originals .....	5-3
Placing Originals on the Platen .....	5-3
Loading Originals in the Document Processor .....	5-4
Loading Paper in the Multi Purpose Tray .....	5-7
Using Applications .....	5-10
Activating Applications .....	5-10
Deactivating Applications .....	5-11
Copying .....	5-12
Copying .....	5-12
Interrupt Copy .....	5-13
Canceling Jobs .....	5-13
Frequently-Used Sending Method .....	5-14
Sending Scanned Document via E-mail .....	5-14
Sending to a Shared Folder on a Computer [SMB] .....	5-16
Sending to an Folder on an FTP Server [FTP] .....	5-18
Scanning with a TWAIN/WIA Compatible Application .....	5-19
Useful Sending Method .....	5-21
Executing WSD Scan .....	5-21
Using File Management Utility to Scan an Original Document .....	5-22
Sending to Different Types of Destinations (Multi Sending) .....	5-23
Sending to the E-mail address of the Logged In User .....	5-23
Using a FAX Server to Send (FAX Server Send) .....	5-24
Canceling Scanning .....	5-26
Destination Operations .....	5-27
Choosing from the Address Book .....	5-27
Choosing from the External Address Book .....	5-29
Choosing from the One Touch Key .....	5-29
Choosing from the Speed Dial .....	5-30
Checking and Editing Destinations .....	5-30
Confirmation Screen of Destinations .....	5-30
Recall .....	5-31
How to Use the FAX Function .....	5-32
Basic Operation for Document Box .....	5-33
Box List Operations .....	5-33
Document List Operations .....	5-33
Custom Box Operations .....	5-34
Saving Scanned Documents to a Custom Box .....	5-34
Moving Documents in Custom Box .....	5-34
Copying Documents in Custom Box into Other Boxes .....	5-35
Copying Documents in Custom Box to Removable Memory .....	5-35
Joining Documents in Custom Box .....	5-36
Deleting Documents in Custom Box .....	5-37
Sending Documents in a Custom Box .....	5-37
Sending Documents in Custom Box to E-mail Address of Logged in user. ....	5-38
Scanning Document Stored in a Custom Box .....	5-39
Printing Data Saved on the Machine .....	5-40
Printing Documents from Private Print Box .....	5-40
Deleting the Documents Stored in the Private Print Box .....	5-40
Printing Document from Stored Job Box .....	5-41

Deleting the Documents Stored in the Stored Job Box .....	5-41
Printing Document from Quick Copy Box .....	5-42
Deleting the Documents Stored in the Quick Copy Box .....	5-42
Printing Document from Proof and Hold Box .....	5-43
Deleting the Documents Stored in the Proof and Hold Box .....	5-43
Printing Documents in Custom Box .....	5-43
Printing from the Handheld Device .....	5-45
Printing by AirPrint .....	5-45
Printing by Google Cloud Print .....	5-45
Printing by Mopria .....	5-45
Printing with Wi-Fi Direct .....	5-45
Printing with NFC .....	5-46
Operating Using Removable USB Memory .....	5-47
Saving Documents to USB Memory (Scan to USB) .....	5-47
Check the USB Memory Information .....	5-48
Removing USB Memory .....	5-48
Printing from Removable USB Memory .....	5-49

## Place the Originals.

Load the originals on the platen or document processor, depending on the original size, type, volume, and function.

- Platen: Place the sheet, book, postcards, and envelopes.
- Document Processor: Place the multiple originals. You can also place the two sided originals.

### Placing Originals on the Platen

You may place books or magazines on the platen in addition to ordinary sheet originals.

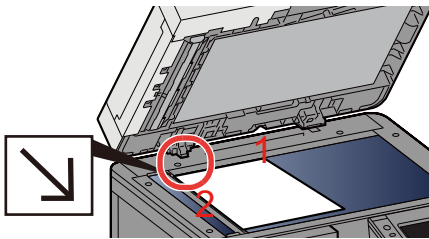

- 1 Put the scanning side facedown.
- 2 Align it flush against the original size indicator plates with the back left corner as the reference point.



#### NOTE

- A5 is detected as A4-R. Set the paper size to A5 by using the function key on the touch panel.

➔ [\[Original Size\] \(6-4\)](#)

- For details on Original Orientation, refer to the following:

➔ [\[Original Orientation\] \(6-9\)](#)

## When you place envelopes or cardstock on the platen

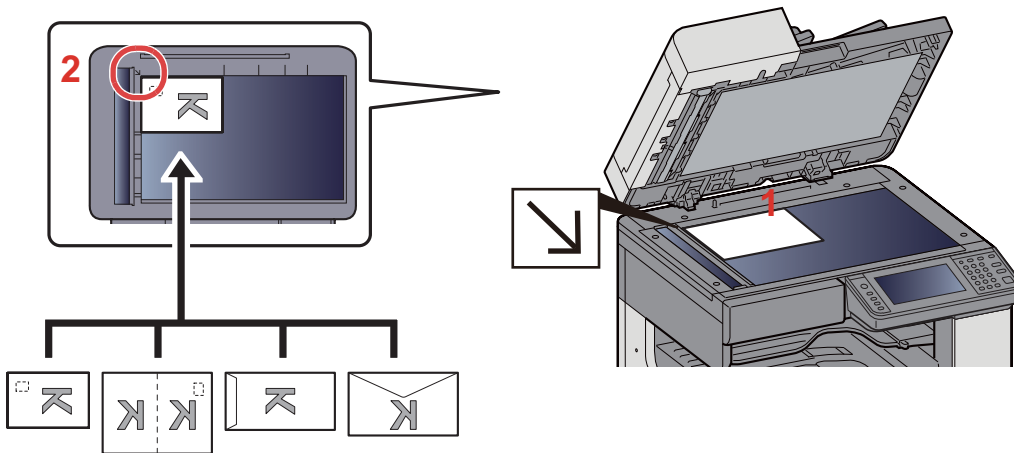

- 1 Put the scanning side facedown.
- 2 Align it flush against the original size indicator plates with the back left corner as the reference point.

### NOTE

- For the procedure for feeding envelopes or cardstock, refer to the following:  
[→ When you place envelopes or cardstock on the platen \(5-9\)](#)



### CAUTION

Do not leave the document processor open as there is a danger of personal injury.

### IMPORTANT

- Do not push the document processor forcefully when you close it. Excessive pressure may crack the platen glass.
- When placing books or magazines on the machine, do so with the document processor in the open position.

## Loading Originals in the Document Processor

The document processor automatically scans each sheet of multiple originals. Both sides of two-sided originals are scanned.

### Originals Supported by the Document Processor

<b>Weight</b>	45 to 160 g/m <sup>2</sup> (duplex: 50 to 120 g/m <sup>2</sup> )
<b>Sizes</b>	Maximum A3/Ledger (297 x 432 mm) (Long-sized 297 x 1,900 mm) to Minimum A5-R/Statement-R (140 x 182 mm)
<b>No. of sheets</b>	Plain paper (80 g/m <sup>2</sup> ), Color paper, Recycled paper, High Quality paper: 50 sheets

Do not use the document processor for the following types of originals. Otherwise, the originals may be jammed or the document processor may become dirty.

- Document Processor Originals Not Supported by the Document Processor Originals bound with clips or staples (Remove the clips or staples and straighten curls, wrinkles or creases before loading. Failure to do so may cause the originals to jam.)
- Originals with adhesive tape or glue
- Originals with cut-out sections

- Curled original
- Originals with folds (Straighten the folds before loading. Failure to do so may cause the originals to jam.)
- Carbon paper
- Crumpled paper

✔ **IMPORTANT**

- **Before loading originals, be sure that there are no originals left on the original eject table. Originals left on the original eject table may cause the new originals to jam.**
- **Do not make an impact on the document processor top cover, such as aligning the originals on the top cover. It may cause an error in the document processor.**

**1 Adjust the original width guides.**

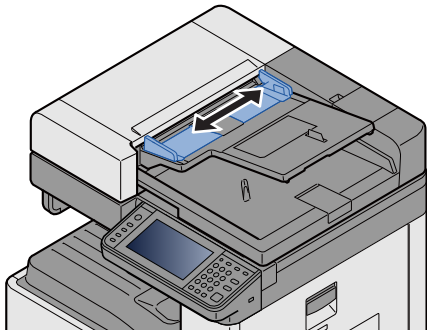

## 2 Place the originals.

- 1 Put the side to be scanned (or the first side of two-sided originals) face-up. Slide the leading edge into the document processor as far as it will go.

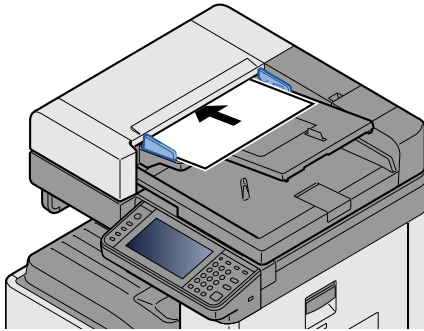

### NOTE

For details on Original Orientation, refer to the following:

→ [\[Original Orientation\] \(6-9\)](#)



### IMPORTANT

**Confirm that the original width guides exactly fit the originals. If there is a gap, readjust the original width guides. The gap may cause the originals to jam.**

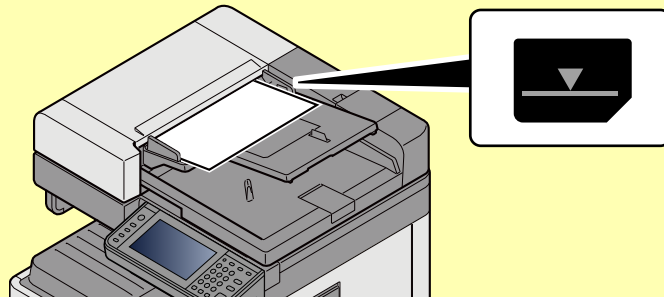

**Ensure that loaded originals do not exceed the level indicator. Exceeding the maximum level may cause the originals to jam.**

**Originals with punched holes or perforated lines should be placed in such a way that the holes or perforations will be scanned last (not first).**

- 2 Open the original stopper to fit the size of the original set (Original size: A3 or Ledger).

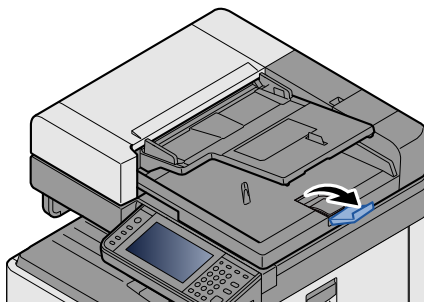



# Loading Paper in the Multi Purpose Tray

For details of the supported paper sizes, refer to the following:

➔ [Paper Appropriate Paper \(12-16\)](#)

For the paper type setting, refer to the following:

➔ [Media Type Setting \(8-14\)](#)

Be sure to use the multi purpose tray when you print on any special paper.

## ✔ IMPORTANT

- If you are using a paper weight of 106 g/m<sup>2</sup> or more, set the media type to Thick and set the weight of the paper you are using.
- Remove each transparency from the inner tray as it is printed. Leaving transparencies in the inner tray may cause a paper jam.

The capacity of the multi purpose tray is as follows.

- A4 or smaller plain paper (80 g/m<sup>2</sup>), recycled paper or color paper: 100 sheets
- Thick paper (220 g/m<sup>2</sup>): 10 sheets
- Thick paper (157 g/m<sup>2</sup>): 10 sheets
- Thick paper (120 g/m<sup>2</sup>): 25 sheets
- Thick paper (104.7 g/m<sup>2</sup>): 25 sheets
- A4 or smaller plain paper (80 g/m<sup>2</sup>), recycled paper or color paper: 25 sheets
- Hagaki (Cardstock): 20 sheets
- Envelope DL, Envelope C5, Envelope #10(Commercial#10), Envelope Monarch, Youkei 4, Youkei 2: 5 sheets
- OHP film: 10 sheet

## 💡 NOTE

- When you load custom size paper, enter the paper size by referring to the following:  
➔ [\[Multi Purpose Tray\] \(8-10\)](#)
- When you use special paper such as transparencies or thick paper, select the media type by referring to the following:  
➔ [Media Type Setting \(8-14\)](#)

## 1 Open the multi purpose tray.

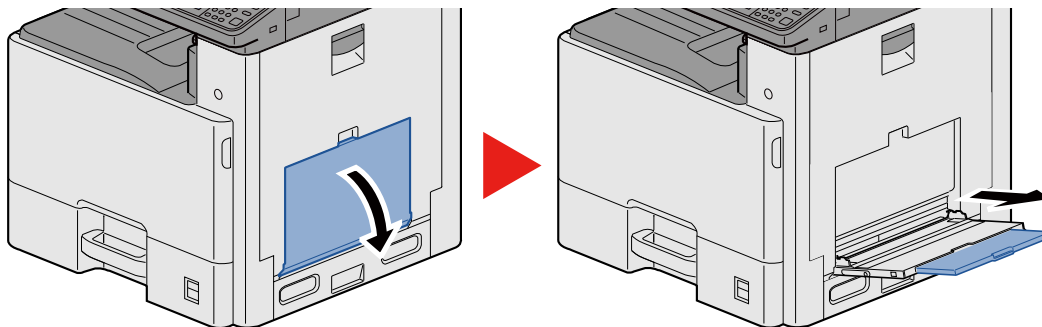

## 2 Adjust the multi purpose tray size.

Paper sizes are marked on the multi purpose tray.

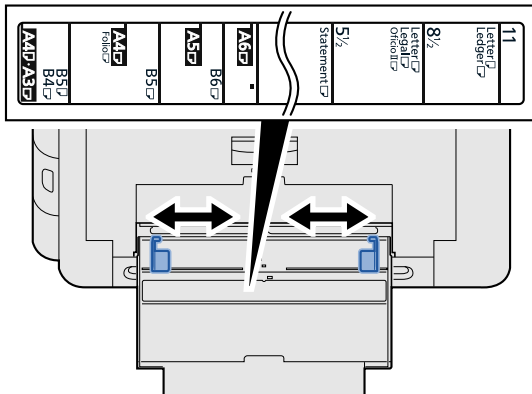

## 3 Load paper.

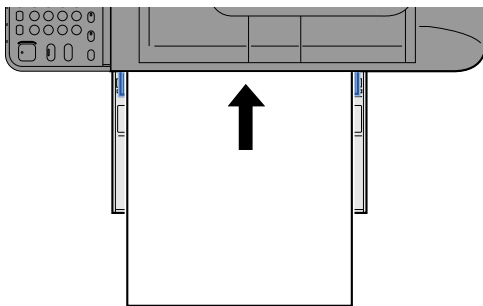

Insert the paper along the paper width guides into the tray until it stops.

After removing new paper from its packaging, fan the paper before loading it in the multi purpose tray.

➔ [Precaution for Loading Paper \(3-17\)](#)

### ✔ IMPORTANT

- When loading the paper, keep the print side facing down.
- Curled paper must be uncurled before use.
- When loading paper into the multi purpose tray, check that there is no paper left over in the tray from a previous job before loading the paper. If there is just a small amount of paper left over in the multi purpose tray and you want to add more, first remove the left-over paper from the tray and include it with the new paper before loading the paper back into the tray.
- If there is a gap between the paper and the paper width guides, readjust the guides to fit the paper in order to prevent skewed feeding and paper jams.

## 4 Specify the type of paper loaded in the multi purpose tray using the operation panel.

➔ [\[Multi Purpose Tray\] \(8-10\)](#)

## When you place envelopes or cardstock on the platen

Load the paper with the print side facing down. For the procedure for printing, refer to the following:

➔ Printer Driver User Guide

### Example: When printing the address.

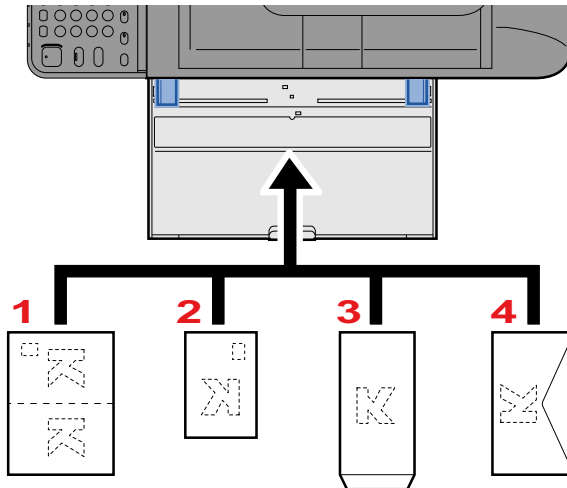

- 1 Oufuku hagaki (Return postcard)
- 2 Hagaki (Cardstock)
- 3 Banker Envelope (Open the flap.)
- 4 Pocket Envelope (Close the flap.)

#### ✔ IMPORTANT

- Use unfolded Oufuku hagaki (Return postcard).
- How to load envelopes (orientation and facing) will differ depending on the type of envelope. Be sure to load it in correctly, otherwise printing may be done in the wrong direction or on the wrong face.

#### 💡 NOTE

- When you load envelopes in the multi purpose tray, select the envelope type by referring to the following:

➔ [\[Multi Purpose Tray\] \(8-10\)](#)

# Using Applications

## Activating Applications

### 1 Display the screen.

[System Menu / Counter] key > [Application] > [Application]

#### NOTE

If the user authentication screen appears, enter your login user name and login password and select [Login]. For this, you need to log in with administrator privileges.

The factory default login user name and login password are set as shown below.

Login user name

ECOSYS M8124cidn:2400, ECOSYS M8130cidn:3000

Login Password

ECOSYS M8124cidn:2400, ECOSYS M8130cidn:3000

### 2 Activate the application.

1 Select the application you want to Activate. > [Menu] > [Activate]

You can view detailed information on the selected application by selecting [  ].

2 [Official] > Enter the license key. > [OK]

Some applications do not require you to enter a license key. If the license key entry screen does not appear, go to step 2-3. To use the application on a trial basis, select [Trial] without entering the license key.

3 Select [Yes].

#### IMPORTANT

If you change the date/time while using the trial version of an application, you will no longer be able to use the application.

Icons of applications that are running are displayed in the Home screen.

### 3 Press the Home screen application icon to start up.

Select the application icon.

The application will start up.

## Deactivating Applications

### 1 Display the screen.

[System Menu / Counter] key > [Application] > [Application]



#### NOTE

If the user authentication screen appears, enter your login user name and login password and select [Login]. For this, you need to log in with administrator privileges.

The factory default login user name and login password are set as shown below.

Login user name

ECOSYS M8124cidn:2400, ECOSYS M8130cidn:3000

Login Password

ECOSYS M8124cidn:2400, ECOSYS M8130cidn:3000

### 2 Deactivate the application.

1 Select the application you want to stop. > [Menu] > [Deactivate]

You can view detailed information on the selected application by selecting [.

2 Select [Yes].

# Copying

The procedures here represent the basic copy operation and how to cancel the copy.

## Copying

- 1 [Home] key > [Copy]
- 2 Place the originals.

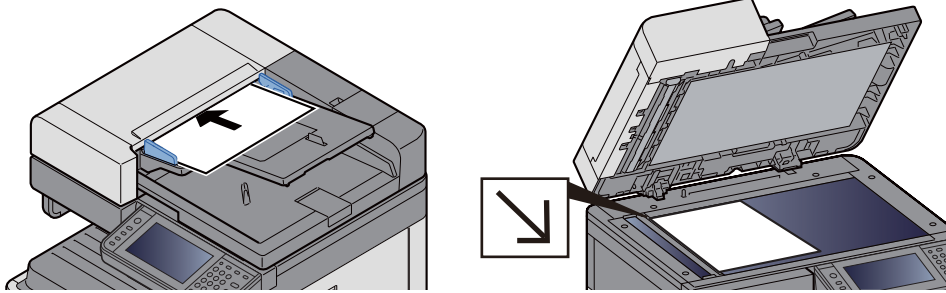

➔ [Place the Originals. \(5-3\)](#)

- 3 Selecting the functions.

You can select a function to configure its settings by selecting its function key. Or you can select a function by selecting [Functions].

➔ [\[Copy\] \(x\)](#)

- 4 Use the numeric keys to enter the copy quantity.

Specify the desired number up to 999.

- 5 Press the [Start] key.

Copying starts.

### NOTE

This function allows you to reserve the next job during printing. When the current print job ends, the reserved copy job is printed. If "Reserve Next Priority" is set to [Off], [Reserve Next] will appear. Select [Reserve Next] and configure the necessary settings for the copy job.

➔ [Reserve Next Priority \(8-24\)](#)

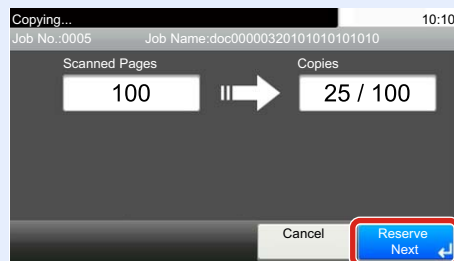

## Interrupt Copy

This function allows you to pause the current jobs in progress when you need to make copies immediately.

When the interruption copy ends, the machine resumes the paused print jobs.

### NOTE

- If the machine is left unused for 60 seconds in interrupt copy mode, interrupt copying is automatically cancelled and printing resumes. You can change the delay until interrupt copying is canceled. Change if needed.

➔ [Interrupt Clear Timer \(8-62\)](#)

➔ [\[Priority Override\] \(6-39\)](#)

### 1 Configure the settings.

- 1 Select the [Interrupt] key.

The current print job is temporarily interrupted.

- 2 Place the originals onto the machine for interrupt copy, and configure the copy settings.

### 2 Press the [Start] key.

Interrupt copying begins.

### 3 When interrupt copying ends, select the [Interrupt] key.

The machine resumes the paused print jobs.

## Canceling Jobs

### 1 Select the [Stop] key with the copy screen displayed.

### 2 Cancel a job.

#### When there is a job is being scanned

The copy job is canceled.

#### When there is a job printing or on standby

Canceling job screen appears. The current print job is temporarily interrupted.

Select the job you wish to cancel > [Delete] > [Yes]

### NOTE

If "Reserve Next Priority" is set to [Off], the Copying screen appears in the touch panel. In such case, selecting the [Stop] key or [Cancel] will cancel the printing job in progress.

➔ [Reserve Next Priority \(8-24\)](#)

## Frequently-Used Sending Method

This machine can send a scanned image as an attachment of an E-mail message or to a PC linked to the network. In order to do this, it is necessary to register the sender and destination (recipient) address on the network.

A network environment which enables the machine to connect to a mail server is required in order to send E-mail. It is recommended that a Local Area Network (LAN) be used to assist with transmission speed and security issues.

The basic scan (send) methods are those below.

- Send as E-mail (E-mail Addr Entry): Sends a scanned original image as an E-mail attachment.

### ➔ [Sending Scanned Document via E-mail \(5-14\)](#)

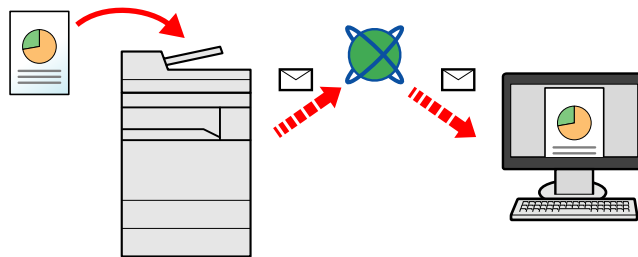

- Send to Folder (SMB): Stores a scanned original image in a shared folder of any PC.

### ➔ [Sending to a Shared Folder on a Computer \[SMB\] \(5-16\)](#)

- Send to Folder (FTP): Stores a scanned original image in a folder of an FTP server.

### ➔ [Sending to an Folder on an FTP Server \[FTP\] \(5-18\)](#)

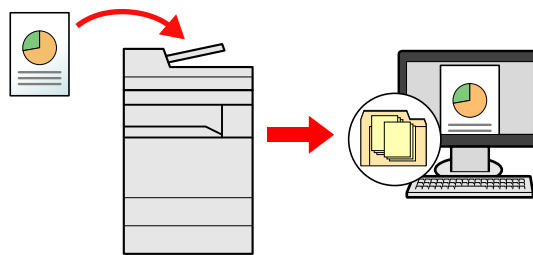

- Image Data Scanning with TWAIN/WIA: Scan the document using a TWAIN or WIA compatible application program.

### ➔ [Scanning with a TWAIN/WIA Compatible Application \(5-19\)](#)

#### **NOTE**

Different sending options can be specified in combination.

#### ➔ [Sending to Different Types of Destinations \(Multi Sending\) \(5-23\)](#)

The fax function can be used on products equipped with fax capability.

#### ➔ [FAX Operation Guide](#)

## Sending Scanned Document via E-mail

Sending scanned document via E-mail.

#### **NOTE**

Before sending a document, Command Center RX must be used to configure settings for SMTP and sending E-mail.

#### ➔ [Setting SMTP and E-mail \(2-45\)](#)



1 **[Home] key > [Send]**

2 **Place the originals.**

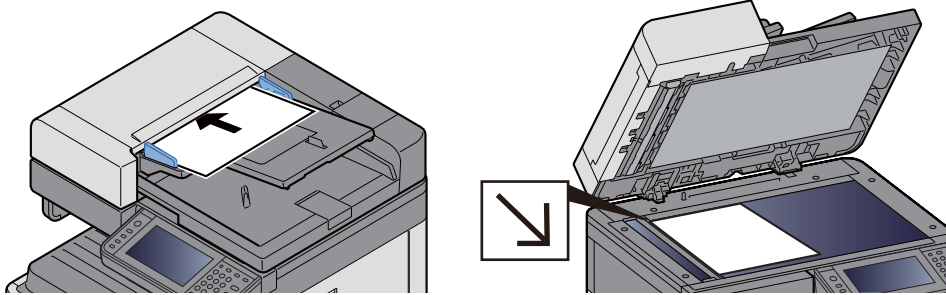

➔ [Place the Originals. \(5-3\)](#)

3 **Selecting [E-mail] displays the Enter Address screen.**

4 **Enter the destination address > [OK].**

You can enter up to 128 characters.

➔ [Character Entry Method \(12-13\)](#)

To enter multiple destinations, select [Next Destination] and enter the next destination.

Number of allowable E-mail address entries: 100

To add the entered mail address to the Address Book, selecting [Menu] > [< Back]. You can also replace the information for a previously registered destination.

Destinations can be changed later.

➔ [Checking and Editing Destinations \(5-30\)](#)



**NOTE**

If [Broadcast] is set to [Prohibit], it is not possible to directly enter multiple destinations.

➔ [Broadcast \(8-25\)](#)

5 **Selecting the functions.**

To select a function and configure its settings, select it with [Functions].

➔ [\[Send\] \(xii\)](#)

6 **Press the [Start] key.**

Start sending.

## Sending to a Shared Folder on a Computer [SMB]

You can store the scanned document into the desired shared folder on a computer.



### NOTE

Before sending a document, configure the following settings.

Making a note of the computer name and full computer name

➔ [Making a note of the computer name and full computer name \(3-22\)](#)

Making a note of the user name and domain name

➔ [Making a note of the user name and domain name \(3-23\)](#)

Creating a shared folder, making a note of a shared folder

➔ [Creating a Shared Folder, Making a Note of a Shared Folder \(3-24\)](#)

Configure the Windows firewall

➔ [Configuring Windows Firewall Settings \(3-28\)](#)

**1** [Home] key > [Send]

**2** Place the originals.

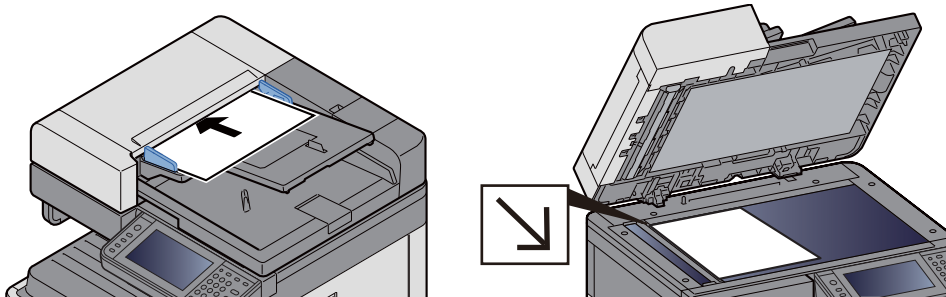

➔ [Place the Originals. \(5-3\)](#)

**3** On the basic screen for sending, select [Folder].

**4** For the folder type, select [SMB].

**5** Select the folder specification method.

To search for a folder on a PC on the network and add it, select [Search Folder from Network] or [Search Folder by Host Name].

If you pressed "Search Folder from Network", you can search all PCs on the network for a destination.

If you selected "Search Folder by Host Name", you can enter the "Domain/Workgroup", and "Host Name" to search PCs on the network for the destination.

Up to 500 addresses can be displayed. Select the host name (PC name) that you want to specify in the screen that appears, and select [Next >]. The login user name and login password entry screen appears.

After you enter the login user name and login password name of the destination PC, the shared folders appear. Select the folder that you want to specify and select [Next >]. The address of the selected shared folder is set.

Select the folder from the Search Results list.

## 6 Enter the destination information.

Enter the SMB destination information. After you have completed entry of one item, select [Next >] to advance to the next item.

➔ [Character Entry Method \(12-13\)](#)

The table below explains the items to be entered.

Description	Description	Max. No. of Characters
Host Name *1	Computer name	64 characters
Path	Share name For example: scannerdata If saving in a folder in the shared folder: share name\folder name in shared folder	128 characters
Login User Name	If the computer name and domain name are the same: User Name: For example: james.smith If the computer name and domain name are different: Domain name\User name For example:abcdnet\yamada	64 characters
Login Password	Windows login password (Case sensitive.)	64 characters

\*1 You can also specify the port number. Enter the following format separated by a colon.  
"Host name: port number" or "IP address: port number"  
To enter the IPv6 address, enclose the address in brackets [ ].  
(Example: [2001:db8:a0b:12f0::10]:445)  
If the port number is not specified in [Host Name], the default port number is 445.

## 7 Check the status.

1 Check the information.

Change if needed.

2 [Menu] > [Connection Test]

The message "Connected." appears when connection with the destination is correctly established. If "Cannot connect." appears, check the information you entered.

To enter multiple destinations, select [Next Destination] and enter the next destination.

You can register the entered information in the address book by selecting [Add Address Book].

## 8 Select [OK].

Destinations can be changed later.

➔ [Checking and Editing Destinations \(5-30\)](#)

## 9 Selecting the functions.

Selecting [Functions] displays a list of functions.

➔ [\[Send\] \(xii\)](#)

## 10 Press the [Start] key.

Start sending.

## Sending to an Folder on an FTP Server [FTP]

You can store the scanned document into the desired shared folder on a computer.



**NOTE**

Before sending a document, configure the FTP Client (Transmission).

➔ [\[Protocol Settings\] \(8-44\)](#)

**1 [Home] key > [Send]**

**2 Place the originals.**

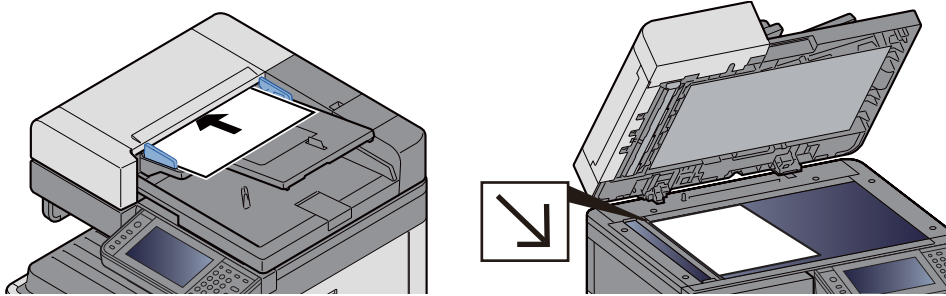

➔ [Place the Originals. \(5-3\)](#)

**3 On the basic screen for sending, select [Folder].**

**4 For the folder type, select [FTP].**

**5 Enter the destination information.**

Enter the destination information. After you have completed entry of one item, select [Next >] to advance to the next item.

➔ [Character Entry Method \(12-13\)](#)

The table below explains the items to be entered.

Description	Data to be entered	Max. No. of Characters
Host Name* <sup>1</sup>	Host name or IP address of FTP server	Up to 70 characters
Path* <sup>2</sup>	Path to the receiving folder For example: \User\ScanData Otherwise the data will be saved in the home directory.	Up to 128 characters
Login User Name	FTP server login user name	Up to 64 characters
Login Password	FTP server login password (Case sensitive.)	Up to 64 characters

\*1 You can also specify the port number. Enter the following format separated by a colon.  
When entering "Host Name:Host Number" or the "IP Address;Port Number".  
IPv6 address, enclose the IPv6 address in square brackets [ ].  
(Example: (Example: [2001:db8:a0b:12f0::1]:21)  
The default port number (21) is used if a port number is not specified.

\*2 When the FTP server is based on Linux/UNIX, the path including the sub-folder is combined by the slash (/) and not the back-slash(\).

## 6 Check the status.

- 1 Check the information.

Change if needed.

- 2 [Menu] > [Connection Test]

The message "Connected" appears when connection with the destination is correctly established. screen appears. If "Cannot connect" appears, check the information you entered.

To enter multiple destinations, select [Next Destination] and enter the next destination.

You can register the entered information in the Address Book by selecting [Add Address Book].

## 7 Select [OK].

Destinations can be changed later.

➔ [Checking and Editing Destinations \(5-30\)](#)

## 8 Selecting the functions.

Selecting [Functions] displays a list of other functions.

➔ [\[Send\] \(xii\)](#)

## 9 Press the [Start] key.

Start sending.

# Scanning with a TWAIN/WIA Compatible Application

This section explains how to scan an original using TWAIN or WIA.

### NOTE

Before sending a document, confirm that TWAIN/WIA driver is installed on a computer and the settings are configured.

➔ [Setting TWAIN Driver \(2-37\)](#)

➔ [Setting WIA Driver \(2-39\)](#)

## 1 Display the screen.

- 1 Start up the TWAIN or WIA compatible application.
- 2 Select the machine using the application and display the dialog box.

### NOTE

For selecting the machine, see the Operation Guide or Help for each application software.

## 2 Configure the settings.

Select scanning settings in the dialog box that opens.

### NOTE

For the settings, refer to Help in the dialog box.

### 3 Place the originals.

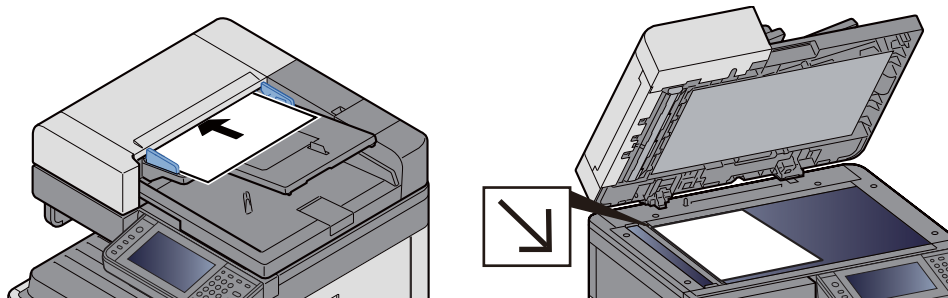

▶ [Place the Originals. \(5-3\)](#)

### 4 Scan the originals.

Click the [Scan] button. This scans the original and stores the data on the computer.

# Useful Sending Method

The useful scan (send) method is described below.

- WSD Scan: Saves images of originals scanned on this machine as files on a WSD-compatible computer.  
➔ [Executing WSD Scan \(5-21\)](#)
- Scanning with File Management Utility: Scans a document using the settings of File Management Utility and saves it to a specified network folder or PC.  
➔ [Using File Management Utility to Scan an Original Document \(5-22\)](#)
- Scanning using the fax server: A scanned original is send via a fax server.  
➔ [Using a FAX Server to Send \(FAX Server Send\) \(5-24\)](#)
- Sending to different types of destinations (Multi sending): Sends to different types of destination (E-mail addresses, folders, etc.) in a single operation.  
➔ [Sending to Different Types of Destinations \(Multi Sending\) \(5-23\)](#)
- Send to Me (E-mail): Sends to the E-mail address of the logged in user when user login is enabled.  
➔ [Sending to the E-mail address of the Logged In User \(5-23\)](#)

## Executing WSD Scan

WSD scan saves images of originals scanned on this machine as files on a WSD-compatible computer.



### NOTE

- To use WSD scan, confirm that the computer used for WSD scanning and the machine is network-connected, and "WSD Scan" is set to [On] in the network settings.  
➔ [WSD Scan \(8-45\)](#)
- For information on operating the computer, refer to the computer's help or the operation guide of your software.

1 [Home] key > [Send]

2 Place the originals.

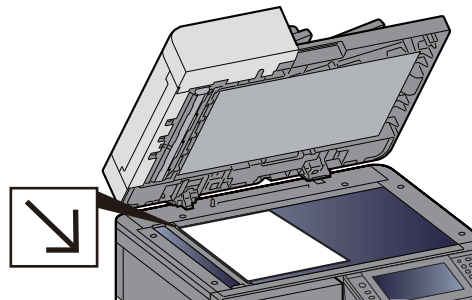
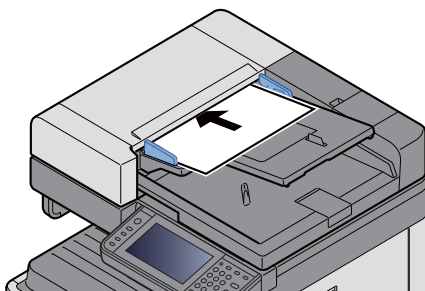

➔ [Place the Originals. \(5-3\)](#)

3 Display the screen.

Select [WSD Scan].

4 Scan the originals.

**Procedure using this machine**

1 Select [From Operation Panel].

2 Select the destination computer > [OK]

Select [Reload] to reload the computer list.

To view information about the destination computer, select [  ].

- 3 Set the type of original, file format, etc., as desired.
- 4 Press the [Start] key.  
Sending begins and the software installed on the computer is activated.

#### **Procedure from Your Computer**

- 1 [From Computer] > [Next >]
- 2 Use the WSD-compatible software installed on the computer to send the images.

## **Using File Management Utility to Scan an Original Document**

The File Management Utility (FMU) is an application that sends a document scanned on the machine to a specified network folder or computer and stores it there. The workflow created by the FMU to process scanned documents can be added on the machine to favorites.

### **NOTE**

To use this function, you must install File Management Utility on your computer and configure settings for the multifunction machine to be used, scanning conditions, and the file save location. For information on installing File Management Utility, refer to the information below.

➔ [Installing Software \(2-27\)](#)

For information on using File Management Utility, refer to the following:

➔ File Management Utility User Guide

- 1 **Make sure that File Management Utility is running on the computer (or server) on which File Management Utility is installed.**
- 2 **Place the originals.**
- 3 **Recalling a Favorite.**  
Select [Favorites] on the Home Screen or [Send] > [Favorites]. Select the icon that appears.
- 4 **Follow the on-screen instructions to enter the necessary information and select [Next >].**
- 5 **When the scan settings screen appears, press each item and configure the necessary settings.**  
The features that can be set depend on File Management Utility.
- 6 **Press the [Start] key.**  
Start sending.



## Sending to Different Types of Destinations (Multi Sending)

You can specify destinations that combine E-mail addresses, folders (SMB or FTP) and fax numbers (Fax functionality can only be used on products equipped with fax capability.). This is referred to as Multi Sending. This is useful for sending to different types of destination (E-mail addresses, folders, etc.) in a single operation.

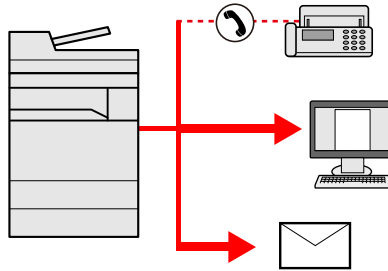

Number of broadcast items: 100 maximum

However, the number of items is limited in the case of the send methods below.

Folders (SMB, FTP): Total of 5 SMB and FTP

Procedures are the same as used in specifying the destinations of respective types. Continue to enter E-mail address or folder path so that they appear in the destination list. Press the [Start] key to start transmission to all destinations at one time.

### NOTE

- If the destinations include a fax, the images sent to all destinations will be black and white.
- If [Broadcast] is set to [Prohibit], it is not possible to directly enter multiple destinations.

➔ [Broadcast 8-25](#)

## Sending to the E-mail address of the Logged In User

When user login is enabled, documents in the custom box are sent to the E-mail address of the logged in user.

### NOTE

Before using this function, the following are necessary.

- The function icon must be displayed in the home screen.

➔ [Editing the Home Screen \(3-8\)](#)

- An E-mail address must be set in user login for the user who logs in.

➔ [Adding a User \(Local User List\) \(9-7\)](#)

- 1 Select **[Home]** key.
- 2 Select **[Send to Me(E-mail)]**.

## Using a FAX Server to Send (FAX Server Send)

You can send a scanned document via a fax server.

### NOTE

- A fax server is required to use this function. For information about the fax server, contact the applicable administrator.
- FAX server settings must be configured to send a FAX.
  - ▶ [Command Center RX User Guide](#)
  - ▶ [\[FAX Server Settings\] \(8-59\)](#)

- 1 **[Home]** key > **[Send]**
- 2 **Place the originals.**

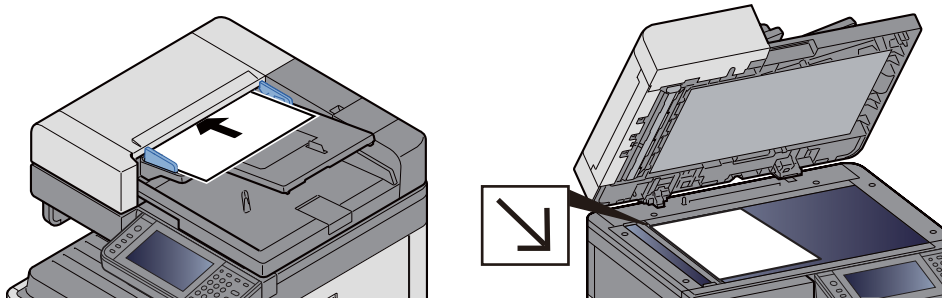

▶ [Place the Originals. \(5-3\)](#)

- 3 **On the basic screen for sending, select [FAX Server].**
- 4 **Enter recipient information.**

Entering Information Directly

- 1 Select **[Enter FAX Number]**.
- 2 Enter the fax number.

### NOTE

Use the numeric keys to enter a number.

- 3 Select **[OK]**.  
Destinations can be changed later.

▶ [Checking and Editing Destinations \(5-30\)](#)

Selecting from the Address Book

- 1 Select **[Address Book]**.
- 2 Specify the destination.

▶ [Choosing from the Address Book \(5-27\)](#)

- 3 Select [OK].

Destinations can be changed later.

➔ [Checking and Editing Destinations \(5-30\)](#)

Selecting from an External Address Book

- 1 Select [Ext Address Book].

- 2 Specify the destination.

➔ [Choosing from the Address Book \(5-27\)](#)

- 3 Select [OK].

Destinations can be changed later.

➔ [Destination Operations \(5-27\)](#)



#### **NOTE**

For details on the External Address Book, refer to the following:

➔ [Command Center RX User Guide](#)

## **5 Selecting the functions.**

Place the originals.

➔ [\[Send\] \(xii\)](#)

## **6 Press the [Start] key.**

Start sending.

# Canceling Scanning

You can also cancel jobs by selecting the [Stop] key.

**1 Select the [Stop] key with the send screen displayed.**

**2 Cancel a job.**

**When there is a job is being scanned**

Job Cancel appears.

**When there is a job sending or on standby**

Canceling job screen appears.

Select the job you want to cancel. > [Delete] > [Yes]



## NOTE

Selecting the [Stop] key will not temporarily stop a job that you have already started sending.

# Destination Operations

This section explains how to select and confirm the destination.

In addition to direct entry, destination information can also be selected using the methods below.

- Choosing from the Address Book
  - ➔ [Choosing from the Address Book \(5-27\)](#)
- Choosing from the External Address Book
  - ➔ [Choosing from the External Address Book \(5-29\)](#)
- Choosing from the One Touch Key
  - ➔ [Choosing from the One Touch Key \(5-29\)](#)
- Choosing from the Speed Dial
  - ➔ [Choosing from the Speed Dial \(5-30\)](#)
- Choosing from the FAX
  - ➔ FAX Operation Guide

## NOTE

- You can set the machine up so that the address book screen appears when you select the [Send] key.
  - ➔ [\[Default Screen\] \(8-11\)](#)
- If you are using the products equipped with the fax function, you can specify the fax destination. Enter the other party number using the numeric keypad.

## Choosing from the Address Book

Select a destination registered in the Address Book.

## NOTE

For more information about how to register destinations in the Address Book, refer to the following:

- ➔ [Adding a Destination \(3-32\)](#)

### 1 In the basic screen for sending, select [Address Book].

## NOTE

For details on the External Address Book, refer to the following:

- ➔ Command Center RX User Guide

## 2 Select the destination.

Select the checkbox to select the desired destination from the list. You can select multiple destinations. The selected destinations are indicated by a checkmark in the check box.

To perform a more detailed search, select [Menu].

 **NOTE**

- To cancel a selection, select the checkbox again so that it is no longer ticked.
- If [Prohibit] is selected for the [Broadcast Transmission] setting, entry of multiple destinations is not supported. In this case, selection of a previously registered group containing multiple recipients also is not supported.

➔ [Broadcast \(8-25\)](#)

### Destination Search

Destinations registered in the Address Book can be searched. Advanced search by type or by initial letter is also available.

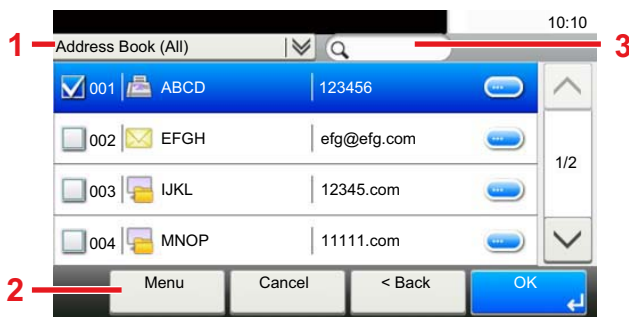

Keys used		Search type	Subjects searched
1		Advanced search by destination	Advanced search narrows down registered destinations according to type (mail, folder (SMP, FTP), FAX, group).
2	Narrow Down	Advanced search by destination	Advanced search narrows down registered destinations according to type (mail, folder (SMP, FTP), FAX, group).
	Search (Name)	Search by name	Search by registered name.
	Search by number	Search by number	Search by registered address number.
	Sort (Name)	Display Sequence Search	Search by registered name.
	Sort (No.)		Search by registered address number.
3		Search by name	Search by registered name.

## 3 Accept the destination > [OK].

Destinations can be changed later.

➔ [Checking and Editing Destinations \(5-30\)](#)

 **NOTE**

You can set the default "Sort" settings.

➔ [Sort \(8-30\)](#)

## Choosing from the External Address Book

Select a destination registered in the external address book.

 **NOTE**

For details on the External Address Book, refer to the following:

➔ [Command Center RX User Guide](#)

**1 On the basic screen for sending, select [Ext Address Book].**

**2 Select the destination.**

Select the checkbox to select the desired destination from the list. You can select multiple destinations. The selected destinations are indicated by a checkmark in the check box.

To perform a more detailed search, select [Menu].

 **NOTE**

To change to a different external address book, select [Switch Ext. Addr. Book] and then select the external address book you want.

**3 Accept the destination > [OK].**

Destinations can be changed later.

➔ [Checking and Editing Destinations \(5-30\)](#)

 **NOTE**

You can set the default "Sort" settings.

➔ [Sort 8-30](#)

## Choosing from the One Touch Key

Select the destination using the One Touch Keys.

In the basic screen for sending, select the One Touch Keys where the destination is registered.

 **NOTE**

If the One Touch Keys for the desired destination are not displayed on the touch panel, select [^] or [v] to show the One Touch keys that are not displayed. This procedure assumes that One Touch Keys have already been registered.

For more information on adding One Touch keys, refer to the following:

➔ [Assigning a Destination to a One Touch Key \(3-37\)](#)

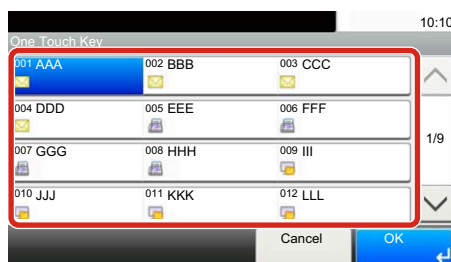

## Choosing from the Speed Dial

Access the destination by specifying the 3-digit (001 to 100) One Touch Key number (speed dial).

Pressing the [Quick No. Search] key displays a number entry screen. Select the number entry area and then use the [# Keys] to enter a One Touch Key number.

### NOTE

If you entered the speed dial in 1 to 3-digit, select [OK].

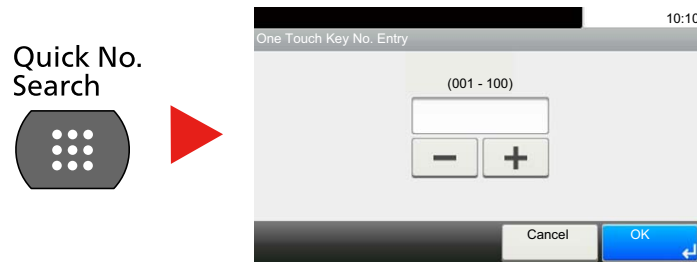

## Checking and Editing Destinations

Check and edit a selected destination.

**1 On the basic screen for sending, select [Check].**

**2 Check and edit the destination.**

Select [+] to add a destination.

To check the destinations contents, press []. The details of destinations that specify a new mail address or computer can be modified.

Select the destination and then select [] to delete the destination.

### NOTE

- When selecting [On] for Entry Check for New Destination, the confirmation screen appears. Enter the same host name and path again, and select [OK].
  - ➔ [Entry Check for New Dest. \(8-25\)](#)
- When selecting [On] for "Destination Check before Send", the confirmation screen appears after pressing the [Start] key.
  - ➔ [Dest. Check before Send \(8-25\)](#)
  - ➔ [Confirmation Screen of Destinations \(5-30\)](#)

## Confirmation Screen of Destinations

When selecting [On] for Destination Check before Send, the confirmation screen of destinations appears after pressing the [Start] key.



➔ [Dest. Check before Send \(8-25\)](#)

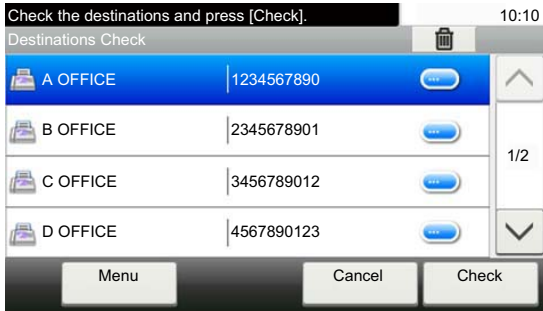

**1 Select [∨] or [^] to check all destination.**

[Selecting [☑]] shows detailed information about the selected destination.

To delete a destination: Select the destination you want to delete. > [🗑️]> [Yes]

To add the destination: select [Cancel] and then return to the destination screen.

**2 Select [Check].**

**NOTE**

Be sure to confirm all destination by displaying them on the touch panel. You cannot select [Check] unless you have confirmed all destination.

## Recall

Recall is a function allowing you to send the last entered destination once again. Or if you want to send to the same destination. In cases such as this, you can select [Recall Destination] and recall the last destination to which you sent a fax back into the destination list.

**1 Select [Recall].**

This displays the destination of the last send.

**NOTE**

When the last sending included FAX, folders and E-mail destinations, they are also displayed. Add or delete destinations as required.

**2 Press the [Start] key.**

Transmission begins.

**NOTE**

- When [On] is selected in [Dest. Check before Send], a destination confirmation screen is displayed when you press the [Start] key.

➔ [Confirmation Screen of Destinations \(5-30\)](#)

- Recall information is canceled in the following conditions.
  - When you turn the power off
  - When you send a next image (new recall information is registered)
  - When you log out

## How to Use the FAX Function

On products with a FAX function, it is possible to use the FAX function. The optional FAX Kit is required in order to make use of fax functionality.

➔ [FAX Operation Guide](#)

# Basic Operation for Document Box

This section explains basic operations for document boxes, using examples where tasks are carried out with custom boxes.

 **NOTE**

In the following explanation, it is assumed that user login administration is enabled. For details on User Logon privileges, refer to the following:

➔ [Edit the custom box. \(3-52\)](#)

## Box List Operations

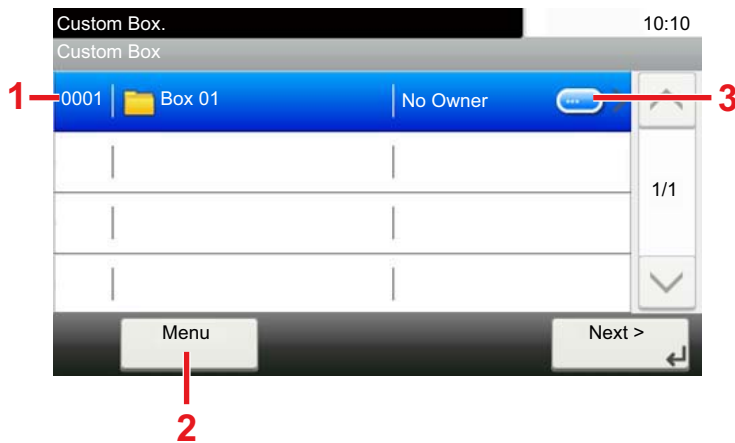

- 1 This opens the selected box.
- 2 You can select [Menu] and then perform one of the following operations: search for a Document Box search (box name, box number), change the sorting sequence of display items (box name, box number, owner), register a new box, modify or delete a box.
- 3 This displays detailed information about each box.

## Document List Operations

The document list is a list of the documents stored in the custom box. The operations below are available.

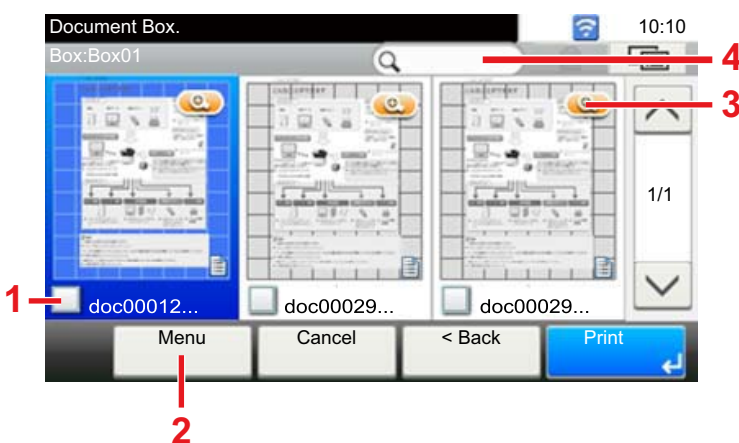

- 1 A check mark indicates an item is selected.
- 2 You can select [Menu] and then perform one of the following operations: print, move, search for (by name), edit, or delete a document, select or deselect all, change the sorting sequence of display items (name, box number, owner)
- 3 Shows detailed information about the document.
- 4 Can be used for a document name search.

 **NOTE**

- You can select multiple documents by pressing the respective document checkboxes.
- Select [  ] to change to list display.

# Custom Box Operations

## Saving Scanned Documents to a Custom Box

### 1 Display the screen.

- 1 [Home] key > [Custom Box]

### 2 Place the originals.

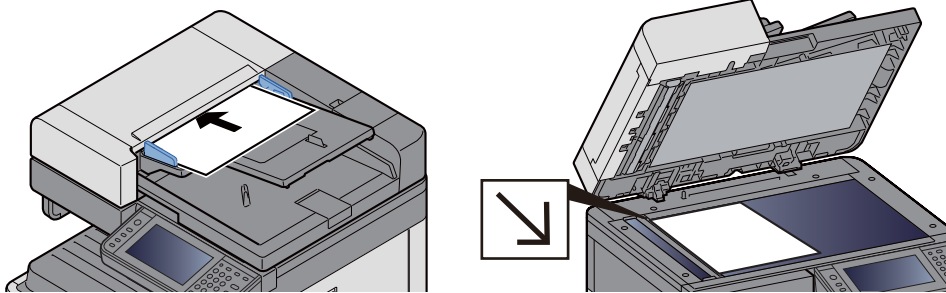

➔ [Place the Originals. \(5-3\)](#)

### 3 Store the forms.

- 1 Select the box > [Menu] > [Store File]
- 2 Specify the type of originals, scanning density, etc., as necessary.  
For the features that can be set, refer to the following:

➔ [\[Store File\] \(xiv\)](#)



#### NOTE

- Enter up to 32 characters as the file name.
- To add or recall a favorite, select the [Favorites] icon.

➔ [Editing the Home Screen \(3-8\)](#)

- 3 Press the [Start] key.

The original is scanned and the data is stored in the specified Custom Box.

## Moving Documents in Custom Box

This function allows you to move documents stored in custom boxes into other boxes.

### 1 Display the screen.

[Home] key > [Custom Box] > Select the box.



#### NOTE

If a custom box is protected by a password, enter the correct password.

## 2 Move the documents.

- 1 Select the document in the list that you want to move by selecting the checkbox.  
The document is marked with a checkmark.

### NOTE

To cancel a selection, select the checkbox again so that it is no longer ticked.

- 2 [Menu] > [Move/Copy] > [Move to Another Custom Box]
- 3 Select the move destination.
- 4 [Select Current Folder] > [Yes]  
This moves the selected documents.

### NOTE

If the box to which the document is being moved is protected by a password, enter the correct password.

## Copying Documents in Custom Box into Other Boxes

This function allows you to copy documents stored in custom boxes into other boxes.

### 1 Display the screen.

- 1 [Home] key > [Custom Box] > Select the box.

### NOTE

If a custom box is protected by a password, enter the correct password.

### 2 Move the documents.

- 1 Select the document in the list that you want to copy by selecting the checkbox.  
The document is marked with a checkmark.

### NOTE

To cancel a selection, select the checkbox again so that it is no longer ticked.

- 2 [Menu] > [Move/Copy] > [Copy to Another Custom Box]
- 3 Select the copy destination.
- 4 [Copy] > [Yes]  
The selected document is copied.

### NOTE

If the box to which the document is being copied is protected by a password, enter the correct password.

## Copying Documents in Custom Box to Removable Memory

This function allows you to copy documents stored in custom boxes to removable memory.

## 1 Display the screen.

- 1 [Home] key > [Custom Box] > Select the box.



### NOTE

If a custom box is protected by a password, enter the correct password.

## 2 Move the documents.

- 1 Select the document in the list that you want to copy by selecting the checkbox.  
The document is marked with a checkmark.



### NOTE

To cancel a selection, select the checkbox again so that it is no longer ticked.

- 2 [Menu] > [Move/Copy] > [Copy to Memory]
- 3 Select the copy destination.
- 4 [Select Current Folder] > [Yes]  
The selected document is copied.

## Joining Documents in Custom Box

You can join documents within a custom box into one file.



### NOTE

You can only join a document to other documents in the same custom box. If necessary, move the documents to be joined beforehand.

## 1 Display the screen.

- [Home] key > [Custom Box] > Select the box.



### NOTE

If a custom box is protected by a password, enter the correct password.

## 2 Join the document.

- 1 Select the documents in the list that you wish to join by selecting the checkbox.  
The document is marked with a checkmark.  
You can join up to 100 documents.



### NOTE

To cancel a selection, select the checkbox again so that it is no longer ticked.

- 2 Arrange the documents in the order they will be joined. > [OK]  
Highlight the document you want to move and then use [Cancel] and [Clear] to move it.

- 3 Enter the name for the joined document > [Next >]

Enter up to 64 characters as the document name.

➔ [Character Entry Method \(12-13\)](#)

- 4 Select [Yes].

The documents are joined.

 **NOTE**

After joining, the original documents are left unchanged. Delete the documents if they are no longer needed.

## Deleting Documents in Custom Box

### 1 Display the screen.

[Home] key > [Custom Box] > Select the box.

 **NOTE**

If a custom box is protected by a password, enter the correct password.

### 2 Delete the document.

- 1 Select the document in the list that you want to delete by selecting the checkbox.

The document is marked with a checkmark.

 **NOTE**

You cannot select [🗑️] without first selecting a document.

To cancel a selection, select the checkbox again so that it is no longer ticked.

- 2 [🗑️] > [Yes]

The document is deleted.

## Sending Documents in a Custom Box

### 1 Display the screen.

- 1 [Home] key > [Custom Box] > Select the box.

 **NOTE**

If a custom box is protected by a password, enter the correct password.

### 2 Send Start.

- 1 Select the document in the list that you want to send by selecting its checkbox.

The document is marked with a checkmark.

 **NOTE**

You cannot select and send multiple documents.

To cancel a selection, select the checkbox again so that it is no longer ticked.

- 2 Select [Send].

 **NOTE**

Depending on the settings, the address book screen may appear.

- 3 Set the destination.

For more information on selecting destinations, refer to the following:

➔ [Destination Operations \(5-27\)](#)

- 4 Specify the file type, resolution, and other settings as desired.

For the features that can be set, refer to the following:

➔ [\[Send\] \(xvi\)](#)

 **NOTE**

For information about registering a shortcut or recalling a favorite, refer to the information below.

➔ [Registering Shortcuts \(Copy, Send, and Document Box Settings\) \(3-46\)](#)

➔ [Recalling Frequently Used Functions \(Favorites\) \(3-41\)](#)

- 5 Press the [Start] key.

Sending of the selected document begins.

## Sending Documents in Custom Box to E-mail Address of Logged in user.

When user login is enabled, documents in the custom box are sent to the E-mail address of the logged in user.

 **NOTE**

When this function is used, functions other than transmission cannot be used.

Before using this function, the following are necessary.

- The function icon must be displayed in the home screen.

➔ [Editing the Home Screen \(3-8\)](#)

- An E-mail address must be set in user login for the user who logs in.

➔ [Adding a User \(Local User List\) \(9-7\)](#)



- 1 Select [Home] key.
- 2 Select [Send to Me(E-mail)].

## Scanning Document Stored in a Custom Box

Follow the steps as below for scanning a document stored in a custom box using the TWAIN driver.

### NOTE

Before sending a document, confirm that TWAIN driver is installed on a computer and the settings are configured.

➔ [Setting TWAIN Driver \(2-37\)](#)

To read a document stored in a custom box, use the TWAIN driver setting screen to change from "Model" to a model name that has "(Box)" appended.

## 1 Display the screen.

- 1 Activate the TWAIN compatible application software.
- 2 Select the machine using the application and display the dialog box.

### NOTE

For selecting the machine, see the Operation Guide or Help for each application software.

## 2 Display lists of documents.

- 1 Select a custom box from "Box List" the stored a document.  
If a password has been set for the box, the password entry screen appears. Enter the password and click the [OK] button. When you select a box, the document files in the Custom Box appear in [Document List].
- 2 Set how to display the document data. Click the [Start] button to select each item.

### NOTE

For the settings, refer to Help in the dialog box.

- 3 Click the [OK] button.

## 3 Scan the originals.

- 1 Select the document data to be scanned from [Document List].  
Enter the document data name in the Search (Name) to find the data having the same document data name or the document data name with the same beginning.  
Click the [Detail] button to display the selected document data. When the document data includes multiple pages, select the checkbox beside the pages you want to scan. The selected pages will be scanned.

### NOTE

In this case, the scanned page or the selected document data will not be deleted from the Custom Box.

- 2 Click the [Acquire] button.  
This scans the document data to the computer.

# Printing Data Saved on the Machine

You can save a print job using a Custom Box or Job Box of this machine and print it when required.

## Printing Documents from Private Print Box

In Private Printing, you can specify that a job is not to be printed until you operate the machine. When sending the job from the application software, specify a 4-digit access code in the printer driver. The job is released for printing by entering the access code on the operation panel, ensuring confidentiality of the print job. The data will be deleted upon completion of the print job or after the power switch is turned off.

### 1 Display the screen.

- 1 [Home] key > [Job Box]
- 2 Select [Private Print/Stored Job].
- 3 Select the creator of the document.

### 2 Print the document.

- 1 Select the document to print > [Print]
- 2 Enter the access code.
- 3 Specify the number of copies to print as desired.
- 4 Select [OK].

Printing starts.

Upon completion of printing, the Private Print job is automatically deleted.

## Deleting the Documents Stored in the Private Print Box

### 1 Display the screen.

- 1 [Home] key > [Job Box]
- 2 Select [Private Print/Stored Job].
- 3 Select the creator of the document.

### 2 Delete the document.

- 1 Select the document to delete. > [🗑️]

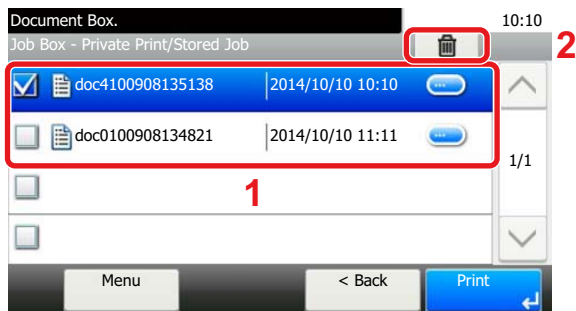

- 2 Enter the access code.  
The document is deleted.

## Printing Document from Stored Job Box

In Stored Job, the print data sent from the application is saved to the machine. You can set up an access code as necessary. If you set up an access code, enter the access code when printing. Print data will be stored in the Stored Job Box after printing. This will allow printing of the same print data repeatedly.

### 1 Display the screen.

- 1 [Home] key > [Job Box]
- 2 Select [Private Print/Stored Job].
- 3 Select the creator of the document.

### 2 Print the document.

- 1 Select the document to print > [Print]
- 2 Specify the number of copies to print as desired.
- 3 Select [OK].  
Printing starts.



#### NOTE

If the document is protected by an access code, the password entry screen will be displayed. Enter the password using the numeric keys.

## Deleting the Documents Stored in the Stored Job Box

### 1 Display the screen.

- 1 [Home] key > [Job Box]
- 2 Select [Private Print/Stored Job].
- 3 Select the creator of the document.

### 2 Delete the document.

- 1 Select the document to delete. > [🗑️]

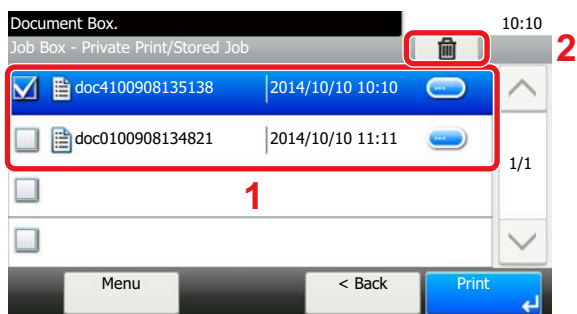

- 2 Enter the access code.  
The document is deleted.

## Printing Document from Quick Copy Box

Quick Copy feature facilitates additional prints of a document already printed. Activating Quick Copy and printing a document using the printer driver allow the print data to be stored in the Quick Copy Job Box. When additional copies are required, you can reprint the required number of copies from the touch panel. When power is turned off, all stored jobs will be deleted.

### NOTE

- Number of storable documents (factory default): 32
- When the number of jobs reaches the limit, the oldest job will be overwritten by the new one.
- To maintain free space on the box, you can set the maximum number of stored jobs.

➔ [Quick Copy Job Retention \(8-26\)](#)

### 1 Display the screen.

- 1 [Home] key > [Job Box]
- 2 Select [Quick Copy/Proof and Hold].
- 3 Select the creator of the document.

### 2 Print the document.

- 1 Select the document to print > [Print]
- 2 Specify the number of copies to print as desired.
- 3 Select [OK].  
Printing starts.

## Deleting the Documents Stored in the Quick Copy Box

### 1 Display the screen.

- 1 [Home] key > [Job Box]
- 2 Select [Quick Copy/Proof and Hold].
- 3 Select the creator of the document.

### 2 Delete the document.

- 1 Select the document to delete. > [  ]

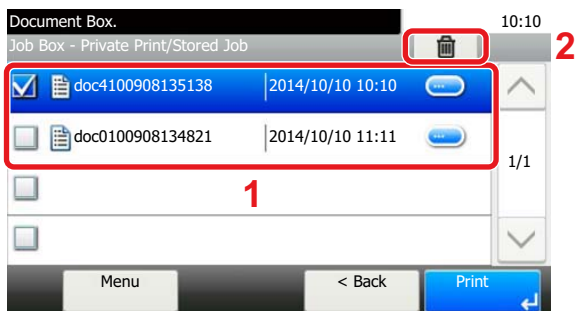

- 2 Select [Yes].  
The document is deleted.

## Printing Document from Proof and Hold Box

The Proof and Hold feature produces only a single proof print of multiple-print job and holds printing of the remaining copies. Printing a multiple-print job in Proof and Hold using the printer driver allows only a single copy to be printed while maintaining the document data in the Job Box. To continue to print the remaining copies, use the touch panel. You can change the number of copies to print.

### 1 Display the screen.

- 1 [Home] key > [Job Box]
- 2 Select [Quick Copy/Proof and Hold].
- 3 Select the creator of the document.

### 2 Print the document.

- 1 Select the document to print > [Print]
- 2 Specify the number of copies to print as desired.
- 3 Select [OK].  
Printing starts.

## Deleting the Documents Stored in the Proof and Hold Box

### 1 Display the screen.

- 1 [Home] key > [Job Box]
- 2 Select [Quick Copy/Proof and Hold].
- 3 Select the creator of the document.

### 2 Delete the document.

- 1 Select the document to delete. > [🗑️]

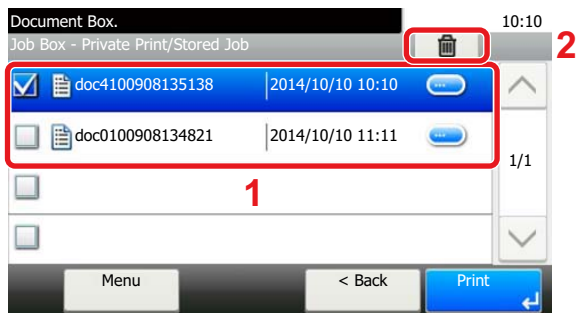

- 2 Select [Yes].  
The document is deleted.

## Printing Documents in Custom Box

### 1 Display the screen.

- 1 [Home] key > [Custom Box]

- 2 Select the box containing the document you want to print.



**NOTE**

If a custom box is protected by a password, enter the correct password.

## 2 Print the document.

- 1 Select the document you wish to send by checking the checkbox.  
The document is marked with a checkmark.



**NOTE**

To cancel a selection, select the checkbox again so that it is no longer ticked.

- 2 Select [Print].
- 3 This displays a screen for selecting print settings to be used.  
To use the settings used at the time of printing (when the document was saved), select [Print As Is]. Select [OK] to start printing.  
Printing begins.  
If you need to change the print settings, select [Print after Change Settings].
- 4 Set the paper selection, duplex printing, etc., as desired.  
For the features that can be set, refer to the following:  
[▶ \[Print\] \(xv\)](#)
- 5 Press the [Start] key.  
Printing of the selected document begins.

## Printing from the Handheld Device

This machine supports the print functions and services listed below.

- AirPrint
- Google Cloud Print
- Mopria

According to the supported OS and application, you can print the job from any handheld device or computer without installing a printer driver.

### Printing by AirPrint

AirPrint is a printing function that is included standard in iOS 4.2 and later products, and Mac OS X 10.7 and later products.

To use the AirPrint, make sure that the AirPrint setting is enabled in the Command Center RX.

➔ [Command Center RX User Guide](#)



### Printing by Google Cloud Print

Google Cloud Print is a printing service provided by Google. This service enables a user with a Google account to print from a machine connected to the Internet.

The machine can be configured in the Command Center RX.

➔ [Command Center RX User Guide](#)

#### **NOTE**

A Google account is necessary to use Google Cloud Print. Obtain a Google account if you do not have one. It is also necessary to register the machine with the Google Cloud Print service in advance. The machine can be registered from a PC connected to the same network.

### Printing by Mopria

Mopria is a standard on printing function included in Android 4.4 or later products. Mopria Print Service needs to be installed and enabled in advance.

For details on how to use, refer to a Web site of Mopria Alliance.

### Printing with Wi-Fi Direct

Wi-Fi Direct is a wireless LAN standard that Wi-Fi Alliance has been established. This is one of the functions of the wireless LAN, without a wireless LAN access point or wireless LAN router, between devices can communicate directly on a peer to peer basis.

The printing procedure by the Wi-Fi Direct is the same as that from the normal handheld devices.

When you use a printer name or Bonjour name on the port settings of the printer property, you can print the job by specifying the name at Wi-Fi Direct connection.

When you use an Time Zone for the port, specify the Time Zone of this machine.

## Printing with NFC

When the Delete after Print and Wi-Fi Direct has been configured in advance, the network between this machine and handheld device will be configured by simply tapping an NFC tag.



# Operating Using Removable USB Memory

Plugging USB memory directly into the machine enables you to quickly and easily print the files stored in the USB memory without having to use a computer.

The following file types can be printed:

- PDF file (Version 1.7 or older)
- TIFF file (TIFF V6/TTN2 format)
- JPEG file format
- XPS file format
- OpenXPS file format
- Encrypted PDF file

In addition, you can store scanned image files in USB memory connected to the machine.

The following file types can be stored:

- PDF file format
- TIFF file format
- JPEG file format
- XPS file format
- OpenXPS file format
- Word file format\*<sup>1</sup>
- Excel file format\*<sup>1</sup>
- PowerPoint file format\*<sup>1</sup>
- High-compression PDF file format

\*<sup>1</sup> Displayed only when the optional OCR Scan Activation Kit is installed.

## Saving Documents to USB Memory (Scan to USB)



### NOTE

Number of storable files: 1,000

### 1 Place the originals.

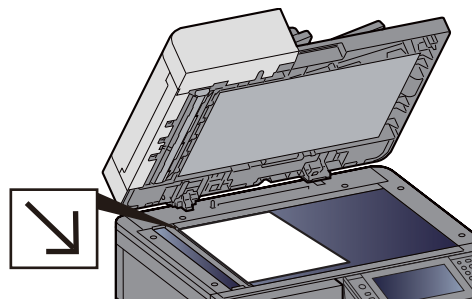
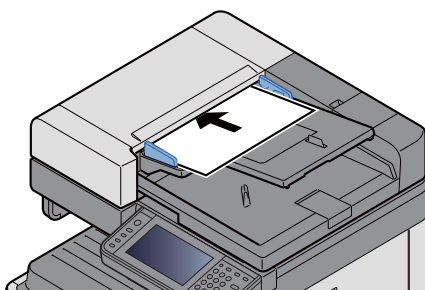

→ [Place the Originals. \(5-3\)](#)

## 2 Plug the USB memory.

- 1 Plug the USB memory into the USB Memory Slot.

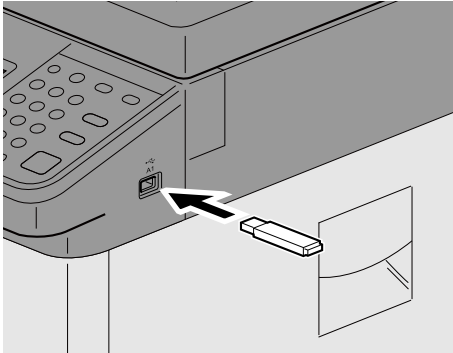

- 2 When the machine reads the USB memory, "Removable Memory is recognized. Displaying files. Are you sure?" may appear. Select [Yes].

This displays the Removable Memory screen.

### NOTE

If the message does not appear, select [Removable Memory] on the Home screen.

## 3 Store the forms.

- 1 Select the folder where the file will be stored.  
The machine will display the top 3 folder levels, including the root folder.
- 2 Select [+].
- 3 Set the type of original, file format, etc., as desired.  
For the features that can be set, refer to the following:  
[→ \[Store File\] \(xvii\)](#)
- 4 Press the [Start] key.  
The original is scanned and the data is stored in the USB memory.

## Check the USB Memory Information

- 1 In the removable memory screen, select [Memory Information].
- 2 Once you confirm the information, select [Close].

## Removing USB Memory

### IMPORTANT

Be sure to follow the proper procedure to avoid damaging the data or USB memory.

- 1 Display the screen.

[Home] key > [Removable Memory]

## 2 [Menu] > [Remove Memory]

If the message [Remove Memory] appears on the removable memory screen, select [OK] and then remove the removable memory.

### NOTE

USB memory can also be removed after checking the status of the device.

➔ [Device/Communication \(7-10\)](#)

## Printing from Removable USB Memory

### NOTE

- PDF files you wish to print should have an extension (.pdf).
- Files to be printed should be saved no further down than the top 3 folder levels, including the root folder.
- Use USB memory properly formatted by this machine.
- Plug the USB memory directly into the USB Memory Slot.

## 1 Plug the USB memory.

- 1 Plug the USB memory into the USB Memory Slot.

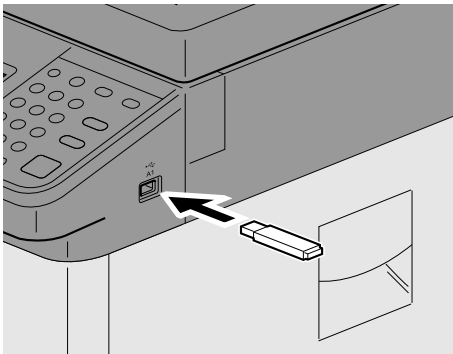

- 2 When the machine reads the USB memory, "Removable Memory is recognized. Displaying files. Are you sure?" may appear. Select [Yes].

Displays the Removable Memory screen.

### NOTE

If the message does not appear, select [Removable Memory] on the Home screen.

## 2 Print the document.

- 1 Select the folder that contains the file to be printed.

The machine will display documents in the top 3 folder levels, including the root folder.

### NOTE

- Number of displayable documents: 1,000
- To return to a higher level folder, select [< Back].

- 2 Select the file to be printed > [Print]
- 3 Change the number of copies, duplex printing, etc., as desired.  
For the features that can be set, refer to the following:  
➔ [\[Print\] \(xix\)](#)
- 4 Press the [Start] key.  
Printing of the selected file begins.

# 6 Advanced Setting of Functions

This chapter explains the following topics:

Icons in This Chapter .....	6-2
[ID Card Copy] .....	6-3
[Original Size] .....	6-4
[Paper Selection] .....	6-5
[Mixed Size Originals] .....	6-7
[Original Orientation] .....	6-9
[Collate/Offset] .....	6-10
[Staple] .....	6-12
[Paper Output] .....	6-15
[Density] .....	6-16
[Original Image] .....	6-17
[EcoPrint] .....	6-18
[Color Selection] .....	6-19
[Color Balance] .....	6-20
[Hue Adjustment] .....	6-21
[Sharpness] .....	6-22
[Contrast] .....	6-23
[Background Density Adj.] .....	6-24
[Saturation] .....	6-25
[Prevent Bleed-through] .....	6-26
[Zoom] .....	6-27
[Combine] .....	6-29
[Margin] .....	6-31
[Duplex] .....	6-32
[Continuous Scan] .....	6-35
[Auto Image Rotation] .....	6-36
[Job Finish Notice] .....	6-37
[File Name Entry] .....	6-38
[Priority Override] .....	6-39
[Skip Blank Page] .....	6-40
[2-sided/Book Original] .....	6-41
[Sending Size] .....	6-42
[File Format] .....	6-43
[File Separation] .....	6-48
[Scan Resolution] .....	6-49
[E-mail Subject/Body] .....	6-50
[FTP Encrypted TX] .....	6-51
[Delete after Printed] .....	6-52
[Delete after Transmitted] .....	6-53
[Storing Size] .....	6-54
[Long Original] .....	6-55
[Encrypted PDF Password] .....	6-56
[JPEG/TIFF Print] .....	6-57
[XPS Fit to Page] .....	6-58
[Erase Shadowed Areas] .....	6-59

## Icons in This Chapter

On pages that explain a convenient function, the modes in which that function can be used are indicated by icons.

**Printing:**



**Sending:**



**Storing:**



## [ID Card Copy]



Use this when you want to copy a driver's license or an insurance card. When you scan the front and back of the card, both sides will be combined and copied onto a single sheet.

(Value: [Off] / [On])

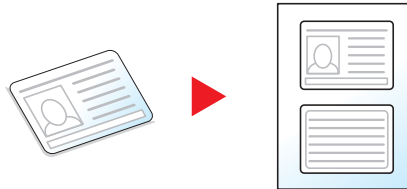

# [Original Size]



Specify the original size to

Select [Auto], [Metric], [Inch], [Others], or [Size Entry] to select the original size.

Item	Value	Description
<b>Auto</b>	---	Automatically detect the original size.
<b>Inch</b>	Ledger, Letter-R, Letter, Legal, Statement-R, Statement, 11x15", Oficio II	Select from the Inch series standard sizes.
<b>Metric</b>	A3, A4-R, A4, A5-R, A5, A6-R, B4, B5-R, B5, B6-R, B6, Folio, 216 x 340 mm	Select from the Metric standard sizes.
<b>Others</b>	8K, 16K-R, 16K, Hagaki (Cardstock), Oufuku Hagaki (Return postcard), Custom <sup>*1</sup>	Select from special standard sizes and custom sizes.
<b>Size Entry</b>	Metric X: 50 to 432 mm (in 1 mm increments) Y: 50 to 297 mm (in 1 mm increments)  Inch X: 2.00 to 17.00" (in 0.01" increments) Y: 2.00 to 11.69" (in 0.01" increments)	Enter the size not included in the standard sizes. <sup>*2</sup> When you have selected [Size Entry], select [+] or [-] to set the sizes of "X" (horizontal) and "Y" (vertical). Select [# Keys] to use the numeric keys for entry.

\*1 For information on how to register the custom original size, refer to the information below.

➔ [Custom Original Size \(8-12\)](#)

\*2 Input units can be changed with the System Menu.

➔ [\[Measurement\] \(8-20\)](#)



## NOTE

Be sure to always specify the original size when using custom size originals.



## [Paper Selection]



Select the cassette or multi-purpose tray that contains the required paper size.

If [Auto] is selected, the paper matching the size of the original is selected automatically.



### NOTE

- Specify in advance the size and type of the paper loaded in the cassette.
- ➔ [\[Cassette/MP Tray Settings\] \(8-9\)](#)
- Cassettes after Cassette 2 to 3 are displayed when the optional paper feeder is installed.

To select [Multipurpose Tray], press [Paper Settings] and specify the paper size and the media type.

The available paper sizes and media types are shown in the table below.

Item		Value	Description
Paper Size	Inch	Ledger, Letter-R, Letter, Legal, Statement-R, Executive, Oficio II	Select from the Inch series standard sizes.
	Metric	A3, A4-R, A4, A5-R, A6-R, B4, B5-R, B5, B6-R, Folio, 216 x 340mm	Select from the Metric series standard sizes.
	Others	ISO B5, Envelope #10, Envelope #9, Envelope #6, Envelope Monarch, Envelope DL, Envelope C5, Envelope C4, Hagaki (Cardstock), Oufuku Hagaki (Return postcard), Youkei 4, Youkei 2, 8K, 16K-R, 16K	Select from special standard sizes and custom sizes.
	Size Entry	Metric X: 148 to 432 mm (in 1 mm increments) Y: 98 to 297 mm (in 1 mm increments)	Enter the size not included in the standard size.*1 When you have selected [Size Entry], use [+]/[-] or the numeric keys to set the sizes of "X" (horizontal) and "Y" (vertical). Select [# Keys] to use the numeric keys for entry.
Inch X: 5.83 to 17.00" (in 0.01" increments) Y: 3.86 to 11.69" (in 0.01" increments)			
Media type		Plain (60 to 105 g/m <sup>2</sup> ), Transparency, Vellum (59 g/m <sup>2</sup> or less), Labels, Recycled, Preprinted*2, Bond, Cardstock, Color, Prepunched*2, Letterhead*2, Envelope, Thick (106 g/m <sup>2</sup> or more), Coated, High Quality, Custom 1-8*2	

\*1 The input units can be changed in System Menu.

➔ [\[Measurement\] \(8-20\)](#)

\*2 For instructions on how to specify the custom paper types 1 to 8, refer to the following:

➔ [Media Type Setting \(8-14\)](#)

To print on preprinted or prepunched paper or on letterhead, refer to the following:

➔ [Special Paper Action \(8-14\)](#)

### IMPORTANT

When paper size and the media type for MP tray is specified, [Media Type] is selected. Note that if [Multipurpose Tray] is pressed at this point, the settings will be canceled.

### NOTE

- You can conveniently select in advance the size and type of paper that will be used often and set them as default.

➔ [\[Multi Purpose Tray\] \(8-10\)](#)

- If the specified size of paper is not loaded in the paper source cassette or multi purpose tray, a confirmation screen appears. Load the required paper in the multi purpose tray and select [Continue]. Copying starts.

# [Mixed Size Originals]



Scans all sheets in the document processor, even if they are of different sizes.

This function cannot be used if platen is used.

## Copying

Item	Available settings	Description
Mixed Size Originals	Off	
	Configure the settings.	Scans and copies multiple sheets of the same width using the document processor.

## Sending

Item	Value	Description
Mixed Size Originals	Off	-
	Same Width	Scans and sends multiple sheets of the same width using the document processor.

## Storing

Item	Value	Description
Mixed Size Originals	Off	-
	Same Width	Scans and stores multiple sheets of the same width using the document processor.

## Supported Combinations of Originals

### Same Width

When the original widths are the same, the combinations of originals that can be placed are as follows.

- B4 and B5
- A3 and A4 (Ledger and Letter)
- A4-R and Folio (Legal and Letter-R)

Example: B4 and B5

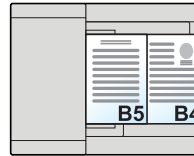
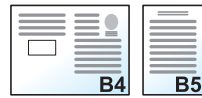

 **NOTE**

- When mixing the original sizes as using the following combination, make sure to set "Auto Detect Original Size" to [On] for "Folio".

A4-R and Folio

➔ [Auto Detect Original Size \(8-12\)](#)

- Loading Originals in the Document Processor: up to 30 sheets

# [Original Orientation]



Select the orientation of the original document top edge to scan correct direction.

To use any of the following functions, the document's original orientation must be set.

- Zoom
- Duplex
- Margin
- Combine
- Stapling (Option)
- [2-sided/Book Original]

Select original orientation from [Top Edge on Top], [Top Edge on Left].

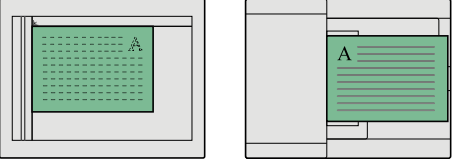
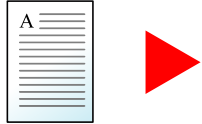
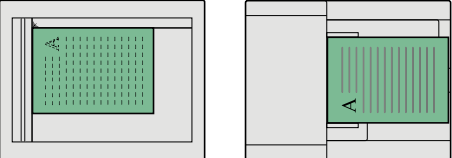
Setting Items	Image	
Top Edge on Top		
Top Edge on Left		
Auto*1		

\*1 Displayed only when the optional OCR Scan Activation Kit is installed.

 **NOTE**

The default setting for Original Orientation can be changed.

➔ [Original Orientation \(Copy\) \(8-16\)](#)

➔ [Original Orientation \(Send/Store\) \(8-16\)](#)

# [Collate/Offset]



Offsets the output by page or set.

## Collate

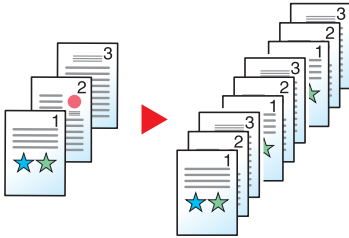

Scans multiple originals and delivers complete sets of copies as required according to page number.

## Offset

Without Document Finisher (Option)

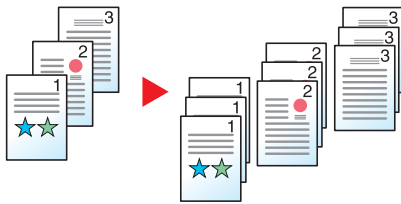

When offset is used, the paper of each set (or each page) is rotated 90 degrees when output.

### NOTE

When offset is used without a Document Finisher, an additional paper feed unit is required. The paper size of the additional paper feed unit must be the same as that of the selected paper feed unit, but the paper orientation must be different.

The paper sizes supported in Offset: A4, B5, Letter, 16K

Without Document Finisher (Option)



When offset is used, the paper of each set (or each page) is offset when output.

Setting Items	Description
Off	Sort and offset are not performed.
Collate Only	Collate Only

<b>Offset Each Page</b>	Each page is offset.
<b>Offset Each Set</b>	Offset Each Set

# [Staple]

Copy

Custom  
BoxUSB  
Memory**NOTE**











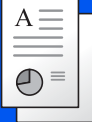



This function requires the optional Sheet Finisher.

Staples the finished documents. The staple position can be selected.

Item	Value	Description
Staple:	Off	
	1 staple (Top Left)	Select the staple position. For details on original orientation and staple position, refer to the following: ➔ <a href="#">Original Orientation and Staple Position (6-13)</a>
	1 staple (Top Right)	
	2 staples (Left)	
	2 staples (Top)	
	2 staples (Right)	
Original Orientation	Top Edge on Top, Top Edge on Left	



**Original Orientation and Staple Position**

[Original Orientation]	Top Edge on Top		Top Edge on Left	
Image				
Cassette paper orientation 				
Cassette paper orientation 				



**NOTE**

One position staple is not slanted for the following paper sizes.

B5-R, 16K-R

**Mixed Size Stapling**

Even with mixed paper sizes, if the sizes have the same width as shown in the combinations below, the output can be stapled.

- A3 and A4
- B4 and B5
- Ledger and Letter
- Legal and Letter-R

• 8K and 16K

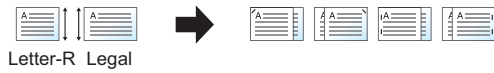
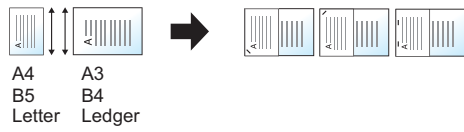

 **NOTE**

- Number of sheets that can be stapled: up to 25 sheets.
- When performing Mixed Size Stapling, refer to the following:  
➔ [\[Mixed Size Originals\] \(6-7\)](#)

# [Paper Output]

Copy

Custom  
BoxUSB  
Memory

Specify the output tray.

Setting Items	Description
Inner Tray <sup>*1</sup>	Outputs to the Inner Tray of the machine.
Job Separator Tray	Delivery to the job separator tray.

with optional Document Finisher

Item	Description
Finisher Tray <sup>*1</sup>	Delivery to the tray of the optional Document Finisher.
Job Separator Tray	Delivery to the job separator tray.

\*1 Display only when an optional Sheet Finisher is installed.



## NOTE

The default setting for Paper Output can be changed.

➔ [Paper Output \(8-18\)](#)

# [Density]



Adjust density.

(Value: [-4] to [+4] (Lighter to Darker))



# [Original Image]



Select original image type for best results.

## Copying

Item		Description	
<b>Text+Photo</b> <sup>*1</sup>		Best for mixed text and photo documents.	
<b>Photo</b>		Best for photos taken with a camera.	
<b>Text</b>		Best for documents that are mostly text.	
<b>Graphic/Map</b>		Best for graphics and maps.	
<b>Printer Output</b>		Best for documents printed on this machine originally.	
<b>Others</b>	<b>Original Image</b>	<b>Text+Photo</b>	Best for mixed text and photo documents.
		<b>Photo</b>	Best for photos taken with a camera.
		<b>Text</b>	Best for documents that are mostly text.
		<b>Graphic/Map</b>	Best for graphics and maps.
		<b>Printer Output</b>	Best for documents printed on this machine originally.
	<b>Highlighter</b>	<b>On</b>	Select to bring out text and markings made with a highlighter pen. Reproduces the color of the highlighter pen to the extent possible.
		<b>Off</b>	Does not reproduce the color of the highlighter.

\*1 If gray text is not printed completely using [Text+Photo], selecting [Text] may improve the result.

## Sending/Storing

Item	Description
<b>Text+Photo</b>	Best for mixed text and photo documents.
<b>Photo</b>	Best for photos taken with a camera.
<b>Text</b>	Sharply renders pencil text and fine lines. Text
<b>Light Text/Fine Line</b>	Clearly reproduces faint characters written in pencil, etc., and thin lines on map originals or diagrams.

## [EcoPrint]



EcoPrint saves toner when printing. Use this function for test prints or any other occasion when high quality print is not required.

(Value: [Off] / [On])

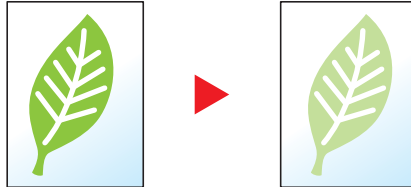

# [Color Selection]



Select the color mode setting.

## Copying

Item	Description
Auto Color	Automatically recognizes whether documents are color or black and white.
Full Color	Prints documents in full color.
(B & W)	Prints documents in black and white.

## Printing

Item	Description
Full Color <sup>*1</sup>	Prints documents in full color.
(B & W) <sup>*1</sup>	Prints documents in black and white.

\*1 Not displayed when printing from the Document Box.

## Sending/Storing

Item	Description
Auto (Color/Gray)	Automatically recognizes whether the document is color or black and white, and scan color documents in Full Color and black and white documents in Grayscale.
Auto (Color/B & W)	Automatically recognizes whether the document is color or black and white, and scan color documents in Full Color and black and white documents in Black and White.
Full Color	Scans a document in full color.
Grayscale	Scans the document in grayscale. Produces a smooth, detailed image.
(B & W)	Prints in black &white.

# [Color Balance]



Adjust the strength of cyan, magenta, yellow, and black.

**Example:**

Less Magenta



Original

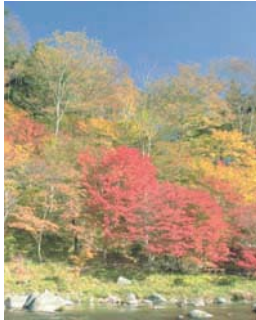

More Magenta



Item		Description
Off		
On	Cyan	Use the [<] and [>] keys, which are at both sides of the color to be adjusted (cyan, magenta, yellow, black), to adjust each color.
	Magenta	
	Yellow	
	Black	



**NOTE**

This feature is used with full color and auto color copying.



# [Hue Adjustment]



Adjust the color (hue) of images.

Make adjustments such as adjusting red to a strong yellow-red or yellow to a strong green-yellow to make more creative copies.

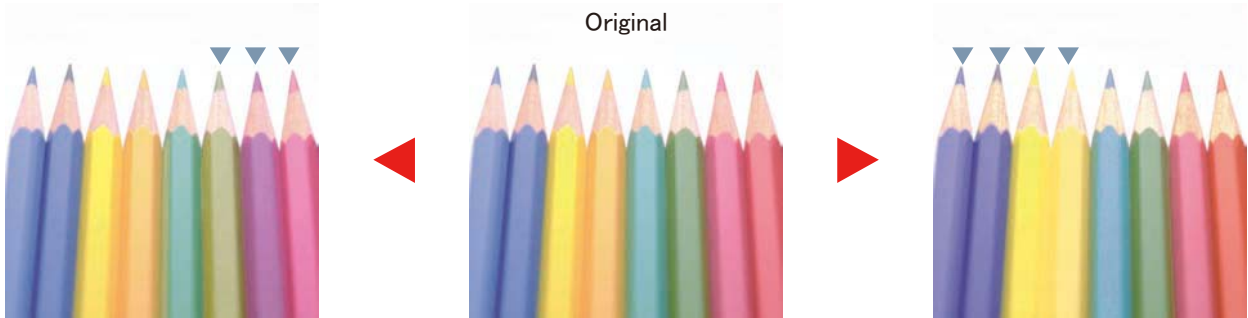

When adjusting yellow to more green, blue to more magenta (the ▼ part)

When adjusting yellowish-red to more yellow, bluish-cyan to more blue (the ▼ part)

The following settings can be set.

Item	Description
<b>Off</b>	
<b>All</b>	Adjust hue for all colors. Use the [<] and [>] keys to adjust the hue.
<b>Individual</b>	Select individual colors to adjust the hue. Select [Red], [Magenta], [Blue], [Yellow], [Green] or [Cyan] and use [<] or [>] to adjust the hue.

**NOTE**

This feature is used with full color and auto color copying.  
These adjustments are especially useful on rich color images.

# [Sharpness]



Adjusts the sharpness of image outlines.

When copying penciled originals with rough or broken lines, clear copies can be taken by adjusting sharpness toward "Sharpen". When copying images made up of patterned dots such as magazine photos, in which moire<sup>\*1</sup> patterns appear, edge softening and weakening of the moire effect can be obtained by setting the sharpness toward "Blur".

Less Sharp



Original



More Sharp

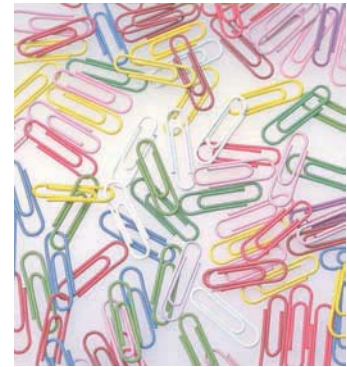

Item	Description
[+1] to [+3] (Sharpen)	Emphasizes the image outline.
[-1] to [-3] (Blur)	Blurs the image outline. Can weaken a Moire <sup>*1</sup> effect.

\*1 Patterns that are created by irregular distribution of halftone dots.

# [Contrast]



You can adjust the contrast between light and dark areas of the image.

Lower



Original



Higher



Item	Description
[+1] to [+4] (Higher)	Increases the sharpness of colors.
[-1] to [-4] (Lower)	Creates smoother colors.

## [Background Density Adj.]



Removes dark background from originals, such as newspapers.

If the ground color is obtrusive, select [Auto]. If [Auto] does not remove the background color, select [Manual] and adjust the background color density.

Setting Items	Description
<b>Off</b>	Does not adjust the ground color.
<b>Auto</b>	Automatically adjusts the background density based on the original.
<b>Manual</b>	Select [1] to [5] (Lighter - Darker) to adjust the background density manually.

# [Saturation]



Adjust the color saturation of the image.

Grayish



Results in paler color.

Original



Vivid



Results in more vivid color.



## NOTE

This feature is used with full color and auto color. Saturation is disabled if Auto Color detects black and white originals.

Item	Description
[-1] to [-3] (Grayish)	Results in paler color.
[+1] to [+3] (Vivid)	Results in more vivid color.

## [Prevent Bleed-through]



Hides background colors and image bleed-through when scanning thin original.

(Value: [Off] / [On])

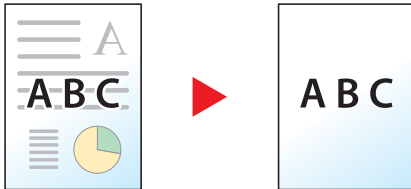

# [Zoom]



Adjust the zoom to reduce or enlarge the image.

## Copying

The following zoom options are available.

### Auto

Adjusts the image to match the paper size.

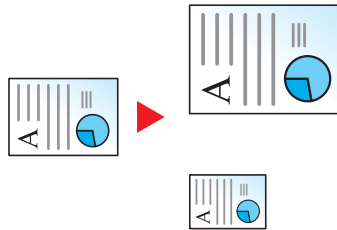

### Standard Zoom

Reduces or enlarges at preset magnifications.

Model	Zoom Level (Original Copy)		Model	Zoom Level (Original Copy)	
<b>Metric Models</b>	400% Max.	90% Folio>>A4	<b>Inch Models</b>	400% Max.	78% Legal>>Letter
	200% A5>>A3	75% 11x15">>A4		200% STMT>>Ledger	77% Ledger>>Legal
	141% A4>>A3, A5>>A4	70% A3>>A4, A4>>A5		154% STMT>>Legal	64% Ledger>>Letter
	127% Folio>>A3	50%		129% Letter>>Ledger	50% Ledger>>STMT
	106% 11x15">>A3	25% Min.		121% Legal>>Ledger	25% Min.
	100%			100%	

### Others

Reduces or enlarges at magnifications other than the Standard Zoom.

Model	Zoom Level (Original Copy)	Model	Zoom Level (Original Copy)
<b>Metric Models</b>	115% B5>>A4	<b>Inch Models</b>	141% A5>>A4
	86% A4>>B5		115% B5>>A4
	129% Statement>>Letter		90% Folio>>A4
	78% Legal>>Letter		86% A4>>B5
	64% Letter>>Statement		70% A4>>A5

### Zoom Entry

Manually reduces or enlarges the original image in 1% increments between 25% and 400%. Use the numeric keys or select [+] or [-] to enter the any magnification.

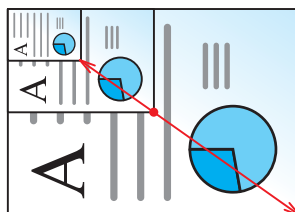

## Printing/Sending/Storing

Item	Description
100%	Reproduces the original size.
Auto	Reduces or enlarges original to sending/storing size.



### NOTE

To reduce or enlarge the image, select the paper size, sending size, or storing size.

➔ [\[Paper Selection\] \(6-5\)](#)

➔ [\[Sending Size\] \(6-42\)](#)

➔ [\[Storing Size\] \(6-54\)](#)



# [Combine]



Combines 2 or 4 original sheets into 1 printed page.

You can select the page layout and the type of boundary lines around the pages.

The following types of the boundary lines are available.

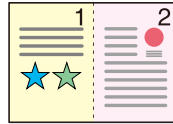
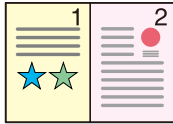

None

Solid Line

Dotted Line

Positioning Mark

Item		Available settings	Description
<b>Off</b>		—	Disables the function.
<b>2 in 1</b>		—	Prints a two-sheet original on a single sheet.
<b>4 in 1</b>		—	Prints a four-sheet original on a single sheet.
<b>Others</b>	<b>Combine</b>	Off, 2 in 1 (L to R/T to B), 2 in 1 (R to L/B to T), 4 in 1 (Right then Down), 4 in 1 (Left then Down), 4 in 1 (Down then Right), 4 in 1 (Down then Left)	Select how to lay out the pages of scanned original.
	<b>Border Line</b>	None, Solid Line, Dotted Line, Positioning Mark	Select the boundary line type.
	<b>Original Orientation</b>	Top Edge on Top, Top Edge on Left	Select the orientation of the original document top edge to scan correct direction.

## Layout Image

Item		Image
2 in 1	L to R/T to B	
	R to L/B to T	
4 in 1	Right then Down	
	Left then Down	
	Down then Right	
	Down then Left	

### NOTE

- The paper sizes supported in Combine mode: A3, A4-R, A4, A5-R, B4, B5-R, B5, Folio, 216×340mm, Ledger, Letter-R, Letter, Legal, Statement-R, Oficioll, 8K, 16K-R, 16K
- When placing the original on the platen, be sure to copy the originals in page order.

# [Margin]



## Copying/Printing

Add margins (white space). In addition, you can set the margin width and the back page margin.

### NOTE

The default setting for margin width can be changed.

➔ [Margin \(8-17\)](#)

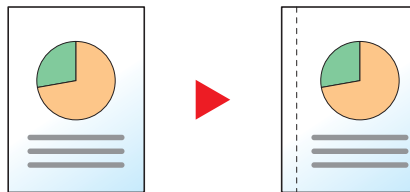

Item		Available settings		Description
Off				No margins are set.
On	Margin	L/R(-18 - +18)	Metric: -18 mm to +18 mm (in 1 mm increments) Inch: -0.75 to +0.75" (in 0.01" increments)	Set the margin width.* <sup>1</sup> Use [+] and [-] to adjust the "L/R(-18 - +18)" and "T/B(-18 - +18)" margin values. You can enter numeric values using the [# Keys].
		T/B(-18 - +18)		
	Back Page	Auto		For duplex copying, press [Back Page], and then and select [Auto] or [Manual]. An appropriate margin is applied automatically on the rear page depending on a margin specified for the front page and a binding orientation.
		Manu al	L/R(-18 - +18) T/B(-18 - +18)	Metric: -18 mm to +18 mm (in 1 mm increments) Inch: -0.75 to +0.75" (in 0.01" increments) You can set a different margin than the front on the back. Set the margin in the screen that is displayed. The setting selections are the same as for the front.* <sup>1</sup> Use [+] and [-] to adjust the "L/R(-18 - +18)" and "T/B(-18 - +18)" margin values. You can enter numeric values using the [# Keys].
Original Orientation		Top Edge on Top, Top Edge on Left		Select the orientation of the original document top edge to scan correct direction. Press [Original Orientation] and then select the original orientation as either [Top Edge on Top] or [Top Edge on Left]. Next, select [OK].

\*1 Input units can be changed with the System Menu.

➔ [\[Measurement\] \(8-20\)](#)

## Sending

When you have sent/stored the original after specifying the original size and sending size, depending on these sizes, a margin is created at the bottom, left, or right side of paper. By using the centering, the image is placed with a margin equally created at each of the page Top/Bottom and Left/Right.

(Value: [Off] / [On])

# [Duplex]



Produces two-sided copies. You can also create single-sided copies from two-sided originals.

The following modes are available.

## 1-sided to 2-sided

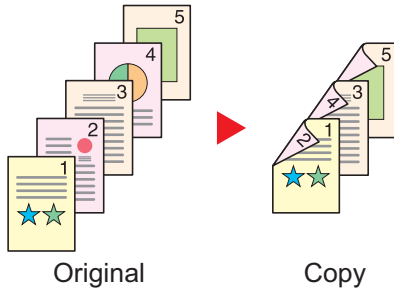

Produces two-sided copies from one-sided originals. In case of an odd number of originals, the back side of the last copy will be blank.

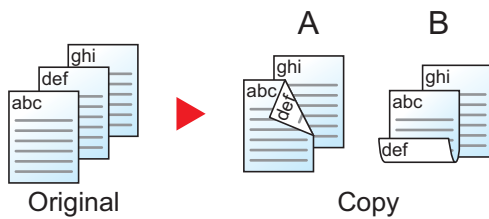

The following binding options are available.

- A Binding Left/Right: Images on the back sides are not rotated.
- B Binding Top: Images on the back sides are rotated 180 degrees. Copies can be bound on the top edge, facing the same orientation when turning the pages.

## 2-sided to 1-sided



Copies each side of a two-sided original onto two individual sheets.

The following binding options are available.

- Binding Left/Right: Images on the second sides are not rotated.
- Binding Top: Images on the second sides are rotated 180 degrees.

## 2-sided to 2-sided

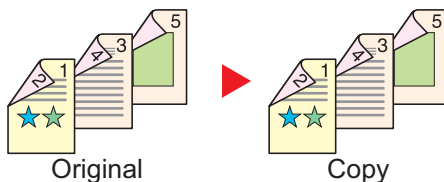

Produces two-sided copies from two-sided originals.



### NOTE

The paper sizes supported in Two-sided to Two-sided mode: A3, A4-R, A4, A5-R, B4, B5-R, B5, 216×340mm, Ledger, Letter-R, Letter, Legal, Statement-R, Executive, OficioII, Folio, and 8K

## Book to One-sided

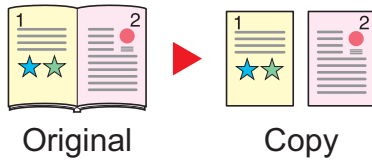

Produces a 1-sided copy of a 2-sided or open book original.

The following binding options are available.

Binding Left: Originals with facing pages are copied from left to right.

Binding Right: Originals with facing pages are copied from right to left.

### NOTE

- The original sizes supported in Book to One-sided mode: A3, A4-R, A5-R, B4, B5-R, Ledger, Letter-R, and 8K
- The paper sizes supported in Book to One-sided mode: A4, B5, Letter and 16K

## Book to Two-sided

Book → Book →  
Front and Back Book

Produces two-sided copies from an open book original with facing pages.

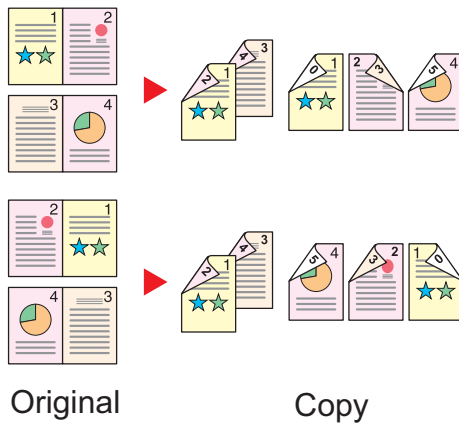

### NOTE

- The original sizes supported in Book to Two-sided mode: A3, A4-R, A5-R, B4, B5-R, Ledger, Letter-R, and 8K
- The paper sizes supported in Book to Two-sided mode: A4, B5, Letter, and 16K

## Copying

Prints 1-sided or open book originals to 2-sided, or 2-sided or open book originals to 1-sided. Select the binding orientation for original and finished documents.

Item		Available settings	Description
<b>1-sided&gt;&gt;1-sided</b>		—	Disables the function.
<b>1-sided&gt;&gt;2-sided</b>		—	Copy the original with the default setting. For the default settings, refer to the following:
<b>2-sided&gt;&gt;1-sided</b>		—	
<b>2-sided&gt;&gt;2-sided</b>		—	
<b>Others</b>	<b>Duplex</b>	1-sided>>1-sided, 1-sided>>2-sided, 2-sided>>1-sided, 2-sided>>2-sided, Book>>1-sided, Book>>2-sided	Select the desired duplex option.
	<b>Binding in Original<sup>*1</sup></b>	Binding Left/Right, Binding Top, Binding Left, Binding Right	Select the binding orientation of originals.
	<b>Binding in Finishing<sup>*2</sup></b>	Binding Left/Right, Binding Top, Book>>2 sided, Book>>Book	Select the binding orientation of copies.
	<b>Original Orientation</b>	Top Edge on Top, Top Edge on Left Auto <sup>*3</sup>	Select the orientation of the original document top edge to scan correct direction.

\*1 Displayed when [2-sided>>1-sided], [2-sided>>2-sided], [Book>>1-sided] or [Book>>2-sided] is selected for "Duplex".

\*2 Displayed when [1-sided>>2-sided], [2-sided>>2-sided] or [Book>>2-sided] is selected for "Duplex".

\*3 Displayed only when the optional OCR Scan Activation Kit is installed.

When placing the original on the platen, consecutively replace each original and press the [Start] key.

After scanning all originals, select [Finish Scan] to start copying. Copying starts.

## Printing

Print a document to 1-sided or 2-sided sheets.

Setting Items	Available settings	Description
<b>1-sided</b>	—	Disables the function.
<b>2-sided</b>	Binding Left/Right	Prints a 2-sided document so that the sheets are aligned properly for binding on the left or right.
	Binding Top	Prints a 2-sided document so that the sheets are aligned properly for binding on the top.

# [Continuous Scan]



Scans a large number of originals in separate batches and then produce as one job. Originals will be scanned continuously until you select [Finish Scan].

Select [On] to use continuous scanning.

(Value: [Off] / [On])

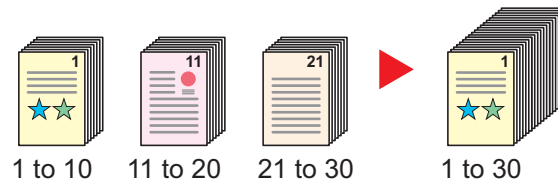

# [Auto Image Rotation]

Copy

Automatically rotates the image 90 degrees when the sizes of the original and the loaded paper matches but the orientations are different.

Value: [Off] / [On]



## NOTE

- You can select whether to rotate the image automatically in the default settings.
- ➔ [Auto Image Rotation \(8-17\)](#)
- When you have enabled this function, you can select how the images are rotated.
- ➔ [Auto Image Rotation Action \(8-24\)](#)



# [Job Finish Notice]



Sends E-mail notice when a job is complete. It is also available that send a notice when a job is interrupted.

Users can be notified of the completion of a job while working at a remote desk, saving the time spent waiting beside the machine to finish.



## NOTE

PC should be configured in advance so that E-mail can be used. To configure the settings, refer to the following:

➔ [Command Center RX \(2-42\)](#)

E-mail can be sent to a single destination.

Item	Description
<b>Off</b>	Disables the function.
<b>Job Finished Only</b>	To add a new destination, select [Menu] > [Add].
<b>Job Finished + Job Interrupted</b>	Address Book: Select the notification destination from the address book and select [OK]. Ext. Address Book <sup>*1</sup> : Select the notification destination from the external address book. Address Entry: Enter the e-mail address directly. Enter the address (up to 128 characters) and select [OK]. My Address <sup>*2</sup> : Uses the e-mail address of the logged in user.

\*1 External address book settings can be configured with Command Center RX.

➔ [Command Center RX User Guide](#)

\*2 Displayed when user login administration is enabled.

➔ [Setting User Login Administration \(9-6\)](#)



## NOTE

- To edit a destination, selecting [Menu] > [Edit], and then select the desired destination.
- Selecting [ ] shows detailed information about the destination.
- Select [ ] to delete a destination.

## [File Name Entry]



Adds a file name.

Additional information such as job number and date and time can also be set. You can check a job history or job status using the file name, date and time, or job number specified here.

Enter the file name and select [OK].

Maximum number of characters: Up to 32

To add date and time, select [Date and Time]. To add job number, select [Job No.]. The added information will be displayed in "Additional Info".

## [Priority Override]

Copy

Custom  
Box

USB  
Memory

Suspends the current job and gives a new job top priority.

The suspended job resumes after the other job is finished.

(Value: [Off] / [On])



### NOTE

- This function is not available if current job was an override.
- Priority override may not be available depending on the status of the current print job and memory usage. In this case, try the interrupt copy.

▶ [Interrupt Copy \(5-13\)](#)

# [Skip Blank Page]



When there are blank pages in a scanned document, this function skips the blank pages and scans only pages that are not blank.

Blank pages can be set as pages that include ruled lines and a small number of characters.

The machine detects blank pages, saving unnecessary printing without the need to check for blank pages in the document.

Item		Description
<b>Off</b>		Everything, including blank pages, is scanned.
<b>Configure the settings.</b>	<b>Blank Pages + Ruled Lines</b>	Blank pages and pages that include ruled lines are judged to be blank pages.
	<b>Blank Pages Only</b>	Blank pages only are judged to be blank pages.
	<b>Blank Pages + Some Text</b>	Blank pages and pages that include a small amount of text are judged to be blank pages.



## NOTE

The originals with punched holes or originals printed on a colored substrate may not be recognized as blank pages.

# [2-sided/Book Original]



Select the type and binding of originals.

Setting Items		Available settings	Description
<b>1-sided</b>		—	2-sided/Book Original is not set.
<b>2-sided</b>	<b>Binding</b>	Binding Left/Right, Binding Top	Select the binding orientation of originals.
	<b>Original Orientation</b>	Top Edge on Top, Top Edge on Left	Select the orientation of the original document top edge to scan correct direction. Select [Original Orientation] to choose orientation of the originals, either [Top Edge on Top] or [Top Edge on Left]. Then select [OK].
<b>Book<sup>*1</sup></b>	<b>Binding</b>	Binding Left, Binding Right	Select the binding orientation of originals.
<b>Others</b>	<b>2-sided/Book Original</b>	1-sided	Select this setting for a one-sided sheet original.
		2-sided (Binding Left/Right)	Select this setting for a two-sided sheet original with left or right binding.
		2-sided (Binding Top)	Select this setting for a two-sided sheet original with top binding.
		Book (Binding Left)	Select this setting for book type (magazine, book, etc.) with left binding.
		Book (Binding Right)	Select this setting for book type (magazine, book, etc.) with right binding.
	<b>Original Orientation<sup>*2</sup></b>	Top Edge on Top, Top Edge on Left	Select the orientation of the original document top edge to scan correct direction.

\*1 Original Orientation set to [Top Edge on Top].

\*2 Displayed when [2-sided (Binding Left/Right)] or [2-sided (Binding Top)] is selected in "Duplex".

## [Sending Size]



Select size of image to be sent.

Select [Same as Original Size], [Metric], [Inch], or [Others] to select the sending size.

Item	Value	Description
<b>Same as Original Size</b>	---	Automatically sends the same size as the original.
<b>Inch</b>	Ledger, Letter, Legal, Statement, 11x15", Oficio II	Select from the Inch series standard sizes.
<b>Metric</b>	A3, A4, A5, A6, B4, B5, B6, Folio, 216 × 340 mm	Select from the Metric series standard sizes.
<b>Others</b>	8K, 16K, Hagaki (Cardstock), Oufukuhagaki (Return postcard)	Select from special standard sizes.

### Relationship between Original Size, Sending Size, and Zoom

Original Size, Sending Size, and Zoom are related to each other. For details, see the table below.

Original size and sending size are	the same	different
<a href="#">[Original Size] (6-4)</a>	Specify as necessary.	Specify as necessary.
<b>Sending Size</b>	Select [Same as Original].	Select the desired size.
<a href="#">[Zoom] (6-27)</a>	Select [100%] (or [Auto]).	Select [Auto].



#### NOTE

When you specify the sending size that is different from the original size, and select the zoom of [100%], you can send the image as the actual size (No Zoom).

## [File Format]



Specify the image file format.

Select the file format from [PDF], [TIFF], [JPEG], [XPS], [OpenXPS], and [High Comp. PDF].

When the optional OCR Scan Activation Kit is installed, you can also select [Word], [Excel], or [PowerPoint].

Image quality level can also be adjusted.

Select [File Format] > [Others] > [Image Quality].

When the color mode in scanning has been selected for Grayscale or Full Color, set the image quality.

If you selected [PDF] or [High Comp. PDF], you can specify encryption or PDF/A settings.

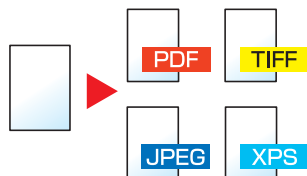

Item		Available settings	Description
<b>High Comp. PDF</b>		—	Performs processing using High-Compression PDF format.
<b>TIFF</b>		—	Performs processing using TIFF format.
<b>PDF</b>		—	Performs processing using PDF format.
<b>JPEG</b>		—	Performs processing using JPEG format. One file is created per original page.
<b>XPS</b>		—	Performs processing using XPS format.
<b>OpenXPS</b>		—	Performs processing using OpenXPS format.
<b>Word<sup>*1</sup></b>		—	Set the file format selected.
<b>Excel<sup>*1</sup></b>		—	
<b>PowerPoint<sup>*1</sup></b>		—	
<b>Others</b>	<b>File Format</b>	High Comp. PDF, TIFF, JPEG, XPS, OpenXPS	Select the image file format.
	<b>Image Quality<sup>*2</sup></b>	Compression Ratio Priority, Standard, Quality Priority	Set the image quality.
	<b>Image Quality<sup>*3</sup></b>	1 Low Quality (High Comp.) to 5 High Quality (Low Comp.)	Set the image quality.
	<b>PDF/A</b>	Off, PDF/A-1a, PDF/A-1b, PDF/A-2a, PDF/A-2b, PDF/A-2u	Set PDF/A format type.
	<b>Encrypt<sup>*4</sup></b>	Acrobat 3.0 and later, Encryption Level: Middle (40-bit) Acrobat 5.0 and later, Encryption Level: High (128-bit)	This configures the encryption setting.
<b>OCR Text Recognition<sup>*1</sup></b>		Off, On	Set the default OCR Text Recognition. ▶ <a href="#">OCR Text Recognition (Option) (6-44)</a>
<b>OCR Output Format<sup>*5</sup></b>		Text + Graphics, Text + Graphics with Scanned Image, Scanned Image with Searchable Text	Set the default OCR Output Format.

\*1 Displayed only when the optional Scan extension kit is installed.

\*2 Displayed when [High Comp. PDF] is selected for “File Format”.

\*3 Displayed when the option other than [High Comp. PDF] is selected for “File Format”.

\*4 Encryption settings can be configured. For details, refer to the information below.

\*5 Displayed when [Word], [Excel] or [PowerPoint] is selected for “File Format”.

## PDF Encryption Functions

If you have selected PDF or High Comp. PDF for file format, you can restrict the access level for displaying, printing, and editing PDF's by assigning a secure password.



- 1 Select [Others] from the item.
- 2 Select [High Comp. PDF] or [PDF] in [File Format].
- 3 [Encryption] > [Compatibility] > Select a setting.

Setting items depend on the selected [Compatibility] setting.

**When [Acrobat 3.0 and higher, Encryption Level: Middle (40-bit)] is selected**

Item	Available settings	Description
<b>Password to Open Document</b>	Off, On	Enter the password to open the PDF file. Select [On], enter a password (up to 256 characters) and then select [Next]. Enter the password again for confirmation, and select [OK].
<b>Password to Edit/Print Document</b>	Off, On	Enter the password to edit the PDF file. Select [On], enter a password (up to 256 characters) and then select [Next]. Enter the password again for confirmation, and select [OK]. When you have entered the password and selected [Detail] to edit/print document, you can specifically limit the operation.
<b>Printing Allowed</b>	Not Allowed, Allowed	Restricts printing of the PDF file.
<b>Changes Allowed</b>	Not Allowed	Disables the change to the PDF file.
	Commenting	Can only add commenting.
	Page Layout except extracting Pages	Can change the page layout except extracting the pages of the PDF file.
	Any except extracting Pages	Can conduct all operations except extracting the pages of the PDF file.
<b>Copying of Text/Images/Others</b>	Disable, Enable	Restricts the copying of text and objects on the PDF file.

**When [Acrobat 5.0 and later, Encryption Level: High (128-bit)] is selected**

Item	Available settings	Description
<b>Password to Open Document</b>	Off, On	Enter the password to open the PDF file. Select [On], enter a password (up to 256 characters) and then select [Next]. Enter the password again for confirmation, and select [OK].
<b>Password to Edit/Print Document</b>	Off, On	Enter the password to edit the PDF file. Select [On], enter a password (up to 256 characters) and then select [Next]. Enter the password again for confirmation, and select [OK]. When you have entered the password to edit/print document, you can specifically limit the operation.

Item	Available settings	Description
<b>Printing Allowed</b>	Not Allowed	Disables the printing of PDF file.
	Allowed (Low Resolution only)	Can print the PDF file only in low resolution.
	Allowed	Can print the PDF file in original resolution.
<b>Changes Allowed</b>	Not Allowed	Disables the change to the PDF file.
	Inserting/Deleting/Rotating Pages	Can only insert, delete, and rotate the pages of the PDF file.
	Commenting	Can only add commenting.
	Any except extracting Pages	Can conduct all operations except extracting the pages of the PDF file.
<b>Copying of Text/ Images/Others</b>	Disable, Enable	Restricts the copying of text and objects on the PDF file.

**OCR Text Recognition (Option)**

When [PDF], [High Comp. PDF], [Word], [Excel], or [PowerPoint] is selected for the file format, you can create Searchable file by running OCR on the scanned document. Select [OCR Text Recognition], and then [On], select the language of the document, and select [OK].

Item	Description
Off	Do not create Searchable file.
On	Create Searchable file. Select the language to extract from the languages that appear on the touch panel.

**NOTE**

- This function can only be used when the optional OCR Scan Activation Kit is installed.
- ▶ [Scan extension kit\(A\) <OCR Scan Activation Kit> \(12-10\)](#)
- If the proper language is not selected, file creation may take a long time or the creation may fail. The default language can be changed in System Menu.
- ▶ [Primary OCR Language<sup>\\*2</sup> \(8-18\)](#)
- If you do not set an original in the correct orientation, the text of the document may not be recognized as characters. In addition, it may take some time to create the file. The original orientation is correct.
- The accuracy of the text recognition depends on the original condition. The following condition may result in decreasing the recognition accuracy.
  - Repeatedly copied documents (as copied copy)
  - Received faxes (with low resolution)
  - Originals with the character space too narrow or wide
  - Originals with the lines on the text
  - Originals with the special fonts
  - Binding part of the book
  - A handwritten texts

## [File Separation]



Creates several files by dividing scanned original data page by page, and sends the files.

(Value: [Off] / [Each Page])

Select [Each Page] to set File Separation.

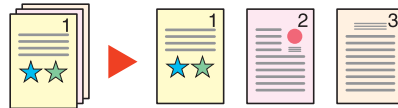

### NOTE

A three-digit serial number such as "abc\_001.pdf, abc\_002.pdf..." is attached to the end of the file name.

# [Scan Resolution]



Select fineness of scanning resolution.

(Value: [600 × 600 dpi] / [400 × 400 dpi Ultra] / [300 × 300 dpi] / [200 × 400 dpi Super] / [200 × 200 dpi Fine] / [200 × 100 dpi Normal])

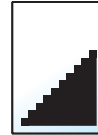
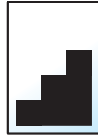

## NOTE

The larger the number, the better the image resolution. However, better resolution also means larger file sizes and longer send times.

## [E-mail Subject/Body]

Send

Custom  
Box

Adds subject and body when sending a document.

Select [Subject] / [Body] to enter the E-mail subject/body.

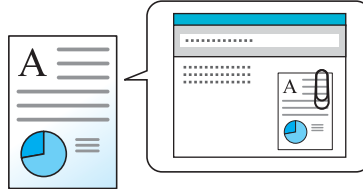

### NOTE

- The maximum number of characters that can be entered are as shown below.  
Subject: 60 characters  
Body: 500 characters

## [FTP Encrypted TX]



Encrypts images when sending via FTP.

Encryption secures the document transmission.

(Value: [Off] / [On])



### NOTE

Click [Security Settings], and then [Network Security] in the Command Center RX. Be sure that "SSL" of Secure Protocol Settings is "On" and one or more effective encryption are selected in Client side settings.

➔ [Command Center RX User Guide](#)

## [Delete after Printed]



Automatically delete a document from the box once printing is complete.

Value: [Off] / [On]



## [Delete after Transmitted]



Automatically deletes a document from the box once transmission is complete.

Value: [Off] / [On]

# [Storing Size]



Select size of image to be stored.

Select [Same as Original Size], [Metric], [Inch], or [Others] to select the storing size.

Item	Value	Description
<b>Same as Original Size</b>	---	Store an image the same size as the original.
<b>Inch</b>	Ledger, Letter, Legal, Statement, 11x15", Oficio II	Select from the Inch series standard sizes.
<b>Metric</b>	A3, A4, A5, A6, B4, B5, B6, Folio, 216 × 340 mm	Select from the Metric series standard sizes.
<b>Others</b>	8K, 16K, Hagaki (Cardstock), Oufukuhagaki (Return postcard)	Select from special standard sizes.

## Relationship between Original Size, Storing Size, and Zoom

Original Size, Storing Size, and Zoom are related to each other. For details, see the table below.

Original size and sending size are	the same	different
<a href="#">[Original Size] (6-4)</a>	Specify as necessary.	Specify as necessary.
<b>Sending Size</b>	Select [Same as Original].	Select the desired size.
<a href="#">[Zoom] (6-27)</a>	Select [100%] (or [Auto]).	Select [Auto].



### NOTE

When you select Storing Size that is different from Original Size, and select the Zoom [100%], you can store the image as the actual size (No Zoom).

## [Long Original]



Reads long-sized original documents using a document processor.

(Value: [Off] / [On])



### NOTE

- Long originals are sent in black and white or Grayscale.
- Only a single side of a long original cannot Originals of up to 1,900 mm / 74.8<sup>\*1</sup> long can be scanned.
- You can select resolution 300×300 dpi or less.

\*1 1,600 mm/63" if fax functions are used.

## [Encrypted PDF Password]



Enter the preassigned password to print the PDF data.

Enter the Password, and select [OK].



### NOTE

For details on entering the password, refer to the following:

➔ [Character Entry Method \(12-13\)](#)

## [JPEG/TIFF Print]



Select the image size when printing JPEG or TIFF files.

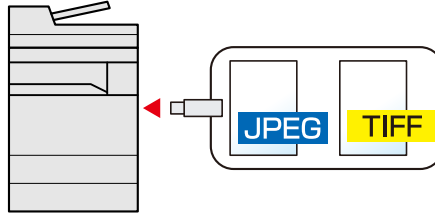

Item	Description
<b>Paper Size</b>	Fits the image size to the selected paper size.
<b>Image Resolution</b>	Prints at resolution of the actual image.
<b>Print Resolution</b>	Fits the image size to the print resolution.

## [XPS Fit to Page]



Reduces or enlarges the image size to fit to the selected paper size when printing XPS file.

(Value: [Off] / [On])

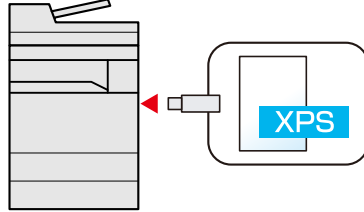

## [Erase Shadowed Areas]



When scanning with the document processor open, erase the extra shaded area.

Value: [Off] / [On]

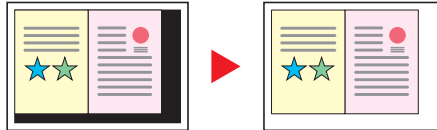

# 7 Managing Jobs, Consumables, and Devices

This chapter explains the following topics:

Checking a Job Status .....	7-2
Available Status Screens .....	7-2
Displaying the Status Screen .....	7-2
Status Display .....	7-3
Print Job Status Screen .....	7-3
Send Job Status Screen .....	7-4
Store Job Status Screen .....	7-5
Scheduled Job Status Screen .....	7-5
Checking Detailed Information of Jobs .....	7-6
Checking Job Histories .....	7-7
Available Job History Screens .....	7-7
Displaying the Job History Screen .....	7-7
Checking the Detailed Information of Histories .....	7-8
Sending the Log History .....	7-8
Job Operation .....	7-9
Pausing and Resuming a Job .....	7-9
Canceling a Job .....	7-9
Device/Communication .....	7-10
Checking the Remaining Amount of Toner and Paper (Paper/Supplies) .....	7-12



# Checking a Job Status

Check the status of jobs being processed or waiting to be printed.

## Available Status Screens

The processing and waiting statuses of jobs are displayed as a list on the touch panel in four different screens - Printing Jobs, Sending Jobs, Storing Jobs, and Scheduled Jobs. The following job statuses are available.

Status Display	Job status to be displayed
Print Job Status	<ul style="list-style-type: none"> <li>• Copy job</li> <li>• Printer job</li> <li>• FAX reception</li> <li>• E-mail reception</li> <li>• Job from Document Box</li> <li>• Data from removable memory</li> <li>• Application</li> <li>• Report/List</li> </ul>
Send Job Status	<ul style="list-style-type: none"> <li>• Fax transmission</li> <li>• Send as E-mail</li> <li>• Folder</li> <li>• Sending Job Application</li> <li>• Multi Sending</li> <li>• Sending Job - FAX Server</li> </ul>
Store Job Status	<ul style="list-style-type: none"> <li>• Storing Job Scan</li> <li>• Storing Job FAX</li> <li>• Storing Job Printer</li> </ul>
Scheduled Job	<ul style="list-style-type: none"> <li>• Fax transmission</li> </ul>

## Displaying the Status Screen

### 1 Display a screen.

Select the [Status/Job Cancel] key.

### 2 Select the job to check details.

Select either of [Print Job Status], [Send Job Status], [Store Job Status] or [Scheduled Job] to check the status.

➔ [Print Job Status Screen \(7-3\)](#)

➔ [Send Job Status Screen \(7-4\)](#)

➔ [Store Job Status Screen \(7-5\)](#)

➔ [Scheduled Job Status Screen \(7-5\)](#)

# Status Display

 **NOTE**

You can show the job statuses of all users, or only the statuses of your own jobs.







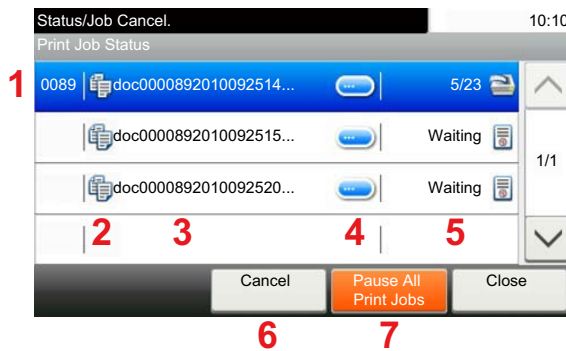

➔ [\[Display Status/Log\] \(8-21\)](#)

This setting can also be changed from Command Center RX.

➔ [Command Center RX User Guide](#)

## Print Job Status Screen



Number	Item	Description
1	Display/Key	Acceptance No. of job
2	Type	Icon indicates job type.  Copy job  Printer job  Job from Document Box  FAX reception  E-mail reception  Data from removable memory  Application  Report/List
3	Job name	Job name or file name
4	[  ]	Select the key of the job whose detailed information you want to display. ➔ <a href="#">Checking Detailed Information of Jobs 7-6</a>
5	Status	Status of job (Number of Sheets Printed)/(Total Number of Sheets): Printing Processing: The status before starting to print. Waiting: Print Waiting Pause: Pausing print job or error Canceling: Canceling the job
6	[Cancel]	Select the job you want to cancel from the list, and press this key.
7	[Pause All Print Jobs]	Pauses all the printing jobs. By pressing this key again, the printing jobs will be resumed.

## Send Job Status Screen

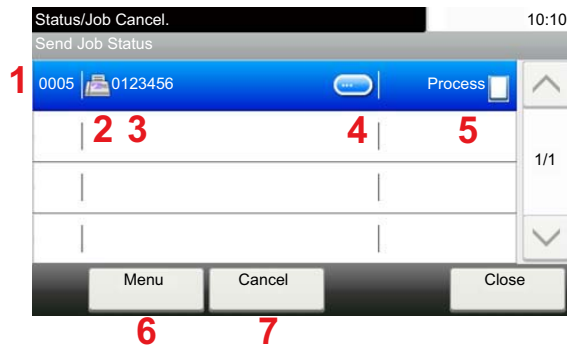

Number	Item	Description
1	Display/Key	Acceptance No. of job
2	Type	Icon indicates job type. Fax transmission Send as E-mail Folder (SMB/FTP) send Application send Multi Sending Sending Job - FAX Server
3	Job name	Job name or file name is displayed.
4	[  ]	Select the key of the job whose detailed information you want to display. <a href="#">▶ Checking Detailed Information of Jobs 7-6</a>
5	Status	Status of job InProcess: The status before starting sending such as during scanning originals Sending: Sending Waiting: Waiting Sending Canceling: Canceling the job Pause: Pausing the job
6	[Menu]	Selecting this key displays [Priority Override]. A fax job can be given send priority. Use the list to select the fax job to be sent immediately. > [Menu] > [Priority Override]
7	[Cancel]	Select the job you want to cancel from the list, and press this key.

## Store Job Status Screen

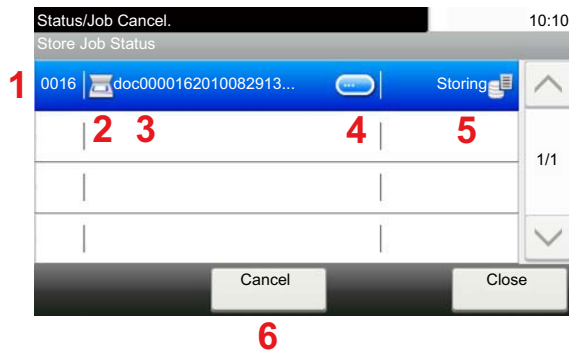

Number	Item	Description
1	Display/Key	Acceptance No. of job
2	Type	Icon indicates job type. Storing Job Scan Storing Job Printer Storing Job FAX
3	Job name	Job name or file name is displayed.
4	[]	Select the job whose detailed information you want to display from the list, and press this key. <a href="#">▶ Checking Detailed Information of Jobs (7-6)</a>
5	Status	Status of job InProcess: The status before starting to save such as during scanning originals Storing: Storing Data Canceling: Canceling the job Pause: Pausing the job
6	[Cancel]	Select the job you want to cancel from the list, and press this key.

## Scheduled Job Status Screen

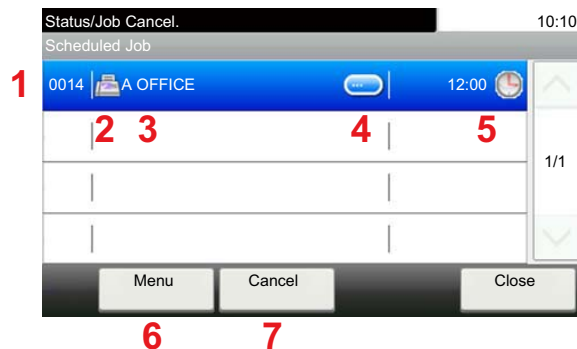

Number	Item	Description
1	Display/Key	Acceptance No. of job
2	Type	Icon indicates job type. Scheduling Job FAX

Number	Item	Description
3	Destination	Destination (Either destination name, FAX number, or No. of broadcast items)
4	[  ]	Select the job whose detailed information you want to display from the list, and press this key. ➔ <a href="#">Checking Detailed Information of Jobs (7-6)</a>
5	Start Time	Time to start the scheduled job
6	[Menu]	Selecting this key displays [Start Now]. From the list, select the job you want to send immediately. > [Menu] > [Start Now]
7	[Cancel]	Select the job you want to cancel from the list, and press this key.

## Checking Detailed Information of Jobs

Check the detailed information of each job.

### NOTE

A user logged in with user privileges will be able to check only the jobs of the logged in user. A user logged in with administrator privileges can check all jobs.

### 1 Display the screen.

➔ [Checking a Job Status \(7-2\)](#)

### 2 Check the information.

1 Select [] for the job whose detailed information you want to check.

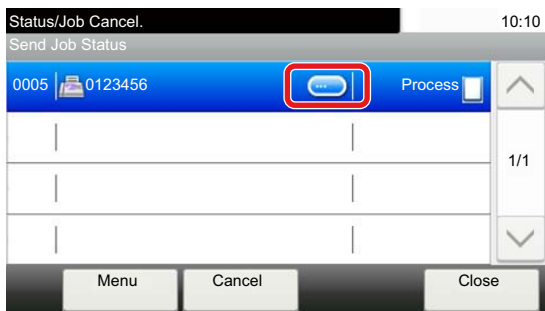

Detailed information of the selected job is displayed.

Click the [OK] button. Select [∨] or [∧] to view information on the next page or previous page. To view more detailed information, select a white item.

In Sending Jobs, you can check the destination by selecting [Status/Destination].

2 To exit from the detailed information, select [Close].

# Checking Job Histories

Check the history of completed jobs.



**NOTE**

- Job history can also be checked from a computer using Command Center RX or KYOCERA Net Viewer
  - ➔ Command Center RX
  - ➔ KYOCERA Net Viewer User Guide
- You can show the job log of all users, or only your own job log.
  - ➔ [\[Display Status/Log\] \(8-21\)](#)

This setting can also be changed from Command Center RX.

- ➔ Command Center RX User Guide

## Available Job History Screens

The job histories are displayed separately in four screens - Printing Jobs, Sending Jobs, Storing Jobs, and FAX Jobs.

The following job histories are available.

Screen	Job histories to be displayed
Printing Jobs	<ul style="list-style-type: none"> <li>• Copy job</li> <li>• Printer job</li> <li>• FAX reception</li> <li>• E-mail reception</li> <li>• Job from Document Box</li> <li>• Report/List</li> <li>• Data from removable memory</li> <li>• Application</li> </ul>
Sending Jobs	<ul style="list-style-type: none"> <li>• Fax transmission</li> <li>• Send as E-mail</li> <li>• Folder</li> <li>• Sending Job Application</li> <li>• Multi Sending</li> <li>• Sending Job - FAX Server</li> </ul>
Storing Jobs	<ul style="list-style-type: none"> <li>• Storing Job Scan</li> <li>• Storing Job FAX</li> <li>• Storing Job Printer</li> </ul>
FAX Job	<ul style="list-style-type: none"> <li>➔ FAX Operation Guide</li> </ul>

## Displaying the Job History Screen

**1 Display the screen.**

Select the [Status/Job Cancel] key.

## 2 Select the job to check details.

# Checking the Detailed Information of Histories

You can check the detailed information of each job.

### 1 Display the screen.

Select the [Status/Job Cancel] key.

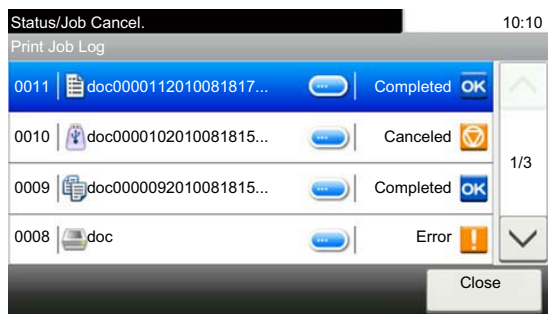

### 2 Check the information.

1 Select [] of the job you want to check > [Detail].



Detailed information of the selected job is displayed.

#### NOTE

Select [] or [] to view information on the next page or previous page.

2 To exit from the detailed information, select [Close].

## Sending the Log History

You can send the log history by E-mail. You can either send it manually as needed or have it sent automatically whenever a set number of jobs is reached.

➔ [\[Sending Log History\] \(8-7\)](#)

# Job Operation

## Pausing and Resuming a Job

Pause/resume all printing jobs in printing/waiting.

- 1 Display the screen.**  
Select the [Status/Job Cancel] key.
- 2 Select [Pause All Print Jobs] on the printing jobs status screen.**  
Printing is paused.  
When resuming the printing of jobs that have been paused, select [Resume All Print Jobs].

## Canceling a Job

A job in printing/waiting status can be canceled.

- 1 Display the screen.**  
Select the [Status/Job Cancel] key.
- 2 Select the job to be canceled from the list, and select [Cancel].**
- 3 Select [Yes] in the confirmation screen.**



# Device/Communication

Configure the devices/lines installed or connected to this machine or check their status.

## 1 Display the screen.

- 1 Select the [Status/Job Cancel] key.
- 2 Select the item you want to check.

The screen to check the status or configure the devices is displayed.

## 2 Check the status.

The items you can check are described below.

### Scanner

The status of an original scanning or the error information (paper jam, opened cover, etc.) is displayed.

### Printer

Error information such as paper jam, out of toner, or out of paper, and status such as waiting or printing are displayed.

### FAX Memory RX Box

➔ FAX Operation Guide

This displays information (document name, file size, etc.) about a document in the FAX Memory RX Box.

➔ **Command Center RX User Guide**

### FAX

- To cancel a fax that is currently being sent/received, select [Line Off].
- The information such as sending/receiving and dialing is displayed.

➔ FAX Operation Guide

### “Removable Memory”

- The usage, capacity and free space of the external media connected to this machine are displayed.
- To format external media, select [Menu] > [Format].

### **IMPORTANT**

**When [Format] is selected, all data in the external media is erased.**

- To safely remove the external media, select [Remove Memory].

**USB Keyboard**

The status of the optional USB Keyboard is displayed.

**Bluetooth Keyboard**

Shows the status of the Bluetooth Keyboard.

**Network Connection Status**

The network connection status appears.

**Option Network Connection Status**

The connection status of an optional network interface kit appears.

**Wi-Fi Direct**

Shows the connection status of Wi-Fi Direct.

**Wireless Network**

The connection status of the Wireless Network Interface Kit is displayed.

**Wi-Fi**

Shows the connection status of Wi-Fi.

**SSD**

The status of the SSD is displayed.

**NFC**

Shows the connection status of NFC.

# Checking the Remaining Amount of Toner and Paper (Paper/Supplies)

Check the remaining amount of toner, and paper on the touch panel.

## 1 Display the screen.

- 1 Select the [Status/Job Cancel] key.
- 2 Select the item you want to check.

## 2 Check the status.

The items you can check are described below.

### **Toner Status**

The amount of toner remaining is shown in levels. And you can check the status of waste toner box.

### **Paper Status**

You can check the size, orientation, type, and remaining amount of paper in each paper source. The amount of paper remaining is shown in levels.

### **Staple**

Can be used to check whether or not there are staples.

# 8 System Menu

This chapter explains the following topics:

Operation Method .....	8-2
[Quick Setup Wizard] .....	8-3
[Language] .....	8-4
[Report] .....	8-5
[Counter] .....	8-8
[Cassette/MP Tray Settings] .....	8-9
[Common Settings] .....	8-11
[Home] .....	8-23
[Copy] .....	8-24
[Send] .....	8-25
[Document Box] .....	8-26
[FAX] .....	8-27
[Application] .....	8-28
[Internet] .....	8-29
[Address Book/One Touch] .....	8-30
[User Login/Job Accounting] .....	8-31
[Printer] .....	8-32
[System/Network] .....	8-35
[Date/Timer/Energy Saver] .....	8-60
[Adjustment/Maintenance] .....	8-63

# Operation Method

Configure settings related to overall machine operation. Change the factory default settings in accordance with usage needs.

## 1 Display the screen.

Select the [System Menu / Counter] key.

## 2 Select a function.

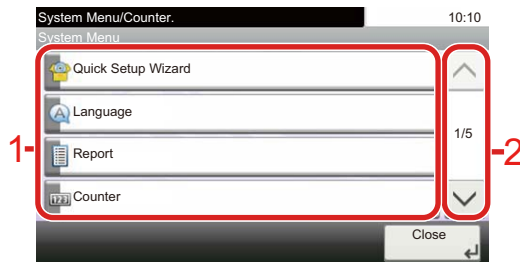

- 1 Displays the System Menu items.
- 2 Scrolls up and down when the list of values cannot be displayed in its entirety on a single screen.
- 3 Displays setting items.  
Select the key of a function to display the setting screen.
- 4 Returns to the previous screen.

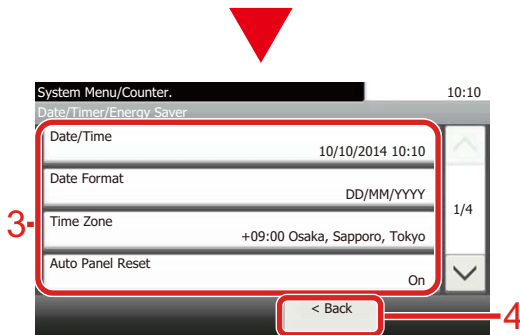

## 3 Configure the function.

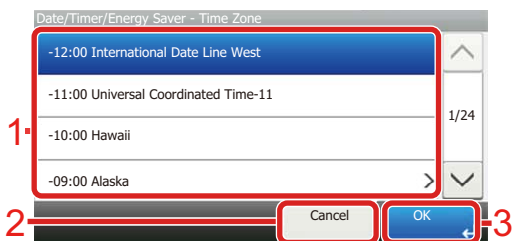

- 1 Enter a setting by selecting it.
- 2 Returns to the previous screen without making any changes.
- 3 Accepts the settings and exits.

### NOTE

- If the login user name entry screen appears during operations, log in by referring to the machine's Operation Guide for Administrator User Name and Password.  
The factory default login user name and login password are set as shown below.  
Login User Name:  
ECOSYS M8124cidn:2400, ECOSYS M8130cidn:3000  
Login Password:  
ECOSYS M8124cidn:2400, ECOSYS M8130cidn:3000
- If function default settings have been changed, the [Reset] key can be selected in each function screen to immediately change the settings.

Refer to System Menu Settings on the following page and configure as needed.

## [Quick Setup Wizard]

For FAX functions, Energy Saver functions and network settings, the following settings can be configured in a wizard-style screen.

➔ [Quick Setup Wizard \(2-25\)](#)

The following settings can be configured in a wizard-style screen.

Function	Item	Description
<b>FAX Setup</b>	Configures basic fax settings. FAX functions are available only on products with the fax function installed. ➔ FAX Operation Guide	
<b>Energy Saver Setup</b>	1. Sleep Mode	Sleep Timer Sleep Level (models except for Europe)
	2. Low Power Mode	Low Power Timer
<b>Network Setup</b>	1. Network	Wi-Fi Wired Network DHCP <sup>*1</sup> IP Address <sup>*2</sup> Subnet Mask <sup>*2</sup> Default Gateway <sup>*2</sup>

\*1 This function is displayed when [Network Selection] is set to [Wired Network].

\*2 This function is not displayed when [Off] is selected for the DHCP setting.



### NOTE

If the user authentication screen appears, enter your login user name and login password and select [Login].

The factory default login user name and login password are set as shown below.

Login User Name

ECOSYS M8124cidn:2400, ECOSYS M8130cidn:3000

Login Password

ECOSYS M8124cidn:2400, ECOSYS M8130cidn:3000

## [Language]

Menu Transition: [System Menu / Counter] key > [Language]

Set the language to be displayed on the machine screen.

Item	Description
Language	Set the language to use for the touch panel display.

# [Report]



Print reports to check the machine settings, status, and history. Settings for printing reports can also be configured.

## [Print Report]

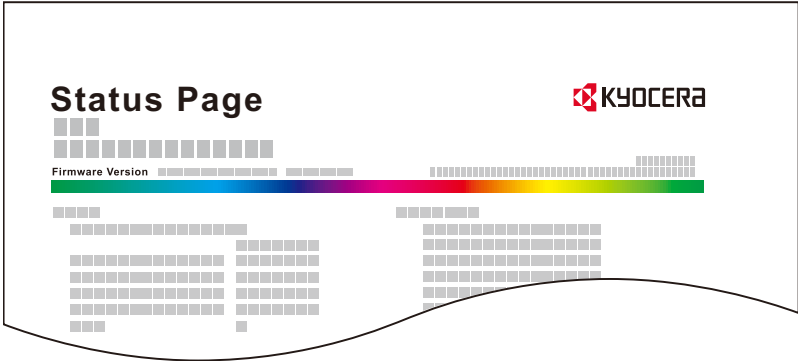
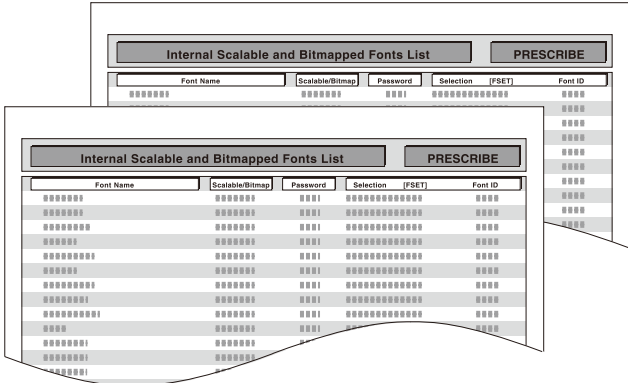
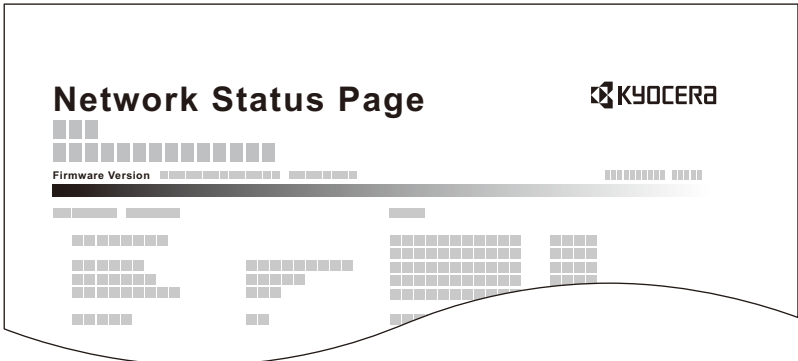
Menu Transition: [System Menu/Counter] key > [Report] > [Print Report]

Item	Description
<p><b>Status Page</b></p>	<p>Prints the status page, allowing you to check the information including current settings, available memory space, and optional equipment installed.</p> 
<p><b>Font List</b></p>	<p>Prints the font list, allowing you to check the font samples installed in the machine.</p> 
<p><b>Network Status</b></p>	<p>Prints the network status, allowing you to check the information including network interface firmware version, network address and protocol.</p> 
<p><b>Service Status</b></p>	<p>Prints the service status. More detailed information is available than on the Status Page. Service personnel usually print the service status pages for maintenance purpose.</p>
<p><b>Accounting Report</b></p>	<p>Print Accounting Report. Allowing you to check the accounts that have been registered on the machine.</p>



Item	Description
Sub Address Box List	This prints a report for fax functions. <a href="#">▶ FAX Operation Guide</a>  <b>NOTE</b> This function is displayed only on products with the fax function installed.
FAX List (Index)	
FAX List (No.)	
Outgoing FAX Report	
Incoming FAX Report	
Optional Network Status	Prints the optional network status, allowing you to check the information including optional network interface firmware version, network address and protocol.  <b>NOTE</b> This function is displayed when the optional Network Interface Kit or Wireless Network Interface Kit is installed.

### [Admin Report Settings]

Menu Transition: [System Menu / Counter] key > [Report] > [Admin Report Settings]

This specifies whether an Outgoing FAX Report or Incoming FAX Report should be printed automatically.

[▶ FAX Operation Guide](#)

### [Result Report Setting]

Menu Transition: [System Menu / Counter] key > [Report] > [Result Report Setting]

Item	Description
Send Result Report	Automatically print a report of transmission result when a transmission is complete.
E-mail/Folder	Automatically print a report of transmission result when E-mail or SMB/FTP transmission is complete. Value: Off, On, Error Only
FAX <sup>*1</sup>	<a href="#">▶ FAX Operation Guide</a>
Attach Image of Network FAX	Select the attached image form Body and Cover Page when sending the Network FAX. Value: Body Text, Cover Page
Canceled before Sending <sup>*2</sup>	Print a send result report if the job is canceled before being sent. Value: Off, On
Recipient Format <sup>*2</sup>	Select the Recipient Format for the send result report. Value: Name or Destination, Name and Destination
RX Result Report <sup>*1</sup>	<a href="#">▶ FAX Operation Guide</a>
Job Finish Notice Setting <sup>*1</sup>	<a href="#">▶ FAX Operation Guide</a>

\*1 Displayed only when the optional fax function is installed.

\*2 This does not appear when both [E-mail/Folder] and [FAX] are set to [Off].

**[Sending Log History]**

Menu Transition: [System Menu / Counter] key &gt; [Report] &gt; [Sending Log History]

Item	Description
<b>Sending Log History</b>	You can also send the log history to the specified destinations manually.
<b>Auto Sending</b>	<p>This function automatically sends the log history to the specified destinations whenever a set number of jobs has been logged.</p> <p>Value: Off, On</p> <p> <b>NOTE</b></p> <p>If [On] is selected, specify the number of job histories to be automatically sent. The setting range is 1 to 16.</p>
<b>Destination</b>	This specifies the destination to which log histories are sent. Only E-mail address can be set.
<b>Job Log Subject</b>	<p>Set the subject automatically entered when sending log histories by E-mail.</p> <p>Value: Up to 60 characters</p>
<b>Personal Information</b>	<p>Select whether to include personal information in the job log.</p> <p>Value: Include, Exclude</p>

## [Counter]

### Check the number of sheets printed and scanned.

- 1 Display the screen.  
[System Menu / Counter] key > [Counter]
- 2 Select [Printed Pages] > [Scanned Pages] to check the counter.

### Refer to the printed coverage.

- 1 Check the screen.  
[System Menu / Counter] key > [Counter] > [Printed Pages] > [Print Coverage]
- 2 The selected [Last Page] or [Last Job] data is displayed.  
[Last Page]: The data of the last printed page is displayed.  
[Last Job]: The data of the last printed job is displayed.



#### NOTE

The printing volume as calculated from information indicated on print coverage data will not match on actual printed volume. The actual printing volume varies depending on the usage (printing content, continuous printing frequency, etc.) and environmental factors (temperature and humidity).

## [Cassette/MP Tray Settings]

Select paper size and media type for Cassette and multi purpose tray.

### [Cassette 1 (to 3)]

[System Menu / Counter] key > [Cassette/MP Tray Settings] > [Cassette 1 (to 3)]

Select paper size and media type for Cassettes 1 to 3.

Selection Item		Selectable Size/Type
PaperSize	Auto	Paper size is automatically detected and selected. <b>Values:</b> Metric, Inch
	Metric	Available options are as follows: <b>Values</b> A3, A4-R, A4, A5-R, B4, B5-R, B5, Folio, 216 x 340 mm
	inch	Available options are as follows: <b>Values</b> Ledger, Letter-R, Letter, Legal, Statement-R, Oficio II
	Others	Select from special standard sizes. <b>Values</b> 8K, 16K-R, 16K
Media Type* <sup>1</sup>		Select the media type. <b>Values:</b> Plain (60 - 105 g/m <sup>2</sup> ), Rough, Vellum (59 g/m <sup>2</sup> or less), Recycled, Preprinted* <sup>2</sup> , Bond, Color, Prepunched* <sup>2</sup> , Letterhead* <sup>2</sup> , Thick (106 - 256 g/m <sup>2</sup> ), High Quality, Custom 1 - 8

\*1 To change to the media type from "Plain" to something else, refer to the information below.

➔ [Media Type Setting \(8-14\)](#)

\*2 To print on preprinted or prepunched paper or on letterhead, refer to the information below.

➔ [Special Paper Action \(8-14\)](#)



#### NOTE

If the optional FAX Kit is installed, the available media types for printing received faxes are as shown below.

Plain, Vellum, Recycled, Bond, Color, Thick, High Quality, Custom1 - 8

**[Multi Purpose Tray]**

[System Menu / Counter] key &gt; [Cassette/MP Tray Settings] &gt; [Multipurpose Tray]

Select paper size and media type for the multi purpose tray.

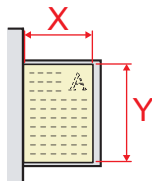
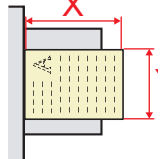
Item		Description
Paper Size	Inch	Available options are as follows: <a href="#">Values</a> Ledger, Letter-R, Letter, Legal, Statement-R, Executive, Oficio II
	Metric	Available options are as follows: <a href="#">Values</a> A3, A4-R, A4, A5-R, A6-R, B4, B5-R, B5, B6-R, Folio, 216 x 340 mm
	Others	Select from special standard sizes and custom sizes. <a href="#">Values</a> 8K, 16K-R, 16K, ISO B5, Envelope #10, Envelope #9, Envelope #6, Envelope Monarch, Envelope DL, Envelope C5, Envelope C4, Hagaki (Cardstock), Oufuku hagaki (Return postcard), Youkei 4, Youkei 2, Custom
	Size Entry	Enter the size not included in the standard size. <a href="#">Values</a> Metric X: 148 to 432 mm (in 1mm increments) Y: 98 to 297 mm (in 1mm increments) Inch X: 5.83 to 17.00" (in 0.01" increments) Y: 3.86 to 11.69" (in 0.01" increments) X=Length, Y=Width  <div style="display: flex; justify-content: space-around; align-items: center;"> <div style="text-align: center;"> <p>Vertical</p>  </div> <div style="text-align: center;"> <p>Horizontal</p>  </div> </div>
Media Type <sup>*1</sup>	Select the media type. <a href="#">Values</a> Plain (60 to 105 g/m <sup>2</sup> ), Transparency, Rough, Vellum (59 g/m <sup>2</sup> or less), Labels, Recycled, Preprinted <sup>*2</sup> , Bond, Cardstock, Color, Prepunched <sup>*2</sup> , Letterhead <sup>*2</sup> , Envelope, Thick (106 g/m <sup>2</sup> or more), Coated, High Quality, Custom 1-8	

\*1 To change to a media type other than "Plain".

➔ [Media Type Setting \(8-14\)](#)

\*2 To print on preprinted or prepunched paper or on letterhead, refer to the following:

➔ [Special Paper Action \(8-14\)](#)**NOTE**

If the optional FAX Kit is installed, faxes cannot be received in the multipurpose tray.

# [Common Settings]

Configures overall machine operation.

## [Default Screen]

Menu Transition: [System Menu / Counter] key > [Common Settings] > [Default Screen]

Item	Description
<b>Default Screen</b>	Select the screen appearing right after start-up (default screen). <b>Value:</b> Home, Copy, Send, FAX <sup>*1</sup> , Custom Box <sup>*2</sup> Job Box, Removable Memory, Sub Address Box <sup>*1</sup> , Polling Box <sup>*1</sup> , FAX Memory RX Box <sup>*1</sup> , Favorites <sup>*3</sup> , Status Check

\*1 Displayed only on products with the fax function installed.

\*2 Displayed when the product is equipped with an optional large capacity storage device (SSD).

\*3 Jobs registered in Favorites are displayed.

➔ [Recalling Frequently Used Functions \(Favorites\) \(3-41\)](#)

## [Sound]

Menu Transition: [System Menu / Counter] key > [Common Settings] > [Sound]



Item	Description
<b>Buzzer</b>	Set options for buzzer sound during the machine operations.
<b>Volume</b>	Set the buzzer volume level. <b>Value:</b> 0 (Mute), 1 (Minimum), 2, 3 (Medium), 4, 5 (Maximum)
<b>Key Confirmation</b>	Emit a sound when the operation panel and touch panel keys are selected, or when auto clear operates. <b>Value:</b> Off, On
<b>Job Finish</b>	Emit a sound when a job is normally completed. <b>Value:</b> OffOff, On, FAX Reception Only
<b>Ready</b>	Emit a sound when the warm-up is completed. <b>Value:</b> Off, On
<b>Warning</b>	Emit a sound when errors occur. <b>Value:</b> Off, On
<b>Key Confirmation (USB Keyboard)</b>	Emit a sound to confirm keypresses with a sound. <b>Value:</b> Off, On
<b>FAX Speaker Volume<sup>*1</sup></b>	➔ <a href="#">FAX Operation Guide</a>
<b>FAX Monitor Volume<sup>*1</sup></b>	

\*1 Displayed only on products with the fax function installed.

## [Original Settings]

Menu Transition: [System Menu / Counter] key > [Common Settings] > [Original Settings]

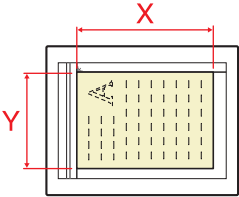
Configure settings for originals.

Item	Description
<p><b>Custom Original Size</b></p>	<p>Set up frequently-used custom original size.</p> <p>The custom size option is displayed on the screen to select original size.</p> <p>To register a custom paper size, select <b>[On]</b> and enter the desired size.</p> <p><b>Value</b></p> <p><b>Metric</b></p> <p>X: 50 to 432 mm (in 1 mm increments)</p> <p>Y: 50 to 297 mm (in 1 mm increments)</p> <p><b>Inch</b></p> <p>X: 2.00 to 17.00" (in 0.01" increments)</p> <p>Y: 2.00 to 11.69" (in 0.01" increments)</p> <p>X=Length, Y=Width</p> <div style="text-align: center;"> <p>Horizontal</p>  </div>
<p><b>Auto Detect Original Size</b></p>	<p>Automatically detect the original size. Select <b>[Metric]</b> when automatically detecting the originals in centimeter sizes. Select <b>[Inch]</b> when detecting the originals in inch sizes.</p> <p><b>Value:</b> Metric, Inch</p> <p><b>Metric</b></p> <p>A6 / Hagaki (Cardstock)</p> <p>As A6 and Hagaki (Cardstock) are similar in size, select either one of them for automatic detection.</p> <p><b>Value:</b> A6, Cardstock</p> <p> <b>NOTE</b></p> <p>If <b>[Cardstock]</b> is set, only the originals placed on the platen are detected.</p> <p><b>Folio</b></p> <p>Automatically detect the original size.</p> <p><b>Value:</b> Off, On</p> <p><b>11×15"</b></p> <p>Automatically detect the original size.</p> <p><b>Value:</b> Off, On</p> <p><b>Inch</b></p> <p>Legal/ Oficioll/ 216×340mm</p> <p>Automatically detect the original size.</p> <p><b>Value:</b> Legal, Oficioll, 216x340mm</p>











**[Paper Settings]**

Menu Transition: [System Menu / Counter] key &gt; [Common Settings] &gt; [Paper Settings]

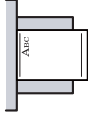
Configure settings for paper.

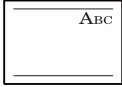
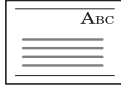
Item	Description
<b>Custom Paper Size</b>	<p>Set up frequently-used custom paper size.</p> <p>The custom size option is displayed on the screen to select paper size.</p> <p>To register a custom paper size, select [On] and enter the desired size.</p> <p><b>Value</b></p> <p><b>Metric</b></p> <p>X: 148 to 432 mm (in 1 mm increments)</p> <p>Y: 98 to 297 mm (in 1 mm increments)</p> <p><b>Inch</b></p> <p>X: 5.83 to 17.00" (in 0.01" increments)</p> <p>Y: 3.86 to 11.69" (in 0.01" increments)</p> <p>X=Length, Y=Width</p>
<b>Media Type Settings</b>	<p>Select weight (Paper thickness) for each media type.</p> <p>For Custom 1-8, settings for duplex printing and media type name can be changed.</p> <p>For details on setting value.</p> <p>➔ <a href="#">Media Type Setting (8-14)</a></p>
<b>Default Paper Source</b>	<p>Select the default paper source from Cassette 1-3 and multi purpose tray.</p> <p><b>Value:</b> Cassette 1 (to 3), Multipurpose Tray</p> <p> <b>NOTE</b></p> <p>[Cassette 2] to [Cassette 3] are displayed when the following optional paper feeder is installed.</p> <p>[Cassette 2]: When a paper feeder (500-sheet) or paper feeder (500-sheet x 2) is installed.</p> <p>[Cassette 3]: When a paper feeder (500-sheet x 2) is installed.</p>
<b>Paper Selection</b>	<p>Set whether the machine automatically selects the paper source or paper is fed from the default paper source.</p> <p><b>Value:</b> Auto, Default Paper Source</p>
<b>Media for Auto (Color)</b>	<p>Select a default media type for auto paper selection when [Auto] is selected of Paper Selection. If [Plain] is selected, the paper source with plain paper loaded in the specific size is selected. Select [All Media Types] for the paper source with any kind of paper loaded in the specific size.</p> <p><b>Value:</b> All Media Types, Plain, Transparency, Vellum, Labels, Recycled, Preprinted, Bond, Cardstock, Color, Prepunched, Letterhead, Envelope, Thick, Coated, High Quality, Custom (1 to 8)</p>
<b>Media for Auto (B &amp; W)</b>	<p>Select a default media type for auto paper selection when [Auto] is selected of Paper Selection. If [Plain] is selected, the paper source with plain paper loaded in the specific size is selected. Select [All Media Types] for the paper source with any kind of paper loaded in the specific size.</p> <p><b>Value:</b> All Media Types, Plain, Transparency, Vellum, Labels, Recycled, Preprinted, Bond, Cardstock, Color, Prepunched, Letterhead, Envelope, Thick, Coated, High Quality, Custom (1 to 8)</p>



Item	Description
<b>Special Paper Action</b>	<p>When printing on Prepunched, Preprint, and Letterhead, punch-holes might not be aligned or the print direction might be upside-down depending on how originals are set and the combination of copying functions. In such a case, select [Adjust Print Direction] to adjust the print direction. When paper orientation is not important, select [Speed Priority].</p> <p>If [Adjust Print Direction] is selected, load paper according to the steps below. Example: copying on Letterhead</p> <div style="display: flex; justify-content: space-around; align-items: center;"> <div style="text-align: center;">  Original         </div> <div style="text-align: center;">  Paper         </div> <div style="text-align: center;">  Finished         </div> <div style="text-align: center;">  Cassette         </div> <div style="text-align: center;">  Multi Purpose         </div> </div> <div style="display: flex; justify-content: space-around; align-items: center; margin-top: 10px;"> <div style="text-align: center;">  Original         </div> <div style="text-align: center;">  Paper         </div> <div style="text-align: center;">  Finished         </div> <div style="text-align: center;">  Cassette         </div> <div style="text-align: center;">  Multi Purpose         </div> </div> <p><b>Value:</b> Adjust Print Direction, Speed Priority</p>
<b>Show Paper Setup Message</b>	<p>Set whether to display the confirmation screen for the paper setting when a new paper is set for each cassette.</p> <p><b>Value:</b> On, Off</p> <p> <b>NOTE</b></p> <p>[Cassette 2] to [Cassette 3] are displayed when the following optional paper feeder is installed.</p> <p>[Cassette 2]: When a paper feeder (500-sheet) or paper feeder (500-sheet x 2) is installed.</p> <p>[Cassette 3]: When a paper feeder (500-sheet x 2) is installed.</p>
<b>Cassette 1 (to 3)</b>	
<b>Multipurpose Tray</b>	

### Media Type Setting

The following media type and paper weight combinations are available.

Paper Weight	Weight (g/m <sup>2</sup> ), Media Type	Paper Weight	Weight (g/m <sup>2</sup> ), Media Type
Light	- 59 g/m <sup>2</sup>	Heavy 1* <sup>1</sup>	106 g/m <sup>2</sup> -135 g/m <sup>2</sup>
Normal 1	60 g/m <sup>2</sup> - 74 g/m <sup>2</sup>	Heavy 2* <sup>1</sup>	136 g/m <sup>2</sup> - 163 g/m <sup>2</sup>
Normal 2	75 g/m <sup>2</sup> - 90 g/m <sup>2</sup>	Heavy 3* <sup>1</sup>	164 g/m <sup>2</sup>
Normal 3	91 g/m <sup>2</sup> - 105 g/m <sup>2</sup>	Extra Heavy* <sup>1</sup>	Transparency

\*1 The processing speed will be slower than normal.

Each media type's default weight is indicated.

Media Type	Default	Media Type	Default
Plain	Normal 2	Color	Normal 3
Transparency	Extra. Heavy	Prepunched	Normal 2
Rough	Normal 3	Letterhead	Normal 2
Vellum	Heavy 1	Envelope	Heavy 2
Labels	Heavy 2	Thick	Heavy 2
Recycled	Normal 2	High Quality	Normal 2

Media Type	Default	Media Type	Default
Preprinted	Normal 2	Coated	Heavy 1
Bond	Normal 3	Custom 1- 8	Normal 2
Cardstock	Heavy 3		

For Custom 1-8, settings for duplex printing and media type name can be changed.

Item		Description
Duplex	Permit	Duplex printing allowed.
	Prohibit	Duplex printing not allowed.
Name		Change names for Custom 1-8. Names should be not more than 16 characters. Selecting media type at multi purpose tray, the name after change will be displayed. <a href="#">➔ Character Entry Method (12-13)</a>

**[Function Defaults]**

Menu Transition: [System Menu / Counter] key &gt; [Common Settings] &gt; [Function Defaults]

Item	Description
<b>File Format</b>	Set the default type of the files. Value: PDF, High Comp. PDF, TIFF, JPEG, XPS, OpenXPS, Word, Excel, PowerPoint  <b>NOTE</b> [Word], [Excel], and [PowerPoint] appear when the optional OCR Scan Activation Kit is installed.
<b>Original Orientation (Copy)</b>	Set the original orientation defaults. Value: Top Edge on Top, Top Edge on Left, Auto
<b>Original Orientation (Send/Store)</b>	 <b>NOTE</b> [Auto] appears when the optional OCR Scan Activation Kit is installed.
<b>Collate/Offset</b>	Set the defaults for Collate/Offset. Value Off, Collate Only, Offset Each Page, Offset Each Set
<b>File Separation</b>	Select the default file separation setting. Value: Off, Each Page
<b>Scan Resolution</b>	Select the default scanning resolution. Value: 600x600dpi, 400x400dpi Ultra Fine, 300x300dpi, 200x400dpi Super Fine, 200x200dpi Fine, 200x100dpi Normal
<b>Color Selection (Copy)</b>	Set the default color mode setting (at copy). Value: Auto Color, Full Color, GrayscaleBlack & White
<b>Color Selection (Send/Store)</b>	Set the default color mode (send/store) setting. Value: Auto (Color/Gray), Auto (Color/B & W), Full Color, Grayscale, Black & White
<b>Original Image(Copy)</b>	Set the default original document type for copying. Value: Text+Photo, Photo, Text, Graphic/Map, Printer Output
<b>Original Image(Send/Store)</b>	Set the default original document type for sending/storing. Value: Text+Photo, Photo, Text, Text (for OCR), Light Text/Fine Line
<b>Background Density Adj. (Copy)</b>	Set the default Background Density (Copy). Value: Off, Auto, Manual (Darker 5)
<b>Background Density Adj. (Send/Store)</b>	Set the default Background Density (Send/Store). Value: Off, Auto, Manual (Darker 5)
<b>EcoPrint</b>	Select the EcoPrint default. Value: Off, On
<b>Prevent Bleed-through (Copy)</b>	Set the default value for preventing bleed-through (Copy). Value: Off, On
<b>Prevent Bleed-through (Send/Store)</b>	Set the default Prevent Bleed (Send/Store). Value: Off, On
<b>Skip Blank Page (Copy)</b>	Select the default Skip Blank Page settings (Copy). Value: Off, On
<b>Skip Blank Page (Send/Store)</b>	Select the default Skip Blank Page settings (Copy). Value: Off, On
<b>FAX TX Resolution</b> <sup>*1</sup>	➔ FAX Operation Guide

Item	Description
<b>Zoom</b>	Set the zoom defaults. Value: 100%, Auto
<b>Margin</b>	Set the default margin. Value Metric Left/Right: -18 to 18 mm (in 1 mm increments) Top/Bottom: -18 to 18 mm (in 1 mm increments) Inch Left/Right: -0.75 to 0.75" (in 0.01" increments) Top/Bottom: -0.75 to 0.75" (in 0.01" increments)
<b>Erase Shadowed Areas</b>	Set the default Erase Shadowed Areas setting. Value: Off, On
<b>Continuous Scan (Copy)</b>	Set continuous scan defaults (at copy). Value: Off, On
<b>Continuous Scan (FAX)<sup>*1</sup></b>	➔ FAX Operation Guide
<b>Continuous Scan (Send/Store)</b>	Set the continuous scan defaults (Send/Store). Value: Off, On
<b>Auto Image Rotation</b>	Select the default Auto Image Rotation setting. Value: Off, On
<b>File Name Entry</b>	Set an automatically entered name (default) for jobs. Additional information such as Date and Time and Job No. can also be set. Value File Name: Up to 32 characters can be entered. Additional Info: None, Date and Time, Job No., Job No. & Date and Time, Date and Time & Job No.
<b>E-mail Subject/Body</b>	Set the subject and body automatically entered (default subject and body) when sending the scanned originals by E-mail. Value Subject: Up to 60 characters can be entered. Body: Up to 500 characters can be entered.
<b>FTP Encrypted TX</b>	Set the document encryption default at send. Value: Off, On  <b>NOTE</b> Displayed when secure protocol [SSL] is [On].
<b>JPEG/TIFF Print</b>	Select the image size (resolution) when printing JPEG or TIFF file. Value: [Paper Size], [Image Resolution], [Print Resolution]
<b>XPS Fit to Page</b>	Set the default value for the XPS fit to page function. Value: Off, On

Item	Description
<b>Detail Settings</b>	-
<b>Image Quality</b>	Set the default of the image adjustment range when selecting the file format of the image to be sent or saved. <b>Value:</b> 1 Low Quality (High Comp.) to 5 High Quality (Low Comp.)
<b>PDF/A</b>	Select the default PDF/A setting. <b>Value:</b> Off, PDF/A-1a, PDF/A-1b, PDF/A-2a, PDF/A-2b, PDF/A-2u
<b>High Comp. PDF Image</b>	Select the default quality setting for high compressed PDF files. <b>Value:</b> Compression Ratio Priority, Standard, Quality Priority
<b>OCR Text Recognition<sup>*2</sup></b>	Set the default OCR Text Recognition. <b>Value:</b> Off, On
<b>Primary OCR Language<sup>*2</sup></b>	Set the default language of the text to be extracted. ([English] is selected as a default.) Select the language to extract from the options displayed on the touch panel.
<b>OCR Output Format<sup>*2</sup></b>	Set the default OCR Output Format. <b>Value:</b> Text + Graphics, Text + Graphics with Scanned Image, Scanned Image with Searchable Text
<b>Detect Items to Skip (Copy)</b>	Select the default Skip Blank Page settings (Copy). <b>Value:</b> Blank Pages + Ruled Lines, Blank Pages Only, Blank Pages + Some Text
<b>Detect Items to Skip (Send/Store)</b>	Select the default Skip Blank Page settings. <b>Value:</b> Blank Pages + Ruled Lines, Blank Pages Only, Blank Pages + Some Text

\*1 This function is displayed when an optional FAX Kit is installed.

\*2 Displayed only when the optional OCR Scan Activation Kit is installed.

## [Paper Output]

Menu Transition: [System Menu / Counter] key > [Common Settings] > [Paper Output]

Item	Description
<b>Paper Output</b>	Select the output tray respectively for copy jobs, print jobs from Document Box, computers, and FAX RX data. <b>Value</b> <ul style="list-style-type: none"> <li>• Inner Tray: Outputs to the Inner Tray of the machine</li> <li>• Job Separator: Delivery to the Job Separator.</li> </ul> Document Finisher <ul style="list-style-type: none"> <li>• Job Separator: Delivery to the Job Separator.</li> <li>• Finisher Tray: Delivery to the Finisher Tray of the optional Sheet Finisher.</li> </ul>  <b>NOTE</b> <ul style="list-style-type: none"> <li>• FAX RX data output can be specified when the optional FAX Kit is installed.</li> </ul>

## [Preset Limit]

Menu Transition: [System Menu / Counter] key > [Common Settings] > [Preset Limit]



Restrict the number of copies that can be made at one time.

Item	Description
<b>Preset Limit</b>	<b>Value:</b> 1 to 999 copies

**[Error Handling]**

Menu Transition: [System Menu / Counter] key &gt; [Common Settings] &gt; [Error Handling]

Select whether to cancel or continue the job when error has occurred.

Item	Description
<b>Duplexing Error</b>	Set what to do when duplex printing is not possible for the selected paper sizes and media types. <b>Value</b> 1-sided: Printed in 1-sided Display Error: Message to cancel printing is displayed.
<b>Finishing Error</b>	Set alternative actions when finishing (Staple/Offset) is not available for the selected paper size or media type. <b>Value</b> Ignore: The setting is ignored and the job is printed. Display Error: Message to cancel printing is displayed.
<b>No Staple Error</b>	Set what to do when staples run out during printing. <b>Value</b> Ignore: Printing continues without stapling. Display Error: Message to cancel printing is displayed.  <b>NOTE</b> Requires the optional Document Finisher.
<b>Stapling Limit Error</b>	Set what to do when stapling capacity is exceeded during printing. <b>Value</b> Ignore: Printing continues without stapling. Display Error: Message to cancel printing is displayed.  <b>NOTE</b> Requires the optional Document Finisher.
<b>Paper Mismatch Error</b>	Set what to do when the selected paper size or type does not match paper size or type loaded in the specified paper source while printing from the computer by specifying the cassette or multi-purpose tray. <b>Value</b> Ignore: The setting is ignored and the job is printed. Display Error: Message to cancel printing is displayed.
<b>Inserted Paper Mismatch</b>	Set what to do when it is detected that the cassette paper size setting does not match the actual paper size that is fed. <b>Value</b> Ignore: The setting is ignored and the job is printed. Display Error: Message to cancel printing is displayed.

**[Color Toner Empty Action]**

Menu Transition: [System Menu / Counter] key &gt; [Common Settings] &gt; [Color Toner Empty Action]

Item	Description
<b>Color Toner Empty Action</b>	Select whether printing is prohibited or the Print in Black and White setting is used for printing once the color toner runs out. <b>Value:</b> Stop printing, Print in Black & White

**[Measurement]**

Menu Transition: [System Menu / Counter] key &gt; [Common Settings] &gt; [Measurement]

Item	Description
Measurement	Select inch or metric for the unit for paper dimensions. Value: mm, inch

**[Low Toner Alert]**

Menu Transition: [System Menu / Counter] key &gt; [Common Settings] &gt; [Low Toner Alert]

Item	Description
Low Toner Alert	Set the amount of remaining toner to notify the administrator when to order a toner when the toner is running low. This notification is used for event report, Status Monitor, SNMP Trap. Value: Off, On  <b>NOTE</b> If [On] is selected, set the amount of remaining toner to alert. The setting range is 5 to 100% (in 1% increments).

**Keyboard Layout**

Menu transition: [System Menu/Counter] key &gt; [Common Settings] &gt; [Keyboard Layout]

Item	Description
Keyboard Layout	<b>Change the layout of the touch panel keyboard used to enter characters.</b> Value: QWERTY, QWERTZ, AZERTY

**[USB Keyboard Type]**

Menu transition: [System Menu / Counter] key &gt; [Common Settings] &gt; [USB Keyboard Type]

Item	Description
USB Keyboard Type	<b>Select the type of USB keyboard that you want to use.</b> Value: US-English, US-English with Euro, French, German, British English

**[Offset Documents by Job]**

Menu Transition: [System Menu / Counter] key &gt; [Common Settings] &gt; [Offset Documents by Job]

Set the display method of the Status/Log.

Item	Description
Offset Documents by Job	Select whether to offset documents by Job. Value: Off, On  <b>NOTE</b> This function is displayed when an optional Document Finisher is installed.

**[Offset One Page Documents]**

Menu Transition: [System Menu / Counter] key &gt; [Common Settings] &gt; [Offset One Page Documents]

Item	Description
<b>Offset One Page Documents</b>	Set whether one-page documents are sorted. Value: Off, On  <b>NOTE</b> This function is displayed when an optional Document Finisher is installed.

**[Display Status/Log]**

Menu Transition: [System Menu / Counter] key &gt; [Common Settings] &gt; [Display Status/Log]

Set the display method of the Status/Log.

Item	Description
<b>Display Jobs Detail Status</b>	Value: Show All, My Jobs Only, Hide All
<b>Display Jobs Log</b>	Value: Show All, My Jobs Only, Hide All
<b>Display FAX Log<sup>*1</sup></b>	Value: Show All, Hide All

\*1 Displayed only on products with the fax function installed.

**[Function Key Assignment]**

Menu Transition: [System Menu / Counter] key &gt; [Common Settings] &gt; [Function Key Assignment]

Assigns a function to each function key.

Item	Description
<b>Function Key 1</b>	Value: None, Copy, Send, FAX Server <sup>*1</sup> , FAX <sup>*2</sup> , Custom Box <sup>*3</sup> Job Box, Removable Memory, Sub Address Box <sup>*2</sup> , Polling Box <sup>*2</sup> , FAX Memory RX Box <sup>*2</sup> , ID Card Copy, Paper Saving Copy, Simple Folder Send (Destination Entry), Simple Folder Send (Address Book), Simple Email Send (Destination Entry), Simple Email Send (Address Book), Application <sup>*4</sup>  <b>NOTE</b> You can select the function to display by selecting [Menu] > [Narrow Down] or from the pull-down menu, by selecting [All], [Application], [Favorites], [Others] to display the function.
<b>Function Key 2</b>	
<b>Function Key 3</b>	

\*1 Displayed when the external server (FAX server) is set.

\*2 Displayed only on products with the fax function installed.

\*3 Displayed when the product is equipped with an optional large capacity storage device (SSD).

\*4 The registered application name is displayed.

**[Show Power Off Message]**

Menu Transition: [System Menu / Counter] key &gt; [Common Settings] &gt; [Show Power Off Message]

Item	Description
<b>Show Power Off Message</b>	Set the mode whether display a confirmation message in power supply off. Value: Off, On



## [Layout for ID Card Copy]

Menu Transition: [System Menu / Counter] key > [Common Settings] > [Layout for ID Card Copy]

Item	Description
Layout for ID Card Copy	Set the print position of the scanned image when copying the ID card. Value: Align Upper Right, Align Center

## [Home]

Menu Transition: [System Menu / Counter] key > [Home]

Configure settings for Home screen.

➔ [Editing the Home Screen \(3-8\)](#)

# [Copy]

Menu Transition: [System Menu / Counter] key > [Copy]

Configures settings for copying functions.

Item	Description
<b>Auto Paper Selection</b>	<p>If [Auto] is selected for Paper Selection, set the paper size selection method when the zoom changes.</p> <p><b>Value</b></p> <p>Most Suitable Size: Selects paper size based on the current zoom and the size of the original.</p> <p>Same as Original Size: Selects paper that matches the size of the original, regardless the zoom.</p>
<b>Auto % Priority</b>	<p>When a paper source of different size from the original is selected, select whether automatic zoom (reduce/zoom) is performed.</p> <p><b>Value:</b> Off, On</p>
<b>Paper Size for Small Original</b>	<p>Specify the paper size to be used for a case where the original is too small to be detected in the Auto Paper Selection mode.</p> <p><b>Value:</b> Default Paper Source, A4-R, A4, A5-R, A6-R, B5-R, B5, B6-R, Letter-R, Letter, Statement-R</p>
<b>Original Size of Undetected Original</b>	<p>This specifies the size to use for the original when the original size is not detected.</p> <p><b>Value:</b> According to default paper size, Display size selection screen</p>
<b>Reserve Next Priority</b>	<p>Specify whether the default screen appears when a subsequent copy job is reserved while printing is in progress. To have the default screen appear, select [On].</p> <p><b>Value:</b> Off, On</p>
<b>Auto Image Rotation Action</b>	<p>Set whether the image is rotated when the orientation of the document to be printed is different from the orientation of the paper.</p> <p><b>Value:</b> No rotation for manual copy, Always rotate, Rotate according to image size</p>

# [Send]

Menu Transition: [System Menu / Counter] key &gt; [Send]

Configures settings for sending functions.

Item	Description
<b>Dest. Check before Send</b>	Select whether to display the confirmation screen of destinations after pressing the [Start] key when performing sending jobs. Value: Off, On
<b>Entry Check for New Dest.</b>	When adding new destination, select whether to display the entry check screen to check the entered destination. Value: Off, On
<b>Send and Forward</b>	Select whether to forward the original to another destination when sending images.
<b>Forward</b>	Select whether to forward the original. Value: Off, On  <b>NOTE</b> If [On] is selected select from among the following for the forwarding rule: [FAX], <sup>*1</sup> [E-mail], [Folder (SMB)], [Folder (FTP)].
<b>Destination</b>	Set the destination to which the original is forwarded. One destination can be set. Follow the steps below to register the destination. <ul style="list-style-type: none"> <li>• Address Book</li> <li>• Ext Address Book</li> <li>• Address Entry (Mail)</li> <li>• Address Entry (Folder)</li> </ul> <a href="#">➔ Destination Operations (5-27)</a>
<b>Color TIFF Compression</b>	Specify the compression method for color TIFF images handled by this machine. Value: TIFF V6, TTN2
<b>Default Screen</b>	Set the default screen displayed when you select the [Send] key. Value: Destination, Address Book, Ext Address Book, One Touch
<b>New Destination Entry</b>	Select whether to permit direct entry of destination. Value: Permit, Prohibit
<b>Recall Destination</b>	Select whether to permit usage of [Recall] on the Send screen. Value: Permit, Prohibit
<b>Broadcast</b>	Set whether to enable broadcast. Value: Permit, Prohibit
<b>OCR Text Recognition Act.<sup>*2</sup></b>	Configure settings for OCR Text Recognition Action. Value: Speed Priority, Quality Priority



\*1 Displayed only when the optional fax function is installed.

\*2 Displayed only when the optional OCR Scan Activation Kit is installed.

# [Document Box]

Menu Transition: [System Menu / Counter] key > [Document Box]

Configures settings for the Custom Box, Job Box, F Code Box, and Polling Box.

Item	Description
<b>Custom Box</b> <sup>*1</sup>	Configure settings for Custom Box.
<b>Add/Edit</b>	➔ <a href="#">Using Machine Operations to Create a New Custom Box (3-49)</a>
<b>Default Setting</b>	Auto File Deletion Time Set the time to automatically delete stored documents.
<b>Sub Address Box</b> <sup>*2</sup>	➔ FAX Operation Guide
<b>Job Box</b>	Configure settings for Job Box.
<b>Quick Copy Job Retention</b>	To maintain free space on the box, you can set the maximum number of stored jobs. <b>Value:</b> number between 0 and 300   <b>NOTE</b> When 0 is set, Quick Copy cannot be used.
<b>Deletion of Job Retention</b>	This setting specifies that documents, such as Private Printing, Quick Copying, or Proof and Hold Printing, saved temporarily in the job box are automatically deleted after they have been saved for a set time. <b>Value:</b> Off, 1 hour, 4 hours, 1 day, 1 week   <b>NOTE</b> This function is valid for documents saved after the function is set. Regardless of this function setting, temporary documents are deleted when the main power switch is turned off.
<b>Storage Media</b>	Select which storage media to use. <b>Value:</b> SSD, SD card   <b>NOTE</b> This setting will not be displayed unless an optional SSD or SD card device is installed.
<b>Polling Box</b> <sup>*2</sup>	➔ FAX Operation Guide
<b>FAX Memory RX Box</b> <sup>*2</sup>	

\*1 Displayed only when an optional SSD is installed.

\*2 Displayed only when the optional fax function is installed.

## [FAX]

Menu Transition: [System Menu / Counter] key > [FAX]

This configures fax function settings.

➔ [FAX Operation Guide](#)

## [Application]

Menu Transition: [System Menu / Counter] key > [Application]

Configure settings for Application.

➔ [Application \(2-54\)](#)

## [Internet]

Menu Transition: [System Menu / Counter] key > [Internet]

Set the proxy for connection to the Internet from an application.

Item	Description
<b>Proxy</b>	This configures the proxy setting. <i>Value:</i> Off, On
<b>Use Same Proxy</b>	Set whether the same proxy server is used for all protocols. If you do not want to use the same proxy server, select [Off]. <i>Value:</i> Off, On
<b>HTTP Proxy Server</b>	Set a proxy server (HTTP). <i>Value:</i> (Enter the proxy address and port number.)
<b>HTTPS ProxyServer</b>	Set a proxy server (HTTPS). This setup is available when the "Use the Same Proxy Server" setting is [Off]. <i>Value:</i> (Enter the proxy address and port number.)
<b>No Proxy Domains</b>	Set domains for which no proxy is used. <i>Value:</i> (Enter the domain name.)



## [Address Book/One Touch]

Menu Transition: [System Menu / Counter] key > [Address Book/One Touch]

Save frequently used destinations to the Address Book or One Touch Key. The saved destinations can be changed. Saved destinations can be modified. Destinations are available for Send as E-mail, Send to Folder, and FAX Transmission.

➔ [Adding a Destination \(3-32\)](#)

### [Address Book]

[System Menu / Counter] key > [Address Book/One Touch] > [Address Book]

Configure settings for address book.

➔ [Adding a Destination \(Address Book\) \(3-32\)](#)

### [One Touch Key]

Menu Transition: [System Menu / Counter] key > [Address Book/One Touch] > [One Touch Key]

Configure settings for One Touch Key.

➔ [Assigning a Destination to a One Touch Key \(3-37\)](#)

### [Address Book Defaults]

[System Menu / Counter] key > [Address Book/One Touch] > [Address Book Defaults]

Item	Description
<b>Sort</b>	Select the default sort setting of the address for the address book. <i>Value:</i> Number, Name
<b>Address Book Type</b> <sup>*1</sup>	This procedure can be used to filter (narrow down) the types of destination listed when the address book is displayed. <i>Value:</i> Machine Address Book, Ext Address Book

\*1 Appears only when an External The Address Book can be used.

### [Edit Restriction]

Menu Transition: [System Menu / Counter] key > [Address Book/One Touch] > [Edit Restriction]

Item	Description
<b>Address Book</b>	Restrict editing of the address book. If [Administrator Only] is selected, log in with administrator privileges is required to edit the address book. <i>Value:</i> Unlimited, Administrator Only
<b>One Touch Key</b>	Restrict editing of the One Touch Key. If [Administrator Only] is selected, log in with administrator privileges is required to edit One Touch Keys. <i>Value:</i> Unlimited, Administrator Only

### [Print List]

Menu Transition: [System Menu / Counter] key > [Address Book/One Touch] > [Print List]

➔ FAX Operation Guide

## [User Login/Job Accounting]

Menu Transition: [System Menu / Counter] key > [User Login/Job Accounting]

Configure settings for machine management.

➔ [Overview of User Login Administration \(9-3\)](#)

➔ [User Login/Job Accounting \(9-29\)](#)



➔ [Setting Unknown Number Processing Method \(9-46\)](#)

# [Printer]

Menu Transition: [System Menu / Counter] key > [Printer]

Printing from computers, settings are generally made on the application software screen. However, the following settings are available for configuring the defaults to customize the machine.

Item	Description
<b>Emulation</b>	<p>Select the emulation for operating this machine by commands oriented to other types of printers.</p> <p><b>Value:</b> PCL6, KPDL, KPDL (Auto)</p> <p> <b>NOTE</b></p> <p>When you have selected [KPDL (Auto)], set "Alt Emulation", too.</p> <p>When you have selected [KPDL] or [KPDL (Auto)], set "KPDL Error Report", too.</p>
<b>Alt Emulation</b>	<p>When you have selected [KPDL (Auto)] as emulation mode, you can switch between KPDL and another emulation mode (alternative emulation) automatically according to the data to print.</p> <p><b>Value:</b> PCL6</p>
<b>KPDL Error Report</b>	<p>When an error has occurred during printing in KPDL emulation mode, set whether or not the error report is output.</p> <p><b>Value:</b> Off, On</p>
<b>Color Setting</b>	<p>You can choose whether reports are printed in color or black and white.</p> <p><b>Value:</b> Color, Black &amp; White</p>
<b>EcoPrint</b>	<p>EcoPrint conserves toner when printing. This is recommended for test copies where faded printing is not a problem.</p> <p><b>Value:</b> Off, On</p>
<b>Override A4/Letter</b>	<p>Select whether to treat A4 size and Letter, which are similar in size, as the same size when printing.</p> <p><b>Value</b></p> <p>Off: A4 and Letter are not regarded as the same in size.</p> <p>On: A4 and Letter are regarded as the same in size. The machine will use whichever size is in the paper source.</p>
<b>Duplex</b>	<p>Select binding orientation for duplex mode.</p> <p><b>Value:</b> 1-sided, 2-sided Bind LongEdge, 2-sided Bind ShortEdge</p>
<b>Copies</b>	<p>Set the default number of copies, from 1 to 999.</p> <p><b>Value:</b> 1 to 999 copies</p>
<b>Orientation</b>	<p>Set the default orientation, [Portrait] or [Landscape].</p> <p><b>Value:</b> Portrait, Landscape</p>
<b>Wide A4</b>	<p>Turn this to on to increase the maximum number of characters that can be printed in a line for an A4 page (78 characters at 10 pitch) and Letter size page (80 characters at 10 pitch). This setting is only effective in PCL6 emulation.</p> <p><b>Value:</b> Off, On</p>
<b>Form Feed TimeOut</b>	<p>Receiving print data from the computer, the machine may sometimes wait if there is no information signaling that the last page does not have any more data to be printed. When the preset timeout passes, the machine automatically prints paper. The options are between 5 and 495 seconds.</p> <p><b>Value:</b> 5 to 495 seconds (in 5 second increments)</p>
<b>LF Action</b>	<p>Set the line feed action when the machine receives the line feed code (character code 0AH).</p> <p><b>Value:</b> LF Only, LF and CR, Ignore LF</p>

Item	Description
<b>CR Action</b>	Set the character return action when the machine receives the character return code (character code 0DH). <b>Value:</b> CR Only, LF and CR, Ignore CR
<b>Job Name</b>	Set whether the job name set in the printer driver is displayed. <b>Value:</b> Off, On  <b>NOTE</b> When selecting [On], select the job name to be displayed from [Job Name], [Job No. & Job Name], or [Job Name & Job No.].
<b>User Name</b>	Set whether the user name set in the printer driver is displayed. <b>Value:</b> Off, On
<b>Print Area Compensation</b>	Correct the print area of the printer. The printing position may differ from the expected position in some applications. In this event, you can correct the print position by shifting it vertically and horizontally. <b>Value</b> Vertical: -76.0 to +76.0 mm Horizontal: -76.0 to +76.0 mm
<b>MP Tray Priority</b>	If paper is set in the MP Tray then it is possible for priority to be given to that MP tray in the paper feed. <b>Value</b> Off: The printer driver settings are followed. Auto Feed: If Auto is selected in the printer driver and there is paper in the MP tray then the paper feed will be from the MP tray. Always: If there is paper in the MP tray then the paper feed will be from the MP tray regardless of what is set in the printer driver.
<b>Paper Feed Mode</b>	While printing from the computer, select how to feed paper when the paper source and type are specified. <b>Value</b> Auto: Search the paper source that matches the selected paper size and type. Fixed: Print on paper loaded in the specified paper source.
<b>Auto Cassette Change</b>	Select the following actions when the paper runs out in the paper source while printing. <b>Value:</b> Off, On  <b>NOTE</b> When selecting [Off], the machine displays "Add the following paper in cassette #." (# is a cassette number) or "Add the following paper in the multi purpose tray.", and stops printing. Load the paper according to the paper source displayed to resume printing. To print from the other paper cassette, select [Paper Selection]. Select the desired paper source. When selecting [On], the machine continues printing automatically when the other cassette contains the same paper as the currently-used cassette.
<b>Resolution</b>	Set the resolution used for printing. <b>Value:</b> 600 dpi, 1200 dpi  <b>NOTE</b> Settings that are received from the printer driver have priority over the operation panel settings.
<b>KIR</b>	Select the default KIR (smoothing) setting. <b>Value:</b> Off, On

Item	Description
<b>Gloss Mode</b>	<p>Gloss Mode increases the effect of glossiness in printing. However, printing takes longer time. <b>Value:</b> Off, On</p> <p> <b>IMPORTANT</b></p> <p><b>This function is not available when [Labels] or [Transparency] is selected as the paper type setting.</b></p> <p>➔ <a href="#">[Cassette/MP Tray Settings] (8-9)</a></p> <p>Depending on the paper used, printing in gloss mode may cause curl in paper. To reduce curl, try using thicker paper.</p>
<b>Printing Job Terminator</b>	<p>You can select the condition which regarded as a job termination if the print job could not be processed until the end due to your environment and the other reason.</p> <p><b>Value</b></p> <p>EOJ (END of Job): Up to the detection of a command indicating the end of job data is regarded as one job.</p> <p>End of Network Session: The data included in a network session at network connection is regarded as one job.</p> <p>UEL (Universal Exit Language): The UEL included in the termination of the job data is regarded as one job until it is detected.</p>

## [System/Network]

Configures machine system settings.

### [Network]

Configures network settings.

### [Host Name]

Menu Transition: [System Menu / Counter] key > [System/Network] > [Network] > [Host Name]

Item	Description
Host Name	Check the host name of the machine. Host name can be changed from Command Center RX. <a href="#">➔ Changing Device Information (2-44)</a>

### [Wi-Fi Direct Settings]

Menu Transition: [System Menu / Counter] key > [System/Network] > [Network] > [Wi-Fi Direct Settings]

Configure Wi-Fi Direct settings.



#### NOTE

This function is displayed when the Wireless Network Interface Kit (IB-36) is installed.

The Wireless Network Interface Kit is an option for some models. Contact your dealer or our sales or service representatives for detail.

➔ [IB-36 <Wireless Network Interface Kit> \(12-3\)](#)

Item	Description
Wi-Fi Direct	Select whether to use Wi-Fi Direct. Value: Off, On
Device Name	Configure the device name setting. <b>NOTE</b> Up to 32 characters can be entered. This function is displayed when [On] is selected for the Wi-Fi Direct setting.
IP Address	Use this to check the machine IP address. <a href="#">➔ [TCP/IP Setting] (8-41)</a> Value: ###.###.###.### <b>NOTE</b> If [On] is selected, set the time until the job is skipped. This function is displayed when [On] is selected for the Wi-Fi Direct setting.
Auto Disconnect	Automatically disconnects devices connected by Wi-Fi Direct. Value: Off, On <b>NOTE</b> When DHCP is set to [On], this function will be grayed out and the value cannot be entered.

**[Wi-Fi Settings]**

Menu Transition: [System Menu / Counter] key &gt; [System/Network] &gt; [Network] &gt; [Wi-Fi Settings]

Configure Wi-Fi settings.

**NOTE**

This function is displayed when the Wireless Network Interface Kit (IB-36) is installed.

The Wireless Network Interface Kit is an option for some models. Contact your dealer or our sales or service representatives for detail.

➔ [IB-36 <Wireless Network Interface Kit> \(12-3\)](#)

**[Wi-Fi]**

Item	Description
Wi-Fi	Select whether to use Wi-Fi. Value: Off, On



**[Setup]**

Item	Description
Connection Status	This can be used to check the wireless LAN status.
Quick Setup	If the machine will connect to an access point that supports the automatic wireless network setup, connection settings can be configured by Quick Setup.
Available Network	Displays access points to which the machine can connect. Select a desired access point from the list.
WEP Key Index	Select the key index value that is set on the access point. Value: 0 to 3
Push Button Method	If the access point supports the push button method, wireless settings can be configured using the push button. This setting executes push button, and the connection is started by pressing the push button on the access point.   <b>NOTE</b> The push button method supports only the WPS.
PIN Code Method (Device)	Starts connection using the machine's PIN code. Enter the PIN code into the access point. The PIN code of the machine is automatically generated.
Custom Setup	The detailed settings for wireless LAN can be changed.

Item	Description
<b>Network Name (SSID)</b>	Set the SSID (Service Set Identifier) of the wireless LAN to which the machine connects.  <b>NOTE</b> Up to 32 characters can be entered.
<b>Network Authentication</b>	Select network authentication type. <b>Value:</b> Open System, WPA2/WPA-PSK, WPA2-PSK, WPA2/WPA-EAP, WPA2-EAP
<b>Encryption</b>	Select encryption method. The setting values vary depending on the [Network Authentication] setting. When [Network Authentication] is set to [Open] <b>Value:</b> Disable, WEP WEP Key: Up to 26 characters WEP Key Index: 0 to 3 When Network Authentication is set to [WPA2/WPA-PSK] <b>Value:</b> AES, Auto Pre-shared Key: Up to 64 characters When Network Authentication is set to [WPA2-PSK] <b>Value:</b> AES (Fixed) Pre-shared Key: Up to 64 characters When Network Authentication is set to [WPA2/WPA-EAP] <b>Value:</b> AES, Auto When Network Authentication is set to [WPA2-EAP] <b>Value:</b> AES (Fixed)







**[TCP/IP Settings]**

Item	Description
<b>TCP/IP</b>	Select whether to use TCP/IP Protocol. <i>Value:</i> Off, On
<b>IPv4 Settings</b>	Set up TCP/IP (IPv4) to connect to the network. This setting is available when [TCP/IP] is [On].
<b>DHCP</b>	Select whether to use the DHCP (IPv4) server. <i>Value:</i> Off, On
<b>Auto-IP</b>	Select whether to use Auto-IP. <i>Value:</i> Off, On
<b>IP Address</b>	Set the IP address. <i>Value:</i> ###.###.###.###  <b>NOTE</b> When DHCP is set to [On], this function will be grayed out and the value cannot be entered.
<b>Subnet Mask</b>	Set the IP subnet mask. <i>Value:</i> ###.###.###.###  <b>NOTE</b> When DHCP is set to [On], this function will be grayed out and the value cannot be entered.
<b>Default Gateway</b>	Set the IP gateway address. <i>Value:</i> ###.###.###.###  <b>NOTE</b> When DHCP is set to [On], this function will be grayed out and the value cannot be entered.
<b>DNS Server</b>	Select whether or not to automatically obtain an IP address using DHCP. <i>Value:</i> Auto (DHCP), Manual
<b>IP Address</b>	When [DNS Server] is set to [Manual], set the IP addresses of the primary and secondary DNS servers.
<b>Primary Server</b>	Set the IP addresses of the primary DNS servers. <i>Value:</i> ###.###.###.###
<b>Secondary Server</b>	Set the IP addresses of the secondary DNS servers. <i>Value:</i> ###.###.###.###

 **IMPORTANT**

- When setting the Auto-IP, enter "0.0.0.0" in [IP Address].
- After changing the setting, restart the network or turn the machine OFF and then ON.

➔ [\[Restart Network\] \(8-51\)](#)

Item	Description
<b>IPv6</b>	Set up TCP/IP (IPv6) to connect to the network. This setting is available when [TCP/IP] is [On].
<b>IPv6</b>	Select whether to use IPv6. <b>Value:</b> Off, On  <b>NOTE</b> Selecting [On] displays IP address in [IP Address (Link Local)] after restarting the network.
<b>Manual Setting</b>	Manual Setting (IPv6) Manually specify the IP address, prefix length, and gateway address of TCP/IP (IPv6). <b>Value</b> IP Address (Manual): 128-bits address is expressed in eight groups consisting of four-digit hexadecimal digits. The groups are separated by colon (:). Prefix Length: 0 to 128 Default Gateway: 128-bits address is expressed in eight groups consisting of four-digit hexadecimal digits. The groups are separated by colon (:).  <b>NOTE</b> This function is displayed when [IPv6] is set to [On]. To enter [Default Gateway], set [RA (Stateless)] to [Off].
<b>RA (Stateless)</b>	Select whether to use RA (Stateless). <b>Value:</b> Off, On  <b>NOTE</b> This function is displayed when [IPv6] is set to [On]. Selecting [On] displays IP address in [IP Address (Stateless)] after restarting the network.
<b>DHCP</b>	Select whether to use the DHCP (IPv6) server. <b>Value:</b> Off, On  <b>NOTE</b> This function is displayed when [IPv6] is set to [On]. Selecting [On] displays IP address in [IP Address (Stateful)] after restarting the network.
<b>DNS Server</b>	Select whether or not to automatically obtain an IP address using DHCP. <b>Value:</b> Auto (DHCP), Manual
<b>IP Address</b>	When [DNS Server] is set to [Manual], set the IP addresses of the primary and secondary DNS servers.
<b>Primary Server</b>	Set the IP addresses of the primary DNS servers. <b>Value:</b> 128-bits address is expressed in eight groups consisting of four-digit hexadecimal digits. The groups are separated by colon (:).
<b>Secondary Server</b>	Set the IP addresses of the secondary DNS servers. <b>Value:</b> 128-bits address is expressed in eight groups consisting of four-digit hexadecimal digits. The groups are separated by colon (:).

 **IMPORTANT**

After changing the setting, restart the network or turn the machine **OFF** and then **ON**.



➔ [\[Restart Network\] \(8-51\)](#)

## **[Wired Network Settings]**

Menu Transition: [System Menu/Counter] key > [System/Network] > [Network] > [Wired Network Settings]

Configure settings for the Wired Network Settings.





## [TCP/IP Setting]

Item	Description
<b>TCP/IP</b>	Select whether to use TCP/IP Protocol. Value: Off, On
<b>IPv4</b>	Set up TCP/IP (IPv4) to connect to the network. This setting is available when [TCP/IP] is [On].
<b>DHCP</b>	Select whether to use the DHCP (IPv4) server. Value: Off, On
<b>Auto-IP</b>	Select whether to use Auto-IP. Value: Off, On
<b>IP Address</b>	Set the IP address. Value: ###.###.###.###  <b>NOTE</b> When DHCP is set to [On], this function will be grayed out and the value cannot be entered.
<b>Subnet Mask</b>	Set the IP subnet mask. Value: ###.###.###.###  <b>NOTE</b> When DHCP is set to [On], this function will be grayed out and the value cannot be entered.
<b>Default Gateway</b>	Set the IP gateway address. Value: ###.###.###.###  <b>NOTE</b> When DHCP is set to [On], this function will be grayed out and the value cannot be entered.
<b>DNS Server</b>	Select whether or not to automatically obtain an IP address using DHCP. Value: Auto (DHCP), Manual
<b>IP Address</b>	When [DNS Server] is set to [Manual], set the IP addresses of the primary and secondary DNS servers.
<b>Primary Server</b>	Set the IP addresses of the primary DNS servers. Value: ###.###.###.###
<b>Secondary Server</b>	Set the IP addresses of the secondary DNS servers. Value: ###.###.###.###

 **IMPORTANT**

- When setting the Auto-IP, enter "0.0.0.0" in [IP Address].
- After changing the setting, restart the network or turn the machine OFF and then ON.

➔ [\[Restart Network\] \(8-51\)](#)

Item	Description
<b>IPv6</b>	Set up TCP/IP (IPv6) to connect to the network. This setting is available when [TCP/IP] is [On].
<b>IPv6</b>	Select whether to use IPv6. <b>Value:</b> Off, On  <b>NOTE</b> Selecting [On] displays IP address in [IP Address (Link Local)] after restarting the network.
<b>Manual Setting</b>	Manual Setting (IPv6) Manually specify the IP address, prefix length, and gateway address of TCP/IP (IPv6). <b>Value</b> IP Address (Manual): 128-bits address is expressed in eight groups consisting of four-digit hexadecimal digits. The groups are separated by colon (:). Prefix Length: 0 to 128 Default Gateway: 128-bits address is expressed in eight groups consisting of four-digit hexadecimal digits. The groups are separated by colon (:).  <b>NOTE</b> This function is displayed when [IPv6] is set to [On]. To enter [Default Gateway], set [RA (Stateless)] to [Off].
<b>RA (Stateless)</b>	Select whether to use RA (Stateless). <b>Value:</b> Off, On  <b>NOTE</b> This function is displayed when [IPv6] is set to [On]. Selecting [On] displays IP address in [IP Address (Stateless)] after restarting the network.
<b>DHCP</b>	Select whether to use the DHCP (IPv6) server. <b>Value:</b> Off, On  <b>NOTE</b> This function is displayed when [IPv6] is set to [On]. Selecting [On] displays IP address in [IP Address (Stateful)] after restarting the network.
<b>DNS Server</b>	Select whether or not to automatically obtain an IP address using DHCP. <b>Value:</b> Auto (DHCP), Manual
<b>IP Address</b>	When [DNS Server] is set to [Manual], set the IP addresses of the primary and secondary DNS servers.
<b>Primary Server</b>	Set the IP addresses of the primary DNS servers. <b>Value:</b> 128-bits address is expressed in eight groups consisting of four-digit hexadecimal digits. The groups are separated by colon (:).
<b>Secondary Server</b>	Set the IP addresses of the secondary DNS servers. <b>Value:</b> 128-bits address is expressed in eight groups consisting of four-digit hexadecimal digits. The groups are separated by colon (:).

 **IMPORTANT**

After changing the setting, restart the network or turn the machine OFF and then ON.

➔ [\[Restart Network\] \(8-51\)](#)

**[LAN Interface]**

Item	Description
LAN Interface	Specify the settings for the LAN interface to be used. <i>Value:</i> Auto, 10Base-Half, 10Base-Full, 100Base-Half, 100Base-Full, 1000BASE-T

**✔ IMPORTANT**

After changing the setting, restart the network or turn the machine OFF and then ON.

➔ [\[Restart Network\] \(8-51\)](#)

**[Bonjour]**

Menu Transition: [System Menu/Counter] key > [System/Network] > [Network] > [Bonjour]

Item	Description
Protocol Settings	Select whether to use Bonjour. <i>Value:</i> Off, On
Available Network (Wi-Fi Direct)	Select whether or not each network is enabled. <i>Value:</i> Disable, Enable
Available Network (Wi-Fi)	 <b>NOTE</b> This setting is displayed when the [Protocol Settings] setting is [On].
Available Network (Wired Network)	

**[IPSec]**



Menu Transition: [System Menu/Counter] key > [System/Network] > [Network] > [IPSec]





Item	Description
IPSec	Select whether to use IPSec. <i>Value:</i> Off, On

**[Protocol Settings]**





Menu Transition: [System Menu/Counter] key &gt; [System/Network] &gt; [Network] &gt; [Protocol Settings]





Configure the protocol settings.





Item	Description
<b>NetBEUI</b>	—
<b>Protocol Settings</b>	Selects whether to receive documents using NetBEUI.* <sup>1</sup> Value: Off, On
<b>Available Network (Wi-FiDirect)</b>	Select whether or not each network is enabled. Value: Disable, Enable
<b>Available Network (Wi-Fi)</b>	 <b>NOTE</b>
<b>Available Network (Wired Network)</b>	This setting is displayed when the [Protocol Settings] setting is [On].
<b>LPD</b>	—
<b>Protocol Settings</b>	Selects whether to receive documents using LPD.* <sup>1</sup> Value: Off, On
<b>Available Network (Wi-Fi Direct)</b>	Select whether or not each network is enabled. Value: Disable, Enable
<b>Available Network (Wi-Fi)</b>	 <b>NOTE</b>
<b>Available Network (Wired Network)</b>	This setting is displayed when the [Protocol Settings] setting is [On].
<b>SMTP (E-mail TX)</b>	Select whether to send E-mail using SMTP. Value: Off, On
<b>POP3 (E-mail RX)</b>	Select whether to receive E-mail using POP3. Value: Off, On
<b>FTP Client (Transmission)</b>	Select whether to send documents using FTP. To use the Thin Print protocol, set the protocol to [On]. The default port number is 21. Value: Off, On
<b>FTP Server (Reception)</b>	—
<b>Protocol Settings</b>	Select whether to receive documents using FTP.* <sup>1</sup> Value: Off, On
<b>Available Network (Wi-FiDirect)</b>	Select whether or not each network is enabled. Value: Disable, Enable
<b>Available Network (Wi-Fi)</b>	 <b>NOTE</b>
<b>Available Network (Wired Network)</b>	This setting is displayed when the [Protocol Settings] setting is [On].
<b>SMB Client (Transmission):</b>	Select whether to send documents using SMB. To use SMB, select [On] for this setting. The default port number is 445. Value: Off, On







Item	Description
<b>WSD Scan</b>	—
<b>Protocol Settings</b>	Select whether to use WSD Scan.* <sup>1</sup> Value: Off, On
<b>Available Network (Wi-Fi Direct)</b>	Select whether or not each network is enabled. Value: Disable, Enable
<b>Available Network (Wi-Fi)</b>	 <b>NOTE</b> This setting is displayed when the [Protocol Settings] setting is [On].
<b>Available Network (Wired Network)</b>	
<b>WSD Print</b>	—
<b>Protocol Settings</b>	Select whether or not each network is enabled.* <sup>1</sup> Value: Off, On
<b>Available Network (Wi-Fi Direct)</b>	Select whether or not each network is enabled. Value: Disable, Enable
<b>Available Network (Wi-Fi)</b>	 <b>NOTE</b> This setting is displayed when the [Protocol Settings] setting is [On].
<b>Available Network (Wired Network)</b>	
<b>DSM Scan</b>	Select whether to use DSM scan.* <sup>1</sup> Value: Off, On
<b>LDAP</b>	Select whether to use LDAP. Value: Off, On
<b>SNMP</b>	—
<b>Protocol Settings</b>	Select whether to communicate using SNMP.* <sup>1</sup> Value: Off, On
<b>Available Network (Wi-Fi Direct)</b>	Select whether or not each network is enabled. Value: Disable, Enable
<b>Available Network (Wi-Fi)</b>	 <b>NOTE</b> This setting is displayed when the [Protocol Settings] setting is [On].
<b>Available Network (Wired Network)</b>	
<b>SNMPv3</b>	—
<b>Protocol Settings</b>	Select whether to communicate using SNMPv3.* <sup>1</sup> Value: Off, On
<b>Available Network (Wi-Fi Direct)</b>	Select whether or not each network is enabled. Value: Disable, Enable
<b>Available Network (Wi-Fi)</b>	 <b>NOTE</b> This setting is displayed when the [Protocol Settings] setting is [On].
<b>Available Network (Wired Network)</b>	





Item	Description
<b>HTTP</b>	—
<b>Protocol Settings</b>	Select whether to communicate using HTTP.* <sup>1</sup> Value: Off, On
<b>Available Network (Wi-Fi Direct)</b>	Select whether or not each network is enabled. Value: Disable, Enable
<b>Available Network (Wi-Fi)</b>	 <b>NOTE</b> This setting is displayed when the [Protocol Settings] setting is [On].
<b>Available Network (Wired Network)</b>	
<b>HTTPS</b>	—
<b>Protocol Settings</b>	Select whether to communicate using HTTPS.* <sup>1*2</sup> Value: Off, On
<b>Available Network (Wi-Fi Direct)</b>	Select whether or not each network is enabled. Value: Disable, Enable
<b>Available Network (Wi-Fi)</b>	 <b>NOTE</b> This setting is displayed when the [Protocol Settings] setting is [On].
<b>Available Network (Wired Network)</b>	
<b>IPP</b>	—
<b>Protocol Settings</b>	Selects whether to receive documents using IPP. To use the IPP protocol, set [IPP] to [On], and set [SSL] to [Off]. In addition, select [Not Secure (IPP&IPPS)] for the security settings from Command Center RX.* <sup>1</sup> Value: Off, On  <b>NOTE</b> When selecting [On], it also requires a certificate for SSL. the default certificate is the self-certificate of the machine.
<b>Direct SMTP Port Number</b>	Specifies the port number used. The default port number is 631. Value: 1 to 32767  <b>NOTE</b> This setting is displayed when the [Protocol Settings] setting is [On].
<b>Available Network (Wi-Fi Direct)</b>	Select whether or not each network is enabled. Value: Disable, Enable
<b>Available Network (Wi-Fi)</b>	 <b>NOTE</b> This setting is displayed when the [Protocol Settings] setting is [On].
<b>Available Network (Wired Network)</b>	

Item	Description
<b>IPP over SSL</b>	<p>Select whether to use IPP to receive documents secured by SSL. To use the IPP protocol, set [IPP] and [SSL] to [On]. The default port number is 443. <sup>*1*2</sup></p> <p>Value: Off, On</p> <p> <b>NOTE</b></p> <p>When selecting [On], it also requires a certificate for SSL. the default certificate is the self-certificate of the machine.</p>
<b>Protocol Settings</b>	<p>Select whether to receive documents using Raw Port. <sup>*1</sup></p> <p>Value: Off, On</p>
<b>Direct SMTP Port Number</b>	<p>Specifies the port number used. The default port number is 4000.</p> <p>Value: 1 to 32767</p> <p> <b>NOTE</b></p> <p>This setting is displayed when the [Protocol Settings] setting is [On].</p>
<b>Available Network (Wi-Fi Direct)</b>	<p>Select whether or not each network is enabled.</p> <p>Value: Disable, Enable</p>
<b>Available Network (Wi-Fi)</b>	<p> <b>NOTE</b></p> <p>This setting is displayed when the [Protocol Settings] setting is [On].</p>
<b>Available Network (Wired Network)</b>	
<b>Raw Port</b>	—
<b>Protocol Settings</b>	<p>Select whether to receive documents using Raw Port. <sup>*1</sup></p> <p>Value: Off, On</p>
<b>Available Network (Wi-Fi Direct)</b>	<p>Select whether or not each network is enabled.</p> <p>Value: Disable, Enable</p>
<b>Available Network (Wi-Fi)</b>	<p> <b>NOTE</b></p> <p>This setting is displayed when the [Protocol Settings] setting is [On].</p>
<b>Available Network (Wired Network)</b>	

Item	Description
<b>ThinPrint</b>	—
<b>Protocol Settings</b>	<p>Select whether to use ThinPrint. To use the Thin Print protocol, set the protocol to [On].  Value: Off, On</p> <p> <b>NOTE</b>  This function can only be used when the optional UG-33 is installed.</p>
<b>Direct SMTP Port Number</b>	<p>Specifies the port number used. The default port number is 4000.  Value: 1 to 32767</p> <p> <b>NOTE</b>  This setting is displayed when the [Protocol Settings] setting is [On].</p>
<b>Thin Print over SSL</b>	<p>To use the Thin Print over SSL protocol, set [Thin Print Over SSL] and [SSL] to [On].  Value: Off, On</p> <p> <b>NOTE</b>  When selecting [On], it also requires a certificate for SSL. The default certificate is the self-certificate of the machine.</p>
<b>Available Network (Wi-FiDirect)</b>	<p>Select whether or not each network is enabled.  Value: Disable, Enable</p>
<b>Available Network (Wi-Fi)</b>	<p> <b>NOTE</b></p>
<b>Available Network (Wired Network)</b>	<p>This setting is displayed when the [Protocol Settings] setting is [On].</p>

Item	Description
<b>Enhanced WSD</b> <b>Protocol Settings</b> <b>Available Network (Wi-Fi Direct)</b> <b>Available Network (Wi-Fi)</b> <b>Available Network (Wired Network)</b>	<p>—</p> <p>Set whether to use our proprietary web services. <sup>*1*2</sup>  Value: Off, On</p> <p> <b>NOTE</b>  Selecting [Off] will disable the functionality of WIA, TWAIN and Network FAX drivers.</p> <p>Select whether or not each network is enabled.  Value: Disable, Enable</p> <p> <b>NOTE</b>  This setting is displayed when the [Protocol Settings] setting is [On].</p>
<b>Enhanced WSD over SSL</b> <b>Protocol Settings</b> <b>Available Network (Wi-Fi Direct)</b> <b>Available Network (Wi-Fi)</b> <b>Available Network (Wired Network)</b>	<p>—</p> <p>Set whether to use our proprietary web services over SSL. <sup>*1*2</sup>  Value: Off, On</p> <p> <b>NOTE</b>  Selecting [Off] will disable the functionality of WIA, TWAIN and Network FAX drivers.  When selecting [On], it also requires a certificate for SSL. the default certificate is the self-certificate of the machine.</p> <p>Select whether or not each network is enabled.  Value: Disable, Enable</p> <p> <b>NOTE</b>  This function is displayed when [Protocol Settings] is set to [On].</p>
<b>5eSCL</b> <b>Protocol Settings</b> <b>Available Network (Wi-Fi Direct)</b> <b>Available Network (Wi-Fi)</b> <b>Available Network (Wired Network)</b>	<p>Selects whether to receive scanned documents using eSCL. <sup>*1</sup>  Value: Off, On</p> <p>Set whether to use our proprietary web services over SSL. <sup>*1*2</sup>  Value: Off, On</p> <p> <b>NOTE</b>  When selecting [On], it also requires a certificate for SSL. The default certificate is the self-certificate of the machine.</p> <p>Select whether or not each network is enabled.  Value: Disable, Enable</p> <p> <b>NOTE</b>  This setting is displayed when the [Protocol Settings] setting is [On].</p>

Item	Description
<b>eSCL over SSL</b>	Selects whether to receive scanned documents using eSCL over SSL. * 1*2 Value: Off, On
<b>Protocol Settings</b>	Set whether to use our proprietary web services over SSL. * 1*2 Value: Off, On  <b>NOTE</b> When selecting [On], it also requires a certificate for SSL. the default certificate is the self-certificate of the machine.
<b>Available Network (Wi-FiDirect)</b>	Select whether or not each network is enabled. Value: Disable, Enable
<b>Available Network (Wi-Fi)</b>	 <b>NOTE</b>
<b>Available Network (Wired Network)</b>	This setting is displayed when the [Protocol Settings] setting is [On].

\*1 The setting will be changed after restarting the device or network.

\*2 Use Security Settings to select [On] for [SSL].

## [Security Settings]

Menu Transition: [System Menu/Counter] key > [System/Network] > [Network] > [Security Settings]

Item	Description
<b>SSL</b>	Select whether to use SSL for communication. Value: Off, On
<b>IPP Security</b>	Select the IPP security level. This setup is available when SSL is [On]. Value: IPP/IPP over SSL, IPPoverSSL only
<b>HTTP Security</b>	Select the HTTP security level. This setup is available when SSL is [On]. Value: HTTP/HTTPS, HTTPS Only
<b>SMTP Security</b>	Select the communication protocol in accordance with the types of security supported by the SMTP server. This setting is available when the [SMTP] setting is [On]. Value: Off, SSL/TLS, STARTTLS
<b>POP3 Security (User 1)</b>	Select the communication protocol in accordance with the types of security supported by the POP3 server. This setting is available when [POP3] is [On]. Value: Off, SSL/TLS, STARTTLS
<b>POP3 Security (User 2)</b>	
<b>POP3 Security (User 3)</b>	

## [Ping]

Menu Transition: [System Menu/Counter] key > [System/Network] > [Network] > [Ping]

Item	Description
<b>Ping</b>	Checks if communication with the destination by entering the host name or IP address of the destination is possible.  <b>NOTE</b> If [Network Interface (Send)] is set to [Optional NIC], this item is not displayed.

**[Restart Network]**

Menu Transition: [System Menu/Counter] key &gt; [System/Network] &gt; [Network] &gt; [Restart Network]

Item	Description
Restart Network	Restarts the network.

**[Proxy]**

Menu Transition: [System Menu/Counter] key &gt; [System/Network] &gt; [Network] &gt; [Proxy]

Item	Description
<b>Proxy</b>	Set the proxy for connection to the Internet from an application. <i>Value:</i> Off, On
<b>Use Same Proxy</b>	Set whether the same proxy server is used for all protocols. <i>Value:</i> Off, On
<b>HTTP Proxy Server</b>	Set a proxy server (HTTP). <i>Value:</i> (Enter the proxy address and port number.)
<b>HTTPS Proxy Server</b>	Set a proxy server (HTTPS). This setup is available when "Use the Same Proxy Server for All Protocols" is [Off]. <i>Value:</i> (Enter the proxy address and port number.)
<b>No Proxy Domains</b>	Set domains for which no proxy is used. <i>Value:</i> (Enter the domain name.)

**[Optional Network]**

Menu Transition: [System Menu/Counter] key &gt; [System/Network] &gt; [Optional Network]

Configure settings for the optional Network Interface Kit.

**NOTE**

This menu is displayed when the optional Network Interface Kit (IB-50) or optional Wireless Interface Kit (IB-51) is installed.

**[Basic]**

Item	Description
<b>Host Name</b>	Check the host name of the machine. Host name can be changed from Command Center RX. ➔ <a href="#">Changing Device Information (2-44)</a>
<b>TCP/IP Setting</b>	For details on setting value. ➔ <a href="#">[TCP/IP Setting] (8-41)</a> ➔ <a href="#">[IPSec] (8-43)</a>
<b>NetWare</b>	Use NetWare to receive documents. ➔ Network Interface Kit Operation Guide Value: Off, On
<b>AppleTalk</b>	Selects whether to receive documents using AppleTalk.*1 Value: Off, On
<b>LAN Interface</b>	Select the LAN interface.*1 Value: Auto, 10Base-Half, 10Base-Full, 100Base-Half, 100Base-Full, 1000BASE-T  <b>NOTE</b> This function is displayed when the optional Network Interface Kit (IB-50) is installed.
<b>MAC Address Filter</b>	Select whether to use MAC Address Filter. ➔ Network Interface Kit Operation Guide Value: Off, On
<b>Restart Network</b>	Restarts the network card of the device.





\*1 The setting will be changed after the device or network is restarted.

**[Wireless Network]**

Configure settings for the optional Wireless Network Interface Kit.

 **NOTE**

This function is displayed when the optional Wireless Network Interface Kit (IB-51) is installed.

Item	Description
<b>Connection Status</b>	When the optional is installed, you can check the wireless LAN status.
<b>Quick Setup Wizard</b>	If the machine will connect to an access point that supports the automatic wireless network setup, connection settings can be configured by Quick Setup.
<b>Available Network</b>	Displays access points to which the machine can connect. Select a desired access point from the list.
<b>Push Button</b>	If the access point supports the push button method, wireless settings can be configured using the push button. This setting executes push button, and the connection is started by pressing the push button on the access point.   <b>NOTE</b> The push button method supports only the WPS.
<b>PIN Code Method (Device)</b>	Starts connection using the machine's PIN code. Enter the PIN code into the access point. The PIN code of the machine is automatically generated.
<b>PIN Code Method (Terminal)</b>	Starts connection using the PIN code of the access point. Enter the PIN code of the access point.
<b>Custom Setup</b>	The detailed settings for wireless LAN can be changed.
<b>Network Name (SSID)</b>	Set the SSID (Service Set Identifier) of the wireless LAN to which the machine connects.   <b>NOTE</b> An SSID can contain up to 32 characters.
<b>Connection Mode</b>	Set the connection mode. <b>Value:</b> Ad Hoc, Infrastructure   <b>NOTE</b> <ul style="list-style-type: none"> <li>• Ad Hoc: Directly communicates with the device without going through an access point. This method cannot be used to connect to two or more devices.</li> <li>• Infrastructure: Performs communication through an access point.</li> </ul>
<b>Channel</b>	Set channel. Use [-] / [+] or the numeric keys to enter a number. <b>Value:</b> 1 to 11
<b>Network Authentication</b>	Select network authentication type. To select other options, open the device home page from a computer. <b>Value:</b> Open System, Shared Key, WPA-PSK* <sup>1</sup> , WPA2-PSK* <sup>1</sup>
<b>Encrypt</b>	Select encryption method. If the option other than [Disable] is selected, enter the WEP key or the Preshared key. The setting values vary depending on the Network Authentication setting. Select [Data Encryption]. When Network Authentication is set to [Open] or [Shared] <b>Value:</b> Disable, WEP When Network Authentication is set to [WPA-PSK] or [WPA2-PSK] <b>Value:</b> TKIP* <sup>2</sup> , AES, Auto* <sup>2</sup> , Pre-shared Key   <b>NOTE</b> <ul style="list-style-type: none"> <li>• If [WEP] is selected, enter the WEP key. A WEP key can contain up to 26 characters.</li> <li>• If [TKIP], [AES] or [Auto] is selected, enter the Preshared key. Enter the value in 8 to 64 characters.</li> </ul>

\*1 Not displayed if [Ad Hoc] is selected for [Connection Mode].

\*2 Not displayed if [WPA2-PSK] was selected for [Network Authentication].



**[Primary Network (Client)]**

Menu Transition: [System Menu/Counter] key &gt; [System/Network] &gt; [Primary Network (Client)]

 **NOTE**

This function is displayed when the optional Network Interface Kit (IB-50) or Wireless Network Interface Kit (IB-36 or IB-51) is installed.

The Wireless Network Interface Kit (IB-36) is an option for some models. Contact your dealer or our sales or service representatives for detail.



➔ [IB-36 <Wireless Network Interface Kit> \(12-3\)](#)

Item	Description
<b>Primary Network (Client)</b>	<p>This selects the network interface to be used when this machine is connected with a sending device operating as a client or with an external Address Book.</p> <p><b>Value:</b> Wi-Fi, Wired Network, Optional Network</p> <p> <b>NOTE</b></p> <ul style="list-style-type: none"> <li>• [Wi-Fi] is displayed when the Wireless Network Interface Kit (IB-36) is installed.</li> <li>• [Optional Network] is displayed when the optional Network Interface Kit (IB-50) or Wireless Network Interface Kit (IB-51) is installed.</li> <li>• For the e-mail settings, you need to configure the equipped network interface and the optional network interface separately.</li> </ul>

**[Interface Block Setting]**

Menu Transition: [System Menu/Counter] key &gt; [System/Network] &gt; [Interface Block Setting]

This allows you to protect this machine by blocking the interface with external devices such as USB hosts or optional interfaces.

Item	Description
<b>USB Host</b>	<p>This locks and protects the USB port (USB host).</p> <p><b>Value:</b> Unblock, Block</p>
<b>USB Device</b>	<p>This locks and protects the USB interface connector (USB Device).</p> <p><b>Value:</b> Unblock, Block</p>
<b>USB Storage</b>	<p>This locks and protects the USB memory slot.</p> <p><b>Value:</b> Unblock, Block</p> <p> <b>NOTE</b></p> <p>This function is available when USB Host is set to [Unblock].</p>
<b>Optional Interface 1</b>	<p>This locks and protects the optional interface slots.</p> <p><b>Value:</b> Unblock, Block</p>
<b>Optional Interface 2</b>	<p> <b>NOTE</b></p> <p>You can set this feature for each slot.</p>

 **IMPORTANT**

After changing the setting, restart the network or turn the machine OFF and then ON.

➔ [\[Restart\] \(8-55\)](#)

**[Bluetooth Settings]**

Menu Transition: [System Menu/Counter] key &gt; [System/Network] &gt; [Bluetooth Settings]

Item	Description
<b>Bluetooth Keyboard</b>	Use Bluetooth Keyboard <i>Value:</i> Unblock, Block
<b>Search Device</b>	Select the keyboard to be used.

**[Security Level]**

Menu Transition: [System Menu/Counter] key &gt; [System/Network] &gt; [Security Level]

Item	Description
<b>Security Level</b>	Specify the security level. <i>Value:</i> Low: This mode is used during maintenance. Do not use normally. High: This is the security setting we recommend. Use this setting normally. Very High: In addition to [High] setting, this setting disables the machine settings to be changed from external command.   <b>NOTE</b> The settings of this function can be configured by a user logged in with administrator privileges. <a href="#">➔ Adding a User (Local User List) (9-7)</a>

**[Optional Memory]**

Menu Transition: [System Menu/Counter] key &gt; [System/Network] &gt; [Optional Memory]

Item	Description
<b>Optional Memory</b>	When optional memory is installed, you can select a memory allocation pattern in accordance with specific needs. <i>Value:</i> Printer Priority, Standard, Copy Priority

**[Restart]**

Menu Transition: [System Menu/Counter] key &gt; [System/Network] &gt; [Restart]

Item	Description
<b>Restart</b>	Restart the CPU without turning the main power switch off. Use this to deal with any unstable operation by the machine. (Same as the computer restart.)

## [RAM Disk]

Menu Transition: [System Menu/Counter] key > [System/Network] > [RAM Disk Setting]

 **NOTE**

This function is displayed when an optional SSD is installed.

Item	Description
<b>RAM Disk Setting</b>	This creates a RAM disk and specifies its capacity. Creating a RAM disk enables printing of print data from the Job Box. <b>Value</b> RAM Disk Setting: Off, On Ram Disk Size: The size setting range depends on the size of the installed memory and option memory usage settings.

 **IMPORTANT**





**After changing the setting, restart the network or turn the machine OFF and then ON.**

➔ [\[Restart\] \(8-55\)](#)

**[Data Security]**

Menu Transition: [System Menu/Counter] key &gt; [System/Network] &gt; [Data Security]

Configure settings for data stored in the SSD.

Item	Description
<b>SSD Initialization</b>	<p>This changes security function settings.</p> <p> <b>NOTE</b></p> <ul style="list-style-type: none"> <li>• This function is displayed when the SSD is installed and the optional Data Security Kit is activated.</li> <li>• Input of the security password is required to change security function settings. The initial setting for the Security Password is "000000".</li> </ul>
<b>Security Password</b>	<p>You can customize the security password so that only the administrator can use the security kit.</p> <p>Enter a password that uses six to 16 alphanumeric characters and symbols.</p> <p>You will need to enter the password again for confirmation.</p> <p> <b>IMPORTANT</b></p> <p>Avoid any easy-to-guess numbers for the security password (e.g. 11111111 or 12345678).</p>
<b>System Initialization</b>	<p>This can be used to delete all the data stored in the SSD. Overwrite all the data stored in the SSD when disposing of the machine.</p> <p> <b>IMPORTANT</b></p> <p>If you accidentally turn the power switch off during initialization, the SSD might possibly crash or initialization might fail.</p> <p> <b>NOTE</b></p> <p>If you accidentally turn off power during initialization, turn it back on. Initialization will restart automatically.</p>
<b>Data Sanitization</b>	<p>Return the following information registered in the machine to the factory defaults.</p> <ul style="list-style-type: none"> <li>• Address Book</li> <li>• Favorites</li> <li>• System settings</li> <li>• Fax transmission and reception / forwarding data</li> <li>• Transmission histories</li> <li>• Data saved in Custom Box</li> <li>• Optional applications</li> </ul> <p> <b>NOTE</b></p> <ul style="list-style-type: none"> <li>• Print a status page and make sure to completely delete security data. <ul style="list-style-type: none"> <li>➔ <a href="#">[Report] (8-5)</a></li> </ul> </li> <li>• Once in progress, the processing cannot canceled.</li> <li>• Before executing this function, disconnect modular, network, and other cables.</li> <li>• Do not turn off the main power switch while sanitizing the data. If the main power is turned off during data erasing, erasing will be executed automatically when the power is restored, however, complete erasure cannot be guaranteed.</li> </ul>

**Information erased**

Category	Data erased
<b>Devices/jobs</b>	<ul style="list-style-type: none"> <li>• Job settings configured by users</li> <li>• Network settings</li> <li>• Image data saved in Document Box, etc.</li> <li>• Data registered in One Touch keys</li> <li>• Job histories</li> <li>• User information (user list, address book, Document Box registered by the user, etc.)</li> <li>• Account information of job accounting</li> <li>• Network certificates</li> <li>• Initial screen on machine changed by service representative</li> </ul>
<b>FAX*1</b>	<ul style="list-style-type: none"> <li>• Fax settings configured by users</li> <li>• Communication restriction settings</li> <li>• Encryption key settings</li> <li>• Transmission histories</li> <li>• Scheduled Job</li> <li>• Conditional reception/forwarding settings</li> </ul>
<b>Application</b>	<ul style="list-style-type: none"> <li>• Application/program added by a user or service representative</li> <li>• Trial functions</li> </ul>

\*1 Only when the optional fax kit is installed.

**[OCR Dictionary Installation]**

Menu Transition: [System Menu/Counter] key > [System/Network] > [OCR Dictionary Installation]

Item	Display
<b>OCR Dictionary Installation</b>	<p>Install the OCR Dictionary.</p> <p> <b>NOTE</b></p> <ul style="list-style-type: none"> <li>• For information on dictionary data, consult your Service Representative.</li> <li>• To install the OCR dictionary, an SSD or SD/SDHC memory card must be inserted.</li> <li>• If both an SSD and an SD/SDHC memory card are inserted, the OCR dictionary will be installed on the SSD.</li> <li>• If you will use an SD/SDHC memory card, a 32 GB SDHC memory card is recommended.</li> </ul>

**[Optional Function]**

Menu Transition: [System Menu/Counter] key > [System/Network] > [Optional Function]

Item	Display
<b>Optional Function</b>	<p>You can use the optional applications installed on this machine.</p> <p>➔ <a href="#">Optional Applications 12-11</a></p>



**[Remote Services Settings]**

Menu Transition: [System Menu/Counter] key &gt; [System/Network] &gt; [Remote Services Settings]

Item	Description
<b>Remote Services Settings</b>	Select whether to use Remote Services Settings. Value: Off, On

**[FAX Server Settings]**

Menu Transition: [System Menu/Counter] key &gt; [System/Network] &gt; [FAX Server Settings]

Item	Description
<b>FAX Server</b>	Select whether to use FAX Server. Value: On, Off
<b>Address Setting</b>	This specifies a prefix, suffix, and domain name to be attached to a destination.  <b>NOTE</b> For information about the fax server, contact the fax server administrator.
<b>File Format</b>	Set the default type of the files. Value: PDF, TIFF, XPS
<b>Address Book Defaults</b>	This specifies the External Address Book to be used.  <b>NOTE</b> <ul style="list-style-type: none"> <li>• This is displayed when [On] is selected by the fax server.</li> <li>• This is not displayed if the External Address Book setting is not configured.</li> </ul> <a href="#">▶ Command Center RX User Guide</a>

**[NFC]**





Menu Transition: [System Menu/Counter] key &gt; [System/Network] &gt; [NFC]

Item	Description
<b>NFC</b>	Uses NFC (Near Field Communication). Value: Off, On

# [Date/Timer/Energy Saver]

Menu Transition: [System Menu / Counter] key > [Date/Timer/Energy Saver] Configure date and time settings.

Item	Description
<b>Date/Time</b>	<p>Set the date and time for the location where you use the machine. If you perform Send as E-mail, the date and time set here will be displayed on the header.</p> <p><b>Value:</b> Year (2000 to 2037), Month (1 to 12), Day (1 to 31), Hour (00 to 23), Minute (00 to 59), Second (00 to 59)</p> <p>➔ <a href="#">Setting Date and Time (2-12)</a></p> <p> <b>NOTE</b></p> <p>If you change the date/time while using the trial version of an application, you will no longer be able to use the application.</p>
<b>Date Format</b>	<p>Select the display format of year, month, and date. The year is displayed in Western notation.</p> <p><b>Value:</b> MM/DD/YYYY, DD/MM/YYYY, YYYY/MM/DD</p>
<b>Time Zone</b>	<p>Set the time difference from GMT. Choose the nearest listed location from the list. If you select a region that utilizes summer time, configure settings for summer time.</p> <p>➔ <a href="#">Setting Date and Time (2-12)</a></p>
<b>Auto Panel Reset</b>	<p>If no jobs are run for a certain period of time, automatically reset settings and return to the default setting. Select to use Auto Panel Reset or not.</p> <p><b>Value:</b> Off, On</p> <p> <b>NOTE</b></p> <p>Refer to the following for the time until reset.</p> <p>➔ <a href="#">Panel Reset Timer (8-60)</a></p>
<b>Panel Reset Timer</b>	<p>If you select [On] for Auto Panel Reset, set the amount of time to wait before Auto Panel Reset.</p> <p><b>Value:</b> 5 to 495 seconds (in 5 second increments)</p> <p> <b>NOTE</b></p> <p>This function is displayed when [Auto Panel Reset] is set to [On].</p>
<b>Low Power Timer</b>	<p>Set amount of time before entering the Low Power mode.</p> <p><b>Value</b></p> <p>For Europe: 1 to 60 minutes (1 minute increments)            Except for Europe 1 to 240 minutes (1 minute increments)</p> <p> <b>NOTE</b></p> <p>➔ <a href="#">Low Power Mode (2-22)</a></p>
<b>Sleep Rules (models for Europe)<sup>*1</sup></b>	<p>Select whether to use the Sleep mode for the following functions individually:</p> <ul style="list-style-type: none"> <li>• Card Reader<sup>*2</sup></li> <li>• FAX<sup>*3</sup></li> <li>• Application</li> </ul> <p><b>Value:</b> Off, On</p> <p> <b>NOTE</b></p> <p>If the sleep condition is not turned off, the ID card cannot be recognized.</p>

Item	Description
<p><b>Sleep Level (models except for Europe)*<sup>1</sup></b></p>	<p>Select the sleep level. Set the Energy Saver mode to reduce power consumption even more than normal Sleep mode. <b>Value:</b> Quick Recovery, Energy Saver</p> <p> <b>NOTE</b> This function will not be displayed when the optional Network Interface Kit is installed.</p>
<p><b>Sleep Rules</b></p>	<p>Select whether to use the Energy Saver mode for the following functions individually:</p> <ul style="list-style-type: none"> <li>• Card Reader*<sup>2</sup></li> <li>• Application</li> </ul> <p><b>Value:</b> Off, On</p> <p> <b>NOTE</b> When the machine has entered sleep mode with Energy Saver setting, it does not wake from sleep mode when it receives print data from a PC connected by USB cable. Also, the ID card cannot be recognized.</p>
<p><b>Sleep Timer</b></p>	<p>Set amount of time before entering Sleep. <b>Value</b> ECOSYS M8124cidn for Europe: 1 to 60 minutes (1 minute increments) ECOSYS M8130cidn for Europe: 1 to 60 minutes (1 minute increments) Except for Europe 1 to 240 minutes (1 minute increments)</p>
<p><b>Energy Saver Recovery Level</b></p>	<p>Select the method of recovery from energy saver. <b>Value</b> Full Recovery: This mode enables the use of all functions immediately. However, this mode saves less energy. Normal Recovery: In this mode, you can select the method from the following: enabling the use of all functions immediately or enabling the use of desired functions only. If you want to use all functions immediately, select the [Energy Saver] key to execute recovery. Power Saving Recovery: This mode enables the use of desired functions only. This mode saves energy most effectively.</p>
<p><b>Auto Error Clear</b></p>	<p>If an error occurs during processing, processing stops to wait for the next step to be taken by the user. In the Auto Error Clear mode, automatically clear the error after a set amount of time elapses. <b>Value:</b> Off, On</p> <p> <b>NOTE</b> For setting the automatic error recovery time, refer to the following item.</p>
<p><b>Error Clear Timer</b></p>	<p>If you select [On] for Auto Error Clear, set the amount of time to wait before automatically clearing errors. <b>Value:</b> 5 to 495 seconds (in 5 second increments)</p> <p> <b>NOTE</b> This function is displayed when [Auto Error Clear] is set to [On].</p>



Item	Description
<b>Interrupt Clear Timer</b>	Set the period after which the machine reverts to Normal mode when it has been set to Interrupt Copy mode and then left unused. <b>Value:</b> 5 to 495 seconds (in 5 second increments)
<b>Unusable Time</b> <sup>*3</sup>	▶ FAX Operation Guide
<b>Ping Timeout</b>	Set the time until timeout occurs when [Ping] is executed in [System/Network]. <b>Value:</b> 1 to 30 seconds (in 1 second increments)

\*1 This function will not be displayed when the optional Network Interface Kit is installed.

\*2 Displayed when the optional Card Authentication Kit is activated.



\*3 Displayed only when the optional fax function is installed.

# [Adjustment/Maintenance]

Menu Transition: [System Menu / Counter] key > [Adjustment/Maintenance]

Adjust printing quality and conduct machine maintenance.

Item	Description
<b>Density Adjustment</b>	Adjust density.
<b>Copy</b>	Adjust copy density. Adjustment can be made in 7 levels. <b>Value:</b> -3 (Lighter), -2, -1, 0 (Normal), +1, +2, +3 (Darker)
<b>Send/Box</b>	Adjust scan density when sending or storing the data in Document Box. Adjustment can be made in 7 levels. <b>Value:</b> -3 (Lighter), -2, -1, 0 (Normal), +1, +2, +3 (Darker)
<b>FAX<sup>*1</sup></b>	➔ FAX Operation Guide
<b>Sharpness Adjustment</b>	Adjusts the sharpness of image outlines.
<b>Copy</b>	Sharpen or blur overall image outlines during copying. Adjustment can be made in 7 levels. <b>Value:</b> -3 (Blur), -2, -1, 0, +1, +2, +3 (Sharpen)
<b>Send/Box</b>	Sharpen or blur overall image outlines when sending the scanned images to the specified destination or storing them in the Document Box. Adjustment can be made in 7 levels. <b>Value:</b> -3 (Blur), -2, -1, 0, +1, +2, +3 (Sharpen)
<b>Contrast</b>	You can increase or decrease the overall contrast.
<b>Copy</b>	Increases or decreases the overall contrast of copies. <b>Value:</b> -3 (Lower), -2, -1, 0 (Normal), +1, +2, +3 (Higher)
<b>Send/Box</b>	Increases or decreases the overall contrast when documents are sent or saved in a document box. <b>Value:</b> -3 (Lower), -2, -1, 0 (Normal), +1, +2, +3 (Higher)
<b>Background Density Adj.</b>	Darkens or lightens overall background density adjustment.
<b>Copy (Auto)</b>	Darkens or lightens overall background density adjustment during copying. Adjustment can be made in 7 levels. <b>Value:</b> -3 (Lighter), -2, -1, 0 (Normal), +1, +2, +3 (Darker)
<b>Send/Box (Auto)</b>	Darkens or lightens overall background density when sending images or storing them in the Document Box. Adjustment can be made in 7 levels. <b>Value:</b> -3 (Lighter), -2, -1, 0 (Normal), +1, +2, +3 (Darker)
<b>Toner Save Level (EcoPrint)</b>	Select the default Toner Save Level (EcoPrint).
<b>Copy</b>	Select the default Toner Save Level (EcoPrint) at the time of copying. <b>Value:</b> 1 (Low) to 5 (High) Raising the level reduces toner consumption, but image quality falls.
<b>Printer</b>	Select the default Toner Save Level (EcoPrint) at the time of use of the printer. <b>Value:</b> 1 (Low) to 5 (High) Raising the level reduces toner consumption, but image quality falls.
<b>Auto Color Correction</b>	This setting allows you to adjust the detection level used by the machine to determine whether the original is color or black and white in Auto Color Selection Mode. Setting a lower value will result in more originals being identified as color, while a larger value will tend to increase the number of originals being identified as black and white. <b>Value:</b> 1 (Color), 2, 3, 4, 5 (B & W)

Item	Description
<b>Correcting Black Line</b>	Correct fine lines (streaks caused by contamination), which may appear on the image, when the document processor is used. <b>Value:</b> Off, On
<b>Display Brightness</b>	Set the brightness of the touch panel. <b>Value:</b> 1 (Darker), 2, 3, 4, 5 (Lighter)
<b>Color Registration</b>	When first installing the machine or moving it to a new location, color drift during printing may occur. Use this function to correct the color position of each of cyan, magenta and yellow to resolve color drift. ➔ <a href="#">Color Registration (11-25)</a>
<b>Tone Curve Adjustment</b>	After prolonged use, or from the effects of surrounding temperature or humidity, the printed output tone may differ from the original. Perform this function to ensure consistency with the original tone. ➔ <a href="#">Tone Curve Adjustment (11-30)</a>
<b>Drum Refresh</b>	Remove image blur and white dots from the printout. It takes about 1 to 2 minutes. The time required may vary depending on the operating environment. ➔ <a href="#">Drum Refresh (11-32)</a>  <b>NOTE</b> Drum Refresh cannot be performed while printing. Execute Drum Refresh after the printing is done.
<b>Auto Drum Refresh</b>	Set the execution duration of auto drum refresh. <b>Value:</b> Short: Shortens the duration of execution of auto drum refresh. Standard: Uses the standard time of execution of auto drum refresh.
<b>Calibration</b>	Adjust color drift and hue of printed images. ➔ <a href="#">Calibration (11-30)</a>  <b>NOTE</b> Perform Color Registration when the color drift is not adjusted even after performing Calibration, and perform Gray Adjust if the color hue is not improved.
<b>Laser Scanner Cleaning</b>	Remove vertical white lines from the printout. ➔ <a href="#">Perform the laser scanner cleaning. (11-30)</a>
<b>Service Settings</b>	Performs maintenance and inspection of the machine. This menu is primarily used by service personnel for maintenance.

# 9 User Authentication and Accounting (User Login, Job Accounting)

This chapter explains the following topics:

Overview of User Login Administration .....	9-3
Managing the Job Account from PC .....	9-4
Enabling User Login Administration .....	9-5
Setting User Login Administration .....	9-6
Authentication Security .....	9-6
Adding a User (Local User List) .....	9-7
Change the user properties .....	9-11
Managing User Printing .....	9-13
Managing the Users to Use TWAIN for Scanning .....	9-14
Managing the Users to Use WIA for Scanning .....	9-15
Managing the Users to Send Faxes from a PC .....	9-16
Local Authorization Settings .....	9-17
Group Authorization Settings .....	9-17
Guest Authorization Set .....	9-20
Obtain NW User Property .....	9-22
Simple Login Settings .....	9-23
ID Card Settings .....	9-26
PIN Code Authorization .....	9-26
Using User Login Administration .....	9-28
Login/Logout .....	9-28
User Login/Job Accounting .....	9-29
Enabling Job Accounting .....	9-30
Job Accounting Access .....	9-30
Setting an account. [Local] .....	9-31
Adding an Account [Accounting List] .....	9-31
Restricting the Use of the Machine .....	9-32
Setting Processing When the Limit is Exceeded .....	9-33
Editing an Account .....	9-33
Deleting an Account .....	9-34
Managing the Account Printing Status .....	9-34
Job Accounting for Scan Using TWAIN .....	9-35
Job Accounting for Scan Using WIA .....	9-36
Job Accounting for the FAX Transmitted from a Computer .....	9-37
Using JOB Accounting .....	9-39
Configuring the Job Accounting Default Settings .....	9-39
Counting by Paper Size .....	9-40
Counting the Number of Pages Printed .....	9-41
Print Accounting Report .....	9-43
Setting the Counting Method for the Copier/Printer .....	9-44
Login/Logout (Job Accounting) .....	9-44
Setting Unknown Number Processing Method .....	9-46
Setting Unknown ID Job Processing .....	9-46

Registering User Property for an Unknown ID User ..... 9-46

## Overview of User Login Administration

User login administration specifies how the user access is administered on this machine. Enter a correct login user name and password for user authentication to login.

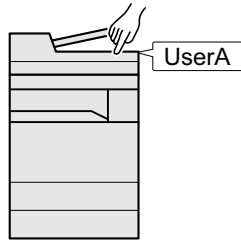

- 1 Enable User Login Administration ([9-5](#)).
- 2 Set the user ([9-6](#)).
- 3 Enter the login user name and password and execute the job ([3-14](#)).

Access are in three levels - "User", "Administrator", and "Machine Administrator". The security levels can be modified only by the "Machine Administrator".

## Managing the Job Account from PC

In addition to the above settings, the following are necessary to manage the job account from PC.

To Manage the Users to Print from PCs

Printer driver settings are necessary to manage the users that print on the machine from PCs.

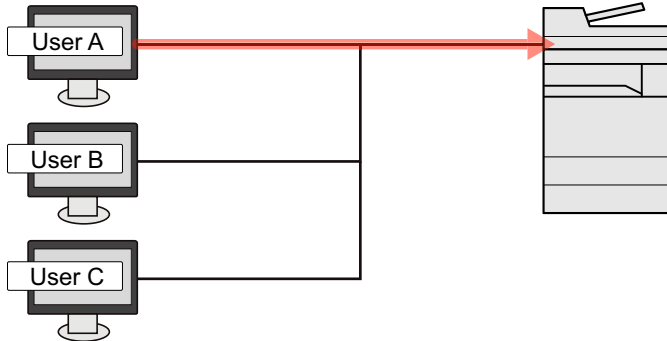

- 1 Set the User Login Administration on the printer driver ([9-13](#)).
- 2 Print the document.

### To Manage the Users to Use TWAIN for Scanning

TWAIN driver settings on the PC are necessary to manage the users that use TWAIN for scanning.

➔ [Managing the Users to Use TWAIN for Scanning \(9-14\)](#)

### To Manage the Users to Use WIA for Scanning

WIA driver settings on the PC are necessary to manage the users that use WIA for scanning.

➔ [Managing the Users to Use WIA for Scanning \(9-15\)](#)

### To Manage the Users to Send Faxes from a PC

FAX driver settings on the PC are necessary to manage the users that send faxes from a PC.

➔ [Managing the Users to Send Faxes from a PC \(9-16\)](#)

The optional FAX Kit is required in order to make use of fax functionality.

# Enabling User Login Administration

Enable User accounting. Select the following authentication methods:

Item	Description
<b>Local Authentication</b>	User authentication based on user properties on the local user list stored in the machine.
<b>Network Authentication</b>	User authentication based on Authentication Server. Use a user property stored in Authentication Server to access the network authentication login page.

## 1 Display the screen.

- 1 [System Menu / Counter] key > [User Login/Job Accounting]

### NOTE

If the user authentication screen appears, enter your login user name and login password and select [Login]. For this, you need to log in with administrator privileges.

The factory default login user name and login password are set as shown below.

Login User Name

ECOSYS M8124cidn:2400, ECOSYS M8130cidn:3000

Login Password

ECOSYS M8124cidn:2400, ECOSYS M8130cidn:3000

- 2 [User Login Setting] > [User Login]

## 2 Configure the settings.

- 1 Select [Local Authentication] or [Network Authentication].

Select [Off] to disable user login administration.

If you select [Network Authentication], Select [NTLM], [Kerberos] or [Ext.] as the server type. Also, enter the host name (64 characters or less) and domain name (256 characters or less) for the Authentication Server.

When selecting [Ext.] as the server type, enter the port number.

### NOTE

Selecting [Domain Name] displays the domain registration list. Enter the domain name.

Up to 10 domain names can be registered.

- 2 "Do you want to add a new function to the home screen?" screen appears. To display a new function on the Home screen, select [Yes] and specify the position in which you want to display the icon of registered function.

➔ [Editing the Home Screen \(3-8\)](#)

### NOTE

If the login user name and password are rejected, check the following settings.

- Network Authentication setting of the machine
- User property of the Authentication Server
- Date and time setting of the machine and the Authentication Server

If you cannot login because of the setting of the machine, login with any administrator registered in the local user list and correct the settings.



# Setting User Login Administration

This registers, alters and deletes users and configures the settings for User Login Administration.

## Authentication Security

If user authentication is enabled, configure the user authentication settings.

### User Account Lockout Setting

You can prohibit the use of a user account if an incorrect password is entered repeatedly to login with that account.

#### 1 Display the screen.

- 1 [System Menu / Counter] key > [User Login/Job Accounting]

#### NOTE

If the user authentication screen appears, enter your login user name and login password and select [Login]. For this, you need to log in with administrator privileges.

The factory default login user name and login password are set as shown below.

Login User Name

ECOSYS M8124cidn:2400, ECOSYS M8130cidn:3000

Login Password

ECOSYS M8124cidn:2400, ECOSYS M8130cidn:3000

- 2 [User Login Settings] > [User Account Lockout Settings]

#### 2 Configure the settings.

The following settings can be set.

Item	Description
<b>Lockout</b>	Select whether or not account lockout policy is enabled. <b>Value:</b> Off, On
<b>Lockout Policy</b>	Specify the conditions and the extent to which the account lockout is applied. <b>Value:</b> Number of Retries until Locked: Specify the conditions and the extent to which the account lockout is applied. (1 to 10 times) Lockout Duration: Specify how long the account is to be locked out until it is unlocked. (1 to 60 minutes) Lockout Target: Specify the extent to which the account lockout is applied. You can select from [All] or [Remote Login Only]. Remote Login Only locks out all operations from outside the operation panel.
<b>Locked out Users List</b>	Displays a list of locked out users. You can unlock a user by selecting the user in the list, and selecting [Unlock].   <b>NOTE</b> This function is displayed when account lockout policy is enabled.

## Adding a User (Local User List)

This adds a new user.



### NOTE

- You can add up to 100 users (including the default login user name).
- By default, one of each default user with machine administrator rights and administrator privileges is already stored. Each user's properties are: Upper case and lower case letters are distinguished (case sensitive).

#### Machine Administrator

User Name: DeviceAdmin

Login User Name

ECOSYS M8124cidn:2400, ECOSYS M8130cidn:3000

Login Password

ECOSYS M8124cidn:2400, ECOSYS M8130cidn:3000

Access Level: Machine Administrator

#### Administrator

User Name: Admin

Login User Name: Admin

Login Password: Admin

Access Level: Administrator

It is recommended to periodically change the user name, login user name and login password regularly for your security.

### 1 Display the screen.

- 1 [System Menu / Counter] key > [User Login/Job Accounting]



### NOTE

If the user authentication screen appears, enter your login user name and login password and select [Login]. For this, you need to log in with administrator privileges.

The factory default login user name and login password are set as shown below.

Login User Name

ECOSYS M8124cidn:2400, ECOSYS M8130cidn:3000

Login Password

ECOSYS M8124cidn:2400, ECOSYS M8130cidn:3000

- 2 [User Login Settings] > [Local User List] > [ + ]

## 2 Enter the user information.

Select [Next >].

The table below explains the user information to be registered.

Item	Descriptions
<b>User Name</b>	Enter the name displayed on the user list (up to 32 characters).
<b>Login User Name</b>	Enter the login user name to login (up to 64 characters). The same login user name cannot be registered.
<b>Access Level</b>	Select "Administrator" or "User" for user access privileges.





### NOTE

For details on entering characters, refer to the following:

▶ [Character Entry Method \(12-13\)](#)

### 3 Check the user information.

Change or add information as needed.

Item	Descriptions
<b>User Name</b> <sup>*1</sup>	Enter the name displayed on the user list (up to 32 characters).
<b>Login User Name</b> <sup>*1</sup>	Enter the login user name to login (up to 64 characters). The same login user name cannot be registered.
<b>Login Password</b>	Enter the password to login (up to 64 characters). Reenter the same password for confirmation and select the [OK] key.
<b>Account Name</b>	<p>Add an account where the user belongs. The user, who registered his/her account name, can login without entering the account ID.</p> <p>➔ <a href="#">User Login/Job Accounting (9-29)</a></p> <p> <b>NOTE</b></p> <p>Select [<b>Name</b>] or [<b>ID</b>] from the "Sort" to sort the account list.</p> <p>Select [<b>Search(Name)</b>] or [<b>Search(ID)</b>] to search by account name or account ID.</p>
<b>E-mail Address</b>	The user can register his/her E-mail address. The registered address will be automatically selected for subsequent operations that need any E-mail function.
<b>Access Level</b> <sup>*1</sup>	Select "Administrator" or "User" for user access privileges.
<b>ID Card Information</b>	<p>Register ID card information.</p> <p>Place the ID card on the ID card reader, and select [<b>Read</b>].</p> <p> <b>NOTE</b></p> <p>This function is displayed when the optional ID Card Authentication Kit is activated.</p> <p>➔ <a href="#">Card Authentication Kit(B) &lt;Card Authentication Kit&gt; (12-3)</a></p>

\*1 Required items for user registration.

Item	Description
<b>My Panel</b>	You can register the language selection, initial screen, and shortcut settings for each user. Settings registered here can be applied simply by logging in.
<b>Local Authorization</b> *1	<p>Set usage authority for each user.</p> <p>The following restriction items are available:</p> <p><b>Printer:</b> Select whether or not to reject usage of print functions for the printer. The relevant print functions are as follows.</p> <ul style="list-style-type: none"> <li>• Printing from Document Box</li> <li>• Printing from removable memory</li> <li>• Printing from PC</li> </ul> <p><b>Printer (Full Color):</b> Select whether or not to reject usage of full-color print functions for the printer. The relevant print functions are as follows.</p> <ul style="list-style-type: none"> <li>• Printing from Document Box</li> <li>• Printing from removable memory</li> <li>• Printing from PC</li> </ul> <p><b>Copy:</b> Select whether or not to reject usage of copy functions.</p> <p><b>Copy (Full Color):</b> Select whether or not to reject usage of full-color copy functions.</p> <p><b>Duplex Restriction:</b> Select whether only duplex printing is allowed.</p> <p><b>Combine Restriction:</b> Specify whether only Combine is allowed.</p> <p><b>EcoPrint Restriction:</b> Specify whether only EcoPrint is allowed.</p> <p><b>Send:</b> Select whether or not to reject usage of the send functions.</p> <p><b>FAX Transmission</b>*2: Select whether or not to reject usage of the FAX transmissions.</p> <p><b>Storing in Box:</b> Select whether or not to reject usage of storing in the document boxes.</p> <p><b>Storing Restr. in Memory:</b> Select whether or not to reject usage of storing in the removable memory.</p>

\*1 Displayed when Local Authorization is enabled.

➔ [Local Authorization Settings \(9-17\)](#)

\*2 Displayed only on products with the fax function installed.

 **NOTE**

For details on entering characters, refer to the following:

➔ [Character Entry Method \(12-13\)](#)

If you selected [Send] in the Default Screen for "My Panel", select the screen to display from [Destination], [Address Book], or [Ext Address Book].

## 4 Select [Save].

A new user is added on the local user list.

### NOTE

If simple login is enabled, a confirmation screen appears when new registration is finished asking if you will configure simple login settings. To configure simple login settings, select [Yes]. If you select [No], you will return to the user list screen.

For the procedure for configuring simple login settings, refer to the following:

➔ [Simple Login Settings \(9-23\)](#)

## Change the user properties

User properties can be changed. Types of user properties that could be changed may be different depending on user access privilege.

### NOTE

To change the user information of the machine administrator, you must log in with machine administrator authority. You can only view user information if you log in as a regular user.

The factory default login user name and login password are set as shown below.

Login User Name

ECOSYS M8124cidn:2400, ECOSYS M8130cidn:3000

Login Password

ECOSYS M8124cidn:2400, ECOSYS M8130cidn:3000

### For a user with Administrator rights who logs in

User properties can be changed and users can be deleted. The items, which can be added, are all able to be changed.

## 1 Display the screen.

1 [System Menu / Counter] key > [User Login/Job Accounting]

### NOTE

If the user authentication screen appears, enter your login user name and login password and select [Login]. For this, you need to log in with administrator privileges.

The factory default login user name and login password are set as shown below.

Login User Name

ECOSYS M8124cidn:2400, ECOSYS M8130cidn:3000

Login Password

ECOSYS M8124cidn:2400, ECOSYS M8130cidn:3000

2 [User Login Settings] > [Local User List]

## 2 Change the user properties.

**Changing user properties**

- 1 Select [  ] for the user whose information you want to modify.

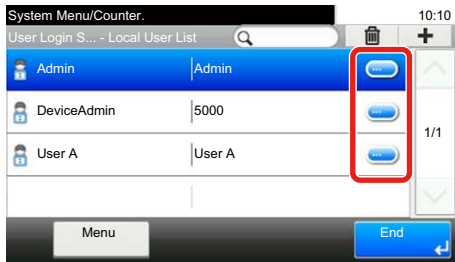

 **NOTE**

- To sort the user list, select [Menu] > [Sort (Name)] or [Sort (Login User Name)].
- Select [Menu] > [Search (Name)] or [Search (Login User Name)] to search by account name or account ID.

- 2 Refer to step 3 of "Adding a User (Local User List)" to change a user property.

➔ [Adding a User \(Local User List\) \(9-7\)](#)

- 3 [Save] > [Yes]

The user information is changed.

**Deleting a user**

- 1 Select the user to delete.

- 2 Select [  ] > [Yes].

The selected user will be deleted.

 **NOTE**

The default user with machine Administrator rights cannot be deleted.

**To change the user information of logged in user (User Property)**

These users can partially change their own user properties. The items can be changed are, "User Name", "Login Password", "E-mail Address", "Simple Login", and "My Panel".

Although "Login User Name", "Access Level", or "Account Name" cannot be changed, the users can check the present status.

- 1 **Display the screen.**





[System Menu / Counter] key > [User Property]

- 2 **Change the user properties.**

Change or add information as needed.

➔ [Adding a User \(Local User List\) \(9-7\)](#)

Item	Description
<b>User Name</b>	Changes the name shown on the user list. Up to 32 characters can be entered.
<b>Login User Name</b>	Displays the login user name that is entered at login.
<b>Login Password</b>	Changes the password that is entered at login. Up to 64 characters can be entered.
<b>Account Name</b>	Displays the department to which the user belongs.

Item	Description
<b>E-mail Address</b>	<p>Changes the user's e-mail address. Up to 128 characters can be entered.</p> <p> <b>NOTE</b> If the user logs in with user authority and [New Destination Entry] is set to [Prohibit], only the e-mail address can be checked.</p>
<b>Access Level</b>	<p>Displays the user's access level.</p>
<b>Authorization Rules</b>	<p>Displays the usage restriction that is set for the logged in user.</p> <p> <b>NOTE</b> This function appears when Local Authorization is set to [On], Group Authorization is set to [On], or Guest Authorization Setting is set to [On]. [Authorization Rules] shows the account name set for the logged in user and the usage restrictions that are set for that account. This function appears when job accounting is set to [On]. For information on job accounting, refer to the following: <a href="#">▶ Enabling Job Accounting (9-30)</a></p>
<b>Simple Login</b>	<p>When simple login is enabled, changes associated settings.</p> <p> <b>NOTE</b> This function does not appear when Simple Login is set to [Off] or the user is not registered in Simple Login.</p>
<b>ID Card Information</b>	<p>Displays the ID card information of the logged in user.</p> <p> <b>NOTE</b> This function is displayed when the optional ID Card Authentication Kit is activated. <a href="#">▶ Card Authentication Kit(B) &lt;Card Authentication Kit&gt; (12-3)</a> This function does not appear when the server type is set to [Ext.] in Network Authentication, and logged in with the user account certificated in the server specified as the [Ext.] server type.</p>
<b>My Panel</b>	<p>Register the language and default screen for each user. Once registered, the setting will be applied simply by login.</p>

### 3 Select [Save].

The user information is changed.

## Managing User Printing

To manage the users that print on this machine from a PC, the following settings are necessary in the printer driver. Instructions are based on interface elements as they appear in Windows 8.1.

### 1 Display the screen.

- 1 From the desktop, click [Settings] in charms, [Control Panel], and then [Devices and Printers].

 **NOTE**

In Windows 7, click the [Start] button in Windows, and then click [Devices and Printers].

- 2 Right-click the printer driver icon of the machine, and click the [Printer properties] menu of the printer driver.
- 3 Click [Administrator] on the [Device Settings] tab.



## 2 Configure the settings.

- 1 Select [User Login] on the [User Login] tab.

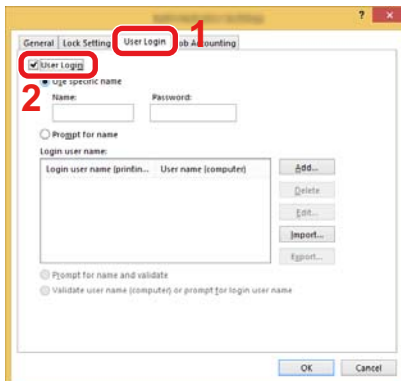

- 2 Set the User Login Administration.

[Use specific name]: This option can be used to specify a user name and password to use the same User login for every print job. If this option is selected, the user does not have to type the name and password for each print job.

[Prompt for name]: A screen for entering the user name and password will be displayed when attempting a printing. The user name and password must be entered each time a printing is attempted.

[Prompt for name and validate]: A screen for entering the user name and password will be displayed when attempting a printing. The user name and password stored in the Login user name list needs to be entered. The user name and password must be entered each time a printing is attempted.

[Validate user name (computer) or prompt for login user name]: When printing, the Windows user name is searched in the "Login user names" and printing is possible if the name is registered. If the name is not registered, the printing will be canceled for users with only user authority. If the user has administrator privileges, the screen to enter the user name and password will appear.

- 3 Click [OK].

### NOTE

For other settings of user accounting, refer to the following:

➔ Printer Driver User Guide

## Managing the Users to Use TWAIN for Scanning

To manage the users that scan using TWAIN, the following settings are necessary in the TWAIN driver. Instructions are based on interface elements as they appear in Windows 8.1.

### 1 Display the screen.

- 1 Click [Search] in charms, and enter "TWAIN Driver Setting" in the search box. Select [TWAIN Driver Setting] in the search list. TWAIN Driver screen appears.

### NOTE

Select [Start] button on the Windows, [All Programs], [Kyocera] and then [TWAIN Driver Setting].

- 2 Select the machine, click [Edit].

## 2 Configure the settings.

- 1 Click [User Authentication Settings].

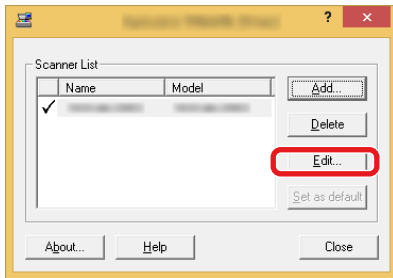

- 2 Select the checkbox beside [Authentication], and enter Login User Name and Password.

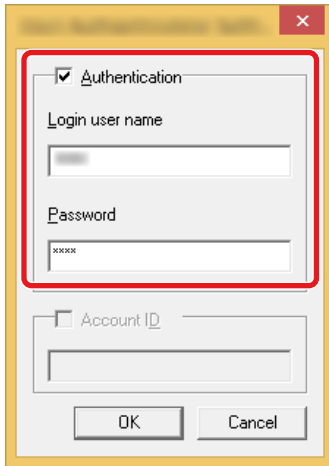

- 3 Click [OK].

## Managing the Users to Use WIA for Scanning

To manage the users that scan using WIA, the following settings are necessary in the WIA driver. Instructions are based on interface elements as they appear in Windows 8.1.

### 1 Display the screen.

- 1 Click [Search] in charms, and enter "View scanners and cameras" in the search box. Click [View scanners and cameras] in the search list then the Scanners and Cameras screen appears.

#### NOTE

In Windows 7, click [Start] button on the Windows and enter [Scanner] in [Program and File Search]. Click [View scanners and cameras] in the search list then the Scanners and Cameras screen appears.

- 2 Select the same name as this machine from WIA Drivers, and click [Properties].

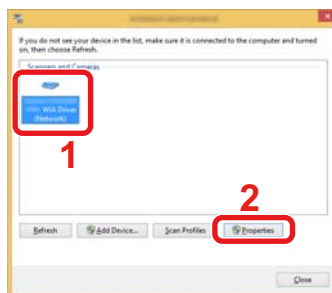

## 2 Configure the settings.

- 1 Select the checkbox beside [Authentication] on the [Settings] tab, and enter Login User Name and Password.

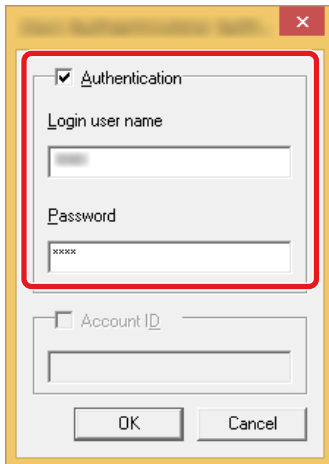

- 2 Click [OK].

## Managing the Users to Send Faxes from a PC

To manage the users that send faxes from a PC, the following settings are necessary in the FAX driver. Instructions are based on interface elements as they appear in Windows 8.1.

### 1 Display the screen.

- 1 From the desktop, click [Settings] in charms, [Control Panel], and then [Devices and Printers].

#### NOTE

In Windows 7, click the [Start] button in Windows, and then click [Devices and Printers].

- 2 Right click the name of the machine to be used as the FAX Driver and select [Printing preferences] from the resulting pull-down menu.
- 3 Click [FAX TX Setting] in the [Printing Preferences] window.

### 2 Configure the settings.

- 1 Select [User Login] on the [Authentication] tab.

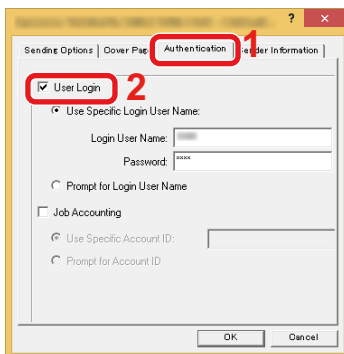

- 2 Set the User Login Administration.

[Use Specific Login User Name]: This option can be used to specify a user name and password to use the same User login for every FAX job. If this option is selected, the user does not have to type the name and password for each FAX job.

[Prompt for Login User Name]: A screen for entering the user name and password will be displayed when attempting a transmission. The user name and password must be entered each time a transmission is attempted.

- 3 Click [OK].

## Local Authorization Settings

Select whether or not to use Local Authorization.

### NOTE

When using Local Authorization, the user authentication type must be set to [Local Authentication].

➔ [Enabling User Login Administration \(9-5\)](#)

### 1 Display the screen.

- 1 [System Menu / Counter] key > [User Login/Job Accounting]

### NOTE

If the user authentication screen appears, enter your login user name and login password and select [Login]. For this, you need to log in with administrator privileges.

The factory default login user name and login password are set as shown below.

Login User Name

ECOSYS M8124cidn:2400, ECOSYS M8130cidn:3000

Login Password

ECOSYS M8124cidn:2400, ECOSYS M8130cidn:3000

- 2 [User Login Settings] > [Local User Authorization]

### 2 Configure the settings.

Select [Off] or [On].

## Group Authorization Settings

Set restrictions of the machine usage by each individual group registered in the authentication server.

### NOTE

To use the group authorization settings, [Network Authentication] must be selected for the authentication method in "User Login Settings". Select "On" for "LDAP" in "Protocol Settings".

➔ [Enabling User Login Administration \(9-5\)](#)

➔ [LDAP \(8-45\)](#)

### Group Authorization

Use the group authorization.

## 1 Display the screen.

- 1 [System Menu / Counter] key > [User Login/Job Accounting]

### NOTE

If the user authentication screen appears, enter your login user name and login password and select [Login]. For this, you need to log in with administrator privileges.

The factory default login user name and login password are set as shown below.

Login User Name

ECOSYS M8124cidn:2400, ECOSYS M8130cidn:3000

Login Password

ECOSYS M8124cidn:2400, ECOSYS M8130cidn:3000

- 2 [User Login Settings] > [Group Authorization Set.] > [Group Authorization]

## 2 Configure the settings.

Select [Off] or [On].

### Adding a Group List

Register the groups that are restricted the machine usage. Other users and groups belong to "Others".

## 1 Display the screen.

- 1 [System Menu / Counter] key > [User Login/Job Accounting]

### NOTE

If the user authentication screen appears, enter your login user name and login password and select [Login]. For this, you need to log in with administrator privileges.

The factory default login user name and login password are set as shown below.

Login User Name

ECOSYS M8124cidn:2400, ECOSYS M8130cidn:3000

Login Password

ECOSYS M8124cidn:2400, ECOSYS M8130cidn:3000

- 2 [User Login Settings] > [Group Authorization Set.] > [Group List] > [ + ]



## 2 Configure the settings.

- 1 Enter the group ID (number between 1 and 4294967295) > [Next >]
- 2 Enter the group name (up to 32 characters) > [Next >]

## 3 Change or add information as needed.

Item	Description
<b>Group ID</b> <sup>*1</sup>	Enter the ID displayed on the group list (between 1 and 4294967295).
<b>Group Name</b>	Enter the name displayed on the group list (up to 32 characters).
<b>Access Level</b>	Select [Administrator] or [User] for group access privileges.
<b>Printer</b>	Select whether or not to reject usage of print functions for the printer. The relevant print functions are as follows. <ul style="list-style-type: none"> <li>• Printing from Document Box</li> <li>• Printing from removable memory</li> <li>• Printing from PC</li> </ul>
<b>Printer (Full Color)</b>	Select whether or not to reject usage of full-color print functions for the printer. The relevant print functions are as follows. <ul style="list-style-type: none"> <li>• Printing from Document Box</li> <li>• Printing from removable memory</li> <li>• Printing from PC</li> </ul>
<b>Copy</b>	Select whether or not to reject usage of copy functions.
<b>Copy (Full Color)</b>	Select whether or not to reject usage of only full-color print functions for copies.
<b>Duplex Restriction</b>	Select whether only duplex printing is allowed.
<b>Combine Restriction</b>	Specify whether only Combine is allowed.
<b>EcoPrint Restriction</b>	Specify whether only EcoPrint is allowed.
<b>Send</b>	Select whether or not to reject usage of the send functions.
<b>FAX Transmission</b> <sup>*2</sup>	Select whether or not to reject usage of the FAX transmissions.
<b>Storing in Box</b>	Select whether or not to reject usage of storing in the document boxes.
<b>Storing Restr. in Memory</b>	Select whether or not to reject usage of storing in the removable memory.

\*1 For "Group ID", specify PrimaryGroupID assigned by Active Directory of Windows. If you are using Windows Server 2008, check Attribute Editor tab of user properties.

\*2 Select whether or not use of the fax send function is prohibited.

 **NOTE**

For details on entering characters, refer to the following:

➔ [Character Entry Method \(12-13\)](#)

3 **Select Access Level > [Next >]**4 **Checks the content. Change or add information as needed.**5 **Registering**

Select [Save].

A new group is added on the group list.

## Guest Authorization Set

When User Login Administration is enabled, set the functions that guest users who cannot log in to the machine are allowed to use.

### NOTE

To use Guest Authorization Set., User Login Administration must be enabled in "User Login Settings".

➔ [Enabling User Login Administration \(9-5\)](#)

### Enabling Guest Authorization

Enable the guest authorization.

#### 1 Display the screen.

1 [System Menu / Counter] key > [User Login/Job Accounting]

### NOTE

If the user authentication screen appears, enter your login user name and login password and select [Login]. For this, you need to log in with administrator privileges.

The factory default login user name and login password are set as shown below.

Login User Name

ECOSYS M8124cidn:2400, ECOSYS M8130cidn:3000

Login Password

ECOSYS M8124cidn:2400, ECOSYS M8130cidn:3000

2 [User Login Settings] > [Guest Authorization Set.] > [Guest Authorization]

#### 2 Configure the settings.

Select [Off] or [On].

### NOTE

If the guest authorization setting is enabled, the [Authentication / Logout] key must be selected when logging in.

In the guest user default settings, only monochrome copying can be used. If you wish to use a different function, log in as a user who can use that function, or change the settings in the guest properties.

### Configuring Guest Property

Register guest user information and functions that are restricted.

## 1 Display the screen.

- 1 [System Menu / Counter] key > [User Login/Job Accounting]



### NOTE

If the user authentication screen appears, enter your login user name and login password and select [Login]. For this, you need to log in with administrator privileges.

The factory default login user name and login password are set as shown below.

Login User Name

ECOSYS M8124cidn:2400, ECOSYS M8130cidn:3000

Login Password

ECOSYS M8124cidn:2400, ECOSYS M8130cidn:3000

- 2 [User Login Settings] > [Guest Authorization Set.] > [Guest Property]

## 2 Configure the settings.

Change or add information as needed.

Item	Descriptions
<b>User Name</b>	Enter the name displayed on the user list (up to 32 characters). The default setting is "Guest User".
<b>Access Level</b>	The authority of the user appears. This cannot be changed.
<b>Account Name</b>	Add an account where the user belongs. If the user does not belong to any account, select [ <b>Other Account</b> ].
<b>Authorization Rules</b>	Set usage authority for each user. The items you can restrict the access level with are as follows. <b>Print Restriction:</b> Select whether or not use of the print function of the printer is prohibited. <b>Print Restriction (Color):</b> Select whether or not use of the print function (color) of the printer is prohibited. <b>Copy Restriction:</b> Select whether or not use of the copy print function is prohibited. <b>Copy Restriction (Full Color):</b> Select whether or not use of the copy print function (full color) is prohibited. <b>Duplex Restriction:</b> Select whether only duplex printing is allowed. <b>Combine Restrict.:</b> Specify whether only Combine is allowed. <b>EcoPrint Restriction:</b> Specify whether only EcoPrint is allowed. <b>Send Restriction:</b> Select whether or not use of the send function is prohibited. <b>FAX TX Restriction*1:</b> Select whether or not use of the fax send function is prohibited. <b>Storing Restr. in Box:</b> Select whether or not use of the box store function is prohibited. <b>Storing Restr. in Memory:</b> Select whether or not use of the removable memory store function is prohibited.

\*1 Select whether or not use of the fax send function is prohibited.



### 3 Registering

Select [Save].

## Obtain NW User Property

Set the required information to obtain the network user property from the LDAP server. The user name and E-mail address obtained with this setting is shown in the user information, the status confirmation screen, and the header of E-mail.

#### NOTE

To obtain the network user property from the LDAP server, [Network Authentication] must be selected for the authentication method in "User Login Settings". Select "On" for "LDAP" in "Protocol Settings".

➔ [Enabling User Login Administration \(9-5\)](#)

➔ [LDAP \(8-45\)](#)

### 1 Display the screen.

1 [System Menu / Counter] key > [User Login/Job Accounting]

#### NOTE

If the user authentication screen appears, enter your login user name and login password and select [Login]. For this, you need to log in with administrator privileges.

The factory default login user name and login password are set as shown below.

Login User Name

ECOSYS M8124cidn:2400, ECOSYS M8130cidn:3000

Login Password

ECOSYS M8124cidn:2400, ECOSYS M8130cidn:3000

2 [User Login Settings] > [Obtain NW User Property] > [On]

### 2 Configure the settings.

Add information on each item > [OK]

Item	Description
<b>Server Name</b> *1	Enter the LDAP server name or the IP address (up to 64 characters). If a server name is not entered, user information will be acquired from the server set for Network Authentication.
<b>Port</b>	Port number for LDAP server. The default port number is 389.
<b>Name 1</b> *2	Enter the LDAP Attribute to obtain the user name to be displayed from the LDAP server (up to 32 characters).
<b>Name 2</b> *3	
<b>E-mail Address</b> *4	Enter the LDAP Attribute to obtain the E-mail address from the LDAP server (up to 128 characters).
<b>Authentication Type</b> *5	Set the authentication method. Select [Simple] or [SASL]. After changing the setting, restart the system or turn the power off and then on.
<b>Search Timeout</b>	Set the amount of time to wait before time-out in seconds (from 5 to 255 seconds).
<b>LDAP Security (User Property)</b>	Select the type of encryption according to the type of security employed by the LDAP server. The value is [Off], [SSL/TLS] or [STARTTLS].

\*1 If using Active Directory of Windows, the server name may be the same as the server name entered in the network au-

thentication.

- \*2 If using Active Directory of Windows, displayName of Attribute may be used as "Name 1".
- \*3 Name 2 can be left out. When you assign displayName in "Name 1" and department in "Name 2", and if the value of displayName is "Mike Smith" and the value of department is "Sales" in Active Directory of Windows, the user name appears as "Mike Smith Sales".
- \*4 If using Active Directory of Windows, mail of Attribute may be used as E-mail Address.
- \*5 Appears when the server type is set to "Kerberos" in "Network Authentication".

## Simple Login Settings

The simple login function allows users to log in simply by selecting a user name. Users must be registered in advance to use this functionality.

### NOTE

- For user registration, refer to the following:
  - ➔ [Adding a User \(Local User List\) \(9-7\)](#)
- To use Simple Login, User Login Administration must be enabled in "User Login Settings".
  - ➔ [Enabling User Login Administration \(9-5\)](#)
- When the guest authorization setting is enabled, the Simple Login screen is not displayed.

## Enabling Simple Login

Select whether or not simple login is enabled.

### 1 Display the screen.

- 1 [System Menu / Counter] key > [User Login/Job Accounting]

### NOTE

If the user authentication screen appears, enter your login user name and login password and select [Login]. For this, you need to log in with administrator privileges.

The factory default login user name and login password are set as shown below.

Login User Name

ECOSYS M8124cidn:2400, ECOSYS M8130cidn:3000

Login Password

ECOSYS M8124cidn:2400, ECOSYS M8130cidn:3000

- 2 [User Login Settings] > [Simple Login Settings] > [Simple Login]

### 2 Configure the settings.

Select [Off] or [On].

## Simple Login Key

Register users to use simple login. You can add up to 20 users.

## 1 Display the screen.

- 1 [System Menu / Counter] key > [User Login/Job Accounting]



### NOTE

If the user authentication screen appears, enter your login user name and login password and select [Login]. For this, you need to log in with administrator privileges.

The factory default login user name and login password are set as shown below.

Login User Name

ECOSYS M8124cidn:2400, ECOSYS M8130cidn:3000

Login Password

ECOSYS M8124cidn:2400, ECOSYS M8130cidn:3000

- 2 [User Login Settings] > [Simple Login Settings] > [Simple Login Setup]

## 2 Enter the user information.

- 1 Select the key to which you want to register a user.
- 2 Select [ + ] for the user whose information you want to modify.



- To specify the user from local users, select [Local User]. To specify from network users, select [Network User]. The procedure differs depending on the transmission method selected.

#### Specifying the user from local users

Select the user to be set for simple login.

#### NOTE

- To sort the user list, select [Menu] > [Sort (Name)] or [Sort (Login User Name)].
- Select [Menu] > [Search (Name)] or [Search (Login User Name)] to search by account name or account ID.

#### Specifying the user from network users



Select [Keyboard] of [Login User Name] and [Login Password], enter the information of the user to be registered, and select [OK].

If you are specifying a user for whom a domain is set in network authentication, select the "Domain Name" and select the domain where the user is registered.

Select [Next >].

#### NOTE

For details on entering characters, refer to the following:

➔ [Character Entry Method \(12-13\)](#)

- Enter the user name to be displayed, select [Next >].

#### NOTE

For details on entering characters, refer to the following:

➔ [Character Entry Method \(12-13\)](#)

- [Password Login] > [On] or [Off] > "Icon"
- Select the user icon to be displayed.

### 3 Registering

Select [Save].

## ID Card Settings

If ID card authentication is enabled, select the authentication type.

### NOTE

- This functions appears when the Card Authentication kit is activated.
- ➔ [Card Authentication Kit\(B\) <Card Authentication Kit> \(12-3\)](#)
- This function does not appear when the user logs in as a network authentication user.

## 1 Display the screen.

1 [System Menu / Counter] key > [User Login/Job Accounting]

### NOTE

If the user authentication screen appears, enter your login user name and login password and select [Login]. For this, you need to log in with administrator privileges.

The factory default login user name and login password are set as shown below.

Login User Name

ECOSYS M8124cidn:2400, ECOSYS M8130cidn:3000

Login Password

ECOSYS M8124cidn:2400, ECOSYS M8130cidn:3000

2 [User Login Settings] > [ID Card Settings]

## 2 Configure the settings.

The following settings can be set.

Item	Description
<b>Keyboard Login</b>	When ID card authentication is enabled, select whether or not login by keyboard is allowed. <i>Value:</i> Permit, Prohibit
<b>Additional Authentication</b> *1	Select whether or not to require password entry after authenticating by ID card. <i>Value:</i> Off, Use Password, Use PIN Code

\*1 This function does not appear when the server type is set to [NTLM] or [Kerberos] in "Network Authentication".

## PIN Code Authorization

Select whether or not to use PIN Code Authorization.

### NOTE

To select [Network], network authentication must be enabled and [Ext.] must be selected for server type.

➔ [Enabling User Login Administration \(9-5\)](#)

## 1 Display the screen.

- 1 [System Menu / Counter] key > [User Login/Job Accounting]



### NOTE

If the user authentication screen appears, enter your login user name and login password and select [Login]. For this, you need to log in with administrator privileges.

The factory default login user name and login password are set as shown below.

Login User Name

ECOSYS M8124cidn:2400, ECOSYS M8130cidn:3000

Login Password

ECOSYS M8124cidn:2400, ECOSYS M8130cidn:3000

- 2 [User Login Settings] > [PIN Login]

## 2 Configure the settings.

- 1 Select [Off] or [On].
- 2 Select [OK].

# Using User Login Administration

This section explains procedures while setting job accounting.

## Login/Logout

If user login administration is enabled, the login user name and login password entry screen appears each time you use this machine.

### Login

If the login user name entry screen appears during operations, log in by referring to the following:

➔ [Login \(3-14\)](#)

### Logout

When the operations are complete, select the [Authentication / Logout] key to return to the account ID entry screen.

## User Login/Job Accounting

Job accounting manages the copy/print/scan/FAX count accumulated by individual accounts by assigning an ID to each account.

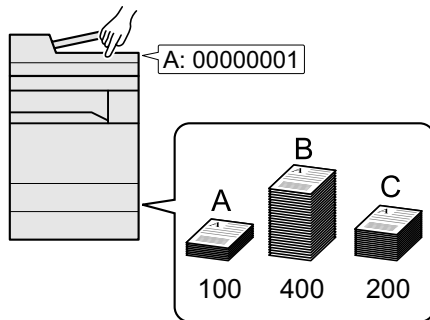

- 1 Enable job accounting. ([9-30](#))
- 2 Configure account settings. ([9-31](#))
- 3 Enter the assigned account ID when executing the job. ([9-44](#))
- 4 This counts the number of sheets used.

### To Manage the Number of Sheets Used on Jobs Printed from a PC

To manage the number of jobs to be printed from the PC on the network, you need to configure settings by using the printer driver on the PC.

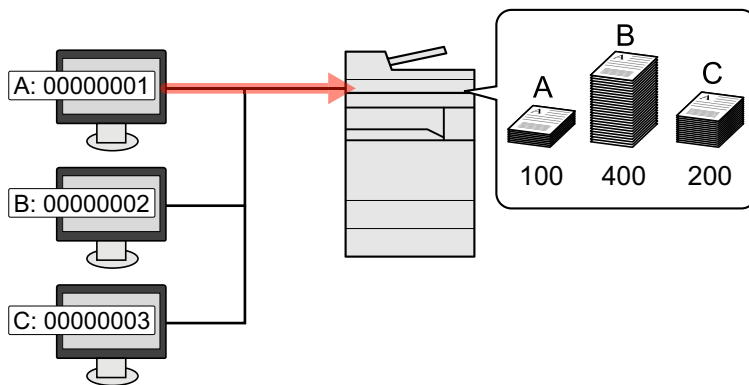

- 1 Set Job Accounting for the PC on the network by using the printer driver. ([9-34](#))
- 2 Print the document.
- 3 Count the number of pages printed.

### Managing the Scan Job Account by Using TWAIN

To manage the scan job account by using TWAIN, you need to configure the TWAIN driver settings on the computer connected to the machine.

#### ➔ [Job Accounting for Scan Using TWAIN \(9-35\)](#)

Managing the Scan Job Account by Using WIA

To manage the scan job account by using WIA, you need to configure the WIA driver settings on the computer connected to the machine.

#### ➔ [Job Accounting for Scan Using WIA \(9-36\)](#)

Managing the FAX Job Transmitted from a PC

To manage the number of FAX jobs transmitted from the PC, you need to configure the settings by using the FAX Driver on the PC.

#### ➔ [Job Accounting for the FAX Transmitted from a Computer \(9-37\)](#)

The optional FAX Kit is required in order to make use of fax functionality.



# Enabling Job Accounting

## 1 Display the screen.

- 1 [System Menu / Counter] key > [User Login/Job Accounting]

### NOTE

If the user authentication screen appears, enter your login user name and login password and select [Login]. For this, you need to log in with administrator privileges. The factory default login user name and login password are set as shown below.

Login User Name

ECOSYS M8124cidn:2400, ECOSYS M8130cidn:3000

Login Password

ECOSYS M8124cidn:2400, ECOSYS M8130cidn:3000

- 2 [Job Accounting Settings] > [Job Accounting Settings]

## 2 Select [On].

### NOTE

- To disable job accounting, select [Off].
- When the display returns to System Menu default screen, logout is automatically executed and the screen to enter the Account ID appears. To continue the operation, enter the Account ID.

# Job Accounting Access

## 1 Display the screen.

- 1 [System Menu / Counter] key > [User Login/Job Accounting]

### NOTE

If the user authentication screen appears, enter your login user name and login password and select [Login]. For this, you need to log in with administrator privileges. The factory default login user name and login password are set as shown below.

Login User Name

ECOSYS M8124cidn:2400, ECOSYS M8130cidn:3000

Login Password

ECOSYS M8124cidn:2400, ECOSYS M8130cidn:3000

- 2 [Job Accounting Settings] > [Job Accounting Access]

## 2 Configure the settings.

Select [Local] or [Network].

### NOTE

To select [Network], network authentication must be enabled and [Ext.] must be selected for server type.

➔ [Enabling User Login Administration \(9-5\)](#)

## Setting an account. [Local]

You can add, change and delete an account and set the restriction for each account.

### Adding an Account [Accounting List]

The number of accounts that can be registered: Up to 100 accounts

The following entries are required.

Item	Description
Account Name	Maximum number of characters that can be entered: Up to 32
Account ID	Input range: 0 to 99999999 (8 digits)

#### 1 Display the screen.

- 1 [System Menu / Counter] key > [User Login/Job Accounting]

##### NOTE

If the user authentication screen appears, enter your login user name and login password and select [Login]. For this, you need to log in with administrator privileges. The factory default login user name and login password are set as shown below.

Login User Name

ECOSYS M8124cidn:2400, ECOSYS M8130cidn:3000

Login Password

ECOSYS M8124cidn:2400, ECOSYS M8130cidn:3000

- 2 [Job Accounting Settings] > [Accounting List] > [ + ]

#### 2 Enter the account information.

- 1 Enter the account name > [Next >]

##### NOTE

For details on entering characters, refer to the following:

➔ [Character Entry Method \(12-13\)](#)

- 2 Enter the account ID > [Next >]

##### NOTE

Any "Account ID" that has already registered cannot be used. Enter any other account ID.

- 3 Activate or deactivate restriction.
  - ➔ [Restricting the Use of the Machine \(9-32\)](#)
- 4 Select [Save].
  - A new account is added on the Account List.

## Restricting the Use of the Machine

This section explains how to restrict the use of the machine by account or the number of sheets available.

The items that can be restricted differ depending on whether "Individual" or "Total" is selected for "Copy/Printer Count".

➔ [Setting the Counting Method for the Copier/Printer \(9-44\)](#)

### Restriction Items

#### [Individual] selected for Copy/Printer Count

Item	Description
Copy (Total)	Limits the number of sheets used for copying.
Copy (Full Color)	Limits the number of pages used for full-color copying.
Printer (Total)	Limits the number of sheets used for printing. The relevant print functions are as follows. <ul style="list-style-type: none"> <li>• Printing from Document Box</li> <li>• Printing from removable memory</li> <li>• Printing from PC</li> </ul>
Printer (Full Color)	Limits the number of sheets used for color printing. The relevant print functions are as follows. <ul style="list-style-type: none"> <li>• Printing from Document Box</li> <li>• Printing from removable memory</li> <li>• Printing from PC</li> </ul>
Scan (Others)	Limits the number of sheets scanned (excludes copying).
FAX Transmission	Restricts the number of fax sheets that can be sent. Displayed only on products with the fax function installed.

#### [Total] selected for Copy/Printer Count

Item	Description
Print (Total)	Limits the total number of sheets used for copying and printing.
Print Restr.(Full Color)	Limits the number of pages used for full-color printing.
Scan (Others)	Limits the number of sheets scanned (excludes copying).
FAX Transmission	Restricts the number of fax sheets that can be sent. Displayed only on products with the fax function installed.

### Applying Restriction

Restriction can be applied in the following modes:

Item	Description
Off	No restriction is applied.
Default Counter Limit	Restricts the print counter in one-page increments up to 9,999,999 copies.
Reject Usage	Restriction is applied.

## Setting Processing When the Limit is Exceeded

This specifies how the machine behaves when the counter has reached the limit of restriction.

Item	Description
<b>Immediately</b> *1	Job stops when the counter reaches its limit.
<b>Subsequently</b>	Printing/scanning of the job continues but the subsequent job will be rejected.
<b>Alert Only</b>	Job continues while displaying an alert message.

\*1 The next job will be prohibited in sending or in storing in the box.

### 1 Display the screen.

- 1 [System Menu / Counter] key > [User Login/Job Accounting]

#### NOTE

If the user authentication screen appears, enter your login user name and login password and select [Login]. For this, you need to log in with administrator privileges. The factory default login user name and login password are set as shown below.

Login User Name

ECOSYS M8124cidn:2400, ECOSYS M8130cidn:3000

Login Password

ECOSYS M8124cidn:2400, ECOSYS M8130cidn:3000

- 2 [Job Accounting Settings] > [Default Setting] > [Apply Limit]

### 2 Configure the settings.

- 1 Select [Immediately], [Subsequently], or [Alert Only].
- 2 Select [OK].

## Editing an Account

### 1 Display the screen.

- 1 [System Menu / Counter] key > [User Login/Job Accounting]

#### NOTE

If the user authentication screen appears, enter your login user name and login password and select [Login]. For this, you need to log in with administrator privileges. The factory default login user name and login password are set as shown below.

Login User Name

ECOSYS M8124cidn:2400, ECOSYS M8130cidn:3000

Login Password

ECOSYS M8124cidn:2400, ECOSYS M8130cidn:3000

- 2 [Job Accounting Settings] > [Accounting List]

## 2 Edit an account.

- 1 Select [  ] for the user whose information you want to modify.

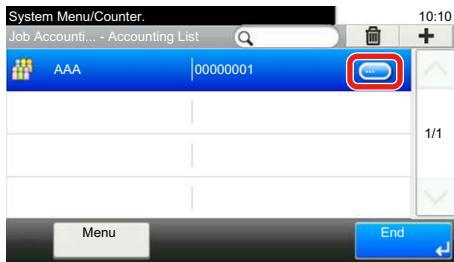

### NOTE

- To perform a name or ID search, select [Menu] > [Search (Name)] or [Search(ID)].
- To sort the account name, select [Menu] > [Sort (Name)] or [Sort (ID)].

- 2 Select the account information to be changed and change the account information.
- 3 [Save] > [Yes]  
The account information is changed.

## Deleting an Account

### 1 Display the screen.

- 1 [System Menu / Counter] key > [User Login/Job Accounting]

### NOTE

If the user authentication screen appears, enter your login user name and login password and select [Login]. For this, you need to log in with administrator privileges. The factory default login user name and login password are set as shown below.

Login User Name

ECOSYS M8124cidn:2400, ECOSYS M8130cidn:3000

Login Password

ECOSYS M8124cidn:2400, ECOSYS M8130cidn:3000

- 2 [Job Accounting Settings] > [Accounting List]

### 2 To delete

- 1 Select the account name you wish to delete.
- 2 Select [  ] > [Yes]  
The account is deleted.

## Managing the Account Printing Status

To manage the number of jobs to be printed from the PC on the network, you need configure the following settings by using the printer driver on the PC. Instructions are based on interface elements as they appear in Windows 8.1.

## 1 Display the screen.

- 1 From the desktop, click [Settings] in charms, [Control Panel], and then [Devices and Printers].

### NOTE

In Windows 7, click the [Start] button in Windows, and then click [Devices and Printers].

- 2 Right-click the printer driver icon of the machine, and click the [Printer properties] menu of the printer driver.
- 3 Click [Administrator] on the [Device Settings] tab.

## 2 Configure the settings.

- 1 Select [Job accounting] on the [Job Accounting] tab.

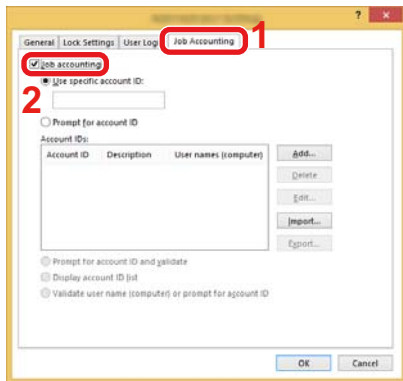

- 2 Set the Job Accounting.

[Use specific account ID]: Enter the Account ID. Printing will be performed using the entered Account ID. If this option is selected, the user does not have to enter the Account ID for each print job.

[Prompt for account ID]: A screen for entering the Account ID will be displayed when attempting a printing. The Account ID must be entered each time a printing is attempted.

[Prompt for account ID and validate]: A screen for entering the Account ID will be displayed when attempting a printing. The Account ID stored in the Account ID list needs to be entered. The Account ID must be entered each time a printing is attempted.

[Display account ID list]: The Account ID list is displayed when printing. The Account ID to be used needs to be selected from the list.

[Validate account ID for each user (host)]: When printing, the Windows user name is searched in the "Account ID list" and printing is possible if the name is registered. If the user is not registered, a screen for entering the account ID is displayed.

- 3 Click [OK].

### NOTE

For other settings of job accounting, refer to the following:

➔ Printer Driver User Guide

## Job Accounting for Scan Using TWAIN

To manage the number of jobs scanned by using TWAIN, you need to configure the following settings by using the TWAIN Driver on the computer. Instructions are based on interface elements as they appear in Windows 8.1.

## 1 Display the screen.

- 1 Click [Search] in charms, and enter "TWAIN Driver Setting" in the search box. Select [TWAIN Driver Setting] in the search list.

### NOTE

Select [Start] button on the Windows, [All Programs], [Kyocera] and then [TWAIN Driver Setting].

- 2 Select the machine, click [Edit].

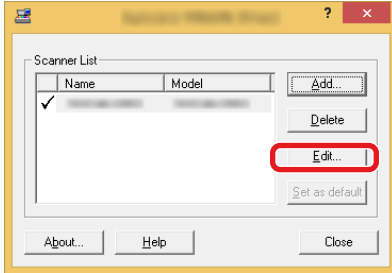

## 2 Configure the settings.

- 1 Click [User Authentication Settings].
- 2 Select the checkbox beside [Account], and enter the account ID.

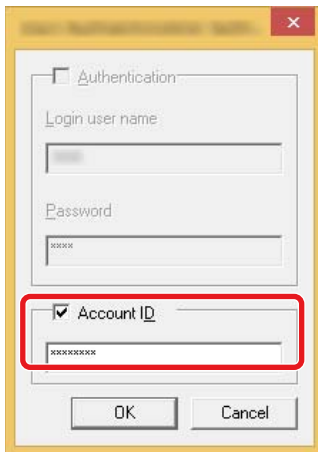

- 3 Click [OK].

## Job Accounting for Scan Using WIA

To manage the number of jobs scanned by using WIA, you need to configure the following settings by using the WIA Driver on the computer. Instructions are based on interface elements as they appear in Windows 8.1.

## 1 Display the screen.

- 1 Click [Search] in charms, and enter "View scanners and cameras" in the search box.

### NOTE

In Windows 7, click [Start] button on the Windows and enter [Scanner] in [Program and File Search]. Click [View scanners and cameras] in the search list then the Scanners and Cameras screen appears.

- 2 Select the same name as this machine from WIA Drivers, and click [Properties].

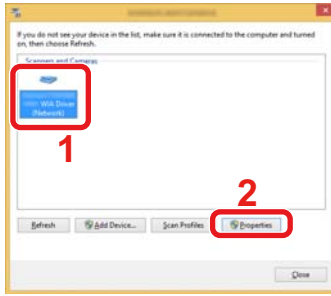

## 2 Configure the settings.

- 1 Select the checkbox beside [Account ID] on the [Settings] tab, and enter the Account ID.

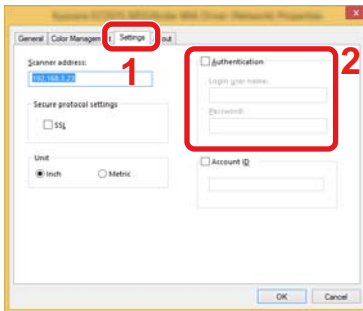

- 2 Click [OK].

## Job Accounting for the FAX Transmitted from a Computer

To manage the number of FAX jobs transmitted from the computer, you need to configure the following settings by using the FAX Driver on the computer. Instructions are based on interface elements as they appear in Windows 8.1.

### 1 Display the screen.

- 1 From the desktop, click [Settings] in charms, [Control Panel], and then [Devices and Printers].

#### NOTE

In Windows 7, click the [Start] button in Windows, and then click [Devices and Printers].

- 2 Right click the name of the machine to be used as the FAX Driver and select [Printing preferences] from the resulting pull-down menu.
- 3 Click [FAX TX Setting] in the [Printing Preferences] window.

### 2 Configure the settings.

- 1 Select [Job Accounting] on the [Authentication] tab.

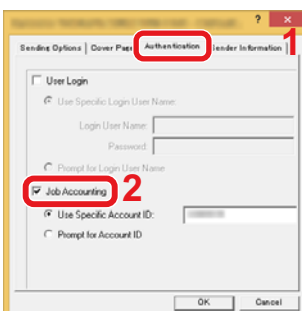



2 Set the Job Accounting.

[Use Specific Account ID]: This option can be used to specify an account ID to use the same Account ID for every FAX job. If this option is selected, the user does not have to enter the Account ID for each FAX job.

[Prompt for Account ID]: A screen for entering the Account ID will be displayed when attempting a transmission. The Account ID must be entered each time a transmission is attempted.

3 Click [OK].

# Using JOB Accounting

## Configuring the Job Accounting Default Settings

Select the item in Default Setting.

### 1 Display the screen.

- 1 [System Menu / Counter] key > [User Login/Job Accounting]



#### NOTE

If the user authentication screen appears, enter your login user name and login password and select [Login]. For this, you need to log in with administrator privileges. The factory default login user name and login password are set as shown below.

Login User Name

ECOSYS M8124cidn:2400, ECOSYS M8130cidn:3000

Login Password

ECOSYS M8124cidn:2400, ECOSYS M8130cidn:3000

- 2 [Job Accounting Settings] > [Default Setting] > [Default Counter Limit]

## 2 Configure the settings.

- 1 Select the item whose maximum sheets default setting you want to configure. > Use the [ + ], [ - ] or use the numeric keypad to enter the default value of the limit.

Item	Description
<b>Default Counter Limit</b>	When you add a new account, you can change the default restrictions on the number of sheets used. You can set any number from 1 to 9,999,999. The items that can be set differ depending on whether [Individual] or [Total] is selected for [Copy/Printer Count]. ➔ <a href="#">Setting the Counting Method for the Copier/Printer (9-44)</a>
<b>[Individual] selected for Copy/Printer Count</b>	
<b>Copy (Total)</b>	Sets the default restriction on the number of sheets used for copying.
<b>Copy (Full Color)</b>	Sets the default restriction on the number of sheets used for full-color copying.
<b>Printer (Total)</b>	Sets the default restriction on the number of sheets used for printing. The relevant print functions are as follows. <ul style="list-style-type: none"> <li>• Printing from Document Box</li> <li>• Printing from removable memory</li> <li>• Printing from PC</li> </ul>
<b>Printer (Full Color)</b>	Sets the default restriction on the number of sheets used for color printing. The relevant print functions are as follows. <ul style="list-style-type: none"> <li>• Printing from Document Box</li> <li>• Printing from removable memory</li> <li>• Printing from PC</li> </ul>
<b>Scan (Others)</b>	Sets the default restriction on the number of sheets used for scanning (excludes copying).
<b>FAX Transmission<sup>*1</sup></b>	Sets the default restriction on the number of sheets used for sending faxes. Displayed only on products with the fax function installed.
<b>[Total] selected for Copy/Printer Count</b>	
<b>Print (Total)</b>	Sets the default restriction on the total number of sheets used for copying and printing.
<b>Print Restr.(Full Color)</b>	Sets the default restriction on the number of sheets used for full-color printing.
<b>Scan (Others)</b>	Sets the default restriction on the number of sheets used for scanning (excludes copying).
<b>FAX Transmission<sup>*1</sup></b>	Sets the default restriction on the number of sheets used for sending faxes. Displayed only on products with the fax function installed.

\*1 FAX functions are available only on products with the fax function installed.

- 2 Select [OK].
- 3 To set the default restriction on other number of sheets, repeat steps 1 and 2.

## Counting by Paper Size

This counts the number of pages by paper size (e.g. Letter).



### NOTE

Paper size is available in four types, 1 to 5. These types are specified in accounting reports.

➔ [Print Accounting Report \(9-43\)](#)

In addition to paper size, media type can also be specified (e.g. count the letter-size color paper used). If you do not specify the media type, the number of used sheets will be counted for the specified sheet size, regardless of the media type.

## 1 Display the screen.

- 1 [System Menu / Counter] key > [User Login/Job Accounting]



### NOTE

If the user authentication screen appears, enter your login user name and login password and select [Login]. For this, you need to log in with administrator privileges. The factory default login user name and login password are set as shown below.

Login User Name

ECOSYS M8124cidn:2400, ECOSYS M8130cidn:3000

Login Password

ECOSYS M8124cidn:2400, ECOSYS M8130cidn:3000

- 2 [Job Accounting Settings] > [Default Setting] > [Count by Paper Size] > [Paper Size 1(-5)]

## 2 Configure the settings.

- 1 Select [On].
- 2 Select the paper size.
- 3 Select [Media Type] to specify media type.
- 4 Select the media type and select [OK].
- 5 Select [OK].

## Counting the Number of Pages Printed

This counts the number of pages printed. Counts are classified into Total Job Accounting and Each Job Accounting. A new count can also be started after resetting the count data which was stored for a certain period of time.

## 1 Display the screen.

- 1 [System Menu / Counter] key > [User Login/Job Accounting]



### NOTE

If the user authentication screen appears, enter your login user name and login password and select [Login]. For this, you need to log in with administrator privileges. The factory default login user name and login password are set as shown below.

Login User Name

ECOSYS M8124cidn:2400, ECOSYS M8130cidn:3000

Login Password

ECOSYS M8124cidn:2400, ECOSYS M8130cidn:3000

- 2 [Job Accounting Settings] > [Total Job Accounting] or [Each Job Accounting]

## 2 Configure the settings.

The table below lists the item you can view.

Item	Description
<b>Printed Pages</b>	Displays the number of pages copied and printed, and the total number of pages used. You can also use [FAX], [Count by Paper Size], [by Duplex] and [by Combine] to check the number of pages used.
<b>Count by Paper Size</b>	
<b>Copy(B &amp; W)</b>	Displays the number of pages used for black and white copying.
<b>Copy (Full Color)</b>	Displays the number of pages used for full-color copying.
<b>Copy (Total)</b>	Displays the number of pages copied.
<b>Printer (B &amp; W)</b>	Displays the number of pages used for black and white printing. The relevant print functions are as follows. <ul style="list-style-type: none"> <li>• Printing from Document Box</li> <li>• Printing from removable memory</li> <li>• Printing from PC</li> </ul>
<b>Printer (Full Color)</b>	Displays the number of pages used for color printing. The relevant print functions are as follows. <ul style="list-style-type: none"> <li>• Printing from Document Box</li> <li>• Printing from removable memory</li> <li>• Printing from PC</li> </ul>
<b>Printer (Total)</b>	Displays the number of pages printed. The relevant print functions are as follows. <ul style="list-style-type: none"> <li>• Printing from Document Box</li> <li>• Printing from removable memory</li> <li>• Printing from PC</li> </ul>
<b>Copy/Printer (B/W)</b>	Displays the total number of pages used for black-and-white copying and printing.
<b>Copy/Print. (Full Color)</b>	Displays the total number of pages used for full-color copying and printing.
<b>Copy/Print.(Total)</b>	Displays the total number of pages used for copying and printing.
<b>FAX<sup>*1</sup></b>	Displays the number of pages received.
<b>Total</b>	Displays the total number of pages used.
<b>by Duplex</b>	Displays the number of pages used in Duplex (1-sided) mode, Duplex (2-sided) mode and the total for both.
<b>by Combine</b>	Displays the pages used in Combine (None) mode, Combine (2in1) mode, Combine (4in1) mode and the total for all three.
<b>Count by Paper Size</b>	Displays the number of pages used in the selected paper size as well as the number of pages used in other paper sizes.
<b>Scanned Pages</b>	Displays the number of pages scanned for copying, faxing and other functions, as well as the total number of pages scanned.
<b>FAX TX Pages<sup>*1</sup></b>	Displays the number of pages faxed.
<b>FAX TX Time<sup>*1</sup></b>	Displays the total duration of FAX transmissions.
<b>Counter Reset</b>	Resets the counter. Select [Yes] in the confirmation screen.

\*1 FAX functions are available on products with the fax function installed.

## Counting the Number of Pages PrintedTotal Accounting

Counting the Number of Pages PrintedTotal Accounting

### 1 Check the number of pages.

- 1 Select [Check] at the function to check the count.  
The results will be displayed.
- 2 Confirm the count and select [Close].

## Counting the Number of Pages Used for Each Account

This counts the number of pages for each account and resets the counts by account.

### 1 Display the screen.

- 1 Select the account to check the count.
- 2 Select [ ] for the user whose information you want to modify.

#### NOTE

- To perform the Account ID select [Menu] > [Search (Name)] or [Search(ID)]. Select [Select Others] to search by account name or account ID.
  - To sort the account name, select [Menu] > [Sort (Name)] or [Sort (ID)].
- 3 Select the function to check the count.  
The results will be displayed.
  - 4 Confirm the count and select [End].

## Print Accounting Report

The total pages counted of all relevant accounts can be printed as an accounting report.

Reports have different formats depending on how the count of copiers and printers is administered.

**When "Individual" is selected for Managing the Copy/Printer Count.**

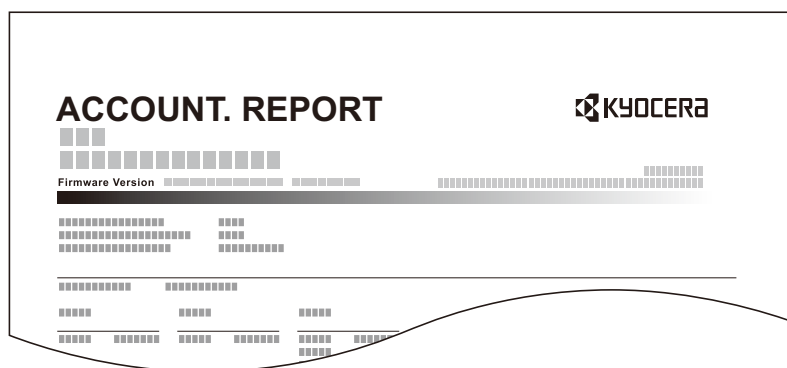

### 1 Prepare paper.

- 1 Check that A4 or Letter paper is loaded in the cassette.

## 2 Display the screen.

[System Menu / Counter] key > [User Login/Job Accounting] > [Job Accounting Settings]

### NOTE

If the user authentication screen appears, enter your login user name and login password and select [Login]. For this, you need to log in with administrator privileges. The factory default login user name and login password are set as shown below.

Login User Name

ECOSYS M8124cidn:2400, ECOSYS M8130cidn:3000

Login Password

ECOSYS M8124cidn:2400, ECOSYS M8130cidn:3000

## 3 Print the document.

[Print Accounting Report] > [Yes]

Accounting report is printed.

# Setting the Counting Method for the Copier/Printer

You can select the management method for the number of pages used for the copier and printer, either combined or individually. Depending on this selection, restrictions and collection method of the number of pages changes. Choose the setting according to the usage environment of the machine.

If the login user name entry screen appears during operations, log in by referring to the following:

➔ [Restricting the Use of the Machine \(9-32\)](#)

➔ [Counting the Number of Pages Printed \(9-41\)](#)

➔ [Print Accounting Report \(9-43\)](#)

## 1 Display the screen.

1 [System Menu / Counter] key > [User Login/Job Accounting]

### NOTE

If the user authentication screen appears, enter your login user name and login password and select [Login]. For this, you need to log in with administrator privileges. The factory default login user name and login password are set as shown below.

Login User Name

ECOSYS M8124cidn:2400, ECOSYS M8130cidn:3000

Login Password

ECOSYS M8124cidn:2400, ECOSYS M8130cidn:3000

2 [Job Accounting Settings] > [Default Setting] > [Copy/Printer Count]

## 2 Configure the settings.

1 Select [Total] or [Individual].

2 Select [OK].

# Login/Logout (Job Accounting)

If job accounting is enabled, an account ID entry screen appears each time you use this machine.

## Login (Job Accounting)

When a screen for entering account ID appears as a result of operating the machine, perform the following operation.

### 1 Enter the account ID using the numeric keys and select [Login].



#### NOTE

- If you entered a wrong character, select the [Clear] key and enter the account ID again.
- By selecting [Check Counter], you can refer to the number of pages printed and the number of pages scanned.

#### When the screen to enter the login user name and password appears

If user login administration is enabled, the screen to enter the login user name and password appears. Enter a login user name and password to login. If the user has already registered the account information, the account ID entry would be skipped.

▶ [Adding a User \(Local User List\) \(9-7\)](#)

### 2 Proceed to complete the rest of the steps.

## Logout (Job Accounting)

When the operations are complete, select the [Authentication / Logout] key to return to the account ID entry screen. Return to the account ID entry screen.



# Setting Unknown Number Processing Method

## Setting Unknown ID Job Processing

This specifies the behavior for handling the jobs sent with unknown or unsend login user names or User ID. If user login administration is disabled and job accounting is enabled, the processing method used for an unknown ID job is used.

The table below lists the items to be set.

Item	Description
Permit	Processes the job.
Reject	Does not process the job.

### 1 Display the screen.

- [System Menu / Counter] key > [User Login/Job Accounting]

#### NOTE

If the user authentication screen appears, enter your login user name and login password and select [Login]. For this, you need to log in with administrator privileges. The factory default login user name and login password are set as shown below.

Login User Name

ECOSYS M8124cidn:2400, ECOSYS M8130cidn:3000

Login Password

ECOSYS M8124cidn:2400, ECOSYS M8130cidn:3000

- Select [Unknown ID Job].

### 2 Configure the settings.

Select [Reject] or [Permit].

## Registering User Property for an Unknown ID User

When registering user property for an unknown ID user, you can check the user on the Job Status screen or Job Log screen. Also, you can restrict the available functions.

#### NOTE

This function is displayed when [Unknown ID Job] is set to [Permit].

## 1 Display the screen.

- 1 [System Menu / Counter] key > [User Login/Job Accounting]



### NOTE

If the user authentication screen appears, enter your login user name and login password and select [Login]. For this, you need to log in with administrator privileges. The factory default login user name and login password are set as shown below.

Login User Name

ECOSYS M8124cidn:2400, ECOSYS M8130cidn:3000

Login Password

ECOSYS M8124cidn:2400, ECOSYS M8130cidn:3000

- 2 Select [Unknown User Settings] > [User Property].

## 2 Enter the user information.

Add information on each item > [OK]

Item	Description
<b>User Name</b>	Enter the user name, up to 32 characters.
<b>Account Name</b>	<p>Register an account for the unknown ID user.</p> <p>➔ <a href="#">User Login/Job Accounting (9-29)</a></p> <p> <b>NOTE</b></p> <ul style="list-style-type: none"> <li>• To perform the Account ID select [Menu] &gt; [Search (Name)] or [Search(ID)].</li> <li>• To sort the account name, select [Menu] &gt; [Sort (Name)] or [Sort (ID)].</li> <li>• This is displayed when job accounting administration is enabled.</li> </ul>
<b>Authorization Rules</b>	<p>Set usage restrictions.</p> <p>The following restriction items are available:</p> <p><b>Printer:</b></p> <p>Select whether or not to reject usage of print functions for the printer.</p> <p>The relevant print functions are as follows.</p> <ul style="list-style-type: none"> <li>• Printing from PC</li> </ul> <p><b>Printer (Full Color):</b></p> <p>Select whether or not use of the print function (full-color) of the printer is prohibited.</p> <p>The relevant print functions are as follows.</p> <ul style="list-style-type: none"> <li>• Printing from PC</li> </ul>

# 10 Maintenance

This chapter explains the following topics:

Regular Maintenance .....	10-2
Cleaning Glass Platen .....	10-2
Cleaning Slit Glass .....	10-2
Toner Container Replacement .....	10-4
Waste Toner Box Replacement .....	10-7
Loading Paper .....	10-9
Staple Cartridge Replacement (Document Finisher) .....	10-10

## Regular Maintenance

Clean the machine regularly to ensure optimum printing quality.



### CAUTION

For safety, always unplug the power cord before cleaning the machine.

## Cleaning Glass Platen

Wipe the glass platen, the original holder, and the inside of the original feeder with a soft cloth moistened with alcohol or a mild detergent.



### IMPORTANT

Do not use thinner or other organic solvents.

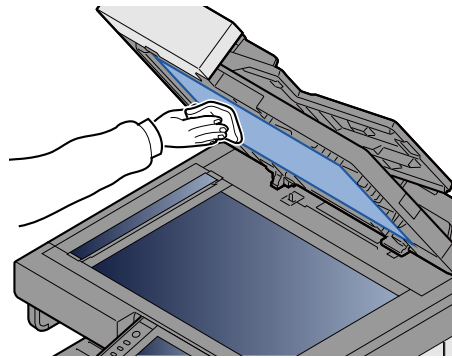
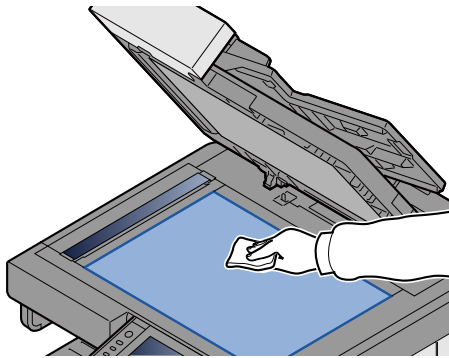

## Cleaning Slit Glass

When using the original feeder, clean the slit glass surface and the reading guide with the provided cleaning cloth.



### NOTE

Dirt on the slit glass or the reading guide may cause black streaks to appear in the output.

### 1 Take out the cleaning cloth.

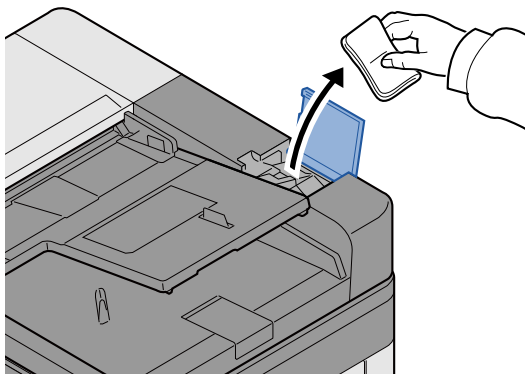

## 2 Clean the slit glass and the reading guide.

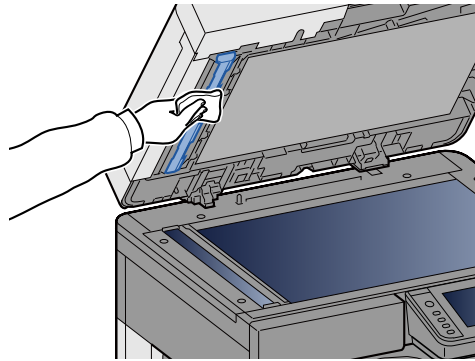
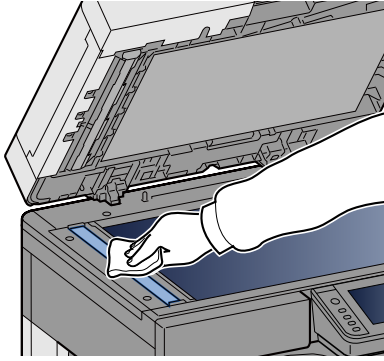

# Consumable Replacement and Replenishment

Messages will appear when toner runs out or when a cassette runs out of paper. Replace or replenish as required in accordance with the message.

## Toner Container Replacement

The message shown below will appear when toner runs out. If this happens, replace the toner container.

"Toner is empty."

The message shown below will appear when toner runs low. Make sure you have a new toner container available for replacement.

"Toner is low. (Replace when empty.)"

### NOTE

- For the toner container, always use a genuine toner container. Using a toner container that is not genuine may cause image defects and product failure.
- The memory chip in the toner container of this product stores information necessary for improving customer convenience, operation of the recycling system for used toner containers, and planning and development of new products. The stored information does not include information that makes it possible to identify individuals, and is only used anonymously for the above purposes.

### CAUTION

Do not attempt to incinerate parts which contain toner. Dangerous sparks may cause burns.

#### 1 Open the front cover.

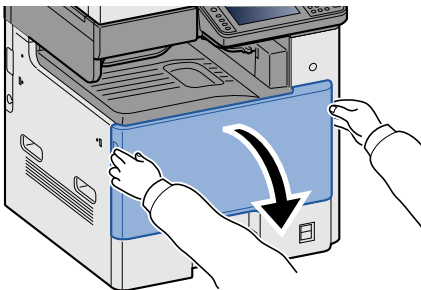

#### 2 Remove the toner container.

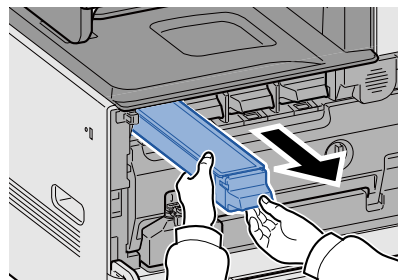
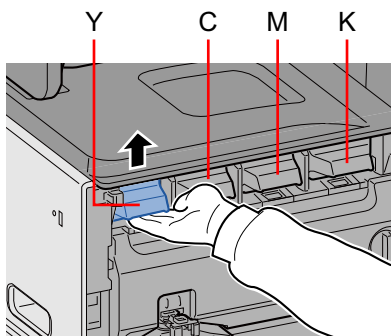

**3 Put used toner containers into the plastic waste bag.**

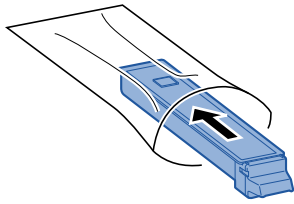

**4 Remove the new toner container from the box.**

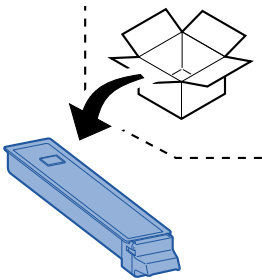

**✔ IMPORTANT**

Do not touch the points shown below.

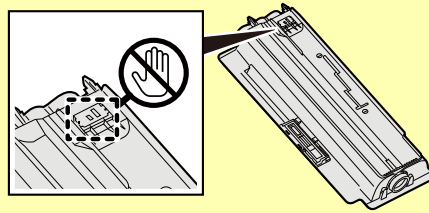

**5 Tap the toner container.**

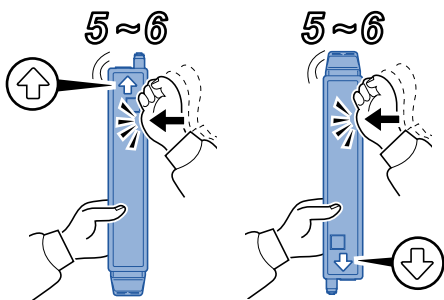

## 6 Shake the toner container.

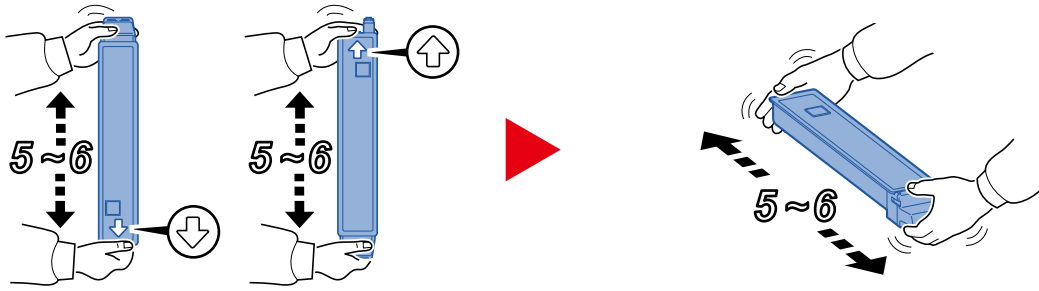

## 7 Install the toner container.

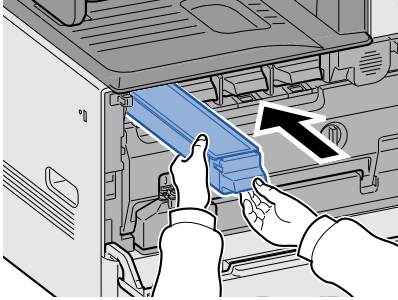

### ✔ IMPORTANT

Insert the toner container as far as it will go.

## 8 Close the front cover.

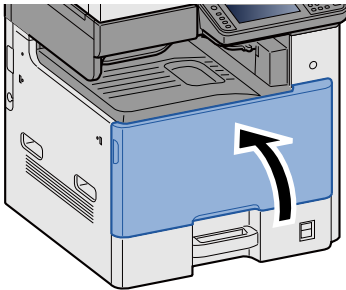

### 💡 NOTE

- If the front cover does not close, check that the new toner container is installed correctly.
- Return the used toner container to your dealer or service representative. The collected toner container will be recycled or disposed in accordance with the relevant regulations.



## Waste Toner Box Replacement

The message shown below will appear when the waste toner box is full. Replace the waste toner box.

"Check the waste toner box."



### CAUTION

Do not attempt to incinerate parts which contain toner. Dangerous sparks may cause burns.

- 1 Open the front cover.

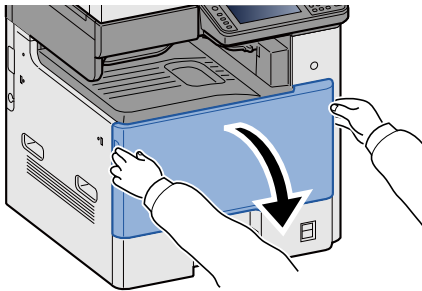

- 2 Remove the Waste Toner Box.

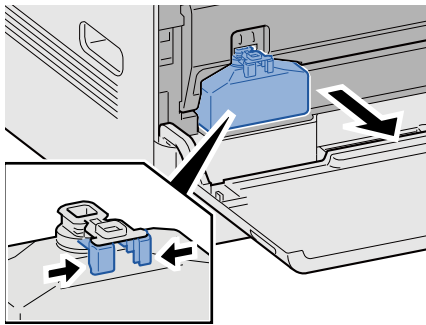

- 3 Put used toner containers into the plastic waste bag.

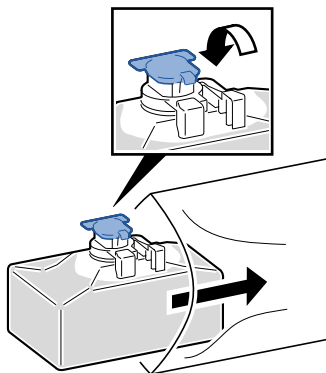

**4 Remove the new Waste Toner Box.**

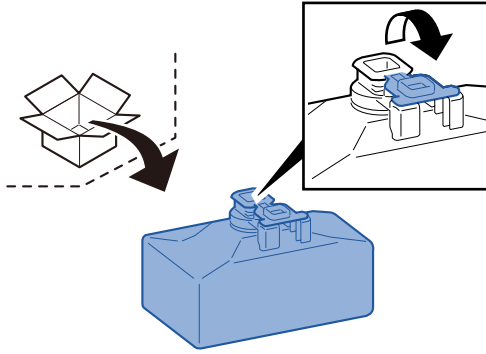

**5 Install the Waste Toner Box.**

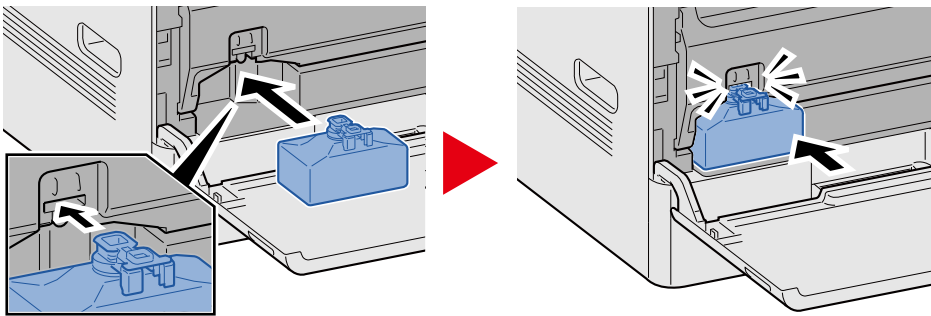

**6 Close the front cover.**

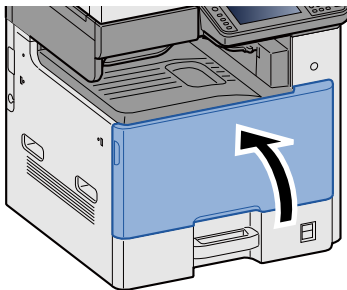

**NOTE**

Return the used waste toner box to your dealer or service representative. The collected waste toner box will be recycled or disposed in accordance with the relevant regulations.

## Loading Paper

The message shown below will appear when a cassette runs out of paper. Load paper.

Add paper in cassette #. (# stands for the cassette number.)

Add paper in Multi Purpose tray.

➔ [Loading in the Cassettes 1 \(to 3\) \(3-19\)](#)

➔ [Loading Paper in the Multi Purpose Tray \(5-7\)](#)



### NOTE

When [On] is selected for the [Show Paper Setup Message], the paper setting confirmation screen will appear. If you changed to a different paper type, select [Change] and then configure the paper settings as required.

➔ [\[Cassette 1 \(to 3\)\] \(8-9\)](#)

➔ [\[Multi Purpose Tray\] \(8-10\)](#)

## Staple Cartridge Replacement (Document Finisher)

The message shown below will appear when staples run out. When this happens, replace the staple cartridge.

"Staple is empty."

 **NOTE**

If staples run out, contact your dealer or service representative.

**1 Open the Staple Cover of the Document Finisher.**

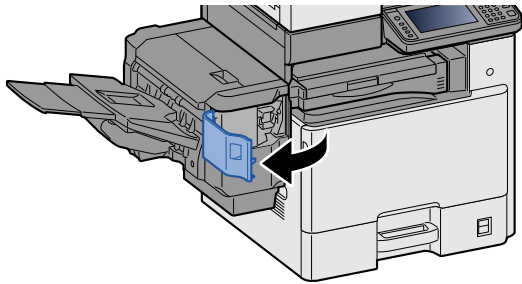

**2 Remove the Staple Cartridge Holder.**

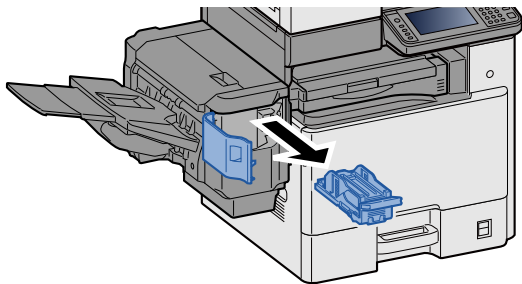

**3 Replace the staples.**

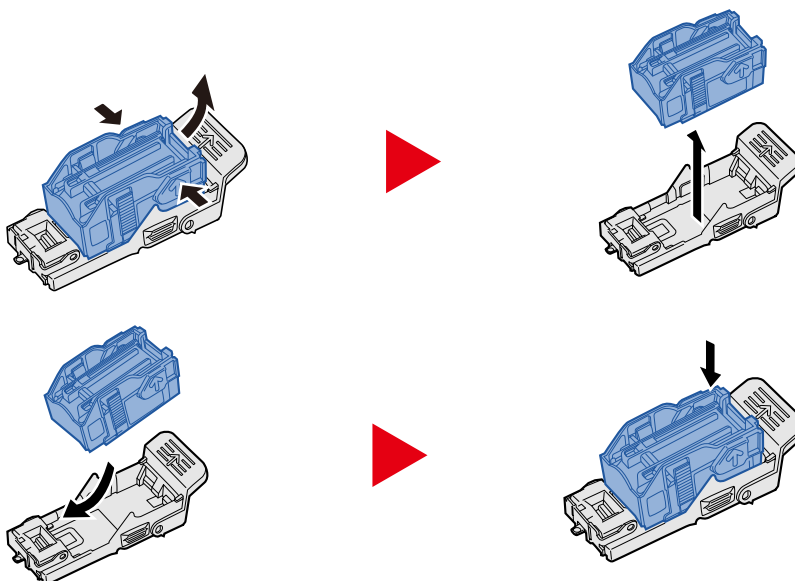

**4** Install the Staple Cartridge Holder.

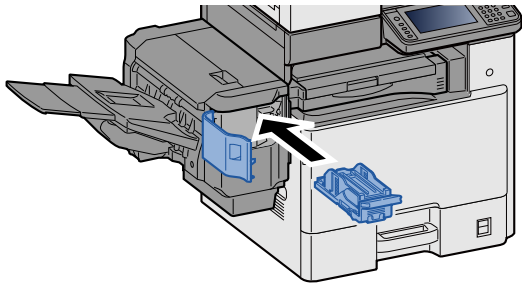

**5** Close the staple cover.

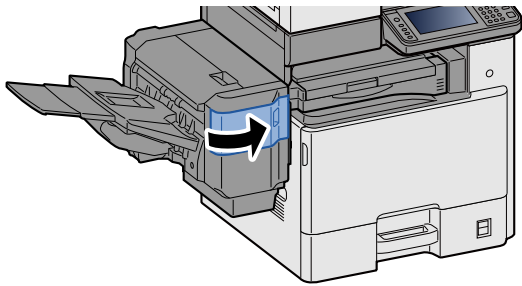

# 11 Troubleshooting

This chapter explains the following topics:

General Troubles .....	11-2
Solving Malfunctions .....	11-2
Machine Operation Trouble .....	11-3
Printed Image Trouble .....	11-6
Color printing trouble .....	11-9
Responding to Messages .....	11-10
Responding to Send Error .....	11-22
Adjustment/Maintenance .....	11-25
Overview of Adjustment/Maintenance .....	11-25
Color Registration Procedure .....	11-25
Calibration .....	11-30
Perform the laser scanner cleaning. ....	11-30
Tone Curve Adjustment .....	11-30
Drum Refresh .....	11-32
Clearing Paper Jams .....	11-33
Jam Location Indicators .....	11-33
Remove any jammed paper in the Multipurpose Tray .....	11-34
Remove any jammed paper in Right Cover 1 .....	11-35
Remove any jammed paper in Cassette 1, 2 and 3 .....	11-36
Remove any jammed paper in Right Cover 2, 3 .....	11-37
Remove any jammed paper in the Document Finisher .....	11-39
Remove any jammed paper in the Bridge Unit .....	11-40
Remove any jammed paper in the Document Processor .....	11-41
Clearing a Staple Jam .....	11-43
Clearing a staple jam of the Document Finisher .....	11-43

# General Troubles

## Solving Malfunctions

The table below provides general guidelines for problem solving. If a problem occurs with your machine, look into the checkpoints and perform procedures indicated on the following pages.

If the problem persists, contact your Service Representative.



### NOTE

When contacting us, the serial number will be necessary.

To check the serial number, refer to the following.

▶ [Display for Device Information \(3-11\)](#)

## Machine Operation Trouble

Mechanical operation trouble includes the following phenomena. Implement appropriate procedures.

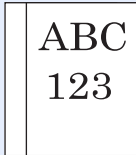
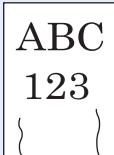
Symptom	Checkpoints	Corrective Actions	Reference Page
<b>An application does not start.</b>	Is the Auto Panel Reset time short?	Set the Auto Panel Reset time to 30 seconds or more.	<a href="#">8-60</a>
<b>The screen does not respond when the power switch is turned on.</b>	Check the power cord.	Connect both ends of the power cord securely.	<a href="#">2-9</a>
<b>Pressing the [Start] key does not produce copies.</b>	Is there a message on the screen?	Determine the appropriate response to the message and respond accordingly.	<a href="#">11-10</a>
	Is the machine in Sleep mode?	Select any key on the operation panel to recover the machine from Sleep mode.	<a href="#">2-23</a>
<b>Blank sheets are ejected.</b> 	Are the originals placed correctly?	When placing originals on the platen, place them face-down and align them with the original size indicator plates.	<a href="#">5-3</a>
		When placing originals in the document processor, place them face-up.	<a href="#">5-4</a>
	—	Check that the settings of the application software.	—
<b>Paper often jams.</b>	Is the paper loaded correctly?	Load the paper correctly.	<a href="#">3-19</a>
	—	Turn the orientation 180 degrees around in which the paper is positioned.	<a href="#">3-19</a>
	Is the paper of the supported type? Is it in good condition?	Remove the paper, turn it over, and reload it.	<a href="#">3-19</a>
	Is the paper curled, folded or wrinkled?	Replace the paper with new paper.	<a href="#">3-17</a>
	Are there any loose scraps or jammed paper in the machine?	Remove any jammed paper.	<a href="#">11-33</a>
<b>2 or more sheets are overlaps when ejected. (multi feed)</b> 	—	Load the paper correctly.	<a href="#">3-18</a>
<b>Printouts are wrinkled.</b> 	Is the paper loaded correctly?	Load the paper correctly.	<a href="#">3-17</a>
	—	Turn the orientation 180 degrees around in which the paper is positioned.	<a href="#">3-17</a>
	Is the paper damp?	Replace the paper with new paper.	<a href="#">3-19</a>
		If you experience frequent problems, turn the cassette heater switch on.	<a href="#">2-5</a>



Symptom	Checkpoints	Corrective Actions	Reference Page
<b>Printouts are curled.</b> 	—	Turn the orientation 180 degrees around in which the paper is positioned.	<a href="#">3-19</a>
	Is the paper damp?	Replace the paper with new paper.	<a href="#">3-17</a>
		If you experience frequent problems, turn the cassette heater switch on.	<a href="#">2-5</a>
<b>This completes the printer driver installation.</b>	Is the driver installed with the host name while Wi-Fi or Wi-Fi Direct function is available?	Specify the IP address instead of the host name.	<a href="#">2-28</a>
<b>Cannot print.</b>	Check the power cord.	Connect both ends of the power cord securely.	<a href="#">2-9</a>
	Is the machine powered on?	Turn on the power switch.	<a href="#">2-10</a>
	Are the USB cable and network cable connected?	Connect the correct USB cable and network cable securely.	<a href="#">2-9</a> <a href="#">2-9</a>
	Is the print job paused?	Resume printing.	<a href="#">7-9</a>
	When the wired or Wi-Fi network is configured using the name resolution, does the IP address (private address) of the other network which can not access coexists?	The number of host name and domain name which can be used with the machine is one respectively. Configure the network under this restriction. Configure the network under this restriction.	—
		Change the settings of name resolution such as NetBEUI and DNS, or network environment settings.	Command Center RX User Guide
		Select Wi-Fi, Wired Network or Optional Network as an unlimited use network on Primary Network (Client).	<a href="#">8-54</a>
	Set to [Wired Network] or [Wi-Fi] either one of [Enable], and set the other setting to [Disable].	<a href="#">8-44</a>	
<b>Cannot print with USB memory.</b>	Is the USB host blocked [Block]?	Select [Unblock] in the USB host settings.	<a href="#">8-54</a>
<b>USB memory not recognized.</b>	—	Check that the USB memory is securely plugged into the machine.	—
<b>While "On" is set to [Auto-IP], the IP address is not assigned automatically.</b>	Is a value other than "0.0.0.0" entered for the IP address of TCP/IP(v4)?	Enter "0.0.0.0" for the IP address of TCP/IP(v4).	<a href="#">2-13</a>





Symptom	Checkpoints	Corrective Actions	Reference Page
<b>Cannot send via SMB.</b>	Is the network cable connected?	Connect the correct network cable securely.	<a href="#">2-9</a>
	Have the network settings for the equipment been configured properly?	Configure the TCP/IP settings properly.	<a href="#">8-41</a>
	Have the folder sharing settings been configured properly?	Check sharing settings and access privileges under the folder properties.	<a href="#">3-24</a>
	Is the "SMB Client (Transmission)" [Local]?	Select [On] in the SMB Client (Transmission).	<a href="#">8-44</a>
	Has [Port] been entered properly? * <sup>1</sup>	Check the name of the computer to which data is being sent.	<a href="#">5-16</a>
	Has [FTP] been entered properly?	Check the share name for the shared folder.	<a href="#">5-16</a>
	Has [Search Folder by Host Name] been entered properly?* <sup>1</sup> * <sup>2</sup>	Check the domain name and login user name.	<a href="#">5-16</a>
	Has the same domain name been used for [Port] and [Search Folder by Host Name]?	Delete the domain name and backslash (\) from [Search Folder by Host Name].	<a href="#">5-16</a>
	Has [Connection Test] been entered properly?	Check the login password.	<a href="#">5-16</a>
	Have exceptions for Windows Firewall been configured properly?	Configure exceptions for Windows Firewall properly.	<a href="#">3-28</a>
	Do the time settings for the equipment, domain server, and data destination computer differ?	Set the equipment, domain server, and data destination computer to the same time.	—
	Is the screen displaying "Send error."?	Refer to Responding to Send Error.	<a href="#">11-22</a>
<b>Cannot connect to this machine by using Wi-Fi Direct.</b>	Are three handheld devices connected simultaneously?	Release the connection of handheld devices being connected manually or set a connection after setting the connection time and releasing the connection by automatic disconnection.	<a href="#">8-35</a>
<b>Cannot send via the e-mail.</b>	Is the E-mail send size limit set in the SMTP server registered on the machine?	Check the limit value is entered to [E-mail Size Limit] > "Address Book" of Command Center RX and change the setting as necessary.	<a href="#">2-45</a>
<b>The machine is emitting steam in the area around the paper ejection slot.</b>	Check the room temperature to see if it is low, or if damp paper was used.	Depending on the printing environment and the paper's condition, the heat generated during printing will cause the moisture in the paper to evaporate, and the steam emitted may look like smoke. This is not a problem, and you can continue printing. If the steam concerns you, raise the room temperature, or replace the paper with a newer, dryer paper.	—



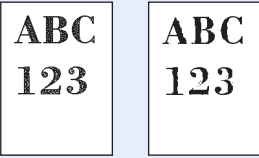
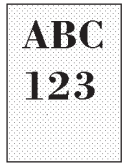

\*1 You can also enter a full computer name as the host name (Example: pc001.abcdnet.com)

\*2 You can also enter login user names in the following formats:  
 Domain Name\User Name (for example, james.smith@\abcdnet)  
 User\_name@domain\_name (for example, james.smith@abcdnet)

## Printed Image Trouble

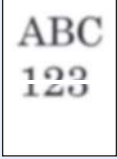
When the following printed image trouble occurs, implement appropriate procedures. Implement appropriate procedures.

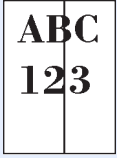
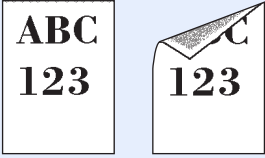
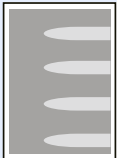
Symptom	Checkpoints	Corrective Actions	Reference Page
<p><b>Printed images are totally too light.</b></p> 	Is the paper damp?	Replace the paper with new paper. If you experience frequent problems, turn the cassette heater switch on.	<a href="#">3-17</a> <a href="#">2-5</a>
	Have you changed the density?	Select appropriate density level.	<a href="#">6-16</a> <a href="#">8-63</a>
	Is the toner distributed evenly within the toner container?	Shake the toner container from side to side several times.	<a href="#">10-4</a>
	Is EcoPrint mode enabled?	Select [EcoPrint] > [Off].	<a href="#">6-18</a>
	—	Run [Drum Refresh].	<a href="#">11-32</a>
	—	Make sure the paper type setting is correct for the paper being used.	<a href="#">8-9</a>
<p><b>The white portion of printed images look gray as a whole.</b></p> 	Have you changed the density?	Select appropriate density level.	<a href="#">6-16</a> <a href="#">8-63</a>
<p><b>Copies have a moire pattern (dots grouped together in patterns and not aligned uniformly).</b></p> 	Is the original a printed photograph?	Set [Original Image (Copy)] or [Org. Image (Send/Store)] to [Photo].	<a href="#">6-17</a>
<p><b>Texts are not clearly printed.</b></p> 	Did you choose appropriate image quality for the original?	Choose the appropriate image for [Original Image (Copy)] or [Org. Image (Send/Store)].	<a href="#">6-17</a>
<p><b>Black spots are in the white portion of the image.</b></p> 	Is the original holder or the glass platen dirty?	Clean the original holder or the glass platen.	<a href="#">10-2</a>

Symptom	Checkpoints	Corrective Actions	Reference Page
<b>Printouts are fuzzy.</b> 	Is the device used in an environment with high humidity or where the temperature or humidity changes suddenly?	Use in an environment that has suitable humidity.  If you experience frequent problems, turn the cassette heater switch on.	—  <a href="#">2-5</a>
	—	Run [Drum Refresh].	<a href="#">11-32</a>
	—	—	—
<b>Images are skewed.</b> 	Are the originals placed correctly?	When placing originals on the platen, align them with the original size indicator plates.  When placing originals in the document processor, align the original width guides securely before placing the originals.	<a href="#">5-3</a>  <a href="#">5-4</a>
	Is the paper loaded correctly?	Check the position of the paper width guides.	<a href="#">3-19</a>
	—	[Perform center line adjustment. For the adjustment method, contact your Service Representative.	—
	—	—	—
<b>Printouts have vertical lines.</b> 	Is the slit glass dirty?	Clean the slit glass.	<a href="#">10-2</a>
<b>Dirt on the top edge or back of the paper.</b> 	Is the interior of the machine dirty?	Open the right cover. If the machine interior is dirty with toner, clean it using soft, dry, lint-free cloth.	—
<b>Part of the image is periodically faint, blurred or shows white lines.</b> 	Is the developing unit or drum unit set correctly?	Set the developing unit or drum unit set correctly.	—
	—	Open and then close the right cover.	—
	—	Run [Drum Refresh].	<a href="#">11-32</a>
	—	If you experience frequent problems, turn the cassette heater switch on.	<a href="#">2-5</a>
<b>Print on the back of the sheet is visible on the front.</b> 	—	Set [Prevent Bleed-thru (Copy)] or [Prevent Bleed(Send/Store)] to [On].	<a href="#">6-26</a>
<b>The background density is obtrusive.</b>	—	Run [Background Density Adj.].	<a href="#">6-24</a>

Symptom	Checkpoints	Corrective Actions	Reference Page
<b>Colors appear different than you anticipated.</b>	—	Run [Tone Curve Adjustment].	<a href="#">11-30</a>
<b>The scanned image is misaligned when copying the ID card.</b>	Is the ID card placed within A5 area which is indicated on the platen?	Place the ID card on the platen within the A5 indicated area.	—

## Color printing trouble

When the following color printing trouble occurs, implement appropriate procedures. Implement appropriate procedures.

Symptom	Checkpoints	Corrective Actions	Reference Page
<b>Skewed-color printout.</b> 	—	Run [Calibration].	<a href="#">11-30</a>
	—	Run [Color Registration].	<a href="#">11-30</a>
<b>Colors appear different than you anticipated.</b>	Did you choose appropriate image quality for the original?	Select appropriate image quality.	<a href="#">6-17</a>
	Have you loaded color copy paper into the paper tray?	Load color copy paper into the paper tray.	—
	—	Run [Calibration].	<a href="#">11-30</a>
	—	Run [Tone Curve Adjustment]	<a href="#">11-30</a>
	—	(When making copies) Adjust the color balance.	<a href="#">6-20</a>
	—	(When printing from a computer) Adjust the color using the printer driver.	—
<b>"Perform Tone Curve Adjustment in the System Menu." is displayed.</b>	Over long periods of use, the effects of the ambient temperature and humidity can cause color output hues to vary slightly.	Run [Tone Curve Adjustment]	<a href="#">11-30</a>
<b>The color toner is empty.</b>	Do you want to continue printing in black and white?	If the black toner is remained, the machine continues printing in black and white by selecting [Print in Black and White] of [Color Toner Empty Action].	<a href="#">8-19</a>

# Responding to Messages

If the touch panel or the computer displays any of these messages, follow the corresponding procedure.

 **NOTE**

When contacting us, the serial number will be necessary. To check the serial number, refer to the following:

➔ [Display for Device Information \(3-11\)](#)

**A**

Error Message	Checkpoints	Corrective Actions	Reference Page
<b>Acceptable staple count exceeded.</b>	Is the acceptable staple count exceeded?	Select [Continue] to print without stapling. Select [Cancel] to cancel the job.	-
<b>Access point was not detected.</b>	-	Check if the access point has been set correctly.	<a href="#">2-15</a>
<b>Activation error.</b>	-	Turn the power switch off and on. If the error exists, contact administrator.	<a href="#">2-9</a>
<b>Add staples.</b>	Has any of the document finisher run out of staples?	If the staples are depleted, the machine will stop and the location of staple depletion will be indicated on the screen. Leave the machine on and follow the instruction to replace the staple case.  Select [Continue] to print without stapling. Press [Cancel] to cancel the job.	<a href="#">10-10</a>
<b>Add the following paper in cassette #.</b>	Is the indicated cassette out of paper?	Load paper. Select [Paper Selection] to select the other paper source. Select [Continue] to print on the paper in the currently selected paper source.	<a href="#">3-19</a>
<b>Add the following paper in the multipurpose tray.</b>	Does the paper size set for the paper source matches the paper size that was actually loaded?	Select [Continue] to continue printing. Select [Cancel] to cancel the job.	<a href="#">5-7</a>
	Is the indicated cassette out of paper?	Load paper. Select [Paper Selection] to select the other paper source. Select [Continue] to print on the paper in the currently selected paper source.	<a href="#">3-19</a>
<b>Adjusting...</b>	-	The machine is under the adjustment to maintain its quality. Please wait.	-

**B**

Error Message	Checkpoints	Corrective Actions	Reference Page
<b>Box is not found.</b>	-	The specified box cannot be found. Job is canceled. Select [End].	-
<b>Box limit exceeded.</b>	Is [End] displayed on the screen?	The specified box is full, and no further storage is available; Job is canceled. Select [End]. Try to perform the job again after printing or deleting data from the box.	-

**C**

Error Message	Checkpoints	Corrective Actions	Reference Page
<b>Cassette is not installed.</b>	-	Cannot feed paper. Set the cassette indicated on the screen.	-
<b>Calibrating...</b>	-	The machine is under the adjustment to maintain its quality. Please wait.	-
<b>Cannot connect to Authentication Server.</b>	-	Set machine time to match the server's time.	<a href="#">2-12</a>
	-	Check the domain name.	<a href="#">9-5</a>
	-	Check the host name.	<a href="#">9-5</a>
	-	Check the connection status with the server.	-
<b>Cannot connect.</b>	-	This appears when the Wi-Fi or Wi-Fi Direct connection did not complete. Check the settings, and check the signal conditions.	-
<b>Cannot duplex print on the following paper.</b>	Did you select a paper size/type that cannot be duplex printed?	Select [Paper Selection] to select the available paper. Select [Continue] to print without using Duplex function.	-
<b>Cannot offset the following paper.</b>	Did you select a paper size/type that cannot be offset?	Select [Paper Selection] to select the available paper. Select [Continue] to print without using Offset function.	<a href="#">6-10</a>
<b>Cannot print the specified number of copies.</b>	-	<p>Only one copy is available. Select [Continue] to continue printing. Select [Cancel] to cancel the job.</p> <p>The machine may reproduce the same originals by arranging the following settings:</p> <ul style="list-style-type: none"> <li>- Uncheck [RAM Disk] in the "Device Settings" tab of the printer's properties.</li> </ul> <p> <b>NOTE</b></p> <p>If you unchecked the [RAM Disk], check the [RAM Disk] again after the printing is completed. If not, print speed may be reduced.</p>	<a href="#">8-55</a>



Error Message	Checkpoints	Corrective Actions	Reference Page
<b>Cannot print the specified number of copies.</b>	Do you want to print the data stored in the USB memory?	<p>Only one copy is available. Select [Continue] to continue printing. Select [Cancel] to cancel the job.</p> <p>The machine may reproduce the same originals by arranging the following settings:</p> <ul style="list-style-type: none"> <li>-Reduce the number of copies to be printed at once.</li> </ul> <p>Furthermore, the machine may reproduce the same originals by arranging the following settings:</p> <ul style="list-style-type: none"> <li>- Select [Copy Priority] of "Optional Memory" in [System Menu].</li> </ul> <p> <b>NOTE</b></p> <p>Before changing the "Optional Memory" setting, contact your administrator.</p>	-
<b>Cannot process this job.</b>	-	This job is canceled because it is restricted by User Authorization or Job Accounting. Select [End].	-
<b>Cannot read data in this ID card.</b>	-	<p>In registration process, the ID card information was not read correctly. Hold again the ID card over the ID card reading part.</p> <p>If the same message still appears, the ID card may not be compatible with this product. Change it to another ID card.</p>	<a href="#">9-9</a>
<b>Cannot recognize.</b>	-	Make sure your ID card has been registered.	<a href="#">9-26</a>
<b>Cannot staple at the specified position.</b>	Have you selected a position that cannot be stapled?	Select [Paper Selection] to select the available paper. Select [Continue] to print without using Staple function.	-
<b>Cannot staple the following paper.</b>	Did you select a paper size/type that cannot be stapled?	Press Select [Paper Selection] to select the available paper. Press Select [Continue] to print without using Staple function.	-
<b>Cassette is not installed.</b>	-	Cannot feed paper. Set the cassette indicated on the screen.	-
<b>Cassette # failure.</b>	-	Contact your Service Representative.	-
<b>Check the document processor.</b>	Is the document processor open?	Close the document processor.	<a href="#">11-41</a>
<b>Check waste toner box.</b>	-	The waste toner box is not installed correctly. Set it correctly.	<a href="#">10-7</a>
	Is the waste toner box full?	Replace the waste toner box.	<a href="#">10-7</a>
<b>Cleaning the laser scanner....</b>	-	The machine is under the adjustment to maintain its quality. Please wait.	-

D

Error Message	Checkpoints	Corrective Actions	Reference Page
Developer unit is not installed. [C][M][Y][K]	-	Replace the developer unit (g). See the leaflet supplied with the developer unit.	-
Drum unit is not installed. [C][M][Y][K]	-	Replace the drum unit. See the leaflet supplied with the drum unit for details.	-

E

Error Message	Checkpoints	Corrective Actions	Reference Page
Error occurred at cassette #.	-	Remove the indicated cassette. Select [Next >] to follow the instructions.	-

F

Error Message	Checkpoints	Corrective Actions	Reference Page
Failed to send the file information.	Is the machine and the PC to which the scanned image is to be sent connected to the network?	<p>Check the network and SMB settings.</p> <ul style="list-style-type: none"> <li>- The network cable is connected.</li> <li>- The hub is not operating properly.</li> <li>- The server is not operating properly.</li> <li>- Host name and IP address</li> <li>- Port number</li> </ul>	<a href="#">2-7</a>
	Is the account information (user ID, password) used to access the shared folder to which the scanned image is to be sent incorrect?	<p>Check the following settings of the PC to which the scanned image is to be sent.</p> <ul style="list-style-type: none"> <li>- Host name</li> <li>- Path</li> <li>- Login user name</li> </ul> <p> <b>NOTE</b></p> <p>If the sender is a domain user, specify the domain name. [Login User ID]@[Domain Name] Example: sa720XXXX@km</p> <ul style="list-style-type: none"> <li>- Login password</li> <li>- Folder share permissions of the recipient</li> </ul>	-
Failed to specify Job Accounting.	-	Failed to specify Job Accounting when processing the job externally. The job is canceled. Select [End].	-
Failed to store job retention data.	-	The job is canceled. Select [End]. Insufficient free space in the Job Box. Try to perform the job again after printing or deleting data from the Job Box.	-

Error Message	Checkpoints	Corrective Actions	Reference Page
<b>Finisher tray is full of paper.</b>	Is the acceptable storage capacity exceeded for the document finisher tray?	Remove paper from the document finisher tray.	-
<b>Fuser unit is not installed.</b>	-	Replace the fuser unit (h-1). See the leaflet supplied with the fuser unit for details.	-

**H**

Error Message	Checkpoints	Corrective Actions	Reference Page
<b>High temperature. Adjust room temp.</b>	-	Adjust the temperature and the humidity of your room.	-

**I**

Error Message	Checkpoints	Corrective Actions	Reference Page
<b>Incorrect account ID.</b>	-	The account ID was incorrect when processing the job externally. The job is canceled. Select [End].	-
<b>Incorrect box password.</b>	-	The box password was incorrect when processing the job externally. The job is canceled. Select [End].	-
<b>Incorrect Login User Name or Password.</b>	-	The login user name or password was incorrect when processing the job externally. The job is canceled. Select [End].	-
<b>Inner tray is full of paper.</b>	-	Remove paper from the inner tray. Printing then resumes.	-
<b>Intermediate transfer unit is not installed.</b>	-	Replace the intermediate transfer unit (r). See the leaflet supplied with intermediate transfer unit.	-

**J**

Error Message	Checkpoints	Corrective Actions	Reference Page
<b>Job Accounting restriction exceeded.</b>	Is the acceptable printing count restricted by Job Accounting exceeded?	The printing count exceeded the acceptable count restricted by Job Accounting. Cannot print any more. This job is canceled. Select [End].	-
<b>Job separator tray is full of paper.</b>	Is the maximum capacity of the job separator tray exceeded?	Follow the instruction indicated on the machine and remove paper from the job separator tray.	-

**K**

Error Message	Checkpoints	Corrective Actions	Reference Page
<b>KPDL error.</b>	-	PostScript error has occurred. The job is canceled. Select [End].	-

**L**

Error Message	Checkpoints	Corrective Actions	Reference Page
<b>Low temperature. Adjust room temp.</b>	-	Adjust the temperature and the humidity of your room.	-

**M**

Error Message	Checkpoints	Corrective Actions	Reference Page
<b>Machine failure.</b>	-	Internal error has occurred. Make a note of the error code displayed on the screen, and contact your Service Representative.	-
<b>Maximum number of scanned pages.</b>	Is the acceptable scanning count exceeded?	Only one copy of the scanned pages is available. Send the excess pages separately. Press [Continue] to print, send or store the scanned pages. Press [Cancel] to cancel printing, sending or storing.	-
<b>Memory card error.</b>	-	An error has occurred on the memory card. Job is canceled. Select [End]. The error cord is as follows. 04: Insufficient space on the memory card to complete this operation. Move data or delete unneeded data.	-
<b>Memory is full.</b>	Do you want to send the scanned image to the PC, or store the image in the machine?	The process cannot be performed due to insufficient memory. If only [End] is available, select [End]. The job will be canceled. The machine may reproduce the same originals by arranging the following settings: - Decrease [Image Quality] of [File Format]. Furthermore, the machine may reproduce the same originals by arranging the following settings: - Select [Normal] of "Optional Memory" in [System Menu].  <b>NOTE</b> Before changing the "Optional Memory" setting, contact your administrator.	<a href="#">8-55</a>

Error Message	Checkpoints	Corrective Actions	Reference Page
<b>Memory is full.</b>	Do you want to print data from the PC?	<p>Unable to continue the job as the memory is used up. Select [Continue] to print the scanned pages. The print job cannot be processed completely. Select [Cancel] to cancel the job.</p> <p>The machine may reproduce the same originals by arranging the following settings:</p> <ul style="list-style-type: none"> <li>- Select [On] of "RAM Disk Setting" in [System Menu], and then decrease the RAM disk size.</li> <li>- Select [Printer Priority] of "Optional Memory" in [System Menu].</li> </ul> <p> <b>NOTE</b> Before changing the "RAM Disk Setting" or "Optional Memory" setting, contact your administrator.</p>	<a href="#">8-55</a>
<b>MK near end.</b>	-	It is almost time to replace the parts. Obtain the maintenance kit container. Contact your Service Representative.	-

**N**

Error Message	Checkpoints	Corrective Actions	Reference Page
<b>Non-genuine Toner.</b>	Is the installed toner container our own brand?	We will not be liable for any damage caused by the use of third party supplies in this machine.	<a href="#">10-4</a>

**O**

Error Message	Checkpoints	Corrective Actions	Reference Page
<b>Only one destination is available for FAX Polling RX. Enter the destination again.</b>	Did you specify multiple contacts for polling reception?	Only one contact can be specified at a time for polling reception. Specify the contact again.	-

**P**

Error Message	Checkpoints	Corrective Actions	Reference Page
Paper is left.	-	Remove paper from the document finisher.	-
Paper jam.	-	If a paper jam occurs, the machine will stop and the location of the jam will be indicated on the screen. Leave the machine on and follow the instruction to remove the jammed paper.	<a href="#">11-33</a>
Perform Tone Curve Adjustment.	Over long periods of use, the effects of the ambient temperature and humidity can cause color output hues to vary slightly.	Run [Tone Curve Adjustment].	<a href="#">11-30</a>
Performing Drum Refresh...	-	The machine is under the adjustment to maintain its quality. Please wait.	<a href="#">11-32</a>
Preparing...	-	The machine is under the adjustment to maintain its quality. Please wait.	-

**R**

Error Message	Checkpoints	Corrective Actions	Reference Page
RAM disk error.	-	An error has occurred on the RAM disk. Job is canceled. Select [End]. The error cord is as follows. 04: Insufficient space on the RAM disk. If the optional RAM dis is installed, increase the RAM disk size by changing "RAM Disk Setting" in [System Menu].  <b>NOTE</b> The range of RAM disk size can be increased by selecting [Printer Priority] in "Optional Memory".	<a href="#">8-55</a>
Register with Google Cloud Print. Are you sure?	-	The message is displayed when this machine? receives the register request for Google Cloud Print. Select the [Yes] key to register the printer as a Google Cloud Print device. Select the [No] key to cancel the registration.	<a href="#">5-45</a>

Error Message	Checkpoints	Corrective Actions	Reference Page
<b>Removable memory error.</b>	Is writing to a removable memory prohibited?	An error occurred in the removable memory. The job stopped. Select [End]. The error cord is as follows. 01: Connect a removable memory that can be written to.	-
	-	An error occurred in the removable memory. The job stopped. Select [End]. The error cord is as follows. 01: The amount of data that can be saved at once has been exceeded. Restart the system or turn the power OFF/ON. If the error still occurs, the removable memory is not compatible with the machine. Use the removable memory formatted by this machine. If the removable memory cannot be formatted, it is damaged. Connect a compatible removable memory.	<a href="#">7-10</a>
<b>Removable Memory is full.</b>	-	Job is canceled. Select [End]. Insufficient free space in the removable memory. Delete unnecessary files.	-
<b>Remove originals in the document processor.</b>	Are there any originals left in the document processor?	Remove originals from the document processor.	<a href="#">11-41</a>
<b>Replace all originals and press [Continue].</b>	-	Remove originals from the document processor, put them back in their original order, and place them again. Select [Continue] to resume printing. Select [Cancel] to cancel the job.	-
<b>Replace MK.</b>	-	Replacement of the parts in the maintenance kit is necessary at every 200,000 pages of printing and requires professional servicing. Contact your Service Representative.	-
<b>Running security function...</b>	-	Running security function. Please wait.	-

**S**

Error Message	Checkpoints	Corrective Actions	Reference Page
<b>Scanner memory is full.</b>	-	<p>Scanning cannot be performed due to insufficient memory of scanner. Only one copy of the scanned pages is available. Select [Continue] to print, send or store the scanned pages. Select [Cancel] to cancel the printing job.</p> <p>The machine may reproduce the same originals by arranging the following settings:</p> <ul style="list-style-type: none"> <li>-Reduce the number of originals to be scanned at once.</li> </ul> <p>Furthermore, the machine may reproduce the same originals by arranging the following settings:</p> <ul style="list-style-type: none"> <li>- Select [Copy Priority] of "Optional Memory" in [System Menu].</li> </ul> <p> <b>NOTE</b></p> <p>Before changing the "Optional Memory" setting, contact your administrator.</p>	<a href="#">8-55</a>
<b>Scheduled sending jobs exceeded.</b>	-	<p>The number of jobs has exceeded the limit set for delayed transmission. Select [End]. The job is canceled.</p> <p>Wait until the delayed transmission is executed, or cancel the delayed transmission and then perform the job again.</p>	-
<b>Send error.</b>	-	<p>An error has occurred during transmission. The job is canceled. Select [End].</p> <p>Refer to Responding to Send Error for the error code and corrective actions.</p>	<a href="#">11-22</a>
<b>Set cassette.</b>	Have the paper width guide and paper length guide been loaded properly?	Load the paper width guide and paper length guide properly so that there is no space between the guides and the paper.	-
<b>Shake the toner container.</b>	-	Open the front cover of the machine and pull out the toner container indicated on the screen. Shake the toner container well and reinstall it.	-



Error Message	Checkpoints	Corrective Actions	Reference Page
<b>SSD error.</b>	-	<p>An error has occurred on SSD. Job is canceled. Select [End].</p> <p>The error cords are as follows.</p> <p>01: The amount of data that can be saved at once has been exceeded. Turn the power OFF/ON. If the error still occurs, divide the file into smaller files. If the error occurs after the file is divided, the specified file may be damaged. Delete the file.</p> <p>04: Insufficient space on SSD to complete this operation. Move data or delete unneeded data.</p> <p> <b>NOTE</b></p> <p>Please be aware that when you carry out initialization of the system, the data saved in SSD will be erased.</p>	-
<b>Staple jam.</b>	-	<p>If a staple jam occurs, the machine will stop and the location of the jam will be indicated on the screen. Leave the machine on and follow the instruction to remove the jammed staple.</p>	-
<b>System error.</b>	-	<p>System error has occurred. Follow the instructions on the screen.</p>	-

**T**

Error Message	Checkpoints	Corrective Actions	Reference Page
<b>The cover is open.</b>	Is there any cover which is open?	Close the cover indicated on the screen.	-
	Is the top cover of the document processor open?	Close the document processor cover.	-
<b>The device cannot be connected because allowed connections would be exceeded.</b>	Are three handheld devices connected simultaneously?	Cancel a connection to a portable device that is not being used, or set the machine's auto disconnect time to break portable device connections.	-
<b>The manufacturer assumes no responsibility for damage caused by a non-genuine toner.</b>	Is the installed toner container our own brand?	We will not be liable for any damage caused by the use of third party supplies in this machine. If you want to continue, select [Next >].	<a href="#">10-4</a>
<b>The phone receiver is off the hook.</b>	-	Put down the receiver.	-
<b>The SD Card is not formatted.</b>	Is the SD Card formatted by this machine?	Select [Format] from [Common Settings], under [System Menu].	-

Error Message	Checkpoints	Corrective Actions	Reference Page
The slit glass requires cleaning.	-	Clean the slit glass using the cleaning cloth supplied with the document processor.	<a href="#">10-2</a>
This ID card is already registered to another user.	-	Your ID card has already been registered. Change it to another ID card.	-
This memory is not formatted. This will be formatted. Are you sure?	Is the removable memory formatted by this machine?	Perform [Format] on this machine.	<a href="#">7-10</a>
This user account is locked out.	-	Contact administrator. Job is canceled. Select [End].	-
Toner container not installed.	-	Install the toner container.	<a href="#">10-4</a>
Toner [C][M][Y][K] are empty.	-	Replace the toner container.   <b>NOTE</b> If the color toner is empty but the black toner is remained, the machine continues printing in black and white by selecting [Print in Black and White] of "Color Toner Empty Action".	<a href="#">10-4</a>
Toner is low. [C][M][Y][K] (Replace when empty.)	-	It is almost time to replace the toner container. Obtain a new toner container.	<a href="#">10-4</a>

**U**

Message	Checkpoints	Corrective Actions	Reference Page
Unknown Toner Installed. PC [C][M][Y][K]	Does the installed toner container's regional specification match the machine's?	Install the specified container.	<a href="#">10-4</a>
Use MP tray to print on the following paper.	-	Set paper displayed on the screen and press [Continue].	-

**W**





Message	Checkpoints	Corrective Actions	Reference Page
Warning low memory.	-	Cannot start the job. Try again later.	-

Y

Message	Checkpoints	Corrective Actions	Reference Page
You cannot use this box.	-	You cannot use the specified box. Job is canceled. Select [End].	-

## Responding to Send Error

The send error displayed on the screen are as follows.

Error Code	Message	Corrective Actions	Reference Page
1101	Failed to send the e-mail.	Check the host name of the SMTP server on the Command Center RX.	<a href="#">2-45</a>
	Failed to send via FTP.	Check the host name of FTP.	<a href="#">5-18</a>
	Failed to send via SMB.	Check the host name of SMB.	<a href="#">5-16</a>
1102	Failed to send via SMB.	Check the SMB settings. <ul style="list-style-type: none"> <li>Login user name and login password</li> </ul>  <b>NOTE</b> If the sender is a domain user, specify the domain name. <ul style="list-style-type: none"> <li>Host name</li> <li>Path</li> </ul>	<a href="#">5-16</a>
	Failed to send the e-mail.	Check the following on the Command Center RX. <ul style="list-style-type: none"> <li>SMTP login user name and login password</li> <li>POP3 login user name and login password</li> <li>E-mail size limit</li> </ul>	<a href="#">2-45</a>
	Failed to send via FTP.	Check the FTP settings. <ul style="list-style-type: none"> <li>Login user name and login password</li> </ul>  <b>NOTE</b> If the sender is a domain user, specify the domain name. <ul style="list-style-type: none"> <li>Path</li> <li>Folder share permissions of the recipient</li> </ul>	<a href="#">5-18</a>
1103	Failed to send via SMB.	Check the SMB settings. <ul style="list-style-type: none"> <li>Login user name and login password</li> </ul>  <b>NOTE</b> If the sender is a domain user, specify the domain name. <ul style="list-style-type: none"> <li>Path</li> <li>Folder share permissions of the recipient</li> </ul>	<a href="#">5-16</a>
	Failed to send via FTP.	Check the FTP settings. <ul style="list-style-type: none"> <li>Path</li> <li>Folder share permissions of the recipient</li> </ul>	<a href="#">5-18</a>
1104	Failed to send the e-mail.	Check the e-mail address.  <b>NOTE</b> If the address is rejected by the domain, you cannot send the email.	<a href="#">5-14</a>

Error Code	Message	Corrective Actions	Reference Page
1105	Failed to send via SMB.	Check the following settings. [System Menu / Counter] key > [Function Key Assignment] > [Menu] > [Store File] > [Quick Setup Wizard] > [SMB Client (Transmission)]	<a href="#">5-16</a>
	Failed to send the e-mail.	Select [Submit] of the SMTP settings on the Command Center RX.	<a href="#">2-45</a>
	Failed to send via FTP.	Check the following settings. [System Menu / Counter] key > [Function Key Assignment] > [Menu] > [Store File] > [Quick Setup Wizard] > [Function Type]	<a href="#">5-18</a>
1106	Failed to send the e-mail.	Check the sender address of SMTP on the Command Center RX.	<a href="#">2-45</a>
1131	Failed to send via FTP.	Enable the SSL. [System Menu / Counter] key > [Function Key Assignment] > [Menu] > [Report] > [Print]	<a href="#">5-18</a>
1132	Failed to send the e-mail.	Check the following of the SMTP server. <ul style="list-style-type: none"> <li>• Is SMTP over SSL available?</li> <li>• Is the encryption available?</li> </ul>	Refer to the Command Center RX User Guide.
	Failed to send via FTP.	Check the following of the FTP server. <ul style="list-style-type: none"> <li>• Is FTPS available?</li> <li>• Is the encryption available?</li> </ul>	—
2101	Failed to send via SMB.	Check the network and SMB settings. <ul style="list-style-type: none"> <li>• The network cable is connected.</li> <li>• The hub is not operating properly.</li> <li>• The server is not operating properly.</li> <li>• Host name and IP address</li> <li>• Port number</li> </ul>	—
	Failed to send via FTP.	Check the network and FTP settings. <ul style="list-style-type: none"> <li>• The network cable is connected.</li> <li>• The hub is not operating properly.</li> <li>• The server is not operating properly.</li> <li>• Host name and IP address</li> <li>• Port number</li> </ul>	—
	Failed to send the e-mail.	Check the network and Command Center RX. <ul style="list-style-type: none"> <li>• The network cable is connected.</li> <li>• The hub is not operating properly.</li> <li>• The server is not operating properly.</li> <li>• POP3 server name of the POP3 user</li> <li>• SMTP server name</li> </ul>	<a href="#">2-45</a>

Error Code	Message	Corrective Actions	Reference Page
2102 2103	Failed to send via FTP.	Check the network. <ul style="list-style-type: none"> <li>The network cable is connected.</li> <li>The hub is not operating properly.</li> <li>The server is not operating properly.</li> </ul>	—
		Check the following of the FTP server. <ul style="list-style-type: none"> <li>Is FTP available?</li> <li>The server is not operating properly.</li> </ul>	—
	Failed to send the e-mail.	Check the network. <ul style="list-style-type: none"> <li>The network cable is connected.</li> <li>The hub is not operating properly.</li> <li>The server is not operating properly.</li> </ul>	—
2201 2202 2203 2231	Failed to send the e-mail. Failed to send via FTP. Failed to send via SMB.	Check the network. <ul style="list-style-type: none"> <li>The network cable is connected.</li> <li>The hub is not operating properly.</li> <li>The server is not operating properly.</li> </ul>	—
2204	Failed to send the e-mail.	Check the e-mail size limit of the SMTP settings on the Command Center RX.	<a href="#">2-45</a>
3101	Failed to send the e-mail.	Check the authentication methods of both the sender and the recipient.	—
	Failed to send via FTP.	Check the network. <ul style="list-style-type: none"> <li>The network cable is connected.</li> <li>The hub is not operating properly.</li> <li>The server is not operating properly.</li> </ul>	—
3201	Failed to send the e-mail.	Check the SMTP user authentication method of the recipient.	—
0007 4201 4701 5101 5102 5103 5104 7101 7102 7103 720f	—	Turn the power switch off and back on. If this error occurs several times, make a note of the displayed error code and contact your service representative.	<a href="#">2-10</a>

# Adjustment/Maintenance

## Overview of Adjustment/Maintenance

If there is an image problem and the message to run adjustment or maintenance menu appears, run Adjustment/Maintenance in the system menu.

The table below lists the item you can Procedure.

Menu	Description	Reference Page
<b>Color Registration</b>	Perform the color registration.	<a href="#">11-25</a>
<b>Tone Curve Adjustment</b>	Adjust the tone curve of the printed image.	<a href="#">11-30</a>
<b>Drum Refresh</b>	Remove image blur and white dots from the printout.	<a href="#">11-32</a>
<b>Calibration</b>	Using this function enables printing in the most appropriate color by adjusting hue and color drift in detail.	<a href="#">11-30</a>
<b>Laser Scanner Cleaning</b>	Remove vertical lines from the printout.	<a href="#">11-30</a>

## Color Registration Procedure

Perform the color registration. However, if it is not resolved or to perform more detailed settings, use the manual registration.

 **IMPORTANT**

Before performing color registration, be sure to perform Calibration. If color drift remains, perform color registration. By performing color registration without performing Calibration, the color drift will be resolved once, however, it may cause the serious color drift later.

## Auto Correction

### 1 Load paper.

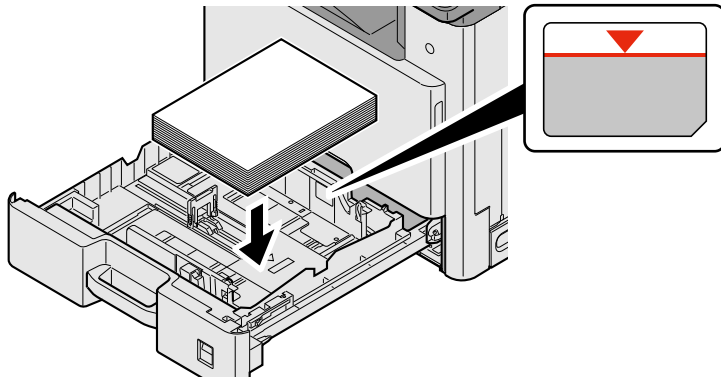

#### ✓ IMPORTANT

- Load the paper with the print side facing up.
- After removing new paper from its packaging, fan the paper before loading it in the multi-purpose tray.
- ▶ [Precaution for Loading Paper \(3-17\)](#)
- Before loading the paper, be sure that it is not curled or folded. Paper that is curled or folded may cause paper jams.
- Ensure that the loaded paper does not exceed the level indicator.
- If paper is loaded without adjusting the paper length guide and paper width guide, the paper may skew or become jammed.

### 2 Display the screen.

[System Menu / Counter] key > [Adjustment/Maintenance] > [Color Registration] > [Auto]

### 3 Print the chart.

Select [Start].

A chart is printed.

## Chart Example

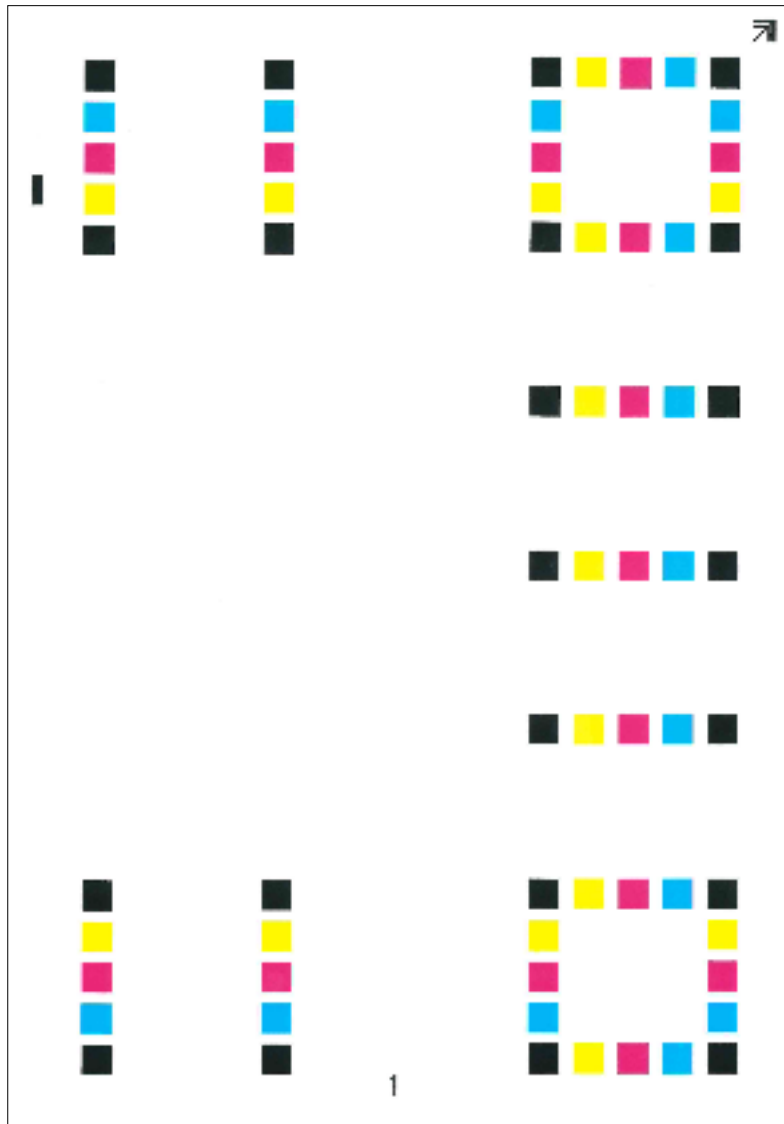

## 4 Correction

- 1 As shown in the illustration, place the printed side down on the platen with the edge with the arrows toward the back.

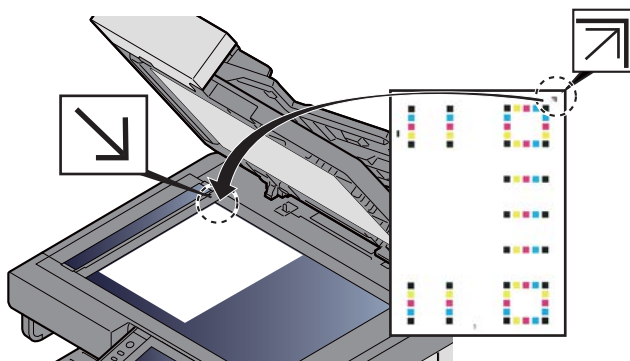

- 2 Select [Start] to scan the chart.  
When scanning is finished, color printing position correction starts.
- 3 Select [OK] after color registration is complete.



## Manual setting

### 1 Load paper.

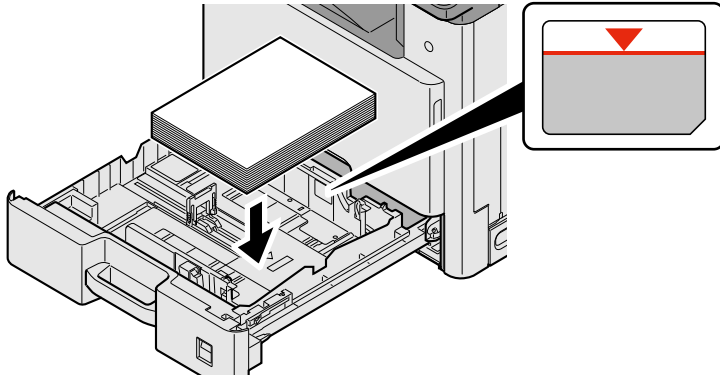

#### ✔ IMPORTANT

- Load the paper with the print side facing up.
- After removing new paper from its packaging, fan the paper before loading it in the multi-purpose tray.
- ▶ [Precaution for Loading Paper \(3-17\)](#)
- Before loading the paper, be sure that it is not curled or folded. Paper that is curled or folded may cause paper jams.
- Ensure that the loaded paper does not exceed the level indicator.
- If paper is loaded without adjusting the paper length guide and paper width guide, the paper may skew or become jammed.

### 2 Display the screen.

[System Menu / Counter] key > [Adjustment/Maintenance] > [Color Registration] > [Manual]

### 3 Print the chart.

Select [Print Chart].

A chart is printed. On the chart, for each of M (magenta), C (cyan) and Y (yellow), charts for H-1 to 7 and V-1/3/5 are printed.

**Chart Example**



**4 Enter the appropriate value.**

- 1 Find the location on each chart where 2 lines most closely match. If this is the 0 position, registration for that color is not required. For the illustration, B is the appropriate value.

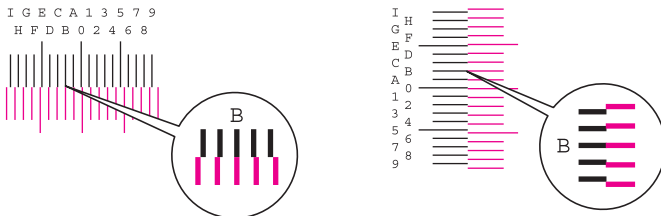

From charts H-1 to H-7, read the values from H-1 to H-7.

From charts V-1/3/5, read only the values from V-3 (center).

- 2 Select [Color Registration] [OK].
- 3 Select [Start] of the chart to be corrected.
- 4 Select [+] or [-] to enter the values read from the chart. Select [OK].  
 Select [+] to increase the value from 0 to 9. To decrease, select [-].  
 By selecting [-], the value changes from 0 to alphabetic letters, going from A to I. To move in the reverse direction, select [+]. To decrease, select [-].  
 You cannot use the numeric keys to enter these values.
- 5 Repeat steps 3 and 4 to enter the registration values for each chart. Select [OK]
- 6 Select [Start] after all values have been entered. Color registration begins.
- 7 Select [OK] after color registration is complete.

## Calibration

Using this function enables printing in the most appropriate color by adjusting hue and color drift in detail.

### 1 Display the screen.

[System Menu / Counter] key > [Adjustment/Maintenance] > [Calibration]

### 2 Perform adjustment.

Select [Start]. Calibration begins.



#### NOTE

When correct toner overlapping is not ensured even after performing calibration, refer to the following:

➔ [Color Registration Procedure 11-25](#)

## Perform the laser scanner cleaning.

Remove vertical white lines from the printout.

### 1 Display the screen.

[System Menu / Counter] key > [Adjustment/Maintenance] > [Laser Scanner Cleaning]

### 2 Perform adjustment.

Select [Start]. Laser Scanner Cleaning begins.

## Tone Curve Adjustment

After prolonged use, or from the effects of surrounding temperature or humidity, the density of printed images may differ from the original. If that is the case, use this function to ensure consistency in density between the printed image and the original. If calibration does not improve the tones, perform this adjustment.

A total of 3 pattern pages (No. 1 to 3) are printed during adjustment in [Copy/Print (600dpi)]. Also, in [Print (1200dpi)], 1 pattern page (No. 1) is printed out. The printed patterns are read sequentially during the adjustment.

## 1 Load paper.

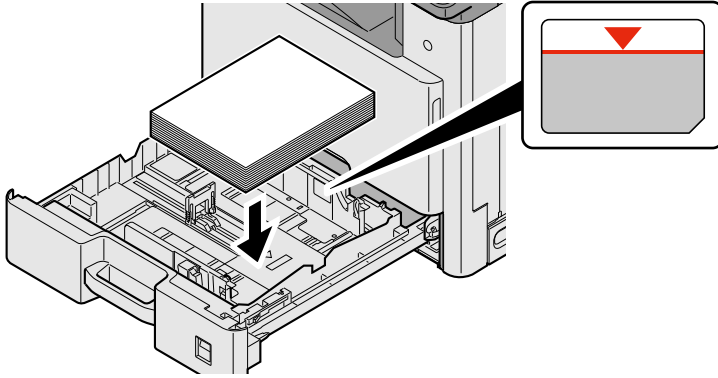

### ✓ IMPORTANT

- Load the paper with the print side facing up.
  - After removing new paper from its packaging, fan the paper before loading it in the multi-purpose tray.
- ➔ [Precaution for Loading Paper \(3-17\)](#)
- Before loading the paper, be sure that it is not curled or folded. Paper that is curled or folded may cause paper jams.
  - Ensure that the loaded paper does not exceed the level indicator.
  - If paper is loaded without adjusting the paper length guide and paper width guide, the paper may skew or become jammed.

## 2 Display the screen.

- 1 [System Menu / Counter] key > [Adjustment/Maintenance] > [Tone Curve Adjustment]
- 2 Select [Copy/Print (600dpi)] or [Print (1200dpi)].

## 3 Perform adjustment.

### [Copy/Print (600dpi)]

3 pattern pages (No. 1 to 3) are printed out.

- 1 Select [Start].  
Check that the number "1" is printed at the bottom of the pattern.
- 2 As shown in the illustration, place the printed side down on the platen with the edge with the arrows toward the back and close the original holder.

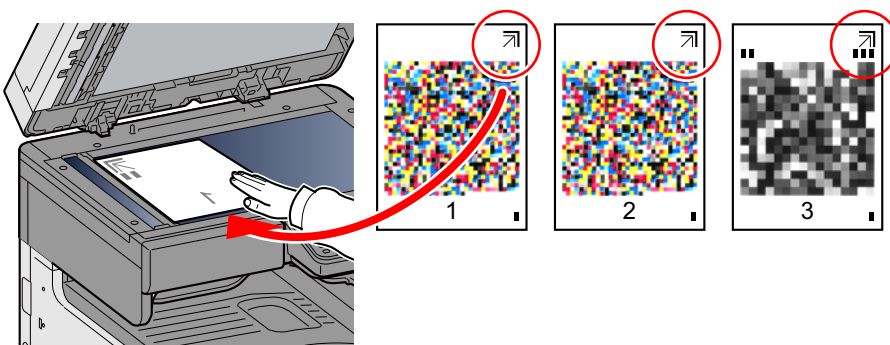

- 3 Select [Start].  
The pattern is read and adjustment begins.  
The second pattern is output.
- 4 Check that the number is printed at the bottom of the pattern and repeat steps 2 to 3 twice to read patterns 2 and 3.
- 5 Select [OK] in the adjustment end confirmation screen.

### [Print (1200dpi)]

In [Print (1200dpi)], 1 pattern page (No. 1) is printed out.

- 1 Start Select [Start].
- 2 As shown in the illustration, place the printed side down on the platen with the edge with the arrows toward the back and close the original holder.

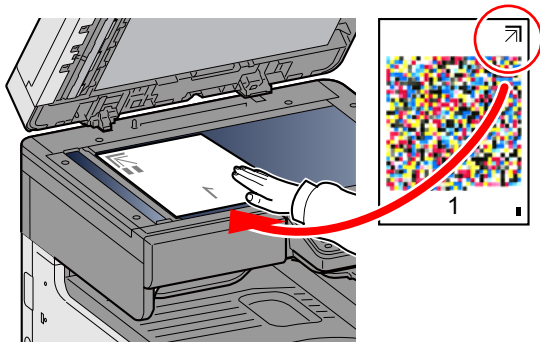

- 3 Select [Start].  
The pattern is read and adjustment begins.
- 4 Select [OK] in the adjustment end confirmation screen.

## Drum Refresh

Remove image blur and white dots from the printout.

### NOTE

Drum Refresh cannot be performed while printing. Execute Drum Refresh after the printing is done.

- 1 **Display the screen.**  
[System Menu / Counter] key > [Adjustment/Maintenance] > [Drum Refresh]
- 2 **Adjust as required.**  
Select [Start]. Drum Refresh begins.

# Clearing Paper Jams

If a paper jam occurs, printing stops and the message below appears on the touch panel along with an indication of the location of the paper jam.

Paper jam.

Refer to these procedures to remove the jammed paper.

## Jam Location Indicators

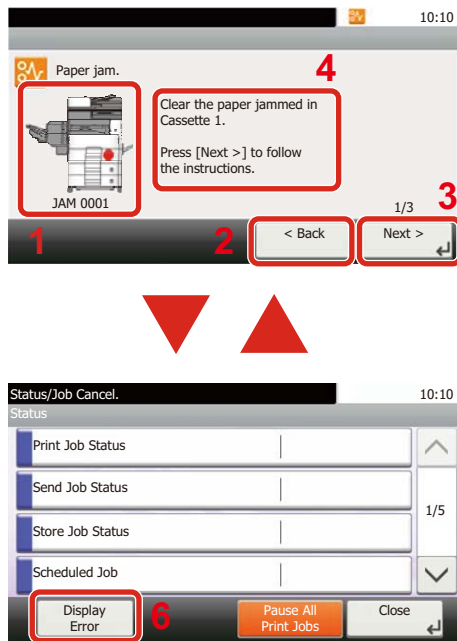

- 1 Shows the location of a paper jam.
- 2 Shows the previous step.
- 3 Shows the next step.
- 4 Shows the removal procedure.
- 5 Selecting the [Status/ Job Cancel] key will cause [Hold] to become selected. Selecting [Hold] displays the status screen, which you can use to check the status of jobs.
- 6 Selecting [Display Error] returns to paper jam guidance.

If a paper jam occurs, the location of the jam will be displayed on the touch panel as well as the clearing instructions.

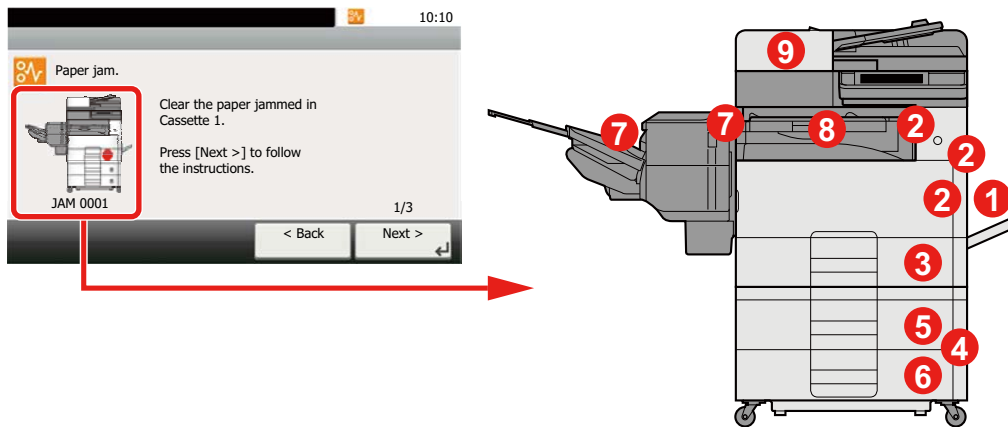

Paper Jam Location Indicator	Paper Jam Location	Reference page
1	Multipurpose Tray	<a href="#">11-34</a>
2	Right Cover 1	<a href="#">11-35</a>
3	Cassette 1	<a href="#">11-36</a>
4	Right Cover 3	<a href="#">11-37</a>
5	Cassette 2	<a href="#">11-36</a>

Paper Jam Location Indicator	Paper Jam Location	Reference page
6	Cassette 3	<a href="#">11-36</a>
7	Document Finisher	<a href="#">11-39</a>
9	Bridge Unit	<a href="#">11-40</a>
8	SpecificationsDocument Processor	<a href="#">11-41</a>

After you remove the jam, the machine will warm up again and the error message will be cleared. The machine resumes with the page that was printing when the jam occurred.

## Remove any jammed paper in the Multipurpose Tray



### CAUTION

- Do not reuse jammed papers.
- If the paper tears during removal, be sure to remove any loose scraps of paper from inside the machine. Scraps of paper left in the machine could cause subsequent jamming.

### 1 Remove any jammed paper.

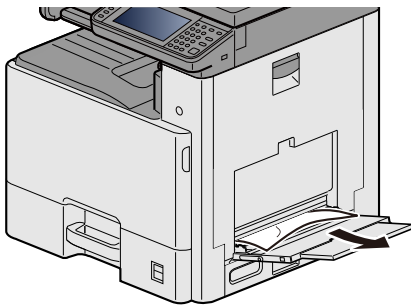

### 2 Remove all the paper.

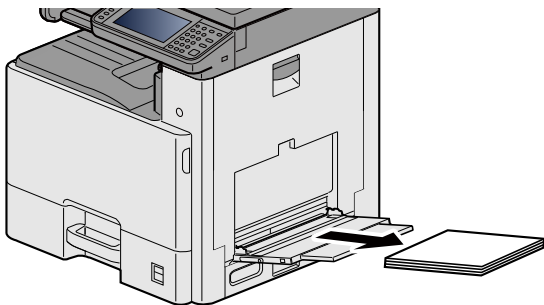

### 3 Reload the paper.

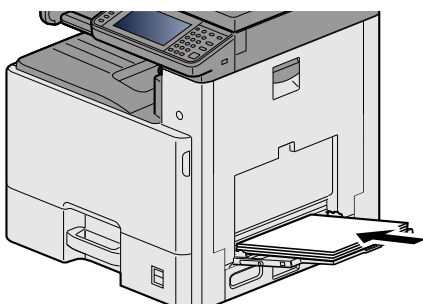

## Remove any jammed paper in Right Cover 1



### CAUTION

The fixing unit is extremely hot. Take sufficient care when working in this area, as there is a danger of getting burned.

- 1 Open Right Cover 1.

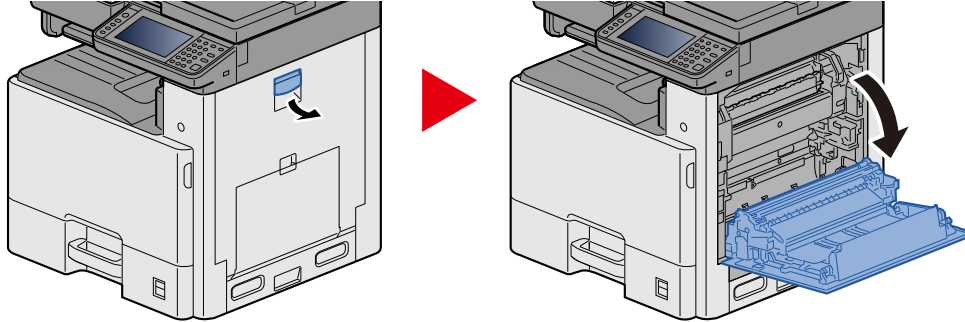

- 2 Remove any jammed paper.

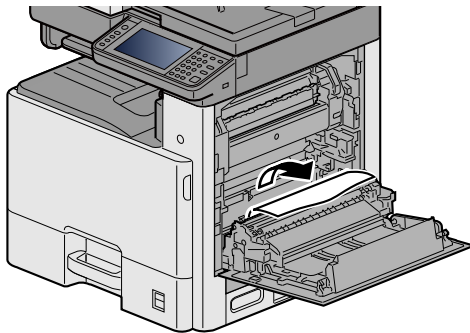

- 3 Open the fuser cover (a) and remove any jammed paper.

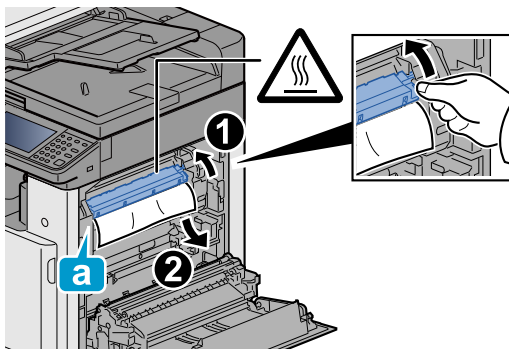



#### 4 Open the duplex unit.

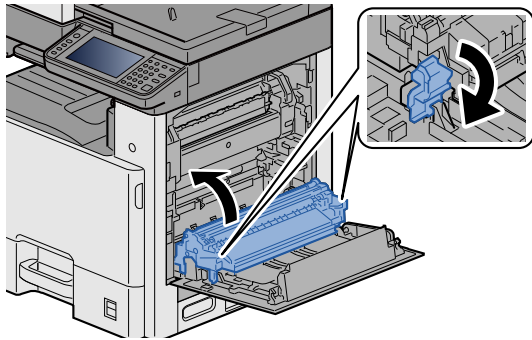

#### 5 Remove any jammed paper.

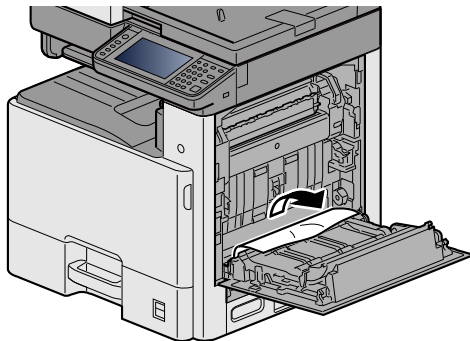

#### 6 Push Right Cover 1.

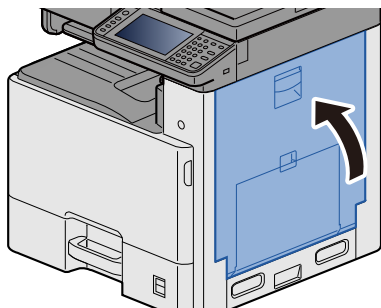

## Remove any jammed paper in Cassette 1, 2 and 3

Here, we'll explain the procedures for Cassette 1, as an example.

### CAUTION

- Do not reuse jammed papers.
- If the paper tears during removal, be sure to remove any loose scraps of paper from inside the machine. Scraps of paper left in the machine could cause subsequent jamming.

- 1 Pull **Cassette 1** out toward you until it stops.

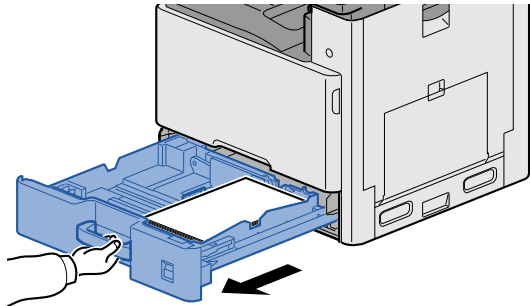

- 2 Remove any jammed paper.

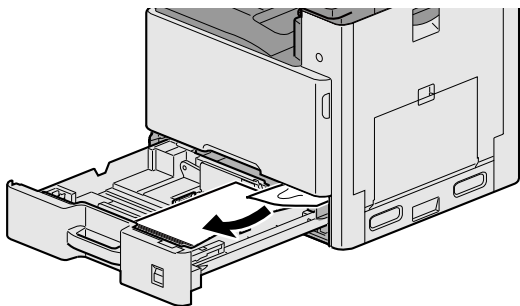

- 3 Push **Cassette 1** back in.

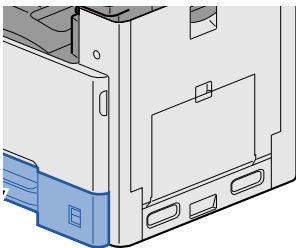

## Remove any jammed paper in Right Cover 2, 3



### CAUTION

- Do not reuse jammed papers.
- If the paper tears during removal, be sure to remove any loose scraps of paper from inside the machine. Scraps of paper left in the machine could cause subsequent jamming.

**1 Open Right Cover 3.**

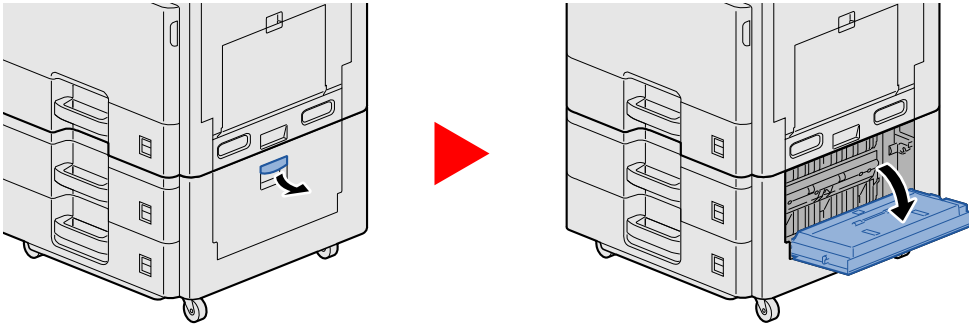

**2 Remove any jammed paper.**

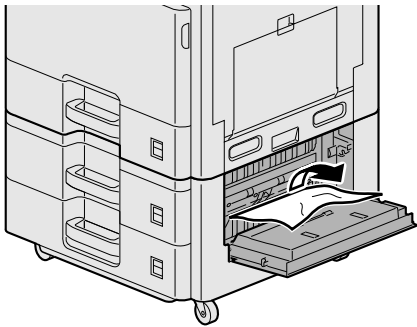

**3 Open Right Cover 2.**

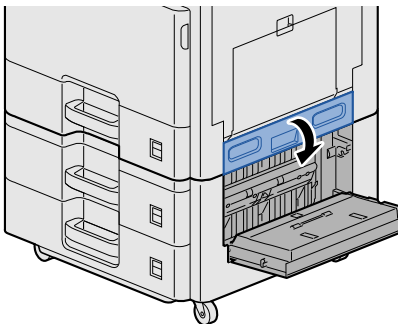

**4 Remove any jammed paper.**

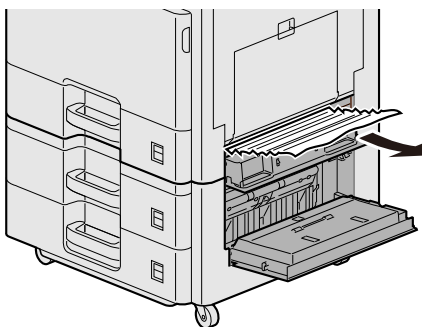

## 5 Push Right Cover 2,3.

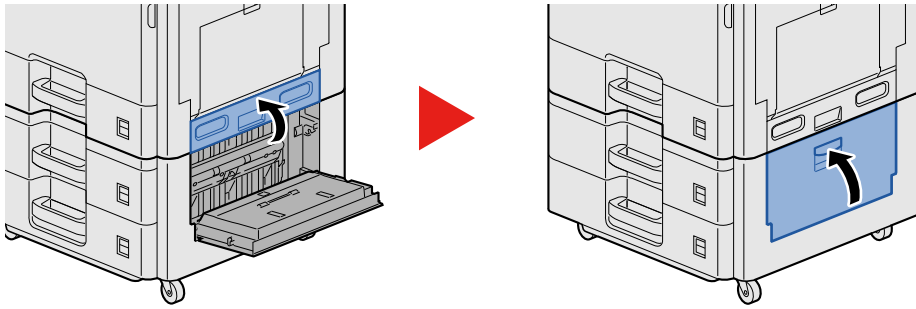

## Remove any jammed paper in the Document Finisher



### CAUTION

- Do not reuse jammed papers.
- If the paper tears during removal, be sure to remove any loose scraps of paper from inside the machine. Scraps of paper left in the machine could cause subsequent jamming.

## 1 Remove any jammed paper.

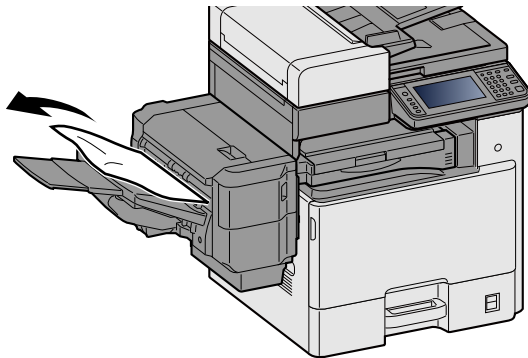

## 2 Open the top cover.

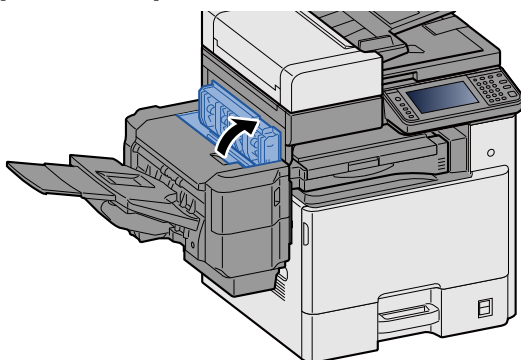

**3 Remove any jammed paper.**

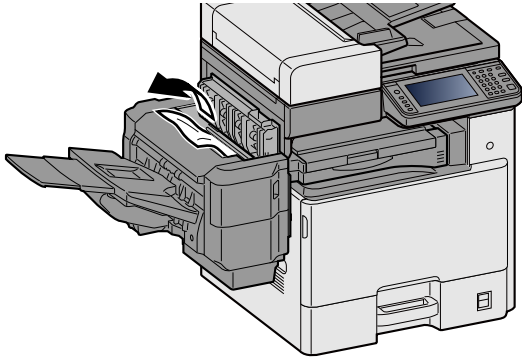

**4 Push the top cover.**

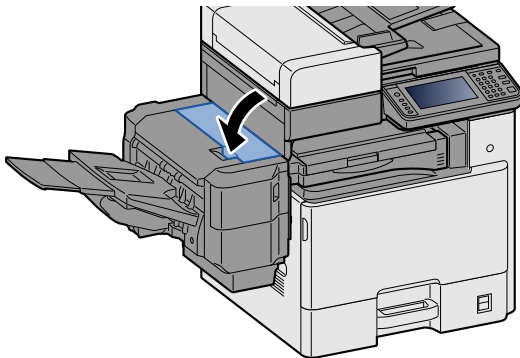

## Remove any jammed paper in the Bridge Unit

**! CAUTION**

- Do not reuse jammed papers.
- If the paper tears during removal, be sure to remove any loose scraps of paper from inside the machine. Scraps of paper left in the machine could cause subsequent jamming.

**1 Open the Bridge Unit cover and remove any jammed paper.**

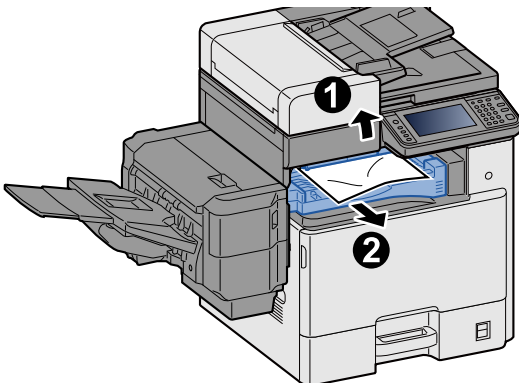

- 2 Return the Bridge Unit cover to its original position.

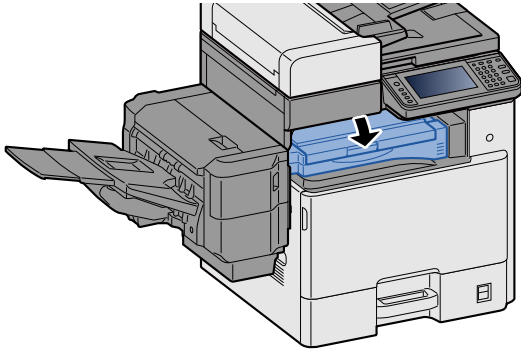

## Remove any jammed paper in the Document Processor



### CAUTION

If the paper tears during removal, be sure to remove any loose scraps of paper from inside the machine. Scraps of paper left in the machine could cause subsequent jamming.

- 1 Remove the originals from the Original Table.

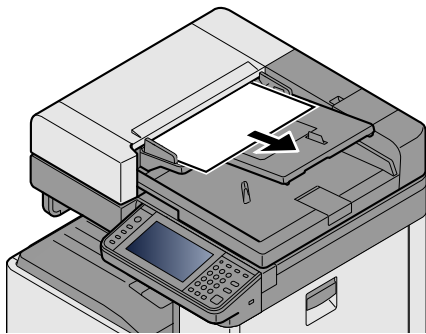

- 2 Open the front cover and remove any jammed paper.

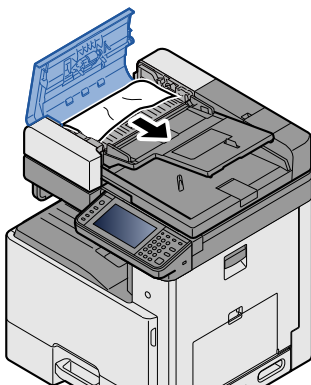

**3** Open Reverse Unit C and remove any jammed paper.

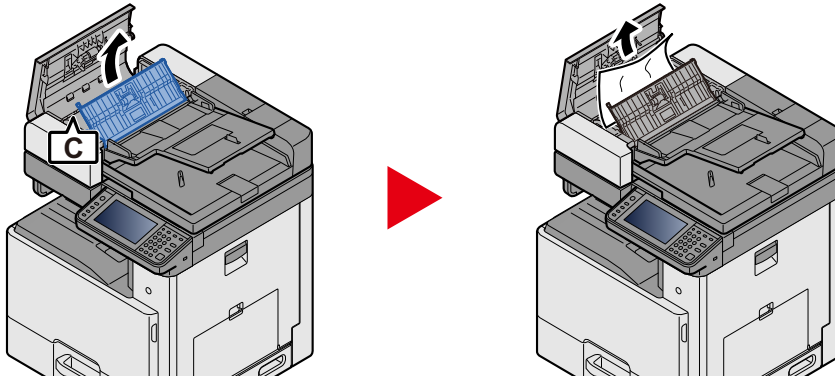

**4** Turn dial B clockwise to feed jammed paper and remove it.

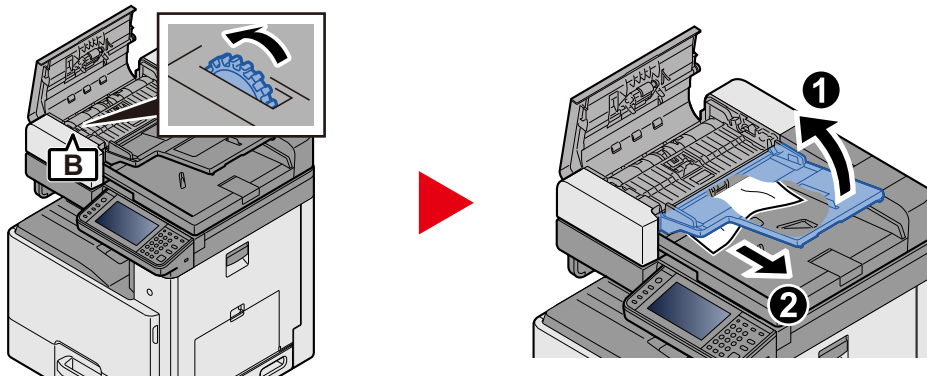

**5** Push the top cover.

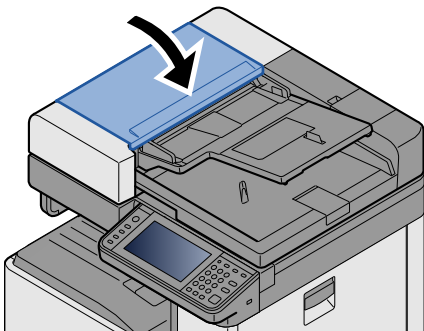

# Clearing a Staple Jam

## Clearing a staple jam of the Document Finisher

- 1 Open the staple cover of the Document Finisher

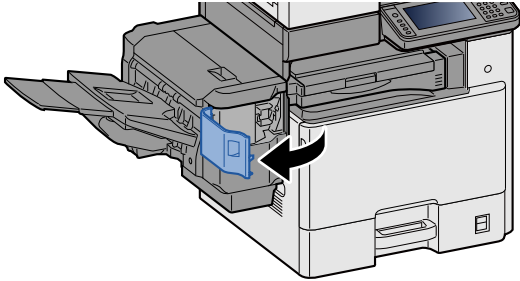

- 2 Remove the Staple Cartridge Holder.

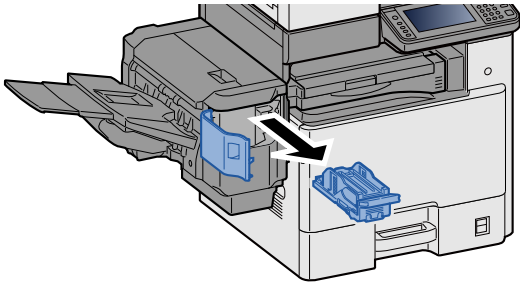

- 3 Remove the jammed staple.

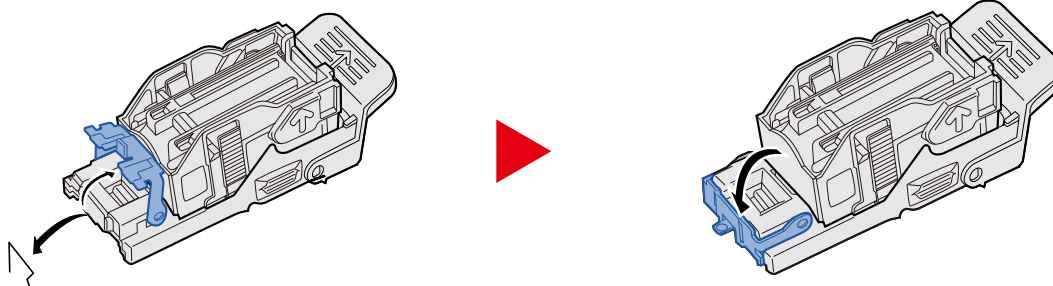

- 4 Install the Staple Cartridge Holder.

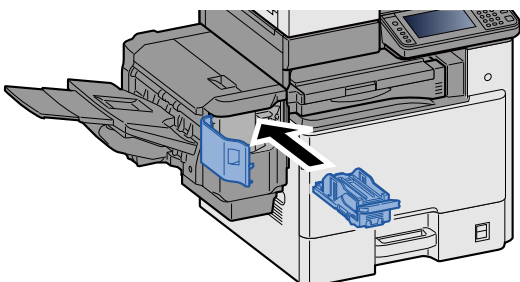



**5** Close the staple cover.

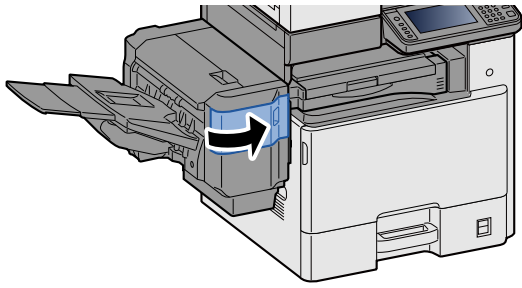

# 12 Appendix

This chapter explains the following topics:

Optional Equipment .....	12-2
Overview of Optional Equipment .....	12-2
Optional Applications .....	12-11
Starting Application Use .....	12-11
Checking Details of Application .....	12-12
Character Entry Method .....	12-13
Entry Screens .....	12-13
Entering Characters .....	12-14
Specifications .....	12-23
Machine .....	12-23
Copy Functions .....	12-25
Printer Functions .....	12-26
Scanner Functions .....	12-26
Document Processor .....	12-27
Paper Feeder (500-sheet x 2) .....	12-27
Document Finisher .....	12-27
Glossary .....	12-29

# Optional Equipment

## Overview of Optional Equipment

The following optional equipment is available for the machine.

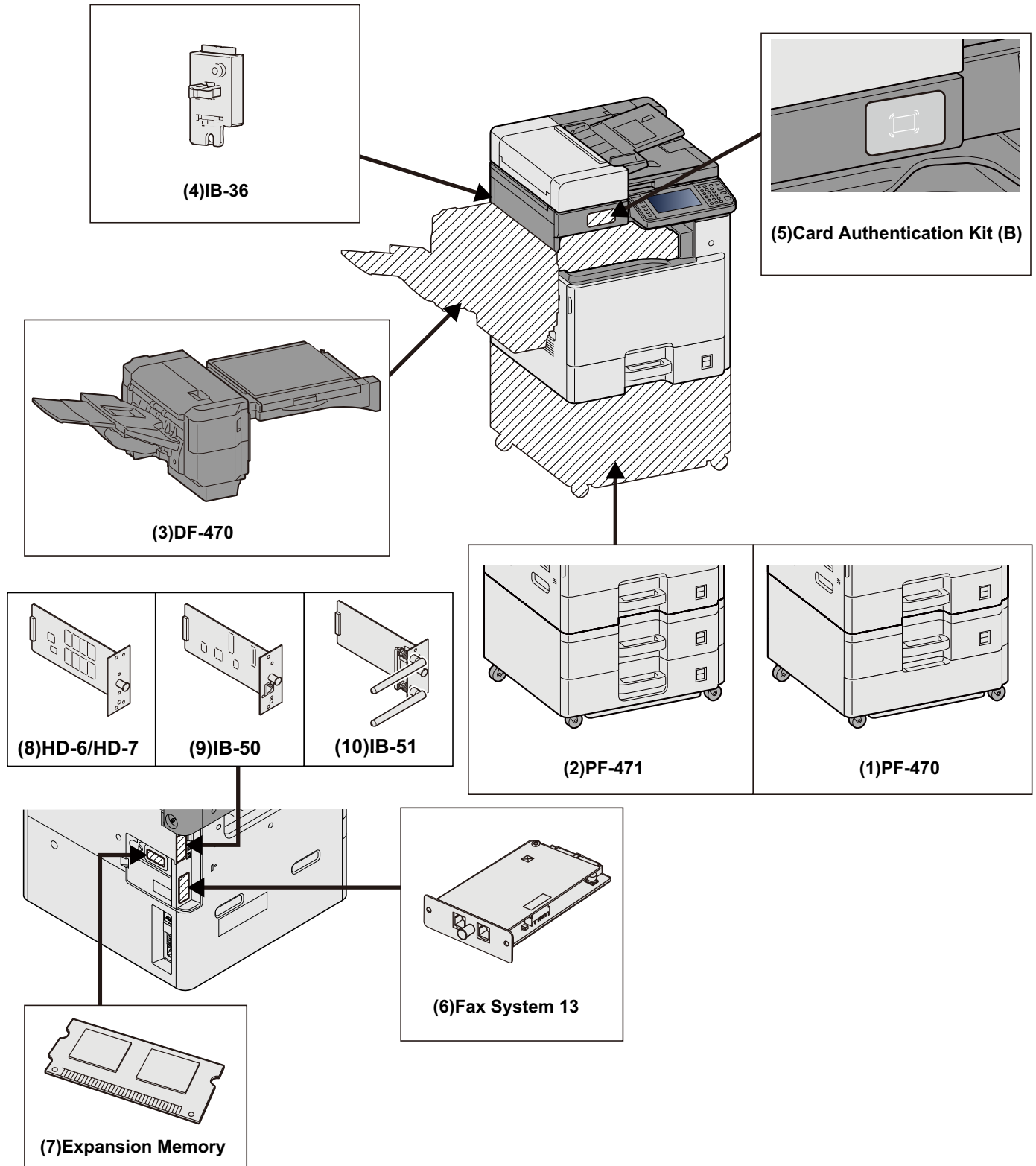



**IMPORTANT**

If PF-470 or PF-471 is installed, toppling prevention kit must be installed.

**(1)PF-470 <Paper Feeder (550-sheetx1)>**

Two additional cassettes identical to the printer's cassette can be installed in the printer. Paper capacity and loading method are the same as the standard cassettes.

➔ [Loading in the Cassettes 1 \(to 3\) \(3-19\)](#)

**(2)PF-471 <Paper Feeder (550-sheetx2)>**

Two additional cassettes identical to the printer's cassette can be installed in the printer. Paper capacity and loading method are the same as the standard cassettes.

➔ [Loading in the Cassettes 1 \(to 3\) \(3-19\)](#)

**(3)DF-470 <Document Finisher> (ECOSYS M8130cidn)**

This is a document finisher capable of holding large print runs and of separating and offsetting multiple copies of a printout into individual copies. It can also staple the offset printouts.

**(4)IB-36 <Wireless Network Interface Kit>**

This is a wireless LAN interface card which supports the wireless LAN specifications IEEE802.11n (max. 65 Mbps) and IEEE802.11 g/b. In addition, network printing is possible without using the wireless LAN router because Wi-Fi Direct is supported. This is standard in Inch Model.

**(5)Card Authentication Kit(B) <Card Authentication Kit>**

Option Card Authentication Kit User login administration can be performed using ID cards. To do so, it is necessary to register ID card information on the previously registered local user list.

➔ Card Authentication Kit(B) Operation Guide

**(6)FAX System 13 <FAX Kit>**

By installing the FAX kit, fax send/receive is enabled. Also, it is possible to use it as a network fax, by using it with a computer.

➔ FAX Operation Guide

**(7)Expansion Memory**

Expanding memory enables more complex printing and speeds up print job processing. The optional Expansion Memory provides an additional 2048 MB of memory, allowing expansion up to 3072 MB.

## Memory Handling Precautions

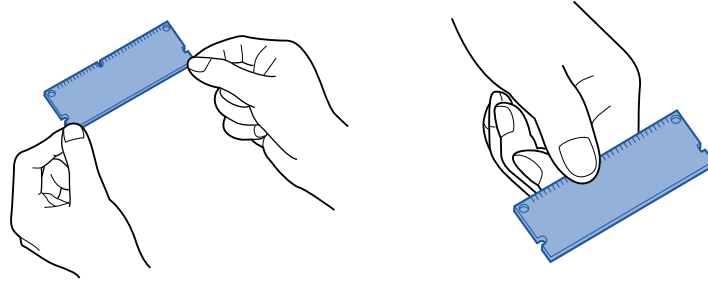

Electrostatic charge that builds up in the body through contact with clothing, carpeting, and other sources is a major enemy of chip memory. To protect memory from damage caused by electrostatic charge, touch a water tap or some metal object to discharge it from your body before loading the expansion memory. If possible, you should wear an anti-static wristband or take other anti-static measures.

## Installing or Replacing Memory

### 1 Power Off.

Turn off power, and disconnect the power cord and any cables connected to the machine.

### 2 Remove the covers.

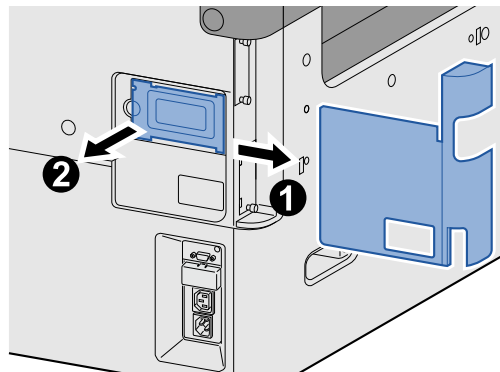

### 3 Install the memory.

- 1 Remove the optional Expansion Memory from its package.

- 2 With the memory connection terminals pointing toward the socket, align the cut-out part of the memory with the tab of the socket and insert the memory at an angle.

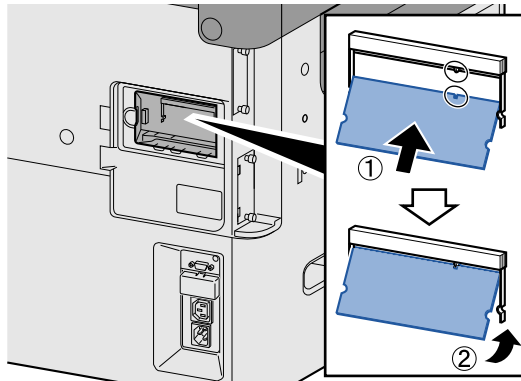

**✓ IMPORTANT**

Before inserting memory, check to make sure that the machine power switch is in the off position.

- 3 Carefully swing the inserted memory towards the machine.
- 4 Replace the covers you removed at the beginning of this procedure.

## Removing Expansion Memory

To remove Expansion Memory that has been installed, remove the machine's right cover. Carefully press the two stoppers of the socket, and then remove the Expansion Memory from the socket.

## Checking Expansion Memory

Improperly installed Expansion Memory will cause the following message to appear: "Machine Failure". Re-install the memory to clear the error. You can check whether or not Expansion Memory is properly installed by printing a status page.

➔ [\[Print Report\] \(8-5\)](#)

## (8)HD-6/7 <Large Capacity Storage: SSD>

The Solid State Device (SSD) is used for storing print data. With Hard Disk installed in the machine, received data can be rasterized and stored on this Hard Disk. Installation of an SSD enables use of Document Box functions.

➔ [Using Document Boxes \(3-48\)](#)

### Installing the SSD

#### 1 Power Off.

Turn off power, and disconnect the power cord and any cables connected to the machine.

#### 2 Remove the covers.

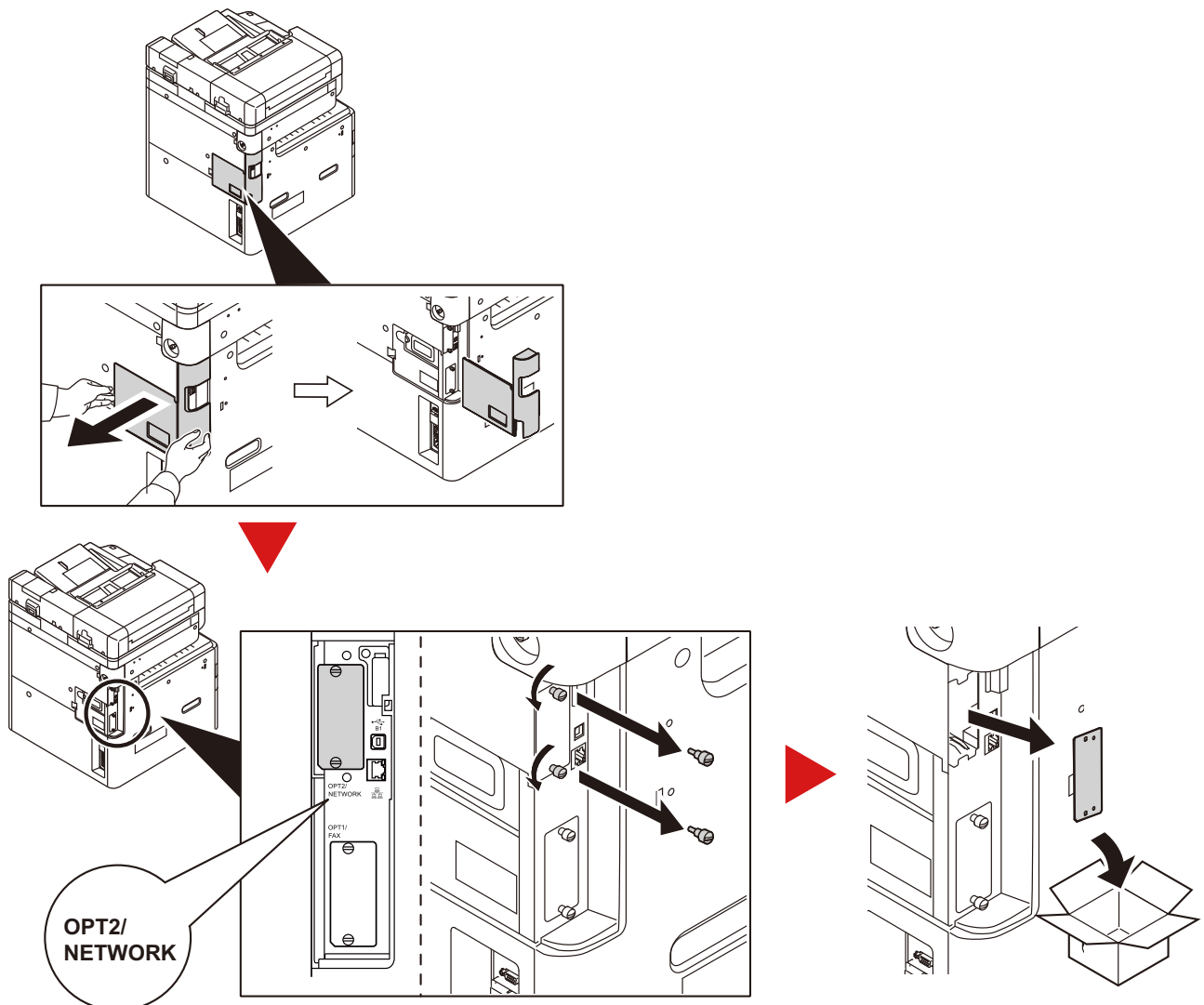

### 3 Install the SSD.

- 1 Remove the SSD from its package.
- 2 Insert straight into the Option Interface Slot.

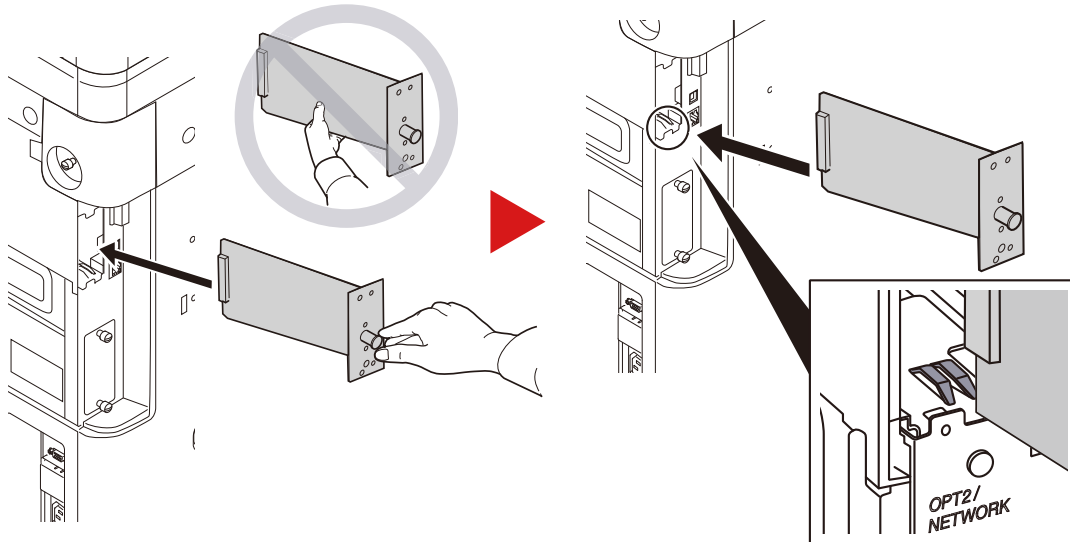

- 3 Fix it with the (2) screws.

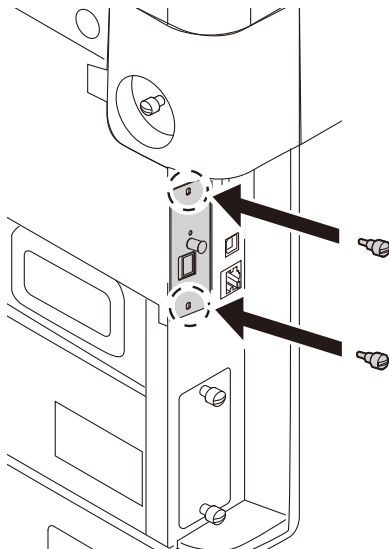



- 4 Replace the covers you removed at the beginning of this procedure.

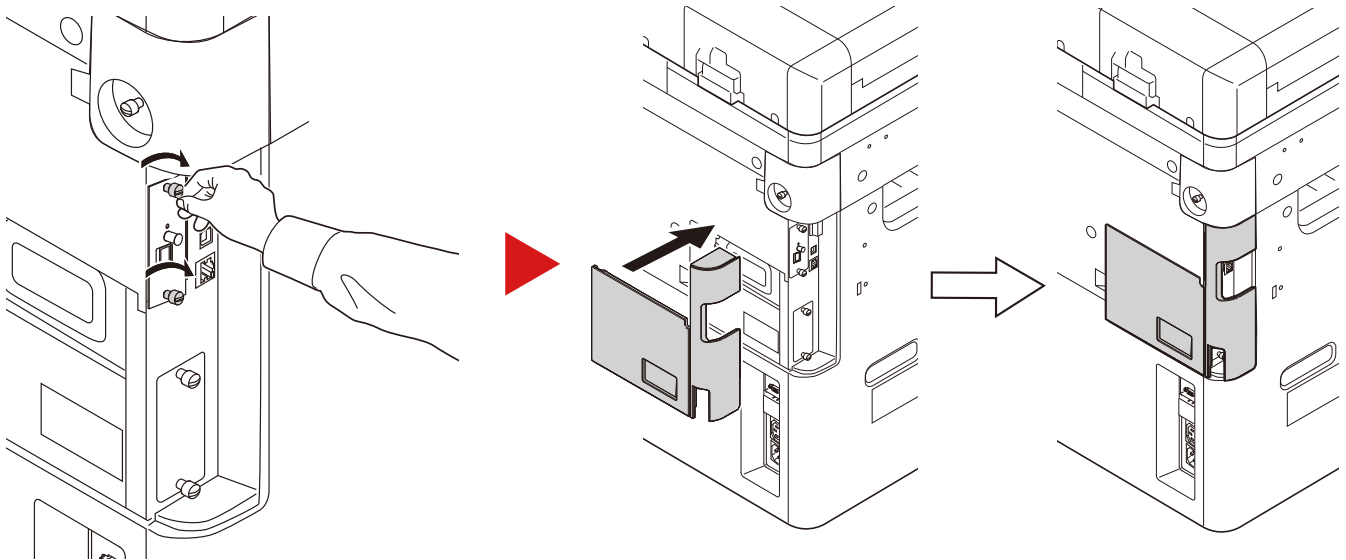

## (9)SD/SDHC Memory Card

An SD/SDHC memory card is useful for storing fonts, macros, and overlays. The machine is equipped with a slot for an SDHC memory card with a maximum size of 32 GB, and an SD memory card with a maximum size of 2 GB.

### Reading the SD/SDHC Memory Card

Once inserted in the machine's slot, the contents of the SD/SDHC memory card can be read from the operation panel or automatically when you power on or reset the machine.

### Installing and Formatting the SD/SDHC Memory Card

To use an unused SD/SDHC memory card, you must first use the machine to format the SD/SDHC memory card. For information on formatting an SD/SDHC memory card, consult your Service Representative.

#### 1 Power Off.

Turn off power, and disconnect the power cord and any cables connected to the machine.

## 2 Remove the covers.

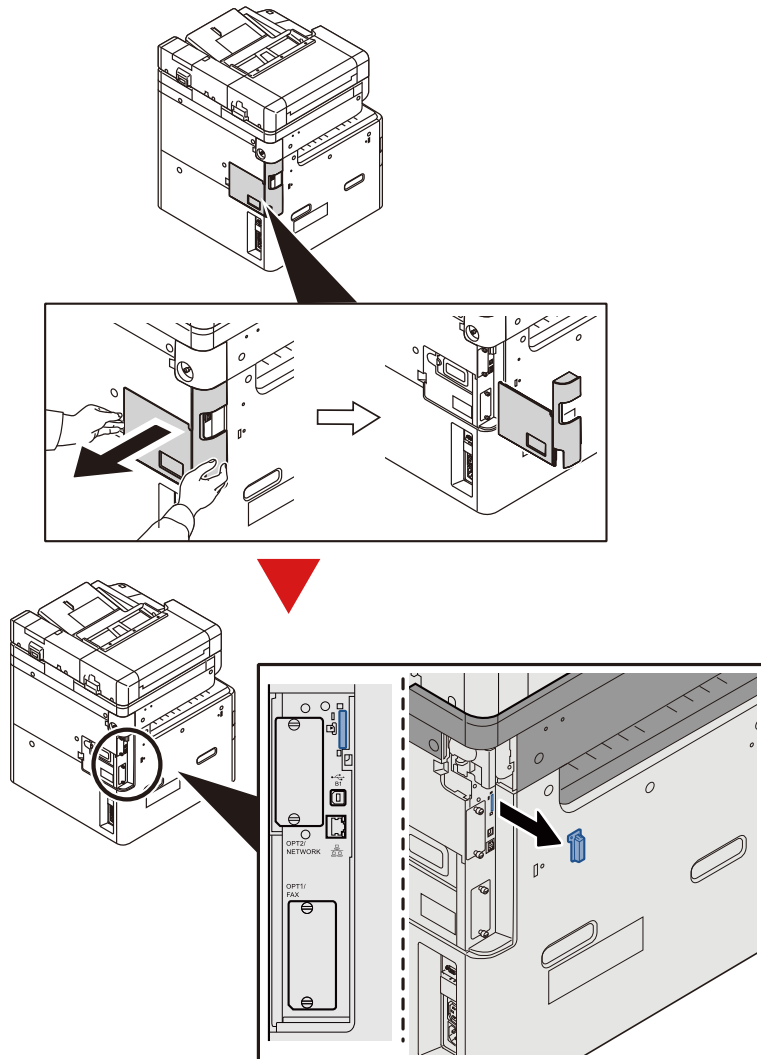

## 3 Install the SD/SDHC Memory Card.

- 1 Insert the SD/SDHC memory card into the SD/SDHC memory card slot.

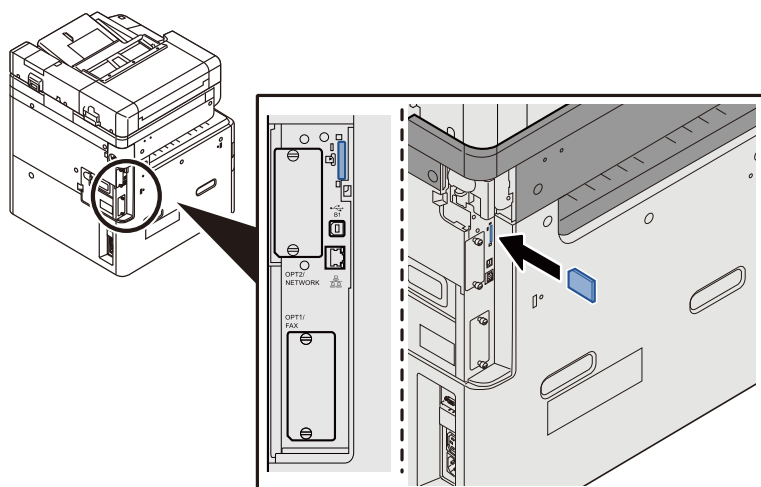

- 2 Replace the covers you removed at the beginning of this procedure.

- 3 Insert the power cord into the socket and turn on the power switch.

### **(10)IB-50 <Network Interface Kit>**

The Network Interface Kit provides a high-speed connection for the Gigabit-per-second interface. The IB-50 provides support for AppleTalk, Netware, and similar conventional protocols.

Only supports minimum function of standard utilities.

### **(11)IB-51 <Wireless Network Interface Kit>**

This is a wireless LAN interface card which supports the wireless LAN specifications IEEE802.11n (Max 300 Mbps) and 11 g/b. The IB-51 provides support for AppleTalk, Netware, and similar conventional protocols.

Only supports minimum function of standard utilities.

The IB-51 setup utility is compatible with a Windows OS and Mac OSX.

### **(12)Data Security kit(E) <Data Security Kit>**

The Data Security Kit overwrites all unnecessary data in the storage area of the hard disk so that it cannot be retrieved. Also, the kit encrypts data before storing it in the SSD. It guarantees higher security because no data cannot be decoded by ordinary output or operations.

### **(13)UG-33 <ThinPrint Option>**

This application allows print data to be printed directly without a print driver.

### **(14)Scan extension kit(A) <OCR Scan Activation Kit>**

This option enables the use of the OCR function in the applications of the machine.

To use this function, an SSD or SD/SDHC memory card must be inserted.

➔ [HD-6/7 <Large Capacity Storage: SSD> \(12-6\)](#)

➔ [SD/SDHC Memory Card \(12-8\)](#)

To use this function, the application and OCR dictionary must be installed.

➔ [Optional Applications \(12-11\)](#)

➔ [OCR Dictionary Installation \(8-58\)](#)

## Optional Applications

The applications listed below are installed on this machine.

Application
Data Security Kit
Card Authentication Kit* <sup>1</sup>
ThinPrint Option* <sup>1</sup>
OCR Scan Activation Kit* <sup>1</sup>

\*<sup>1</sup> This can be used on a trial basis for a limited time.

### NOTE

- Restrictions such as the number of times the application can be used during the trial period differ depending on the application.
- If you change the date/time while using the trial version of an application, you will no longer be able to use the application.

## Starting Application Use

### 1 Display the screen.

[System Menu / Counter] key > [System/Network] > Optional Function

### NOTE

If the user authentication screen appears, enter your login user name and login password and select [Login]. For this, you need to log in with administrator privileges.

The factory default login user name and login password are set as shown below.

- Login user name  
ECOSYS M8124cidn:2400, ECOSYS M8130cidn:3000
- Login Password  
ECOSYS M8124cidn:2400, ECOSYS M8130cidn:3000

### 2 Select the desired application > [Activate].

You can view detailed information on the selected application by selecting [].

### 3 [Official] > [Next >] > Input the license key. > [OK]

Some applications do not require you to enter a license key. If the license key entry screen does not appear, go to Step 4.

To use the application as a trial, select [Trial] without entering the license key.

### 4 Select [Yes] in the confirmation screen.

### NOTE

- If you started the Data Security Kit or ThinPrint Option and entered the license key, you need to turn power OFF and then back ON again.
- Icons of activated application are displayed in the Home screen.

## Checking Details of Application

### 1 [System Menu / Counter] key > [System/Network] > Optional Function

#### NOTE

If the user authentication screen appears, enter your login user name and login password and select [Login]. For this, you need to log in with administrator privileges.

The factory default login user name and login password are set as shown below.

- Login user name  
ECOSYS M8124cidn:2400, ECOSYS M8130cidn:3000
- Login Password  
ECOSYS M8124cidn:2400, ECOSYS M8130cidn:3000

### 2 Select [] for the application whose detailed information you want check. Select [+].

You can view detailed information on the selected application.

The table below lists the item you can view.

Description
Function Name
License
Remaining Counts
Expiration Date
Operational Status

To extend the trial period, select [Print after Change Settings] > [Yes]

# Character Entry Method

To enter characters for a name, use the on-display keyboard in the touch panel following the steps as explained below.

## NOTE

### Keyboard Layout

"QWERTY", "QWERTZ" and "AZERTY" are available as keyboard layouts the same as a PC keyboard. Select the [System Menu/Counter] key, [Common Settings] and then [Keyboard Layout] to choose the desired layout. "QWERTY" layout is used here as an example. You may use another layout following the same steps.

## Entry Screens

### Lower-case Letter Entry Screen

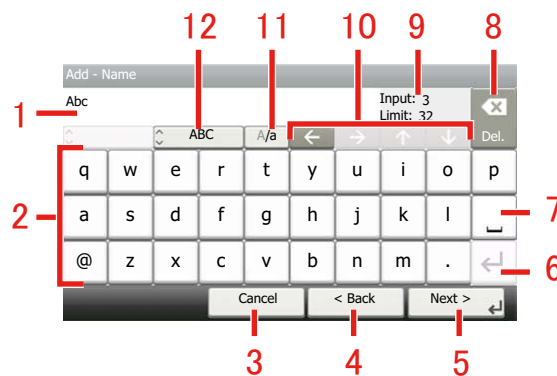

No.	Display/Key	Description
1	Display	Displays entered characters.
2	Keyboard	Select the character to enter.
3	[Cancel]	Select to cancel entered characters and return to the screen before the entry was made.
4	[< Back]	Select to return to the previous screen.
5	[OK] / [Next >]	Select to save the entered characters and move to the next screen.
6	Enter Key	Select to enter a line break.
7	Space Key	Select to insert a space.
8	Delete Key	Select to delete a character to the left of the cursor.
9	[Input] / [Limit] Display	Displays maximum number of characters and the number of characters entered.
10	Cursor Key	Select to move the cursor on the display.
11	[A/a] / [A/a]	Select to switch between upper case and lower case.
12	[ABC] / [Symbol]	Select the characters that are entered. To enter symbols or numbers, select [Symbol].

## Upper-case Letter Entry Screen



## Number/Symbol Entry Screen

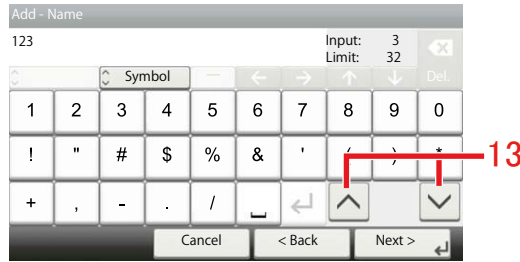

No.	Display/Key	Description
13	[^]/[v]	To enter a number or symbol not shown in the keyboard, select the cursor key and scroll the screen to view other numbers or symbols to enter.

## Entering Characters

Follow the steps below to enter 'List A-1' for an example.

### 1 Enter 'List', (space).

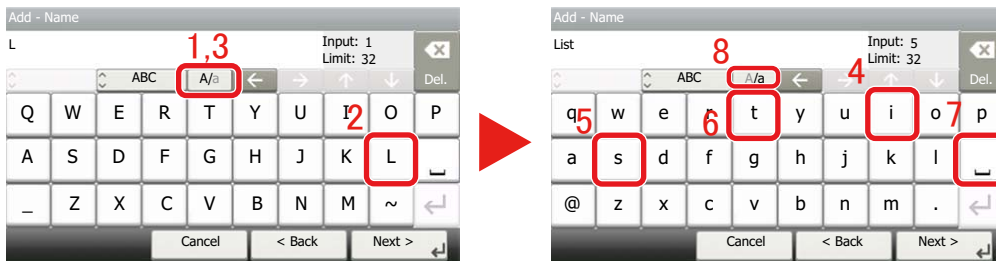

To shift from lower case to upper case letters, select [A/a]. To shift from upper case to lower case letters, select [A/a].

### 2 Enter 'A-1'.

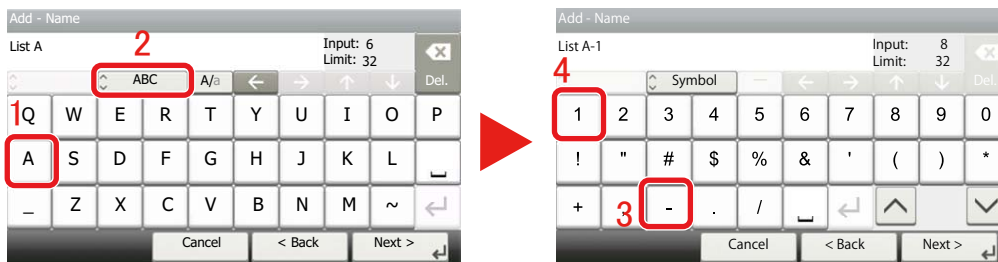

To enter numbers or symbols, select [ABC] to display [Symbol].

### 3 Register the characters you entered.

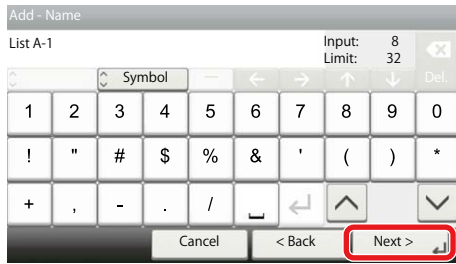

Select [Next>]. The entered characters are registered.



# Paper

This section explains the paper sizes and types that can be used in the paper source.

For details on the sizes, types, and number of sheets of paper that can be loaded in each paper tray, refer to the following.

➔ [Machine \(12-23\)](#)

## Paper Specifications

This machine is designed to print on standard copy paper as used in regular ('dry') copiers and page printers such as laser printers. It also supports a variety of other types of paper that conform to the specifications given in this appendix.

Be careful when choosing paper. Paper unsuitable for the machine may cause jams or may be wrinkled.

### Supported Paper

Use standard copy paper for regular copiers or laser printers. The printing quality will be affected by the quality of paper. Poor quality paper may result in unsatisfactory output.

### Basic Paper Specifications that can be Used with This Machine

The following table lists the specifications of paper that is supported with this machine. Refer to the subsequent sections for further details.

Criteria	Specifications
Weight	Cassettes: 60 to 256 g/m <sup>2</sup>
	Multi purpose tray: 60 - 256 g/m <sup>2</sup>
Dimensional accuracy	±0.7 mm
Squareness of corners	90° ±0.2°
Moisture content	4 to 6%
Pulp content	80% or more



#### NOTE

Some recycled paper does not meet requirements for use with this machine as listed in the Basic Paper Specifications shown below, such as moisture or pulp content. For this reason, we recommend purchasing a small amount of recycled paper as a sample for testing prior to use. Choose recycled paper that gives the best printing results and contains low levels of paper dust.

We are not responsible for the problems occurred from the use of paper that does not conform to our specifications.

## Paper Appropriate Paper

This section describes guidelines for choosing paper.

### Condition

Avoid using paper with bent corners or that is curled, dirty, or torn. Do not use paper that has a rough surface or paper fiber lint, or that is especially delicate. Use of paper in any of these conditions will not only deliver poor copies but may also cause jams and shorten the useful life of the machine. Choose paper with a smooth and even surface; however, avoid coated paper or paper with a treated surface as it may damage the drum or fusing unit.

## Ingredients

Do not use paper such as paper that has been coated or surface-treated or paper that contains plastic or carbon. Those types of paper may produce harmful fumes from the heat of printing and may damage the drum.

Be sure to use the standard paper that contains at least 80% pulp, i.e., not more than 20% of the total paper content consists of cotton or other fibers.

## Smoothness

The paper surface should be smooth, but it must be uncoated. With paper that is too smooth and slippery, several sheets may accidentally be supplied at once, causing jams.

## Basis Weight

In countries that use the metric system, basis weight is the weight in grams of one sheet of paper one square meter in area. Paper that is too heavy or too light may be supplied incorrectly or cause paper jams, which may cause excessive wear of the machine. Mixed paper weight (i.e., thickness) may cause several sheets to be supplied at once accidentally and may also cause blurring or other printing problems if the toner fails to adhere correctly.

## Moisture content

Paper moisture content is the ratio of moisture to dryness expressed as a percentage. Moisture affects how the paper is supplied, the electrostatic chargeability of the paper, and how the toner adheres.

Paper moisture content varies depending on the relative humidity in the room. High relative humidity causes paper to become damp, making the edges expand so it appears wavy. Low relative humidity causes paper to lose moisture, making the edges tighten and weakening print contrast.

Wavy or tight edges may cause the paper to slip when it is supplied. Try to keep the moisture content between 4 to 6%.

To maintain the right level of moisture content, bear in mind the following considerations.

- Store paper in a cool, well-ventilated place.
- Store paper flat and unopened in the package. Once the package is opened, reseal it if the paper is not to be used for a while.
- Store paper sealed in the original package and box. Put a pallet under the carton to keep it raised above the floor. Especially during rainy seasons keep the paper a sufficient distance away from wooden or concrete floors.
- Before using paper that has been stored, keep it at the proper moisture level for at least 48 hours.
- Do not store paper where it is exposed to heat, sunlight, or dampness.

## Other Paper Specifications

### Porosity

The density of the paper fibers.

### Stiffness

Paper must be stiff enough or it may buckle in the machine, causing jams.

### Curl

Most paper naturally tends to curl after the package is opened. When paper passes through the fixing unit, it curls upward slightly. To deliver flat printouts, load the paper so that the curl faces towards the bottom of the paper tray.

### Static electricity

During printing, paper is electrostatically charged so that the toner adheres. Choose paper that can be discharged quickly so that copies do not cling together.

### **Whiteness**

Paper whiteness affects print contrast. Use whiter paper for sharper, brighter copies.

### **Quality**

Machine problems may occur if sheet sizes are not uniform or if corners are not square, edges are rough, sheets are uncut, or edges or corners are crushed. In order to prevent these problems, be especially careful when you cut the paper yourself.

### **Packaging**

Choose paper that is properly packaged and stacked in boxes. Ideally, the packaging itself should have been treated with a coating to inhibit moisture.

### **Specially treated paper**

We do not recommend printing onto the following types of paper, even if it conforms to the basic specifications. When you use these kinds of paper, purchase a small amount first as a sample to test.

- Glossy paper
- Watermarked paper
- Paper with an uneven surface
- Perforated paper

## **Paper Sizes that can be Used with This Machine**

Paper of the following sizes is supported by the machine.

Measurements in the table take into account a  $\pm 0.7$  mm dimensional accuracy for length and width. Corner angles must be  $90^\circ \pm 0.2^\circ$ .

- A3 (297 × 420 mm)
- A4 (297 × 210 mm)
- A5 (210 × 148 mm)
- A6 (148 × 105 mm) \*1
- B4 (257 × 364 mm)
- B5 (257 × 182 mm)
- B6 (182 × 128 mm) \*1
- 216 × 340 mm
- Ledger
- Letter
- Legal
- Statement
- Executive (7-1/4 × 10-1/2") \*1
- Oficio II
- Folio (210 × 330 mm)
- 8K (273 × 394 mm)
- 16K (273 × 197 mm)
- ISO B5 (176 × 250 mm) \*1
- Envelope #10 (4-1/8 × 9-1/2") \*1
- Envelope #9 (3-7/8 × 8-7/8") \*1
- Envelope #6 3/4 (3-5/8 × 6-1/2") \*1

- Envelope Monarch (3-7/8 × 7-1/2") \*1
- Envelope DL (110 × 220 mm) \*1
- Envelope C5 (162 × 229 mm) \*1
- Envelope C4 (229 × 324 mm) \*1
- Hagaki (Cardstock) (100 × 148 mm) \*1
- Oufuku hagaki (Return postcard) (148 × 200 mm) \*1
- Youkei 4 (105 × 235 mm) \*1
- Youkei 2 (114 × 162 mm) \*1
- Custom (Multi Purpose Tray: 98 × 148 to 297 × 432 mm) \*1

\*1 Can only be used with the multi purpose tray.

## Special Paper

This section describes printing onto special paper and print media.

Special Paper that can be Used with This Machine

- OHP Transparencies
- Preprinted paper
- Bond paper
- Recycled paper
- Thin paper
- Letterhead
- Colored paper
- Prepunched paper
- Envelopes
- Hagaki (Cardstock)
- Thick paper
- Labels
- High-quality paper
- Coated Paper

When using these paper and media, choose those that are designed specifically for copiers or page printers (such as laser printers). Use the multi purpose tray for transparencies, envelopes, cardstocks, and label paper.

### Choosing Special Paper

Although special paper that meets the following requirements can be used with the machine, print quality will vary considerably due to differences in the construction and quality of special paper. Thus, special paper is more likely than regular paper to cause printing problems. Before purchasing special paper in volume, try testing a sample to ensure the print quality is satisfactory. General precautions when printing onto special paper are given below. Note that we are not responsible for any harm to the user or damage to the machine caused by moisture or specifications of special paper.

Select a cassette or multi purpose tray for special paper.

## OHP Transparencies

Transparencies must be able to withstand the heat of printing. Transparencies must meet the following conditions.

<b>Heat resistance</b>	Must withstand at least 190°C
<b>Thickness</b>	0.100 to 0.110 mm
<b>Material</b>	Polyester
<b>Dimensional accuracy</b>	±0.7 mm
<b>Squareness of corners</b>	90° ±0.2°

To avoid problems, use the multipurpose tray for transparencies and load transparencies with the long side facing the machine.

If transparencies jam frequently at output, try pulling the leading edge of sheets gently as they are ejected.

## Labels

Be sure to feed labels from the multi purpose tray.

For selecting labels, use extreme care so that the adhesive may not come in direct contact with any part of the machine and that the labels are not easily peeled from the carrier sheet. Adhesives that stick to the drum or rollers and peeled labels remaining in the machine may cause a failure.

When printing onto labels, you must be liable for the print quality and possible trouble.

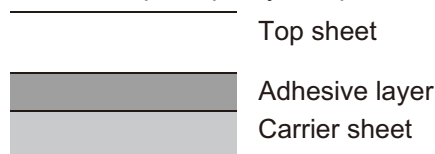

Labels consist of three layers as shown in the illustration. The adhesive layer contains materials that are easily affected by the force applied in the machine. The carrier sheet bears the top sheet until the label is used. This composition of labels may cause more problems.

The label surface must be covered completely with the top sheet. Gaps between labels may cause peeling of labels, resulting in a serious failure.

Some label paper has large margins on the top sheet. When using such paper, do not peel these margins from the carrier sheet before completing output.

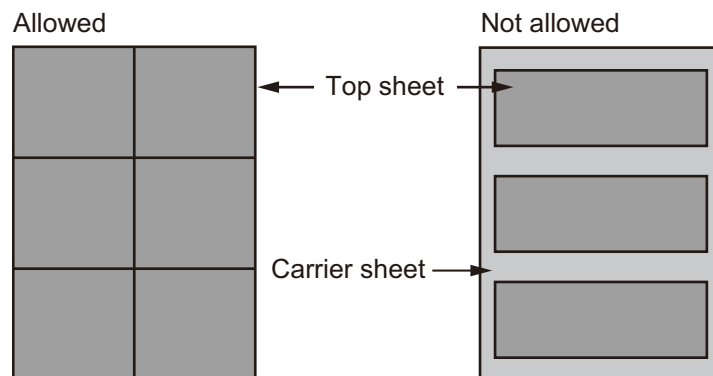

Use label paper that conforms to the following specifications.

Criteria	Specifications
<b>Top sheet weight</b>	44 to 74 g/m <sup>2</sup>
<b>Basis weight (overall paper weight)</b>	104 to 151 g/m <sup>2</sup>
<b>Top sheet thickness</b>	0.086 to 0.107 mm

Criteria	Specifications
0.115 to 0.145 mm	0.115 to 0.145 mm
Moisture content	4 to 6 % (composite)

## Hagaki (Cardstock)

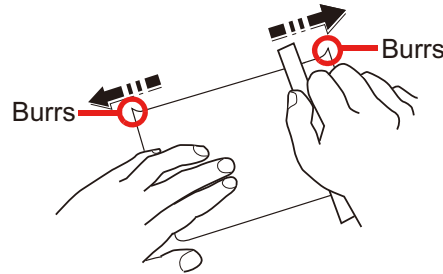

Before loading Hagaki (Cardstock), fan them and align the edges. Hagaki (Cardstock) should be fed from the MP tray with the print-side down or the cassette and the optional paper feeder with the print-side up. If the Hagaki (Cardstock) paper is curled, straighten it before loading. Printing onto curled Hagaki (Cardstock) may cause jams.

Use unfolded Oufuku hagaki (Return postcard) (available at post offices). Some Hagaki (Cardstock) may still have rough

## Envelopes

Envelopes should be fed from the MP tray with the print-side down.

Due to the structure of envelopes, printing evenly over the entire surface may not be possible in some cases. Thin envelopes in particular may be wrinkled by the machine in some cases as they pass through. Before purchasing envelopes in volume, try testing a sample to ensure the print quality.

Storing envelopes for a long period may cause them to become wrinkled. Thus, keep the package sealed until you are ready to use them.

Keep the following points in mind.

- Do not use envelopes with exposed adhesive. In addition, do not use the type of envelope in which the adhesive is exposed after the top layer is peeled off. Serious damage may be caused if the paper covering the adhesive comes off in the machine.
- Do not use envelopes with certain special features. For example, do not use envelopes with a grommet for winding a string to close the flap or envelopes with an open or film-covered window.
- If paper jams occur, load fewer envelopes at once.

## Thick paper

Before loading thick paper, fan it and align the edges. Some thick paper may still have rough edges developed by a paper cutter on the back side. Remove any such rough edges just as with Hagaki (Cardstock) by placing the paper on a flat surface and rubbing the edges gently a few times with a ruler. Printing onto paper with rough edges may cause jams.

### NOTE

If the paper is not supplied correctly even after it is smoothed, load the paper with the leading edge raised a few millimeters.

## Colored paper

Colored paper must conform to the specifications.

➔ [Basic Paper Specifications that can be Used with This Machine \(12-16\)](#)

In addition, the pigments in the paper must be able to withstand the heat of printing (up to 200°C or 392°F).

## Preprinted paper

Preprinted paper must conform to the specifications.

➔ [Basic Paper Specifications that can be Used with This Machine \(12-16\)](#)

The colored ink must be able to withstand the heat of printing. It must be resistant to silicone oil as well. Do not use paper with a treated surface such as glossy paper used for calendars.

## Recycled paper

Recycled paper must conform to the specifications; however, its whiteness may be considered separately.

➔ [Basic Paper Specifications that can be Used with This Machine \(12-16\)](#)



### NOTE

Before purchasing recycled paper in volume, try testing a sample to ensure satisfactory print quality.

## Coated Paper

Coated paper is created by treating the surface of the base paper with a coating that provides higher printing quality than plain paper. Coated paper is used for particularly high quality printing.

The surface of high-quality or medium-quality paper is coated with special agents that improve ink adhesion by making the paper surface smoother. These agents are used either to coat both sides of the paper or just one side. The coated side appears slightly glossy.



### IMPORTANT

**When printing on coated paper in very humid environments, ensure that the paper is kept dry as moisture may cause sheets to stick together when they are fed into the machine. If printing in very humid environments, set coated paper for one sheet each.**

# Specifications

## ✔ IMPORTANT

Specifications are subject to change without notice.

## 📖 NOTE

For more information on using the FAX, refer to the following:

➔ FAX Operation Guide

## Machine

Item		Description
<b>Type</b>		Desktop
<b>Printing Method</b>		Electrophotography by semiconductor laser
<b>Paper Weight</b>	<b>Cassette</b>	60 to 256 g/m <sup>2</sup>
	<b>Multi Purpose Tray</b>	60 to 256 g/m <sup>2</sup>
<b>Paper Type</b>	<b>Cassette</b>	Plain, Rough, Recycled, Vellum, Preprinted, Bond, Color, Prepunched, Letterhead, Thick, High Quality, Envelope, Custom (Duplex: Same as Simplex)
	<b>Multi Purpose Tray</b>	Plain, Transparency (OHP film), Rough, Vellum, Labels, Recycled, Preprinted, Bond, Cardstock, Coated, Color, Prepunched, Letterhead, Envelope, Thick, High Quality, Custom 1 to 8
<b>Paper Size</b>	<b>Cassette</b>	A3, A4, A5, B4, B5, Ledger, Letter, Legal, Statement, Oficio II, Folio, 216 × 340 mm, 8K, 16K
	<b>Multi Purpose Tray</b>	A3, A4, A5, B4, B5, B6, Folio, 216 × 340 mm, Ledger, Letter, Legal, Statement, Executive, Oficio II, 8K, 16K, B5 (ISO), Envelope #10, Envelope #9, Envelope #6 3/4, Envelope Monarch, Envelope DL, Envelope C5, Hagaki (Cardstock), Oufuku Hagaki (Return postcard), Youkei 4, Youkei 2, Custom (98 × 148 mm to 297 × 432 mm),
<b>Printable Area</b>		Print margin for top is 4.5 ± 1.5 mm, bottom is 3 ± 2.5 mm, both sides is 4 mm.
<b>Warm-up Time (23°C/73.4°F, 60%)</b>	<b>Power on</b>	ECOSYS M8124cidn 30 seconds or less ECOSYS M8130cidn 30 seconds or less
	<b>Low Power</b>	ECOSYS M8124cidn 10 seconds or less ECOSYS M8130cidn 10 seconds or less
	<b>Sleep</b>	ECOSYS M8124cidn 10 seconds or less ECOSYS M8130cidn 10 seconds or less
<b>Paper Capacity</b>	<b>Cassette</b>	500 sheets (80 g/m <sup>2</sup> )* <sup>1</sup>
	<b>Multi Purpose Tray</b>	100 sheets (A4/Letter or smaller) (80 g/m <sup>2</sup> ), 25 sheets (larger than A4/Letter) (80 g/m <sup>2</sup> )
<b>Output Tray Capacity</b>	<b>Inner tray</b>	250 sheets (80 g/m <sup>2</sup> )
	<b>Job separator</b>	30 sheets (80 g/m <sup>2</sup> )



Item		Description
<b>Image Write System</b>		Semiconductor laser and electrophotography
<b>Memory</b>		Standard: 1536MB(1.5GB), Maximum: 3072MB(3.0GB)
<b>Interface</b>	<b>Standard</b>	USB Interface Connector: 1 (Hi-Speed USB) Network interface: 1 (1000Base-T/100Base-TX/10BASE-T [IPv6IPv4IPSec], 802.3az supported) USB Host: 2 (USB memory slot) Wireless LAN (Option): 1 (For IB-36 mounting)* <sup>2</sup>
	<b>Option</b>	eKUIO: 2 (For HD-6/HD-7/FAX System*3/IB-50/IB-51 mounting.)
<b>Operating Environment</b>	<b>Temperature</b>	10 to 32.5°C/50 to 90.5°F
	<b>Humidity</b>	10 to 80 %
	<b>Altitude</b>	3,500 m/11,482 ft maximum
	<b>Brightness</b>	1,500 lux maximum
<b>Dimension (W × D × H) (without Document Processor)</b>		23.23" × 23.23" × 29.65" 590 × 590 × 753 mm
<b>Weight</b>		ECOSYS M8124cidn: Approx. 169.8 lb/Approx. 77 kg (without toner container) ECOSYS M8130cidn: Approx. 174.2 lb/Approx. 79 kg (without toner container)
<b>Space Required (W × D) (Using multi purpose tray)</b>		34.37" × 23.23" 873 × 590 mm
<b>Power Source</b>		120 V Specification Model: 120 V ~ 60 Hz, 7.2 A 220 V -240 V Specification Model: 220 to 240 V ~ 50 Hz, 3.5 A
<b>The power consumption of the product in networked standby (If all network ports are connected.)</b>		The information is available at the website below. <a href="http://www.kyoceradocumentsolutions.eu/index/environment/green_products/low_power_consumption.html">http://www.kyoceradocumentsolutions.eu/index/environment/green_products/low_power_consumption.html</a>
<b>Options</b>		➔ <a href="#">Optional Equipment (12-2)</a>

\*1 Up to upper limit height line in the cassette.

\*2 This is standard in Inch Model.

\*3 Use slot 2 for FAX system.

## Copy Functions

Item		Description		
Copy Speed	ECOSYS M8124cidn		Black and White Copying	Full Color Copying
		A4/Letter	24 sheets/min	24 sheets/min
		A4-R/Letter-R	17 sheets/min	17 sheets/min
		A3/Ledger	12 sheets/min	12 sheets/min
		B4/Legal	12 sheets/min	12 sheets/min
		B5	24 sheets/min	24 sheets/min
		B5-R	17 sheets/min	17 sheets/min
	A5-R	12 sheets/min	12 sheets/min	
	ECOSYS M8130cidn		Black and White Copying	Full Color Copying
		A4/Letter	30 sheets/min	30 sheets/min
		A4-R/Letter-R	21 sheets/min	21 sheets/min
		A3/Ledger	15 sheets/min	15 sheets/min
		B4/Legal	15 sheets/min	15 sheets/min
		B5	30 sheets/min	30 sheets/min
B5-R		21 sheets/min	21 sheets/min	
A5-R	15 sheets/min	15 sheets/min		
First Copy Time (A4, place on the platen, feed from Cassette)	ECOSYS M8124cidn	7.6 seconds or less	9.8 seconds or less	
	ECOSYS M8130cidn	6.5 seconds or less	8.3 seconds or less	
Zoom Level	Manual mode: 25 to 400%, 1% increments Auto mode: Preset Zoom			
Continuous Copying	1 to 999 sheets			
Resolution	600 × 600 dpi			
Supported Original Types	Sheet, Book, 3-dimensional objects (maximum original size: Legal/Folio)			
Original Feed System	Fixed			

## Printer Functions

Item		Description
<b>Printing Speed</b>		Same as Copying Speed.
<b>First Print Time (A4, feed from Cassette)</b>	<b>ECOSYS M8124cidn</b>	Black and White 7.5 seconds or less Color 10.2 seconds or less
	<b>ECOSYS M8130cidn</b>	Black and White 6.5 seconds or less Color 8.3 seconds or less
<b>Resolution</b>		600 × 600 dpi, 1200 × 1200 dpi <sup>*1</sup>
<b>Operating System</b>		Windows Vista, Windows 7, Windows 8, Windows 8.1, Windows 10, Windows Server 2008/R2, Windows Server 2012/R2, Windows Server 2016, Mac OS X(10.5 or more)
<b>Interface</b>		USB Interface Connector: 1 (Hi-Speed USB) Network interface: 1 (10 BASE-T/100 BASE-TX/1000 BASE-T [IPv6, IPv4, IPsec], 802.3a supported) Optional Interface (Option): 2 (For IB-50/IB-51 mounting) Wireless LAN (Option): 1 (For IB-36 mounting) <sup>*2</sup>
<b>Page Description Language</b>		PRESCRIBE
<b>Emulations</b>		PCL6 (PCL-XL, PCL5c), KPDL3 (PostScript3 compatible), PDF, XPS, OpenXPS

\*1 The processing speed will be slower than normal.

\*2 This is standard in Inch Model.

## Scanner Functions

Item		Description
<b>Resolution</b>		600 x 600 dpi, 400 x400 dpi, 200 x 400 dpi, 300 x 300 dpi, 200 x 200 dpi, 200 x 100 dpi
<b>File Format</b>		TIFF, JPEG, XPS, OpenXPS, PDF (MMR/JPEG compression), MS Office <sup>*1*2</sup> , Searchable PDF <sup>*1</sup>
<b>Scanning Speed<sup>*3</sup> (A4 landscape, 300 dpi, Image quality: Text/Photo original)</b>	<b>ECOSYS M8124cidn</b>	Simplex: B/W 50 Images/min, Color 50 Images/min
	<b>ECOSYS M8130cidn</b>	Duplex: B/W 16 Images/min, Color 16 Images/min
<b>Interface</b>		Ethernet (10 BASE-T/100 BASE-TX/1000 BASE-T) Wireless LAN (Option): 1 (For IB-36 mounting) <sup>*4</sup>
<b>Transmission System</b>		SMB, SMTP, SMTP over SSL, FTP, FTP over SSL, TWAIN <sup>*5</sup> , WIA <sup>*5</sup> , WSD

\*1 When the optional OCR Scan Activation Kit is installed.

\*2 Microsoft Office 2007 or later

\*3 When using the document processor (except TWAIN and WIA scanning)

\*4 This is standard in Inch Model.

\*5 Available Operating System: Windows Vista, Windows Server 2008, Windows Server 2008 R2, Windows 7, Windows 8, Windows 8.1, Windows 10, Windows Server 2012, Windows Server 2012 R2, Windows Server 2016

## Document Processor

Item	Description
Original Feed Method	Automatic feed
Supported Original Types	Sheet originals
Paper Size	Maximum: A3/ Ledger (Custom: 297 x 432 mm, Long-sized: 297 x 1900 mm)
	Minimum: A5-R/ Statement-R (Custom: 140 x 182 mm)
Paper Weight	1-sided: 45 to 160 g/m <sup>2</sup> 2-sided: 50 to 120 g/m <sup>2</sup>
Loading Capacity	50 sheets or less (50 to 80 g/m <sup>2</sup> )*1

\*1Up to upper limit height line in the document processor.

## Paper Feeder (500-sheet)

Item	Description
Paper Supply Method	Friction roller feeder (No. Sheets: 500, 80 g/m <sup>2</sup> , 1 cassette)
Paper Size	A3, A4, A5, B4, B5, Ledger, Letter, Legal, Statement, Oficio II, 216×340 mm, Folio, 8K, 16K
Supported Paper	Paper weight: 60 to 256 g/m <sup>2</sup> Media types: Plain, Recycled, Material
Dimensions (W) × (D) × (H)	23.23 x 23.19 x 13.86 " 590 × 589 × 352 mm
Weight	Approx. 45.9 lb/ Approx. 20.8 kg

## Paper Feeder (500-sheet x 2)

Item	Description
Paper Supply Method	Friction roller feeder (No. Sheets: 500, 80 g/m <sup>2</sup> , 2 cassettes)
Paper Size	A3, A4, A5, B4, B5, Ledger, Letter, Legal, Statement, Oficio II, 216×340 mm, Folio, 8K, 16K
Supported Paper	Paper weight: 60 to 256 g/m <sup>2</sup> Media types: Plain, Recycled, Material
Dimensions (W) × (D) × (H)	23.23 x 23.19 x 13.86 " 590 × 589 × 352 mm
Weight	Approx. 46lb/ Approx. 21 kg

## Document Finisher

Item	Description
Number of Trays	1 tray
Paper Size (80 g/m <sup>2</sup> )	Tray (Non-stapling) A3, B4, Folio, 216 x 340 mm, Ledger, Legal, Oficio II, 8K: 250 sheets A4, B5, A5, Letter, Executive, Statement, 16K: 500 sheets

Item		Description
<b>Supported Paper Weight</b>		45 to 256 g/m <sup>2</sup> (Stapling: 90 g/m <sup>2</sup> or less)
<b>Stapling</b>	<b>Number of Sheets</b>	A3, B4, Ledger, Legal, Oficio II, 216 × 340 mm, 8K: 25 sheets A4, B5, Letter, 16K: 50 sheets (Paper weight 90 g/m <sup>2</sup> or less)
	<b>Media types</b>	Plain, Recycled, Preprinted, Bond, Color, Prepunched, Letterhead, High Quality, Rough, Custom 1 to 8
<b>Dimensions (W) × (D) × (H)</b>		16.38 x 20.51 x 10.85 " 416 x 521 x 275.5 mm
<b>Weight</b>		Approx. 26.4lb/ Approx. 12 kg or less
<b>Space Required (W × D) (When pulling the tray)</b>		24.09 x 20.51 " 612 x 521 mm

# Glossary

## Accessibility

The machine is designed featuring good accessibility even for the elderly and those who are physically challenged or visually impaired. Touch panel is adjustable in two angles.

## Apple Talk

AppleTalk offers file sharing and printer sharing and it also enables you to utilize application software that is on another computer on the same AppleTalk network.

## Auto Form Feed Timeout

During data transmission, the machine may sometimes have to wait until receiving the next data. This is the auto form feed timeout. When the preset timeout passes, the machine automatically prints output. However, no output is performed if the last page has no data to be printed.

## Auto-IP

Auto-IP is a module that enables dynamic IPv4 addresses to be assigned to a device on startup. However, DHCP requires a DHCP server. Auto-IP is a server-less method of choosing an IP address. IP addresses between 169.254.0.0 to 169.254.255.255 are reserved for Auto-IP and assigned automatically.

## Auto Paper Selection

A function to automatically select paper in the same size as originals when printing.

## Auto Sleep

A mode designed for electrical power saving, activated when the machine is left unused or there is no data transfer for a specific period. In Sleep mode, power consumption is kept to a minimum.

## Bonjour

Bonjour, also known as zero-configuration networking, is a service that automatically detects computers, devices and services on an IP network. Bonjour, because an industry-standard IP protocol is used, allows devices to automatically recognize each other without an IP address being specified or DNS server being set. Bonjour also sends and receives network packets by UDP port 5353. If a firewall is enabled, the user must check that UDP port 5353 is left open so that Bonjour will run correctly. Some firewalls are set up so as to reject only certain Bonjour packets. If Bonjour does not run stably, check the firewall settings and ensure that Bonjour is registered on the exceptions list and that Bonjour packets are accepted. If you install Bonjour on Windows XP Service Pack 2 or later, the Windows firewall will be set up correctly for Bonjour.

## Custom Box

The Custom Box function stores print data for each individual user on the printer and allows the user to print single or multiple copies of the stored data later using the printer's operation panel.

## Default Gateway

This indicates the device, such as a computer or router, that serves as the entrance/exit (gateway) for accessing computers outside the network that you are on. When no specific gateway is designated for a destination IP address, data is sent to the host designated as the Default Gateway.

## **DHCP (Dynamic Host Configuration Protocol)**

Dynamic Host Configuration Protocol (DHCP) that automatically resolves IP addresses, subnet masks, and gateway addresses on a TCP/IP network. DHCP minimizes the load of network management employing a large number of client computers because it relieves individual clients including printers from the IP address being assigned.

## **DHCP (IPv6)**

DHCP (IPv6) is the next-generation of the Internet's Dynamic Host Configuration Protocol and supports IPv6. It extends the BOOTP startup protocol that defines the protocols used for transferring configuration information to hosts on the network. DHCP (IPv6) permits the DHCP server to use its expanded functionality to send configuration parameters to an IPv6 node. Because the network addresses that can be used are allocated automatically, the IPv6 node management workload is reduced in systems where the administrator has to exercise close control over IP address allocation.

## **dpi (dots per inch)**

A unit for resolution, representing the number of dots printed per inch (25.4 mm).

## **EcoPrint Mode**

A printing mode that helps save toner. Copies made in this mode are thus lighter than normal.

## **Emulation**

The function to interpret and execute other printers' page description languages. The machine emulates operation of PCL6, KPDL3 (PostScript 3 compatible).

## **Enhanced WSD**

Proprietary web services.

## **FTP (File Transfer Protocol)**

A protocol to transfer files on the TCP/IP network, whether the Internet or an intranet. Along with HTTP and SMTP/POP, FTP is now frequently used on the Internet.

## **Grayscale**

A computer color expression. Displayed images of this sort are typically composed of shades of gray, varying from black at the weakest intensity to white at the strongest, without any other colors. Gray levels are displayed in numerical levels: that is, white and black only for 1 bit; 256 gray levels (including white and black) for 8 bits; and 65,536 gray levels for 16 bits.

## **Help**

A ? (Help) key is provided on this machine's operation panel. If you are unsure of how to operate the machine, would like more information on its functions or are having problems getting the machine to work properly, press the ? (Help) key to view a detailed explanation on the touch panel.

## **IP Address**

An Internet protocol address is a unique number that represents a specific computer or related device on the network. The format of an IP address is four sets of numbers separated by dots, e.g. 192.168.110.171. Each number should be between 0 and 255.

## **IPP**

IPP (Internet Printing Protocol) is a standard that uses TCP/IP networks such as the Internet to enable print jobs to be sent between remote computers and printers. IPP is an extension of the HTTP protocol used to view websites and enables printing to be carried out via routers on printers in remote locations. It also supports the HTTP authentication mechanisms along with SSL server and client authentication as well as encryption.

## **Job Box**

The Job Box function stores print data on the printer and allows users to print single or multiple copies of the stored data later using the printer's operation panel.

## **KPDL (Kyocera Page Description Language)**

Kyocera's PostScript page description language compatible with Adobe PostScript Level 3.

## **Multi Purpose (MP) Tray**

The paper supply tray on the front side of the machine. Use this tray instead of the cassettes when printing onto envelopes, Hagaki (Cardstock), transparencies, or labels.

## **NetBEUI (NetBIOS Extended User Interface)**

An interface, developed by IBM in 1985, as an update from NetBIOS. It enables more advanced functions on smaller networks than other protocols such as TCP/IP, etc. It is not suitable for larger networks due to lack of routing capabilities to choose the most appropriate routes. NetBEUI has been adopted by IBM for its OS/2 and Microsoft for its Windows as a standard protocol for file sharing and printing services.

## **Outline font**

With outline fonts, character outlines are represented with numerical expressions and fonts can be enlarged or reduced in different ways by changing the numeric values of those expressions. Printing remains clear even if you enlarge fonts, since the characters are defined with outlines represented with numerical expressions. You can specify the font size in steps of 0.25 points up to 999.75 points.

## **PDF/A**

This is "ISO 19005-1. Document management - Electronic document file format for long-term preservation - Part 1: Use of PDF (PDF/A)", and is a file format based on PDF 1.4. It has been standardized as ISO 19005-1, and is a specialization of PDF, which has been mainly used for printing, for long-term storage. A new part, ISO 19005-2 (PDF/A-2), is currently being prepared.

## **POP3 (Post Office Protocol 3)**

A standard protocol to receive E-mail from the server in which the mail is stored on the Internet or an intranet.

## **PostScript**

A page description language developed by Adobe Systems. It enables flexible font functions and highly-functional graphics, allowing higher quality printing. The first version called Level 1 was launched in 1985, followed by Level 2 that enabled color printing and two-byte languages (e.g. Japanese) in 1990. In 1996, Level 3 was released as an update for the Internet access and PDF format as well as gradual improvements in implementation technologies.

## **PPM (prints per minute)**

This indicates the number of A4 size printouts made in one minute.



## **Printer Driver**

The software to enable you to print data created on any application software. The printer driver for the machine is contained in the DVD enclosed in the package. Install the printer driver on the computer connected to the machine.

## **RA(Stateless)**

The IPv6 router communicates (transmits) information such as the global address prefix using ICMPv6. This information is the Router Advertisement (RA).

ICMPv6 stands for Internet Control Message Protocol, and is a IPv6 standard defined in the RFC 2463 "Internet Control Message Protocol (ICMPv6) for the Internet Protocol Version 6 (IPv6) Specification".

## **RAM Disk**

Using part of the printer's memory as a virtual disk, you can set any amount of memory from overall printer memory as a RAM disk in order to use features such as electronic sorting (shortening print time).

## **Send as E-mail**

A function to send the image data stored in the machine as an E-mail attachment. E-mail addresses can be selected from the list or entered at each time.

## **SMTP (Simple Mail Transfer Protocol)**

A protocol for E-mail transmission over the Internet or an intranet. It is used for transferring mail between mail servers as well as for sending mail from clients to their servers.

## **Status Page**

The page lists machine conditions, such as the memory capacity, total number of prints and scans, and paper source settings.

## **Subnet Mask**

The subnet mask is a way of augmenting the network address section of an IP address.

A subnet mask represents all network address sections as 1 and all host address sections as 0. The number of bits in the prefix indicates the length of the network address. The term "prefix" refers to something added to the beginning and, in this context, indicates the first section of the IP address. When an IP address is written, the length of the network address is indicated by the prefix length after a forward slash (/). For example, "24" in the address "133.210.2.0/24". In this way, "133.210.2.0/24" denotes the IP address "133.210.2.0" with a 24-bit prefix (network section). This new network address section (originally part of the host address) made possible by the subnet mask is referred to as the subnet address. When you enter the subnet mask, be sure to set the "DHCP" setting to "Off".

## **TCP/IP (Transmission Control Protocol/Internet Protocol)**

TCP/IP is a suite of protocols designed to define the way computers and other devices communicate with each other over a network.

## **TCP/IP (IPv6)**

TCP/IP (IPv6) is based on the current Internet protocol, TCP/IP (IPv4). IPv6 is the next-generation Internet protocol and expands the available address space, which resolves the problem of the lack of addresses under IPv4, while also introducing other improvements such as additional security functionality and the capacity to prioritize data transmission.

### **TWAIN (Technology Without An Interesting Name)**

A technical specification for connecting scanners, digital cameras, and other image equipment to computers. The TWAIN compatible devices enable you to process image data on any relevant application software. TWAIN is adopted on a large amount of graphic software (e.g. Adobe Photoshop) and OCR software.

### **USB (Universal Serial Bus) 2.0**

A USB interface standard for Hi-Speed USB 2.0. The maximum transfer rate is 480 Mbps. This machine is equipped with USB 2.0 for high-speed data transfer.

### **WIA (Windows Imaging Acquisition)**

A function to import images supported after Windows Me/XP from digital cameras and other peripheral devices. This function replaces what TWAIN used to do. The feature is provided as a part of Windows functions and improves ease of operation, so that you import images directly to My Computer without using any application.

# Index

## A

- Accessibility [12-29](#)
- Address Book [3-32](#)
  - Assign [3-32](#)
  - Deleting [3-37](#)
  - Editing and Deleting [3-36](#)
  - Individual [3-32](#)
  - Private [3-35](#)
- Adjustment/Maintenance [8-63](#)
  - Auto Color Correction [8-63](#)
  - Calibration [11-30](#)
  - Development Refresh [11-30](#)
  - Drum Refresh [8-64](#), [11-32](#)
  - Sharpness Adjustment [8-63](#)
  - Tone Curve Adjustment [8-64](#)
- Adjustment/Maintenance Menu [11-25](#)
- AirPrint [5-45](#)
- AppleTalk [12-29](#)
- Application [2-54](#), [8-28](#)
- Auto Form Feed Timeout [12-29](#)
- Auto Image Rotation [6-36](#)
- Auto Paper Selection [12-29](#)
- Auto Sleep [2-23](#), [12-29](#)
- Auto-IP [12-29](#)
  - Settings [8-38](#), [8-41](#)
- Automatic 2-Sided Print Function [1-18](#)

## B

- Background Density Adjustment [6-24](#), [8-63](#)
- Bonjour [12-29](#)
  - Settings [8-43](#)

## C

- Cables [2-8](#)
- Cancel Printing [4-10](#)
- Canceling a Print Job [5-13](#)
- Canceling Scanning [5-26](#)
- Cassette
  - Paper Size and Media Type [8-9](#)
- Cassette 1 [2-3](#)
- Cassette/MP Tray Settings [8-9](#)
- Cassettes
  - Loading Paper [3-19](#)
- Checking and Editing Destinations [5-30](#)
- Checking the Counter [3-16](#)
  - By Paper Size [9-40](#)
  - Each Job Accounting [9-43](#)
  - Print Accounting Report [9-43](#)
  - Total Job Accounting [9-43](#)
  - Unknown User Settings [9-46](#)
- Checking the Remaining Amount of Toner [7-12](#)
- Cleaning
  - Glass Platen [10-2](#)
  - Slit Glass [10-2](#)
- Clearing a Staple Jam
  - Clearing a Staple Jam of the Inner Finisher [11-43](#)

- Clearing Paper Jams
  - Bride Unit [11-40](#)
  - Jam Location Indicators [11-33](#)
  - Multi Purpose Tray [11-34](#)
  - Original Feeder (Reverse Automatic) [11-41](#)
  - Right Cover 1 [11-35](#)
  - Right Cover 2, 3 [11-37](#)
- Collate/Offset [6-10](#)
- Color
  - Background Density Adjustment [6-24](#), [8-63](#)
  - Calibration [11-30](#)
  - Color Balance [6-20](#)
  - Hue Adjustment [6-21](#)
- Color Balance [6-20](#)
- Color Registration Procedure
  - Auto Correction [11-26](#)
  - Manual Correction [11-28](#)
- Color Selection [6-19](#)
- Combine [6-29](#)
- Command Center RX [2-42](#)
- Common Settings [8-11](#)
  - Default Screen [8-11](#)
  - Display Status/Log [8-21](#)
  - Error Handling [8-19](#), [8-20](#)
  - Finish Documents by Job [8-20](#)
  - Function Defaults [8-16](#)
  - Function Key Assignment [8-21](#)
  - Low Toner Alert Level [8-20](#)
  - Measurement [8-19](#), [8-20](#)
  - Number of Copies Limit [8-18](#)
  - Offset One Page Documents [8-21](#)
  - Original Settings [8-12](#), [8-13](#)
  - Paper Output [8-19](#), [8-20](#)
  - Show Power Off Message [8-21](#)
  - Sound [8-11](#)
- Connecting
  - LAN Cable [2-9](#)
  - Power Cable [2-9](#)
  - USB Cable [2-9](#)
- Connection Method [2-12](#)
- Consumable Replacement and Replenishment
  - Loading Paper [10-9](#)
  - Staple Cartridge Replacement (Document Finisher) [10-10](#)
  - Toner Container Replacement [10-4](#)
  - Waste Toner Box Replacement [10-7](#)
- Contrast [6-23](#)
- Conventions Used in This Guide [li](#)
- Copy [5-14](#)
- Counting the Number of Used Sheets
  - Counter [3-16](#)
- Custom Box [12-29](#)
  - Creating a Box [3-49](#)
  - Delete Box [3-53](#)
  - Deleting Documents [5-37](#)
  - Printing Documents [5-43](#)
  - Send [5-37](#)
  - Storing Documents [5-34](#)

## D

- Data Sanitization [8-57](#)
- Date/Timer/Energy Saver [8-60](#)
  - Panel Reset Timer [8-60](#)
- Default
  - XPS Fit to Page [8-17](#)
- Default Gateway [12-29](#)
  - Settings [8-41](#)
- Default Screen [8-11](#)
- Defaults
  - Background Density (Send/Store) [8-16](#)
  - Continuous Scan (Send/Store) [8-17](#)
  - Document Name Entry [8-17](#)
  - FAX TX Resolution [8-16](#)
  - File Format [8-16](#)
  - File Separation File Separation
    - Default [8-16](#)
  - Margin [8-17](#)
  - Original Orientation (Copy) [8-16](#)
  - Prevent Bleed-thru (Copy) [8-16](#)
  - Scan (Except FAX) [8-17](#)
  - Scan Resolution [8-16](#)
  - Skip Blank Page (Send/Store) [8-16](#)
  - Sort/Offset [8-16](#)
- Density [6-16](#)
- Density Adjustment [8-63](#)
- Destination
  - Add [3-32](#)
  - Address Book [5-27](#), [5-29](#)
  - Address Book Type [8-30](#)
  - Checking and Editing [5-30](#)
  - Checking/Editing [5-30](#)
  - Confirmation Screen of Destinations [5-30](#)
  - Destination Check before Send [5-30](#)
  - Multi Sending [5-23](#)
  - One Touch Key [3-37](#)
  - Quick No. Specification [5-29](#)
  - Recall [5-31](#)
  - Search [5-28](#)
  - Select from Address Book [5-27](#), [5-29](#)
  - Selecting Using One Touch Keys [5-29](#)
  - Sort [8-30](#)
- Device [7-10](#)
- DHCP [12-30](#)
  - Settings [8-38](#), [8-41](#)
- DHCP (IPv6) [12-30](#)
- DHCP(IPv6)
  - Settings [8-39](#)
- Display for Device Information [3-11](#)
- Display Setting Screen [3-11](#)
- Display Status/Log [8-21](#)
- Displaying Job History Screen [7-7](#)
- Document Box
  - Custom Box [3-48](#)
  - External Memory Box [3-49](#)
  - Job Box [3-48](#)
- Document Box Settings [8-32](#)
- Document Box/Removable Memory
  - Custom Box [8-26](#)
  - Polling Box [8-26](#)

- Document Name Entry
  - Default [8-17](#)
- Document Processor
  - Loading Originals [5-4](#)
  - Originals Supported by the Document Processor [5-4](#)
- dpi [12-30](#)
- Drum Refresh [8-64](#)
- DSM Scan [5-22](#)
  - Protocol Settings [8-45](#)
- Duplex [6-32](#)

## E

- EcoPrint [6-18](#), [12-30](#)
- Edit Destination
  - Address book [3-32](#)
  - Address Book Defaults [8-30](#)
  - Edit Restriction [8-30](#)
  - Group [3-35](#)
  - Individual [3-32](#)
  - One Touch Key [3-37](#)
- E-mail Settings [2-45](#)
- Emulation [8-32](#), [12-30](#)
- Encrypted PDF Password [6-55](#)
- Energy Saver Recovery Level [2-22](#)
- Energy Saving Control Function [1-17](#)
- Energy Star Program [1-21](#)
- Enhanced WSD [12-30](#)
  - Protocol Settings [8-49](#)
- Enhanced WSD over SSL
  - Protocol Settings [8-49](#)
- Enter Key [3-12](#)
- Entry File Name [6-38](#)
- Entry Subject [6-50](#)
- Envelopes [12-21](#)
- Environment [1-3](#)
- Error Handling [8-19](#), [8-20](#)
  - Finished Pages Exceeded [8-19](#)
  - Paper Mismatch Error [8-19](#)
  - Staples Empty [8-19](#)
- eSCL over SSL
  - Protocol Settings [8-50](#)

## F

- Favorites
  - Add [3-43](#)
  - Delete [3-45](#)
  - Edit [3-45](#)
  - Program Mode Execution [3-45](#)
  - Wizard Mode Execution [3-44](#)
- FAX Settings [8-27](#)
- File Format [6-43](#)
- File Management Utility [5-22](#), [5-23](#)
- File Name Entry [6-38](#)
- File PDF [6-44](#)
- File Separation [6-48](#)
- Finish Documents by Job [8-20](#)
- FMU Connection [5-22](#)
- FTP [12-30](#)
- FTP Client (Sent)
  - Protocol Settings [8-44](#)

FTP Encrypted TX 6-51  
    Default 8-17  
FTP Server (Receive)  
    Protocol Settings 8-44  
Function Key Assignment 3-4, 8-21  
Functions key 3-11

## G

Google Cloud Print 5-45  
GPL/LGPL 1-11  
Grayscale 12-30  
Group Authorization 9-17  
    Group List 9-18  
Group Authorization Setting  
    Group Authorization 9-17  
Guest Authorization Settings 9-20  
    Guest Authorization 9-20  
    Guest Properties 9-20  
Guides Provided with the Machine -xlviii

## H

Hagaki (Cardstock) 12-21  
Help 12-30  
Hold Name 8-35  
Home 8-23  
Home Customize Taskbar 3-8  
Home Screen 3-6  
HTTP  
    Protocol Settings 8-46  
HTTPS  
    Protocol Settings 8-46  
Hue Adjustment 6-21

## I

ID Card Copy 6-3  
Install  
    Mac 2-35  
    Software 2-27  
    Windows 2-28  
Interface Block Setting 8-54  
Internet 8-29  
IP Address 12-30  
    Settings 8-38, 8-41  
IPP 12-31  
    Protocol Settings 8-46  
IPP over SSL  
    Protocol Settings 8-47  
IPSec 8-43

## J

Job  
    Available Status 7-2  
    Canceling 7-9  
    Checking History 7-10  
    Checking Status 7-2  
    Detailed Information 7-6  
    Detailed Information of Histories 7-8  
    Displaying Status Screens 7-2  
    Pause and Resumption 7-9  
    Sending the Log History 7-8, 8-7  
Job Accounting 9-29  
    Accounting Report 9-43  
    Add 9-31  
    Checking the Counter 9-41  
    Defaults 9-39  
    Delete 9-34  
    Edit 9-33  
    FAX 9-37  
    Job Accounting Access 9-30  
    Logout 9-45  
    Print 9-34  
    Restrictions 9-32  
    TWAIN 9-35  
    WIA 9-36  
Job Accounting Settings  
    Apply Limit 9-33  
    Copy/Print Count 9-45  
Job Box 12-31  
    Private Print 5-40  
    Proof and Hold 5-43  
    Quick Copy Box 5-42  
    Quick Copy Job Retention 8-26  
    Specifying a Job Box from a Computer and Saving a  
        Job 4-11  
Job Finish Notice 6-37  
Job Finish Notice Setting 8-6  
JPEG/TIFF Printing 6-57

## K

KPDL 12-31

## L

Labels 12-20  
LAN Cable 2-8  
    Connecting 2-9  
Laser Scanner Cleaning 11-32  
LDAP  
    Protocol Settings 8-45  
Loading Originals 5-14  
    Document processor 2-3  
Loading Paper 10-9  
Local Authorization 9-17  
Login 3-14  
Logout 3-15  
Long Original 6-55  
Low Power Mode 2-22  
Low Toner Alert Level 8-20  
LPD  
    Protocol Settings 8-44

## M

- Mail Subject/Body
  - Default [8-17](#)
- Management [9-5](#)
- Manual Settings (IPv6) [8-39](#), [8-42](#)
- Margin
  - Default [8-17](#)
- Measurement [8-19](#), [8-20](#)
- Mixed Size Originals [6-7](#)
  - Combinations [6-7](#)
- Mixed Size Stapling [6-13](#)
- Mopria [5-45](#)
- MP (Multi Purpose) tray [2-4](#)
- Multi Purpose Tray [12-31](#)
  - Paper Size and Media Type [8-10](#)
- Multi Purpose tray
  - Loading Envelopes or Cardstock [5-9](#)
  - Loading Paper [5-7](#)
- Multi Sending [5-23](#)

## N

- NetBEUI [12-31](#)
  - Protocol Settings [8-44](#)
- NetWare
  - Settings [8-52](#)
- Network
  - Preparation [2-13](#)
- Network Interface [2-8](#)
- Network Interface Connector [2-5](#)
- Network Settings
  - NFC Settings [2-21](#)
- Network settings
  - Wired Network Settings [2-13](#), [2-19](#)
  - Wireless Network Settings [2-15](#)
- NFC
  - Printing [5-46](#)
  - Setup [2-21](#)

## O

- OCR Dictionary Installation [xxviii](#)
- OCR Output Format [xxviii](#), [6-44](#)
- OCR Text Recognition [xxviii](#), [6-44](#), [6-47](#), [8-18](#)
- OCR Text Recognition Action [xxx](#), [8-25](#)
- Offset One Page Documents [8-21](#)
- One Touch Key
  - Assign [3-37](#)
  - Delete [3-39](#)
  - Modify [3-38](#)
- Operation panel [2-3](#)
- Option
  - Overview of Optional Equipment [12-2](#)
- Option Interface Slot [2-5](#)
- Option Network
  - Basic Settings [8-52](#)
  - Wireless Network [8-53](#)
- Optional Function [8-58](#), [8-59](#)
- Original Image [6-17](#)
- Original Orientation [6-9](#)
- Original Preview [3-12](#)
- Original Size [6-4](#)

- Original Stopper [5-6](#)
- Original width guides [2-4](#)
- Original/Paper Settings [8-12](#)
- Outline font [12-31](#)
- Output Stopper [3-22](#)

## P

- Panel Reset Timer [8-60](#)
- Paper
  - [5-9](#)
  - Cassette [8-9](#)
  - Handling Precautions [3-4](#), [3-17](#)
  - Loading an Original on the Multi Purpose Tray [5-14](#)
  - Loading Paper into a Cassette [3-19](#)
  - Multi Purpose Tray [8-10](#)
  - Selecting Paper Feeder Units [3-18](#)
  - Special Paper [12-19](#)
- Paper Length Guide [3-19](#)
- Paper Output [6-15](#), [8-19](#), [8-20](#)
- Paper Selection [6-7](#)
- Paper Settings [8-13](#)
- Paper Width Guide [3-20](#)
- PaperChecking the Remaining Amount of PaperPaper [7-12](#)
- PaperSize and Media Type [12-16](#)
- Part Names [2-12](#)
- PDF/A [12-31](#)
- PIN Code Authorization [9-26](#)
- Ping [8-50](#)
- Place the originals [5-3](#)
  - Platen [5-3](#)
- POP3 [12-31](#)
- POP3 (Mail Receive)
  - Protocol Settings [8-44](#)
- PostScript [12-31](#)
- Power Cable
  - Connecting [2-9](#)
- Power Management [1-20](#)
- Power OFF [2-10](#)
- Power On [2-10](#)
- Power switch [2-3](#)
- PPM [12-31](#)
- Preprinted paper [12-22](#)
- Prevent Bleed-thru [6-26](#)
  - Default [8-16](#)
- Primary OCR Language [xxviii](#), [8-18](#)
- Printer
  - Copies [8-32](#)
  - Emulation [8-32](#)
  - Print Setting [5-45](#)
- Printer Driver [12-32](#)
  - Changing Defaults [3-48](#)
  - Help [4-4](#)
  - Print Settings [4-2](#)
- Printer Settings [8-32](#)
- Printing
  - Printing on Non-standard Size Paper [4-7](#)
  - Printing on Standard Size Paper [4-6](#)
  - Printing from PC [5-45](#)
  - Printing from Removable USB Memory [5-47](#)
  - Product Library [xlviii](#)

Proxy [8-51](#)

## Q

Quick No. Search key [3-13](#)

Quick Setup Wizard [2-25](#)

## R

RA (Stateless) [12-32](#)

Setting [8-39](#), [8-42](#)

RAM Disk [12-32](#)

Raw Port

Protocol Settings [8-47](#)

Recycled paper [12-22](#)

Regular Maintenance [10-2](#)

Resource Saving - Paper [1-19](#)

Responding to Messages [11-10](#)

## S

Safety Conventions in This Guide [1-2](#)

Saturation [6-25](#)

Saving Documents to USB Memory [5-47](#)

Scan Resolution

Default [8-16](#)

Send

Using a FAX Server to Send [5-24](#)

Send Result Report [8-6](#)

Send to Folder (FTP) [5-14](#)

Send to Folder (SMB) [5-14](#)

Send to FTP [5-18](#)

Sending [5-14](#)

Sending Mail [5-14](#)

Sending Size [6-42](#)

Sending to a Shared Folder in a PC [5-16](#)

Sending to an Folder on an FTP Server [5-18](#)

Setting Date and Time [2-12](#)

Sharpness [6-22](#)

Shortcut

Editing Shortcuts [3-46](#)

Shortcuts [3-46](#), [5-14](#)

Delete [3-47](#)

ShortcutsEditing and Deleting Shortcuts [3-46](#)

Show Power Off Message [8-21](#)

Simple Login [3-15](#)

Simple Login Settings

Simple Login [9-23](#)

Skip Blank Page [6-40](#)

Sleep [2-23](#)

Sleep Level

Energy Saver [2-24](#)

Quick Recovery [2-24](#)

Slit Glass [2-3](#)

SMB Client (Send)

Protocol Settings [8-44](#)

SMB Send [5-16](#)

SMTP [12-32](#)

SMTP (Mail Send)

Protocol Settings [8-44](#)

SNMP

Protocol Settings [8-45](#)

SNMPv3

Protocol Settings [8-45](#)

Sort/Offset

Default [8-16](#)

Sound [8-11](#)

Specifications [12-23](#)

Document Finisher [12-27](#)

SSD Initialization [8-57](#)

SSL

Security Settings [8-50](#)

Staple [6-12](#)

Staple Cartridge Replacement

Document Finisher [10-10](#)

Status Monitor

Notification Settings [4-17](#)

Quit [4-14](#)

Startup [4-17](#)

Status Page [12-32](#)

Storing Size [6-54](#)

Subnet Mask [12-32](#)

Settings [8-38](#), [8-41](#)

SuppliesChecking the Remaining Amount [7-12](#)

Symbols [1-2](#)

System Menu

Adjustment/Maintenance [8-63](#)

Application [8-28](#)

Cassette/MP Tray Settings [8-9](#)

Common Settings [8-11](#)

Copy [8-24](#)

Date/Timer/Energy Saver [8-60](#)

Document Box [8-32](#)

Edit Destination [8-30](#)

FAX [8-27](#)

Home [8-23](#)

Internet [8-29](#)

Operation Method [8-2](#)

Printer [8-32](#)

Quick Setup Wizard [2-25](#)

Report [8-5](#)

Send [8-32](#)

System/Network [8-35](#)

User Information [9-12](#)

User Login/Job Accounting [8-31](#)

System Menu/Counter [8-8](#)

System/Network [8-35](#)

Bluetooth Settings [8-55](#)

Data Security [8-57](#)

Interface Block Settings [8-54](#)

Network [8-35](#)

OCR Dictionary Installation [8-58](#)

Optional Function [8-58](#), [8-59](#)

Primary Network (Client) [8-54](#)

Restart Entire Device [8-55](#)

Security Level [8-55](#)

## T

TCP/IP [12-32](#)

TCP/IP (IPv4)

Settings [2-13](#), [8-38](#)

TCP/IP (IPv6) [12-30](#)

- Thick paper [12-21](#)
- Thin Print over SSL
  - Protocol Settings [8-48](#)
- ThinPrint
  - Protocol Settings [8-48](#)
- Toner Container [2-4](#)
- Touch Panel [3-6](#)
- Transmission Settings [8-32](#)
  - Recall [8-25](#)
- Transparencies [12-20](#)
- Tray 1 to 5 [2-6](#)
- Troubleshooting [11-2](#)
  - Color printing Trouble [11-9](#)
  - Machine Operation Trouble [11-3](#)
  - Printed image Trouble [11-6](#)
- TWAIN [12-33](#)
  - Scanning [5-19](#)
- Wi-Fi Direct
  - Printing [5-45](#)
  - Setup [2-19](#), [8-35](#)
- Wireless Network Settings
  - Settings [2-15](#)
- WSD Print
  - Protocol Settings [8-45](#)
- WSD Scan [5-21](#)
  - Protocol Setting [8-45](#)

## X

- XPS Fit to Page [6-58](#)
  - Default [8-17](#)

## Z

- Zoom [6-27](#)

## U

- USB [12-33](#)
- USB Cable
  - Connecting [2-9](#)
- USB Interface [2-8](#)
- USB Interface Connector [2-5](#)
- USB Memory
  - Checking Information [5-48](#)
  - Printing [5-47](#)
- USB Memory Slot [2-3](#)
- USB MemoryRemove [5-48](#)
- USB MemorySave [5-47](#)
- Useful Sending Method [5-21](#)
- User Information [9-12](#)
- User Login Administration
  - Adding a User [9-7](#)
  - Enabling [9-5](#)
  - FAX [9-16](#)
  - Group Authorization [9-17](#)
  - Guest Authorization Settings [9-20](#)
  - IC Card Settings [9-26](#)
  - Local Authorization [9-17](#)
  - Login [3-14](#)
  - Logout [3-15](#)
  - Modifying User Information [9-11](#)
  - Obtain NW User Properties [9-22](#)
  - Overview of User Login Administration [9-3](#), [9-5](#)
  - PIN Code Authorization [9-26](#)
  - Printing [9-13](#)
  - Simple Login Settings [9-23](#)
  - TWAIN [9-14](#)
  - User Account Lockout Setting [9-6](#)
  - WIA [9-15](#)
- User/Job Accounting
  - Unknown ID Job [9-46](#)
  - Unknown User Settings [9-46](#)

## W

- Waste Toner Box [2-4](#)
- WIA [12-33](#)
  - Scanning [5-19](#)
- WIASetting WIA Driver [2-37](#), [2-39](#)



**QUALITY  
CERTIFICATE**

This machine has passed  
all quality controls and  
final inspection

**KYOCERA Document Solutions America, Inc.****Headquarters**

225 Sand Road,  
Fairfield, New Jersey 07004-0008, USA  
Phone: +1-973-808-8444  
Fax: +1-973-882-6000

**Latin America**

8240 NW 52nd Terrace Dawson Building, Suite 100  
Miami, Florida 33166, USA  
Phone: +1-305-421-6640  
Fax: +1-305-421-6666

**KYOCERA Document Solutions Canada, Ltd.**

6120 Kestrel Rd., Mississauga, ON L5T 1S8,  
Canada  
Phone: +1-905-670-4425  
Fax: +1-905-670-8116

**KYOCERA Document Solutions****Mexico, S.A. de C.V.**

Calle Arquimedes No. 130, 4 Piso, Colonia Polanco  
Chapultepec, Delegacion Miguel Hidalgo,  
Distrito Federal, C.P. 11560, México  
Phone: +52-555-383-2741  
Fax: +52-555-383-7804

**KYOCERA Document Solutions Brazil, Ltda.**

Alameda África, 545, Pólo Empresarial Consbrás,  
Tamboré, Santana de Parnaíba, State of São Paulo, CEP  
06543-306, Brazil  
Phone: +55-11-2424-5353  
Fax: +55-11-2424-5304

**KYOCERA Document Solutions Chile SpA**

Jose Ananias 505, Macul. Santiago, Chile  
Phone: +562-2350-7000  
Fax: +562-2350-7150

**KYOCERA Document Solutions****Australia Pty. Ltd.**

Level 3, 6-10 Talavera Road North Ryde N.S.W, 2113,  
Australia  
Phone: +61-2-9888-9999  
Fax: +61-2-9888-9588

**KYOCERA Document Solutions****New Zealand Ltd.**

Ground Floor, 19 Byron Avenue, Takapuna, Auckland,  
New Zealand  
Phone: +64-9-415-4517  
Fax: +64-9-415-4597

**KYOCERA Document Solutions Asia Limited**

13/F., Mita Centre, 552-566, Castle Peak Road Tsuen Wan,  
New Territories, Hong Kong  
Phone: +852-2496-5678  
Fax: +852-2610-2063

**KYOCERA Document Solutions****(China) Corporation**

8F, No. 288 Nanjing Road West, Huangpu District,  
Shanghai, 200003, China  
Phone: +86-21-5301-1777  
Fax: +86-21-5302-8300

**KYOCERA Document Solutions****(Thailand) Corp., Ltd.**

335 Ratchadapisek Road, Wongsawang, Bangsue,  
Bangkok 10800,  
Thailand  
Phone: +66-2-586-0333  
Fax: +66-2-586-0278

**KYOCERA Document Solutions****Singapore Pte. Ltd.**

12 Tai Seng Street #04-01A,  
Luxasia Building, Singapore 534118  
Phone: +65-6741-8733  
Fax: +65-6748-3788

**KYOCERA Document Solutions****Hong Kong Limited**

16/F., Mita Centre, 552-566, Castle Peak Road Tsuen Wan,  
New Territories, Hong Kong  
Phone: +852-3582-4000  
Fax: +852-3185-1399

**KYOCERA Document Solutions****Taiwan Corporation**

6F., No.37, Sec. 3, Minquan E. Rd.,  
Zhongshan Dist., Taipei 104, Taiwan R.O.C.  
Phone: +886-2-2507-6709  
Fax: +886-2-2507-8432

**KYOCERA Document Solutions Korea Co., Ltd.**

#10F Daewoo Foundation Bldg 18, Toegye-ro, Jung-gu,  
Seoul, Korea  
Phone: +822-6933-4050  
Fax: +822-747-0084

**KYOCERA Document Solutions****India Private Limited**

Second Floor, Centrum Plaza, Golf Course Road,  
Sector-53, Gurgaon, Haryana 122002, India  
Phone: +91-0124-4671000  
Fax: +91-0124-4671001

**KYOCERA Document Solutions Europe B.V.**

Bloemlaan 4, 2132 NP Hoofddorp,  
The Netherlands  
Phone: +31-20-654-0000  
Fax: +31-20-653-1256

**KYOCERA Document Solutions Nederland B.V.**

Beechavenue 25, 1119 RA Schiphol-Rijk,  
The Netherlands  
Phone: +31-20-5877200  
Fax: +31-20-5877260

**KYOCERA Document Solutions (U.K.) Limited**

Eldon Court, 75-77 London Road,  
Reading, Berkshire RG1 5BS,  
United Kingdom  
Phone: +44-118-931-1500  
Fax: +44-118-931-1108

**KYOCERA Document Solutions Italia S.p.A.**

Via Monfalcone 15, 20132, Milano, Italy,  
Phone: +39-02-921791  
Fax: +39-02-92179-600

**KYOCERA Document Solutions Belgium N.V.**

Sint-Martinusweg 199-201 1930 Zaventem,  
Belgium  
Phone: +32-2-7209270  
Fax: +32-2-7208748

**KYOCERA Document Solutions France S.A.S.**

Espace Technologique de St Aubin  
Route de l'Orme 91195 Gif-sur-Yvette CEDEX,  
France  
Phone: +33-1-69852600  
Fax: +33-1-69853409

**KYOCERA Document Solutions Espana, S.A.**

Edificio Kyocera, Avda. de Manacor No.2,  
28290 Las Matas (Madrid), Spain  
Phone: +34-91-6318392  
Fax: +34-91-6318219

**KYOCERA Document Solutions Finland Oy**

Atomitie 5C, 00370 Helsinki,  
Finland  
Phone: +358-9-47805200  
Fax: +358-9-47805212

**KYOCERA Document Solutions****Europe B.V., Amsterdam (NL) Zürich Branch**

Hohlstrasse 614, 8048 Zürich,  
Switzerland  
Phone: +41-44-9084949  
Fax: +41-44-9084950

**KYOCERA Bilgitas Document Solutions  
Turkey A.S.**

Gülbahar Mahallesi Otello Kamil Sk. No:6 Mecidiyeköy  
34394 Şişli İstanbul, Turkey  
Phone: +90-212-356-7000  
Fax: +90-212-356-6725

**KYOCERA Document Solutions  
Deutschland GmbH**

Otto-Hahn-Strasse 12, 40670 Meerbusch,  
Germany  
Phone: +49-2159-9180  
Fax: +49-2159-918100

**KYOCERA Document Solutions Austria GmbH**

Wienerbergstraße 11, Turm A, 18. OG, 1100 Wien,  
Austria  
Phone: +43-1-863380  
Fax: +43-1-86338-400

**KYOCERA Document Solutions Nordic AB**

Esbogatan 16B 164 75 Kista, Sweden  
Phone: +46-8-546-550-00  
Fax: +46-8-546-550-10

**KYOCERA Document Solutions Norge Nuf**

Olaf Helsetsv. 6, 0619 Oslo, Norway  
Phone: +47-22-62-73-00  
Fax: +47-22-62-72-00

**KYOCERA Document Solutions Danmark A/S**

Ejby Industrivej 60, DK-2600 Glostrup,  
Denmark  
Phone: +45-70223880  
Fax: +45-45765850

**KYOCERA Document Solutions Portugal Lda.**

Rua do Centro Cultural, 41 (Alvalade) 1700-106 Lisboa,  
Portugal  
Phone: +351-21-843-6780  
Fax: +351-21-849-3312

**KYOCERA Document Solutions****South Africa (Pty) Ltd.**

KYOCERA House, Hertford Office Park,  
90 Bekker Road (Cnr. Allandale), Midrand, South Africa  
Phone: +27-11-540-2600  
Fax: +27-11-466-3050

**KYOCERA Document Solutions Russia LLC.**

Building 2, 51/4, Schepkina St., 129110, Moscow,  
Russia  
Phone: +7(495)741-0004  
Fax: +7(495)741-0018

**KYOCERA Document Solutions Middle East**

Dubai Internet City, Bldg. 17,  
Office 157 P.O. Box 500817, Dubai,  
United Arab Emirates  
Phone: +971-04-433-0412

**KYOCERA Document Solutions Inc.**

2-28, 1-chome, Tamatsukuri, Chuo-ku  
Osaka 540-8585, Japan  
Phone: +81-6-6764-3555  
<http://www.kyoceradocumentsolutions.com>

