

USER MANUAL



UNINTERRUPTIBLE POWER SUPPLY SYSTEMS (UPS)

SPS serie SOHO+

SALICRU

General index.

1. INTRODUCTION.

- 1.1. THANK YOU LETTER.

2. SAFETY INFORMATION.

- 2.1. USING THIS MANUAL.
 - 2.1.1. Conventions and symbols used.

3. QUALITY ASSURANCE AND STANDARDS.

- 3.1. STATEMENT BY THE MANAGEMENT.
- 3.2. STANDARDS.
- 3.3. ENVIRONMENT.

4. PRESENTATION.

- 4.1. VIEWS OF THE DEVICE.
- 4.2. KEY FOR THE VIEWS.
- 4.3. NOMENCLATURE.
- 4.4. DESCRIPTION.
 - 4.4.1. Main features.

5. INSTALLATION AND OPERATION.

- 5.1. RECEPTION OF THE DEVICE.
 - 5.1.1. Reception, unpacking and contents.
 - 5.1.2. Storage.
 - 5.1.3. Transport to the site.
 - 5.1.4. Siting, immobilising and considerations.
 - 5.1.4.1. Considerations.
 - 5.1.4.2. Preliminary considerations before connection, regarding the batteries and their protections.
- 5.2. CONNECTION AND COMMISSIONING.
 - 5.2.1. Procedure to follow.
 - 5.2.1.1. Audible indications.
 - 5.2.2. Communications connection.
 - 5.2.3. Software.
 - 5.2.4. Smart Battery function.

6. LCD DISPLAY.

- 6.1. GENERAL INFORMATION.
 - 6.1.1. Information represented by the display.
 - 6.1.2. Display visualisation in each device mode.
 - 6.1.3. Battery charge level.
 - 6.1.4. Load level connected to the output.

7. MAINTENANCE, WARRANTY AND SERVICE.

- 7.1. TROUBLESHOOTING GUIDE.
- 7.2. MAINTENANCE.
- 7.3. WARRANTY CONDITIONS.
 - 7.3.1. Terms of the warranty.
 - 7.3.2. Exclusions.
- 7.4. TECHNICAL SERVICES NETWORK.

8. ANNEXES.

- 8.1. TECHNICAL SPECIFICATIONS.

1. INTRODUCTION.

1.1. THANK YOU LETTER.

We thank you in advance for the trust placed in us in the purchasing of this product. Read this instruction manual carefully in order to familiarize yourself with its content, since the more you know and understand the equipment the greater your satisfaction, level of safety and optimization of its functionalities will be.

We remain at your disposal for any additional information or queries that you may wish to make.

Yours sincerely.

SALICRU

- The equipment described here **is capable of causing significant physical damage in the event of incorrect connection and/or operation**. For this reason its installation, maintenance and/or repair must be carried out exclusively by our personnel or by **qualified personnel**.
- Although no effort has been spared to ensure that the information in this user manual is complete and accurate, we are not responsible for any errors or omissions that may exist.

The images included in this document are for illustrative purposes and may not represent exactly the parts of the equipment shown, therefore they are not contractual. However, any divergence that may arise will be remedied or solved with the correct labelling on the unit.

- Following our policy of constant evolution, **we reserve the right to modify the characteristics, operations or actions described in this document without prior notice**.
- **Reproduction, copying, assignment to third parties, modification or total or partial translation** of this manual or document, in any form or by any means, **without previous written authorization by our firm is prohibited**, with the full and exclusive property rights over the same being reserved by our firm.

2. SAFETY INFORMATION.

2.1. USING THIS MANUAL.

The documentation for any standard device is available for customers to download from our website, where the most up-to-date product information can be found.

Go to our SITE: <http://www.salicru.com>

- For devices "powered by socket", this is the website for obtaining the user manual and "**Safety Instructions**" EK266*08.
- For devices with "permanent connection" via terminals, a CD-ROM or pen drive containing all necessary information for connection and start-up, including "**Safety Instructions**" EK266*08, may be supplied with it.

Before carrying out any action on the device relating to its installation or start-up, change of location, configuration or handling of any kind, carefully read the safety instructions.

The purpose of the user manual is to provide information regarding safety and explanations of the procedures for installation and operation of the equipment. Read them carefully and follow the steps indicated in the order established.



Compliance with the "Safety Instructions" is mandatory and the user is legally responsible for compliance and enforcement.

The equipment is delivered properly labelled for the correct identification of each of the parts, which together with the instructions described in this user manual allows the operations of installation and commissioning to be performed in a simple and orderly manner without having any doubts whatsoever.

Finally, once the equipment is installed and operating, it is recommended to save the documentation downloaded from the website, CD-ROM or Pen Drive in a safe and easy-to-access place, for any future queries or doubts that may arise.

The following terms are used interchangeably in the document to refer to:

- **'SPS.SOHO+, 'SPS,' 'device,' 'unit' or 'UPS'** - Uninterruptible power supply.
Depending on the context of the phrase, it can refer either to the actual UPS itself or to the UPS and the batteries, regardless of whether it is all contained in the same enclosure.
- **'Battery or accumulator'** - Element that stores the flow of electrons by electrochemical means.
- **'T.S.S.'** - Technical Service and Support.
- **'Client, installer, operator or user'** - These are used interchangeably and by extension to refer to the installer and/or operator who will carry out the corresponding actions, and the same person may be responsible for carrying out the respective actions when acting on behalf of, or in representation of, same.

2.1.1. Conventions and symbols used.

Some symbols may be used and appear on the equipment, batteries and/or in the context of the user manual.

For more information, see section 1.1.1 of document EK266*08 on "**Safety instructions**".

3. QUALITY ASSURANCE AND STANDARDS.

3.1. STATEMENT BY THE MANAGEMENT.

Our goal is customer satisfaction, therefore this Management has decided to establish a Quality and Environment Policy, through the implementation of a Quality and Environmental Management System that will enable us to comply with the requirements demanded in the **ISO 9001** and **ISO 14001** and also by our Customers and Stakeholders.

Likewise, the management of the company is committed to the development and improvement of the Quality and Environmental Management System, through:

- Communication to the entire company of the importance of satisfying both the client's requirements as well as legal and regulatory requirements.
- The dissemination of the Quality and Environment Policy and the setting of the Quality and Environment objectives.
- Conducting reviews by the Management.
- Providing the necessary resources.

3.2. STANDARDS.

The SPS.SOHO+ is designed, manufactured and sold in accordance with Quality Management Standard **EN ISO 9001**. The **CE** marking indicates conformity with EC Directives through the application of the following standards:

- **2014/35/EU**. - Low voltage safety.
- **2014/30/EU**. - Electromagnetic Compatibility (EMC).
- **2011/65/EU**. - Restriction of the use of hazardous substances in electrical and electronic equipment (RoHS).

According to the specifications of the harmonized standards. Reference standards:

- **EN-IEC 62040-1**. Uninterruptible power supplies (UPS). Part 1-1: General and safety requirements for UPS used in user access areas.
- **EN-IEC 60950-1**. Information technology equipment. Safety. Part 1: General requirements.
- **EN-IEC 62040-2**. Uninterruptible power supplies (UPS). Part 2: EMC requirements.



The manufacturer accepts no liability in the event of modification of or intervention on the device by the user.



WARNING!:

The SPS.SOHO+ is a category C2 UPS. It is not appropriate to use this device with basic life support applications, where a failure of the former can render vital equipment out of service or significantly affect its safety or effectiveness. It is also not recommended in medical applications, commercial transport, nuclear installations, or other applications or loads, where a failure of the product can lead to personal or material damages.



The EC declaration of conformity of the product is available to the customer upon express request to our headquarters.

3.3. ENVIRONMENT.

This product has been designed to respect the environment and manufactured according to **ISO 14001**.

Recycling of the equipment at the end of its useful life:

Our company undertakes to use the services of authorized and regulatory companies to treat the set of products recovered at the end of their useful life (contact your distributor).

Packaging:

For the recycling of the packaging there must be compliance with the legal requirements in force, according to the specific regulations of the country where the equipment is installed.

Batteries:

Batteries pose a serious danger to health and the environment. The disposal of them shall be carried out in accordance with the laws in force.

4. PRESENTATION.



The nameplate of the device shows all of the values relating to its main properties and characteristics. Act accordingly for its installation.

4.1. VIEWS OF THE DEVICE.

In Fig. 1, Fig. 2 and Fig. 3, illustrations of the device are shown according to box size in relation to the power rating of the model. However, because the product is constantly evolving, discrepancies or slight contradictions may arise. If in any doubt, the labelling on the equipment itself will always prevail.

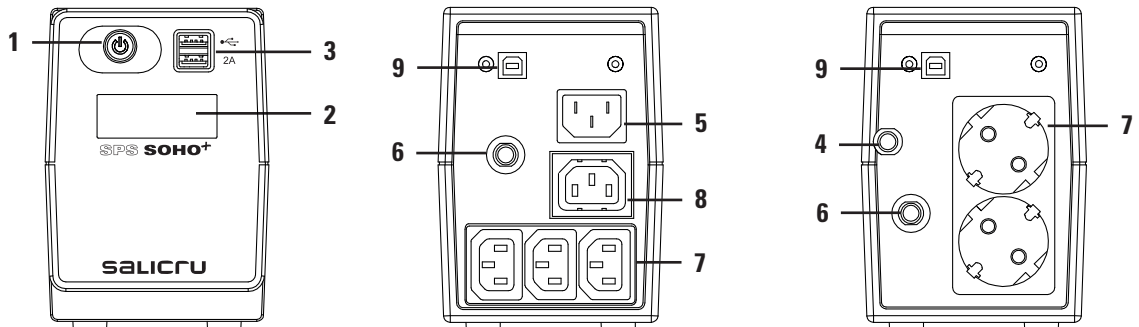

Fig. 1. View of SPS.SOH0+ 500/650/850 VA models.

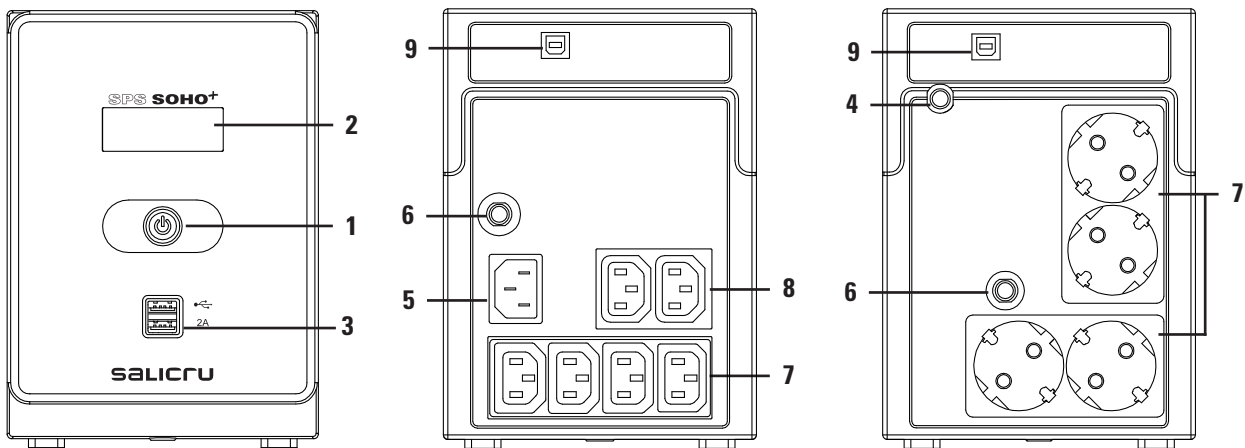

Fig. 2. View of SPS.SOH0+ 1200/1600 VA models.

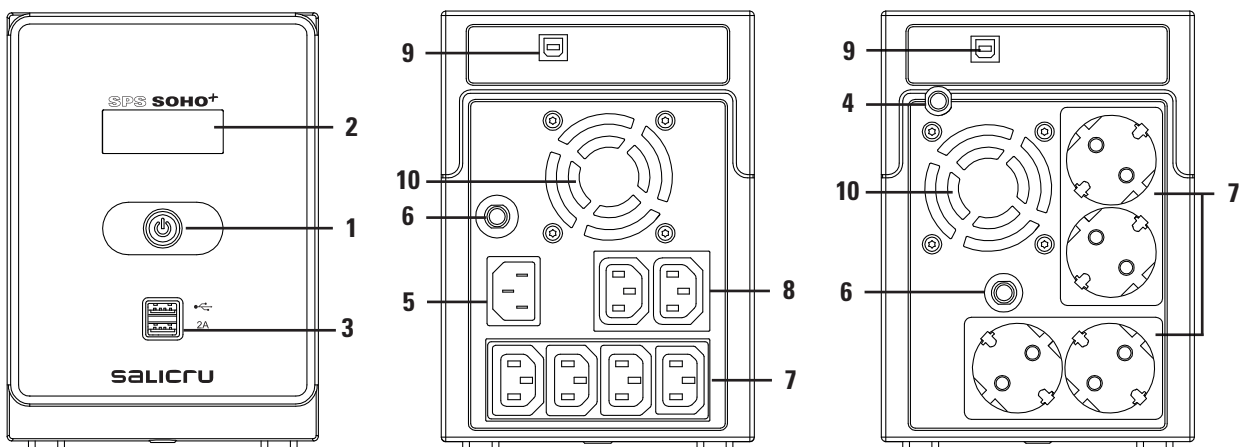

Fig. 3. View of SPS.SOH0+ 2200 VA models.

4.2. KEY FOR THE VIEWS.

1. 'On-Off' inverter start-up and stop button.
2. LCD screen.
3. USB connectors, max. 5 V 2 A charger.
4. Device power cable.
5. IEC input connector (only in SPS with IEC output sockets).
6. Resettable input protection breaker.
7. AC output sockets with backup in case of mains failure.
8. AC output sockets, direct from mains with overvoltage protection.
9. USB connector communication port.
10. Fan.

4.3. NOMENCLATURE.

SPS.500.SOHO+ "EE61837-37"

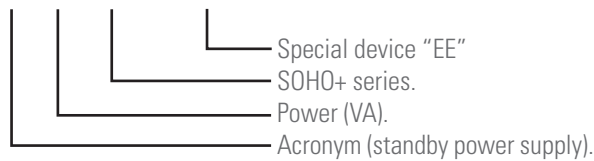

4.4. DESCRIPTION.

The SPS.SOHO+ series UPS is notable for its line-interactive technology, compatibility with APFC (active power factor correction) loads, USB interface with HID protocol and USB charger (max. 5V 2A) available through two connectors.

The main function of a UPS is to provide power, in the event of mains failure, to the devices connected to the output sockets through its internal battery for a limited time.

Line-interactive systems use AVR (buck-boost) automatic voltage regulators to provide constant voltage at the output and reduce possible fluctuations in input voltage, thereby lowering battery use and providing maximum backup where necessary. Outside this range, or with mains power absent, the inverter supplies pseudo sine wave power from the batteries for a limited time.

When mains power is restored or returns to its corresponding range, the load is again powered from the mains after being filtered through the stabiliser.

By simply being connected to the mains, the batteries will recharge.

If the SPS is overloaded in any of its operating modes, it will shut down the output after a few seconds:

- Line mode.
 - 110% overload: shutdown at 5 min and switch to fault mode.
 - 120% overload: shutdown at 5 s and switch to fault mode.
- Battery mode.
 - 110% overload: shutdown after 5 s.
 - 120% overload: immediate shutdown.

The device has automatic input frequency detection which is activated when it is connected to the power mains.

Models with IEC output sockets, depending on the power, have one or two direct mains sockets for the connection of non-critical loads, with battery backup reserved for the sockets exclusively used for critical loads. The power of the loads connected to each group of output sockets should never exceed their limits nor should the sum of both exceed the rated power

of the unit in VA, otherwise the internal protections could be activated leading to a cut in power to the loads.

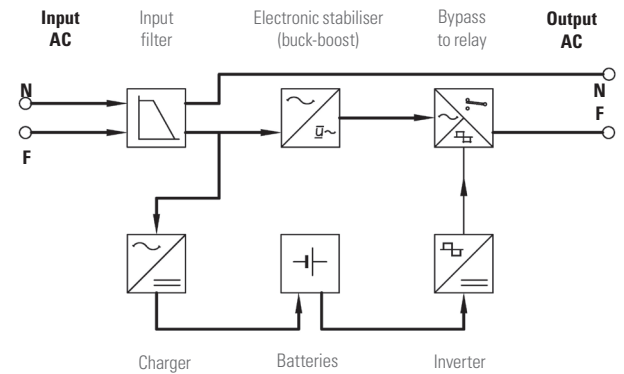

Fig. 4. Structural block diagram.

4.4.1. Main features.

- Line-interactive technology.
- Permanent stabiliser (AVR).
- Automatic frequency detector 50 or 60 Hz.
- Resettable input circuit breaker.
- Schuko or IEC output sockets available.
- Compatible with APFC (active power factor correction) loads.
- Cold start function for start-up without mains.
- Automatic restart when power restored.
- Protection against overloads and short circuits.
- Dual USB charger on the front (max. 2 A).
- Control panel with LCD display.
- USB communication interface with HID protocol.
- Downloadable software for Windows, Linux and Mac.

Model	Output socket type.
SPS 500 SOHO+	Schuko
SPS 650 SOHO+	
SPS 850 SOHO+	
SPS 1200 SOHO+	
SPS 2200 SOHO+	
SPS 500 SOHO+ IEC	IEC
SPS 650 SOHO+ IEC	
SPS 850 SOHO+ IEC	
SPS 1200 SOHO+ IEC	
SPS 2200 SOHO+ IEC	

Tab. 1. Standardised models

5. INSTALLATION AND OPERATION.

-  Read and respect the Safety Information described in Chapter 2 of this document. Failure to obey some of the instructions described in this manual can result in a serious or very serious accident to persons in direct contact or in the vicinity, as well as faults in the equipment and/or loads connected to it.

5.1. RECEPTION OF THE DEVICE.

- Pay attention to section 1.2.1. of the safety instructions -EK266*08- in all matters relating to the handling, movement and siting of the unit.
- Use the most appropriate means to move the UPS.
- Any handling of the device must be carried out in accordance with the weights shown in the technical specifications according to the model, indicated in chapter 8.

5.1.1. Reception, unpacking and contents.

- Reception.
 - Check that the information on the label affixed to the packaging matches that specified on the order. Remove the packing unit and check the above information against that on the nameplate of the SPS.SOHO+. If there are any discrepancies, report them, quoting the references on the delivery note.
 - Check that no mishaps have occurred during transportation.
- Unpacking.
 - The packaging consists of a full-colour cardboard box, a plastic bag and two moulded pieces of expanded polystyrene (EPS) to protect the SPS.SOHO+ from knocks.
- Contents.
 - Device.
 - Quick guide.
 - Particular terms and conditions of warranty.
 - 1 USB cable.
 - 2 IEC cables (only in SPS with IEC output sockets).
- After reception, it is advisable to store the device in its original packaging as a preventative measure if installation is not to be carried out immediately.
- When the packaging needs to be disposed of, it must be carried out in accordance with current laws. We advise keeping it for at least 1 year.

5.1.2. Storage.

- Equipment storage shall be done in a dry, ventilated place and protected from rain, dust, water splashes or chemical agents. It is advisable to keep each equipment in its original packaging as it has been specifically designed to ensure maximum protection during transport and storage.
-  The devices contain Pb-Ca batteries, whose charging times indicated in Tab 2 of document EK266*08, determined by the temperature to which they are exposed, must be respected, otherwise the warranty may be invalidated.

- After this period, connect the device to the mains according to the instructions described in this manual and charge for 8 hours.
- Then disconnect and store the UPS in its original packaging, noting the new date for recharging the batteries on a document as a record or even on the packaging itself.
- Do not store the devices where the ambient temperature exceeds 50°C or drops below -20°C, as this may cause degradation of the electrical characteristics of the batteries.

5.1.3. Transport to the site.

- It is advisable to move the UPS using the most suitable means for this. If the distance is considerable, it is recommended to transport the device in its packaging to the installation site and then unpack it.

5.1.4. Siting, immobilising and considerations.

- Install the unit in a location which takes into consideration and complies with the Safety Instructions of document EK266*08.
- For all instructions regarding connections, refer to section 5.2.

5.1.4.1. Considerations.



- Although the internal battery is charged at the factory, it may run down during transportation and/or storage, so it should be charged for a minimum of 8 hours to ensure a full charge before using the device with complete assurance. Although the device can operate correctly without charging the battery for the specified time, the risk of a prolonged mains outage during the first hours of operation and the UPS's available backup time should be assessed.
- To recharge the battery, simply leave the unit plugged into an AC socket. The battery will charge irrespective of whether the device is switched on or off.
- If the rated capacities are exceeded, an overload condition will occur. If mains power is present, the input breaker will trip and, in battery mode, the device's inverter will be blocked. Either way, the end result will be an unwanted stoppage of the device and loads.
- For optimum performance, keep the load connected to the SPS below 80% of rated capacity.

5.1.4.2. Preliminary considerations before connection, regarding the batteries and their protections.

- Check that the loads connected to the power sockets do not exceed the power rating of the unit, see chapter 8 of this document.
- SPS.SOHO+ devices incorporate the batteries in the same box as the device. The UPS's battery protection is internal by means of fuses and is therefore not accessible to the user.
-  If the mains power of the device is cut for longer than a simple intervention and it is expected that it will be out of service for a prolonged period time, the system must be shut down completely.





-  The battery circuit is not isolated from the input voltage. Dangerous voltages can occur between the terminals of the battery group and the earth. Check that there is no input voltage before working on the battery module connectors.

5.2. CONNECTION AND COMMISSIONING.

-  All of the device's connections, including those related to control, will be made with all of the switches in standby and without mains power present (UPS power supply line selector set to 'Off').
-  It should never be forgotten that a UPS is a generator of electrical energy, so the user must take the necessary precautions against direct or indirect contact when it is part of the facility.

5.2.1. Procedure to follow.

Observe the following order of operation and instructions:

1. Take power cable **4** and insert the plug into a properly connected AC socket with an earth connection.
For models with IEC output sockets, it is necessary to purchase a cable for powering the device, connected to an AC power socket and to connector **5** at its opposite end. The socket that supplies power to the device must have a properly connected earth cable ().
 The SPS.SOH0+'s power socket should be protected by a fuse or circuit breaker limiter. This line must not power machines with large electrical demands such as air conditioning units, refrigerators, etc.).
Avoid the use of extension cables, since the SPS itself could be considered as a PDU.
2. Plug all of the elements to be protected by the UPS into the device's output sockets **7**.
 **Do not plug in** laser printers, paper shredders or other high-consumption electrical devices or high current probes. The power demand of any of these devices will overload the SPS and possibly damage the unit.
Models with IEC output sockets, depending on the power, have one or two direct mains sockets **8** for the connection of non-critical loads **7**, with battery backup reserved for the sockets exclusively used for critical loads. The power of the loads connected to each group of output sockets should never exceed their limits nor should the sum of both exceed the rated power of the unit in VA, otherwise the internal protections could be activated leading to a cut in power to the loads.
3. Press start-stop button **1** to start the unit. The display will light up and the unit will emit a beep.
 It is possible to start the unit without mains power (Coldstart function) by pressing on start-stop button **1**. This, however, is not recommended because if a mains failure extends beyond the available backup, it will be necessary to carry out a forced stop.
In the event of a mains failure and the battery's backup reaching its end, the device will be automatically blocked, leaving the loads unpowered.
 Similarly, when mains voltage returns, the device will start automatically.

4. If an overload is detected, an audible alarm consisting of a modulated beep every 0.5 s will sound. To correct this situation, it is necessary to switch the UPS off and disconnect the load that exceeds the rated power of output sockets **7**. Wait 10 seconds. Check that the fuse or circuit breaker of the line that supplies the SPS is correct or set to 'On' and then restart the UPS by pressing button **1**.
5. To keep the battery fully charged, always leave the SPS plugged into a live AC power outlet.
6. If the UPS is stored or put away for a prolonged period of time, protect it from dust, knocks, etc., and keep the battery fully charged. Recharge the battery according to the time set in Table 2 of the EK266*08 Safety Instructions document and in correlation with the ambient temperature to which the SPS.SOH0+ is subject. That way, a longer battery life will be ensured.

5.2.1.1. Audible indications.

Audible alarm	Status
Modulated every 10 s	Battery mode.
Modulated every second.	Low battery.
Modulated every 0.5 s	Overload.
Permanent.	Fault.

Tab. 2. Audible indications guide.

5.2.2. Communications connection.

Connect the communications cable supplied with the device to the UPS's USB port and the other end to the computer. With the WinPower software installed on the PC, both the status of the UPS can be monitored and a shutdown/automatic start can be performed remotely.

5.2.3. Software.

- **Download of free WinPower software.**
WinPower is a UPS monitoring software which provides a user-friendly interface for monitoring and control. It features an auto shutdown function for systems consisting of several PCs in case of power failure. The software enables users to monitor and control any SPS in the same LAN through an RS232 or USB communications port, regardless of how far away they are from each other.

- **Installation procedure:**

- Go to the web page:
http://support.salicru.com
- Select the required operating system and follow the instructions described on the web page to download the software.
- When downloading all of the necessary files from the Internet, enter the following serial number to install the software:
511C1-01220-0100-478DF2A .

When the computer is restarted, the WinPower software will appear as a green plug icon in the system tray near the clock.

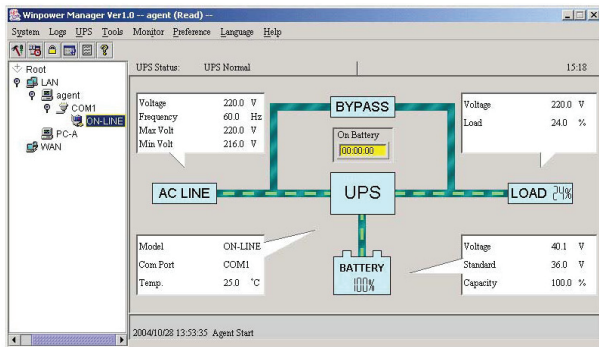

Fig. 5. View of the monitoring software's main screen.

5.2.4. Smart Battery function.

With the UPS connected to a Windows-installed PC via a USB cable, a battery icon appears in the system tray.

- You can access basic device information (charge/discharge/ battery capacity) by clicking on the battery icon.

Device in charging mode.

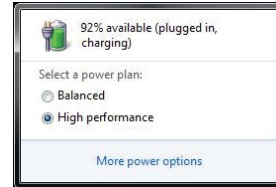

Device in discharging mode.

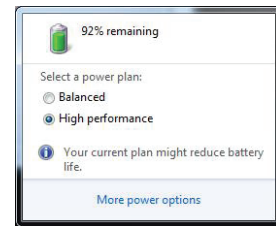

Fig. 6. Battery status screens.

- You can select Sleep/Hibernation/Off or do nothing when the device has low battery or critical battery.

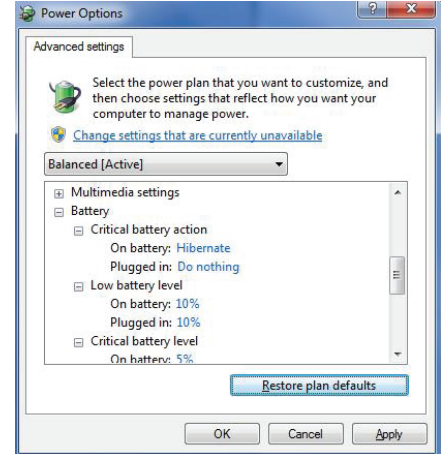
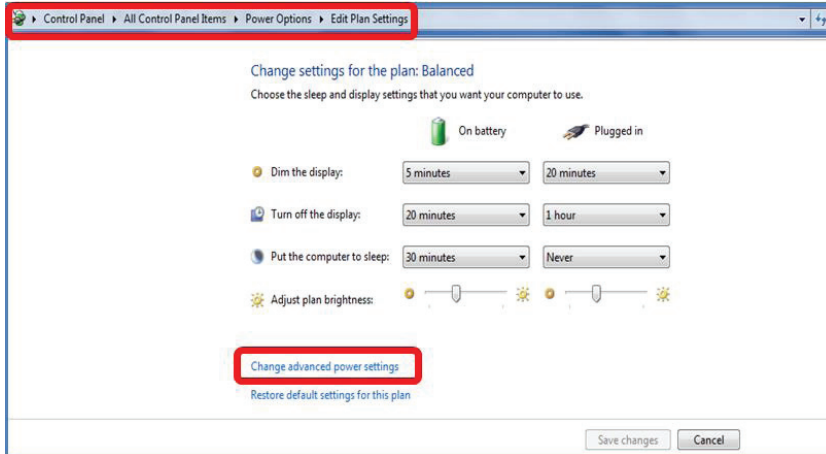
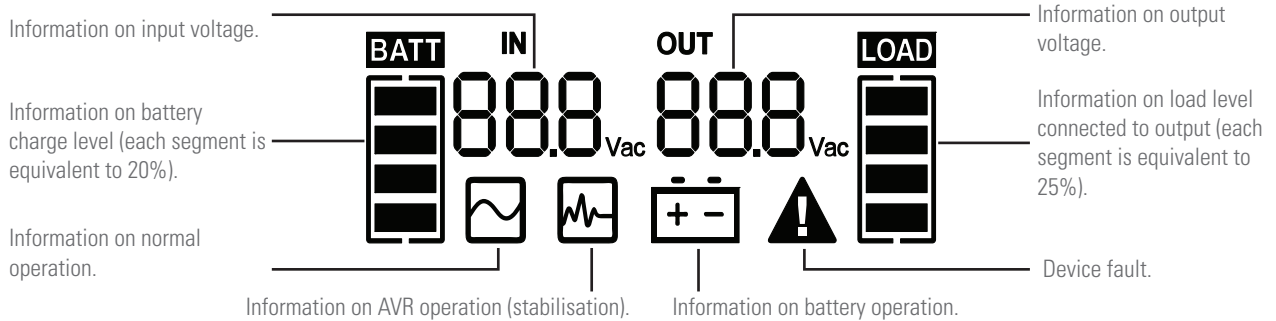

Fig. 7. Device settings screens.

6. LCD DISPLAY.

6.1. GENERAL INFORMATION.

6.1.1. Information represented by the display.



 The LCD display does not show any alarm or information regarding the direct mains output sockets and available only on models with IEC sockets).

Fig. 8. Graphic and textual information shown on the display

6.1.2. Display visualisation in each device mode.

- Normal mode.



Fig. 9. Display in normal mode.

- Battery charger mode.

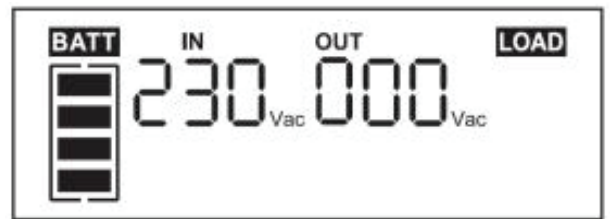

Fig. 12. Display in battery charger mode.

- AVR mode (stabilisation).

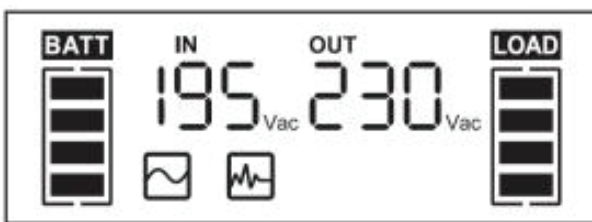

Fig. 10. Display in AVR (stabilisation) mode.

- Fault mode

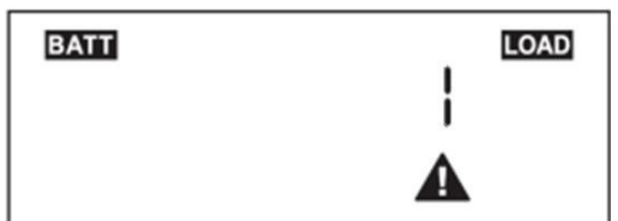

Fig. 13. Display in fault mode.

- Battery mode.



Fig. 11. Display in battery mode.

6.1.3. Battery charge level.



Indicates % of battery charge. Each bar represents 20% of the total capacity. When the battery is less than 20%, the symbol flashes every second.

6.1.4. Load level connected to the output.



Indicates % of connected loads. Each load bar represents 25% of total power. When there is an overload, the symbol flashes every second.

7. MAINTENANCE, WARRANTY AND SERVICE.

7.1. TROUBLESHOOTING GUIDE.

- If the UPS is not working properly, before calling **T.S.S.**, try to resolve the issue using the information in Tab. 3.

Issue.	Possible cause.	Solution.	
Unable to see the display.	ON/OFF button not pressed.	Press ON/OFF button.	
	Battery discharged.	Connect UPS to power socket and allow to charge for at least 8 hours.	
	Battery defect.	Contact distributor or seller, failing that, T.S.S.	
Low backup in battery mode.	Overload at the output.	Disconnect non-critical loads.	
	Battery voltage low.	Connect UPS to power socket and allow to charge for at least 8 hours.	
	Batteries defective	Contact distributor or seller, failing that, T.S.S.	
With voltage present, battery mode is activated.	Input breaker tripped	Reset input breaker.	
	Input cable defective or badly connected.	Check cable and proper connection.	
Loss of communication signal.	Software incorrectly installed.	Check software configuration.	
	Communication cable defective or incorrectly connected.	Check cable and proper connection.	
USB does not charge in normal mode.	USB cable defective or incorrectly connected.	Check cable and proper connection.	
Audible alarm sounds continuously.	Code	Type of fault	Solution
	1	Short circuit.	Disconnect defective loads.
	2	Overload.	Check loads are compatible with device.
	3	Line fault.	Restart device. If problem persists, contact distributor or seller, failing that, our T.S.S.
	4	Internal fault.	
	5	Charger fault.	
	6	Battery fault.	Check fan is locked. If not, contact distributor or seller, failing that, our T.S.S.
7	Fan locking fault.		

Tab. 3. Troubleshooting guide.

7.2. MAINTENANCE.

- This product does not require preventative maintenance.

7.3. WARRANTY CONDITIONS.

7.3.1. Terms of the warranty.

On our website you will find the warranty conditions for the product you have purchased where you can also register it. It is recommended to do so as soon as possible to include it in the database of our Technical Service and Support (**T.S.S.**). Among other advantages, it will streamline any regulatory procedures for the intervention of **T.S.S.** in the event of a fault.

7.3.2. Exclusions.

Our company will not be bound by the warranty if it notices that the defect in the product does not exist or was caused by improper use, negligence, improper installation and/or verification, attempts at unauthorized repair or modification, or any other cause beyond the intended use, or by accident, fire, lightning or other hazards. Nor shall it cover any compensation for damages.

7.4. TECHNICAL SERVICES NETWORK.

Information about our national and international Technical Service and Support (**T.S.S.**) centres can be found on our website.

8. ANNEXES.

8.1. TECHNICAL SPECIFICATIONS.

Models.	SPS.500.SOHO+	SPS.650.SOHO+	SPS.850.SOHO+	SPS.1200.SOHO+	SPS.1600.SOHO+	SPS.2200.SOHO+
Power VA / W	500 / 300	650 / 360	850 / 480	1200 / 720	1600 / 960	2200 / 1200
Technology.	Line-interactive.					
Input.						
Voltage (V AC).	230 single-phase.					
Voltage range (V AC).	162.. 290.					
Stabiliser	AVR (buck-boost).					
Frequency (Hz).	50 / 60 ±5 % auto-detectable.					
Input protection.	Resettable breaker.					
Output.						
Rated voltage (V AC).	230 single-phase.					
Voltage accuracy in battery mode (%).	±10.					
Waveform (battery mode).	Pseudo sine wave.					
Frequency (Hz).	50 / 60 (same as input).					
Output frequency accuracy (Hz).	±1 (battery mode).					
Typical transfer time (ms).	2.. 6			4.. 8		
Compatibility with APFC loads.	Yes					
Output sockets.	Schuko or IEC (depending on model)					
Battery.						
Element rated voltage (V DC).	12 (Pb-Ca, sealed and maintenance-free).					
Number of elements / Capacity (Ah).	1 / 7		1 / 9	2 / 7		2 / 9
Protection.	Against deep discharge and short circuit by means of fuse.					
Typical recharge time (h).	2.. 4 to 90% charge.					
Optical and audible indication.						
Surrounding the On-Off button.	LCD display					
Physical.						
Maximum dimensions Depth × Width × Height (mm).	290 x 100 x 143			364 x 139 x 195		
Weight (kg).	4.4		5.2	10.4	10.7	11
Protection rating.	IP20					
Output sockets (Schuko models).	2			4		
Output sockets (IEC models).	4			6		
Critical load output sockets (inverter output) + direct mains sockets (overvoltage protection - IEC models).	3 + 1			4 + 2		
Environmental.						
Operating temperature (°C).	0.. 40					
Relative humidity (%).	0.. 90 non-condensing.					
Interface, communication and management.						
USB (HID).	Yes					
Winpower software.	Windows 8 / 7 / Vista / XP / 2000 / Server 2003, Linux.					
Battery self-charging.	Yes					
Auto start after mains failure.	Yes					

Tab. 4. Technical specifications.



A series of horizontal dotted lines spanning the width of the page, providing a guide for writing or drawing.

SALICRU

Avda. de la Serra 100

08460 Palautordera

BARCELONA

Tel. +34 93 848 24 00

Fax +34 93 848 22 05

services@salicru.com

SALICRU.COM



The Technical Service and Support (T.S.S.) network, Commercial network and warranty information are available in website:

www.salicru.com

Product Range

Uninterruptible Power Supplies (UPS)

Lighting Flow Dimmer-Stabilisers

DC Power Systems

Static Inverters

Photovoltaic Inverters

Voltage stabilisers

Variable frequency drives



@salicru_SA



www.linkedin.com/company/salicru

