

Always here to help you

Register your product and get support at
www.philips.com/welcome



HR1378



PHILIPS

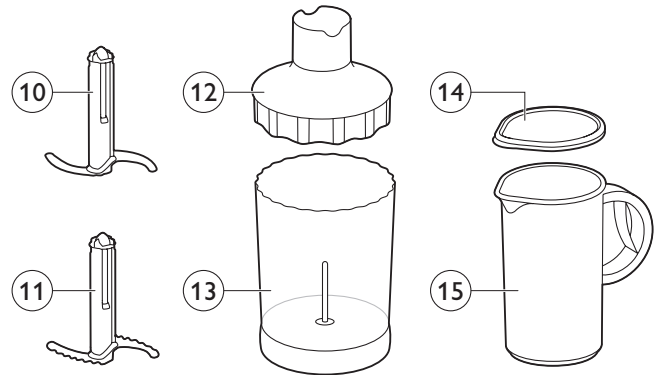
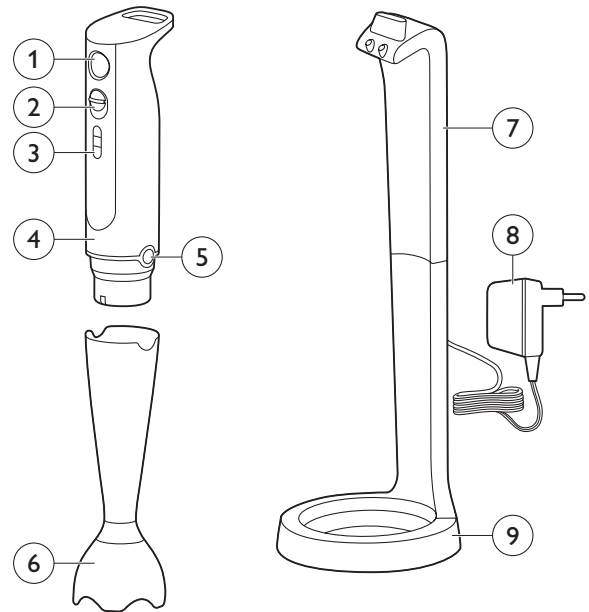

		MAX.	
		100-200 g	30 sec
		100-400 ml	60 sec
		100-500 ml	60 sec
		100-1000 ml	60 sec
→		2x2x2 cm	



www.philips.com

100% recycled paper
 100% papier recyclé
 4203.064.5561.2

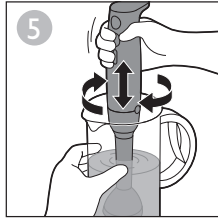
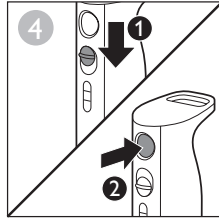
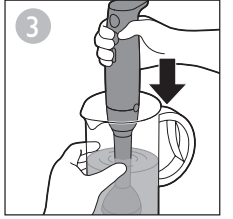
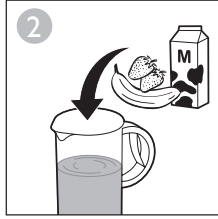
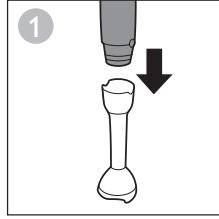
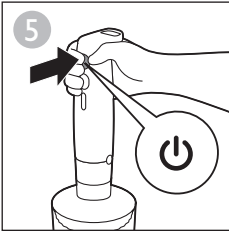
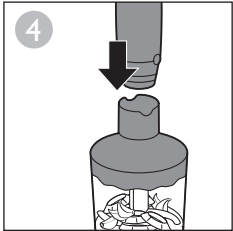
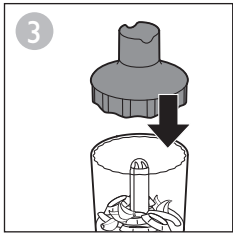
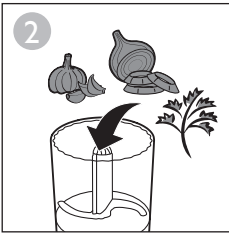
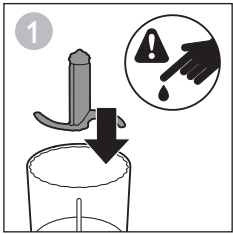
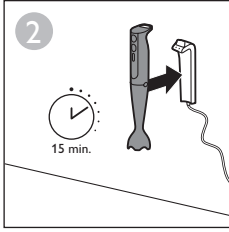
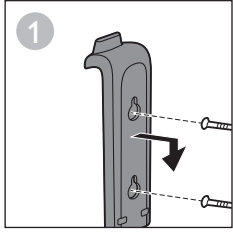
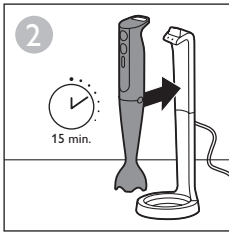
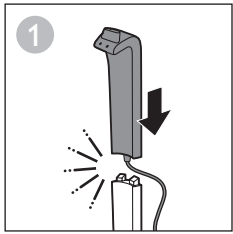

	×	×	✓
	✓	✓	✓
	✓	×	✓

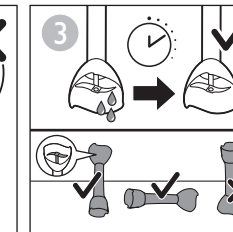
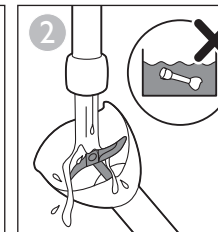
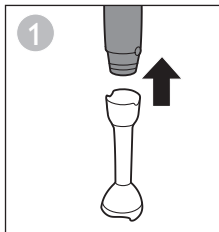

ENGLISH

Introduction

Congratulations on your purchase and welcome to Philips!

To fully benefit from the support that Philips offers, register your product at www.philips.com/welcome.

General description

- 1 On/off button
- 2 Safety switch
- 3 Indicator lights
- 4 Motor unit
- 5 Release buttons
- 6 Blender bar with integrated blade unit
- 7 Upper part of charger
- 8 Adapter
- 9 Lower part of charger
- 10 Chopper blade unit
- 11 Serrated chopper blade unit for crushing ice
- 12 Chopper coupling unit
- 13 Chopper bowl
- 14 Beaker lid
- 15 Beaker

Important

Read this important information carefully before you use the appliance and save it for future reference.

Danger

- Never immerse the motor unit, the charger and the adapter in water or any other liquid, nor rinse them under the tap. Only use a moist cloth to clean the motor unit and the charger.

Warning

- Check if the voltage indicated on the adapter corresponds to the local mains voltage before you connect the appliance.
- Do not use the appliance if the adapter, the cord, the charger, the appliance itself or other parts are damaged or have visible cracks.
- If the adapter or charger is damaged, always replace it with one of the original type in order to avoid a hazard.
- The adapter contains a transformer. Do not cut off the adapter to replace it with another plug, as this causes a hazardous situation.
- This appliance is not intended for use by persons (including children) with reduced physical, sensory or mental capabilities, or lack of experience and knowledge, unless they have been given supervision or instruction concerning use of the appliance by a person responsible for their safety.
- Children should be supervised to ensure that they do not play with the appliance.
- Keep the appliance and its cord out of the reach of children.
- Do not touch the cutting edges of the blade units under any conditions, especially when the appliance is plugged in. The cutting edges are very sharp.
- Always switch off the appliance before you attach or detach accessories and before you clean it.
- If one of the blade units gets stuck, switch off the appliance before you remove the ingredients that block the blade unit.
- To avoid splashing, always immerse the blender bar in the ingredients before you switch on the appliance, especially when you process hot ingredients.
- Be careful when you pour hot liquid into the beaker; as hot liquid and steam may cause scalding.

Caution

- Only use the adapter and the charger supplied.
- Never use any accessories or parts from other manufacturers or that Philips does not specifically recommend. If you use such accessories or parts, your guarantee becomes invalid.
- Only use this appliance for its intended purpose as shown in the user manual.
- This appliance is intended for household use only.
- Do not exceed the quantities and processing times indicated in the table.
- Do not let the appliance operate with any of the accessories longer than 3 minutes without interruption. Let the appliance cool down for 15 minutes before you continue processing.
- Clean the blade unit of the blender bar under the tap.
Never immerse the blender bar in water.
- After cleaning, let the blender bar dry. Store it either horizontally or with the blade pointing upwards. Make sure the blade unit is completely dry before you store the blender bar.

Electromagnetic fields (EMF)

This Philips appliance complies with all applicable standards and regulations regarding exposure to electromagnetic fields.

Ordering accessories

To buy accessories or spare parts, visit www.shop.philips.com/service or go to your Philips dealer. You can also contact the Philips Consumer Care Centre in your country (see the worldwide guarantee leaflet for contact details). You can order a direct-driven mini chopper (under service code number 4203 035 83450) from your Philips dealer or a Philips service centre as an extra accessory.

Recycling

Do not throw away the appliance with the normal household waste at the end of its life, but hand it in at an official collection point for recycling. By doing this, you help to preserve the environment.

Guarantee and support

If you need information or support, please visit www.philips.com/support or read the separate worldwide guarantee leaflet.

Baby food recipe

Ingredients

- 50g cooked potatoes
- 50g cooked chicken
- 50g cooked french beans
- 100ml milk

1 Put all ingredients in the beaker.

2 Press and hold the on/off button and let the blender operate for 5 seconds.

INDONESIA

Pendahuluan

Selamat atas pembelian Anda dan selamat datang di Philips!

Untuk memanfaatkan sepenuhnya dukungan yang ditawarkan Philips, daftarkan produk Anda di www.philips.com/welcome.

Gambaran umum

- 1 Tombol on/off
- 2 Saklar pengaman
- 3 Lampu indikator
- 4 Unit motor
- 5 Tombol pelepas
- 6 Bilah blender dengan unit pisau terpadu
- 7 Bagian atas pengisi daya
- 8 Adaptor
- 9 Bagian bawah pengisi daya
- 10 Unit pisau perajang
- 11 Unit pisau perajang bergerigi untuk menghancurkan es
- 12 Unit sambungan perajang
- 13 Mangkuk pencacah
- 14 Penutup gelas
- 15 Gelas

Penting

Baca informasi penting ini dengan saksama sebelum menggunakan alat dan simpanlah untuk referensi di masa mendatang.

Bahaya

- Jangan merendam unit motor, pengisi daya, dan adaptor ke dalam air atau cairan lain apa pun, atau membilasnya di bawah air keran. Gunakan hanya kain lembap untuk membersihkan unit motor dan pengisi daya.

Peringatan

- Periksa apakah voltase pada adaptor sesuai dengan voltase listrik di rumah Anda, sebelum menghubungkan alat.
- Jangan gunakan alat jika adaptor, kabel, pengisi daya, alat itu sendiri atau komponen lainnya rusak atau terlihat adanya keretakan.
- Jika adaptor atau pengisi daya rusak, gantilah selalu dengan salah satu tipe asli agar terhindar dari bahaya.
- Adaptor berisi trafo. Jangan memotong adaptor untuk menggantinya dengan steker lain, karena bisa membahayakan.
- Alat ini tidak dimaksudkan untuk digunakan oleh orang (termasuk anak-anak) dengan cacat fisik, indera atau kecakapan mental yang kurang, atau kurang pengalaman dan pengetahuan, kecuali jika mereka diberikan pengawasan atau petunjuk mengenai penggunaan alat oleh orang yang bertanggung jawab bagi keselamatan mereka.
- Anak kecil harus diawasi untuk memastikan mereka tidak bermain-main dengan alat ini.
- Jauhkan alat dan kabelnya dari jangkauan anak-anak.
- Jangan pernah menyentuh tepi pemotong pada unit pisau, terutama saat alat sudah dihubungkan ke stopkontak listrik. Tepi pemotong ini sangat tajam.

- Selalu matikan alat sebelum memasang atau melepas aksesoris dan dan sebelum membersihkannya .
- Jika salah satu unit pisau macet, matikan alat sebelum mengeluarkan bahan yang menghambat unit pisau.
- Agar tidak terkena cipratan, selalu masukkan bilah blender ke dalam bahan sebelum menghidupkan alat, terutama saat Anda mengolah bahan yang panas.
- Berhati-hatilah saat menuangkan cairan panas ke gelas blender; karena cairan panas bisa menyebabkan kulit melepuh.

Perhatian

- Hanya gunakan adaptor dan pengisi daya yang disertakan.
- Jangan sekali-kali menggunakan aksesoris atau komponen apa pun dari produsen lain atau yang tidak secara khusus direkomendasikan oleh Philips. Jika Anda menggunakan aksesoris atau komponen tersebut, garansi Anda tidak berlaku.
- Hanya gunakan alat ini untuk keperluan yang dimaksud di petunjuk pengguna.
- Alat ini hanya untuk keperluan rumah tangga.
- Jangan melebihi takaran dan waktu pengolahan seperti yang ditunjukkan pada tabel.
- Jangan biarkan alat beroperasi dengan aksesoris apa pun lebih dari 3 menit tanpa berhenti. Biarkan alat mendingin selama 15 menit sebelum melanjutkan pengolahan.
- Bersihkan unit pisau bilah blender di bawah air keran. Jangan merendam bilah blender di dalam air.
- Setelah dibersihkan, biarkan bilah blender kering. Simpan pada posisi horizontal atau dengan pisau mengarah ke atas. Pastikan unit pisau sudah kering sepenuhnya sebelum menyimpan bilah blender.

Medan elektromagnet (EMF)

Alat Philips ini mematuhi semua standar dan peraturan yang berlaku terkait paparan terhadap medan elektromagnet.

Memesan aksesoris

Untuk membeli aksesoris atau suku cadang, kunjungi www.shop.philips.com/service atau pergi ke dealer Philips Anda. Anda juga dapat menghubungi Pusat Layanan Konsumen Philips di negara Anda (lihat pamflet garansi internasional untuk rincian kontak).

Anda dapat memesan perajang mini kendali-langsung (pada nomor kode servis 4203 035 83450) dari dealer Philips atau pusat layanan Philips sebagai aksesoris ekstra.

Mendaur ulang

Jangan membuang alat bersama limbah rumah tangga biasa jika alat sudah tidak dapat dipakai lagi, tetapi serahkan ke tempat pengumpulan barang bekas yang resmi untuk didaur ulang. Dengan melakukan hal ini, Anda ikut membantu melestarikan lingkungan.

Garansi dan dukungan

Jika Anda membutuhkan informasi atau dukungan, harap kunjungi www.philips.com/support atau bacalah pamflet garansi internasional.

Resep makanan bayi

Bahan-bahan

- 50g kentang matang
- 50g daging ayam matang
- 50g buncis matang
- 100ml susu

1 Masukkan semua bahan ke dalam gelas blender.

2 Tekan dan tahan tombol on/off dan biarkan blender beroperasi selama 5 detik.

한국어

소개

Philips 제품을 구입해 주셔서 감사합니다! 필립스가 드리는 지원 혜택을 받으실 수 있도록 www.philips.co.kr에서 제품을 등록하십시오.

제품정보

- 1 전원 버튼
- 2 안전 스위치
- 3 표시등
- 4 본체
- 5 열림 버튼
- 6 칼날부 통합형 블렌더 바
- 7 충전기 상단부
- 8 어댑터
- 9 충전기 하단부
- 10 다지기 칼날부
- 11 얼음 분쇄용 톱니모양의 다지기 칼날
- 12 다지기 결합부
- 13 다지기 용기
- 14 용기 뚜껑
- 15 용기

중요 사항

본 제품을 사용하기 전에 이 중요 정보를 주의 깊게 읽고 나중에 참조할 수 있도록 잘 보관하십시오.

주의

- 본체, 충전기 및 어댑터를 절대로 물 또는 다른 액체에 담그거나 행구지 마십시오. 본체 및 충전기는 젖은 천으로만 닦으십시오.

경고

- 전원을 연결하시기 전에 어댑터에 표시된 전압과 해당 지역의 전압이 일치하는지 확인하십시오.
- 어댑터, 코드, 충전기, 제품 자체 또는 기타 부품이 손상되었거나 금이 간 경우에는 제품을 사용하지 마십시오.
- 어댑터 또는 충전기가 손상된 경우 위험할 수 있으므로 반드시 정품으로 교체하여 사용하십시오.
- 어댑터에는 변압기가 내장되어 있습니다. 위험할 수 있으므로 어댑터를 잘라내고 다른 플러그로 교체하지 마십시오.
- 신체적인 감각 및 인지능력이 떨어지거나 경험과 지식이 풍부하지 않은 성인 및 어린이는 혼자 제품을 사용하지 말고 제품 사용과 관련하여 안전에 책임질 수 있도록 지시사항을 충분히 숙지한 사람의 도움을 받으십시오.
- 어린이가 제품을 가지고 놀지 못하도록 지도해 주십시오.
- 제품과 전원 코드는 어린이의 손이 닿지 않는 곳에 보관하십시오.
- 특히 제품에 전원이 연결되어 있을 때는 어떤 조건에서든 칼날부의 날카로운 부분을 만지지 않도록 주의하십시오. 칼날이 매우 날카롭습니다.
- 액세서리를 부착하거나 세척하기 전에는 항상 제품의 전원을 끄십시오.
- 만일 칼날부 중 하나가 움직이지 않으면 먼저 전원을 끈 다음 칼날부에 끼어 있는 음식을 꺼내십시오.
- 특히 뜨거운 재료를 다룰 때, 재료가 튀지 않도록 전원을 켜기 전에 항상 바를 재료 속에 넣으십시오.
- 뜨거운 액체 또는 증기로 인해 화상을 입을 수 있으므로 뜨거운 액체를 용기에 따를 때는 주의하십시오.

주의

- 반드시 제품과 함께 제공된 어댑터, 충전기만 사용하십시오.
- 다른 제조업체에서 만들었거나 필립스에서 권장하지 않은 제품 액세서리 또는 부품은 절대 사용하지 마십시오. 이러한 액세서리나 부품을 사용했을 경우에는 품질 보증이 무효화됩니다.
- 사용 설명서에 나온 본래 용도로만 제품을 사용하십시오.
- 본 제품은 가정용입니다.
- 표에 표시된 용량 및 작동 시간을 초과하지 마십시오.
- 제품에 액세서리를 장착한 채 연속으로 3분 이상 작동시키지 마십시오. 제품이 식을 때까지 15분 정도 기다렸다가 다시 사용하십시오.
- 바의 아래 부분을 흐르는 물에 세척하십시오. 세척 후, 바를 건조시키십시오.
- 바를 수평 또는 위 아래로 뒤집어 건조한 상태로 보관하십시오. 보관 시 내부에 물기가 남아 있지 않도록 하십시오.

EMF(전자기장)

이 제품은 EMF(전자기장)와 관련된 모든 기준 및 규정을 준수합니다.

액세서리 주문

액세서리나 교체 부품을 구입하려면 웹사이트 (www.shop.philips.com/service) 또는 필립스 대리점을 방문하십시오. 해당 지역의 필립스 고객 상담실에 문의하셔도 됩니다. 자세한 연락처는 제품 보증서를 참조하십시오. 소형 다지기(서비스 코드 번호 4203 035 83450)는 필립스 대리점 또는 필립스 서비스 센터에서 추가 액세서리로 구입할 수 있습니다.

재활용

수명이 다 된 제품은 일반 가정용 쓰레기와 함께 버리지 마시고 지정된 재활용 수거 장소에 버리십시오. 이런 방법으로 환경 보호에 동참하실 수 있습니다.

보증 및 지원

보다 자세한 정보나 지원이 필요한 경우에는 필립스 웹사이트 (www.philips.com/support)를 방문하시거나 제품 보증서를 참조하십시오.

이유식 레시피

재료

- 삶은 감자 50g
- 삶은 닭고기 50g
- 삶은 강낭콩 50g
- 우유 100ml

1 용기에 모든 재료를 넣습니다.

2 전원 버튼을 길게 누르고 핸드블렌더를 5초 동안 작동시킵니다.

ข้อมูลเบื้องต้น

ขอแสดงความยินดีที่คุณสั่งซื้อและยินดีต้อนรับสู่ผลิตภัณฑ์ของ Philips! เพื่อให้คุณได้รับประโยชน์อย่างเต็มที่จากบริการที่ Philips มอบให้ โปรดลงทะเบียนผลิตภัณฑ์ของคุณที่ www.philips.com/welcome

ส่วนประกอบ

- ปุ่มเปิด/ปิด
- ระบบรักษาความปลอดภัย
- ไฟแสดงสถานะ
- แท่นมอเตอร์
- ปุ่มปลดล็อก
- ด้ามเครื่องปั่นพร้อมชุดใบมีดในตัว
- ส่วนบนของแท่นชาร์จ
- อะแดปเตอร์
- ส่วนล่างของแท่นชาร์จ
- ชุดใบมีดโกลี
- ชุดใบมีดโกลีสำหรับปั่นน้ำแข็ง
- ชุดสำหรับบดสับ
- โกลี
- ฝาปิดโกลี
- โกลีปั่น

ข้อสำคัญ

โปรดอ่านข้อมูลที่สำคัญอย่างละเอียดก่อนใช้งานเครื่องและเก็บคู่มือไว้เพื่อใช้อ้างอิงในภายหลัง

อันตราย

- ห้ามจุ่มแท่นมอเตอร์ แท่นชาร์จ และอะแดปเตอร์ลงในน้ำหรือของเหลวใดๆ หรือนำไปล้างใต้ก๊อกน้ำ ใช้ผ้าเช็ดทำความสะอาดแท่นมอเตอร์และแท่นชาร์จเท่านั้น

คำเตือน

- ก่อนใช้งานโปรดตรวจสอบแรงดันไฟที่ระบุบนอะแดปเตอร์ว่าตรงกับแรงดันไฟที่ใช้ภายในบ้านหรือไม่
- ห้ามใช้เครื่อง หากอะแดปเตอร์ สายไฟ แท่นชาร์จ ตัวเครื่อง หรือชิ้นส่วนอื่นๆ ชำรุดเสียหายหรือมีรอยแตกที่เห็นได้ชัดเจน
- ในกรณีทีอะแดปเตอร์หรือแท่นชาร์จเบตเตอร์ชำรุดเสียหาย จะต้องเปลี่ยนแทนด้วยอุปกรณ์ชนิดเดิม เพื่อป้องกันการเกิดอันตราย
- ภายในอะแดปเตอร์ประกอบด้วยตัวแปลงไฟ ดังนั้นจึงไม่ควรนำไปตัดออกแล้วเปลี่ยนหัวปลั๊กใหม่ เพราะจะก่อให้เกิดอันตรายร้ายแรงขึ้น
- ไม่ควรให้บุคคล (รวมทั้งเด็กเล็ก) ที่มีสภาพร่างกายไม่สมบูรณ์ ประสาทสัมผัสไม่สมบูรณ์หรือสภาพจิตใจไม่ปกติ หรือขาดประสบการณ์และความรู้ความเข้าใจ นำเครื่องนี้ไปใช้งาน เว้นแต่จะอยู่ในการควบคุมดูแลหรือได้รับคำแนะนำในการใช้งานโดยผู้ที่รับผิดชอบในด้านความปลอดภัย
- เด็กเล็กควรได้รับการดูแลเพื่อป้องกันไม่ให้เด็กนำเครื่องนี้ไปเล่น
- เก็บเครื่องและสายไฟให้พ้นมือเด็ก
- ห้ามสัมผัสขั้วขั้วของชุดใบมีด ในทุกกรณี โดยเฉพาะเมื่อเครื่องเสียบปลั๊กไฟอยู่ เพราะใบมีดคมมาก
- ปิดเครื่องทุกครั้งก่อนที่คุณจะติดตั้งหรือถอดอุปกรณ์เสริมและก่อนที่จะทำความสะอาด
- หากหนึ่งในชุดใบมีดเกิดติดขัด ให้ปิดเครื่องก่อนแล้วจึงเช็ยส่วนผลมที่ติดใบมีดออกเพื่อหลีกเลี่ยงการกระเด็น ให้จุ่มด้ามเครื่องปั่นเข้าไปในส่วนผลมก่อนที่คุณจะเปิดเครื่องเสมอ โดยเฉพาะเมื่อคุณปั่นส่วนผลมที่ร้อน
- โปรดใช้ความระมัดระวังเมื่อเทของเหลวที่ร้อนลงในโกลีปั่น เนื่องจากของเหลวที่ร้อนและไอน้ำร้อนอาจลวกผิวหนังได้

ข้อควรระวัง

- ใช้อะแดปเตอร์และแท่นชาร์จเฉพาะที่แนะนำให้เท่านั้น
- ห้ามใช้อุปกรณ์เสริม หรือชิ้นส่วนที่ผลิตโดยผู้ผลิตรายอื่น หรือบริษัทที่ Philips ไม่ได้แนะนำ การรับประกันจะเป็นโมฆะทันที หากคุณใช้อุปกรณ์เสริม หรือชิ้นส่วนดังกล่าว
- ให้ใช้เครื่องนี้ตามวัตถุประสงค์การใช้งานที่แสดงในคู่มือผู้ใช้เท่านั้น
- เครื่องใช้ไฟฟ้านี้เหมาะสำหรับการใช้งานในครัวเรือนเท่านั้น
- ห้ามปั่นส่วนผลมในปริมาณที่มากกว่าที่กำหนดและใช้เวลานานกว่าที่ระบุไว้ในตาราง
- ห้ามปล่อยให้เครื่องทำงานเชื่อมต่อกับอุปกรณ์เสริมติดต่อกันนานกว่า 3 นาทีโดยไม่ได้หยุดพัก ปล่อยให้เครื่องเย็นลง 15 นาทีก่อนที่จะใช้ทำงานเครื่องต่อ
- ทำความสะอาดชุดใบมีดของด้ามเครื่องปั่นได้ก็อกน้ำ ห้ามจุ่มด้ามเครื่องปั่นลงในน้ำ
- หลังจากทำความสะอาดแล้ว ปล่อยให้ด้ามเครื่องปั่นแห้ง จัดเก็บเครื่องในแนวนอนหรือในแนวที่ใบมีดตั้งขึ้น ตรวจสอบให้แน่ใจว่าชุดใบมีดแห้งดีแล้ว ก่อนที่จะจัดเก็บด้ามเครื่องปั่น

Electromagnetic fields (EMF)

ผลิตภัณฑ์ของ Philips นี้เป็นไปตามมาตรฐานและกฎข้อบังคับด้านคลื่นแม่เหล็กไฟฟ้าที่มีทุกประการ

การสั่งซื้ออุปกรณ์เสริม

หากต้องการซื้ออุปกรณ์เสริมหรืออะไหล่ โปรดเยี่ยมชม www.shop.philips.com/service หรือไปที่ตัวแทนจำหน่าย Philips คุณสามารถติดต่อศูนย์บริการลูกค้า Philips ในประเทศของคุณ (ดูรายละเอียดการติดต่อจากเอกสารแผ่นพับเกี่ยวกับการรับประกันทั่วโลก) คุณสามารถสั่งซื้อที่บดสับขนาดเล็กแบบ Direct-driven (โดยใช้หมายเลขบริการ 4203 035 83450) จากตัวแทนจำหน่ายของ Philips หรือศูนย์บริการของ Philips เพื่อใช้เป็นอุปกรณ์เสริม

การรีไซเคิล

ห้ามทิ้งเครื่องร่วมกับขยะในครัวเรือนทั่วไป เมื่อเครื่องหมดอายุการใช้งานแล้ว ควรทิ้งลงในถังขยะสำหรับนำกลับไปใช้ใหม่ได้ (รีไซเคิล) เพื่อช่วยรักษาสิ่งแวดล้อมที่ดีที่สุด

การรับประกันและสนับสนุน

หากคุณต้องการข้อมูลหรือการสนับสนุน โปรดเข้าชมเว็บไซต์ www.philips.com/support หรืออ่านข้อมูลจากเอกสารแผ่นพับที่แยกเฉพาะเกี่ยวกับการรับประกันทั่วโลก

สูตรอาหารเด็ก

ส่วนผสม

- มันฝรั่งปรุงสุก 50 กรัม
- โกลีปรุงสุก 50 กรัม
- ถั่วแขกปรุงสุก 50 กรัม
- นม 100 มล.

1. ใส่ส่วนผสมทั้งหมดในโกลีปั่น

2. กดปุ่มเปิด/ปิดค้างไว้ และปล่อยให้เครื่องปั่นทำงานเป็นเวลา 5 วินาที

TIẾNG VIỆT

Giới thiệu

Chúc mừng bạn đã mua được sản phẩm Philips mới và chào mừng bạn đến với Philips! Để có được lợi ích đầy đủ từ sự hỗ trợ do Philips cung cấp, hãy đăng ký sản phẩm tại www.philips.com/welcome.

Mô tả chung

- 1 Nút on/off (bật/tắt)
- 2 Công tắc an toàn
- 3 Đèn chỉ báo
- 4 Bộ phận động cơ
- 5 Nút tháo
- 6 Thanh máy trộn với bộ lưới cắt tích hợp
- 7 Phần trên của bộ sạc
- 8 Bộ điều hợp
- 9 Phần đế của bộ sạc
- 10 Dao xay thịt
- 11 Bộ lưới cắt răng cưa dùng để nghiền đá
- 12 Bộ ghép nối máy xay thịt
- 13 Tô máy xay thịt
- 14 Nắp cốc
- 15 Cốc

Quan trọng

Hãy đọc kỹ thông tin quan trọng này trước khi bạn sử dụng thiết bị và hãy cất giữ nó để tiện tham khảo sau này.

Nguy hiểm

- Không nhúng bộ phận động cơ, bộ sạc và bộ điều hợp vào trong nước hoặc chất lỏng khác, hay rửa chúng dưới vòi nước. Chỉ dùng một miếng vải ẩm để lau bộ phận động cơ và bộ sạc.

Cảnh báo

- Trước khi nối máy với nguồn điện, kiểm tra xem điện áp ghi trên bộ điều hợp có phù hợp với điện áp của nguồn điện không.
- Không nên sử dụng thiết bị nếu bộ điều hợp, dây điện, bộ sạc, chính thiết bị hoặc những bộ phận khác bị hỏng hay có vết nứt thấy rõ.
- Nếu bộ điều hợp hoặc bộ sạc bị hỏng, hãy luôn thay bộ điều hợp hoặc bộ sạc cùng loại gốc để tránh nguy hiểm.
- Trong bộ điều hợp có một biển áp. Không cắt bỏ bộ điều hợp này để thay bằng bộ điều hợp khác, vì làm như vậy sẽ gây ra tình huống nguy hiểm.
- Thiết bị này không dành cho người dùng (bao gồm cả trẻ em) bị suy giảm năng lực về thể chất, giác quan hoặc tâm thần, hay người thiếu kinh nghiệm và kiên nhẫn, trừ khi họ được giám sát hoặc hướng dẫn sử dụng thiết bị bởi người có trách nhiệm đảm bảo an toàn cho họ.
- Trẻ em phải được giám sát để đảm bảo rằng chúng không chơi đùa với thiết bị này.
- Để thiết bị và dây điện ngoài tầm với của trẻ em.
- Dưới bất cứ tình huống nào, bạn cũng không nên chạm vào các cạnh cắt của bộ lưới cắt, đặc biệt khi thiết bị đang được cắm điện. Các cạnh cắt rất sắc.
- Luôn tắt máy trước khi bạn lắp hoặc tháo phụ kiện và trước khi vệ sinh máy.

- Nếu bộ lưới cắt bị kẹt, hãy tắt máy trước khi lấy nguyên liệu làm kẹt bộ lưới cắt ra.
- Để tránh bị bắn tung tóe, luôn nhúng thanh máy trộn vào nguyên liệu trước khi bật thiết bị, đặc biệt khi bạn chế biến nguyên liệu nóng.
- Hãy cẩn thận khi đổ chất lỏng nóng vào cốc, vì chất lỏng nóng và hơi nước có thể gây bỏng.

Chú ý

- Chỉ sử dụng thiết bị nối tiếp và bộ sạc đi kèm.
- Không sử dụng bất kỳ phụ kiện hoặc bộ phận nào mà Philips không đặc biệt khuyến dùng. Nếu bạn sử dụng các phụ kiện hoặc bộ phận không phải của Philips, việc bảo hành sẽ bị mất hiệu lực.
- Chỉ sử dụng thiết bị này cho mục đích sử dụng đã định như mô tả trong hướng dẫn sử dụng.
- Thiết bị này được thiết kế chỉ để dùng trong gia đình.
- Không nên vượt quá số lượng và thời gian chế biến được nêu trong bảng.
- Không nên để thiết bị hoạt động với bất kỳ phụ kiện nào liên tục quá 3 phút. Hãy để thiết bị nguội xuống khoảng 15 phút trước khi tiếp tục chế biến.
- Rửa sạch bộ lưới cắt của thanh máy trộn dưới vòi nước. Không nên nhúng vào nước.
- Sau khi rửa xong, để thanh máy trộn ráo nước. Khi bảo quản, hãy đặt thanh máy trộn nằm ngang hoặc để lưới cắt hướng lên trên. Đảm bảo bộ lưới cắt hoàn toàn khô ráo trước khi bạn cất giữ thanh máy trộn.

Điện từ trường (EMF)

Thiết bị Philips này tuân thủ tất cả các tiêu chuẩn và quy định hiện hành liên quan đến mức phơi nhiễm điện từ trường.

Đặt mua phụ kiện

Để mua phụ kiện hoặc phụ tùng của bạn, hãy truy cập www.shop.philips.com/service hoặc liên hệ đại lý Philips tại địa phương bạn. Bạn cũng có thể liên hệ Trung tâm Chăm sóc Khách hàng của Philips tại quốc gia bạn (xem tờ rơi về chế độ bảo hành trên toàn thế giới để biết thông tin liên hệ). Bạn có thể đặt mua máy xay thịt mini truyền động trực tiếp (theo mã số dịch vụ 4203 035 83450) từ đại lý Philips hoặc trung tâm dịch vụ của Philips để làm phụ kiện bổ sung.

Tái chế

Không vứt thiết bị cùng với chất thải gia đình thông thường khi chấm dứt sử dụng thiết bị. Hãy đem thiết bị đến điểm thu gom chính thức để tái chế. Làm như vậy, bạn sẽ giúp bảo vệ môi trường.

Bảo hành và hỗ trợ

Nếu bạn cần hỗ trợ hay để biết thông tin, vui lòng truy cập www.philips.com/support hoặc đọc tờ bảo hành toàn cầu riêng lẻ.

Công thức chế biến thức ăn cho bé

Nguyên liệu

- 50g khoai tây đã nấu
- 50g thịt gà đã nấu
- 50g đậu cô ve đã nấu
- 100 ml sữa

1 Cho tất cả nguyên liệu vào cốc.

2 Nhấn và giữ nút on/off (bật/tắt) và để máy xay hoạt động trong 5 giây.

繁體中文

簡介

恭喜您購買本產品並歡迎加入飛利浦！請於 www.philips.com/welcome 註冊您的產品，以善用飛利浦提供的支援。

一般說明

- 1 開關按鈕
- 2 安全開關
- 3 指示燈
- 4 馬達座
- 5 配件釋放鈕
- 6 配備整合式刀片座的攪拌器
- 7 充電器上部
- 8 轉換器
- 9 充電器下部
- 10 切碎機刀組
- 11 碎冰用的鋸齒狀切碎機刀組
- 12 切碎機組合座
- 13 刨碎器攪拌槽
- 14 容器蓋
- 15 容器

重要事項

使用本產品前，請先仔細閱讀此重要資訊，並保留說明以供日後參考。

危險

- 請勿將馬達座、充電器和轉換器浸入水中或其他液體中，也請勿置於水龍頭下沖洗。只能使用微濕的布來清潔馬達座和充電器。

警告

- 在您連接電源之前，請先檢查轉換器上所標示的電壓是否與您當地的電源系統電壓一致。
- 若轉換器、電線、充電器、產品本身或其他零件受損或有明顯刮痕，則請勿繼續使用此產品。
- 如果轉換器或充電器損壞，請務必依原型號進行更換，以免發生危險。
- 電源轉換器內含一個變壓器。請勿切斷電源轉換器而以其他的插頭取代，否則會造成危險。
- 本產品不適合供下列人士（包括兒童）使用：身體官能或心智能力退化者，或是經驗與使用知識缺乏者。他們需要負責其安全的人員在旁監督，或指示產品的使用方法，方可使用。
- 請勿讓孩童使用本產品或將本產品當成玩具。
- 請勿讓兒童接觸產品與電線。
- 在任何情況下，都請勿碰刀片座的刀鋒，尤其裝置接通電源時切勿觸碰。刀鋒相當鋒利。
- 在裝上或拆下配件，以及進行清潔之前，請務必先關閉產品電源。
- 如果任何刀片座卡住，請先關閉產品電源，再將卡住刀片座的食材取出。
- 為避免飛濺，在您開啟產品電源之前，請務必將攪拌器浸入食材中，尤其是處理滾燙食材時。
- 將高溫液體倒入量杯時請小心，因為高溫液體和蒸氣可能會造成燙傷。

警告

- 僅可使用充電器隨附的電源轉換器。
- 請勿使用其他製造商的任何配件或零件，或非飛利浦建議之配件或零件。如果您使用此類配件或零件，保固即會失效。
- 請僅將本產品用於本使用手冊所述之相關用途。
- 本產品僅供家用。
- 請勿超過表格中註明的食材用量與處理時間。
- 無論本產品是搭配哪一種配件，都請勿連續運作超過 3 分鐘。請先讓本產品降溫 15 分鐘，然後再繼續處理食材。
- 請將攪拌器刀片座放在水龍頭下沖洗。但請勿將攪拌器浸泡在水中。
- 清洗後，請將攪拌器晾乾。以水平方式或刀片朝上的方式加以收納。收納攪拌器前，請確定刀片座已完全乾燥。

電磁波 (EMF)

本飛利浦產品符合所有電磁波暴露的相關適用標準和法規。

訂購配件

若要購買配件或備用零件，請造訪 www.shop.philips.com/service，或洽詢您的飛利浦經銷商。您也可以聯絡您所在國家/地區的飛利浦客戶服務中心（聯絡詳細資料請參閱全球保證書）。您可以透過飛利浦經銷商或服務中心訂購直接傳動迷你刨碎器（服務代碼型號為 4203 035 83450）作為額外配件。**回收** 本產品使用壽命結束時，請勿與一般家庭廢棄物一併丟棄。請將本產品送至政府指定的回收站，此舉能為環保盡一份心力。

保固與支援

如果您需要資訊或支援，請造訪：www.philips.com/support，或另行參閱全球保證書。

嬰兒食品食譜

食材

- 50 公克的煮熟馬鈴薯
- 50 公克的煮熟雞肉
- 50 公克的煮熟四季豆
- 100 毫升的牛奶

1 將所有食材放入容器中。

2 按住開關按鈕，讓攪拌器運轉 5 秒鐘。

简介

感谢您的惠顾，欢迎光临飞利浦！为了您能充分享受飞利浦提供的支持，请在 www.philips.com/welcome 上注册您的产品。

基本说明

- 1 开/关按钮
- 2 安全开关
- 3 指示灯
- 4 马达组件
- 5 释放按钮
- 6 带集成式刀片组件的搅拌棒
- 7 充电器的上半部分
- 8 适配器
- 9 充电器的下半部分
- 10 切碎器刀片组件
- 11 切碎器锯齿形刀片组件，用于切碎冰块
- 12 粉碎器耦合装置
- 13 切碎器加工杯
- 14 杯盖
- 15 搅拌杯

注意事项

使用产品之前，请仔细阅读本重要信息，并妥善保管以供日后参考。

危险

- 切勿将马达装置、充电器和适配器浸入水或任何其它液体中，也不要将它们放在水龙头下冲洗。只能用湿布清洁马达组件和充电器。

警告

- 在将本产品连接电源前，务必检查当地的电压是否与电源适配器所标电压一致。
- 如果适配器、电源线、充电器、产品本身或其他部件受损或有明显破裂，则不要使用产品。
- 如果适配器或充电器已损坏，则务必用原装型号进行更换，以免发生危险。
- 电源适配器内有一个变压器。切勿自行打开更换以免发生危险。
- 产品不建议由有肢体、感官或精神能力缺陷或缺乏使用经验和知识的人（包括儿童）使用，除非有负责他们安全的人对他们进行与产品使用有关的监督或指导。
- 请照顾好儿童，本产品不能用于玩耍。
- 将产品及其线缆放在儿童接触不到的地方。
- 任何情况下，切勿接触刀片组件的刀刃，尤其是在产品接通电源时。刀刃非常锋利。
- 在连接或拆开附件及进行清洁之前，请务必先关闭产品。
- 如果其中一个刀片组件被卡住，请务必先关闭产品，再清除堵塞刀片组件的原料。
- 为避免飞溅，请务必先将搅拌棒浸入原料中，再打开产品，尤其是加工热原料时。
- 将高温液体倒入搅拌杯时请小心，因为高温液体和蒸汽可能会导致烫伤。

警告

- 只能使用随附的电源适配器和充电器。
- 切勿使用其它制造商生产的或未经飞利浦特别推荐的附件或部件。如果您使用了此类附件或部件，则本产品的保修将会失效。
- 只能将本产品用于用户手册中所示的原定用途。
- 本产品仅限于家用。
- 不要超出表中所示的份量和加工时间。
- 请勿让装有任一附件的产品持续运行超过 3 分钟。让产品冷却 15 分钟后再进行加工。
- 在水龙头下清洗搅拌棒的刀片组件。切勿将搅拌棒浸入水中。
- 清洁后，将搅拌棒晾干。请将其水平存放或将刀片向上存放。在存储搅拌棒之前，确保刀片组件已彻底干燥。

电磁场 (EMF)

本飞利浦产品符合所有有关暴露于电磁场的适用标准和法规。

订购附件

要购买附件和备件，请访问 www.shop.philips.com/service 或请联系飞利浦经销商。您也可以联系您所在国家/地区的飞利浦客户服务中心（联系详情，请参阅全球保修卡）。您可以从飞利浦经销商或飞利浦服务中心订购直接传动式迷你切碎器（服务码为 4203 035 83450），将其用作额外附件。

回收

弃置产品时，请不要将其与一般生活垃圾扔在一起，应将其交给指定的回收中心，这样做有利于环保。

保修和支持

如需信息或支持，请访问 www.philips.com/support 或阅读单独的全球保修卡。

婴儿食物食谱

原料

- 50 克煮熟的土豆
- 50 克熟鸡肉
- 50 克煮熟的法国豆
- 100 毫升牛奶

1 将所有原料放入搅拌杯。

2 按住开/关按钮，让搅拌机运转 5 秒钟。