



RACK MOUNTING MANUAL BYPASS

BM-R 3, 6 and 10 kVA

General index.

1. INTRODUCTION.

- 1.1. THANK YOU LETTER.

2. SAFETY INFORMATION.

- 2.1. USING THIS MANUAL.
 - 2.1.1. Conventions and symbols used.
- 2.2. ADDITIONAL SAFETY PRECAUTIONS.

3. QUALITY ASSURANCE AND STANDARDS.

- 3.1. STATEMENT BY THE MANAGEMENT.
- 3.2. STANDARDS.
- 3.3. ENVIRONMENT.

4. OVERVIEW.

- 4.1. VIEWS.
 - 4.1.1. Equipment front views.
 - 4.1.2. Corresponding legend of the equipment's views.
- 4.2. PRODUCT DEFINITION.
 - 4.2.1. Nomenclature.

5. DESCRIPTION.

6. INSTALLATION.

- 6.1. RECEPTION OF THE EQUIPMENT.
 - 6.1.1. Reception, unpacking and contents.
- 6.2. LOCATION AND CONSIDERATIONS.
 - 6.2.1.1. Location.
- 6.3. WIRING.

7. OPERATING.

- 7.1. START UP.
- 7.2. TRANSFERENCE FROM «NORMAL» OR «UPS» MODE TO «BYPASS».
 - 7.2.1. 3 kVA manual bypass models, from «NORMAL» to «BYPASS» mode.
 - 7.2.2. 6 and 10 kVA manual bypass models, from «UPS» to «BYPASS» mode.
- 7.3. TRANSFERENCE FROM «BYPASS» TO «NORMAL» OR «UPS» MODE.
 - 7.3.1. 3 kVA manual bypass models, from «BYPASS» to «NORMAL» mode.
 - 7.3.2. 6 and 10 kVA manual bypass models, from «BYPASS» to «UPS» mode.

8. MAINTENANCE, WARRANTY AND SERVICE.

- 8.1. MAINTENANCE.
- 8.2. WARRANTY CONDITIONS.

- 8.2.1. Warranty terms.
- 8.2.2. Out of scope of supply.
- 8.3. TECHNICAL SERVICE NETWORK.

9. ANNEXES.

- 9.1. TECHNICAL SPECIFICATIONS.

1. INTRODUCTION.

1.1. THANK YOU LETTER.

We thank you in advance for the trust placed in us in the purchasing of this product. Read this instruction manual carefully in order to familiarize yourself with its content, since the more you know and understand the equipment the greater your satisfaction, level of safety and optimization of its functionalities will be.

We remain at your disposal for any additional information or queries that you may wish to make.

Yours sincerely.

SALICRU

- The equipment described herein **is capable of causing significant physical damage in the event of improper handling**. For this reason its installation, maintenance and/or repair must be carried out exclusively by our personnel or by **qualified personnel**.
- Although no effort has been spared to ensure that the information in this user manual is complete and accurate, we are not responsible for any errors or omissions that may exist.
The images included in this document are for illustrative purposes and may not represent exactly the parts of the equipment shown, therefore they are not contractual. However, any divergence that may arise will be remedied or solved with the correct labelling on the unit.
- Following our policy of constant evolution, **we reserve the right to modify the characteristics, operations or actions described in this document without prior notice**.
- **Reproduction, copying, assignment to third parties, modification or total or partial translation** of this manual or document, in any form or by any means, **without previous written authorization by our firm is prohibited**, with the full and exclusive property rights over the same being reserved by our firm.

2. SAFETY INFORMATION.

2.1. USING THIS MANUAL.

The documentation of any standard equipment is available to the customer on our website for download (www.salicru.com).

- For devices "powered by socket", this is the website for obtaining the user manual and "**Safety Instructions**" EK266*08.
- For devices with "permanent connection" via terminals, a CD-ROM or pen drive containing all necessary information for connection and start-up, including "**Safety Instructions**" EK266*08, may be supplied with it.

Before carrying out any action on the device relating to its installation or start-up, change of location, configuration or handling of any kind, carefully read the safety instructions.

The purpose of the user manual is to provide information regarding safety and explanations of the procedures for installation and operation of the equipment. Read them carefully and follow the steps indicated in the order established.



Compliance with the "Safety Instructions" is mandatory and the user is legally responsible for compliance and enforcement.

The equipment is delivered properly labelled for the correct identification of each of the parts, which together with the instructions described in this user manual allows the operations of installation and commissioning to be performed in a simple and orderly manner without having any doubts whatsoever.

Finally, once the equipment is installed and operating, it is recommended to save the documentation downloaded from the website, CD-ROM or Pen Drive in a safe and easy-to-access place, for any future queries or doubts that may arise.

The following terms are used interchangeably in the document to refer to:

- **«Manual bypass, Bypass, equipment or unit»**.- Rack mounting manual bypass.
- **«T.S.S.»**.- Technical Service and Support.
- **«Client, installer, operator or user»**.- These are used interchangeably and by extension to refer to the installer and/or operator who will carry out the corresponding actions, and the same person may be responsible for carrying out the respective actions when acting on behalf of, or in representation of, same.

2.1.1. Conventions and symbols used.

Some symbols may be used and appear on the equipment, batteries and/or in the context of the user manual.

For more information, see section 1.1.1 of document EK266*08 on **«Safety instructions»**.

2.2. ADDITIONAL SAFETY PRECAUTIONS.

- In the point of view of installation and electrical safety, the rack mounting manual bypass must be considered as a transformer or distribution line.
- As this is an equipment with protection against electrical shocks class I, it is essential to supply or install the main protection earth cable (⚡), through either the AC wall outlet or corresponding terminal.
-  Those models with terminals, they have to be installed **by both qualified personnel and personnel with particular training** which can make the shifting manoeuvring with the help of this document.
- The instructions that being read are relating to the own manual bypass only. Any other action related to this document, which involves any manoeuvring over any other equipment like a UPS or stabilizer, it will be done as its user's manual states.
- The neutral regime from input to output is identical for the bypass panels "with no galvanic isolation". The neutral regime must always be the same for the manual bypass as well as the UPS or stabilizer.

3. QUALITY ASSURANCE AND STANDARDS.

3.1. STATEMENT BY THE MANAGEMENT.

Our goal is customer satisfaction, therefore this Management has decided to establish a Quality and Environment Policy, through the implementation of a Quality and Environmental Management System that will enable us to comply with the requirements demanded in the **ISO 9001** and **ISO 14001** and also by our Customers and Stakeholders.

Likewise, the management of the company is committed to the development and improvement of the Quality and Environmental Management System, through:

- Communication to the entire company of the importance of satisfying both the client's requirements as well as legal and regulatory requirements.
- The dissemination of the Quality and Environment Policy and the setting of the Quality and Environment objectives.
- Conducting reviews by the Management.
- Providing the necessary resources.

3.2. STANDARDS.

The **Manual Bypass** product is designed, manufactured and commercialized in accordance with the standard **EN ISO 9001** of Quality Management Systems and certified by SGS body. The **CE** marking shows the conformity to the EEC Directive by means of the application of the following standards:

- **2014/35/EU**. - Low Voltage Directive (LVD).
- **2011/65/EU**. - Restriction of Hazardous Substances in electrical and electronic equipment (RoHS).



The manufacturer's responsibility is excluded in the event of any modification or intervention in the product by the customer's side.



Declaration of conformity CE of the product is at the client disposal under previous request to our headquarters offices.

3.3. ENVIRONMENT.

This product has been designed to respect the environment and manufactured according to **ISO 14001**.

Recycling of the equipment at the end of its useful life:

Our company undertakes to use the services of authorized and regulatory companies to treat the set of products recovered at the end of their useful life (contact your distributor).

Packaging:

For the recycling of the packaging there must be compliance with the legal requirements in force, according to the specific regulations of the country where the equipment is installed.

4. OVERVIEW.

4.1. VIEWS.

4.1.1. Equipment front views.

Fig. 1 and 2 show the corresponding illustrations of the rack mounting manual bypass, ready to be installed in 19" rack cabinets, although the 3 kVA model allows wall mounting installation too see section 6 installation.

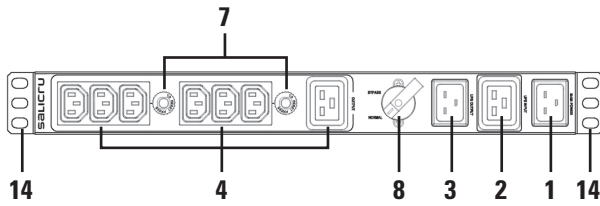
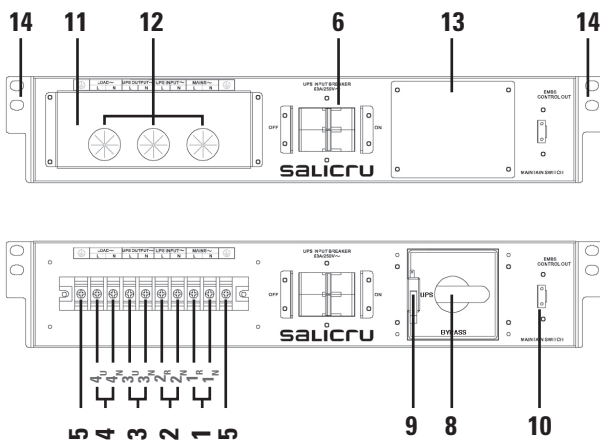

Fig. 1. Front view of the 3kVA rack mounting manual bypass.



! Respect the phase and neutral rotation, **otherwise there will be a short-circuit** when the manual bypass switch will be switched.

Fig. 2. Front view of the 6 and 10kVA rack mounting manual bypass.

4.1.2. Corresponding legend of the equipment's views.

- 1 AC power supply IEC connector or input terminals.
- 2 To be connected to the UPS or stabilizer input.
- 3 To be connected to the UPS or stabilizer output.
- 4 IEC connectors or output terminals to loads.
- 5 Main protective earth (6 and 10 kVA models only).
- 6 Input circuit breaker switch (6 and 10 kVA models only).
- 7 Output thermal switches (2 sections in the 3 kVA model).
- 8 Manual bypass switch (Normal or Bypass positions).
- 9 Manual bypass signal auxiliary contact for signalling.
- 10 Terminal strip to connect with the EBMS signal of the UPS.
- 11 Protection cover for terminal power strip.
- 12 Cable gland for connection cables.

13 Manual bypass switch cover.

14 Angle support and screws to adapt the device to 19" rack format.

4.2. PRODUCT DEFINITION.

4.2.1. Nomenclature.

BM-TWIN PRO-RT-6 2/2

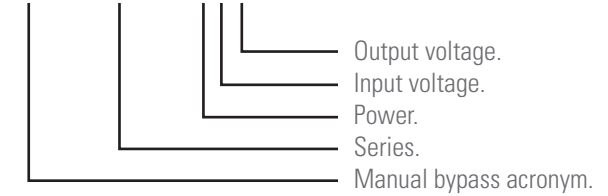

5. DESCRIPTION.

- The manual bypass is an option which allows feeding the load or loads either from an equipment - UPS or stabilizer-, or from commercial mains directly without breaking the power supply during its switching manoeuvring, because it is make before break type, unless it is used in a wrong way without respecting the stated procedure in section 7.
- In correlation with Fig. 1 and 2, Fig 3 and 4 illustrations show the single line diagrams of both structures. The structure is identical in both figures, although there are some differences between models. The most important one is the auxiliary contact from the manual bypass switch, which comes from a microswitch located in the back side of the protection cover and connected to a signal connector internally. By means of the electrical connection with the supplied cable between this connector and the one available in several equipments like the UPS from TWIN PRO2 and/or RT2 series, when the protecting cover from manual bypass is removed, the UPS shifts from «Inverter output mode» to «Static bypass mode», considering that the system was on normal mode operating previously. Therefore, it makes easier the operating and avoids possible wrong manoeuvring that it could cause serious damages to the installation set, loads included.

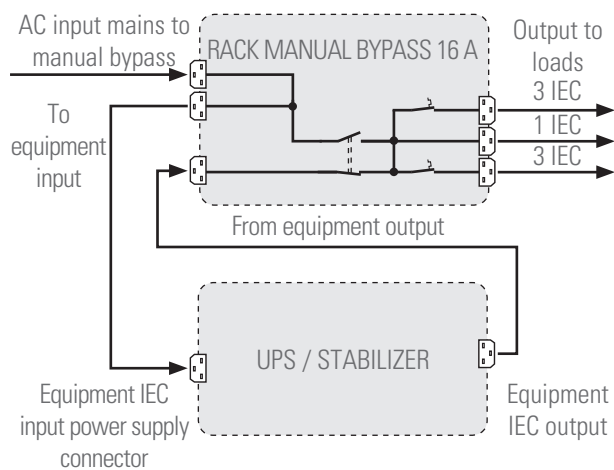

Fig. 3. Wiring between the UPS and the 3 kVA bypass.

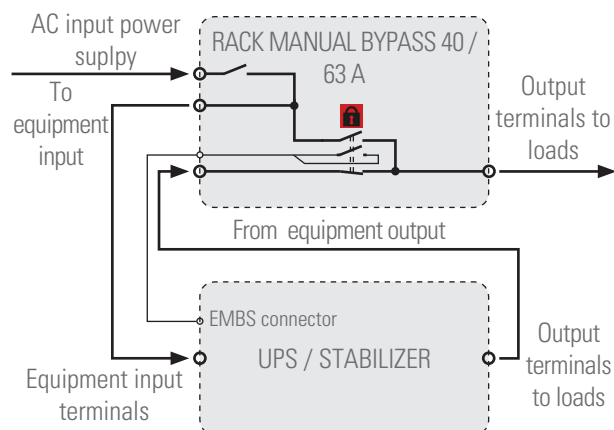



Fig. 4. Wiring between UPS and 6 and 10 kVA bypass.

6. INSTALLATION.

-  Read and respect the Safety instructions, described in section 2 of this document. The fact of omitting any of the stated indications can cause serious or very serious accidents to the surrounding, as well as failures in the equipment and/or loads connected to it.

6.1. RECEPTION OF THE EQUIPMENT.

6.1.1. Reception, unpacking and contents.

- Reception. Check that:
 - Data of the label stucked on the packaging corresponds to the ones stated in the order. And once it is unpacked, check the previous data with the ones in the nameplate of the own manual bypass unit.
In case of any discrepancies, make the nonconformity, quoting the references in the delivery note.
 - It has not been damaged during transport.
- Contents.
 - Rack mounting equipment.
 - Wiring link with connector and AC inlet (3 kVA model).
 - Bypass signal cable to be connected with TWIN PRO2 or RT2 UPSs (6 and 10 kVA models).
 - Angles supports for 19" rack mounting and their screws.
 - User's manual in hardcopy and warranty.
- Once the reception is finished, if it is not going to be installed in the next days, it is recommended to keep the equipment back in its original packaging as a preventive measure.
- As regards to the packaging, when it is going to be disposed, do it in accordance with the regulations in force. It is advised to keep it for year, at least.

6.2. LOCATION AND CONSIDERATIONS.

6.2.1.1. Location.

- Remove the angles and screws from the plastic bag and assemble them on the rack mounting bypass.
- These devices are designed to be integrated into rack cabinets. Illustrations from Fig 5 and 6 are mere examples and the first one shows the wall mounting version for 16 A model.

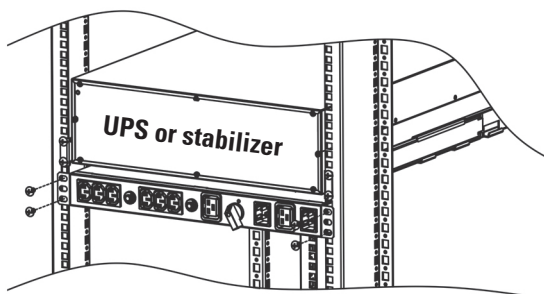

19" rack installation.

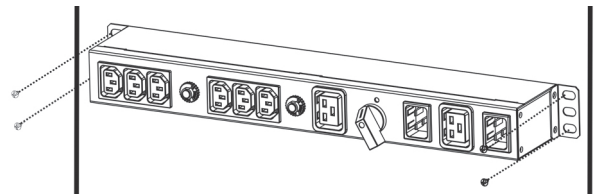

Wall mounting installation.

Fig. 5. Example of 3 kVA manual bypass installation.

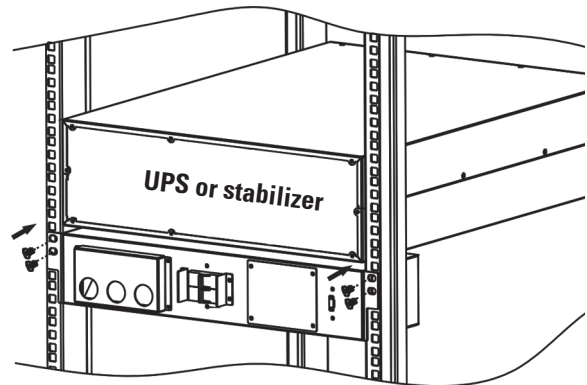





Fig. 6. Example of 6 and 10 kVA manual bypass installation.

6.3. WIRING.

-  Any equipment connection, control included (interface, remote control, ...), will be done with all the switched OFF and with no mains present (power supply switch of the UPS to «Off»).
-  Do not forget that the UPS is an electrical generator, so the end-user must take the needed cautions against the direct and indirect contacts, in case the installation has one.
- For 6 and 10 kVA manual bypass connected to a UPS, the documentation of itself will be taken into account, as regard the «Backfeed protection». Also, in the installation itself, it is also stated the cross cable section and protection size and features, etc.. for a determined power rate. At least proceed according to these recommendations.
- For 6 and 10 kVA models, remove the terminal protection cover **11**. Once the connection actions are finished, put it back.
 -  Cover **11** has two cable glands **12** for the use of the cable entrance. Before connecting the cables to their respective terminals, remember to pass them through

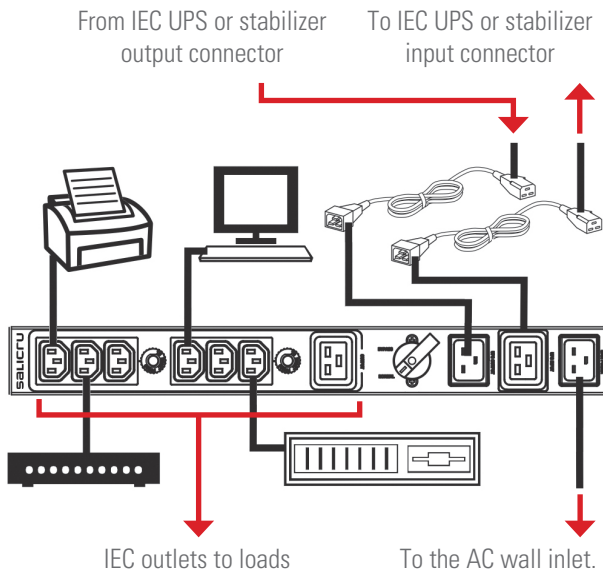

Fig. 7. Example of 3 kVA manual bypass wiring.

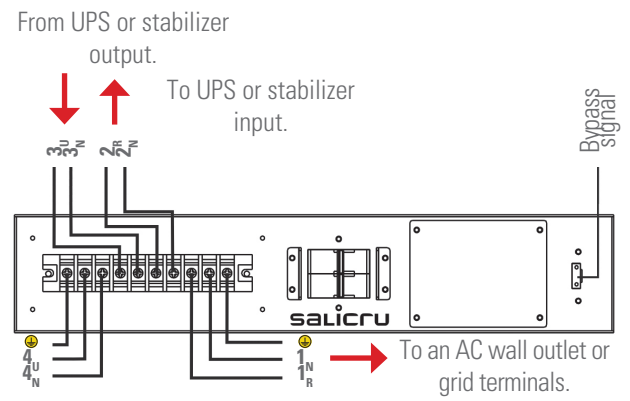





Fig. 8. Example of 6 and 10 kVA manual bypass wiring.

- For 6 and 10 kVA models, the manual bypass has an auxiliary contact **10** labelled as EBMS, which has to be connected with its homologous located in the UPS or stabilizer, where its mission has been previously described.

 The risk of short-circuit is increased in case of wrong manoeuvring, when the UPS or stabilizer do not have this contact or it has not been connected. Make the steps following the stated order.

- Illustrations of Fig. 7 and/or 8 show how to connect the manual bypass with a UPS or stabiliser and loads, depending on its power rate.

 Respect the stated input and output strictly, otherwise the UPS or stabiliser, manual bypass and loads can be damaged.

-  As this is an equipment with protection against electrical shocks class I, it is essential to install the main earth protection cable [⚡].

In 3 kVA bypass models.

The bypass power supply plug will be connected to a wall outlet with protection earth duly installed, which through the IEC connectors will be connected to the entire system.

In 6 and 10 kVA bypass models.

Connect the main earth protection cable **5** to the terminal [⚡]. There is a second terminal **5** beside the output terminals. The earth protection cable to be connected to the UPS or stabilizer can be taken from any of them.

7. OPERATING.

- UPS or stabilizer operating manual, which the manual bypass is linked has to be available.
- Make sure that all connections have been done properly and the instructions and labelling on each device as regards to installation have been respected.
- It is needed and mandatory to proceed in the established order.
- Consider the available protections:
 - ❑ In 3 kVA models, two circuit breakers, one for each output terminal strip with IEC connectors.
 - ❑ In 6 and 10 kVA models, one input circuit breaker of 40 or 63 A respectively.

7.1. START UP.

- Supply voltage to the manual bypass input.
- In the 6 and 10 kVA models, turn the input circuit breaker **6** from manual bypass to «On».
- Start the UPS or stabilizer up, by respecting the steps stated in their documentation (user's manual).

7.2. TRANSFERENCE FROM «NORMAL» OR «UPS» MODE TO «BYPASS».

7.2.1. 3 kVA manual bypass models, from «NORMAL» to «BYPASS» mode.

1. Transfer the own UPS or stabilizer to «Bypass mode» (shutdown the inverter or the stabiliser, depending on the case, in order to feed the load through their internal static bypass switch). Confirm the output voltage availability through the LCD panel or indicator.

 **Any transfer manoeuvring will be done with the UPS or stabilizer on «Bypass mode».**

2. Turn the manual bypass switch **8** from «UPS» to «BYPASS». The load will be supplied from the AC grid directly.
3. Those UPS or stabilizer models with input circuit breaker, turn it «Off». The UPS or stabilizer will be out of service completely.
4. In case, a preventive maintenance, reparation or replacement of the equipment were needed, disconnect both cables with the IEC connector, which go from the UPS or stabilizer to the rack mounting manual bypass.

7.2.2. 6 and 10 kVA manual bypass models, from «UPS» to «BYPASS» mode.

1. Transfer the own UPS or stabilizer to «Bypass mode» (shutdown the inverter or the stabiliser, depending on the case, in order to feed the load through their internal static bypass switch). Confirm the output voltage availability through the LCD panel or indicator.

 **Any transfer manoeuvring will be done with the UPS or stabilizer on «Bypass mode».**

2. Remove the protection cover **13** from the manual bypass switch. In case the UPS or stabilizer have not been transferred to «Bypass mode», when the protection cover **13** is removed, the equipment will shift to this operating mode automatically, provided that the bypass signal **10** of the own rack

mounting bypass is connected with the UPS or stabiliser.

3. Turn the manual bypass switch **8** from «UPS» to «BYPASS». The load will be supplied from the AC grid directly.
4. Those UPS or stabilizer models with input circuit breaker, turn it «Off». The UPS or stabilizer will be out of service completely.
5. In case, a preventive maintenance, reparation or replacement of the equipment were needed, disconnect the cables between the UPS or stabilizer and the rack mounting manual bypass.

 It is recommended to disconnect both ends of the cable, UPS or stabilizer and rack mounting bypass, in order to avoid any incident of wrong manoeuvring.

7.3. TRANSFERENCE FROM «BYPASS» TO «NORMAL» OR «UPS» MODE.

7.3.1. 3 kVA manual bypass models, from «BYPASS» to «NORMAL» mode.

1. Check that the complete set is connected according to section 6.3, as regards to the power of each model.
2. UPS or stabiliser models with input circuit breaker, turn it «On», and the «Bypass mode» will be restored (the UPS inverter or stabiliser has to be turned «Off»).
3. Turn the manual bypass switch **8** from «BYPASS» to «NORMAL». The load will be supplied through the AC grid through the UPS or stabiliser static bypass.

 **Any transfer manoeuvring will be done with the UPS or stabilizer on «Bypass mode».**

4. Turn the UPS inverter or stabilizer «On», by respecting the steps stated in their documentation (user's manual).

7.3.2. 6 and 10 kVA manual bypass models, from «BYPASS» to «UPS» mode.

1. Check that the complete set is connected according to section 6.3, as regards to the power of each model.
2. UPS or stabiliser models with input circuit breaker, turn it «On», and the «Bypass mode» will be restored (the UPS inverter or stabiliser has to be turned «Off»).
3. Turn the manual bypass switch **8** from «BYPASS» to «UPS». The load will be supplied through the AC grid through the internal UPS or stabiliser static bypass.

 **Any transfer manoeuvring will be done with the UPS or stabilizer on «Bypass mode».**

4. Put the protection cover **13** of the manual bypass switch back, otherwise the UPS inverter or stabiliser will not start up.
5. Turn the UPS inverter or stabilizer «On», by respecting the steps stated in their documentation (user's manual).

8. MAINTENANCE, WARRANTY AND SERVICE.

8.1. MAINTENANCE.

- This product does not require any preventive maintenance.

8.2. WARRANTY CONDITIONS.

8.2.1. Warranty terms.

Warranty conditions for the acquired product can be found in our website, please register the unit in it. It is recommended to do it as soon as possible in order to be included in the data base of our Technical Service and Support **(T.S.S.)**. Among others benefits, in case of any **T.S.S.** intervention to fix an hypothetical failure, the procedure formality will be smoother.

8.2.2. Out of scope of supply.

In case it is detected that the product is not damaged or the fault was caused by a wrong manoeuvring, negligence, installation and/or wrong checking, reparation attempts or non-authorized modifications, or any other cause beyond of the intended use, or by accident fire, lightnings or other dangers, **our company** is not forced by the warranty. Also, it will not cover any compensation due to the incurred damages.

8.3. TECHNICAL SERVICE NETWORK.

The coverage in both national and international markets for Technical Service and Support **(T.S.S.)**, can be found in our Website.

9. ANNEXES.

9.1. TECHNICAL SPECIFICATIONS.

Available power rates (kVA)	3	6	10
Input and output topology	Single phase / Single phase		
Male IEC connector or terminals, AC input power supply	IEC connector	3 terminals (phase, neutral and PE)	
Female IEC connector or terminals, UPS or stabilizer power supply	IEC connector	3 terminals (phase, neutral and PE)	
Female IEC connector or terminals, from UPS or stabilizer output	IEC connector	3 terminals (phase, neutral and PE)	
Maximum permissible voltage of the input circuit breaker	250 V		
Input circuit breaker size	-	40 A	63 A
Maximum permissible voltage of manual bypass switch	690 V		
Maximum permissible current of the manual bypass switch	16 A	40 A	63 A
Selective output breakers IEC connectors	2	-	-
Maximum permissible voltage of the output breakers	250 V		
Output breaker size	10 A	-	-
Number of output connectors or terminals	2 groups of 3 female IEC connectors of 10 A with thermic protection + 1 direct female IEC connector of 16 A	1 group of 3 terminals (phase, neutral and PE)	
Operating relative humidity	0-95 % non-condensing		
Protection degree	IP20		
Dimensions - Depth x Width x Height- (mm)	110 x 438 (480) x 50 mm	160 x 438 (480) x 86 (2U) mm	
Weight	1,5 kg	3 kg	
Safety	EN-IEC 62040-1; EN-IEC 60950-1		
Marking	CE		
Quality System	ISO 9001 and ISO 140001		

Tab. 1. Technical specifications.

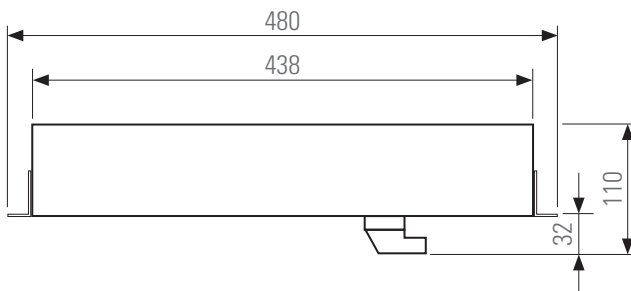

Fig. 9. Dimensions BM-R 3 kVA.

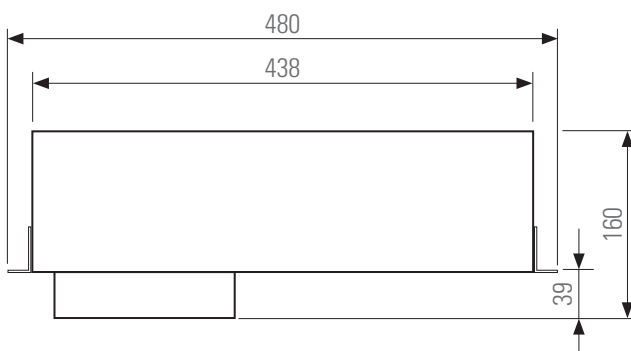

Fig. 10. Dimensions BM-R 6 and 10 kVA.



A series of horizontal dotted lines spanning the width of the page, providing a guide for handwriting practice.



A series of horizontal dotted lines spanning the width of the page, providing a template for writing or drawing.

SALICRU

Avda. de la Serra 100

08460 Palautordera

BARCELONA

Tel. +34 93 848 24 00

Fax +34 93 848 22 05

services@salicru.com

SALICRU.COM



The Technical Service and Support (T.S.S.) network, Commercial network and warranty information are available in website:

www.salicru.com

Product Range

Uninterruptible Power Supplies (UPS)

Lighting Flow Dimmer-Stabilisers

DC Power Systems

Static Inverters

Photovoltaic Inverters

Voltage stabilisers

Variable frequency drives



@salicru_SA



www.linkedin.com/company/salicru

