

INSTRUCTIONS FOR USE

BEFORE USING THE COOKTOP

SUGGESTIONS FOR ENVIRONMENT PROTECTION

PRECAUTIONS AND GENERAL ADVICE

ENERGY SAVING TIPS

CARE AND MAINTENANCE

TROUBLESHOOTING GUIDE

AFTER SALES SERVICE

INSTALLATION



BEFORE USING THE COOKTOP

These instructions are only valid for those Countries where the destination abbreviations are mentioned on the rear cover of the user instructions and on the appliance.

- To get full satisfaction of your cooktop, please read these instructions carefully and keep them for future consultation.

- Keep the packaging material (plastic bags, polystyrene parts, etc.) out of the reach of children, as they are potentially dangerous.
- Check whether the cooktop has been damaged during transport.
- Ensure that the installation and gas/electrical connections are performed by a qualified technician, following the manufacturer's instructions and in compliance with current local safety regulations.

SUGGESTIONS FOR ENVIRONMENT PROTECTION

1. Packaging

The packaging material is entirely recyclable, and is marked with the recycling symbol , which identifies it as a type of material that must be sent to local waste-disposal centres.

2. Product

The cooktop is made out of recyclable material. When scrapping it, comply with local waste-disposal regulations. Before disposing of it, cut its power cable off in order to render it inoperative.

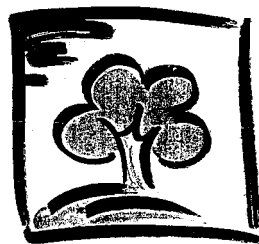

PRECAUTIONS AND GENERAL ADVICE

- Before any cleaning or maintenance operation, disconnect the cooktop from mains power supply.
- The use of a gas appliance produces heat and humidity in the room. Ensure that the room is well ventilated, or install an extractor hood with exhaust duct.
- In case of prolonged use, additional ventilation may be needed (opening a window or increasing the extraction force of the hood).
- Keep children away from the cooktop when it is in use and when it has just been switched off.
- After use, ensure that the knobs are in position  (off), and close the main gas delivery valve or the gas cylinder valve.
- Caution: the lid (where present) might break if overheated. Before closing it, make sure that all the burners are off.
- Warning: The protective rubber feet on the panstand grids represent a choking hazard for young children. After cleaning the panstand grids, please ensure that all the rubber feet are correctly fitted.

Declaration of conformity

- This cooktop has been designed, constructed and marketed in compliance with:
 - safety requirements of EEC Directive "Gas" 90/396;
 - safety requirements of EEC Directive "Low voltage" 73/23;
 - protection requirements of EEC Directive "EMC" 89/336;
 - requirements of EEC Directive 93/68.
- This cooktop is suitable for contact with foodstuffs, and complies with EEC Directive 89/109.
- This cooktop (Class 3) has been designed to be used only for cooking. Any other use (such as heating a room) is improper and dangerous.

ENERGY SAVING TIPS

- The cooktop is equipped with burners and/or a hotplate with different diameters. Use pots and pans whose bottom diameter is equal to that of the burners and hotplate, or slightly larger.
- Only use flat-bottomed pots and pans.
- The pots and pans must not overlap the control panel.

Burner	Diameter of container
Large (9,1 cm)	24 to 26 cm
Medium (6,4 cm)	16 to 22 cm
Small (4,5 cm)	8 to 14 cm
Triple crown (12 cm)	24 to 26 cm
Fish kettle (23 cm x 4,5 cm)	16 to 35 cm

- If possible, keep the container covered when cooking.
- Cook vegetables, potatoes, etc. with a small amount of water in order to cut down cooking time.
- A pressure cooker allows you to save even more energy and time.





CARE AND MAINTENANCE

Cleaning the cooktop surface, panstand grids and control panel

- Before cleaning the cooktop, disconnect it from mains power supply and wait until it has cooled down.
- Wipe with a cloth moistened with hot water and soap or diluted liquid detergent.
- Do not use abrasive or corrosive products, chlorine products or steel wool.
- Do not use vapour cleaning appliances.
- Do not use flammable products.
- Do not leave acid or alkaline substances, such as vinegar, salt or lemon juice, etc., on the cooktop.

Stainless steel surface

- Clean with a specific commercial product.

Note: if the cooktop is used continuously, the high temperatures produced by the flames may alter the colour of the surface near the burners.

Cleaning the burners

1. Raise the cap and remove it.
2. Extract the burner from its housing by pulling it up.
3. Soak the burner and the cap in hot water and liquid detergent. (Do not wash into a dishwasher).
4. Rinse out and dry carefully.
5. Ensure that none of its openings is clogged.
6. Reposition the burner and cap.

Note: to avoid damaging the electric ignition device, do not use it when the burners are not in their housing.

Cleaning the electric hotplate

The electric hotplate must be cleaned when it is lukewarm. Wipe with a cloth moistened with water and salt, and polish with a cloth moistened with oil.



TROUBLESHOOTING GUIDE

1. The burner fails to ignite:

- Is the main gas delivery valve open?
- Has the delivery of the town gas (methane) been suspended?
- Is the gas cylinder (liquid gas) empty?
- Are the openings of the burner clogged?
- Have the cap and burner been positioned correctly after cleaning?
(See paragraph "Care and Maintenance".)

2. The burner fails to remain lit:

- Repeat the ignition operation, turning the knob to the position with the small flame symbol .

3. The electric ignition device does not work:

- Is there a power failure?

AFTER SALES SERVICE

Before you call the After Sales Service:

1. Check the "Troubleshooting guide" above to see if you can eliminate the trouble yourself.
2. Re-start the cooktop, to check whether correct operation has been restored.
3. If the malfunction persists, call the After Sales Service.

Give the following information:

- type of malfunction;
- model of cooktop;
- service number (i.e., the number that follows the word SERVICE on the rating plate under the cooktop and on the guarantee paper);
- your complete address;
- your telephone number and area code.

If any repairs are required, please contact an **authorised After-Sales Service**, as indicated in the warranty.

In the unlikely event that an operation or repair is carried out by an **unauthorised technician**, always request a certification of the job carried out and insist on the use of **original spare parts**.

Failure to comply with these instructions may compromise the safety and quality of the product.

SERVICE 0000 000 00000





INSTALLATION

Technical information for the Installer

This cooktop can be embedded in a worktop 20 to 50 mm thick. If there is no oven beneath the cooktop (any oven installed must be manufactured by us and equipped with a cooling system), insert a separator panel at a minimum distance of 20 mm from the bottom of the cooktop.

Note: before installation, make sure that the local gas delivery conditions (nature and pressure of gas) are compatible with the settings of the cooktop, as indicated on the Product Description Sheet and on the rating plate.

- If a vertical piece of furniture is installed, there must be a gap of at least 100 mm between it and the edge of the cooktop.
- Before installation, remove the plastic film protecting the appliance, if provided.
The outer surfaces of the furniture or appliances adjacent to the cooktop must be heat resistant (heat protection "V") according to standards.
- Installation must comply with current local regulations.
- In the room where the cooktop is installed, there must be enough air to allow the gas to burn correctly (see the separate Product Description Sheet).
- The natural flow of air must take place through an adequate opening, that must be:
 - permanent, made on one of the outside walls of the room, and communicating with the exterior in an area away from sources of pollution;
 - built so as to ensure that its openings, both on the inside and on the outside, cannot be obstructed, intentionally or accidentally;
 - protected by a metal grid or mesh that does not reduce its working section;
 - situated near the floor level and positioned so as not to interfere with the operation of the fume exhaust devices.
 - The fume exhaust has to take place through an appropriate hood or fan installed on the wall or on the window.

Assembly

- Apply the supplied gasket to the cooktop (if not yet fitted), after having cleaned its surface as shown in the relevant figure.

To secure the cooktop, use brackets (A) supplied with it.

1. Fit the brackets into the relevant bores and fasten them by means of their screws.
2. Make an opening in the worktop, respecting the dimensions indicated in the enclosed Product Description Sheet.
3. Install the cooktop in the worktop.

Important: the power supply cable and plug must be suitable for the power absorption of the cooktop, and the cable must be long enough to permit its upward extraction.

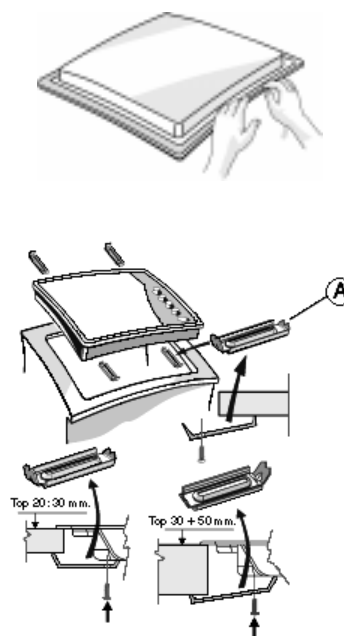

INSTALLATION

Electrical connection

- The electrical connections must comply with local regulations.
- The data relevant to the voltage and power absorption are indicated on the rating plate.
- The earthing of this appliance is compulsory by law.
- The manufacturer cannot be held responsible for any injury to persons or animals or damage to property arising from failure to comply with these requirements.
- When the cooktop is installed, provide a single-pole circuit breaker with a contact separation of at least 3 mm.
- If necessary, the electrical power cable must be replaced exclusively with a power cable having identical characteristics to the original supplied by the manufacturer (type H05V2V2-F - T90°C or type H05RR-F). This operation must be performed by the After Sales Service or a qualified electrician.

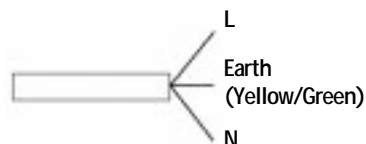

Connection to gas supply

The gas supply system must comply with local regulations. You can find specific local regulations for some countries, in the separate National Safety Regulations Sheet supplied. If no information concerning your Country is given, please ask details to your Installer.

The connection of the cooktop to the gas pipe network or gas cylinder must be made by means of a rigid copper or steel pipe with fittings complying with local regulations, or by means of a continuous-surface stainless steel hose complying with local regulations. Interpose gasket (B) in the elbow connection.

The maximum length of the hose is 2 m.

FOR BELGIUM ONLY: It is necessary to replace the elbow connection (A) on the appliance, with the one supplied.

Important: if a stainless steel hose is used, it must be installed so as not to touch any mobile part of the furniture. It must pass through an area where there are no obstructions and where it is possible to inspect it on all its length.

After connection to the gas supply, check for leaks with soapy water.

Attention: Should you experience difficulty in turning the burners knobs, please contact the After Sales Service for the replacement of the burner tap.

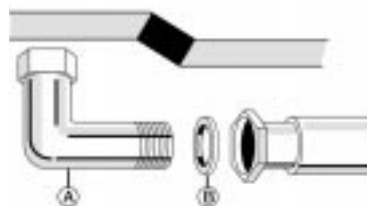

INSTALLATION

ADJUSTMENT TO DIFFERENT TYPES OF GAS

If a different type of gas to the type shown on the rating plate and on the orange sticker affixed to the top of the cooktop is used, the cooktop must be converted to work with the new gas type. Remove the orange sticker and affix it to the instructions booklet, which must be retained for the lifetime of the appliance.

Use pressure regulators suitable for the gas pressures indicated in the separate Product Description Sheet.

1. The gas nozzles must be changed by After Sales Service or a qualified technician.
Nozzles not supplied with the appliance must be ordered from After Sales Service.
2. Connect the cooktop to the gas shut-off valve by means of a pipe suitable for the type of gas used, in compliance with current local regulations.
3. Adjust the minimum setting of the taps.

Note: when liquid petroleum gas is used (G30/G31), the minimum gas setting screws must be tightened as far as they will go.

Replacing the injectors (see table in the enclosed Product Description Sheet)

1. Remove grids (A).
2. Extract burners (B).
3. Using a socket spanner of the appropriate size, (C), unscrew the injector to be replaced.
4. Replace it with the injector suitable for the new type of gas.
5. Re-assemble the injector in (D).
6. For models equipped with a triple crown burner, proceed as shown in figure.

- Remove the two screws (F) followed by the cap (G) then replace both injectors (D) as previously described. Replace the cap (G), ensuring the seal is properly positioned before attempting to use the cooktop.

Before installing the cooktop, remember to affix the gas calibration plate supplied with the injectors in such a way that it covers the existing information relating to gas calibration



Adjusting minimum gas setting of taps

1. To ensure that the minimum setting is correctly adjusted, remove knob (E) and proceed as follows:

- tighten (-) to reduce the height of the flame;
- loosen (+) to increase the height of the flame;

The adjustment must be performed with the tap in minimum gas setting position (small flame) .

Upon completion of adjustment, reseal using sealing wax or an equivalent material.

2. The primary air of the burners does not need to be adjusted.
3. After the adjustment of the minimum gas setting, light up the burners and turn the knobs from max. position  to min. position  to check the stability of the flame.

