



Ledinaire SlimDownlight DN065B

DN065B LED20S/830 PSU II WH

LED Module, system flux 2000 lm - 830 warm white - Power supply unit - Safety class II - White

The LEDINAIRE range contains a selection of popular off-the-shelf LED luminaires that come with the high Philips quality levels at a competitive price. Reliable, energy-efficient and affordable – just what you need

Product data

General Information	
Number of light sources	1 pc
Lamp family code	LED20S [LED Module, system flux 2000 lm]
Beam angle of light source	90 x 90 °
Light source color	830 warm white
Light source replaceable	No
Number of gear units	1 unit
Driver/power unit/transformer	Power supply unit
Driver included	Yes
Optic type	Wide beam
Luminaire light beam spread	90° x 90°
Connection	Screw connector
Cable	-
Protection class IEC	Safety class II
Glow-wire test	Temperature 650 °C, duration 5 s
Flammability mark	-

CE mark	CE mark
ENEC mark	-
Warranty period	3 years
Constant light output	No
Number of products on MCB of 16 A type B	48
RoHS mark	RoHS mark
Operating and Electrical	
Input Voltage	220 to 240 V
Input Frequency	50 to 60 Hz
Inrush current	6.07 A
Inrush time	272 ms
Power Factor (Min)	0.8

Ledinaire SlimDownlight DN065B

Controls and Dimming

Dimmable	No
----------	----

Mechanical and Housing

Housing Material	Aluminum
Reflector material	-
Optic material	Polycarbonate
Optical cover/lens material	Polycarbonate
Fixation material	Stainless steel
Optical cover/lens finish	Frosted
Overall height	30 mm
Overall diameter	225 mm

Approval and Application

Ingress protection code	IP20 [Finger-protected]
Mech. Impact protection code	IK02 [0.2 J standard]

Initial Performance (IEC Compliant)

Initial luminous flux (system flux)	1850 lm
Luminous flux tolerance	+/-10%
Initial LED luminaire efficacy	80 lm/W
Init. Corr. Color Temperature	3000 K
Init. Color Rendering Index	>80
Initial chromaticity	(0.42, 0.40) SDCM <5
Initial input power	23 W

Power consumption tolerance	+/-10%
-----------------------------	--------

Over Time Performance (IEC Compliant)

Driver failure rate at 5000 h	1.5 %
Median useful life L70B50	30000 h
Median useful life L80B50	20000 h
Median useful life L90B50	15000 h

Application Conditions

Ambient temperature range	0 to +35 °C
Suitable for random switching	No

Product Data

Full product code	871869938177699
Order product name	DN065B LED20S/830 PSU II WH
EAN/UPC - Product	8718699381776
Order code	910503910333
Numerator - Quantity Per Pack	1
Numerator - Packs per outer box	12
Material Nr. (12NC)	910503910333
Net Weight (Piece)	0.440 kg

Dimensional drawing

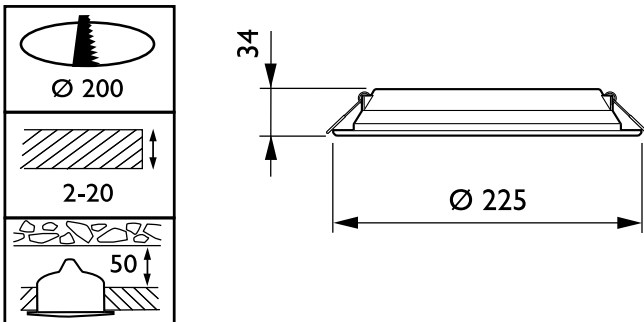

Ledinaire SlimDownlight DN065B

Ledinaire SlimDownlight DN065B

