

Dell OptiPlex 3050 All-in-One

Owner's Manual



Notes, cautions, and warnings

 | **NOTE:** A NOTE indicates important information that helps you make better use of your product.

 | **CAUTION:** A CAUTION indicates either potential damage to hardware or loss of data and tells you how to avoid the problem.

 | **WARNING:** A WARNING indicates a potential for property damage, personal injury, or death.

© 2016 Dell Inc. or its subsidiaries. All rights reserved. This product is protected by U.S. and international copyright and intellectual property laws. Dell and the Dell logo are trademarks of Dell Inc. in the United States and/or other jurisdictions. All other marks and names mentioned herein may be trademarks of their respective companies.

1 Working on your computer	7
Safety instructions.....	7
Before working inside your computer.....	7
Turning off your computer.....	7
Turning off your computer — Windows 10.....	8
Turning off your computer — Windows 7.....	8
After working inside your computer.....	8
Important Information.....	8
2 Removing and installing components	9
Stand.....	9
Removing easel stand.....	9
Installing easel stand.....	10
Installing Height Adjustable Stand - HAS.....	10
Removing Height Adjustable Stand.....	12
Optical drive.....	12
Removing optical drive.....	12
Installing optical drive.....	13
Back cover.....	13
Removing back cover.....	13
Installing back cover.....	14
Intrusion switch.....	14
Removing intrusion switch.....	14
Installing intrusion switch.....	15
System board shield.....	15
Removing system board shield.....	15
Installing system board shield.....	16
Hard drive.....	16
Removing hard drive.....	16
Installing hard drive	17
Cable holder.....	17
Removing cable holder.....	17
Installing cable holder	18
Memory modules.....	18
Removing memory module.....	18
Installing memory module.....	19
Coin cell battery.....	19
Removing coin cell battery.....	19
Installing coin cell battery.....	20
Solid State Drive — optional	20
Removing Solid State Drive (SSD) card.....	20
Installing Solid State Drive (SSD) card.....	21
WLAN card.....	21



Removing WLAN card.....	21
Installing WLAN card.....	22
Heat sink	22
Removing heat sink	22
Installing heat sink	23
System fan.....	23
Removing system fan (35 W optional).....	23
Installing system fan (35 W optional).....	24
Removing system fan (65 W).....	24
Installing system fan (65 W).....	25
Power and On-Screen Display.....	25
Removing power and On-Screen Display (OSD) board	25
Installing power and On-Screen Display (OSD) board.....	26
Speaker.....	26
Removing speaker	26
Installing speaker.....	28
VGA/Serial port (optional).....	28
Removing VGA/serial port (optional).....	28
Installing VGA/serial port (optional).....	29
Processor.....	29
Removing processor.....	29
Installing processor.....	30
System board.....	30
Removing system board.....	30
Installing system board.....	33
Chassis frame.....	33
Removing chassis frame.....	33
Installing chassis frame.....	35
Display assembly.....	36
Removing display assembly.....	36
Installing display assembly.....	37
Camera.....	38
Removing camera.....	38
Installing camera.....	39
M.2 Intel Optane Memory Module 16 GB.....	39
Overview.....	39
Intel®Optane™ Memory Module Driver Requirements.....	40
Installing M.2 Intel Optane Memory Module 16 GB.....	40
Product specifications.....	41
Environmental Conditions.....	42
Troubleshooting.....	43
3 Technology and components.....	45
Chipsets.....	45
Identifying chipset in Device Manager on Windows 7.....	45
Identifying the chipset in Device Manager on Windows 10.....	45
Intel HD Graphics drivers.....	45



Downloading the chipset driver.....	46
Downloading drivers.....	46
Display options.....	46
Identifying the display adapter (Windows 7 and Windows 10).....	46
Changing the screen resolution (Windows 7 and Windows 10).....	47
Adjusting brightness in Windows 7.....	47
Adjusting brightness in Windows 10.....	47
Connecting to external display devices (Windows 7, 8.1 and 10).....	47
Intel HD Graphics	47
Intel HD Graphics drivers.....	47
Hard drive options.....	48
Identifying the hard drive in Windows 7.....	48
Identifying the hard drive in Windows 10.....	48
Entering BIOS setup.....	48
USB features.....	48
USB 3.0/USB 3.1 Gen 1 (SuperSpeed USB).....	49
Speed.....	49
Applications.....	50
Compatibility.....	50
Memory features.....	51
Verifying system memory in Windows 10 and Windows 7	51
Verifying system memory in setup.....	51
DDR4.....	51
Testing memory using ePSA.....	52
Realtek HD audio drivers.....	53
4 System setup.....	54
BIOS Overview.....	54
Boot menu.....	54
System setup options.....	54
5 Technical specifications.....	63
Processor specifications.....	63
Memory specifications.....	64
Video specifications.....	64
Audio specifications.....	64
Communication specifications.....	64
Cards specifications.....	65
Display specifications.....	65
Drives specifications.....	65
Port and connector specifications.....	65
Power specifications.....	66
Camera specifications.....	66
Stand specifications.....	66
Physical specifications.....	66
Environmental specifications.....	67



6 Troubleshooting..... 68
Enhanced Pre-Boot System Assessment — ePSA diagnostics..... 68
Running the ePSA diagnostics..... 68
LCD built in self test (BIST)..... 68
 Invoking BIST with user modes..... 70
 OSD toggle..... 70
 ePSA..... 70

7 Contacting Dell..... 72



Working on your computer

Safety instructions

Use the following safety guidelines to protect your computer from potential damage and to ensure your personal safety. Unless otherwise noted, each procedure included in this document assumes that the following conditions exist:

- You have read the safety information that shipped with your computer.
- A component can be replaced or, if purchased separately, installed by performing the removal procedure in reverse order.

⚠ WARNING: Disconnect all power sources before opening the computer cover or panels. After you finish working inside the computer, replace all covers, panels, and screws before connecting to the power source.

⚠ WARNING: Before working inside your computer, read the safety information that shipped with your computer. For additional safety best practices information, see the Regulatory Compliance Homepage at www.Dell.com/regulatory_compliance

⚠ CAUTION: Many repairs may only be done by a certified service technician. You should only perform troubleshooting and simple repairs as authorized in your product documentation, or as directed by the online or telephone service and support team. Damage due to servicing that is not authorized by Dell is not covered by your warranty. Read and follow the safety instructions that came with the product.

⚠ CAUTION: To avoid electrostatic discharge, ground yourself by using a wrist grounding strap or by periodically touching an unpainted metal surface at the same time as touching a connector on the back of the computer.

⚠ CAUTION: Handle components and cards with care. Do not touch the components or contacts on a card. Hold a card by its edges or by its metal mounting bracket. Hold a component such as a processor by its edges, not by its pins.

⚠ CAUTION: When you disconnect a cable, pull on its connector or on its pull-tab, not on the cable itself. Some cables have connectors with locking tabs; if you are disconnecting this type of cable, press in on the locking tabs before you disconnect the cable. As you pull connectors apart, keep them evenly aligned to avoid bending any connector pins. Also, before you connect a cable, ensure that both connectors are correctly oriented and aligned.

ⓘ NOTE: The color of your computer and certain components may appear differently than shown in this document.

Before working inside your computer

To avoid damaging your computer, perform the following steps before you begin working inside the computer.

- 1 Ensure that you follow the [Safety Instruction](#).
- 2 Ensure that your work surface is flat and clean to prevent the computer cover from being scratched.
- 3 Ensure you follow the [Turning off your computer](#).
- 4 Disconnect all network cables from the computer.

⚠ CAUTION: To disconnect a network cable, first unplug the cable from your computer and then unplug the cable from the network device.

- 5 Disconnect your computer and all attached devices from their electrical outlets.
- 6 Press and hold the power button while the computer is unplugged to ground the system board.

ⓘ NOTE: To avoid electrostatic discharge, ground yourself by using a wrist grounding strap or by periodically touching an unpainted metal surface at the same time as touching a connector on the back of the computer.

Turning off your computer



Turning off your computer — Windows 10

⚠ CAUTION: To avoid losing data, save and close all open files and exit all open programs before you turn off your computer .

- 1 Click or tap .
- 2 Click or tap  and then click or tap **Shut down**.

i NOTE: Ensure that the computer and all attached devices are turned off. If your computer and attached devices did not automatically turn off when you shut down your operating system, press and hold the power button for about 6 seconds to turn them off.

Turning off your computer — Windows 7

⚠ CAUTION: To avoid losing data, save and close all open files and exit all open programs before you turn off your computer.

- 1 Click **Start**.
- 2 Click **Shut Down**.

i NOTE: Ensure that the computer and all attached devices are turned off. If your computer and attached devices did not automatically turn off when you shut down your operating system, press and hold the power button for about 6 seconds to turn them off.

After working inside your computer

After you complete any replacement procedure, ensure that you connect any external devices, cards, and cables before turning on your computer.

- 1 Connect any telephone or network cables to your computer.

⚠ CAUTION: To connect a network cable, first plug the cable into the network device and then plug it into the computer.

- 2 Connect your computer and all attached devices to their electrical outlets.
- 3 Turn on your computer.
- 4 If required, verify that the computer works correctly by running **ePSA diagnostics**.

Important Information

i NOTE: Avoid using the touchscreen in dusty, hot, or humid environments.

i NOTE: Sudden change in temperature may cause condensation on the inner surface of the glass screen, which will disappear after a short time and does not affect normal usage.

Removing and installing components

This section provides detailed information on how to remove or install the components from your computer.

Stand

Removing easel stand

- 1 Follow the procedure in [Before working inside your computer](#).
- 2 Place the computer on a flat surface with the display facing downward.
- 3 To lift the stand:
 - a Lift the stand to access the stand cover.[1].
 - b Hold the stand cover and lift it away from the computer [2].

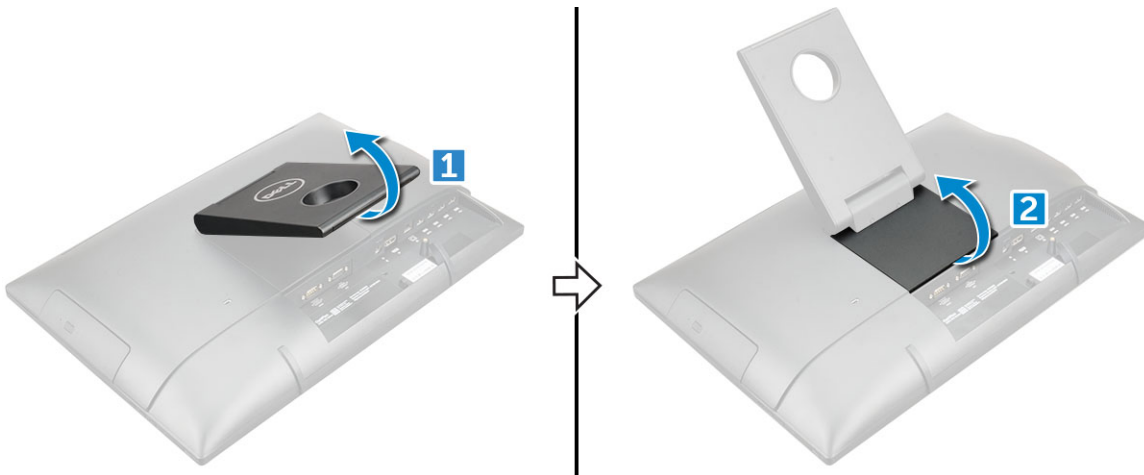

- 4 To remove stand:
 - a Remove the screws that secure the stand [1].
 - b Push the stand to release the metal plate from the notches of the back cover and lift it from the computer [2].

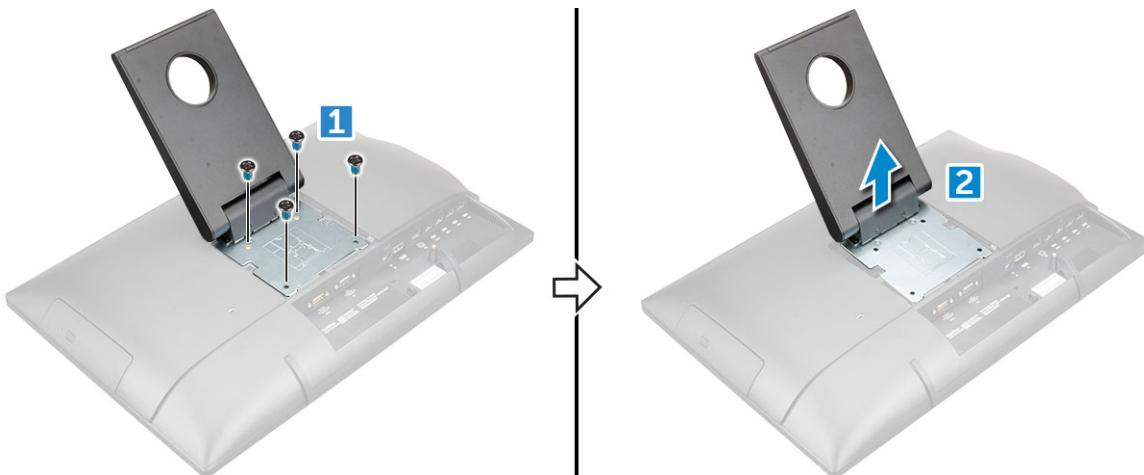

Installing easel stand

- 1 Position the stand to allow the metal plate tab to align with the notches on the back cover.
- 2 Replace the M4x7 screws to secure the stand to the computer.
- 3 Place the cover on the metal plate until snaps in.
- 4 Follow the procedure in [After working inside your computer](#).

Installing Height Adjustable Stand - HAS

① | **NOTE:** A separate VESA bracket and 2 screws are provided to install the Height adjustable stand.

① | **NOTE:** Before installing HAS stand, follow the procedure to install VESA bracket.

- 1 Remove the:
 - a optical drive
 - b back cover
- 2 Insert the VESA bracket into its slot on the computer.

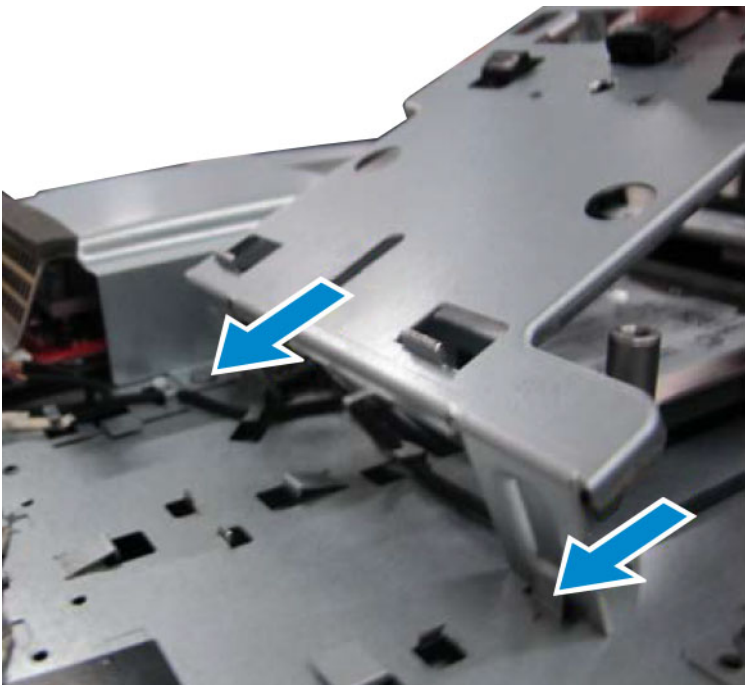

- 3 Install the screws to secure the VESA bracket on the computer.

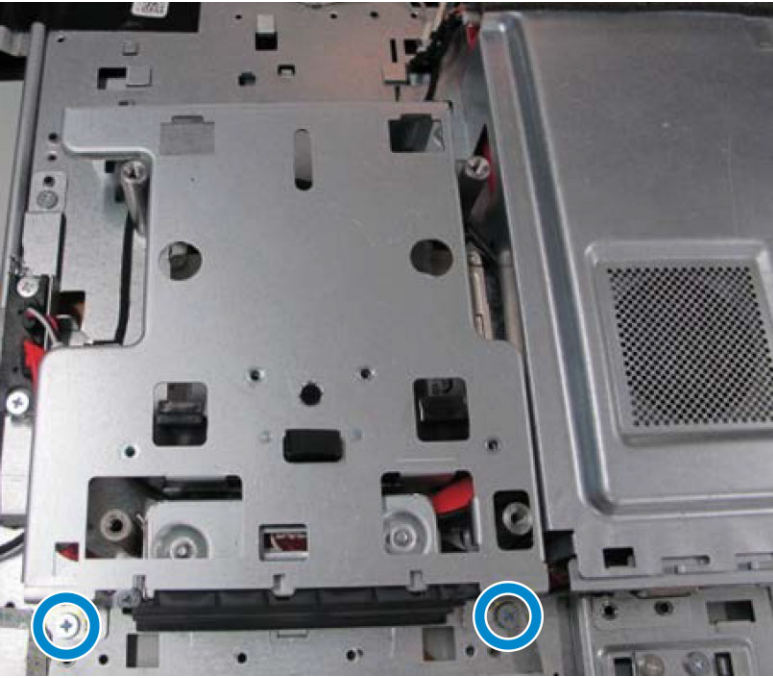

- 4 Close the back cover.
- 5 Install optical drive.
- 6 Position the stand to allow the metal plate tab to align with the notches on the back cover.



- 7 Place the cover on the metal plate until snaps in.





- 8 Follow the procedure in [After working inside your computer](#).

Removing Height Adjustable Stand

- 1 Follow the procedure in [Before working inside your computer](#).
- 2 Place the computer on clean, flat surface with the display facing downward.
- 3 To remove the stand:
 - a Press the tab on the cover to release the stand [1].
 - b Lift the stand upward [2].

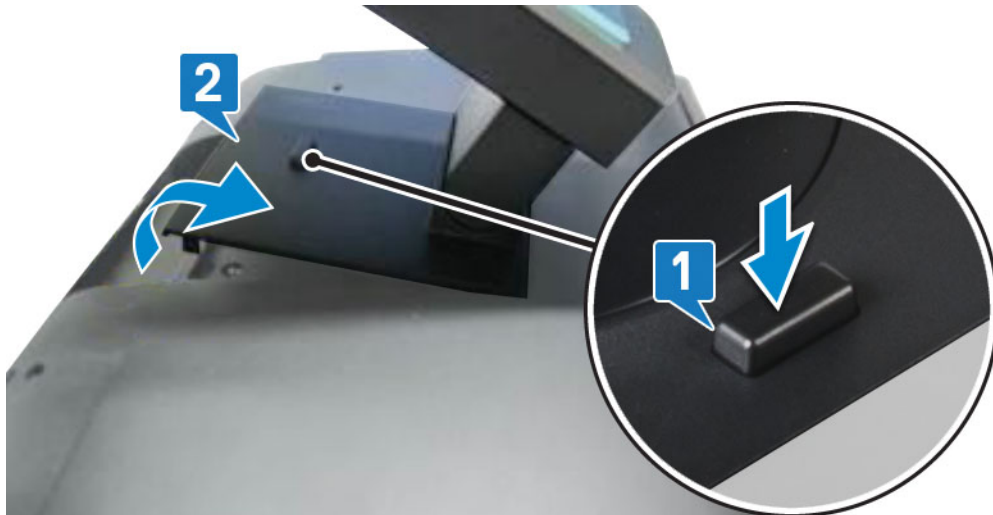

Optical drive

Removing optical drive

- 1 Follow the procedure in [Before working inside your computer](#).
- 2 Remove the [stand](#).
- 3 To remove the optical drive:
 - a Using a plastic scribe push the metal tab that is beneath the cover to release the optical drive [1].
 - b Remove the optical drive from the computer [2].



NOTE: If your system is not shipped with optical drive, to remove the metal tab follow step 3(a).

Installing optical drive

- 1 Insert the optical drive into the slot, until it snaps in.
- 2 Install the [stand](#).
- 3 Follow the procedure in [After working inside your computer](#).

Back cover

Removing back cover

- 1 Follow the procedure in [Before working inside your computer](#).
- 2 Remove the:
 - a [stand](#)
 - b [optical drive](#)
- 3 Pry the edges and remove the back cover optical drive slot.



NOTE: On system with POGO Intrusion feature; after replacing the system board, it is very important that technicians reassemble the back cover prior booting the system up to the SMMM service menu. The POGO intrusion feature can only be enabled when the system is in service mode at SMMM. Once exited, the SMMM can no longer be triggered and a replacement system board would be required.

Installing back cover

- 1 Align the notches on the back cover to the holes on the computer.
- 2 Press the back cover until it snaps on the computer.
- 3 Install the:
 - a optical drive
 - b stand
- 4 Follow the procedure in [After working inside your computer](#).

Intrusion switch

Removing intrusion switch

- 1 Follow the procedure in [Before working inside your computer](#).
- 2 Remove the:
 - a stand
 - b optical drive
 - c back cover
- 3 To remove intrusion switch from the back cover:
 - a Turn the holder clockwise direction [1].
 - b Lift the holder [2].

- c Lift the intrusion switch [3].

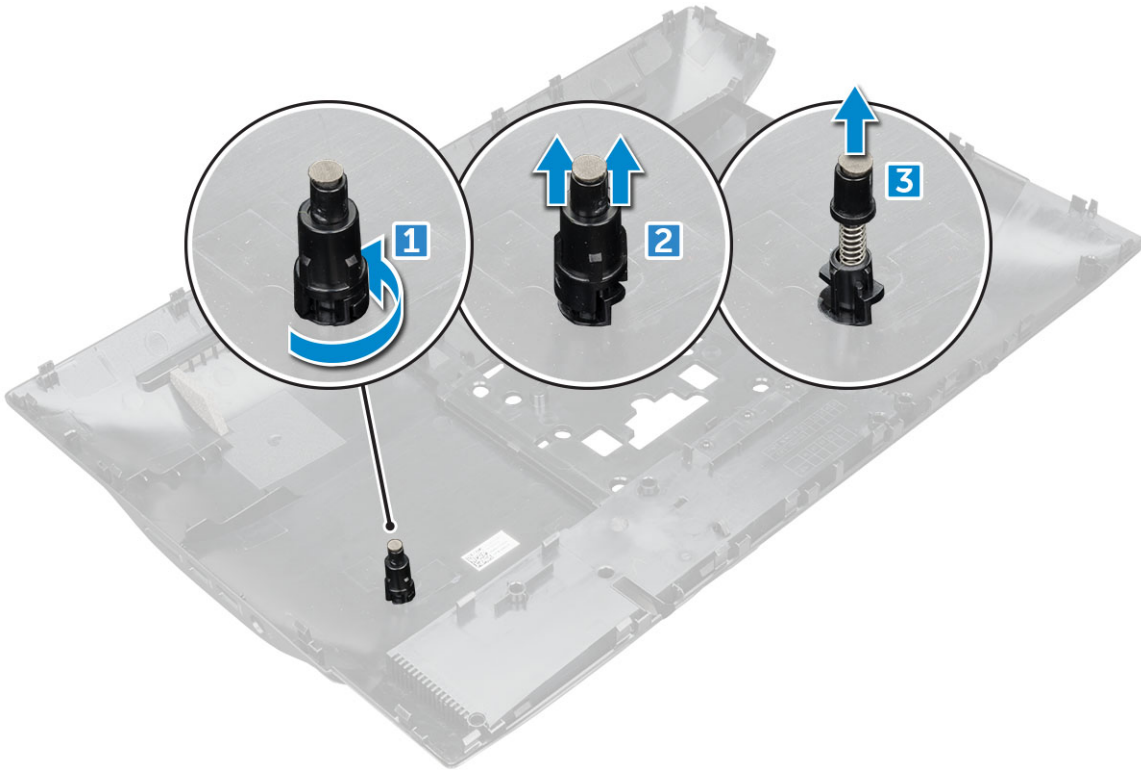

Installing intrusion switch

- 1 Insert the switch on the holder on the back cover.
- 2 Plug the holder to intrusion switch
- 3 Replace the holder in direction.
- 4 Install the:
 - a back cover
 - b optical drive
 - c stand
- 5 Follow the procedure in [After working inside your computer](#).

System board shield

Removing system board shield

- 1 Follow the procedure in [Before working inside your computer](#).
- 2 Remove the:
 - a stand
 - b optical drive
 - c back cover
- 3 To remove system board shield:
 - a Remove the M3 0.5x5 screw that secures system board shield to the computer [1].
 - b Lift the system board shield away from the computer [2].

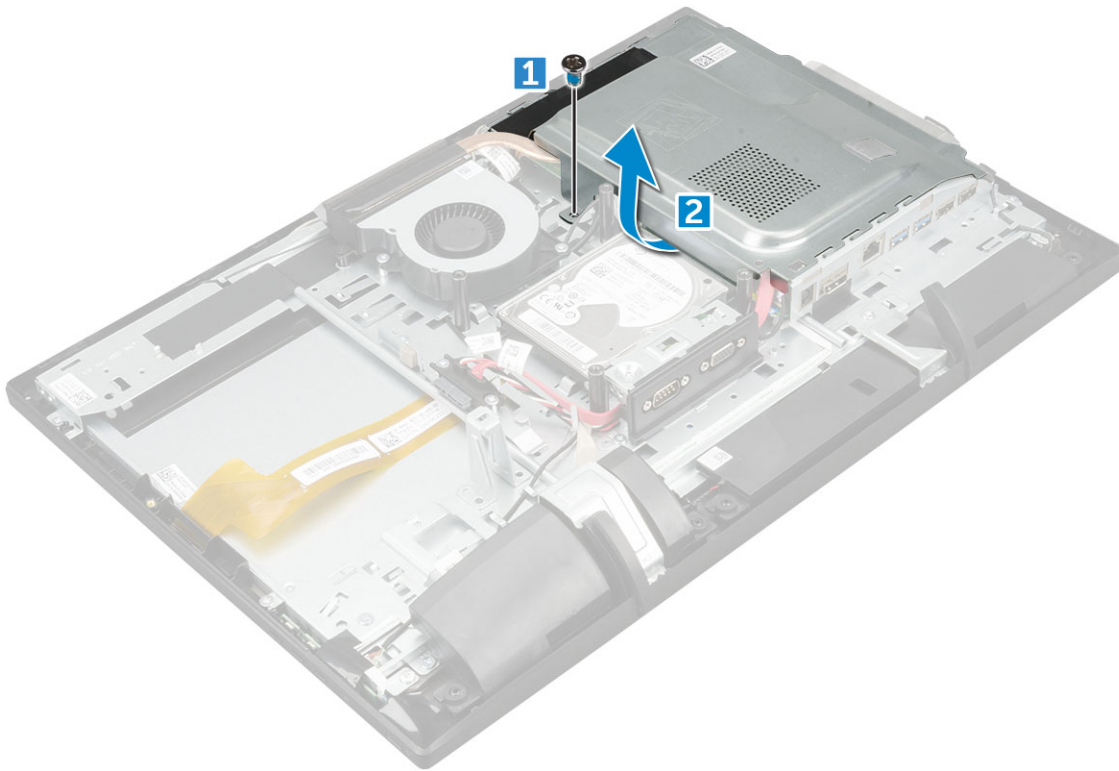

Installing system board shield

- 1 Align the system board shield with the screw holder on the computer.
- 2 Replace M3 0.5x5 screw to secure the system board shield to the computer.
- 3 Install the:
 - a back cover
 - b optical drive
 - c stand
- 4 Follow the procedure in [After working inside your computer](#).

Hard drive

Removing hard drive

- 1 Follow the procedure in [Before working inside your computer](#).
- 2 Remove the:
 - a stand
 - b optical drive
 - c back cover
 - d system board shield
- 3 To remove hard drive:
 - a Remove the M3X3.5 screws that secure the hard drive to the computer [1].
 - b Slide and remove the hard drive from the computer [2].

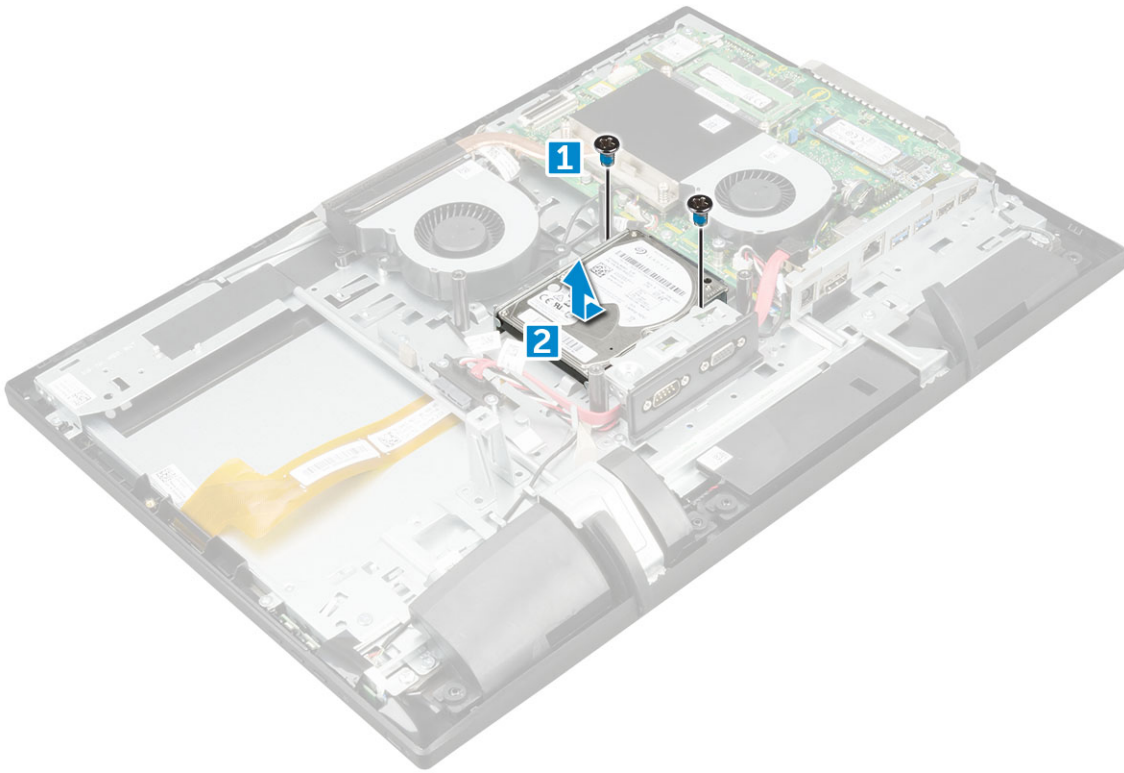

Installing hard drive

- 1 Place the hard drive on the slot and slide it in to align with the screw holders and to connect it to the connector on the system board.
- 2 Replace the M3X3.5 screws to secure the hard drive on the computer.
- 3 Install the:
 - a system board shield
 - b back cover
 - c optical drive
 - d stand
- 4 Follow the procedure in [After working inside your computer](#).

Cable holder

Removing cable holder

- 1 Follow the procedure in [Before working inside your computer](#).
- 2 Remove the:
 - a stand
 - b optical drive
 - c back cover
 - d system board shield
 - e graphics card assembly
- 3 To remove cable holder:
 - a Disconnect and unroute VGA and SATA ODD cables from the system board [1]
 - b Remove the M2x2.5 screws that secure VGA and SATA ODD cables on the computer [2].
 - c Lift the cable holder away from the computer [3].

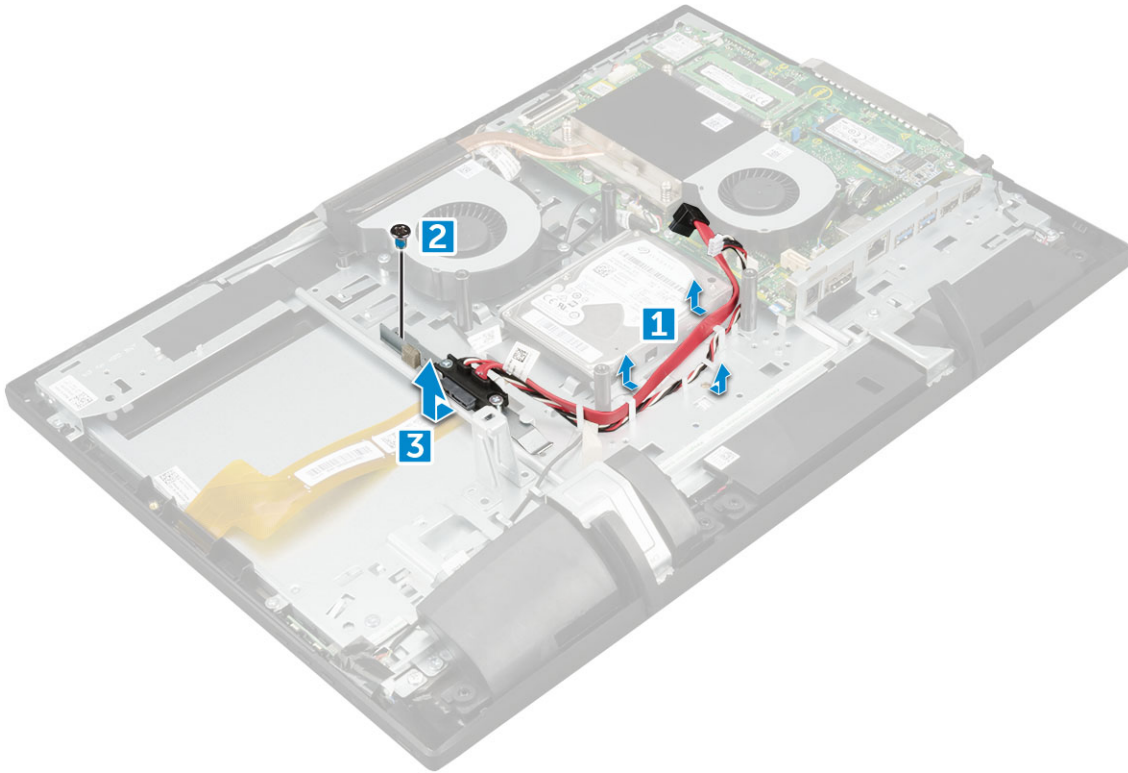

Installing cable holder

- 1 Route the VGA and SATA ODD cable the slot on the chassis.
- 2 Replace the M2x2.5 screws to secure the VGA and SATA ODD cable on the computer.
- 3 Connect the VGA and SATA ODD cables to the connector on the system board.
- 4 Install the:
 - a [graphics card assembly](#)
 - b [system board shield](#)
 - c [back cover](#)
 - d [optical drive](#)
 - e [stand](#)
- 5 Follow the procedure in [After working inside your computer](#).

Memory modules

Removing memory module

- 1 Follow the procedure in [Before working inside your computer](#).
- 2 Remove the:
 - a [stand](#)
 - b [optical drive](#)
 - c [back cover](#)
 - d [system board shield](#)
- 3 To remove memory module:
 - a Pry the retention clips away from the memory module until it pops-up [1].
 - b Lift the memory module from the connector [2].

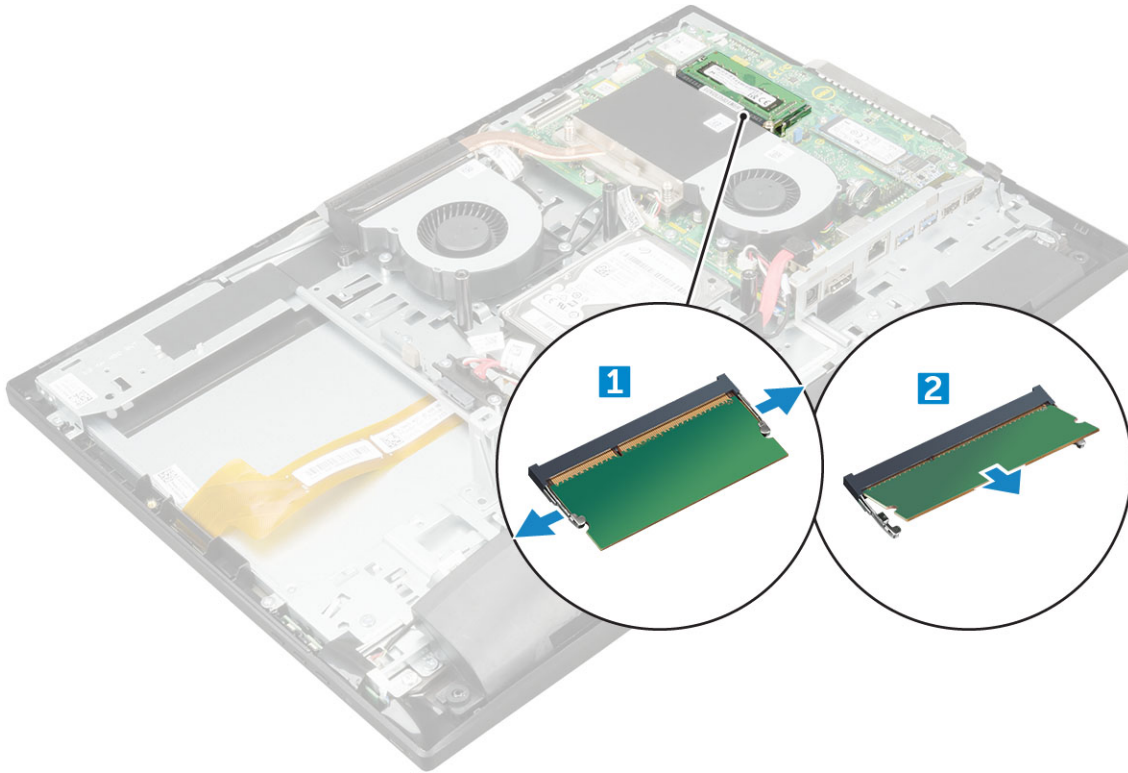

- 4 Perform the same steps to remove the second memory module.

Installing memory module

- 1 Insert the memory module into the slot and then press down until the clips snap-in.
- 2 Perform the same steps to insert the second memory module.
- 3 Install the:
 - a [system board shield](#)
 - b [back cover](#)
 - c [optical drive](#)
 - d [stand](#)
- 4 Follow the procedure in [After working inside your computer](#).

Coin cell battery

Removing coin cell battery

- 1 Follow the procedure in [Before working inside your computer](#).
- 2 Remove the:
 - a [stand](#)
 - b [optical drive](#)
 - c [back cover](#)
 - d [system board shield](#)
- 3 To remove coin cell battery:
 - a Push the metal latch to release the coin cell battery [1].
 - b Lift the coin cell battery from the computer [2].



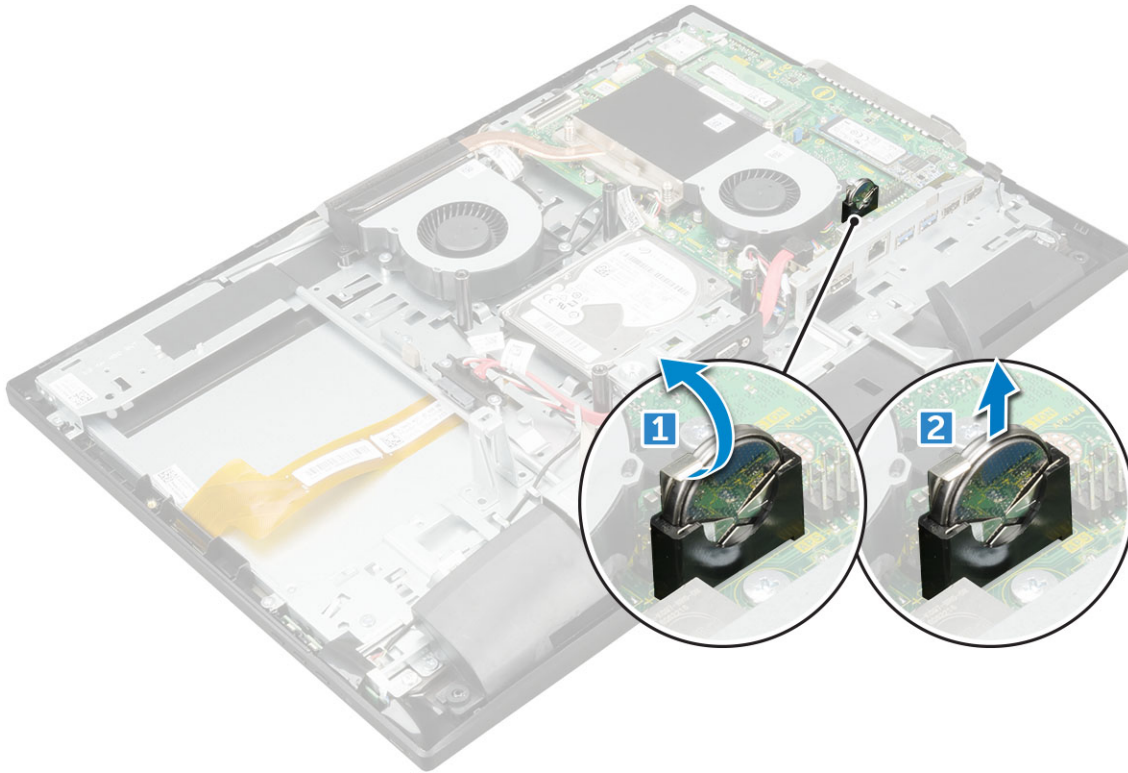

Installing coin cell battery

- 1 Insert the coin cell battery into the slot on the system board, until it fits securely.

NOTE: Insert the coin cell with the smooth side facing the metal tab.

- 2 Install the:
 - a system board shield
 - b back cover
 - c optical drive
 - d stand
- 3 Follow the procedure in [After working inside your computer](#).

Solid State Drive — optional

Removing Solid State Drive (SSD) card

- 1 Follow the procedure in [Before working inside your computer](#).

NOTE: If the system is shipped with SSD perform the following steps.

- 2 Remove the:
 - a stand
 - b optical drive
 - c back cover
 - d system board shield
- 3 To remove SSD card:
 - a Remove the M2x2.5 screw that secures the SSD card to the system board [1].
 - b Lift the SSD card away from the connector [2].

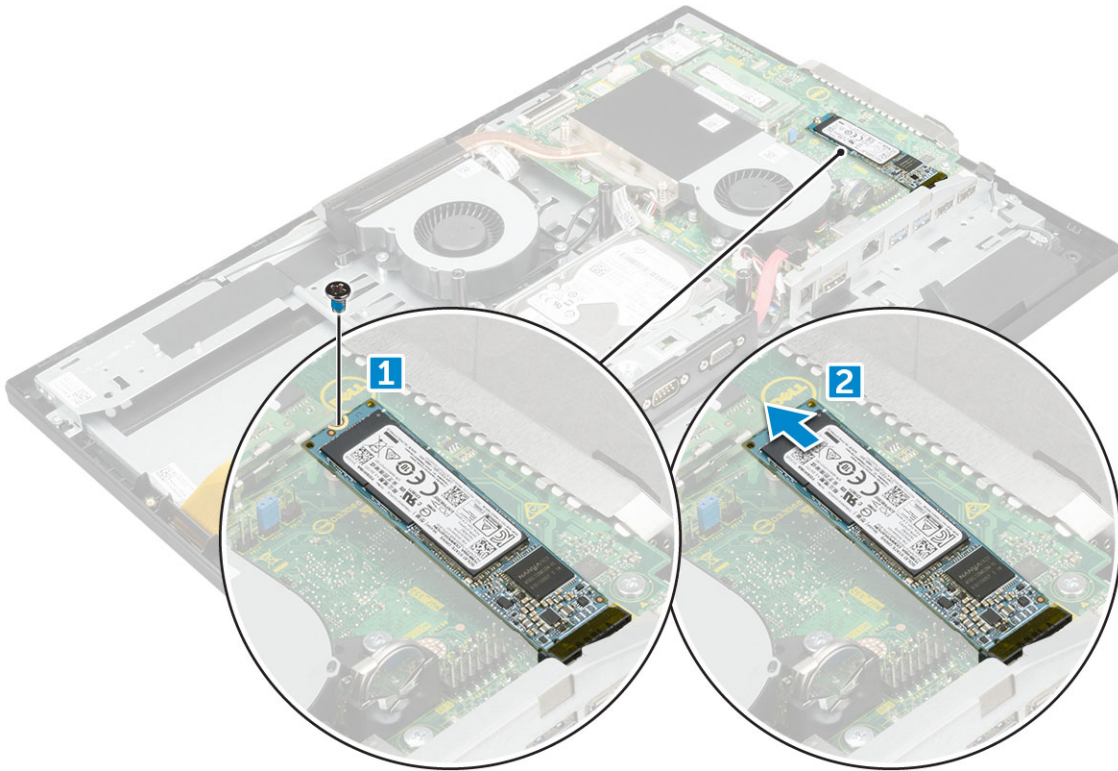

Installing Solid State Drive (SSD) card

- 1 Insert the SSD card to the connector on the system board.
 - NOTE:** If the system is shipped with SSD perform the following steps.
- 2 Replace the screw to secure the SSD card to the system board.
- 3 Install the:
 - a system board shield
 - b back cover
 - c optical drive
 - d stand
- 4 Follow the procedure in [After working inside your computer](#).

WLAN card

Removing WLAN card

- 1 Follow the procedure in [Before working inside your computer](#).
- 2 Remove the:
 - a stand
 - b optical drive
 - c back cover
 - d system board shield
- 3 To remove WLAN card:
 - a Disconnect the antenna cables from the connectors on the WLAN card [1].
 - b Remove the M2x 2.5 screw that secures the WLAN card to the system board [2].



- c Hold the WLAN card, and pull it from the connector on the system board [3].

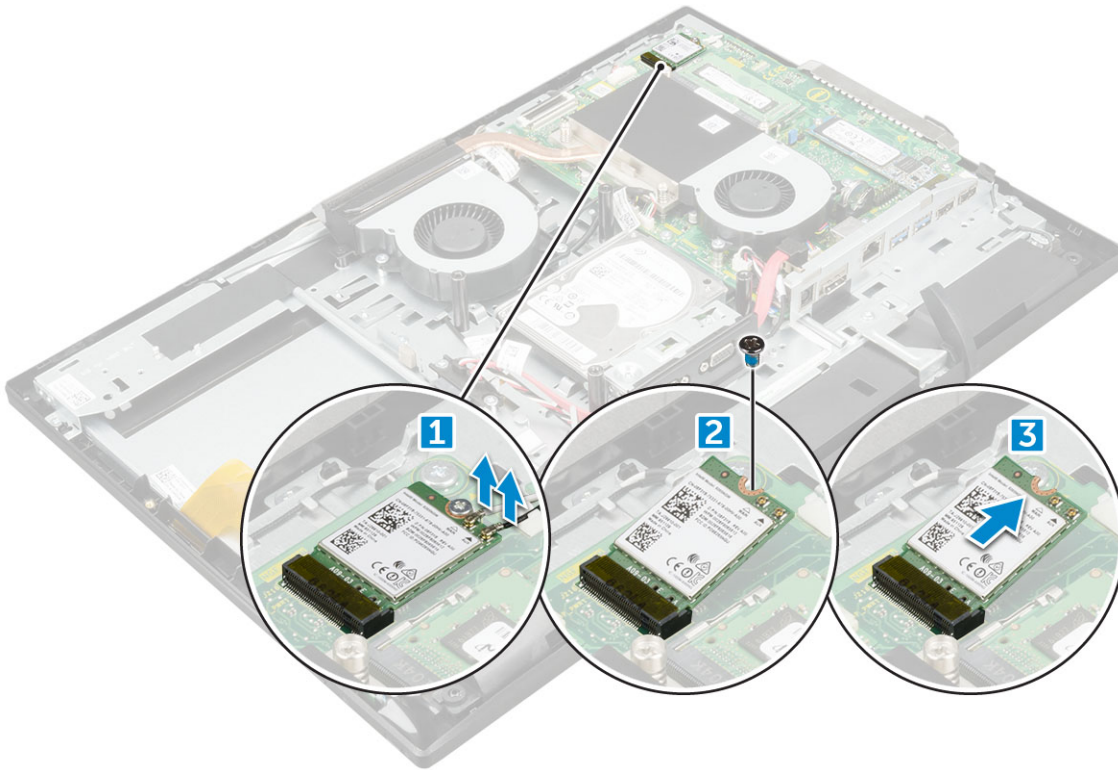

Installing WLAN card

- 1 Align and then insert the WLAN card to the connector on the system board.
- 2 Replace the M2x2.5 screw to secure the WLAN card to the system board.

NOTE: Best practise: Connect the cables and then insert the card into the slot.

- 3 Connect the antenna cables to the connectors on the WLAN card.
- 4 Install the:
 - a system board shield
 - b back cover
 - c optical drive
 - d stand
- 5 Follow the procedure in [After working inside your computer](#).

Heat sink

Removing heat sink

- 1 Follow the procedure in [Before working inside your computer](#).
- 2 Remove the:
 - a stand
 - b optical drive
 - c back cover
 - d system board shield
- 3 To remove heat sink:

- a Remove the screw M2x2.5 that secures the heat sink to the chassis [1].
- b Loosen the captive screws that secure the heat sink to the system board [2].

NOTE: Remove the screws that secure the heat sink to the system board in the order of the callouts shown on the heat sink [1, 2, 3, 4].

- c Lift the heat sink away from the computer [3].

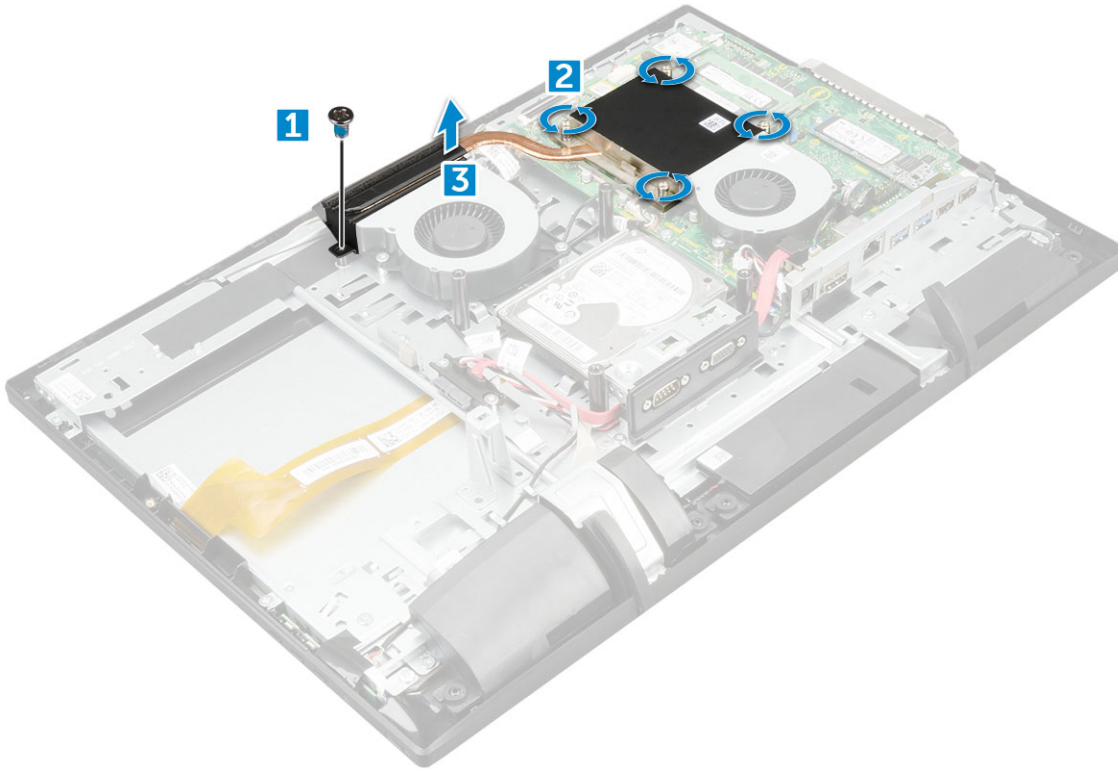

Installing heat sink

- 1 Place the heat sink on the system board and align it with the screw holders.
- 2 Replace the screws to secure the heat sink to the system board.

NOTE: Tighten the screws that secure the heat sink to the system board in the order of the callouts shown on the heat sink [1, 2, 3, 4].

- 3 Replace the M2x2.5 screw to secure the heat sink to the chassis.
- 4 Install the:
 - a system board shield
 - b back cover
 - c optical drive
 - d stand
- 5 Follow the procedure in [After working inside your computer](#).

System fan

Removing system fan (35 W optional)

- 1 Follow the procedure in [Before working inside your computer](#).
- 2 Remove the:



- a stand
 - b optical drive
 - c back cover
 - d system board shield
- 3 To remove system fan:
- a Disconnect the system fan cable [1].
 - b Remove the M3.5x5 screws that secure the system fan to the system board [2].
 - c Lift the system fan away from the computer [3].

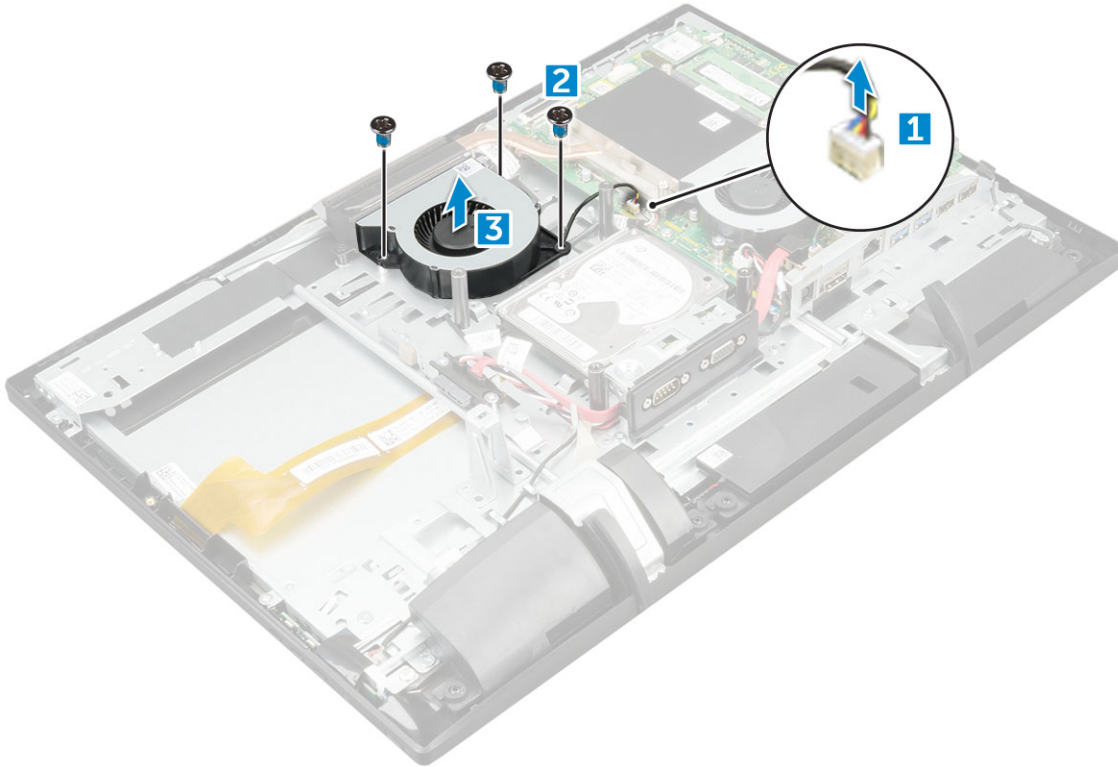

Installing system fan (35 W optional)

- 1 Place the system fan to align with the screw holders on the chassis.
- 2 Replace the M3.5x5 screws to secure the system fan to the chassis.
- 3 Connect the system fan cable to the connector on the system board.
- 4 Install the:
 - a system board shield
 - b back cover
 - c optical drive
 - d stand
- 5 Follow the procedure in [After working inside your computer](#).

Removing system fan (65 W)

- 1 Follow the procedure in [Before working inside your computer](#).
- 2 Remove the:
 - a stand
 - b optical drive

- c back cover
 - d system board shield
- 3 To remove system fan:
- a Disconnect the system fan cable [1].
 - b Remove the M3.5x5 screws that secure the system fan to the system board [2].
 - c Lift the system fan away from the computer [3].

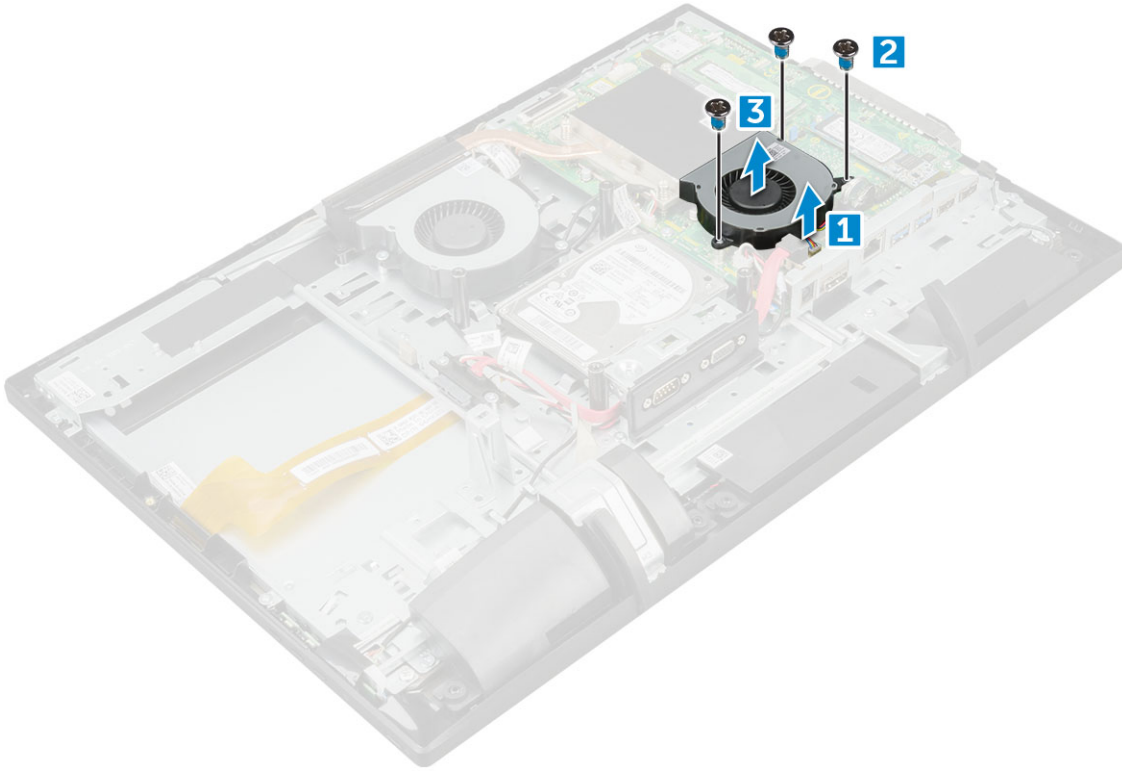

Installing system fan (65 W)

- 1 Place the system fan to align with the screw holders on the chassis.
- 2 Replace the M3.5x5 screws to secure the system fan to the chassis.
- 3 Connect the system fan cable to the connector on the system board.
- 4 Install the:
 - a system board shield
 - b back cover
 - c optical drive
 - d stand
- 5 Follow the procedure in [After working inside your computer](#).

Power and On-Screen Display

Removing power and On-Screen Display (OSD) board

- 1 Follow the procedure in [Before working inside your computer](#).
- 2 Remove the:
 - a stand
 - b optical drive



- c [back cover](#)
- 3 To remove OSD board:
- a Peel off the adhesive tapes from the OSD board [1].
 - b Turn over OSD board to access the cable [2].
 - c Disconnect the cable from the power and OSD board to release the board from the computer [3].

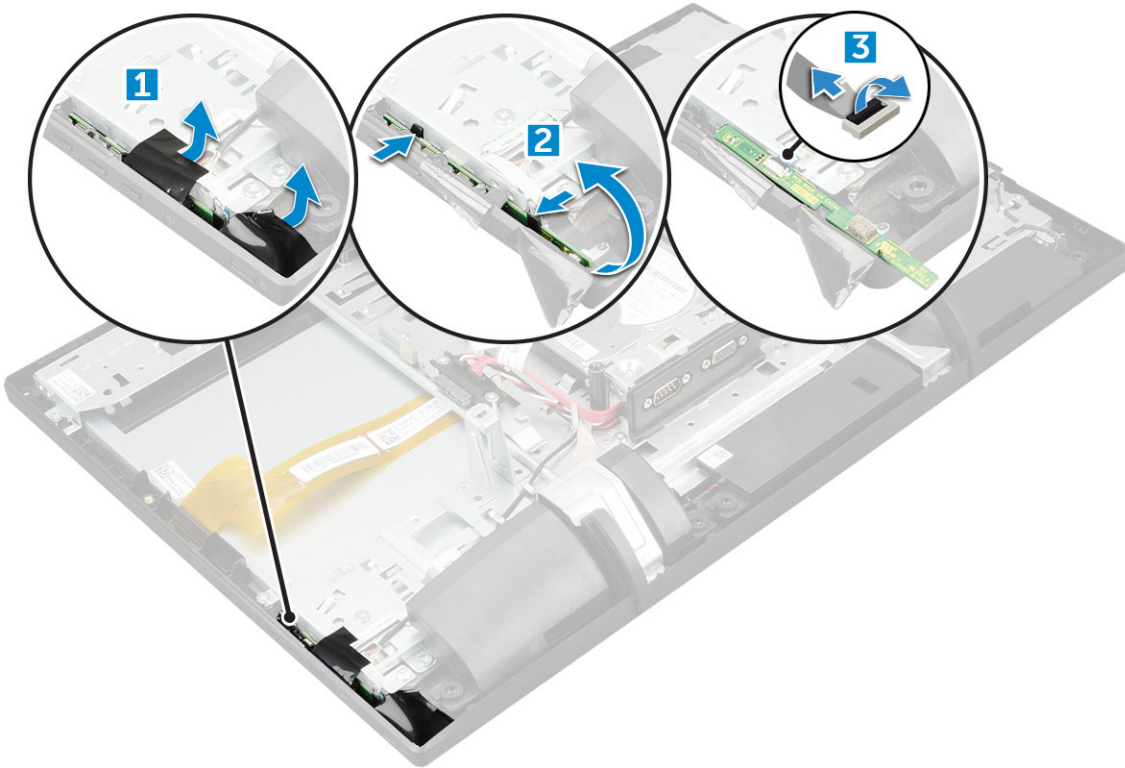

Installing power and On-Screen Display (OSD) board

- 1 Connect the OSD cable to the power and OSD board.
- 2 Insert the power and OSD board into the slot.
- 3 Affix the adhesive tapes on the OSD board.
- 4 Install the:
 - a [back cover](#)
 - b [optical drive](#)
 - c [stand](#)
- 5 Follow the procedure in [After working inside your computer](#).

Speaker

Removing speaker

- 1 Follow the procedure in [Before working inside your computer](#).
- 2 Remove the:
 - a [stand](#)
 - b [optical drive](#)
 - c [back cover](#)
 - d [system board shield](#)

- 3 To remove speaker cover:
- a Remove the M2x2.5 screws that secure the speaker cover to the computer [1].
 - b Lift the speaker cover away from the computer [2].

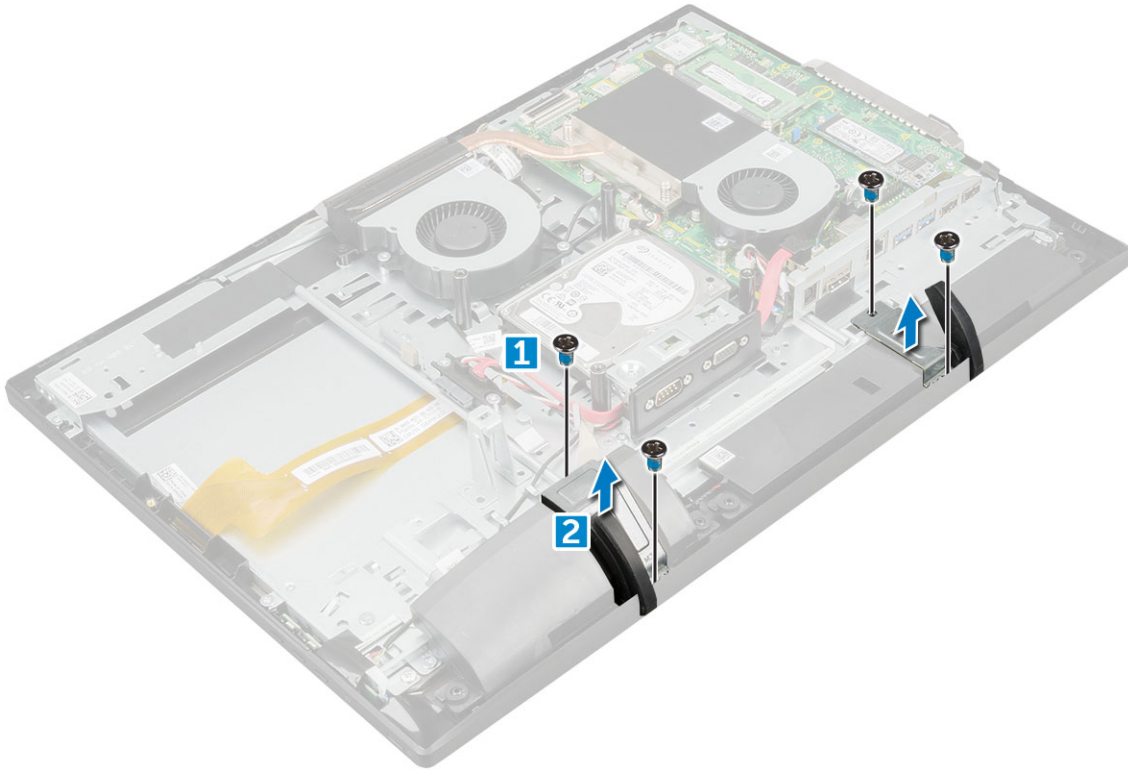

- 4 To remove speaker:
- a Disconnect the speaker cable from the system board [1].
 - b Unthread the speaker cable from the retention clips [2].
 - c Lift the speaker module away from the computer [3].

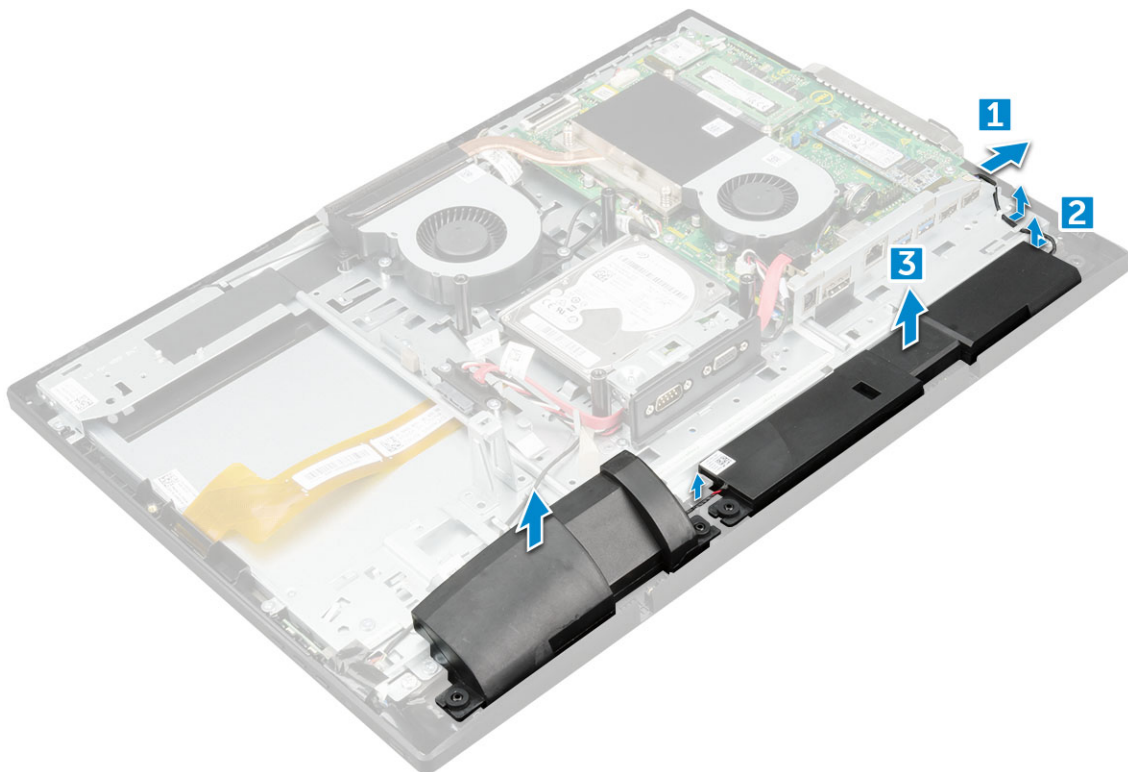

Installing speaker

- 1 Align and place the speaker into the slot on the chassis.
- 2 Route the speaker cables through the retention clips.
- 3 Connect the speaker cable to the connector on the system board.
- 4 Align the speaker cover to its position on the back of the computer.
- 5 Replace the M2x2.5 screws to secure the speaker cover to the computer.
- 6 Install the:
 - a [system board shield](#)
 - b [back cover](#)
 - c [optical drive](#)
 - d [stand](#)
- 7 Follow the procedure in [After working inside your computer](#).

VGA/Serial port (optional)

Removing VGA/serial port (optional)

- 1 Follow the procedure in [Before working inside your computer](#).
- 2 Remove the:
 - a [stand](#)
 - b [optical drive](#)
 - c [back cover](#)
 - d [system board shield](#)
- 3 To remove VGA/serial port:
 - a Disconnect VGA/serial port and SATA cables from the system board [1,2]
 - b Remove the M2x2.5 screws that secure VGA/serial port on the computer [3].
 - c Lift the VGA/serial port away from the computer [4].

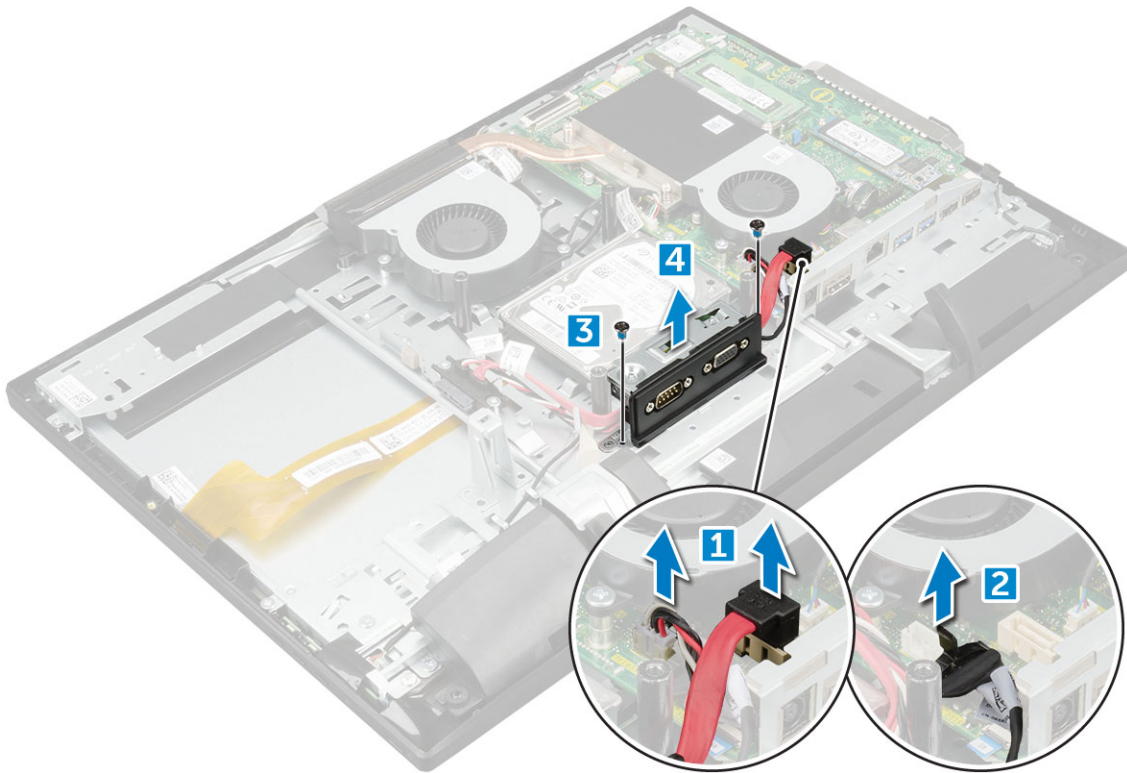

Installing VGA/serial port (optional)

- 1 Align and place the VGA/serial port in the slot on the chassis.
- 2 Replace the M2x2.5 screws to secure the VGA/serial port on the computer.
- 3 Connect the VGA/serial port and SATA ODD cables to the connector on the system board.
- 4 Install the:
 - a system board shield
 - b back cover
 - c optical drive
 - d stand
- 5 Follow the procedure in [After working inside your computer](#).

Processor

Removing processor

- 1 Follow the procedure in [Before working inside your computer](#).
- 2 Remove the:
 - a stand
 - b optical drive
 - c back cover
 - d system board shield
 - e heat sink
- 3 To remove processor:
 - a Release the socket lever by pushing the lever down and out from under the tab on the processor shield [1].
 - b Lift the lever upward, and lift the processor shield [2].



CAUTION: The processor socket pins are fragile and can be permanently damaged. Be careful not to bend the pins in the processor socket when removing the processor out of the socket.

- c Lift the processor out of the socket [3].

CAUTION: After removing the processor, place it in an antistatic bag for reuse, return, or temporary storage. Do not touch the pins of the processor to avoid damage to the processor contacts. Touch only the side edges of the processor.

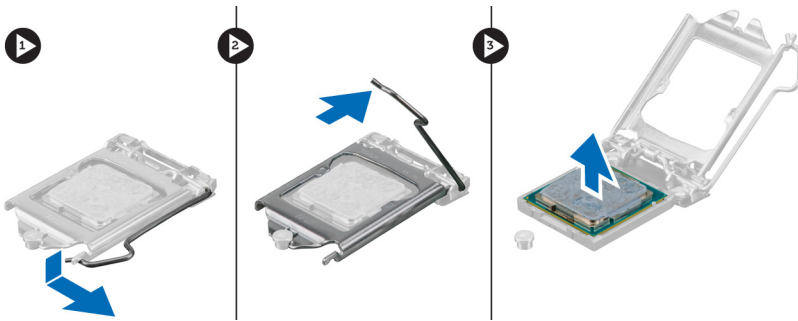

Installing processor

- 1 Align the processor with the socket keys on the connector.

CAUTION: Do not use force to seat the processor. When the processor is positioned correctly, it engages easily into the socket

- 2 Align the pin-1 indicator of the processor with the triangle on the socket.
- 3 Place the processor on the socket such that the slots on the processor align with the socket keys.
- 4 Close the processor shield by sliding it under the retention screw.
- 5 Lower the socket lever and push it under the tab to lock it.
- 6 Install the:
 - a heat sink
 - b system board shield
 - c back cover
 - d optical drive
 - e stand
- 7 Follow the procedure in [After working inside your computer](#).

System board

Removing system board

- 1 Follow the procedure in [Before working inside your computer](#).
- 2 Remove the:
 - a stand
 - b optical drive
 - c back cover
 - d hard drive
 - e system board shield
 - f coin cell battery
 - g SSD card
 - h memory module
 - i WLAN card

- j heat sink
- k system fan
- l processor

- 3 Disconnect following cables:
- a SATA ODD cable [1]
 - b VGA serial cable [2]
 - c VGA cable [3]
 - d Speaker cable [4]
 - e LCD link bar cable [5]
 - f LCD assembly [6]

NOTE: Press the clips to release the assembly from the chassis, to avoid damage while removing the cable.

- g Heat sink cable [7]
- h LCD assembly [8]

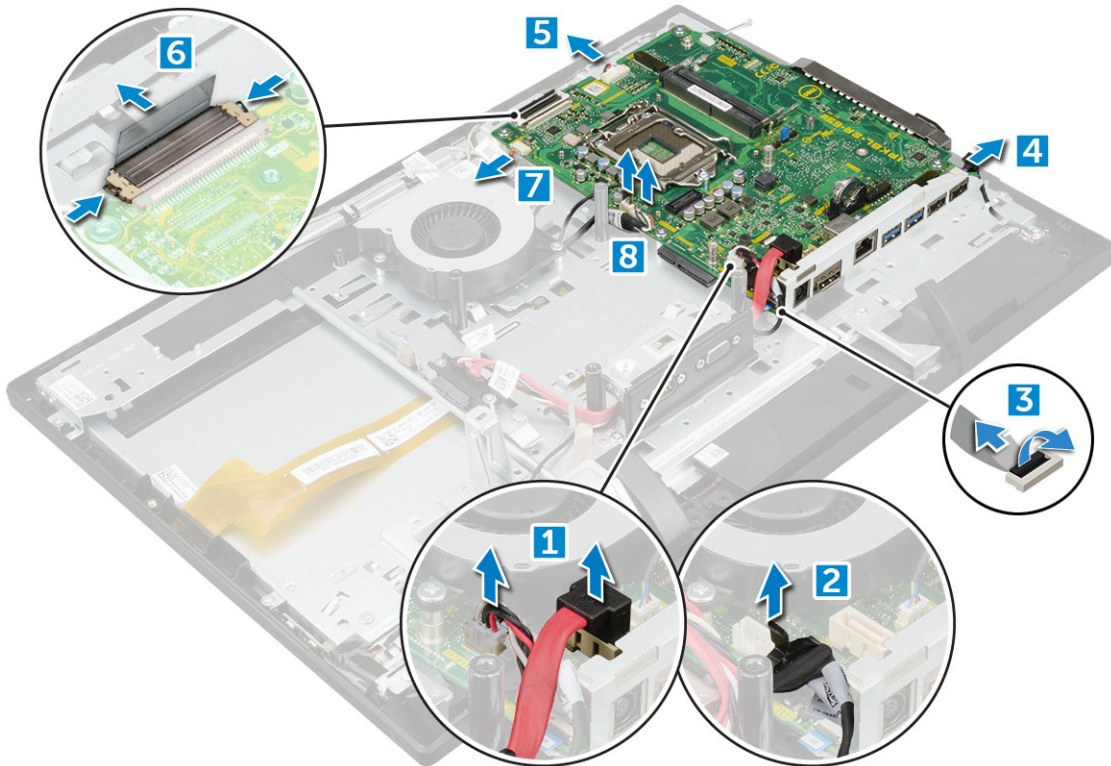

- 4 To remove system board:
- a Remove M3 0.5x5 screws that secure the system board to release it from the chassis [1]
 - b Slide the system board from the chassis [2].

NOTE: Pull the system board metal shield on both sides while removing the system board chassis.

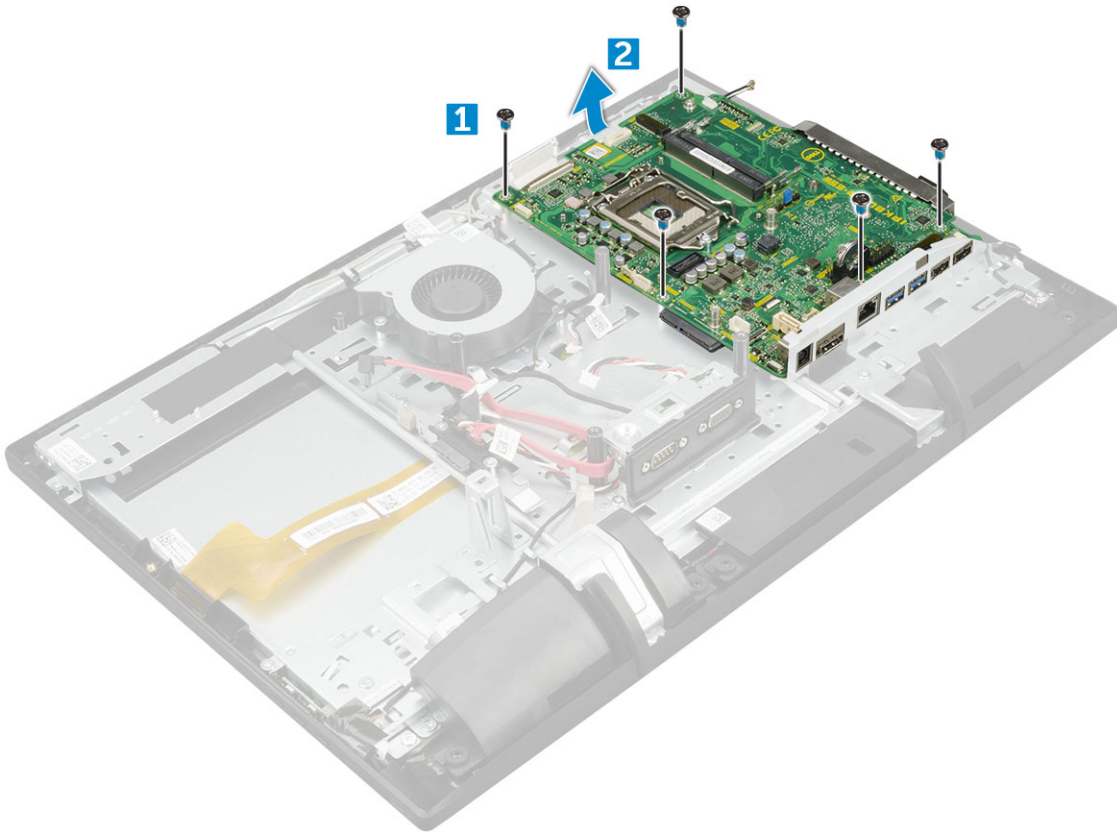

5 Remove the system board.

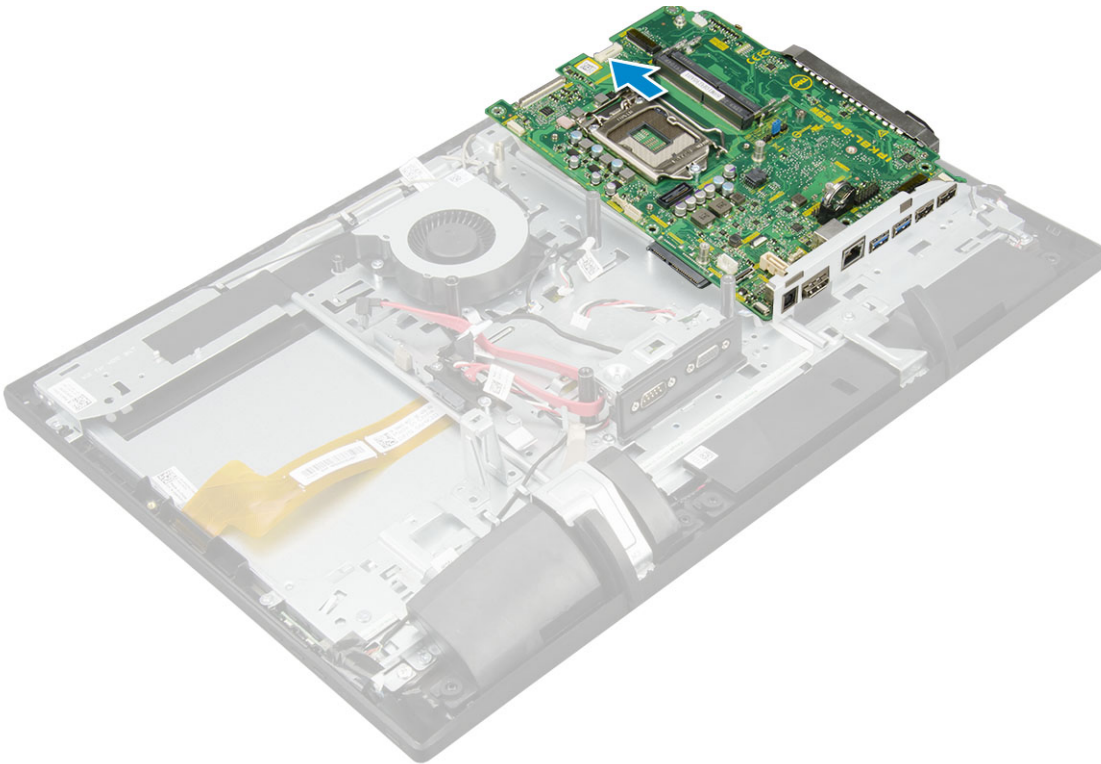

Installing system board

- 1 Place and push the system board to slide into the metal shield of the system board chassis.
- 2 Replace the screws to secure the system board to the computer.
- 3 Connect the following cables to the system board:
 - a LCD assembly cable
 - b Heat sink cable
 - c LCD assembly cable
 - d LCD link bar cable
 - e Speaker cable
 - f VGA serial cable
 - g VGA cable
 - h SATA ODD cable
- 4 Install the:
 - a [processor](#)
 - b [system fan](#)
 - c [heat sink](#)
 - d [WLAN card](#)
 - e [memory module](#)
 - f [SSD card](#)
 - g [coin cell battery](#)
 - h [system board shield](#)
 - i [hard drive](#)
 - j [back cover](#)
 - k [optical drive](#)
 - l [stand](#)
- 5 Follow the procedure in [After working inside your computer](#).

Chassis frame

Removing chassis frame

- 1 Follow the procedure in [Before working inside your computer](#).
- 2 Remove the:
 - a [stand](#)
 - b [optical drive](#)
 - c [back cover](#)
 - d [hard drive](#)
 - e [system board shield](#)
 - f [cable holder](#)
 - g [memory module](#)
 - h [coin cell battery](#)
 - i [SSD card](#)
 - j [WLAN card](#)
 - k [heat sink](#)
 - l [processor](#)
 - m [system fan](#)
 - n [OSD board](#)
 - o [speaker](#)
 - p [graphics card assembly](#)



q system board

3 Press the latch to unroute the cable [1,2]

NOTE: Press the plastic latch to release the cable from the receptacle.

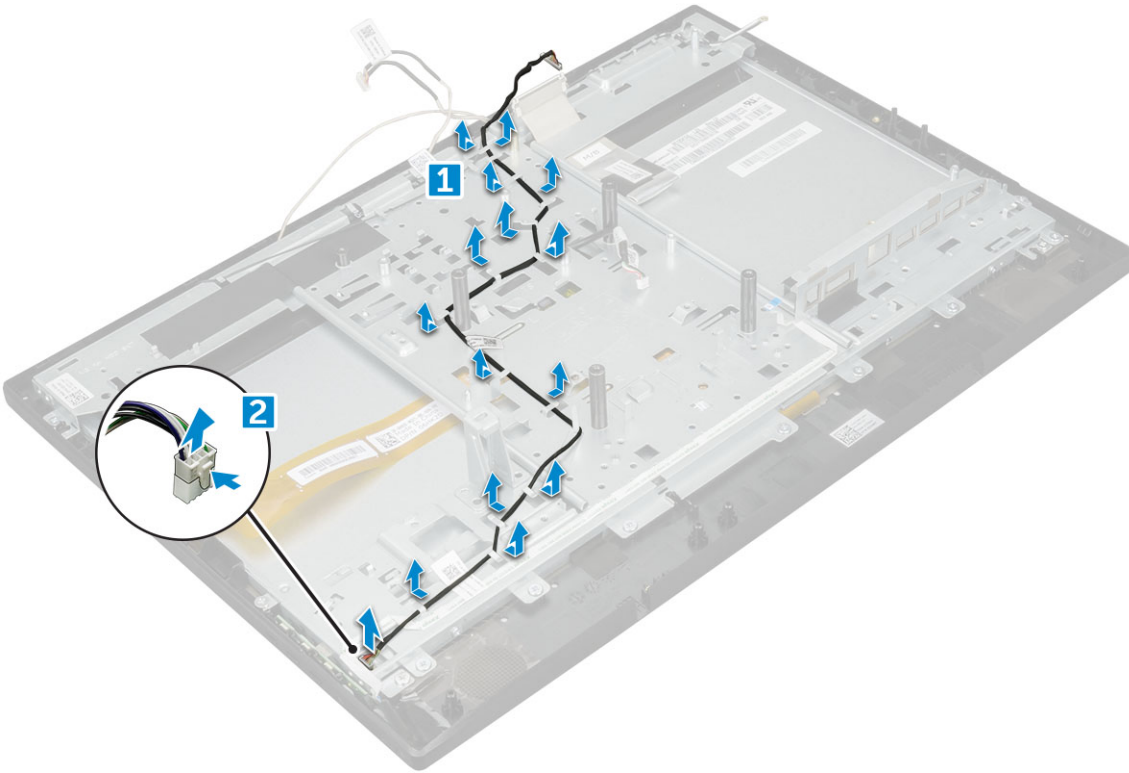

4 Unroute the WLAN cable [1] and peel the OSD cable [2].

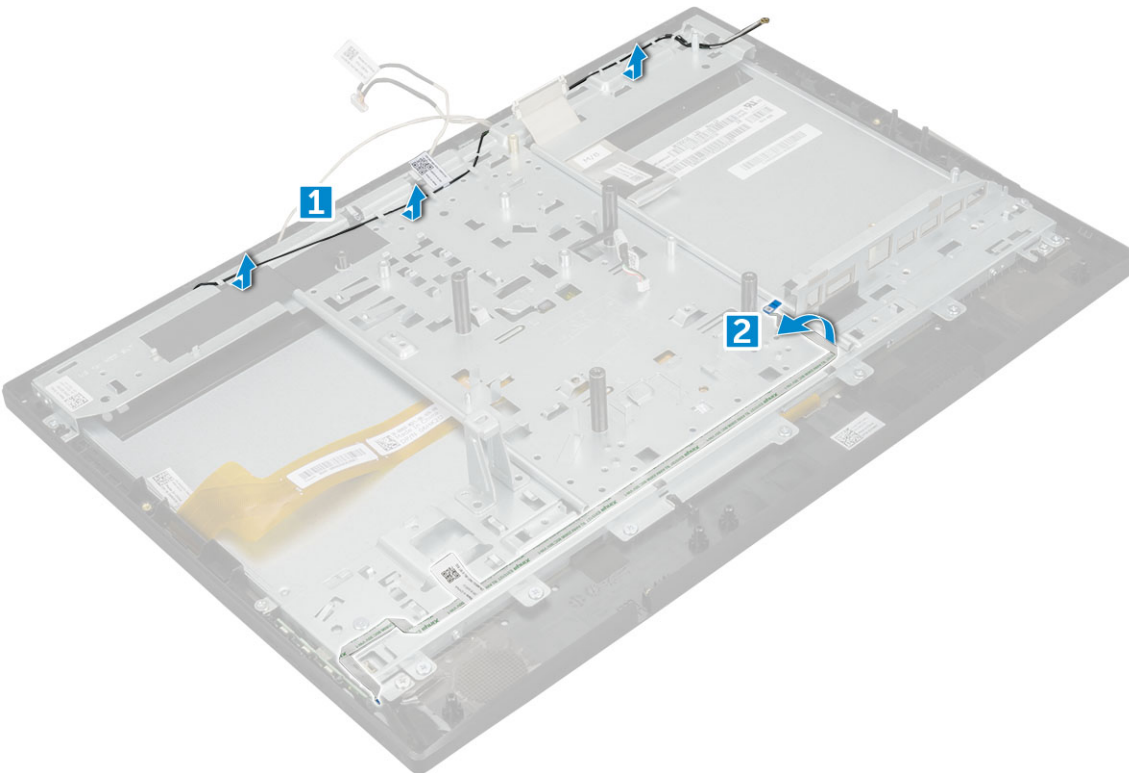

5 Remove the M3 0.5x5 screws, and lift the chassis frame from the display assembly.

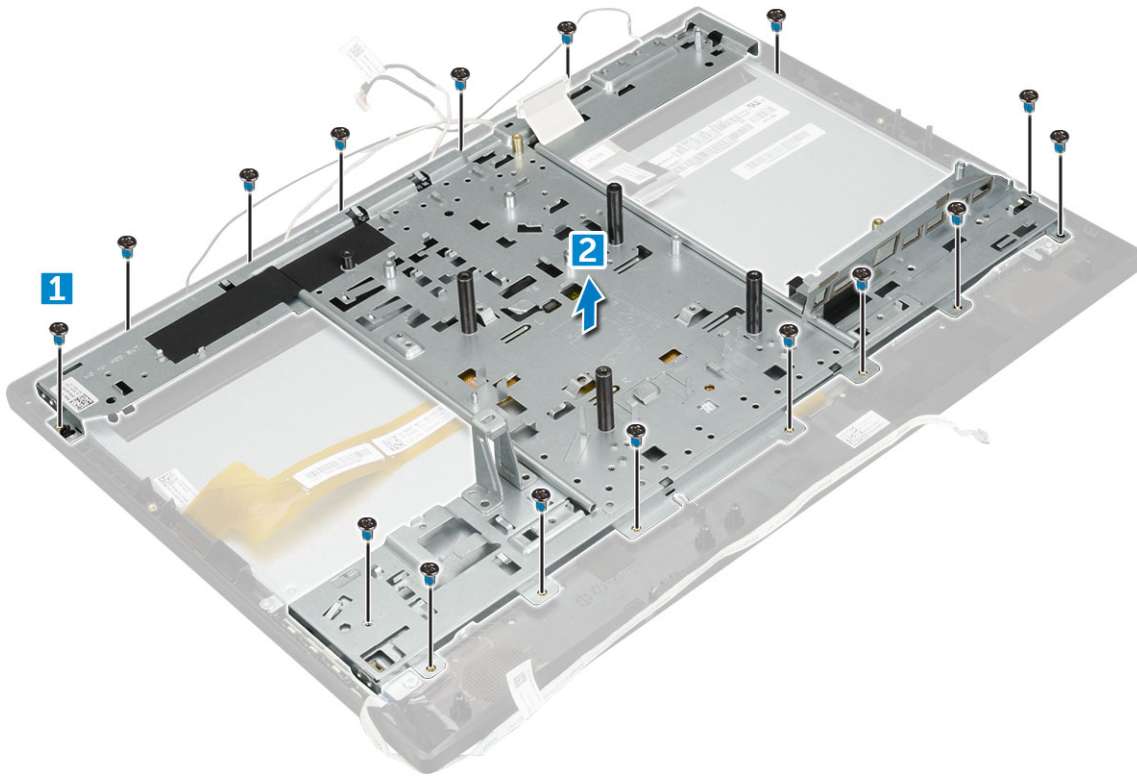

Installing chassis frame

- 1 Align and place the chassis frame on the display assembly.
- 2 Replace the M3 0.5x5 screws to secure the chassis frame to the display assembly.
- 3 Route the cables to the chassis frame.
- 4 Install the:
 - a system board
 - b graphics card assembly
 - c speaker
 - d OSD board
 - e system fan
 - f processor
 - g heat sink
 - h WLAN card
 - i SSD card
 - j coin cell battery
 - k memory module
 - l cable holder
 - m system board shield
 - n hard drive
 - o back cover
 - p optical drive
 - q stand
- 5 Follow the procedure in [After working inside your computer](#).

Display assembly

Removing display assembly

- 1 Follow the procedure in [Before working inside your computer](#).
- 2 Remove the:
 - a stand
 - b optical drive
 - c back cover
 - d hard drive
 - e system board shield
 - f cable holder
 - g memory module
 - h coin cell battery
 - i SSD card
 - j WLAN card
 - k heat sink
 - l processor
 - m system fan
 - n OSD board
 - o speaker
 - p graphics card assembly
 - q system board
 - r chassis frame
- 3 To disconnect the cable:
 - a Peel off the adhesive tapes that secure the display panel [1].
 - b Disconnect the touch and eDP cable from the board [2].

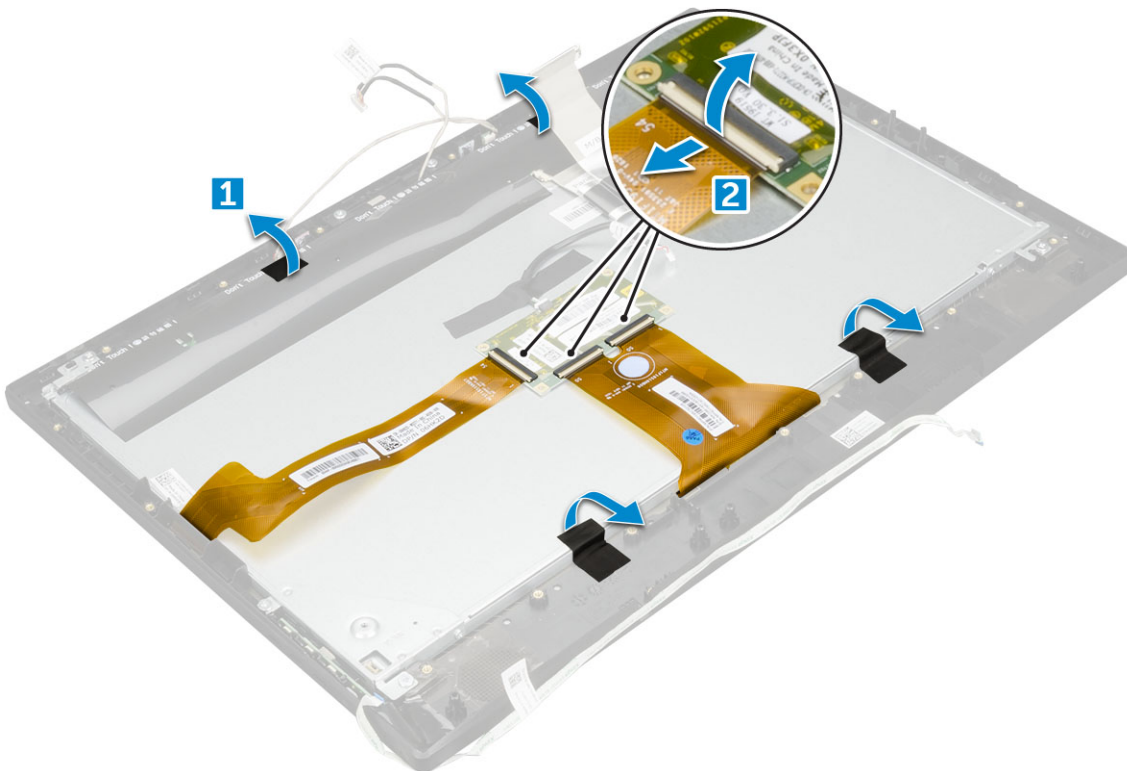

- 4 To remove display assembly:

- a Remove the M3x3.7 screws that secure the display assembly to the chassis [1].
- b Lift the display assembly away from the computer [1]

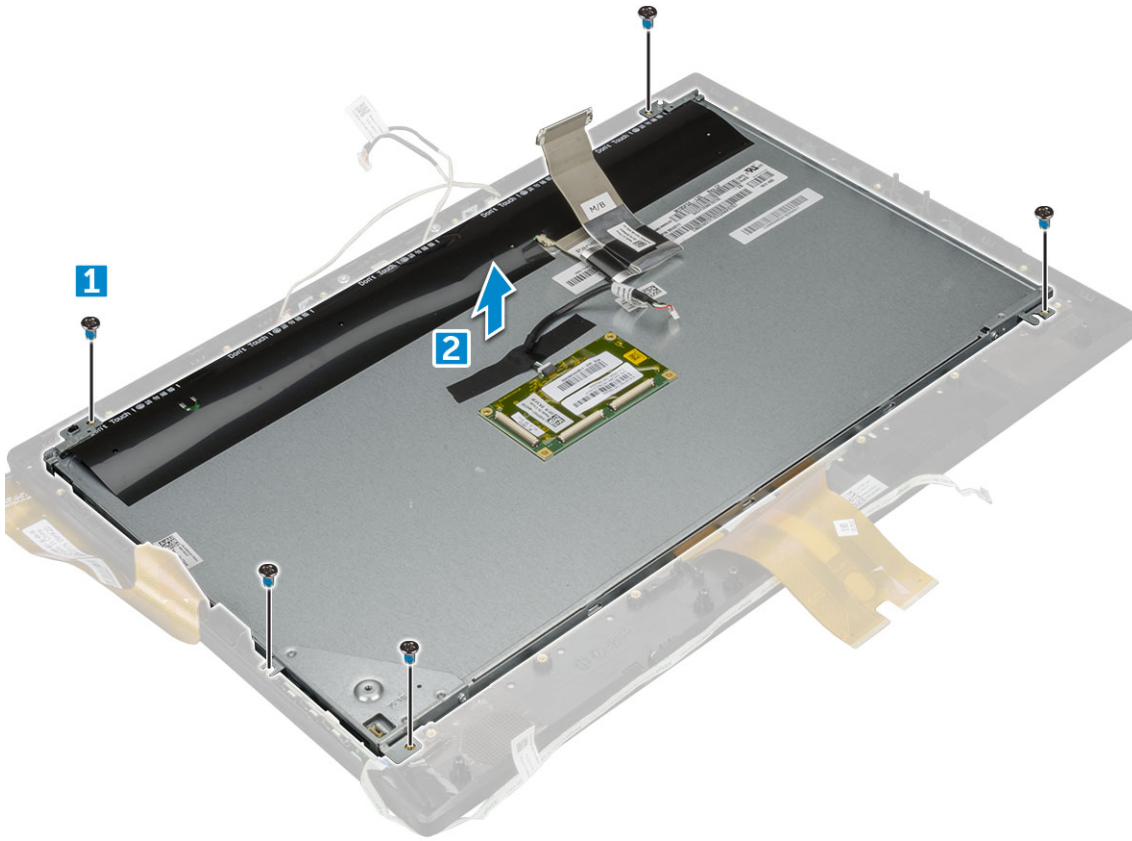

Installing display assembly

- 1 Place the chassis display assembly on the chassis.
- 2 Replace the M3x3.7 screws to secure the display assembly to the computer.
- 3 Connect the touch and eDP cable.
- 4 Affix the adhesive tapes to secure the display assembly.
- 5 Install the:
 - a chassis frame
 - b system board
 - c graphics card assembly
 - d speaker
 - e OSD board
 - f system fan
 - g processor
 - h heat sink
 - i WLAN card
 - j SSD card
 - k coin cell battery
 - l memory module
 - m cable holder
 - n system board shield
 - o hard drive
 - p back cover
 - q optical drive



r stand

- 6 Follow the procedure in [After working inside your computer](#).

Camera

Removing camera

- 1 Follow the procedure in [Before working inside your computer](#).
- 2 Remove the:
 - a stand
 - b optical drive
 - c back cover
 - d hard drive
 - e system board shield
 - f cable holder
 - g memory module
 - h coin cell battery
 - i SSD card
 - j WLAN card
 - k heat sink
 - l processor
 - m system fan
 - n OSD board
 - o speaker
 - p graphics card assembly
 - q system board
 - r chassis frame
 - s display assembly
- 3 To remove camera:
 - a Remove the M3 0.5x5 screws that secure the camera [1].
 - b Disconnect the camera cables [2].
 - c Remove the camera module [3, 4].

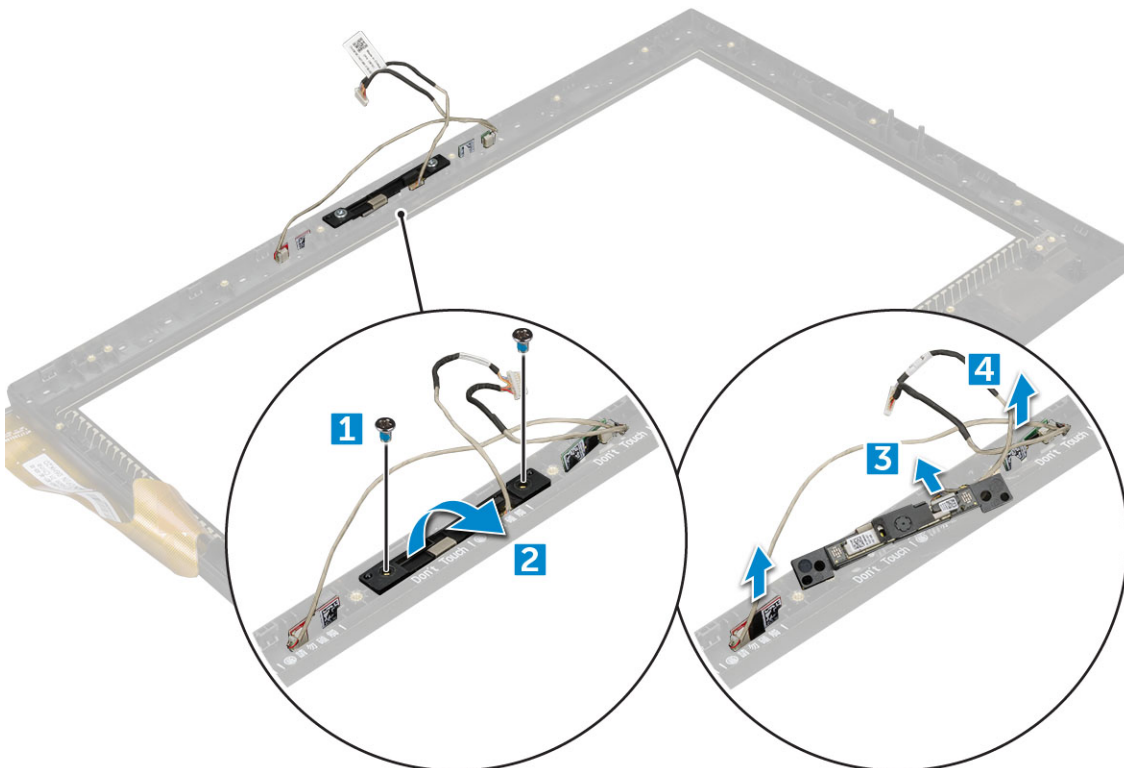

Installing camera

- 1 Align and place the camera module on the display frame on the computer.
- 2 Connect the camera cables.
- 3 Tighten the M3 0.5x5 screws to secure the camera to the computer.
- 4 Install the:
 - a display assembly
 - b chassis frame
 - c system board
 - d graphics card assembly
 - e speaker
 - f OSD board
 - g system fan
 - h processor
 - i heat sink
 - j WLAN card
 - k SSD card
 - l coin cell battery
 - m memory module
 - n cable holder
 - o system board shield
 - p hard drive
 - q back cover
 - r optical drive
 - s stand
- 5 Follow the procedure in [After working inside your computer](#).

M.2 Intel Optane Memory Module 16 GB

Overview

This document describes the specifications and capabilities of the Intel® Optane™ memory module. The Intel® Optane™ memory is a system acceleration solution developed for 7th Generation Intel® Core™ processor-based platforms. The Intel® Optane™ memory module is architected with the high performance controller interface Non-Volatile Memory Express (NVMe*)- delivering outstanding performance, low latency and quality of service. NVMe uses a standardized interface that enables higher performance and lower latency than previous interfaces. Intel® Optane™ memory module offers capacities of 16 GB and 32 GB in small M.2 form factors.

The Intel® Optane™ memory module offers a system acceleration solution using the latest Intel® Rapid Storage Technology (Intel® RST) 15.5X.

The Intel® Optane™ memory module includes these key features:

- PCIe 3.0x2 with NVMe interface
- Uses Intel's revolutionary new storage technology, 3D Xpoint™ memory media
- Ultra-low latency; exceptional responsiveness
- Performance saturation at queue depth of 4 and lower
- Very high endurance capabilities



Intel® Optane™ Memory Module Driver Requirements

The following table describes the driver requirements for the Intel® Optane™ memory system acceleration as a component of Intel® Rapid Storage Technology 15.5 or later and requires 7th generation Intel® Core™ processor-based platforms to function.

Table 1. Driver Support

Support Level	Operating System Description
Intel® Optane™ Memory with System Acceleration Configuration Using Rapid Storage Technology Driver ¹	Windows 10*64 bit

NOTES:

- 1 Intel® RST driver requires device to be attached to RST enabled PCIe lanes on 7th generation Intel® Core™.

Installing M.2 Intel Optane Memory Module 16 GB

- 1 Follow the procedure in [Before working inside your computer](#).

NOTE: Systems built/shipped before June/20/2017 require the below installation steps.

- 2 Remove the:
 - a stand
 - b optical drive
 - c back cover
 - d system board shield
 - e SSD (optional)
- 3 To remove M.2 Intel optane memory module:
 - a Remove the thermal pad and white adhesive tape from the box.

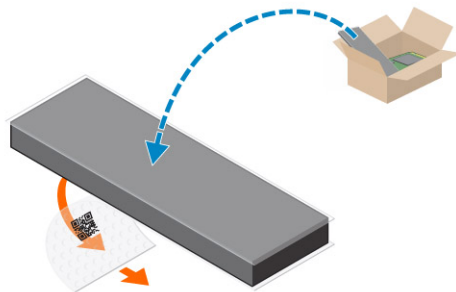

- b Place the thermal pad on the SSD slot and remove the white adhesive tape.

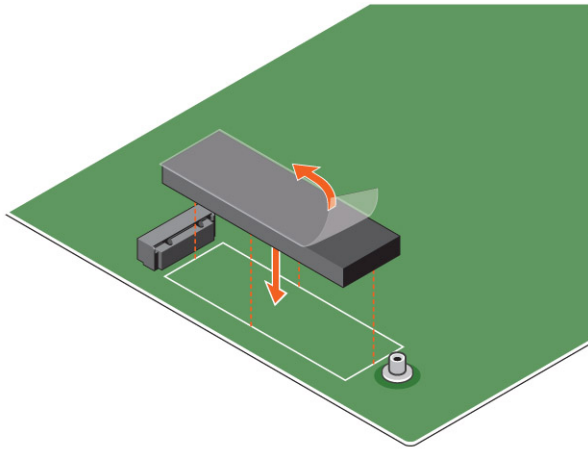

c Place the M.2 Intel optane memory module into the slot on the thermal pad.

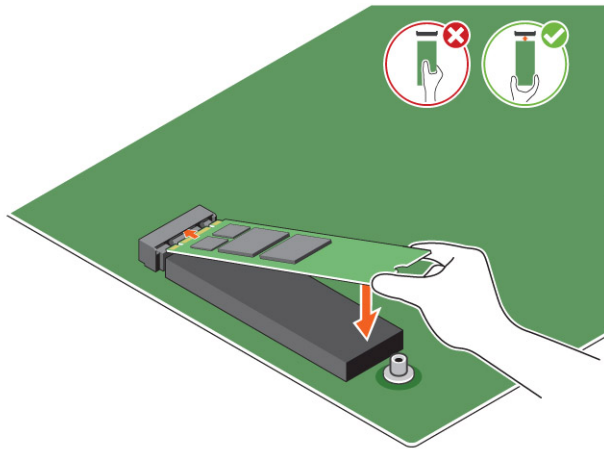

d Tighten the screw that secures the M.2 Intel optane memory module on the computer.

4 Install the:

- a [system board shield](#)
- b [back cover](#)
- c [optical drive](#)
- d [stand](#)

Product specifications

Table 2. Product specifications

Features	Specification
Capacities	16 GB, 32 GB
Expansion cards	PCIe 3.0 x 2
M.2 form factors (all densities)	2280–S3–B–M
Performance	<ul style="list-style-type: none"> • Seq R/W: Up to 1350/290 MS/s • QD4 4HB Random Read: 240K + IOPs • QD4 4HB Random Write: 240K + IOPs
Latency (average sequential)	<ul style="list-style-type: none"> • Read 8.25 μ



Components	<ul style="list-style-type: none"> • Write: 30 μ • Intel 3D XPoint Memory Media • Intel Controller and Firmware • PCIe 3.0x2 with NVMe Interface • Intel Rapid Storage Technology 15.2 or later
Operating System Support	Windows 10 64 bit
Supported Platforms	7th generation or newer Intel Core processor based platforms
Power	<ul style="list-style-type: none"> • 3.3V Supply Rail • Active: 3.5 W • Drive Idle :900mW to 1.2W
Compliance	<ul style="list-style-type: none"> • NVMe Express 1.1 • PCI Express Base specification rev 3.0 • PCI M.2 HS Spec
Certification and Declarations μ	UL, CE, C-Tick, BSMI, KCC, Microsoft WHQL, Microsoft WHCK, VCCI
Endurance Rating	<ul style="list-style-type: none"> • 100 GB Writes per day • Upto 182.3 TBW (Terabytes written)
Temperature Specification	<ul style="list-style-type: none"> • Operating: 0 to 70$^{\circ}$ C • Non-Operating: 10 to 85$^{\circ}$ C • Temperature monitoring
Shock	1500 G/0.5msec
Vibration	<ul style="list-style-type: none"> • Operating: 2.17 G_{RMS}(5–800Hz) • Non-Operating: 3.13 G_{RMS} (5–800Hz)
Altitude (Simulated)	<ul style="list-style-type: none"> • Operating: –1,000 ft to 10,000 ft • Non-Operating: –1,000 ft to 40,000 ft
Product Ecological Compliance	RoHS
Reliability	<ul style="list-style-type: none"> • Uncorrectable Bit Error Rate (UBER): 1 sector per 10¹⁵ bits read • Mean Time Between Failure (MTBF): 1.6 million hours

Environmental Conditions

Table 3. Temperature, Shock, Vibration

Temperature	M.2 2280 form factor
Operating ¹	0–70 $^{\circ}$ C
Non-operating ²	-10–85 $^{\circ}$ C
Temperature Gradient ³	30 $^{\circ}$ C/hr (Typical)



Operating	30° C/hr (Typical)
Non-operating	
Humidity	
Operating	5–95%
Non-operating	5–95%
Shock and Vibration	Range
Shock ⁴	
Operating	1500 G / 0.5 ms
Non-operating	230 G / 3 msec
Vibration ⁵	
Operating	2.17 G _{RMS} (5–800Hz) Max
Non-operating	3.13 G _{RMS} (5–800Hz) Max

NOTES:

- 1 Operating temperature is targeted for 70° C.
- 2 Please contact your Intel representative for details on the non-operating temperature range.
- 3 Temperature gradient measured without condensation.
- 4 Shock specification assume the device is mounted securely with the input vibration applied to the drive-mounting screws. Stimulus may be applied in the X,Y, or Z axis and shock specification is measured using Root Mean Squared (RMS) value.
- 5 Vibration specifications assume the device is mounted securely with the input vibration applied to the drive-mounting screws. Stimulus may be applied in the X, Y, or Z axis. Vibration specificities is measured using RMS value.

Troubleshooting

- 1 The Intel Optane Memory model name "NVME INTEL MEMPEK1W01" in Device Manager does not match in the Intel Rapid Storage Technology user interface; it only shows a part of the serial number information. This is a known issue and does not impede the functionality of the Intel Optane Memory.

Device Manager: NVME INTEL MEMPEK1W01

IRST UI: INTEL MEMPEK1W016GA

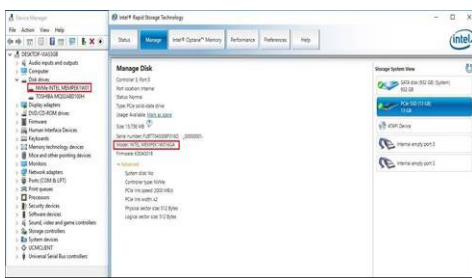

- 2 During the first-time boot up, the system will scan the pairing status as below screen shot after shutdown. It's working as designed and the message will not appear again in following boot ups.

```
Creating the segment/Node pairs.....done
Total number of segment/Node Pairs.....14497
Writing segment/Node pairs phase 1.....done
Writing segment/Node pairs phase 2.....done
Writing the segment/Node pairs.....done
Total Node Size.....6030
Writing segment heap.....done
```



Technology and components

This chapter details the technology and components available in the system.

Topics:

- [Chipsets](#)
- [Display options](#)
- [Intel HD Graphics](#)
- [Hard drive options](#)
- [USB features](#)
- [Memory features](#)
- [Realtek HD audio drivers](#)

Chipsets

All Desktops communicate with the CPU through the chipset. This system is shipped with the Intel 100 Series chipset.

Identifying chipset in Device Manager on Windows 7

- 1 Click **Start** → **Control Panel** → **Device Manager**.
- 2 Expand **System Devices** and search for the chipset.

Identifying the chipset in Device Manager on Windows 10

- 1 Click inside the **Cortana Search Box** and type **Control Panel** and then click or press **Enter** on the keyboard, for the appropriate search result
- 2 From the **Control Panel**, select **Device Manager**.
- 3 Expand **System Devices** and search for the chipset.

Intel HD Graphics drivers

Verify if the Intel HD Graphics drivers are already installed in the computer.

 **NOTE:** Click **Start** > **Control Panel** > **Device Manager**.

or

Tap Search the web and Windows and type **Device Manager**

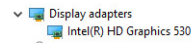

Table 4. Intel HD Graphics drivers

Before installation



After installation



Downloading the chipset driver

- 1 Turn on the computer.
- 2 Go to **Dell.com/support**.
- 3 Click **Product Support**, enter the Service Tag of your computer, and then click **Submit**.

NOTE: If you do not have the Service Tag, use the autodetect feature or manually browse for your computer model.

- 4 Click **Drivers and Downloads**.
- 5 Select the operating system installed in your computer.
- 6 Scroll down the page, expand **Chipset**, and select your chipset driver.
- 7 Click **Download File** to download the latest version of the chipset driver for your computer.
- 8 After the download is complete, navigate to the folder where you saved the driver file.
- 9 Double-click the chipset driver file icon and follow the instructions on the screen.

Downloading drivers

- 1 Turn on the computer.
- 2 Go to **Dell.com/support**.
- 3 Click **Product Support**, enter the Service Tag of your computer, and then click **Submit**.

NOTE: If you do not have the Service Tag, use the auto detect feature or manually browse for your computer model.

- 4 Click **Drivers and Downloads**.
- 5 Select the operating system installed on your computer.
- 6 Scroll down the page and select the driver to install.
- 7 Click **Download File** to download the driver for your computer.
- 8 Navigate to the folder where you saved the driver file, after the download is complete.
- 9 Double-click the driver file icon and follow the instructions on the screen.

Display options

Identifying the display adapter (Windows 7 and Windows 10)

- 1 Start the **Search Charm** and select **Settings**.
- 2 Type `Device Manager` in the search box, and tap **Device Manager** from the left pane.
- 3 Expand **Display adapters**.



Changing the screen resolution (Windows 7 and Windows 10)

- 1 Right click on the desktop and select **Display Settings**.
- 2 Tap or click **Advanced display settings**.
- 3 Select the required resolution from the drop-down list and tap **Apply**.

Adjusting brightness in Windows 7

To enable or disable automatic screen brightness adjustment:

- 1 Click **Start → Control Panel → Display**.
- 2 Use the **Adjust brightness** slider to enable or disable automatic-brightness adjustment.

 **NOTE:** You can also use the **Brightness level** slider to adjust the brightness manually.

Adjusting brightness in Windows 10

To enable or disable automatic screen brightness adjustment:

- 1 Click open **Settings**  from Start menu on Windows 10.
- 2 Click **System → Display**.
- 3 Use the **Adjust brightness level** to adjust the brightness manually.

Connecting to external display devices (Windows 7, 8.1 and 10)

Follow these steps to connect your computer to an external display device:

- 1 Ensure that the projector is turned on and plug the projector cable into a video port on your computer.
- 2 Press the Windows logo+P key.
- 3 Select one of the following modes:
 - PC screen only
 - Duplicate
 - Extend
 - Second Screen only

Intel HD Graphics

This computer is shipped with the following list of Intel HD Graphics chipsets.

- 1 Intel Core i3-6606U Intel HD graphics 520
- 2 Intel Celeron 3865U Intel HD graphics 610
- 3 Intel Pentium 4415U Intel HD graphics 610
- 4 Intel Core i5-7200U Intel HD graphics 620

Intel HD Graphics drivers

Verify if the Intel HD Graphics drivers are already installed in the computer.



 **NOTE:** Click **Start** > **Control Panel** > **Device Manager**.

or

Tap Search the web and Windows and type **Device Manager**

Table 5. Intel HD Graphics drivers

Before installation



After installation

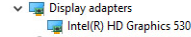

Hard drive options

This computer supports HDD and PCIe SSD.

Identifying the hard drive in Windows 7

- 1 Click **Start** > **Control Panel** > **Device Manager**.
The hard drive is listed under **Disk drives**.
- 2 Expand **Disk drives**.

Identifying the hard drive in Windows 10

- 1 Click inside the **Cortana Search Box** and type **Control Panel** and then click or press **Enter** on the keyboard, for the appropriate search result
- 2 Click **Control Panel**, select **Device Manager**, and expand **Disk drives**.
The hard drive is listed under **Disk drives**.

Entering BIOS setup

- 1 Turn on or restart your laptop.
- 2 When the Dell logo appears, perform the following action to enter the BIOS setup program:
Tap F2 until the **Entering BIOS** setup message appears.

Hard drive is listed under the **System Information** under the **General** group.

- 3 On the left pane, select **Settings** > **General** > **System Information**.
The memory information is displayed on the right pane.

USB features

Universal Serial Bus, or USB, was introduced in 1996. It dramatically simplified the connection between host computers and peripheral devices like mice, keyboards, external drivers, and printers.

Let's take a quick look on the USB evolution referencing to the table below.



Table 6. USB evolution

Type	Data Transfer Rate	Category	Introduction Year
USB 3.0/USB 3.1 Gen 1	5 Gbps	Super Speed	2010
USB 2.0	480 Mbps	High Speed	2000

USB 3.0/USB 3.1 Gen 1 (SuperSpeed USB)

For years, the USB 2.0 has been firmly entrenched as the de facto interface standard in the PC world with about 6 billion devices sold, and yet the need for more speed grows by ever faster computing hardware and ever greater bandwidth demands. The USB 3.0/USB 3.1 Gen 1 finally has the answer to the consumers' demands with a theoretically 10 times faster than its predecessor. In a nutshell, USB 3.1 Gen 1 features are as follows:

- Higher transfer rates (up to 5 Gbps)
- Increased maximum bus power and increased device current draw to better accommodate power-hungry devices
- New power management features
- Full-duplex data transfers and support for new transfer types
- Backward USB 2.0 compatibility
- New connectors and cable

The topics below cover some of the most commonly asked questions regarding USB 3.0/USB 3.1 Gen 1.



Speed

Currently, there are 3 speed modes defined by the latest USB 3.0/USB 3.1 Gen 1 specification. They are Super-Speed, Hi-Speed and Full-Speed. The new SuperSpeed mode has a transfer rate of 4.8Gbps. While the specification retains Hi-Speed, and Full-Speed USB mode, commonly known as USB 2.0 and 1.1 respectively, the slower modes still operate at 480Mbps and 12Mbps respectively and are kept to maintain backward compatibility.

USB 3.0/USB 3.1 Gen 1 achieves the much higher performance by the technical changes below:

- An additional physical bus that is added in parallel with the existing USB 2.0 bus (refer to the picture below).
- USB 2.0 previously had four wires (power, ground, and a pair for differential data); USB 3.0/USB 3.1 Gen 1 adds four more for two pairs of differential signals (receive and transmit) for a combined total of eight connections in the connectors and cabling.
- USB 3.0/USB 3.1 Gen 1 utilizes the bidirectional data interface, rather than USB 2.0's half-duplex arrangement. This gives a 10-fold increase in theoretical bandwidth.

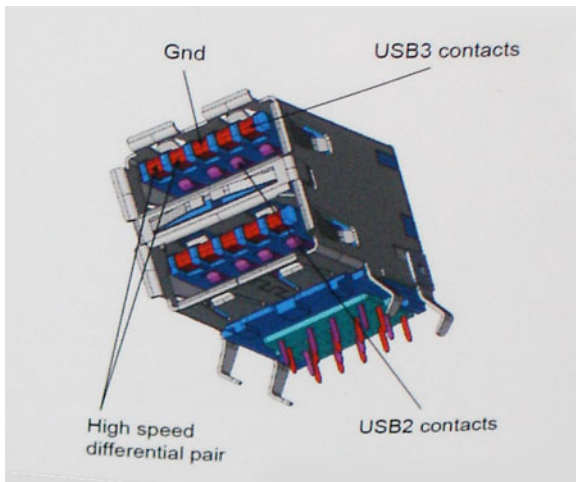

With today's ever increasing demands placed on data transfers with high-definition video content, terabyte storage devices, high megapixel count digital cameras etc., USB 2.0 may not be fast enough. Furthermore, no USB 2.0 connection could ever come close to the 480Mbps theoretical maximum throughput, making data transfer at around 320Mbps (40MB/s) — the actual real-world maximum. Similarly, USB 3.0/USB 3.1 Gen 1 connections will never achieve 4.8Gbps. We will likely see a real-world maximum rate of 400MB/s with overheads. At this speed, USB 3.0/USB 3.1 Gen 1 is a 10x improvement over USB 2.0.

Applications

USB 3.0/USB 3.1 Gen 1 opens up the laneways and provides more headroom for devices to deliver a better overall experience. Where USB video was barely tolerable previously (both from a maximum resolution, latency, and video compression perspective), it's easy to imagine that with 5-10 times the bandwidth available, USB video solutions should work that much better. Single-link DVI requires almost 2Gbps throughput. Where 480Mbps was limiting, 5Gbps is more than promising. With its promised 4.8Gbps speed, the standard will find its way into some products that previously weren't USB territory, like external RAID storage systems.

Listed below are some of the available SuperSpeed USB 3.0/USB 3.1 Gen 1 products:

- External Desktop USB 3.0/USB 3.1 Gen 1 Hard Drives
- Portable USB 3.0/USB 3.1 Gen 1 Hard Drives
- USB 3.0/USB 3.1 Gen 1 Drive Docks & Adapters
- USB 3.0/USB 3.1 Gen 1 Flash Drives & Readers
- USB 3.0/USB 3.1 Gen 1 Solid-state Drives
- USB 3.0/USB 3.1 Gen 1 RAIDs
- Optical Media Drives
- Multimedia Devices
- Networking
- USB 3.0/USB 3.1 Gen 1 Adapter Cards & Hubs

Compatibility

The good news is that USB 3.0/USB 3.1 Gen 1 has been carefully planned from the start to peacefully co-exist with USB 2.0. First of all, while USB 3.0/USB 3.1 Gen 1 specifies new physical connections and thus new cables to take advantage of the higher speed capability of the new protocol, the connector itself remains the same rectangular shape with the four USB 2.0 contacts in the exact same location as before. Five new connections to carry receive and transmitted data independently are present on USB 3.0/USB 3.1 Gen 1 cables and only come into contact when connected to a proper SuperSpeed USB connection.

Windows 8/10 will be bringing native support for USB 3.1 Gen 1 controllers. This is in contrast to previous versions of Windows, which continue to require separate drivers for USB 3.0/USB 3.1 Gen 1 controllers.

Microsoft announced that Windows 7 would have USB 3.1 Gen 1 support, perhaps not on its immediate release, but in a subsequent Service Pack or update. It is not out of the question to think that following a successful release of USB 3.0/USB 3.1 Gen 1 support in Windows 7, SuperSpeed support would trickle down to Vista. Microsoft has confirmed this by stating that most of their partners share the opinion that Vista should also support USB 3.0/USB 3.1 Gen 1.

Super-Speed support for Windows XP is unknown at this point. Given that XP is a seven-year-old operating system, the likelihood of this happening is remote.

Memory features

In this computer, the memory (RAM) is a part of the system board.

- This computer supports 2133 MHz DDR4 for Intel 6th generation processor.
- This computer supports 2400 MHz DDR4 for Intel 7th generation processor.

Verifying system memory in Windows 10 and Windows 7

Windows 10

- 1 Click the **Windows** button and select **All Settings**  **> System**.
- 2 Under **System**, click **About**.

Windows 7

- 1 Click **Start** → **Control Panel** → **System**

Verifying system memory in setup

- 1 Turn on or restart your computer..
- 2 Perform one of the following actions after the Dell logo is displayed:
 - BIOS — Tap F2 until the **Entering BIOS** setup message appears.
 - Boot Menu — Tap F12 to enter the boot section menu.
- 3 On the left pane, select **Settings > General > System Information**.
The memory information is displayed on the right pane.

DDR4

DDR4 (double data rate fourth generation) memory is a higher-speed successor to the DDR2 and DDR3 technologies and allows up to 512 GB in capacity, compared to the DDR3's maximum capacity of 128 GB per DIMM. DDR4 synchronous dynamic random-access memory is keyed differently from both SDRAM and DDR to prevent the user from installing the wrong type of memory into the system.

DDR4 needs 20 percent less or just 1.2 volts, compared to DDR3 which requires 1.5 volts of electrical power to operate. DDR4 also supports a new, deep power-down mode that allows the host device to go into standby without needing to refresh its memory. Deep power-down mode is expected to reduce standby power consumption by 40 to 50 percent.



DDR4 Details

There are subtle differences between DDR3 and DDR4 memory modules, as listed below.

Key notch difference

The key notch on a DDR4 module is in a different location from the key notch on a DDR3 module. Both notches are on the insertion edge, but the notch location on the DDR4 is slightly different, to prevent the module from being installed into an incompatible board or platform.

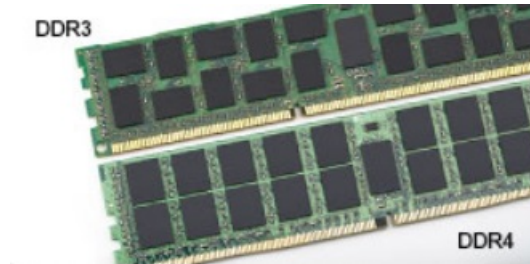

Figure 1. Notch difference

Increased thickness

DDR4 modules are slightly thicker than DDR3, to accommodate more signal layers.

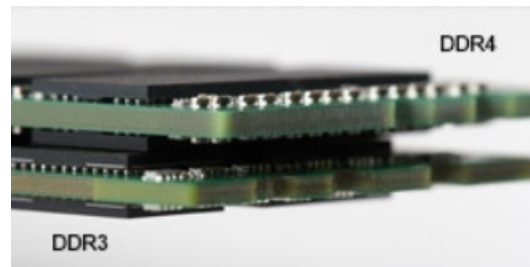

Figure 2. Thickness difference

Curved edge

DDR4 modules feature a curved edge to help with insertion and alleviate stress on the PCB during memory installation.



Figure 3. Curved edge

Testing memory using ePSA

- 1 Turn on or restart your computer.
- 2 Perform the following actions immediately after the Dell logo is displayed:
 - With keyboard — Press F2.

The PreBoot System Assessment (PSA) starts on your computer.

NOTE: If you wait too long and the operating system logo appears, continue to wait until you see the desktop. Turn off the computer and try again.

Realtek HD audio drivers

Verify if the Realtek audio drivers are already installed in the computer.

- 1 Click **Start**
- 2 Navigate to **Control Panel**
- 3 Under **Device Manager**, click **Sound,video and game controllers**

Table 7. Realtek HD audio drivers

Before installation

- Audio inputs and outputs
 - Microphone (High Definition Audio Device)
 - Speakers (High Definition Audio Device)
- Sound, video and game controllers
 - High Definition Audio Device
 - Intel(R) Display Audio

After installation

- Sound, video and game controllers
 - Bluetooth Hands-free Audio
 - Intel(R) Display Audio
 - Realtek High Definition Audio



System setup

System setup enables you to manage your hardware and specify BIOS level options. From the System setup, you can:

- Change the NVRAM settings after you add or remove hardware
- View the system hardware configuration
- Enable or disable integrated devices
- Set performance and power management thresholds
- Manage your computer security

BIOS Overview

Boot menu

Press <F12> when the Dell™ logo appears to initiate a one-time boot menu with a list of the valid boot devices for the system. Diagnostics and BIOS Setup options are also included in this menu. The devices listed on the boot menu depend on the bootable devices in the system. This menu is useful when you are attempting to boot to a particular device or to bring up the diagnostics for the system. Using the boot menu does not make any changes to the boot order stored in the BIOS.

The options are:

- Legacy Boot:
 - Internal HDD
 - Onboard NIC
- UEFI Boot:
 - Windows Boot Manager
- Other Options:
 - BIOS Setup
 - BIOS Flash Update
 - Diagnostics
 - Change Boot Mode Settings

System setup options

NOTE: Depending on the computer and its installed devices, the items listed in this section may or may not appear.

Table 8. General tab

Option	Description
System Information	This section lists the primary hardware features of your computer. <ul style="list-style-type: none"> • System Information: Displays BIOS Version, Service Tag, Asset Tag, Ownership Tag, Ownership Date, Manufacture Date, and the Express Service Code.

Option	Description
	<ul style="list-style-type: none"> Memory Information: Displays Memory Installed, Memory Available, Memory Speed, Memory Channels Mode, Memory Technology, DIMM A Size, DIMM B Size, PCI Information: Slot1, Slot2 Processor Information: Displays Processor Type, Core Count, Processor ID, Current Clock Speed, Minimum Clock Speed, Maximum Clock Speed, Processor L2 Cache, Processor L3 Cache, HT Capable, and 64-Bit Technology. Device Information: Displays Primary Hard Drive, ODD Device, LOM MAC Address, Video Controller, Video BIOS Version, Video Memory, Panel Type, Native Resolution, Audio Controller, Wi-Fi Device, Bluetooth Device.
Boot Sequence	<p>Boot Sequence</p> <p>Allows you to change the order in which the computer attempts to find an operating system. The option is:</p> <ul style="list-style-type: none"> Windows Boot Manager <p>By default, all the options are checked. You can also deselect any option or change the boot order.</p> <p>Boot List Option</p> <p>Allows you to change the boot list option.</p> <ul style="list-style-type: none"> Legacy UEFI
Advanced Boot Options	This option allows you the legacy option ROMs to load. By default, the Enable Legacy Option ROMs is disabled.
UEFI Boot Path Security	<p>This option allows you control whether the system prompts the user to enter the Admin password when booting a UEFI boot path from the F12 boot menu. The options are:</p> <ul style="list-style-type: none"> Always, Except Internal HDD (Enabled) Always Never
Date/Time	Allows you to change the date and time.

Table 9. System Configuration

Option	Description
Integrated NIC	<p>Allows you to configure the integrated network controller. The options are:</p> <ul style="list-style-type: none"> Disabled Enabled Enabled w/PXE: (Enabled by default)
Serial Port	<p>Allows you to configure built-in serial port operates.</p> <ul style="list-style-type: none"> Disabled COM1: (Enabled by default) COM2 COM3 COM4
SATA Operation	<p>Allows you to configure the internal SATA hard-drive controller. The options are:</p> <ul style="list-style-type: none"> Disabled AHCI RAID On: (Enabled by default)
Drives	Allows you to configure the SATA drives on board. All drives are enabled by default. The options are:



Option	Description
SMART Reporting	<ul style="list-style-type: none"> • SATA-0: (Enabled by default) • SATA-1: (Enabled by default) • M.2 PCIe SSD-0: (Enabled by default) <p>This field controls whether hard drive errors for integrated drives are reported during system startup. This technology is part of the SMART (Self-Monitoring Analysis and Reporting Technology) specification.</p> <ul style="list-style-type: none"> • Enable SMART Reporting (Disabled by default)
USB Configuration	<p>This field configures the integrated USB controller. If Boot Support is enabled, the system is allowed to boot any type of USB Mass Storage Devices (HDD, memory key, floppy). If USB port is enabled, device attached to this port is enabled and available for OS.</p> <p>If USB port is disabled, the OS cannot see any device attached to this port.</p> <ul style="list-style-type: none"> • Enable Boot Support • Enable Side USB Ports • Enable Rear USB Ports
Rear USB Configuration	<p>i NOTE: USB keyboard and mouse always work in the BIOS setup irrespective of these settings.</p> <p>This field enables or disables the rear USB configuration</p> <ul style="list-style-type: none"> • Left* • Center Right • Center Left* • Right <p>i NOTE: *Left port denotes a USB 3.1 Gen 1 capable port.</p>
Side USB Configuration	<p>This field enables or disables the side USB configuration</p> <ul style="list-style-type: none"> • Side Port 1 (Top)* • Side Port 2 (Bottom)* <p>i NOTE: *Side Port 1 (Top) port denotes a USB 3.1 Gen 1 capable port.</p>
USB PowerShare	<p>Allows you to configure the USB PowerShare feature behavior.</p> <ul style="list-style-type: none"> • Enable USB PowerShare (Disabled)
Audio	<p>This field enables or disables the integrated audio controller. By default, the Enable Audio option is selected. The options are:</p> <ul style="list-style-type: none"> • Enable Microphone • Enable Internal Speaker
OSB Button Management	<p>This field allows the user to disable the OSB (On-Screen Display) buttons on their AIO.</p> <ul style="list-style-type: none"> • Disabled OSD Buttons (Disabled)
Touchscreen	<p>This field controls whether the touchscreen is enabled or disabled.</p> <ul style="list-style-type: none"> • Touchscreen (Enabled)
Miscellaneous Devices	<p>Allows you to enable or disable the following devices:</p> <ul style="list-style-type: none"> • Enable Camera (Enabled) • Enabled Secure Digital (SD) Card (Enabled)

Option	Description
	<ul style="list-style-type: none"> Secure Digital (SD) card Boot Secure Digital (SD) card Read-Only Mode

Table 10. Security

Option	Description
Admin Password	<p>Allows you to set, change, or delete the administrator (admin) password.</p> <p>i NOTE: You must set the admin password before you set the system or hard drive password. Deleting the admin password automatically deletes the system password and the hard drive password.</p> <p>i NOTE: Successful password changes take effect immediately.</p> <p>Default Setting: Not set</p>
System Password	<p>Allows you to set, change, or delete the system password.</p> <p>i NOTE: Successful password changes take effect immediately.</p> <p>Default Setting: Not set</p>
Internal HDD-0 Password	<p>Allows you to set, change, or delete the password on the system's internal hard-disk drive.</p> <p>i NOTE: Successful password changes take effect immediately.</p> <p>Default Setting: Not set</p>
Strong Password	<p>Allows you to enforce the option to always set strong passwords.</p> <p>Default Setting: Enable Strong Password is not selected.</p> <p>i NOTE: If Strong Password is enabled, the Admin and System passwords must contain at least one uppercase character, one lowercase character and be at least 8 characters long.</p>
Password Configuration	<p>Allows you to determine the minimum and maximum length of the Administrator and System passwords.</p>
Password Bypass	<p>Allows you to enable or disable the permission to bypass the System and the Internal HDD password, when they are set. The options are:</p> <ul style="list-style-type: none"> Disabled Reboot bypass <p>Default Setting: Disabled</p>
Password Change	<p>Allows you to enable the disable permission to the System and Hard Drive passwords when the admin password is set.</p> <p>Default Setting: Allow Non-Admin Password Changes is selected.</p>
UEFI Capsule Firmware Updates	<p>Allows you to controls whether the system allows BIOS update via UEFI capsule update packages. Default setting: Enable</p>
TPM 1.2 Security	<p>Allows you to enable the Trusted Platform Module (TPM) during POST. The options are:</p> <ul style="list-style-type: none"> TPM On (Enabled) Clear PPI Bypass for Enabled Commands Enabled (Enabled) Disabled



Option	Description
Computrace	<p>NOTE: To upgrade or downgrade TPM1.2/2.0, download the TPM wrapper tool (software).</p> <p>Allows you to activate or disable the optional Computrace software. The options are:</p> <ul style="list-style-type: none"> Deactivate Disable Activate <p>NOTE: The Activate and Disable options will permanently activate or disable the feature and no further changes are allowed.</p> <p>Default setting: Deactivate</p>
CPU XD Support	<p>Allows you to enable the Execute Disable mode of the processor.</p> <p>Enable CPU XD Support (Default)</p>
Admin Setup Lockout	<p>Allows you to prevent users from entering Setup when an Administrator password is set.</p> <p>Default Setting: Enable Admin Setup Lockout is not selected.</p>
Master Password Lockout	<p>This option is when enabled this option disables master password support.</p> <ul style="list-style-type: none"> Enable Admin Setup Lockout (Disabled)

Table 11. Secure Boot

Option	Description
Secure Boot Enable	<p>This option enables or disables the Secure Boot Feature.</p> <ul style="list-style-type: none"> Disabled Enabled <p>Default Setting: The option is disabled.</p>
Expert Key Management	<p>Allows you to manipulate the security key databases only if the system is in Custom Mode. The Enable Custom Mode option is disabled by default. The options are:</p> <ul style="list-style-type: none"> PK KEK db dbx <p>If you enable the Custom Mode, the relevant options for PK, KEK, db, and dbx appear. The options are:</p> <ul style="list-style-type: none"> Save to File- Saves the key to a user-selected file Replace from File- Replaces the current key with a key from a user-selected file Append from File- Adds a key to the current database from a user-selected file Delete- Deletes the selected key Reset All Keys- Resets to default setting Delete All Keys- Deletes all the keys <p>NOTE: If you disable the Custom Mode, all the changes made will be erased and the keys will restore to default settings.</p>

Table 12. Intel Software Guard Extensions screen options

Option	Description
Intel SGX Enable	<p>This field specifies you to provide a secured environment for running code/storing sensitive information in the context of the main OS. The options are:</p> <ul style="list-style-type: none"> • Disabled • Enabled • Software Controlled (Enabled)
Enclave Memory Size	<p>This option sets SGX Enclave Reserve Memory Size. The options are:</p> <ul style="list-style-type: none"> • 32 MB • 64 MB • 128 MB

Table 13. Performance

Option	Description
Multi Core Support	<p>This field specifies whether the process has one or all cores enabled. The performance of some applications improve with the additional cores. This option is enabled by default. Allows you to enable or disable multi-core support for the processor. The installed processor supports two cores. If you enable Multi Core Support, two cores are enabled. If you disable Multi Core Support, one core will be enabled.</p> <ul style="list-style-type: none"> • All (Enabled) • 1 • 2 • 3
Intel SpeedStep	<p>Allows you to enable or disable the Intel SpeedStep feature.</p> <ul style="list-style-type: none"> • Enable Intel SpeedStep <p>Default Setting: The option is enabled.</p>
C States Control	<p>Allows you to enable or disable the additional processor sleep states.</p> <ul style="list-style-type: none"> • C states <p>Default Setting: The option is enabled.</p>
Limited CPUID Value	<p>This field limits the maximum value the processor standard CPUID function will support.</p> <ul style="list-style-type: none"> • Enable CPUID Limit
Intel TurboBoost	<p>Allows you to enable or disable the Intel TurboBoost mode of the processor.</p> <ul style="list-style-type: none"> • Enable Intel TurboBoost <p>Default Setting: The option is enabled.</p>
HyperThread control	<p>This option enables or disables HyperThreading in the processor.</p> <ul style="list-style-type: none"> • Disabled • Enabled (Default)



Table 14. Power Management

Option	Description
AC Behavior	<p>Allows you to enable or disable the computer from turning on automatically when an AC adapter is connected.</p> <ul style="list-style-type: none">• Power Off (Default)• Power On• Last Power State
Auto On Time	<p>Allows you to set the time at which the computer must turn on automatically. The options are:</p> <ul style="list-style-type: none">• Disabled (Default)• Every Day• Weekdays• Select Days
Deep Sleep Control	<p>Allows you to aggressive the system is at conserving power while Shut down (S5) or in Hibernate (S4) mode.</p> <ul style="list-style-type: none">• Disabled (Default)• Enabled in S5 only• Enabled in S4 and S5
Fan Control Override	<p>This field determines the speed of the system fan.</p> <ul style="list-style-type: none">• Fan Control Override (Disabled)
USB Wake Support	<p>Allows you to enable USB devices to wake the system from Standby.</p> <p>NOTE: This feature is only functional when the AC power adapter is connected. If the AC power adapter is removed during Standby, the system setup will remove power from all of the USB ports to conserve battery power.</p> <ul style="list-style-type: none">• Enable USB Wake Support <p>Default Setting: The option is disabled.</p>
Wake on LAN/WLAN	<p>Allows you to enable or disable the feature that powers on the computer from the Off state when triggered by a LAN signal.</p> <ul style="list-style-type: none">• Disabled: This option is enabled by default• LAN Only• WLAN Only• LAN or WLAN• LAN with PXE Boot
Block Sleep	<p>Allows you to block entering to sleep (S3 state) in OS environment.</p> <p>Default Setting: The option is disabled.</p>
Intel Ready Mode	<p>Allows you to replace sleep S3 to put your PC in an always aware state that allows the user to interact with it even while the PC is asleep</p> <ul style="list-style-type: none">• Enable Intel Ready Mode: The option is disabled.



Table 15. POST Behavior

Option	Description
Adapter Warnings	Allows you to enable or disable the system setup (BIOS) warning messages when you use certain power adapters. <ul style="list-style-type: none"> • Default Setting: Enable Adapter Warnings
Numlock LED	This option specifies whether the NumLock LED should be on when the system boots. <ul style="list-style-type: none"> • Enable Numlock LED: The option is enabled.
Keyboard Errors	This option specifies whether the keyboard related errors are reported when it boots. <ul style="list-style-type: none"> • Enables Keyboard Error Detection: The option is disabled.
Fastboot	Allows you to speed up the boot process by bypassing some of the compatibility steps. The options are: <ul style="list-style-type: none"> • Minimal(default) • Thorough • Auto
Extended BIOS POST Time	Allows you to create an additional preboot delay. The options are: <ul style="list-style-type: none"> • 0 seconds. This option is enabled by default. • 5 seconds • 10 seconds
Full Screen Logo	This option displays full screen logo if your image match screen resolution. <ul style="list-style-type: none"> • Enable Full Screen Logo (Disabled)
Warnings and Errors	This option is caused when warnings and errors are detected. <ul style="list-style-type: none"> • Prompt on Warnings and Error (Enabled) • Continue on Warnings • Continue on Warnings and Errors

Table 16. Virtualization Support

Option	Description
Virtualization	Allows you to enable or disable the Intel Virtualization Technology. <ul style="list-style-type: none"> • Enable Intel Virtualization Technology (default)
VT for Direct I/O	Enables or disables the Virtual Machine Monitor (VMM) from utilizing the additional hardware capabilities provided by Intel® Virtualization technology for direct I/O. <p>Enable VT for Direct I/O — enabled by default.</p>

Table 17. Wireless

Option	Description
Wireless Device Enable	This field allows enabling/disabling of internal wireless devices. <ul style="list-style-type: none"> • WLAN/WiGig



Option	Description
	<ul style="list-style-type: none"> Bluetooth

Table 18. Maintenance

Option	Description
Service Tag	Displays the Service Tag of your computer.
Asset Tag	Allows you to create a system asset tag if an asset tag is not already set. This option is not set by default.
SERR Messages	<p>This field controls the SERR message mechanism. Some graphic card required the SERR message.</p> <ul style="list-style-type: none"> Enable SERR Messages (default)
BIOS Downgrade	<p>This field controls flashing of the system firmware to pervious revisions.</p> <p>Allows BIOS Downgrade (Enabled)</p>
Data Wipe	This field enables user to erase data from all internal storage device.
BIOS Recovery	Allows you to recover from certain corrupted BIOS conditions from a recover file on the user primary hard drive or an external USB key. Enabled by default.

Table 19. System Logs

Option	Description
BIOS Events	Allows you to view and clear the System Setup (BIOS) POST events.

Table 20. SupportAssist System Resolution

Option	Description
Auto OS Recovery Threshold	<p>Allows you to control the automatic boot flow for SupportAssist System. Options are:</p> <ul style="list-style-type: none"> Off 1 2 (Enabled) 3



Technical specifications

NOTE: Offerings may vary by region. For more information regarding the configuration of your computer in:

- Windows 10, click or tap **Start**  > **Settings** > **System** > **About**.
- Windows 7, click **Start** , right-click **My Computer**, and then select **Properties**.

Topics:

- Processor specifications
- Memory specifications
- Video specifications
- Audio specifications
- Communication specifications
- Cards specifications
- Display specifications
- Drives specifications
- Port and connector specifications
- Power specifications
- Camera specifications
- Stand specifications
- Physical specifications
- Environmental specifications

Processor specifications

Feature	Specification
Processor cache	<ul style="list-style-type: none"> Intel 6th Generation Core i5-6400T QC (Support for Windows 7/8.1/10/Linux) Intel 6th Generation Core i5-6500T (Support for Windows 7/8.1/10/Linux) Intel 6th Generation Core i7-6700T QC (Support for Windows 7/8.1/10/Linux) Intel Pentium Processor G4500T DC Intel 7th Generation Core i3-7300T DC (Support for Windows 10/Linux Only) Intel 7th Generation Core i5-7400T QC (Support for Windows 10/Linux Only) Intel 7th Generation Core i5-7500T (Support for Windows 10/Linux Only) Intel 7th Generation Intel Core i7-7700T (Support for Windows 10/Linux Only)
Total cache	Up to 8 MB cache depending on processor type
Chipset	Intel B250 Chipset



Memory specifications

Feature	Specification
Memory type	<ul style="list-style-type: none">Up to 2133 MHz (6th generation Intel processors)Up to 2400 MHz (7th generation Intel processors), unbuffered non-ECC, dual-channel DDR4 configuration
Memory capacity	Up to 16 GB each
Memory connectors	Two internally accessible DDR4 SODIMM sockets
Minimum memory	2 GB
Maximum memory	32 GB

Video specifications

Feature	Specification
Video Controller (Integrated)	<ul style="list-style-type: none">Intel HD 630 Graphics [with 7th generation Core-i3/i5/i7 CPU-GPU combo]Intel HD 610 Graphics [with 7th generation Celeron/Pentium CPU-GPU combo]Intel HD 530 Graphics [with 6th generation Core-i3/i5/i7 CPU-GPU combo]Intel HD 510 Graphics [with 6th generation Celeron/Pentium CPU-GPU combo]
Video Memory	Shared memory
External display support	DisplayPort, VGA and serial port (optional)

Audio specifications

Feature	Specification
Controller	Integrated Realtek ALC3661-CG-A3 High Definition Audio with Waves MaxxVoice Pro
Speaker	Single 4 Ω , 4 W AVG speakers with 5 W Peak
Internal speaker amplifier	Up to 6 W per channel
Internal microphone support	Single digital microphone
Volume controls	Volume up/down buttons, program menus, and keyboard media-control keys

Communication specifications

Features	Specification
Network adapter	Realtek RTL8111HSD-CG Ethernet LAN 10/100/1000M on system board
Wireless	<ul style="list-style-type: none">Intel Dual Band Wireless-AC 8265 WLAN card (802.11abgn+ac MIMO 2x2)Intel Dual Band Wireless-AC 8265 WLAN card - Bluetooth 4.2Intel Dual Band Wireless-AC 3165 WLAN card (802.11abgn+ac MIMO 1x1)



Features

Specification

- Intel Dual Band Wireless-AC 3165 WLAN card - Bluetooth 4.2

Cards specifications

Feature

Specification

M.2

One

Display specifications

Feature

Specification

Type

19.5 inches, HD+ WLED

Maximum resolution

1600 x 900

Refresh rate

60 Hz

Brightness

Brightness up/down buttons

Operating angle

85 degrees horizontal/ 75 degrees vertical

Pixel pitch

- 271.2 mm x 262.6 mm (touch)
- 270 mm x 270 mm (non-touch)

Height

452 mm (17.75 inches)

Width

263 mm (10.35 inches)

Drives specifications

Feature

Specification

Hard drive

One 2.5 inches SATA drive

Optical drive
(optional)

DVD+/-RW SATA

Port and connector specifications

Feature

Specification

Audio

One Universal audio jack

Network adapter

One RJ-45 connector

USB 2.0

- Two USB 2.0 ports (rear)

USB 3.0

- Two USB 3.0 ports (rear)

Video

One DisplayPort, VGA and serial port (optional)

Media card reader

One 4-in-1 slot



Power specifications

Feature	Specifications
Type	130 W; 180 W
Voltage	90 V AC–264 V AC
Input current:	1.8 A / 0.9 A; 2.34 A / 1.25 A
Frequency	47–63 Hz
Rated output voltage	19.50 V DC

Camera specifications

Feature	Specification
Image resolution	1.0 megapixels
Video resolution	HD (720p)
Diagonal viewing angle	74.6 degrees

Stand specifications

Feature	Specification
Tilt	–5 degrees to 30 degrees
HAS Stand Dimensions:	
Width	10.12 inches (25.70 cm)
Depth	8.86 inches (22.50 cm)
Weight	6.27 lbs (2.85 kg)
Easel Stand Dimensions:	
Width	5.19 inches (13.20 cm)
Depth	1.04 inches (2.65 cm)
Weight	1.76 lbs (0.80 kg)

Physical specifications

Features	Specifications
Weight without stand (Non-Touch)	7.92 lbs (3.6 kg)
Weight without stand (Touch)	9.0 lbs (4.1 kg)
Non-Touch (without stand):	



Features	Specifications
Height	12.94 inches (32.87 cm)
Width	19.0 inches (48.25 cm)
Depth	2.38 inches (5.89 cm)
Touch (without stand):	
Height	12.94 inches (32.87 cm)
Width	19.00 inches (48.25 cm)
Depth	2.32 inches (5.80 cm)

Environmental specifications

Temperature	Specifications
Operating	0°C to 35°C (32°F to 95°F)
Storage	-40°C to 65°C (-40°F to 149°F)

Relative humidity (maximum)	Specifications
Operating	20% to 80% (non condensing)
Storage	20% to 80% (non condensing)

Maximum vibration	Specifications
Operating	0.26 GRMS at 5 Hz to 350 Hz
Storage	1.37 GRMS at 5 Hz to 200 Hz

Maximum shock	Specifications
Operating	40 G
Storage	105 G

Altitude (maximum)	Specifications
Operating	0 m to 5000 m (0 ft to 16,404 ft)
Non-operating	0 m to 5000 m (0 ft to 16,404 ft)
Airborne contaminant level	G2 or lower as defined by ANSI/ISA-S71.04-1985



Troubleshooting

Enhanced Pre-Boot System Assessment — ePSA diagnostics

The ePSA diagnostics (also known as system diagnostics) performs a complete check of your hardware. The ePSA is embedded with the BIOS and is launched by the BIOS internally. The embedded system diagnostics provides a set of options for particular devices or device groups allowing you to:

- Run tests automatically or in an interactive mode
- Repeat tests
- Display or save test results
- Run thorough tests to introduce additional test options to provide extra information about the failed device(s)
- View status messages that inform you if tests are completed successfully
- View error messages that inform you of problems encountered during testing

⚠ CAUTION: Use the system diagnostics to test only your computer. Using this program with other computers may cause invalid results or error messages.

ⓘ NOTE: Some tests for specific devices require user interaction. Always ensure that you are present at the computer terminal when the diagnostic tests are performed.

ⓘ NOTE: Regular ePSA's run for about 5 to 10 minutes, however, the extended test takes about three and half hours with only 8GB of ram in the system.

Running the ePSA diagnostics

- 1 Power-on the computer.
- 2 As the computer boots, press the F12 key as the Dell logo appears.
- 3 On the boot menu screen, select the **Diagnostics** option.
- 4 Click the arrow key at the bottom left corner.
Diagnostics front page is displayed.
- 5 Press the arrow in the lower-right corner to go to the page listing.
The items detected are listed.
- 6 To run a diagnostic test on a specific device, press Esc and click **Yes** to stop the diagnostic test.
- 7 Select the device from the left pane and click **Run Tests**.
- 8 If there are any issues, error codes are displayed.
Note the error code and validation number and contact Dell.

LCD built in self test (BIST)

All-in-One (AIO) systems supports LCD BIST similar to any other Dell systems that have BIST test implemented. It allows the user to isolate the LCD during troubleshooting to determine which sub-system is at fault. The main difference is the lack of an integrated keyboard scan controller in the AIO. When BIST is initiated, an internal generated pattern from the LCD will be emitted for user's observation. This pattern will go by sequence through this pattern. Black-White-Red-Green-Blue or a White-Black-Red-Green-Blue where each pattern is emitted for 2 to 3 seconds. The following images displays the pattern of the colors on the LCD.

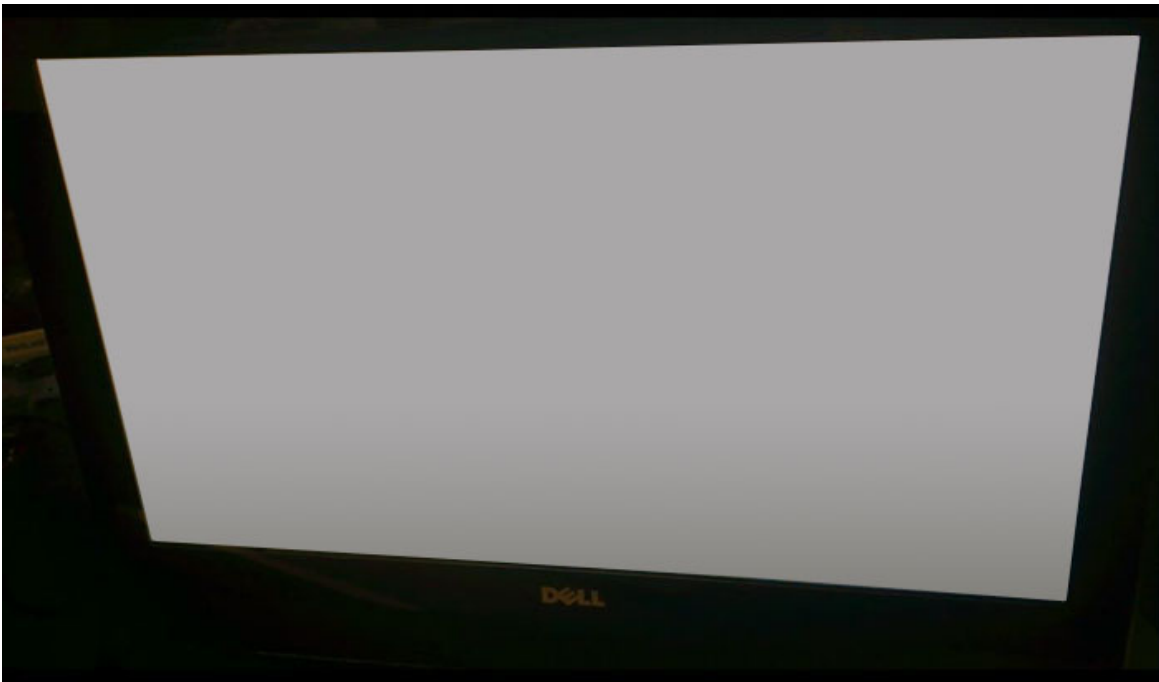

Invoking BIST with user modes



There are two methods to invoke the LCD BIST .

- OSD Toggle
- ePSA

OSD toggle

The first method of user initiation is via OSD toggle button. The user should press the OSD toggle button and hold it in while the power button is applied to turn the AIO on. This is the hardware-initiated method that does not require the CPU and BIOS to be functional. The panel will stay in BIST mode until the BIOS reboots the system. The test duration is approximately 20 seconds which allows 2 cycles of color bar patterns.

To invoke the BIST test via OSD Toggle:

- 1 Press and hold down the OSD toggle button.
- 2 Press the power button to turn on the computer while holding down on the OSD toggle button.

NOTE: The OSD toggle is located at the right side of the chassis, just above the Hard Disk indicator light.

ePSA

The second method to troubleshoot is via ePSA entry. The user initiates a Pre-Boot POST via F12 function key and the system enters ePSA. The ePSA menu will have an LCD BIST selection that asserts the proper signals via BIOS commands. The BIST mode will loop for

approximately 20 seconds giving 2 cycles of color bar patterns that the user can observe. The time period is controlled by BIOS. After the time period, the BIOS will return the system to the ePSA menu.



Contacting Dell

NOTE: If you do not have an active Internet connection, you can find contact information on your purchase invoice, packing slip, bill, or Dell product catalog.

Dell provides several online and telephone-based support and service options. Availability varies by country and product, and some services may not be available in your area. To contact Dell for sales, technical support, or customer service issues:

- 1 Go to **Dell.com/support**.
- 2 Select your support category.
- 3 Verify your country or region in the **Choose a Country/Region** drop-down list at the bottom of the page.
- 4 Select the appropriate service or support link based on your need.