

Dell Latitude 7390

Owner's Manual



Notes, cautions, and warnings

 | **NOTE:** A NOTE indicates important information that helps you make better use of your product.

 | **CAUTION:** A CAUTION indicates either potential damage to hardware or loss of data and tells you how to avoid the problem.

 | **WARNING:** A WARNING indicates a potential for property damage, personal injury, or death.

© 2018 Dell Inc. or its subsidiaries. All rights reserved. Dell, EMC, and other trademarks are trademarks of Dell Inc. or its subsidiaries. Other trademarks may be trademarks of their respective owners.

Working on your computer

Safety precautions

The safety precautions chapter details the primary steps to be taken before performing any disassembly instructions.

Observe the following safety precautions before you perform any installation or break/fix procedures involving disassembly or reassembly:

- Turn off the system and all attached peripherals.
- Disconnect the system and all attached peripherals from AC power.
- Disconnect all network cables, telephone, and telecommunications lines from the system.
- Use an ESD field service kit when working inside any notebook to avoid electrostatic discharge (ESD) damage.
- After removing any system component, carefully place the removed component on an anti-static mat.
- Wear shoes with non-conductive rubber soles to reduce the chance of getting electrocuted.

Standby power

Dell products with standby power must be unplugged before you open the case. Systems that incorporate standby power are essentially powered while turned off. The internal power enables the system to be remotely turned on (wake on LAN) and suspended into a sleep mode and has other advanced power management features.

Unplugging, pressing and holding the power button for 15 seconds should discharge residual power in the system board. notebooks.

Bonding

Bonding is a method for connecting two or more grounding conductors to the same electrical potential. This is done through the use of a field service electrostatic discharge (ESD) kit. When connecting a bonding wire, ensure that it is connected to bare metal and never to a painted or non-metal surface. The wrist strap should be secure and in full contact with your skin, and ensure that you remove all jewelry such as watches, bracelets, or rings prior to bonding yourself and the equipment.

Electrostatic discharge — ESD protection

ESD is a major concern when you handle electronic components, especially sensitive components such as expansion cards, processors, memory DIMMs, and system boards. Very slight charges can damage circuits in ways that may not be obvious, such as intermittent problems or a shortened product life span. As the industry pushes for lower power requirements and increased density, ESD protection is an increasing concern.

Due to the increased density of semiconductors used in recent Dell products, the sensitivity to static damage is now higher than in previous Dell products. For this reason, some previously approved methods of handling parts are no longer applicable.

Two recognized types of ESD damage are catastrophic and intermittent failures.

- **Catastrophic** – Catastrophic failures represent approximately 20 percent of ESD-related failures. The damage causes an immediate and complete loss of device functionality. An example of catastrophic failure is a memory DIMM that has received a static shock and immediately generates a "No POST/No Video" symptom with a beep code emitted for missing or nonfunctional memory.
- **Intermittent** – Intermittent failures represent approximately 80 percent of ESD-related failures. The high rate of intermittent failures means that most of the time when damage occurs, it is not immediately recognizable. The DIMM receives a static shock, but the

tracing is merely weakened and does not immediately produce outward symptoms related to the damage. The weakened trace may take weeks or months to melt, and in the meantime may cause degradation of memory integrity, intermittent memory errors, etc.

The more difficult type of damage to recognize and troubleshoot is the intermittent (also called latent or "walking wounded") failure.

Perform the following steps to prevent ESD damage:

- Use a wired ESD wrist strap that is properly grounded. The use of wireless anti-static straps is no longer allowed; they do not provide adequate protection. Touching the chassis before handling parts does not ensure adequate ESD protection on parts with increased sensitivity to ESD damage.
- Handle all static-sensitive components in a static-safe area. If possible, use anti-static floor pads and workbench pads.
- When unpacking a static-sensitive component from its shipping carton, do not remove the component from the anti-static packing material until you are ready to install the component. Before unwrapping the anti-static packaging, ensure that you discharge static electricity from your body.
- Before transporting a static-sensitive component, place it in an anti-static container or packaging.

ESD field service kit

The unmonitored Field Service kit is the most commonly used service kit. Each Field Service kit includes three main components: anti-static mat, wrist strap, and bonding wire.

Components of an ESD field service kit

The components of an ESD field service kit are:

- **Anti-Static Mat** – The anti-static mat is dissipative and parts can be placed on it during service procedures. When using an anti-static mat, your wrist strap should be snug and the bonding wire should be connected to the mat and to any bare metal on the system being worked on. Once deployed properly, service parts can be removed from the ESD bag and placed directly on the mat. ESD-sensitive items are safe in your hand, on the ESD mat, in the system, or inside a bag.
- **Wrist Strap and Bonding Wire** – The wrist strap and bonding wire can be either directly connected between your wrist and bare metal on the hardware if the ESD mat is not required, or connected to the anti-static mat to protect hardware that is temporarily placed on the mat. The physical connection of the wrist strap and bonding wire between your skin, the ESD mat, and the hardware is known as bonding. Use only Field Service kits with a wrist strap, mat, and bonding wire. Never use wireless wrist straps. Always be aware that the internal wires of a wrist strap are prone to damage from normal wear and tear, and must be checked regularly with a wrist strap tester in order to avoid accidental ESD hardware damage. It is recommended to test the wrist strap and bonding wire at least once per week.
- **ESD Wrist Strap Tester** – The wires inside of an ESD strap are prone to damage over time. When using an unmonitored kit, it is a best practice to regularly test the strap prior to each service call, and at a minimum, test once per week. A wrist strap tester is the best method for doing this test. If you do not have your own wrist strap tester, check with your regional office to find out if they have one. To perform the test, plug the wrist-strap's bonding-wire into the tester while it is strapped to your wrist and push the button to test. A green LED is lit if the test is successful; a red LED is lit and an alarm sounds if the test fails.
- **Insulator Elements** – It is critical to keep ESD sensitive devices, such as plastic heat sink casings, away from internal parts that are insulators and often highly charged.
- **Working Environment** – Before deploying the ESD Field Service kit, assess the situation at the customer location. For example, deploying the kit for a server environment is different than for a desktop or portable environment. Servers are typically installed in a rack within a data center; desktops or portables are typically placed on office desks or cubicles. Always look for a large open flat work area that is free of clutter and large enough to deploy the ESD kit with additional space to accommodate the type of system that is being repaired. The workspace should also be free of insulators that can cause an ESD event. On the work area, insulators such as Styrofoam and other plastics should always be moved at least 12 inches or 30 centimeters away from sensitive parts before physically handling any hardware components.
- **ESD Packaging** – All ESD-sensitive devices must be shipped and received in static-safe packaging. Metal, static-shielded bags are preferred. However, you should always return the damaged part using the same ESD bag and packaging that the new part arrived in. The ESD bag should be folded over and taped shut and all the same foam packing material should be used in the original box that the new part arrived in. ESD-sensitive devices should be removed from packaging only at an ESD-protected work surface, and parts should never be placed on top of the ESD bag because only the inside of the bag is shielded. Always place parts in your hand, on the ESD mat, in the system, or inside an anti-static bag.
- **Transporting Sensitive Components** – When transporting ESD sensitive components such as replacement parts or parts to be returned to Dell, it is critical to place these parts in anti-static bags for safe transport.

ESD protection summary

It is recommended that all field service technicians use the traditional wired ESD grounding wrist strap and protective anti-static mat at all times when servicing Dell products. In addition, it is critical that technicians keep sensitive parts separate from all insulator parts while performing service and that they use anti-static bags for transporting sensitive components.

Electrostatic discharge — ESD protection

ESD is a major concern when you handle electronic components, especially sensitive components such as expansion cards, processors, memory DIMMs, and system boards. Very slight charges can damage circuits in ways that may not be obvious, such as intermittent problems or a shortened product life span. As the industry pushes for lower power requirements and increased density, ESD protection is an increasing concern.

Due to the increased density of semiconductors used in recent Dell products, the sensitivity to static damage is now higher than in previous Dell products. For this reason, some previously approved methods of handling parts are no longer applicable.

Two recognized types of ESD damage are catastrophic and intermittent failures.

- **Catastrophic** – Catastrophic failures represent approximately 20 percent of ESD-related failures. The damage causes an immediate and complete loss of device functionality. An example of catastrophic failure is a memory DIMM that has received a static shock and immediately generates a "No POST/No Video" symptom with a beep code emitted for missing or nonfunctional memory.
- **Intermittent** – Intermittent failures represent approximately 80 percent of ESD-related failures. The high rate of intermittent failures means that most of the time when damage occurs, it is not immediately recognizable. The DIMM receives a static shock, but the tracing is merely weakened and does not immediately produce outward symptoms related to the damage. The weakened trace may take weeks or months to melt, and in the meantime may cause degradation of memory integrity, intermittent memory errors, etc.

The more difficult type of damage to recognize and troubleshoot is the intermittent (also called latent or "walking wounded") failure.

Perform the following steps to prevent ESD damage:

- Use a wired ESD wrist strap that is properly grounded. The use of wireless anti-static straps is no longer allowed; they do not provide adequate protection. Touching the chassis before handling parts does not ensure adequate ESD protection on parts with increased sensitivity to ESD damage.
- Handle all static-sensitive components in a static-safe area. If possible, use anti-static floor pads and workbench pads.
- When unpacking a static-sensitive component from its shipping carton, do not remove the component from the anti-static packing material until you are ready to install the component. Before unwrapping the anti-static packaging, ensure that you discharge static electricity from your body.
- Before transporting a static-sensitive component, place it in an anti-static container or packaging.

Before working inside your computer

- 1 Ensure that your work surface is flat and clean to prevent the computer cover from being scratched.
- 2 Turn off your computer.
- 3 If the computer is connected to a docking device (docked), undock it.
- 4 Disconnect all network cables from the computer (if available).

 **CAUTION: If your computer has an RJ45 port, disconnect the network cable by first unplugging the cable from your computer.**

- 5 Disconnect your computer and all attached devices from their electrical outlets.
- 6 Open the display.
- 7 Press and hold the power button for few seconds, to ground the system board.

 **CAUTION: To guard against electrical shock unplug your computer from the electrical outlet before performing Step # 8.**

 **CAUTION: To avoid electrostatic discharge, ground yourself by using a wrist grounding strap or by periodically touching an unpainted metal surface at the same time as touching a connector on the back of the computer.**

- 8 Remove any installed ExpressCards or Smart Cards from the appropriate slots.

After working inside your computer

After you complete any replacement procedure, ensure that you connect external devices, cards, and cables before turning on your computer.

⚠ CAUTION: To avoid damage to the computer, use only the battery designed for this particular Dell computer. Do not use batteries designed for other Dell computers.

- 1 Connect any external devices, such as a port replicator or media base, and replace any cards, such as an ExpressCard.
- 2 Connect any telephone or network cables to your computer.

⚠ CAUTION: To connect a network cable, first plug the cable into the network device and then plug it into the computer.

- 3 Connect your computer and all attached devices to their electrical outlets.
- 4 Turn on your computer.

Removing and installing components

This section provides detailed information on how to remove or install the components from your computer.

Recommended tools

The procedures in this document require the following tools:

- Phillips #0 screwdriver
- Phillips #1 screwdriver
- Small plastic scribe

Screw size list

Table 1. Latitude 7390 - screw size list

Component	M2.5 x 6	M2 x 5	M2.5 x 3.5	M2 x 3	M2.5 x 4	M2 x 2.5	M2 x 2
Back cover	8 (captive screws)						
Battery—3-cell		1					
Battery—4-cell		2					
SSD module				1			
Heat sink module				4			
System fan				2			
Speaker				4			
WWAN card				1			
WLAN card				1			
Power connector port				1			
ESD bracket				1			
EDP bracket				2			
Touchpad buttons						2	
Fingerprint reader						1	
LED board						1	
Smart card reader cage						2	
Keyboard Lock bracket					1		
Display hinge			6				
Display panel(Not Applicable for HUD assembly)							2

Component	M2.5 x 6	M2 x 5	M2.5 x 3.5	M2 x 3	M2.5 x 4	M2 x 2.5	M2 x 2
Antenna—Infinity displays(Not Applicable for HUD assembly)				2			
Keyboard support plate						19	
Keyboard							5
System board				9			
Memory module bracket				1			

Subscriber Identification Module (SIM) card

Removing SIM card or SIM card tray

NOTE: SIM card or SIM card tray removal is only available on systems that are shipped with WWAN module. Hence, removing procedure is only applicable for systems that are shipped with WWAN module.

CAUTION: Removing the SIM card when the computer is On, may cause data loss or damage the card. Ensure that your computer is turned off or the network connections are disabled.

- 1 Insert a paperclip or a SIM card removal tool into the pinhole on the SIM card tray [1].
- 2 Use a scribe to pull the SIM card tray [2].
- 3 Remove the SIM card, if a SIM card is available from the SIM card tray.

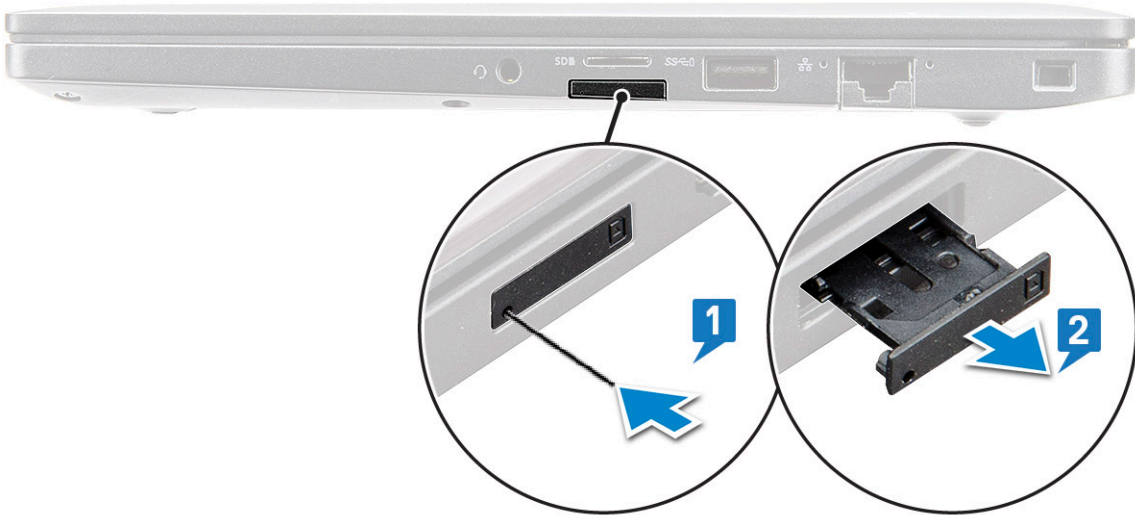

NOTE: For Latitude 7390 , the SD memory card must be removed before replacing any system components. Failure to remove the SD memory card before the disassembly of other components may result in damage to the system

Replacing SIM card

NOTE: You can replace a SIM card only for those systems that are shipped with WWAN module.

- 1 Insert a paperclip or a SIM card removal tool into the pinhole on the SIM card tray.
- 2 Use a scribe to pull the SIM card tray.
- 3 Place on the SIM card on the tray.

- 4 Insert the SIM card tray into the slot.

Base cover

Removing base cover

- 1 Follow the procedure in [Before working inside your computer](#).
- 2 To release the base cover:
 - a Loosen the M2.5 x 6 captive screws (8) that secure the base cover to the computer [1].
NOTE: Exercise caution when loosening the screws. Angle the screwdriver to match the head of the front corners of screw, to avoid a possible stripped screw head.
 - b Use a plastic scribe to release the base cover from the edge and lift it from the computer [2].
NOTE: Pry the edges starting from SIM card tray button clockwise.

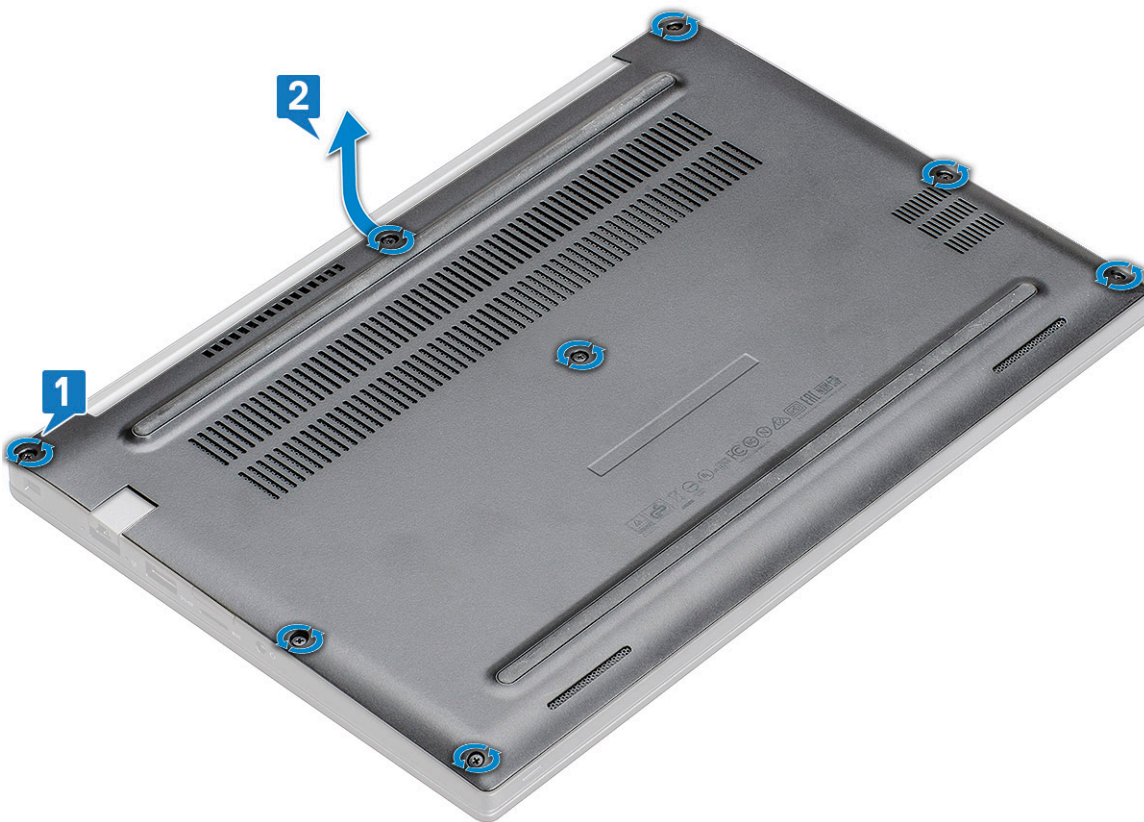

CAUTION: Exercise caution when loosening the screws. Angle the screwdriver to match the head of the screw (front corners on the laptop base cover) to avoid a possible stripped screw head.

- 3 Lift the base cover from the computer.



Installing base cover

- 1 Align the base cover tabs to the slots on the edges of the computer.
- 2 Press the edges of the cover until it clicks into place.
- 3 Tighten the M2.5 x 6.0 captive screws to secure the base cover to the computer.

i **Remember:** Exercise caution when tightening the screws. Angle the screw driver to match the head of the screw to avoid a possible stripped screw head.

- 4 Follow the procedure in [After working inside your computer](#).

Battery

Removing 3-cell battery

- 1 Follow the procedure in [Before working inside your computer](#).
- 2 Remove the [base cover](#).
- 3 To remove the battery:
 - a Disconnect the battery cable from the connector on the system board [1].
 - b Remove the M2 x 5 screw (1) that secures the battery to the computer [2].
 - c Lift the battery from the computer [3].

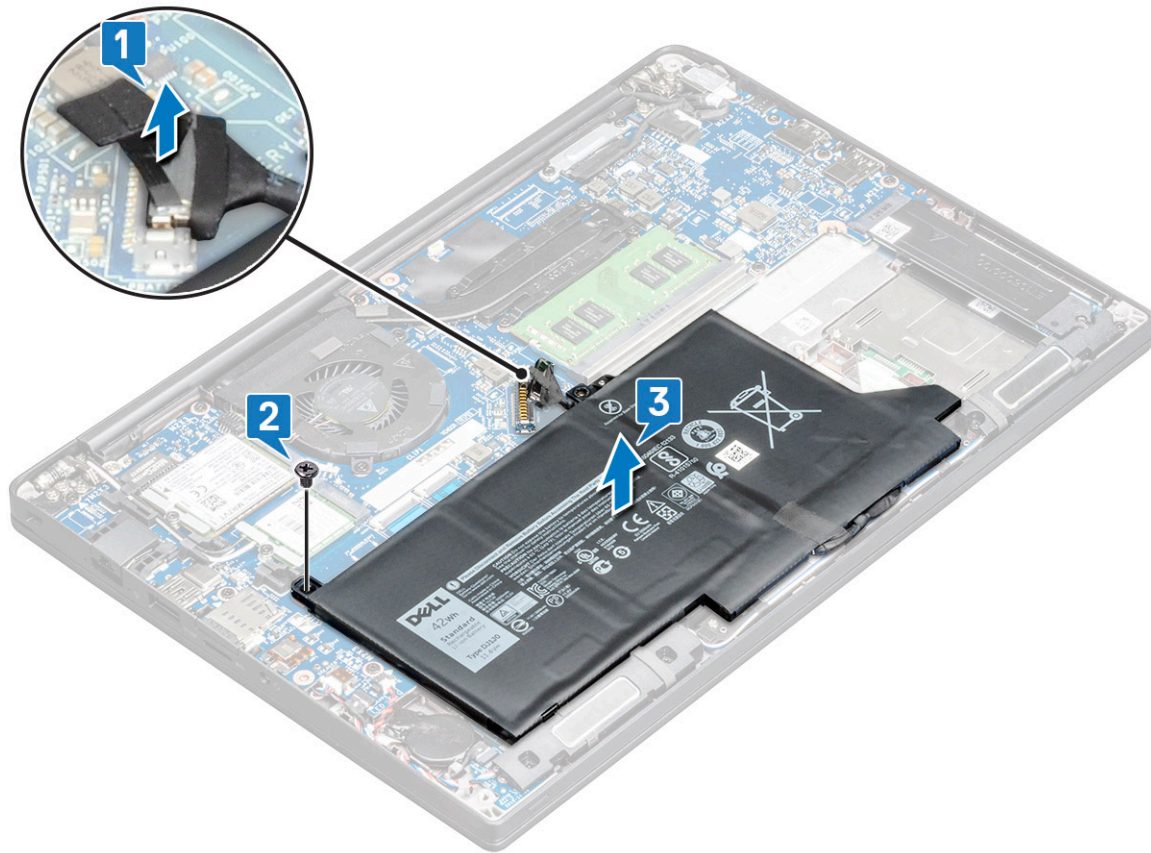

Installing 3-cell battery

- 1 Insert the battery into the slot on the computer.
- 2 Route the battery cable through the routing clip and connect the battery cable to the connector on the system board.

NOTE: Route the battery cable, if the cable at the base of the battery is un-routed.

- 3 Replace the M2 x 5 screw to secure the battery to the computer.
- 4 Install the [base cover](#)
- 5 Follow the procedure in [After working inside your computer](#).

Removing 4-cell battery

- 1 Follow the procedure in [Before working inside your computer](#).
- 2 Remove the [base cover](#).
- 3 To remove the battery:
 - a Disconnect the battery cable from the connector on the system board [1].
 - b Remove the M2 x 5 screw (2) that secure the battery to the computer[2].
 - c Lift the battery from the computer [3].

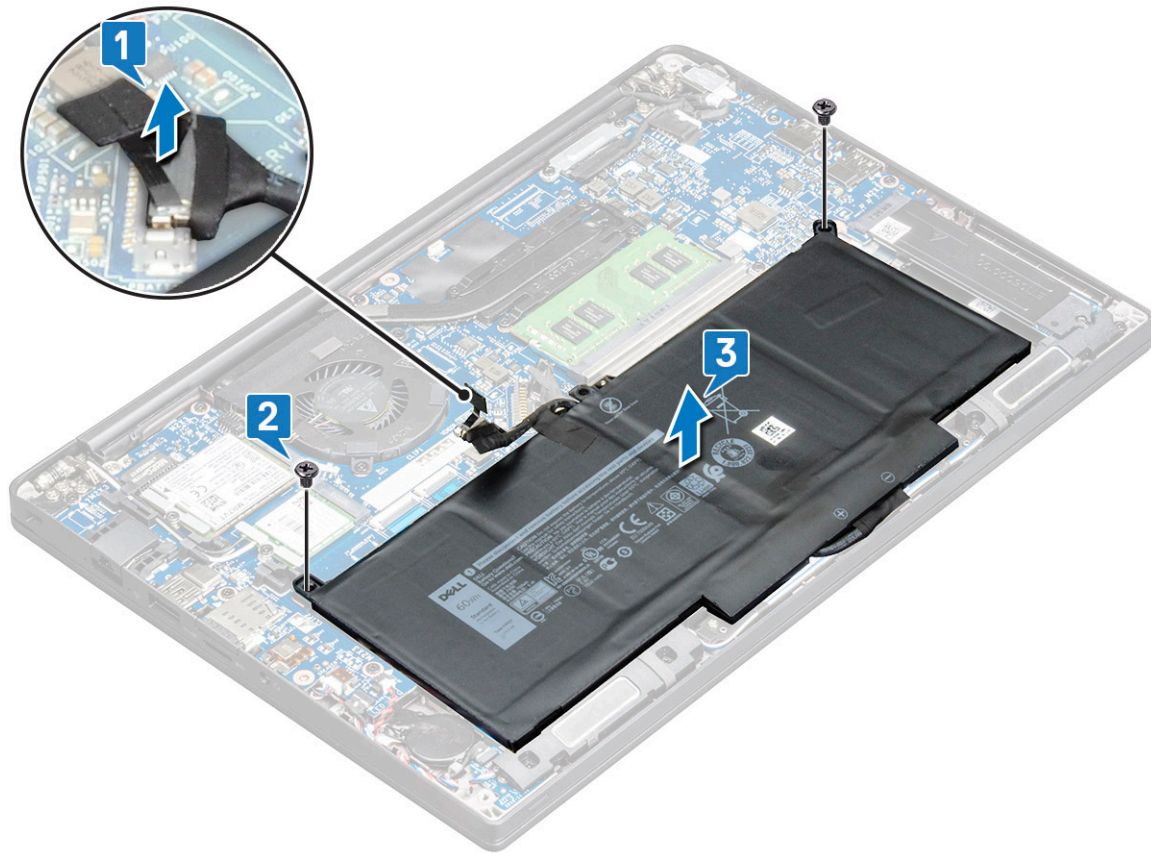

Installing 4-cell battery

- 1 Insert the battery into the slot on the computer.
- 2 Route the battery cable through the routing clip and connect the battery cable to the connector on the system board.

NOTE: Route the battery cable, if the cable at the base of the battery is un routed.

- 3 Replace the M2 x 5 screws (2) to secure the battery to the computer.
- 4 Install the [base cover](#)
- 5 Follow the procedure in [After working inside your computer](#).

PCIe Solid State Drive (SSD)

Removing PCIe SSD

- 1 Follow the procedure in [Before working inside your computer](#).
- 2 Remove the :
 - a [base cover](#)
 - b [battery](#)
- 3 To remove the PCIe SSD:
 - a Loosen the M2 x3 captive screw that secure the SSD bracket [1].
 - b Remove the SSD bracket [2].
 - c Remove the PCIe SSD from the connector on the system board [3].

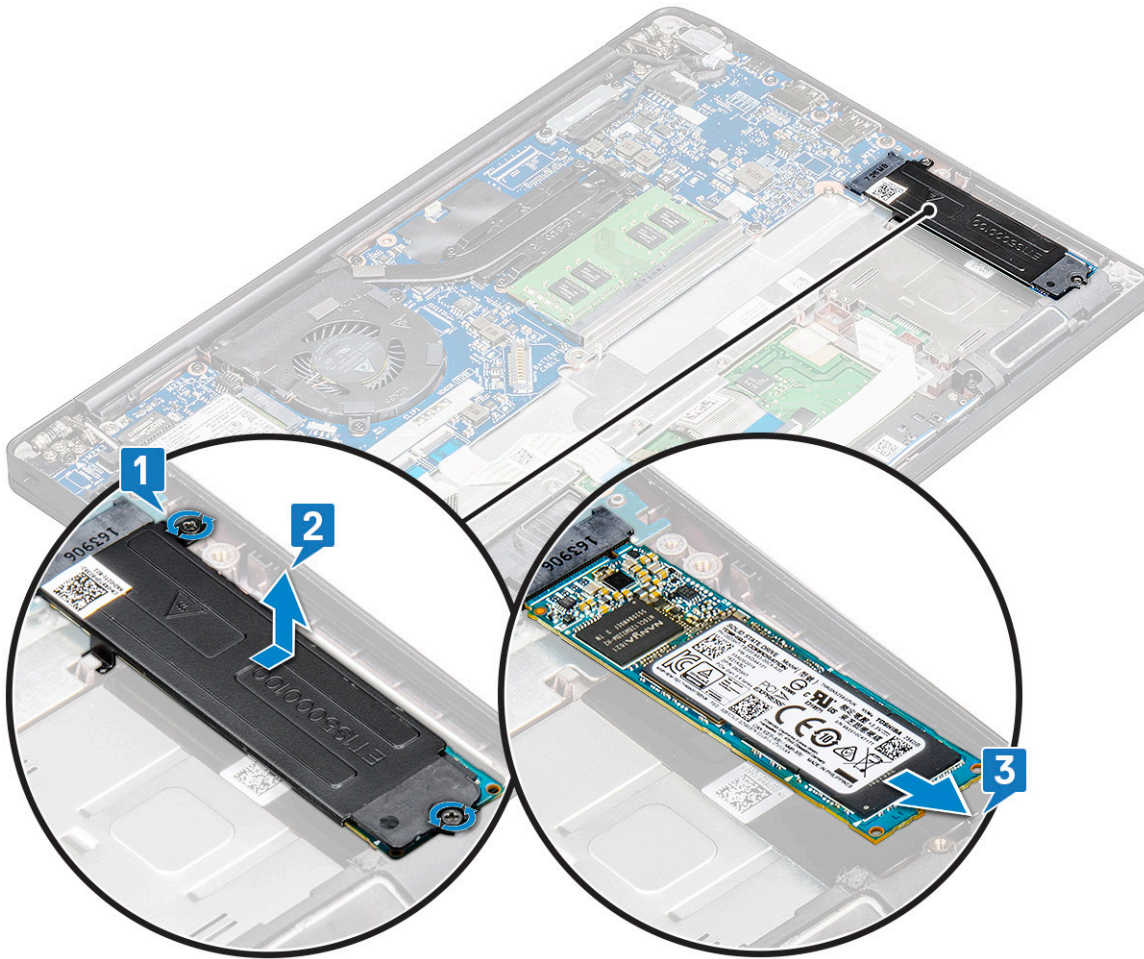

Removing PCIe SSD without bracket

- 1 Follow the procedure in [Before working inside your computer](#).
- 2 Remove the :
 - a [base cover](#)
 - b [battery](#)
- 3 To remove the PCIe SSD:
 - a Loosen the M2.0x3.0 captive screw that secure the SSD bracket [1].
 - b Slightly lift the SSD and pull out from its connector [2].

NOTE: Ensure to lift the PCIe SSD card by an angle NOT more than 30°.

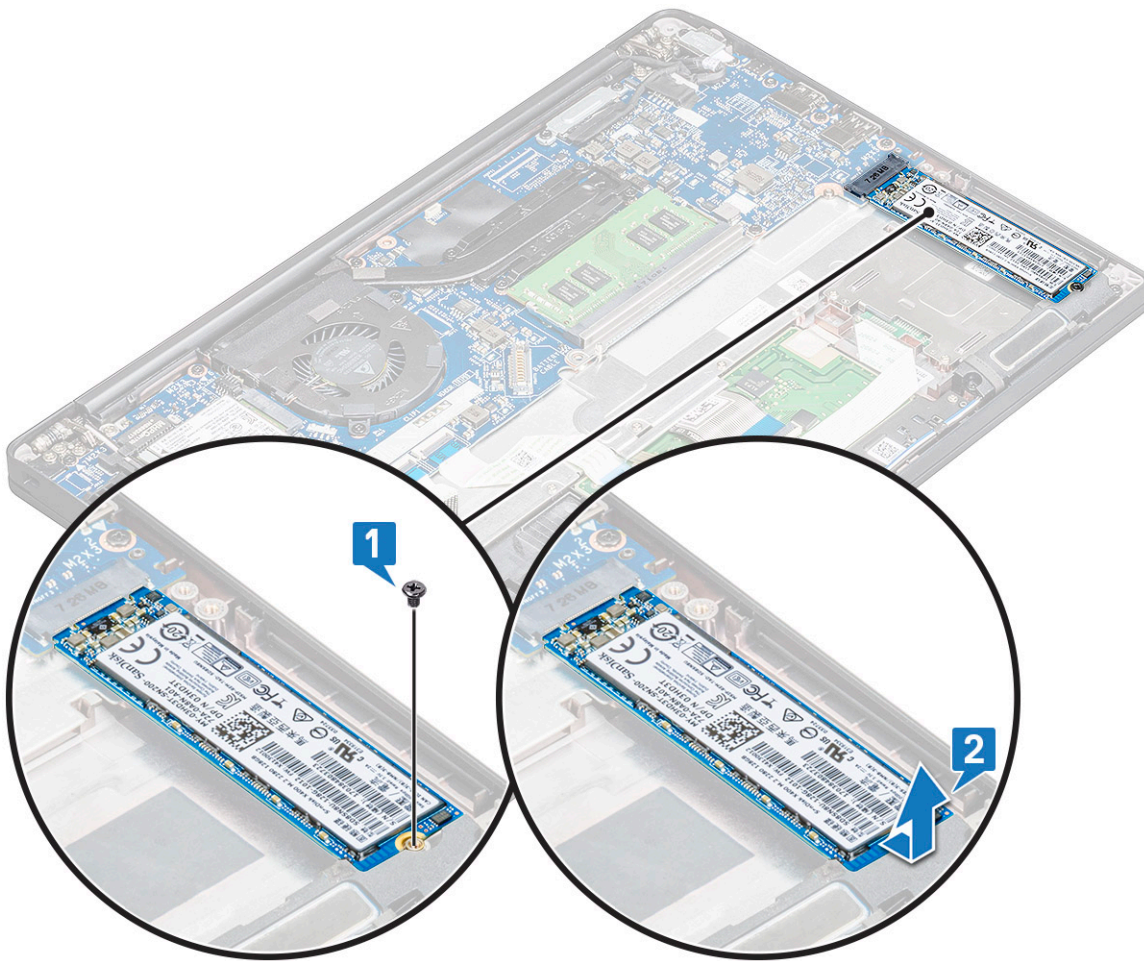

Installing PCIe SSD

- 1 Insert the PCIe SSD card into the connector.
- 2 Install the SSD bracket over the PCIe SSD card.

NOTE: When installing the SSD bracket, ensure that the tab on the bracket is held securely with the tab on the palm rest.

NOTE: Ensure to install the bracket is the system is shipped with bracket.

- 3 Tighten the M2 x 3 screws to secure it the SSD bracket.
- 4 Install the
 - a battery
 - b base cover
- 5 Follow the procedure in [After working iinside your computer](#).

NOTE: For models shipped with NVMe SSDs, the SSD do not require installation of a thermal plate over the SSD, neither SATA SSDs require thermal plates.

SATA Solid State Drive (SSD)

Removing SATA SSD

- 1 Follow the procedure in [Before working inside your computer](#).
- 2 Remove the:
 - a [base cover](#)
 - b [battery](#)
- 3 To remove the SATA SSD:
 - a Remove the M2 x 3 screw that secures the SSD [1].
 - b Slide and lift the SSD to disconnect it from the connector [2].

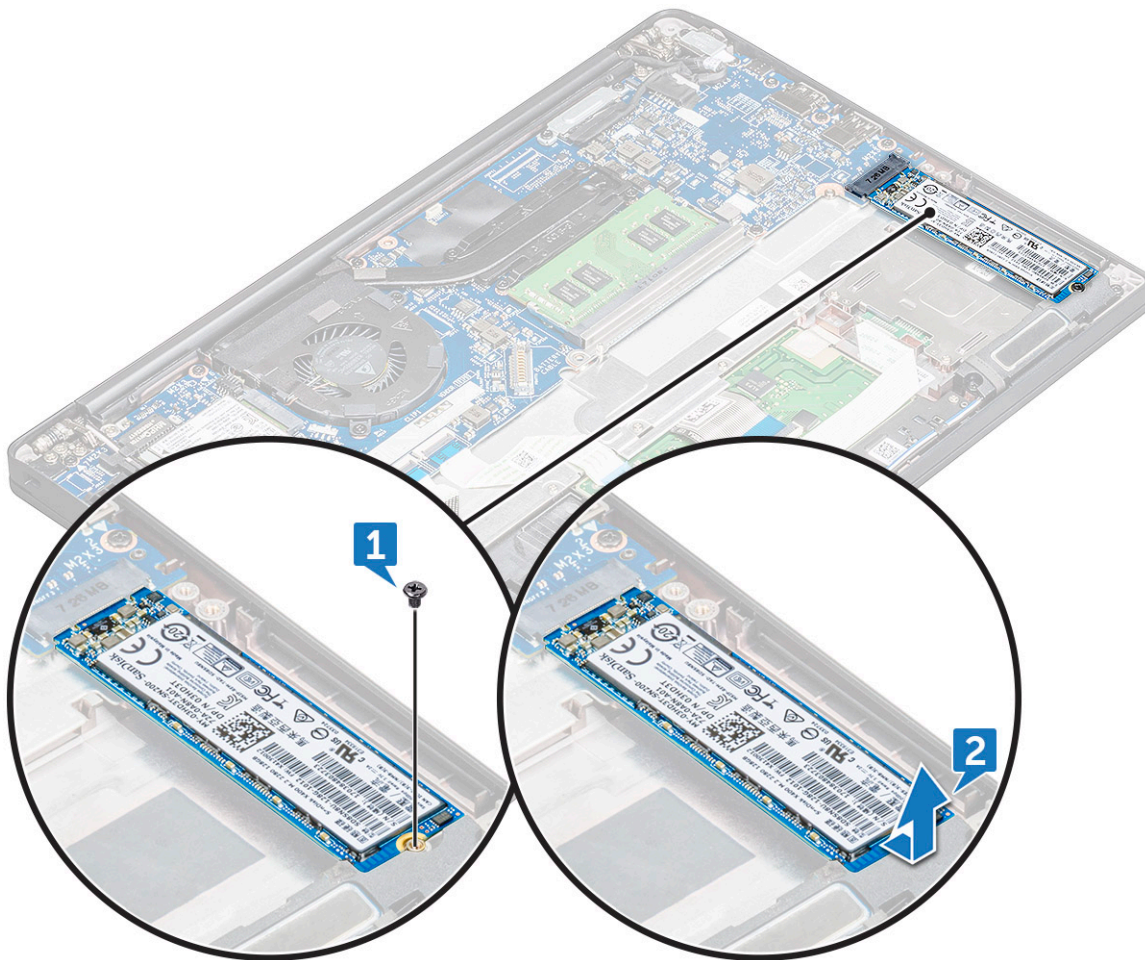

Installing SATA SSD

- 1 Insert the SATA SSD card into the connector.
- 2 Tighten the screw to secure the SATA SSD to the system board.
- 3 Install the:
 - a [battery](#)
 - b [base cover](#)
- 4 Follow the procedure in [After working inside your computer](#).

Speaker

Removing speaker module

- 1 Follow the procedure in [Before working inside your computer](#).
- 2 Remove the:
 - a [base cover](#)
 - b [battery](#)
- 3 To release the speaker module:
 - a Push to disconnect the speaker cable from the connector on the system board [1].

① | NOTE: Ensure to unroute the speaker cable from the routing clip.

① | NOTE: Use a plastic scribe to release the cable from the connector. Do not pull the cable as it may result in breakage.

- b Un-route the speaker cable from the routing clips [2].
- c Remove the tape that secures the speaker cables to the touchpad board [3].

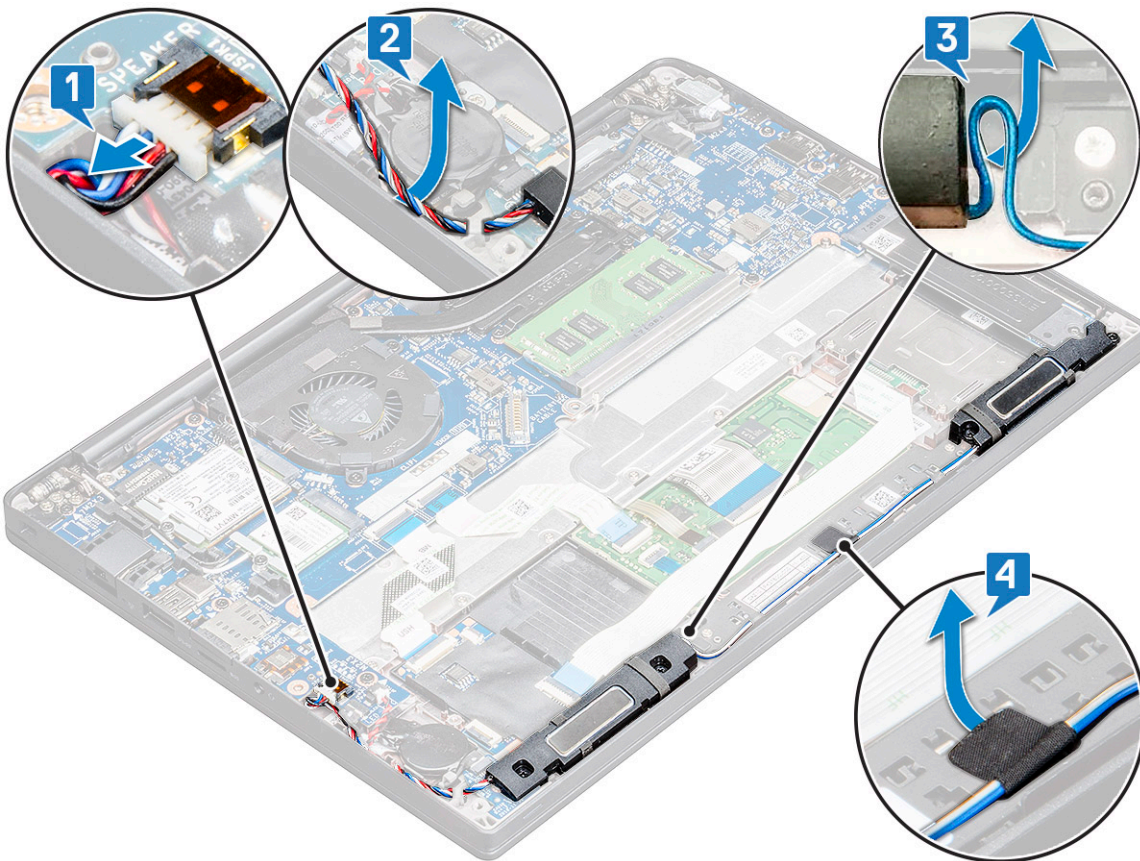

- 4 To remove the speaker module:
 - a Remove the M2.0x3.0 screws (4) that secure the speaker module to the computer [1].
 - b Lift the speaker module from the computer [2].

① | NOTE: Ensure to un-route the speaker cable from the routing clips.

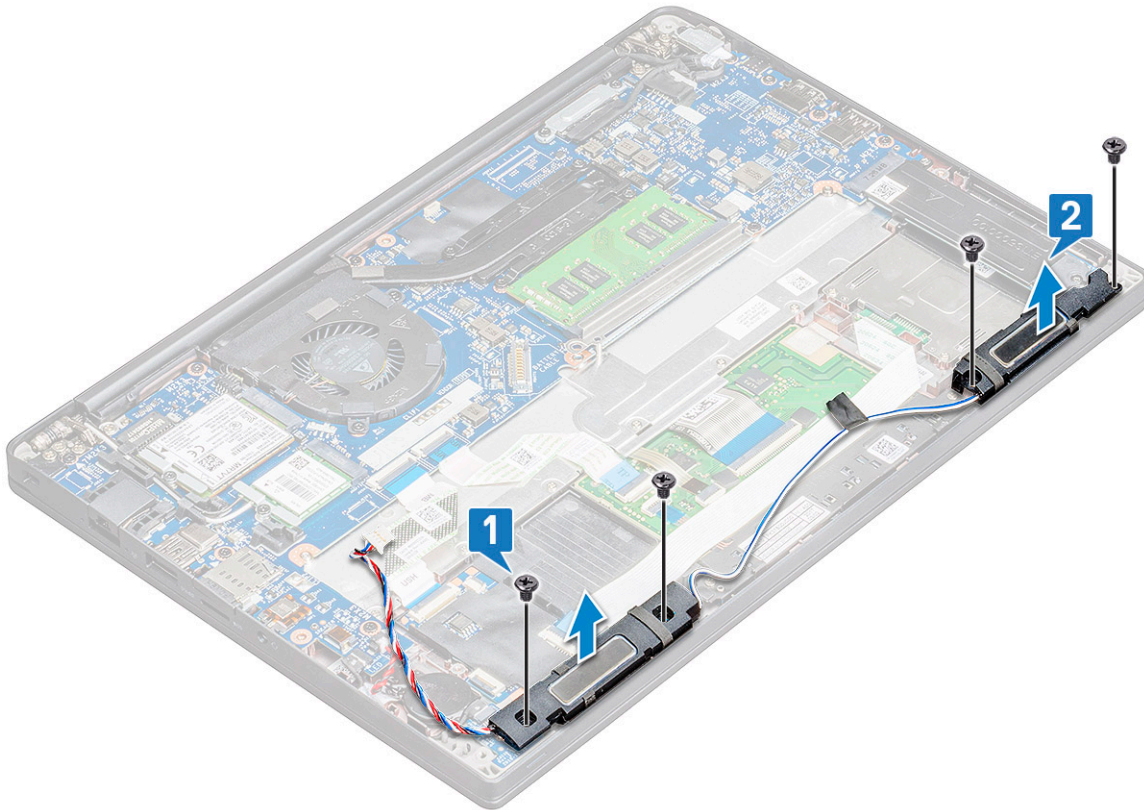

Installing speaker module

- 1 Place the speaker module into the slots on the computer.
- 2 Route the speaker cable through the retention clips on the computer.
- 3 Connect the speaker cable to the connector on the system board.
- 4 Install the:
 - a battery
 - b base cover
- 5 Follow the procedure in [After working inside your computer](#).

Coin cell battery

Removing the coin cell battery

- 1 Follow the procedure in [Before working inside your computer](#).
- 2 Remove the :
 - a base cover
 - b battery
- 3 To remove the coin cell battery:
 - a Disconnect the coin cell battery cable from the connector on the system board [1].
 - b Lift the coin cell battery to release it from the adhesive [2].

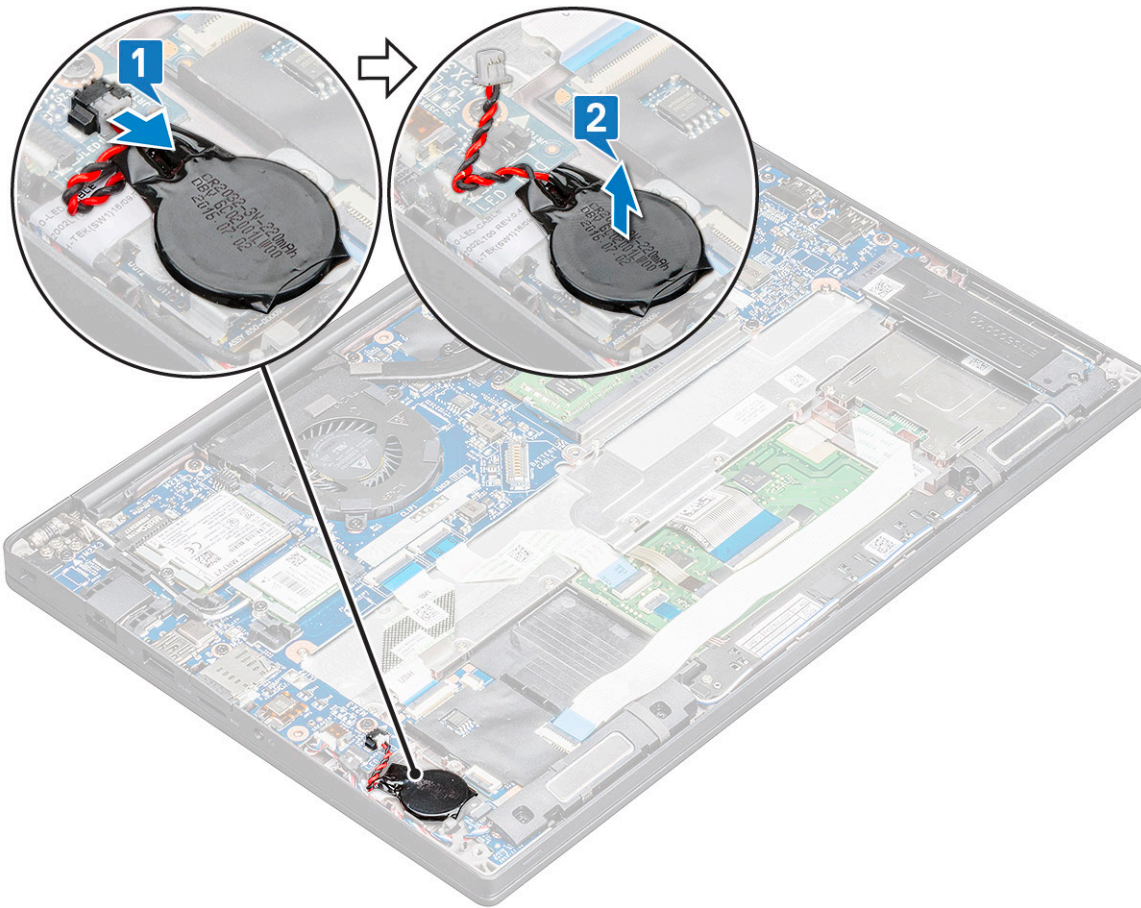

Installing coin cell battery

- 1 Affix the coin cell battery on the slot inside the computer.
- 2 Route the coin cell battery cable through the routing channel before connecting the cable.
- 3 Connect the coin cell battery cable to the connector on the system board.
- 4 Install the :
 - a battery
 - b base cover
- 5 Follow the procedure in [After working inside your computer](#).

WWAN card

Removing WWAN card

- 1 Follow the procedure in [Before working inside your computer](#).
- 2 Remove the :
 - a base cover
 - b battery
- 3 To remove the WWAN card:
 - a Remove the M2.0 x 3.0 screw that secures the metal bracket to the WWAN card [1].

NOTE: The WWAN card pops out by an angle 15°.

- b Lift the metal bracket that secures the WWAN card [2].
 - c Disconnect the WWAN cables from the connectors on the WWAN card with a plastic scribe.[3].
- NOTE:** Ensure to press the WWAN card, and then release the cables from the connectors.
- d Slide and lift the WWAN card from the connector on the system board [4].Lift the WWAN card from the computer .
- NOTE:** Ensure to lift the WWAN card by an angle NOT more than 35°.

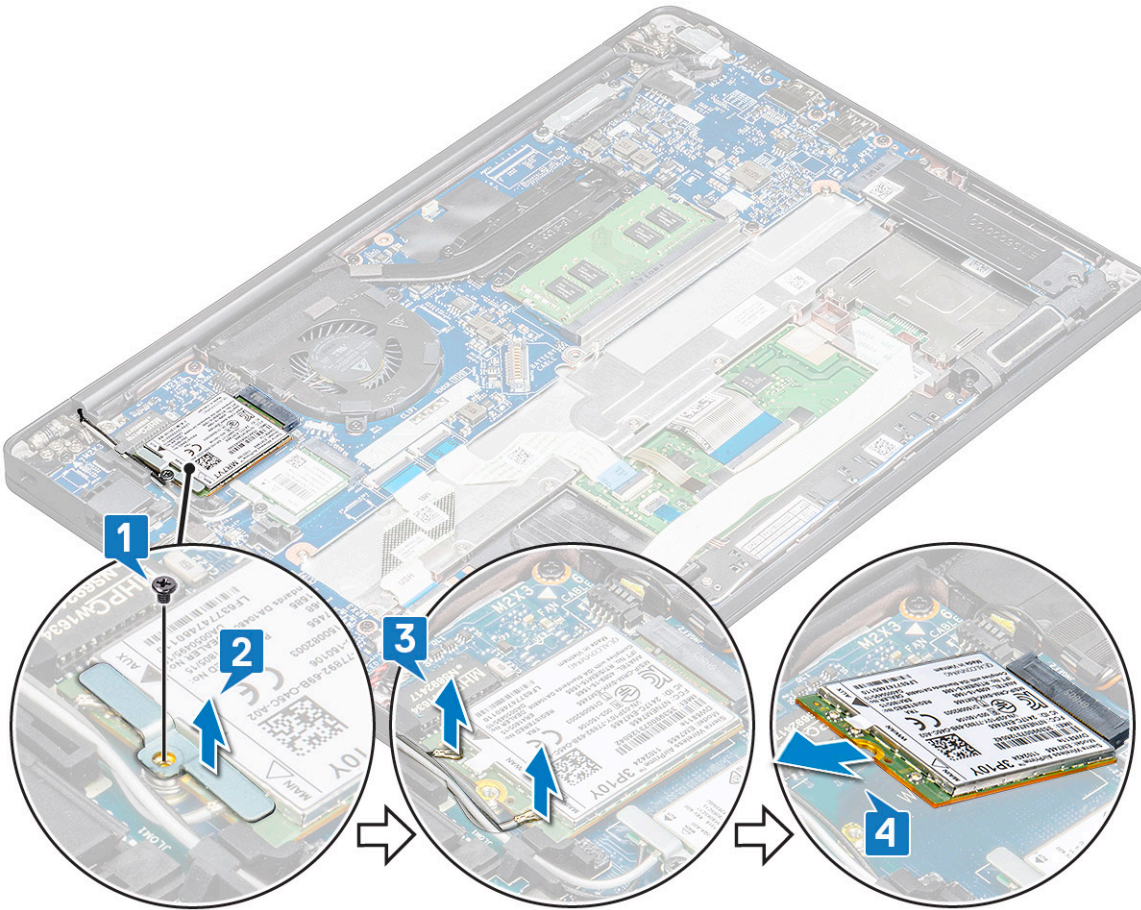

Installing WWAN card

- 1 Insert the WWAN card into the connector on the system board.
- 2 Connect the WWAN cables to the connectors on the WWAN card.
- 3 Place the metal bracket and tighten the M2.0 x 3.0 screw to secure it to the computer.
- 4 Install the :
 - a battery
 - b base cover
- 5 Follow the procedure in [After working inside your computer.](#)

NOTE: The IMEI number can also be found on the WWAN card.

WLAN card

Removing WLAN card

- 1 Follow the procedure in [Before working inside your computer](#).
- 2 Remove the :
 - a [base cover](#)
 - b [battery](#)
- 3 To remove the WLAN card:
 - a Remove the M2.0 x 3.0 screw that secures the metal bracket to the WLAN card [1].
 - b Lift the metal bracket [2].
 - c Disconnect the WLAN cables from the connectors on the WLAN card [3].
 - d Remove the WLAN card from the computer [4].

NOTE: Ensure NOT to pull the WLAN card more than 35°, to avoid damage to pin.

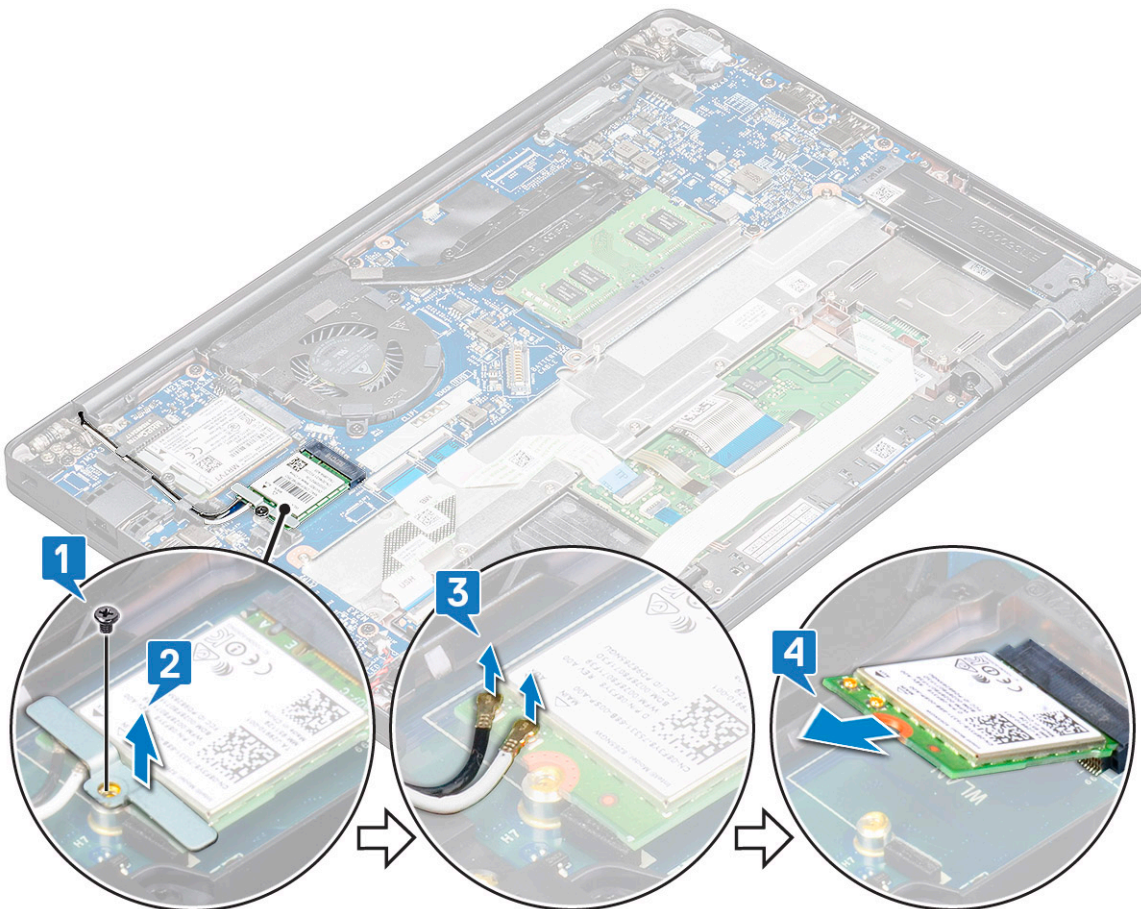

Installing WLAN card

- 1 Insert the WLAN card into the connector on the system board.
- 2 Connect the WLAN cables to the connectors on the WLAN card.
- 3 Place the metal bracket and tighten the M2.0 x 3.0 screw to secure it to the computer.

- 4 Install the :
 - a battery
 - b base cover
- 5 Follow the procedure in [After working inside your computer](#).

Memory modules

Removing memory module

- 1 Follow the procedure in [Before working inside your computer](#).
- 2 Remove the :
 - a base cover
 - b battery
- 3 To remove the memory module:
 - a Pull the clips securing the memory module until the module snaps-out [1].
 - b Remove the memory module from the connector on the system board [2].

 **NOTE:** Ensure to lift the memory module card by an angle NOT more than 35°.

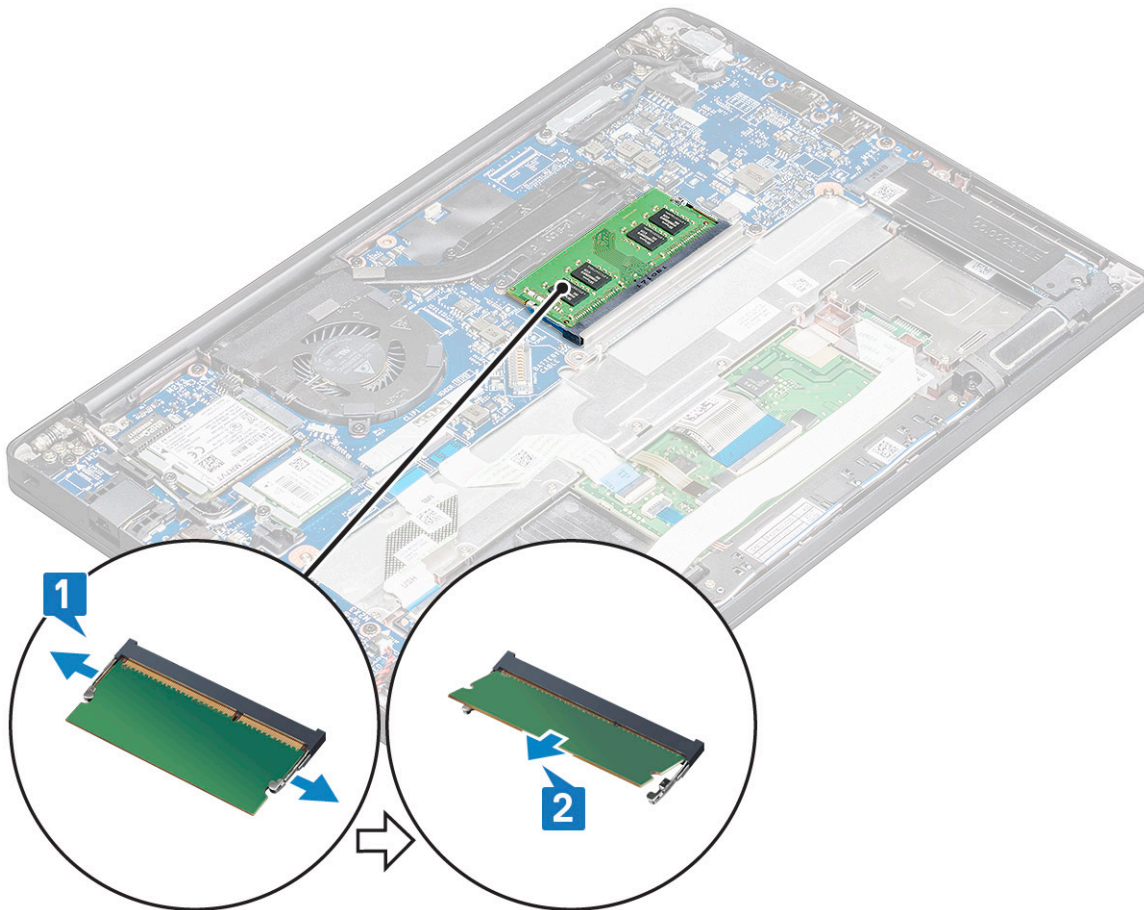

Installing memory module

- 1 Insert the memory module into the connector until snaps in.
- 2 Install the :
 - a [battery](#)
 - b [base cover](#)
- 3 Follow the procedures in [After working inside your computer](#).

Heat sink

Removing heat sink assembly

Heat sink assembly comprises of heat sink and the system fan.

- 1 Follow the procedure in [Before working inside your computer](#).
- 2 Remove the :
 - a [base cover](#)
 - b [battery](#)
- 3 To remove the heat sink assembly:

 **NOTE:** To identify the number of screws, see [screw list](#)

- a Remove the M2 x 5 screws (6) that secure the heat sink assembly to the system board [2].

 **NOTE:** Remove the screws in order of the callout numbers [1, 2, 3, 4] as printed on the heat sink assembly.

- b Lift the heat sink assembly from the system board [3].
- c Disconnect the fan cable from the system board [1]

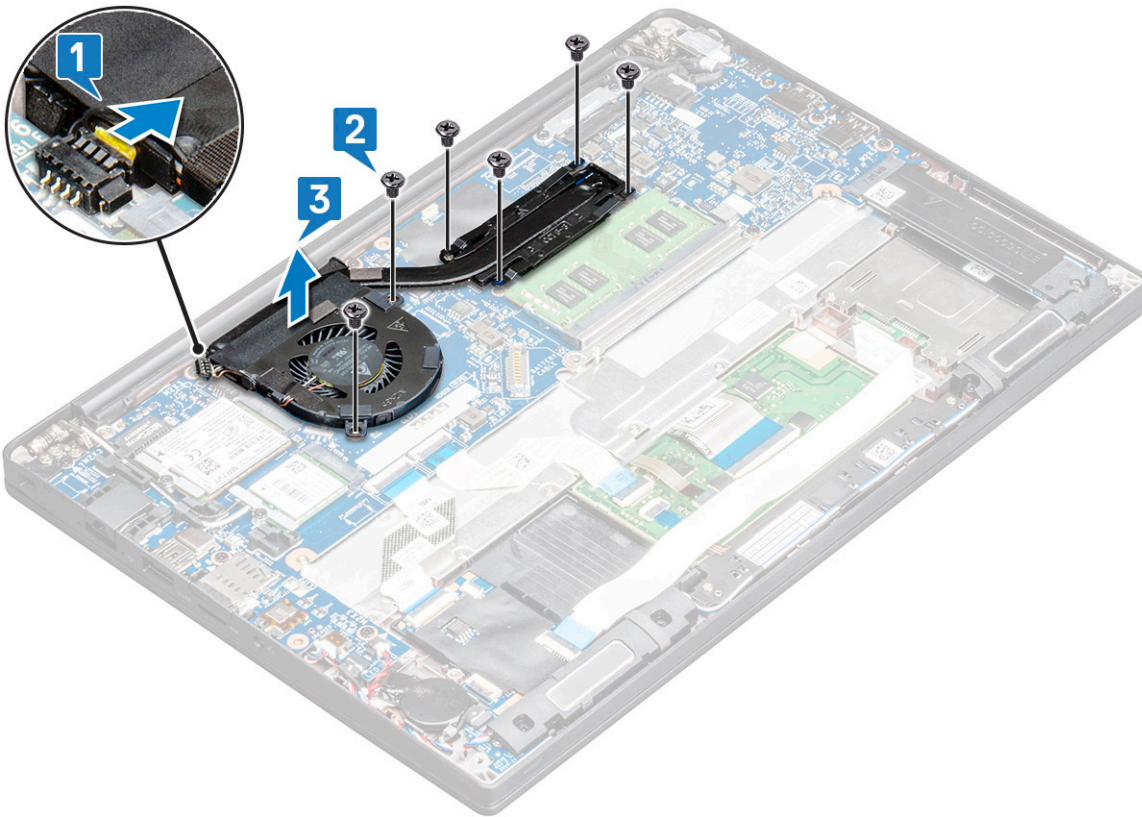

Installing heat sink assembly

Heat sink assembly comprises of heat sink and the system fan.

- 1 Align the heat sink assembly with screw holders on the system board and connect the fan cable to the connector on the system board..

NOTE: Ensure to first connect the fan cable to the system board before securing the heat-sink assembly onto the system board.

- 2 Tighten the M2 x 5 screws to secure the fan to the system board

NOTE: Ensure to connect fan cable before installing heatsink.

- 3 Install the :
 - a battery
 - b base cover
- 4 Follow the procedure in [After working inside your computer](#).

Power connector port

Removing power connector port

- 1 Follow the procedure in [Before working inside your computer](#).
- 2 Remove the :
 - a base cover
 - b battery
- 3 To remove the power connector port:

- a Disconnect the power connector port cable from the system board [1].

NOTE: Ensure to remove the adhesive tape that covers the connector.

NOTE: Use a plastic scribe to release the cable from the connector. Do not pull the cable as it may result in breakage

- b Remove the M2.0x3.0 screw (1) to release the metal bracket on the power connector port [2].
- c Lift the metal bracket from the computer [3].
- d Remove the power connector port from the computer [4].

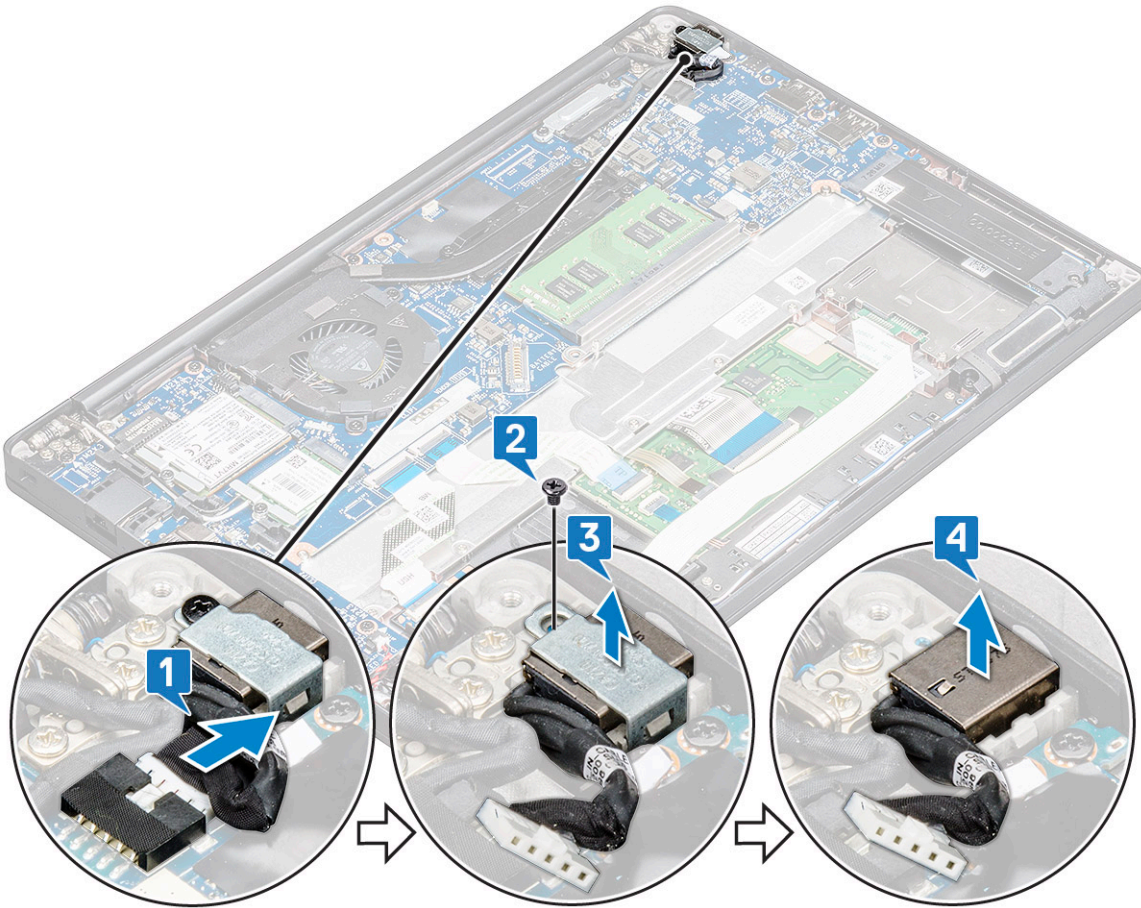

Installing power connector port

- 1 Install the power connector port into the slot on the computer.
- 2 Place the metal bracket on the power connector port.
- 3 Tighten the M2.0x3.0 screw to secure the power connector port to the computer.
- 4 Connect the power connector port cable to the connector on the system board.
- 5 Install the :
 - a battery
 - b base cover
- 6 Follow the procedure in [After working inside your computer](#).

LED board

Removing LED board

1 Follow the procedure in [Before working inside your computer](#).

2 Remove the :

- a [base cover](#)
- b [battery](#)

3 To remove the LED board:

- a Disconnect the LED cable from the system board [1].

CAUTION: Avoid pulling the cable as it would result in breaking the cable connector. Instead, use a scribe to release the LED cable from its connector.

- b Unroute the LED cable from the routing channel [2].
- c Remove the M2 x 2.5 (1) screw that secures the LED board to the computer [3].
- d Lift the LED board from the computer [4].

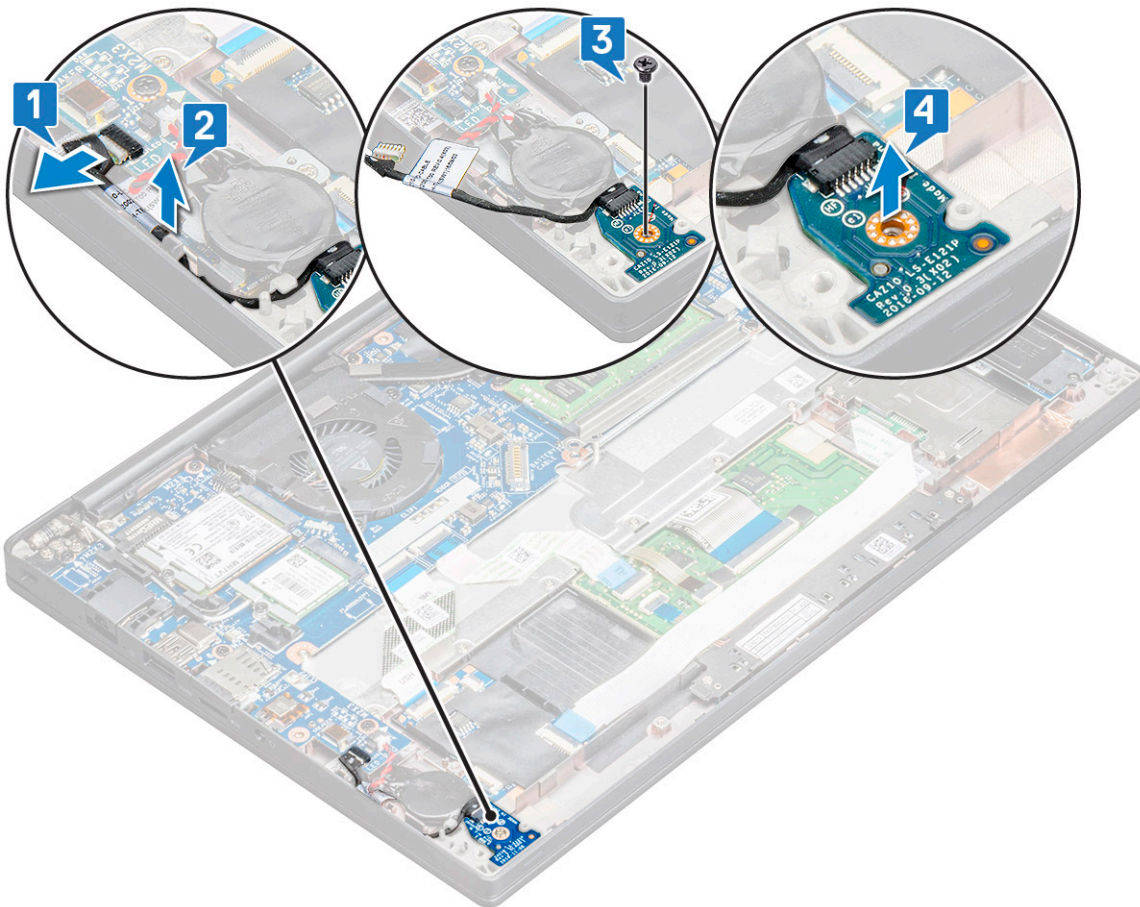

Installing LED board

1 Insert the LED board into the slot on the computer.

2 Tighten the M2 x 2.5 screw (1) to secure the LED board.

3 Connect the LED cable to the system board.

- 4 Install the :
 - a battery
 - b base cover
- 5 Follow the procedure in [After working inside your computer](#).

Smart card module

Removing smart card cage

- 1 Follow the procedure in [Before working inside your computer](#).
- 2 Remove the:
 - a base cover
 - b battery
 - c PCIe SSD card
 - d SATA SSD
- 3 To disconnect the smart card cable:
 - a Disconnect the smart card cable [1].

NOTE: Ensure to gently push the connector, to avoid damage to the smart card head.
 - b Lift the smart card cable that is affixed to the touchpad module [2].

NOTE: Ensure to pull gently to release it with adhesive tape.

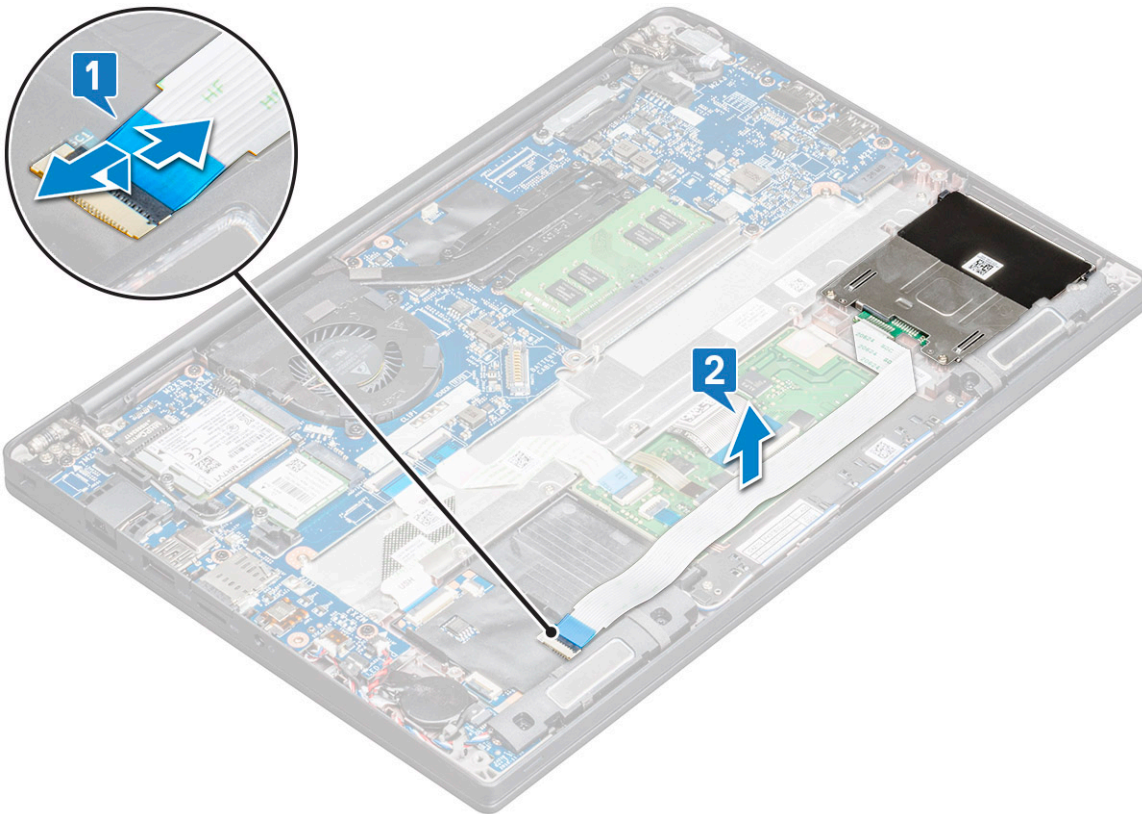

- 4 To remove the smart card cage:

NOTE: To identify the number of screws, see [screw list](#)

 - a Remove the M2 x 3 screws (2) that secure the smart card cage to the computer [1].
 - b Slide and lift the smart card cage from the computer [2].

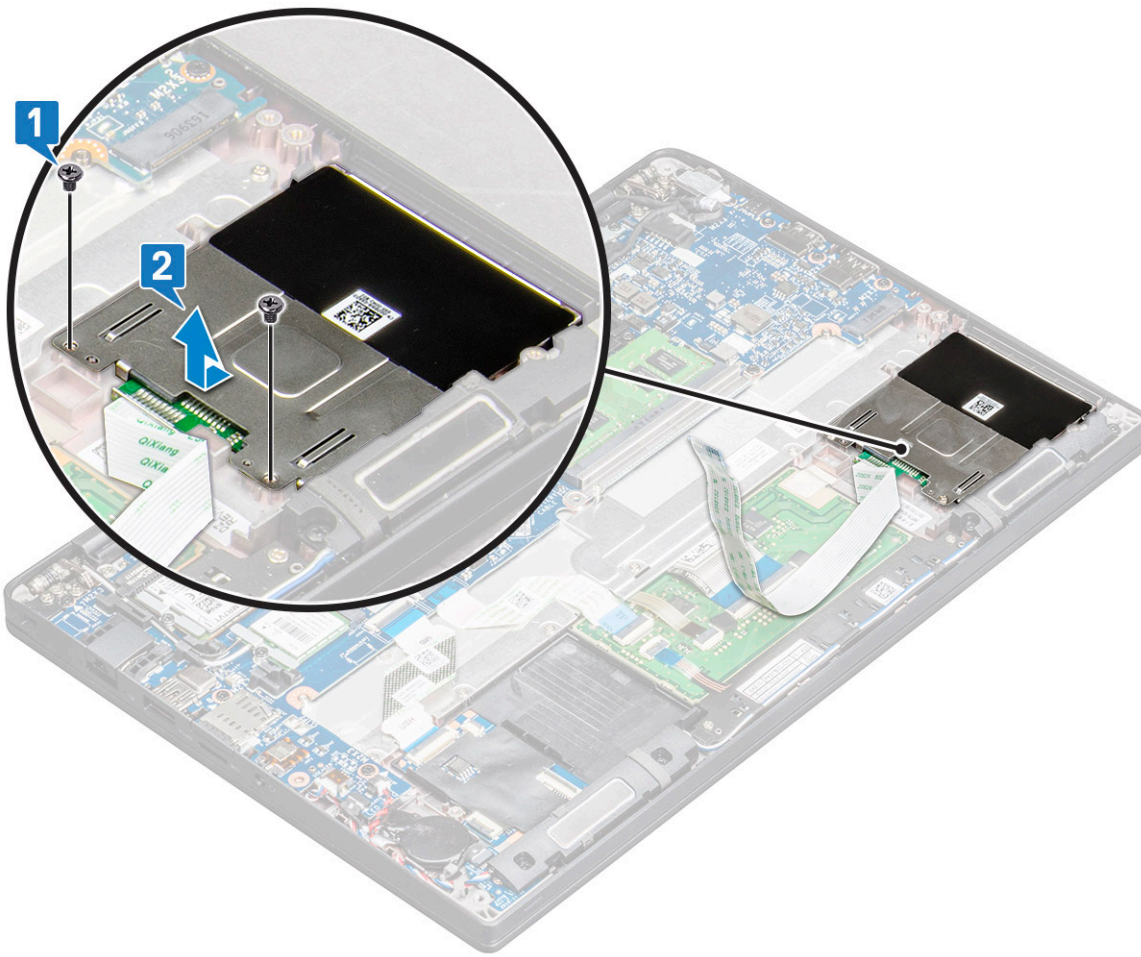

Installing smart card cage

- 1 Slide the smart card cage into the slot to align with the tabs on the computer.
- 2 Tighten the M2 x 3 screws to secure the smart card cage to the computer.
- 3 Affix the smart card cable and connect it to the connector on the computer .
- 4 Install the:
 - a SATA SSD
 - b PCIe SSD card
 - c battery
 - d base cover
- 5 Follow the procedure in [After working inside your computer](#).

Touchpad buttons board

Removing touchpad buttons board

- 1 Follow the procedure in [Before working inside your computer](#).
- 2 Remove the:
 - a base cover
 - b battery

- 3 To disconnect the smart card cable:
 - a Disconnect the smart card cable [1].
 - b Lift the smart card cable that is affixed to the computer [2] to reveal the touchpad buttons board cable.
 - c Remove the adhesive tape that secures the speaker cable to the touchpad panel [3].

NOTE: Un-route the speaker cable from the routing clips from the touchpad buttons.

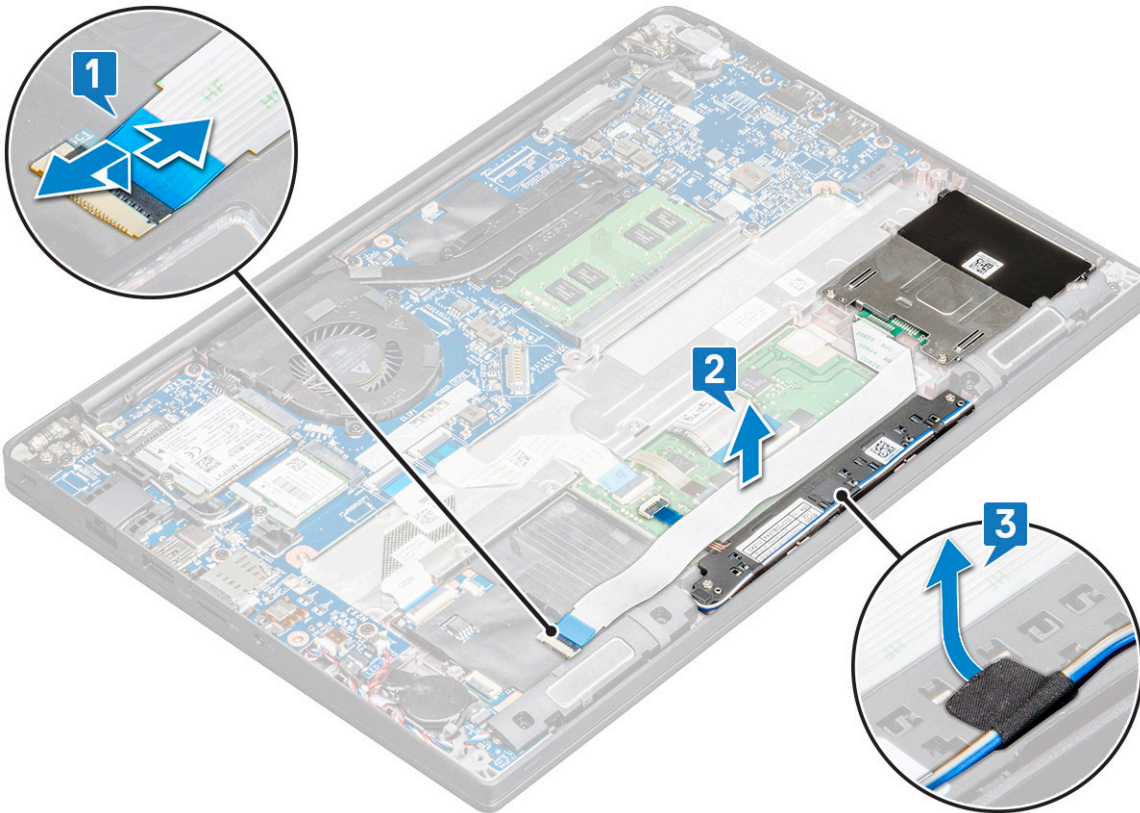

- 4 To remove the touchpad buttons board:
 - a Disconnect the touchpad buttons board cable from the touchpad board [1].
 - NOTE:** The touchpad buttons board cable is below the smart card cable. Ensure to lift the latch, to release the touchpad button board cable.
 - b Remove M2.0 x 2.5 screws (2) that secure the touchpad buttons board [2].
 - c Lift the touchpad buttons board from the computer [3].

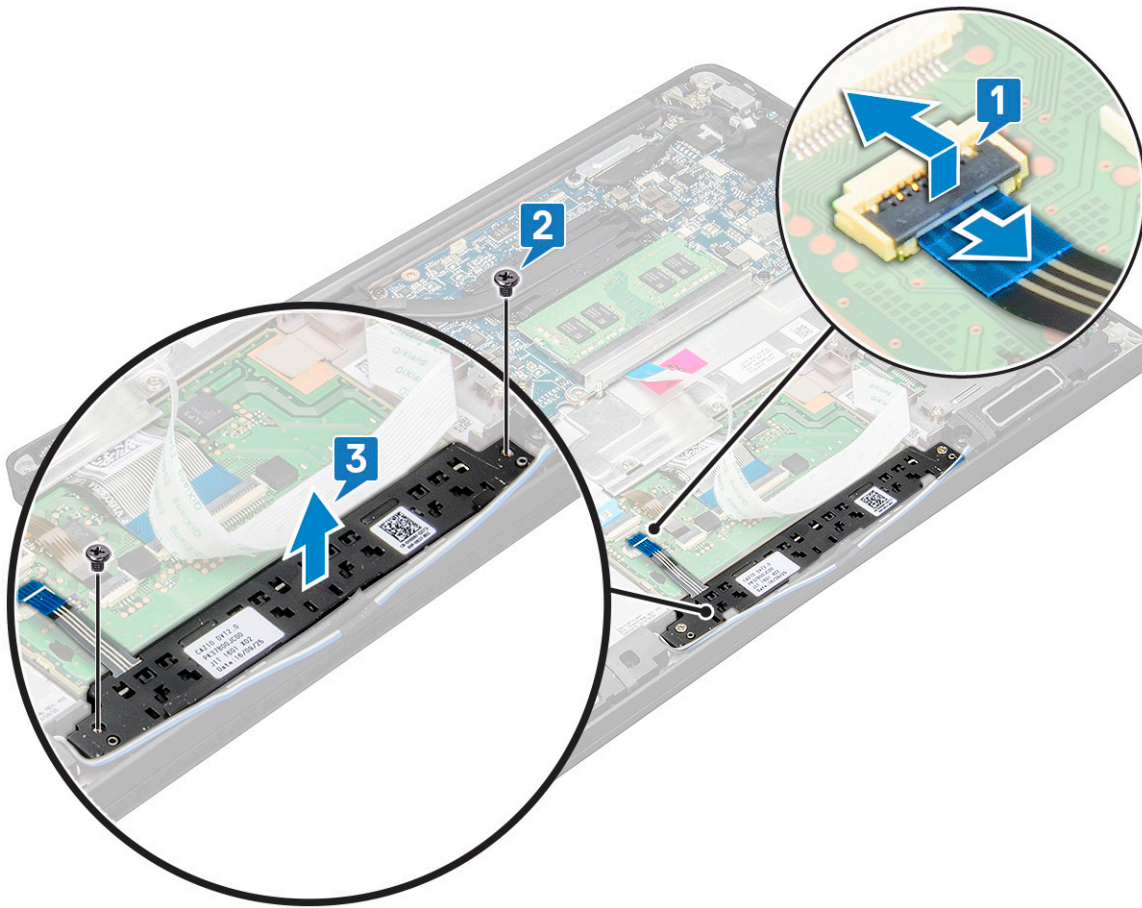

Installing touchpad buttons board

- 1 Insert the touchpad buttons board into the slot to align the tabs with the grooves on the computer.
- 2 Tighten the screws to secure the touchpad buttons board to the computer.
- 3 Connect the touchpad buttons board cable to the connector on the touchpad board.
- 4 Affix the smart card cable and connect it to the connector on the computer
- 5 Install the:
 - a speaker
 - b battery
 - c base cover
- 6 Follow the procedure in [After working inside your computer](#).

Display Assembly

Removing display assembly

- 1 Follow the procedure in [Before working inside your computer](#).
- 2 Remove the:
 - a base cover
 - b battery
 - c WLAN card

d WWAN card

NOTE: To identify the number of screws, see [screw list](#).

- 3 To remove the display assembly:
 - a Unroute the WLAN and WWAN cables from the routing channels [1].
 - b Remove the M2 x 3 screws that secure the eDP bracket [2].
 - c Lift the eDP bracket from the eDP cable [3].
 - d Disconnect the eDP cable from its connector on the system board [4].

NOTE: In touch-configuration system, ensure to remove the touch display cable that is connected to its connector on the system board.

- e Remove the adhesive tape that secures the eDP cable [5].

NOTE: In touch-configuration system, you find both eDP cable and touch display cable that is secured with adhesive tape.

- f Disconnect the cable from its connector on the system board [6].

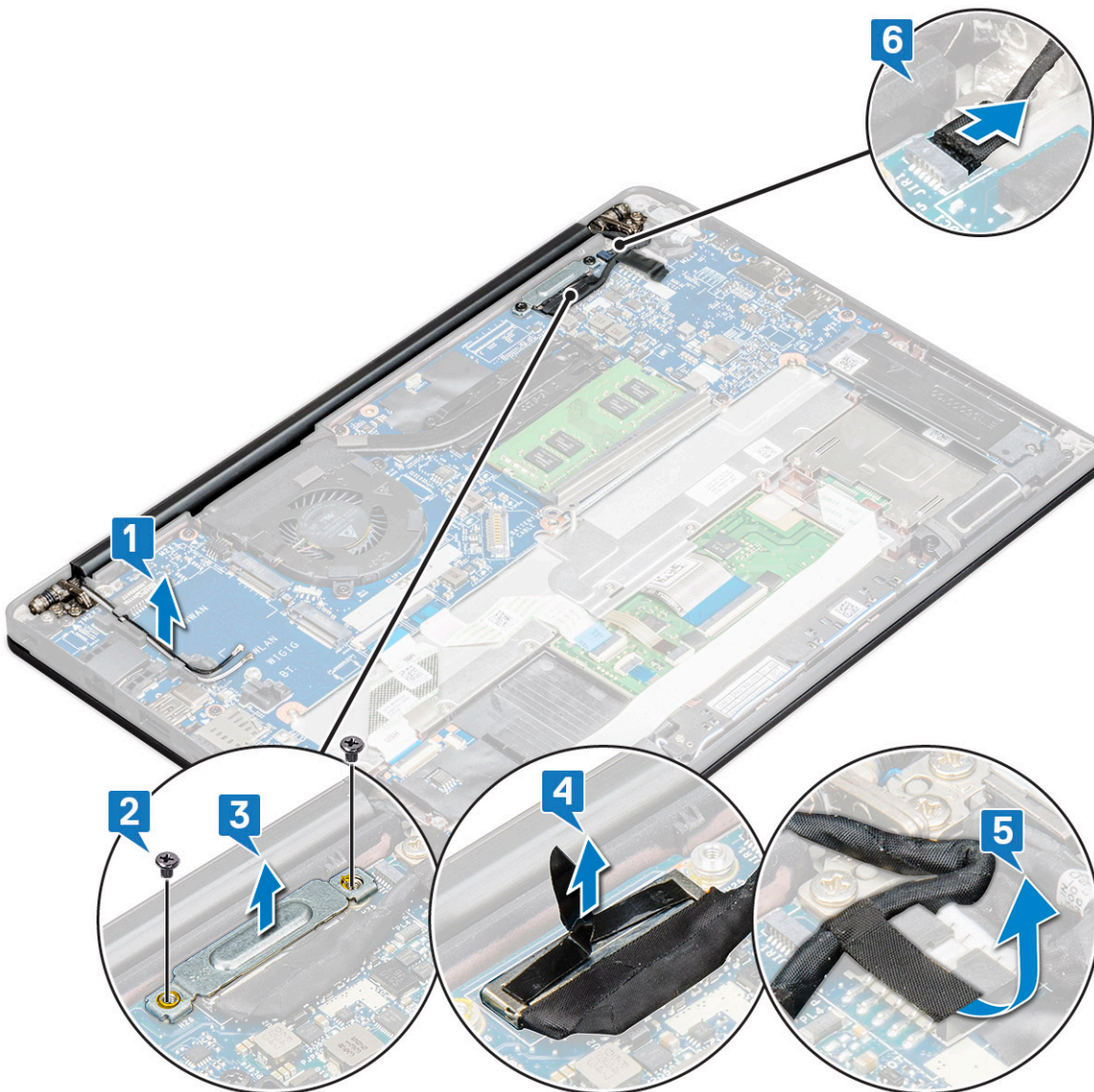

- 4 To remove the display assembly:
 - a Open the display of the computer, and lay it on a flat surface at 180 degree angle.
 - b Remove the M2 x 3.5 screws (6) that secure the display hinge to the display assembly [1].
 - c Lift the display assembly from the computer [2].

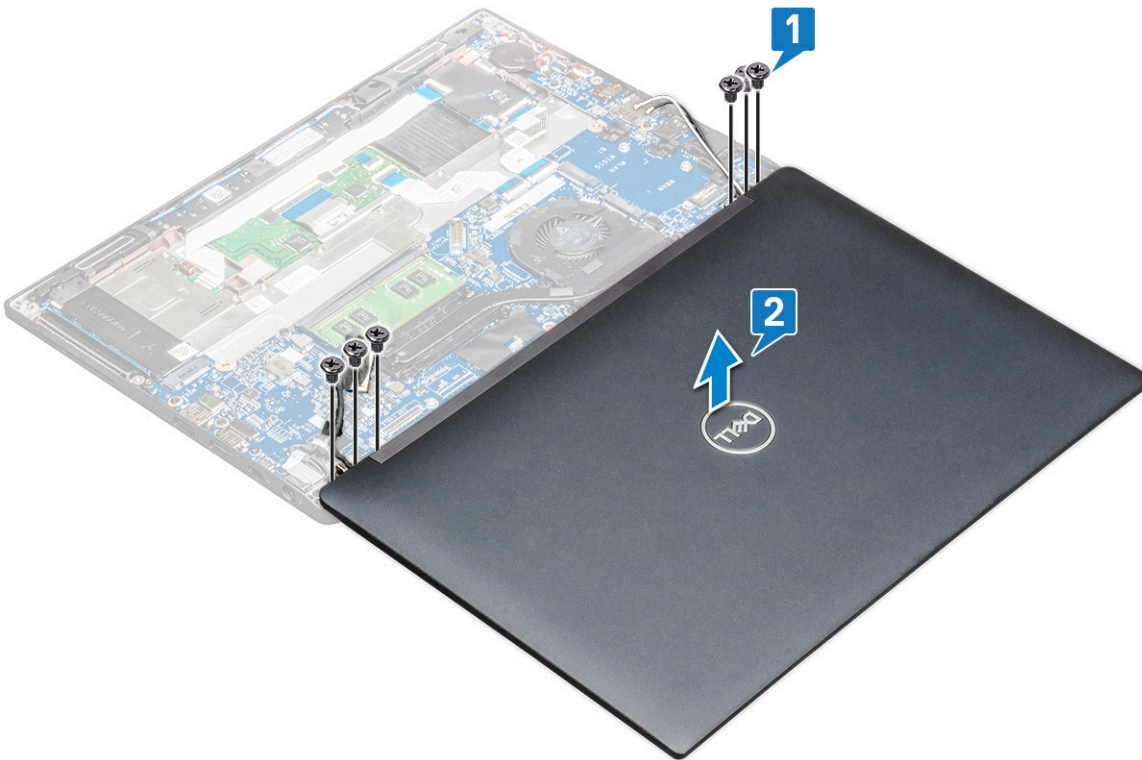

Installing display assembly

- 1 Place the base of the computer on a plane surface of a table and position it closer to the edge of the table.
- 2 Install the display assembly to align it with the display hinge holders on the system.
- 3 Hold the display assembly, tighten the M2 x 3.5 screws to secure the display hinges on the system display assembly with the system unit.
- 4 Affix the tapes to secure the eDP cable (display cable).

NOTE: For touch-configuration system you see touch display cable, secure it with tapes along with the eDP cable.

- 5 Connect the eDP cable to the connector on the system board.

NOTE: For touch-configuration system, connect the touch display cable to its connector on the system board.

- 6 Install the eDP metal bracket on the eDP cable and tighten the M2 x 3 screws.
- 7 Route the WLAN and WWAN cables through the routing channels.
- 8 Install the:
 - a WLAN card
 - b WWAN card
 - c battery
 - d base cover
- 9 Follow the procedure in [After working inside your computer](#).

Display hinge cap

Removing display hinge Cap

- 1 Follow the procedure in [Before working inside your computer](#).
- 2 Remove the:
 - a [base cover](#)
 - b [battery](#)
 - c [WLAN card](#)
 - d [WWAN card](#)
 - e [display assembly](#)

i | **NOTE:** To identify the number of screws, see [screw list](#)

- 3 Push the display hinge cap to the right.

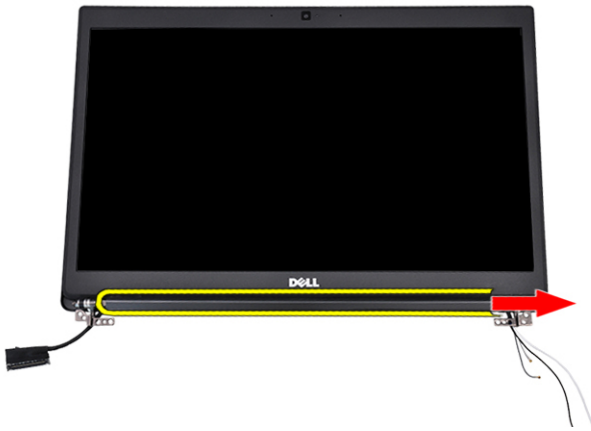

- 4 Remove the display hinge cap.

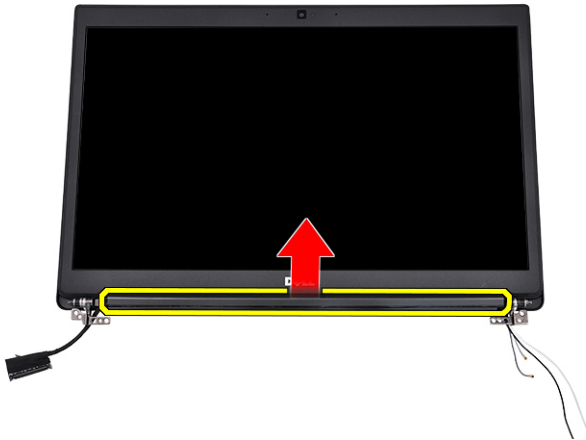

Installing display hinge Cap

- 1 Insert the display hinge cap to the display assembly.
- 2 Push the display hinge cap to the left to secure it.

- 3 Install the:
 - a [display assembly](#)
 - b [WLAN card](#)
 - c [WWAN card](#)
 - d [battery](#)
 - e [base cover](#)
- 4 Follow the procedure in [After working inside your computer](#).

System board

Removing system board

- 1 Follow the procedure in [Before working inside your computer](#).

NOTE: If your computer is shipped with a WWAN card, then the removal of a blank SIM card tray is a requirement.

- 2 Remove the:

- a [SIM card](#)
- b [base cover](#)
- c [battery](#)
- d [memory module](#)
- e [PCIe SSD](#)
- f [SATA SSD](#)
- g [WLAN card](#)
- h [WWAN card](#)
- i [heat sink assembly](#)

- 1 To identify the screws, see [screw list](#)

- 3 To remove the memory module bracket:

- a Remove the M2 x 3 screw (1) that secure memory module bracket to the system board [1].

NOTE: The DDR ESD bracket is a pre-removal part when replacing the system board. Ensure that the DDR ESD bracket is reinstalled to the new replacement system board.

- b Lift the memory module bracket from the system board [2].

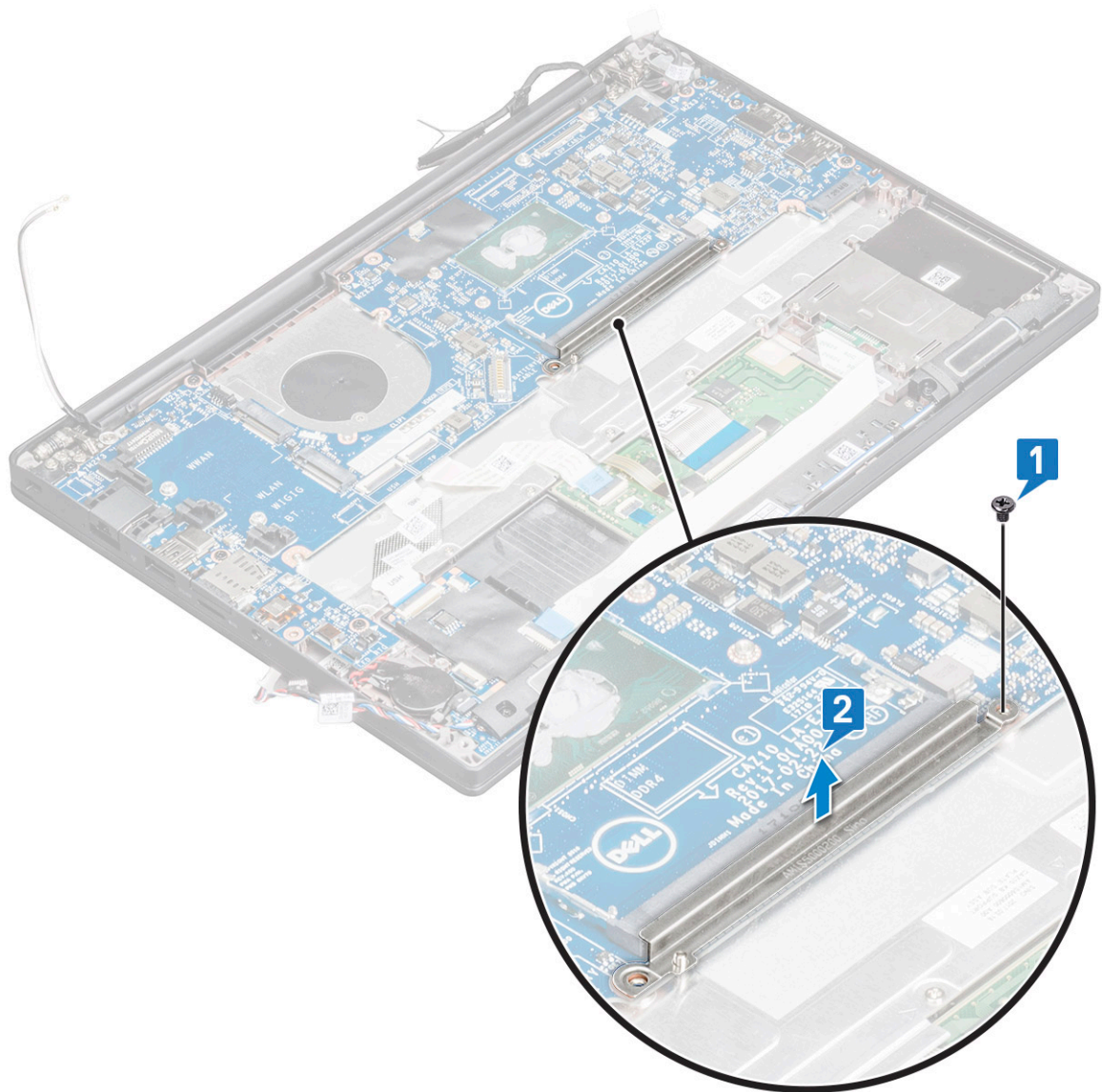

4 To disconnect the eDP cable:

- a Un route the WLAN and WWAN cables from the routing channels [1].
- b Remove the M2 x 3 screw (2) and lift the eDP cable bracket that secures to the system board [2,3].
- c Disconnect the clip that secures the cable to the system board [4].
- d Remove the adhesive tape that secures the eDP cable [5].
- e Disconnect the eDP cable from the system board [6].

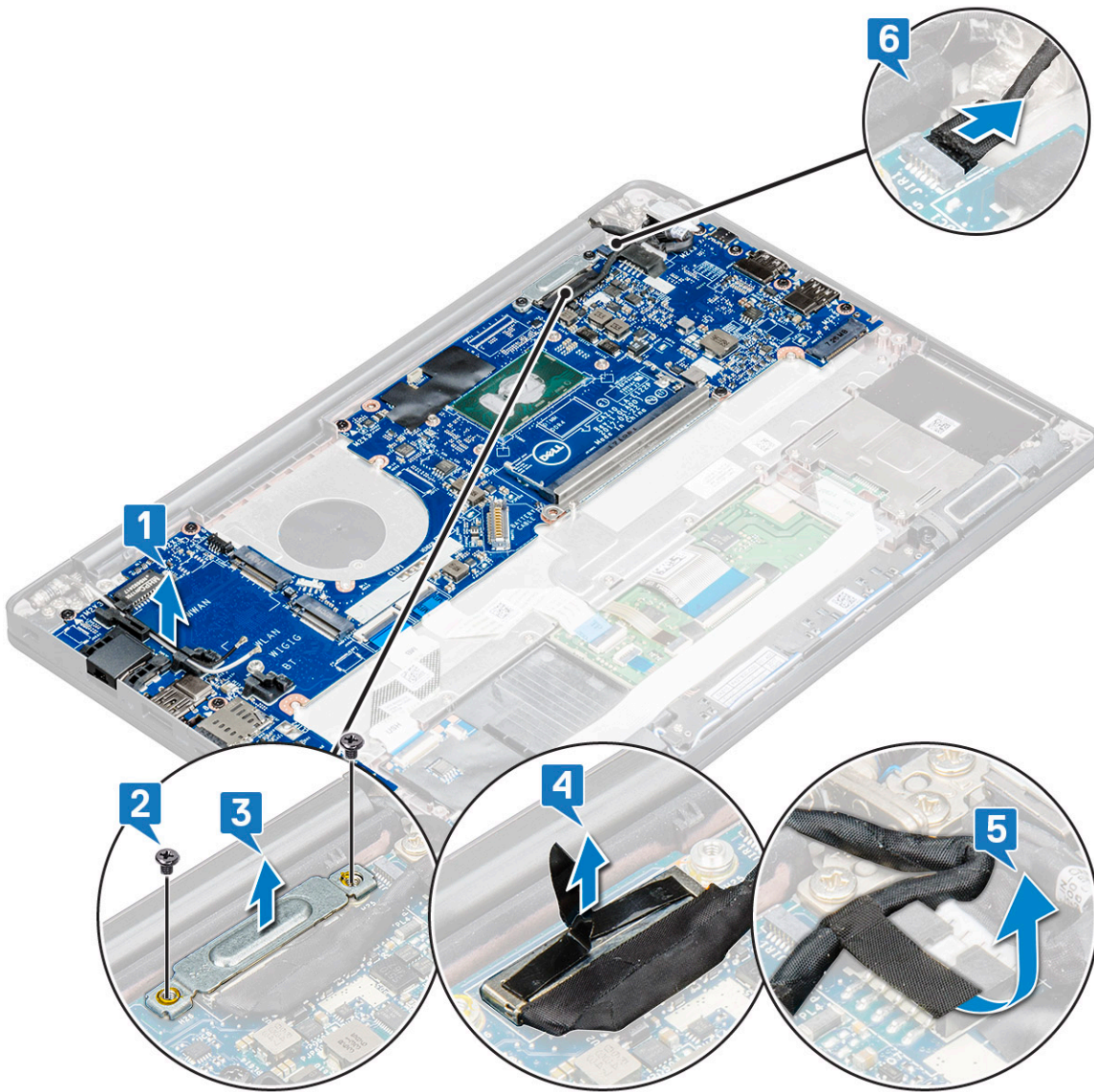

5 Disconnect the cables:

NOTE: To disconnect the speaker, LED board, coin cell battery and the power connector port cables, use a plastic scribe to release the cables from the connectors. Do not pull the cable as it may result in breakage

- a speaker cable [1]
- b LED board cable [2]
- c coin cell battery cable [3]
- d touchpad cable and UHS board cable [4]
- e power connector port [5]

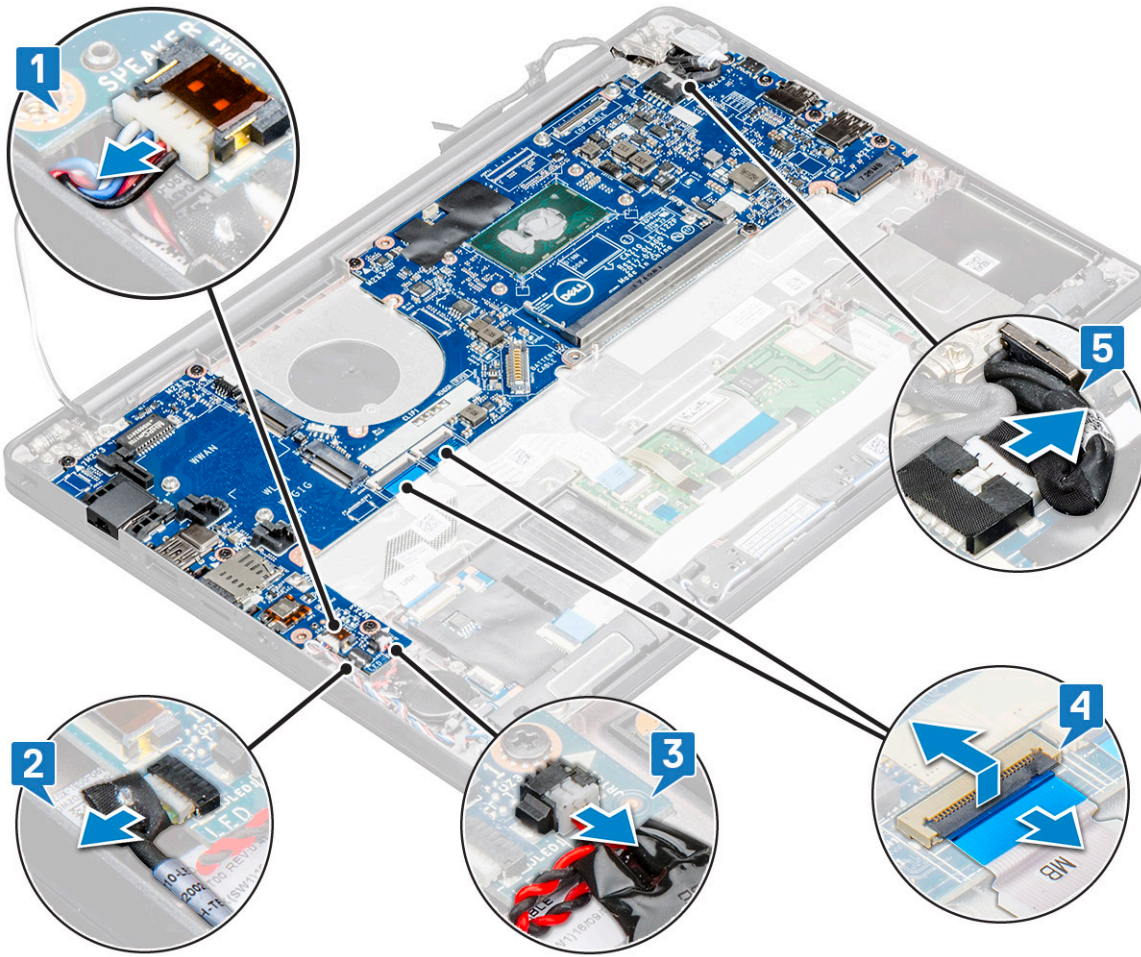

6 To remove the system board:

- a Remove the M2 x 3 screws (8) that secure the system board [1].

ⓘ | NOTE: Ensure to remove the USB Type-C bracket from system board.

- b Lift the system board away from the computer [2].

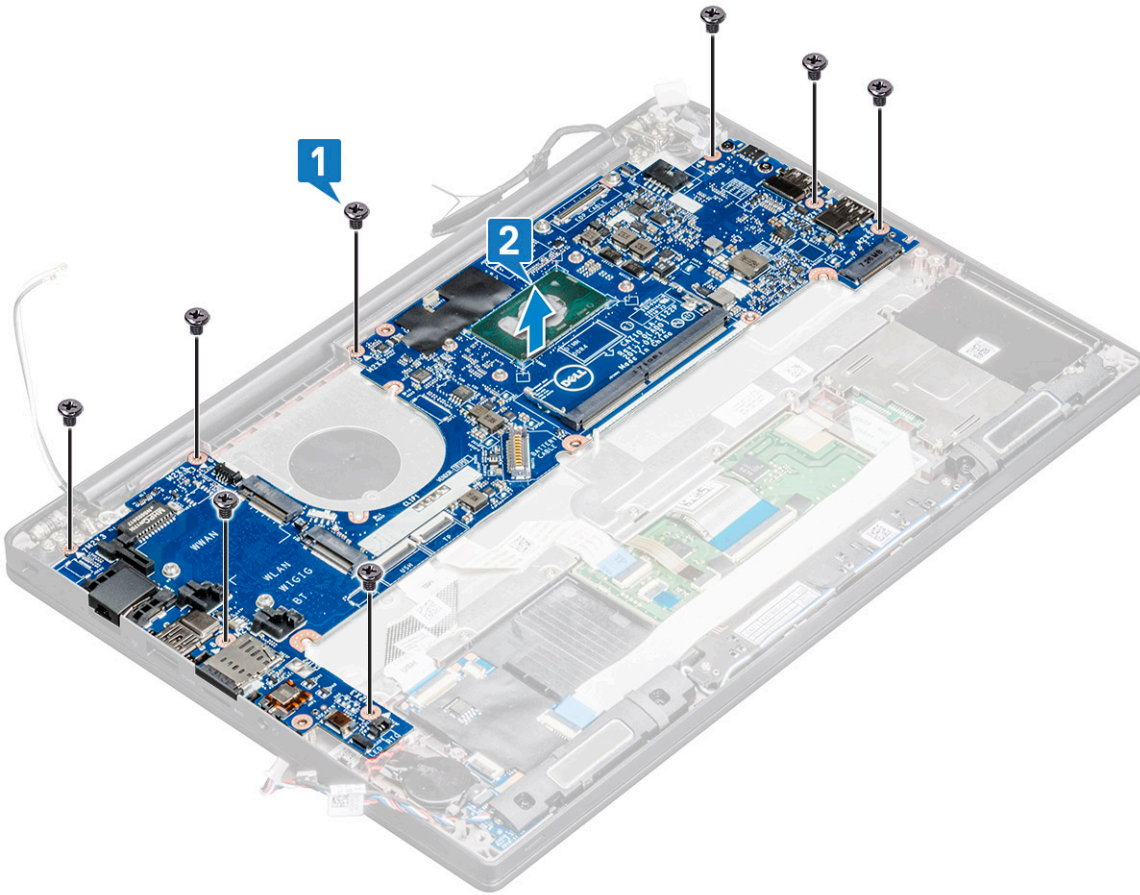

- 7 To remove the USB Type-C port from system board:
 - a Flip the system board, peel off the tapes and the screw securing the USB Type-C bracket.
 - b Lift the USB Type-C port away from the system board.

Installing system board

- 1 Place the USB Type-C port along with the bracket in the slot on the system board.
- 2 Affix the tape to secure the Type-C bracket.
- 3 Flip the system board and tighten the M2 x 3 screws to secure the USB type-C port to the system board.
- 4 Align the system board with the screw holders on the computer.
- 5 Tighten the M2 x 3 screws to secure the system board to the computer.
- 6 Connect the speaker, power connector, LED board, touchpad, and USH cables to the connectors on the system board.
- 7 Connect the eDP cable to the connector on the system board.
- 8 Place the metal bracket over the eDP cable and tighten the M2 x 3 screws to secure it.
- 9 Remove the metal bracket from the memory module connectors of the system board that was removed.
- 10 Place the metal bracket over the memory module connectors and tighten the M2 x 3 screws to secure it to the computer.

NOTE: If your computer has a WWAN card, then SIM card tray installation is a requirement.

- 11 Install the:
 - a coin cell battery
 - b heat sink
 - c WLAN card
 - d WWAN card
 - e SSD card

- f memory module
- g speaker
- h battery
- i base cover

12 Follow the procedure in [After working inside your computer](#).

Keyboard assembly

Removing keyboard assembly

NOTE: The keyboard and the keyboard tray together are called the keyboard assembly.

- 1 Follow the procedure in [Before working inside your computer](#).
- 2 Remove:
 - a base cover
 - b battery
 - c memory module
 - d PCIe SSD
 - e SATA SSD
 - f WLAN card
 - g WWAN card
 - h heatsink assembly
 - i system board
- 3 Disconnect the cables from the palmrest end:
 - a touchpad and USH board cables [1]
 - b keyboard backlight cable [2]
 - c keyboard cable [3]

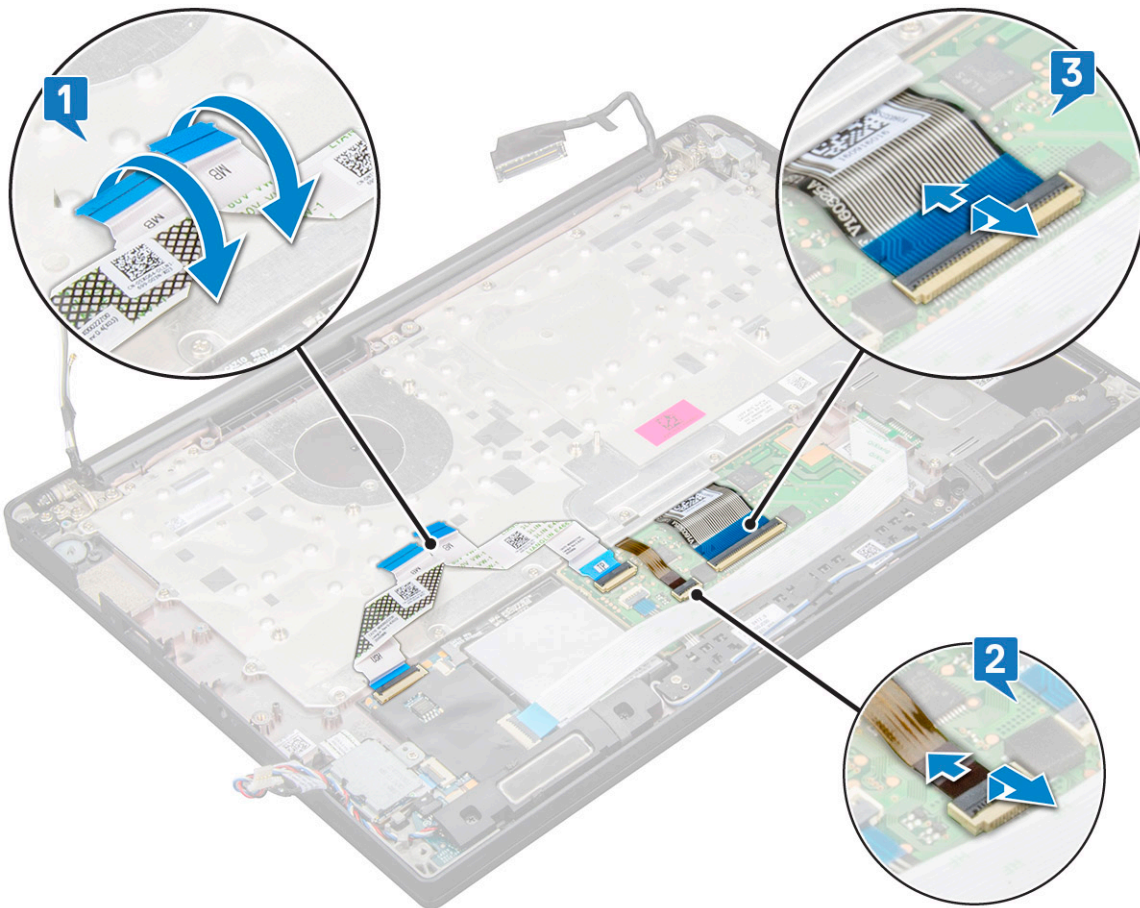

4 To remove the keyboard assembly:

NOTE: To identify the screws, see [screw list](#).

- a Remove the M2 x 2.5 screws (19) that secure the keyboard [1].
- b Lift the keyboard assembly from the chassis [2].

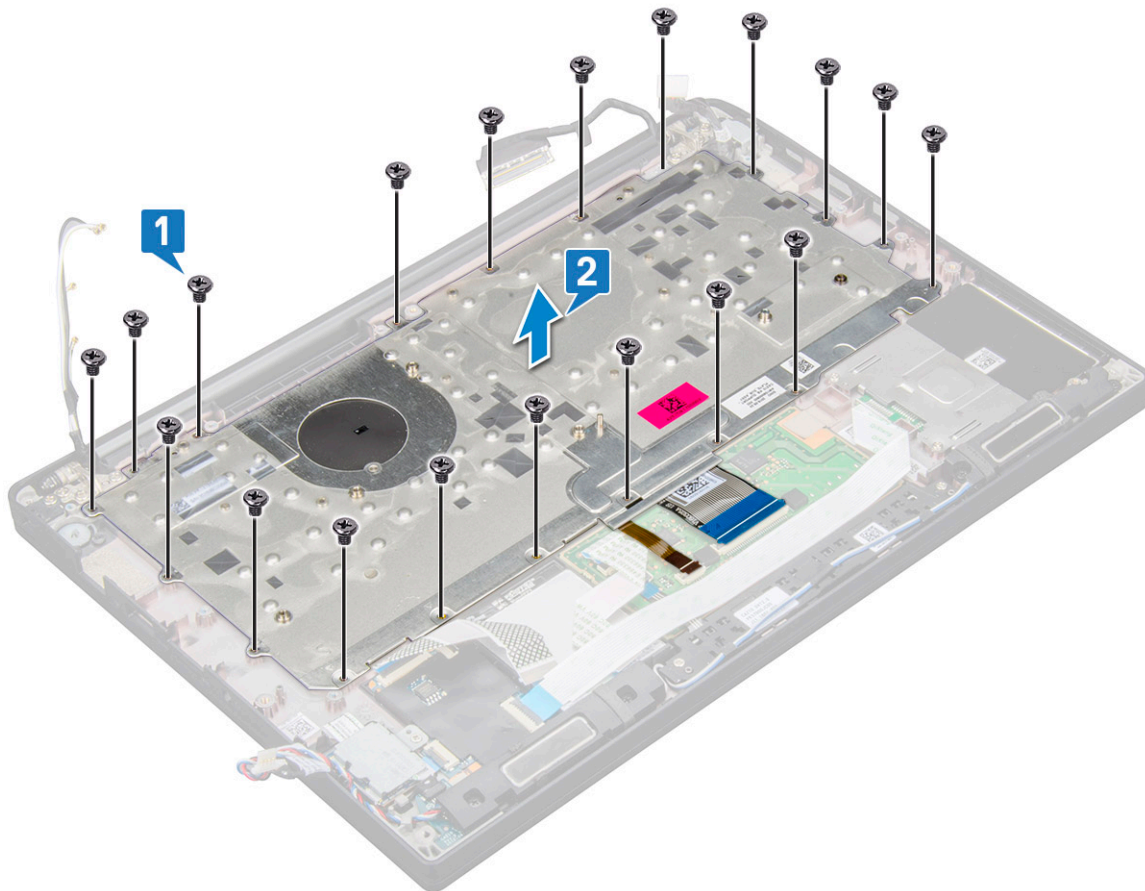

5 Remove the screws (5) that secures the keypad to the keyboard chassis and lift the keyboard [1,2].

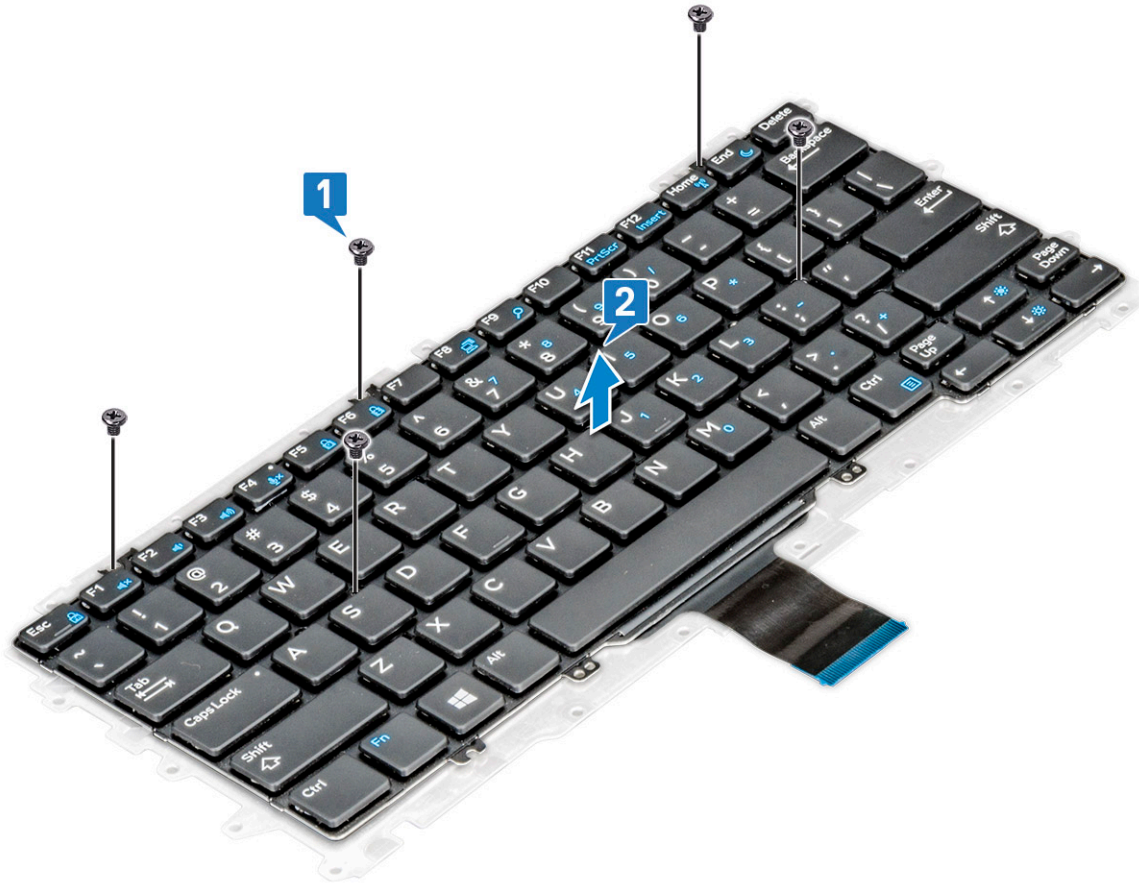

Installing keyboard assembly

NOTE: The keyboard and the keyboard tray together are called the keyboard assembly.

- 1 Align the keyboard assembly with the screw holders on the computer.
- 2 Tighten the M2.0 x 2.5 screws that secure the keyboard to the chassis.
- 3 Connect the keyboard cable, keyboard backlight cable, touchpad cable to the connectors on the touchpad buttons board.
- 4 Install the:
 - a [system board](#)
 - b [heat sink](#)
 - c [WLAN card](#)
 - d [WWAN card](#)
 - e [SSD card](#)
 - f [memory module](#)
 - g [battery](#)
 - h [base cover](#)
- 5 Follow the procedure in [After working inside your computer](#).

Keyboard

Removing keyboard from keyboard tray

- 1 Follow the procedure in [Before working inside your computer](#).
- 2 Remove the [keyboard assembly](#)
- 3 Remove the M2.0 x 2.0 screws that secure the keyboard to the keyboard assembly [1].
- 4 Lift the keyboard away from the keyboard tray [2].



Installing keyboard to keyboard tray

- 1 Align the keyboard with the screw holders on the keyboard tray.
- 2 Tighten the M2.0 x 2.0 screws to secure the keyboard to the keyboard tray.
- 3 Install the [keyboard assembly](#).

Palm rest

Replacing palm rest

- 1 Follow the procedure in [Before working inside your computer](#).
- 2 Remove the:
 - a [base cover](#)
 - b [battery](#)
 - c [memory module](#)
 - d [PCIe SSD](#)
 - e [WLAN card](#)
 - f [WWAN card](#)
 - g [power connector port](#)
 - h [heat sink assembly](#)
 - i [coin cell battery](#)
 - j [speaker](#)
 - k [display assembly](#)
 - l [system board](#)
 - m [keyboard](#)

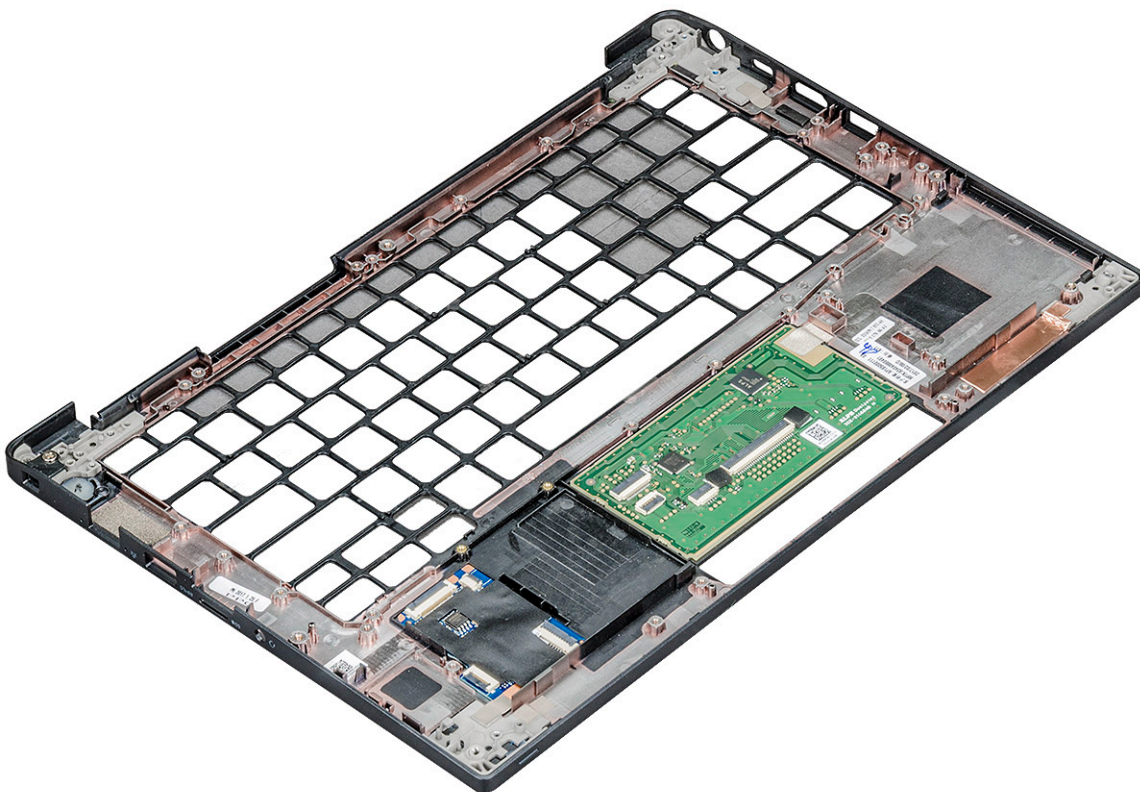

The component you are left with is the palm rest.

- 3 Replace the palm rest.
- 4 Install the:
 - a [keyboard](#)
 - b [system board](#)
 - c [display assembly](#)

- d [speaker](#)
- e [coin cell battery](#)
- f [heatsink](#)
- g [power connector port](#)
- h [WLAN card](#)
- i [WWAN card](#)
- j [PCIe SSD](#)
- k [memory](#)
- l [battery](#)
- m [base cover](#)

5 Follow the procedure in [After working inside your computer](#).

Technology and components

This chapter details the technology and components available in the system.

Topics:

- USB features
- HDMI 1.4

USB features

Universal Serial Bus, or USB, was introduced in 1996. It dramatically simplified the connection between host computers and peripheral devices like mice, keyboards, external drives, and printers.

Let's take a quick look on the USB evolution referencing to the table below.

Table 2. USB evolution

Type	Data Transfer Rate	Category	Introduction Year
USB 3.0/USB 3.1 Gen 1	5 Gbps	Super Speed	2010
USB 2.0	480 Mbps	High Speed	2000

USB 3.0/USB 3.1 Gen 1 (SuperSpeed USB)

For years, the USB 2.0 has been firmly entrenched as the de facto interface standard in the PC world with about 6 billion devices sold, and yet the need for more speed grows by ever faster computing hardware and ever greater bandwidth demands. The USB 3.0/USB 3.1 Gen 1 finally has the answer to the consumers' demands with a theoretically 10 times faster than its predecessor. In a nutshell, USB 3.1 Gen 1 features are as follows:

- Higher transfer rates (up to 5 Gbps)
- Increased maximum bus power and increased device current draw to better accommodate power-hungry devices
- New power management features
- Full-duplex data transfers and support for new transfer types
- Backward USB 2.0 compatibility
- New connectors and cable

The topics below cover some of the most commonly asked questions regarding USB 3.0/USB 3.1 Gen 1.



Speed

Currently, there are 3 speed modes defined by the latest USB 3.0/USB 3.1 Gen 1 specification. They are Super-Speed, Hi-Speed and Full-Speed. The new SuperSpeed mode has a transfer rate of 4.8Gbps. While the specification retains Hi-Speed, and Full-Speed USB mode,

commonly known as USB 2.0 and 1.1 respectively, the slower modes still operate at 480Mbps and 12Mbps respectively and are kept to maintain backward compatibility.

USB 3.0/USB 3.1 Gen 1 achieves the much higher performance by the technical changes below:

- An additional physical bus that is added in parallel with the existing USB 2.0 bus (refer to the picture below).
- USB 2.0 previously had four wires (power, ground, and a pair for differential data); USB 3.0/USB 3.1 Gen 1 adds four more for two pairs of differential signals (receive and transmit) for a combined total of eight connections in the connectors and cabling.
- USB 3.0/USB 3.1 Gen 1 utilizes the bidirectional data interface, rather than USB 2.0's half-duplex arrangement. This gives a 10-fold increase in theoretical bandwidth.

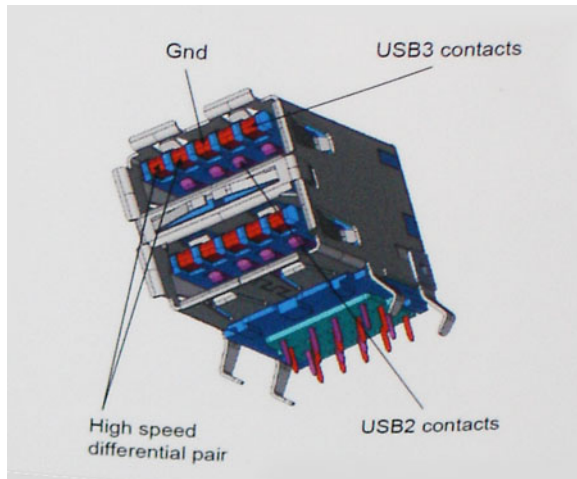

With today's ever increasing demands placed on data transfers with high-definition video content, terabyte storage devices, high megapixel count digital cameras etc., USB 2.0 may not be fast enough. Furthermore, no USB 2.0 connection could ever come close to the 480Mbps theoretical maximum throughput, making data transfer at around 320Mbps (40MB/s) — the actual real-world maximum. Similarly, USB 3.0/USB 3.1 Gen 1 connections will never achieve 4.8Gbps. We will likely see a real-world maximum rate of 400MB/s with overheads. At this speed, USB 3.0/USB 3.1 Gen 1 is a 10x improvement over USB 2.0.

Applications

USB 3.0/USB 3.1 Gen 1 opens up the laneways and provides more headroom for devices to deliver a better overall experience. Where USB video was barely tolerable previously (both from a maximum resolution, latency, and video compression perspective), it's easy to imagine that with 5-10 times the bandwidth available, USB video solutions should work that much better. Single-link DVI requires almost 2Gbps throughput. Where 480Mbps was limiting, 5Gbps is more than promising. With its promised 4.8Gbps speed, the standard will find its way into some products that previously weren't USB territory, like external RAID storage systems.

Listed below are some of the available SuperSpeed USB 3.0/USB 3.1 Gen 1 products:

- External Desktop USB 3.0/USB 3.1 Gen 1 Hard Drives
- Portable USB 3.0/USB 3.1 Gen 1 Hard Drives
- USB 3.0/USB 3.1 Gen 1 Drive Docks & Adapters
- USB 3.0/USB 3.1 Gen 1 Flash Drives & Readers
- USB 3.0/USB 3.1 Gen 1 Solid-state Drives
- USB 3.0/USB 3.1 Gen 1 RAIDs
- Optical Media Drives
- Multimedia Devices
- Networking
- USB 3.0/USB 3.1 Gen 1 Adapter Cards & Hubs

Compatibility

The good news is that USB 3.0/USB 3.1 Gen 1 has been carefully planned from the start to peacefully co-exist with USB 2.0. First of all, while USB 3.0/USB 3.1 Gen 1 specifies new physical connections and thus new cables to take advantage of the higher speed capability of the new protocol, the connector itself remains the same rectangular shape with the four USB 2.0 contacts in the exact same location as before. Five new connections to carry receive and transmitted data independently are present on USB 3.0/USB 3.1 Gen 1 cables and only come into contact when connected to a proper SuperSpeed USB connection.

Windows 8/10 will be bringing native support for USB 3.1 Gen 1 controllers. This is in contrast to previous versions of Windows, which continue to require separate drivers for USB 3.0/USB 3.1 Gen 1 controllers.

Microsoft announced that Windows 7 would have USB 3.1 Gen 1 support, perhaps not on its immediate release, but in a subsequent Service Pack or update. It is not out of the question to think that following a successful release of USB 3.0/USB 3.1 Gen 1 support in Windows 7, SuperSpeed support would trickle down to Vista. Microsoft has confirmed this by stating that most of their partners share the opinion that Vista should also support USB 3.0/USB 3.1 Gen 1.

Super-Speed support for Windows XP is unknown at this point. Given that XP is a seven-year-old operating system, the likelihood of this happening is remote.

Thunderbolt over USB Type-C

Thunderbolt is a hardware interface that combines data, video, audio, and power in a single connection. Thunderbolt combines PCI Express (PCIe) and DisplayPort (DP) into one serial signal, and additionally provides DC power, all in one cable. Thunderbolt 1 and Thunderbolt 2 use the same connector [1] as miniDP (DisplayPort) to connect to peripherals, while Thunderbolt 3 uses a USB Type-C connector [2].

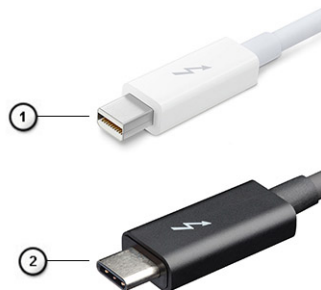

Figure 1. Thunderbolt 1 and Thunderbolt 3

- 1 Thunderbolt 1 and Thunderbolt 2 (using a miniDP connector)
- 2 Thunderbolt 3 (using a USB Type-C connector)

Thunderbolt 3 over USB Type-C

Thunderbolt 3 brings Thunderbolt to USB Type-C at speeds up to 40 Gbps, creating one compact port that does it all - delivering the fastest, most versatile connection to any dock, display or data device like an external hard drive. Thunderbolt 3 uses a USB Type-C connector/port to connect to supported peripherals.

- 1 Thunderbolt 3 uses USB Type-C connector and cables - It is compact and reversible
- 2 Thunderbolt 3 supports speed up to 40 Gbps
- 3 DisplayPort 1.2 – compatible with existing DisplayPort monitors, devices and cables
- 4 USB Power Delivery - Up to 130W on supported computers

Key Features of Thunderbolt 3 over USB Type-C

- 1 Thunderbolt, USB, DisplayPort and power on USB Type-C on a single cable (features vary between different products)
- 2 USB Type-C connector and cables which are compact and reversible
- 3 Supports Thunderbolt Networking (*varies between different products)
- 4 Supports up to 4K displays
- 5 Up to 40 Gbps

📘 | **NOTE: Data transfer speed may vary between different devices.**

Thunderbolt Icons

Table 3. Thunderbolt Iconography Variation

Protocol	USB Type-A	USB Type-C	Notes
Thunderbolt	Not Applicable		mDP or USB Type-C

Advantages of Displayport over USB Type-C

- Full DisplayPort audio/video (A/V) performance (up to 4K at 60Hz)
- SuperSpeed USB (USB 3.1) data
- Reversible plug orientation and cable direction
- Backwards compatibility to VGA, DVI with adaptors
- Supports HDMI 2.0a and is backwards compatible with previous versions

HDMI 1.4

This topic explains the HDMI 1.4 and its features along with the advantages.

HDMI (High-Definition Multimedia Interface) is an industry-supported, uncompressed, all-digital audio/video interface. HDMI provides an interface between any compatible digital audio/video source, such as a DVD player, or A/V receiver and a compatible digital audio and/or video monitor, such as a digital TV (DTV). The intended applications for HDMI TVs, and DVD players. The primary advantage is cable reduction and content protection provisions. HDMI supports standard, enhanced, or high-definition video, plus multichannel digital audio on a single cable.

📘 | **NOTE: The HDMI 1.4 will provide 5.1 channel audio support.**

HDMI 1.4 Features

- **HDMI Ethernet Channel** - Adds high-speed networking to an HDMI link, allowing users to take full advantage of their IP-enabled devices without a separate Ethernet cable
- **Audio Return Channel** - Allows an HDMI-connected TV with a built-in tuner to send audio data "upstream" to a surround audio system, eliminating the need for a separate audio cable
- **3D** - Defines input/output protocols for major 3D video formats, paving the way for true 3D gaming and 3D home theater applications
- **Content Type** - Real-time signaling of content types between display and source devices, enabling a TV to optimize picture settings based on content type
- **Additional Color Spaces** - Adds support for additional color models used in digital photography and computer graphics

- **4K Support** - Enables video resolutions far beyond 1080p, supporting next-generation displays that will rival the Digital Cinema systems used in many commercial movie theaters
- **HDMI Micro Connector** - A new, smaller connector for phones and other portable devices, supporting video resolutions up to 1080p
- **Automotive Connection System** - New cables and connectors for automotive video systems, designed to meet the unique demands of the motoring environment while delivering true HD quality

Advantages of HDMI

- Quality HDMI transfers uncompressed digital audio and video for the highest, crispest image quality.
- Low -cost HDMI provides the quality and functionality of a digital interface while also supporting uncompressed video formats in a simple, cost-effective manner
- Audio HDMI supports multiple audio formats from standard stereo to multichannel surround sound
- HDMI combines video and multichannel audio into a single cable, eliminating the cost, complexity, and confusion of multiple cables currently used in A/V systems
- HDMI supports communication between the video source (such as a DVD player) and the DTV, enabling new functionality

System specifications

System specifications

Feature	Specification
Chipset	Intel KabyLake U & R (integrated with processor)
DRAM bus width	64-bit
Flash EPROM	SPI 128 Mbits
PCIe bus	100 MHz
External Bus Frequency	DMI 3.0—8GT/s

Processor specifications

Feature	Specification
Types	Intel Core i3-7130U (3M Cache, up to 2.7 GHz)
	Intel Core i5-7300U (3M Cache, up to 3.5 GHz), vPro
	Intel Core i5-8250U (6M Cache, Quad Core, 3.4GHz)
	Intel Core i5-8350U (6M Cache, Quad Core, 3.6GHz), vPro
	Intel Core i7-8650U (8M Cache, Quad Core, 3.9GHz), vPro

Memory specifications

Feature	Specification
Memory connector	One DIMM slot
Memory capacity	4 GB and 16 GB
Memory type	DDR4 2400 SDRAM operates at 2133 with Intel 7th Gen, DDR4 2400 SDRAM operates at 2400 with Intel 8th Gen
Minimum memory	4 GB
Maximum memory	Up to 16 GB

Video specifications

Feature	Specification
Type	Integrated on system board

Feature	Specification
UMA controller	<ul style="list-style-type: none"> Intel HD Graphics 620 (GT2) - (7th Gen Intel® Core) Intel UHD Graphics 620 (GT2) - (8th Gen Intel® Core)
External display support	<ul style="list-style-type: none"> HDMI 1.4 Display Port over USB Type-C(optional Thunderbolt 3)

 **NOTE: Supports one VGA, DisplayPort, HDMI through the docking station .**

Audio specifications

Feature	Specification
Types	Four-channel high-definition audio
Controller	Realtek ALC3246
Stereo conversion	24-bit— analog-to-digital and digital-to-analog
Internal interface	High-definition audio
External interface	Microphone-in, stereo headphones, and headset combo connector
Speakers	Two
Internal speaker amplifier	2 W (RMS) per channel
Volume controls	Hot keys

Battery specifications

Feature	Specification
Type	<ul style="list-style-type: none"> 3-cell Lithium Prismatic battery with ExpressCharge 4-cell Lithium Prismatic battery with ExpressCharge

42 WHr (3–cell):

Length	200.5 mm (7.89 inches)
Width	95.9 mm (3.78 inches)
Height	5.7 mm (0.22 inch)
Weight	185.0 g (0.41 lb)
Voltage	11.4 VDC

60 WHr (4–cell):

Length	238 mm (9.37 inches)
Width	95.9 mm (3.78 inch)
Height	5.7 mm (0.22 inch)
Weight	270 g (0.6 lb)
Voltage	7.6 VDC

Feature	Specification
Life span	300 discharge per charge cycles
Temperature range	
Operating	<ul style="list-style-type: none"> Charge: 0°C to 50°C (32°F to 158°F) Discharge: 0°C to 70°C (32°F to 122°F)
Non-operating	- 20°C to 65°C (- 4°F to 149°F)
Coin cell battery	3 V CR2032 lithium coin cell

AC adapter specifications

Feature	Specification
Type	7.4 mm Barrel Type 65 W or 90 W (65W E5 for India)
	 NOTE: The system is shipped with 65 W adapter and also supports 90 W adapter for fast charging.
Input voltage	100 V AC to 240 V AC
Input current— maximum	1.7 A / 1.6 A
Input frequency	50 Hz to 60 Hz
Output current	3.34 A (continuous) and 4.62 A (continuous)
Rated output voltage	19.5 V DC
Weight	0.23 kg, 0.51 lbs (65W) and 0.32 kg, 0.77 lbs (90W)
Dimensions	22 x 66 x 106 mm (65 W) and 22 x 66 x 130 (90 W) or 0.87 x 2.60 x 4.17 inches (65 W) and 0.87 x 2.60 x 5.12 inches (90 W)
Temperature range —Operating	0°C to 40°C (32°F to 104°F)
Temperature range —Non-Operating	-40°C to 70°C (-40°F to 158°F)

Touchpad specifications

Feature	Specification
Active Area:	Sensor-active area
X-axis	101.7mm (4.0 inch)
Y-axis	52mm (2.04 inch)
X/Y position resolution	X: 1048dpi; Y:984dpi
Multi-touch	Configurable single finger and multi-finger gestures

Port and connector specifications

Feature	Specification
Audio	<ul style="list-style-type: none">• Microphone-in, stereo headphones, and headset combo connector• Realtek ALC3246 Controller• Stereo conversion: 24-bit (analog-to-digital and digital-to-analog)• Internal interface - high-definition audio codec• External interface - microphone-in and stereo headphones/speakers universal connector• Speakers: Power: 2X2 Wrms• Internal speaker amplifier: Two watts per channel• Internal microphone: Digital microphone (dual microphone with camera)• No volume control buttons• Support hot-key keyboard button
Video	HDMI 1.4
Network adapter	One RJ-45 connector
USB	<ul style="list-style-type: none">• Two Type-C USB 3.1 Gen 1 DisplayPort (optional Thunderbolt)• Two USB 3.1 Gen 1 ports (one PowerShare capable)
Memory card reader	MicroSD 4.0 card reader and One 3042, One 2280 M.2 slot
Micro Subscriber Identity Module (uSIM) card	External tray tied to WWAN hinge up
Docking port	<ul style="list-style-type: none">• Dell Business Dock WD15 (optional)• Dell Business Thunderbolt Dock TB16 (optional)• Noble Wedge Lock slot• External USB Type-C Dock
Express Card	None
AC adapter	<ul style="list-style-type: none">• E5 65 W• E5 65 W rug (Only for India)• E5 90 W• E4 65 W HF (BFR/PVC Free)• Power Companion 45 W (Dura Ace)• Power Companion 65 W (Tesla) (No express charge)• Hybrid Power Bank and adapter (45 W) (12 inches only, not 14/15) (No express charge)
Smart card reader	One (optional)

Communication specifications

Features	Specification
Network adapter	Intel i219LM Gigabit Ethernet Controller 10/100/1000 Mb/s(RJ-45)

Features

Specification

Wireless

- No WLAN option
- Qualcomm QCA61x4A 2x2 AC + Bluetooth 4.1 (non vPro)
- Qualcomm QCA6174A XR 2x2 AC + Bluetooth 4.1 (non vPro)
- Intel Dual-Band Wireless-AC 8265 2x2 + Bluetooth 4.2 (non vPro)
- Mobile Broadband Options (optional)

Mobile Broadband Options (optional)

- Qualcomm Snapdragon X7 LTE-A (DW5811e) for AT&T
- Verizon & Sprint. (US)
- Qualcomm Snapdragon X7 LTE-A (DW5811e) (EMEA/APJ/ROW)
- Qualcomm Snapdragon X7 HSPA + (DW5811e) (China/Indonesia/ India)
- Qualcomm Snapdragon X7 LTE-A (DW5816e) (Japan/ANZ/India/South Korea/Taiwan)

Camera specifications

Easy Remote Collaboration:

- Video conference online with an optional built-in camera
- Windows Hello feature can be enabled with IR Camera embedded

Table 4. Camera specifications

Camera features	13 HD/FHD	13" FHD	13" FHD touch
Camera Type	HD fixed focus	HD fixed focus	HD fixed focus
IR Camera	N/A	Yes	N/A
Sensor Type	CMOS sensor technology	CMOS sensor technology	CMOS sensor technology
Resolution: Motion Video	Up to 1280x720 (0.92MP)	Up to 1280x720 (0.92MP)	Up to 1280x720 (0.92MP)
Resolution: Still Image	Up to 1280 x 720 (0.92MP)	Up to 1280 x 720 (0.92MP)	Up to 1280 x 720 (0.92MP)
Imaging Rate	Up to 30 frames per second	Up to 30 frames per second	Up to 30 frames per second

Display

Table 5. 13.3" (16:9) AG FHD Non-Touch WLED 300 nits eDP 1.3 WVA

Feature	Specification
Type	FHD Anti-Glare
Luminance (typical)	300 nits
Dimensions (Active Area)	<ul style="list-style-type: none">• Height: 165.08 mm• Width: 293.47 mm• Diagonal: 13.3 inch

Native Resolution	1920 x 1080
Megapixels	2.07
Pixels per Inch (PPI)	166
Contrast Ratio (min)	600:1
Response Time (max)	35 msec rise/fall
Refresh Rate	60 Hz
Horizontal View Angle	+/- 80 degrees
Vertical View Angle	+/- 80 degrees
Pixel Pitch	0.153 mm
Power Consumption (maximum)	4.6 W
Back Cover Variants	Magnesium Alloy/Narrow Border Magnesium Alloy with WLAN and/or WWAN and HD/IR Cam with Mic variants

Table 6. 13.3" (16:9) AG FHD Touch WLED 300 nits eDP 1.3 WVA

Feature	Specification
Type	FHD Anti-Glare
Luminance (typical)	300 nits
Dimensions (Active Area)	<ul style="list-style-type: none"> • Height:165.08 mm • Width: 293.47 mm • Diagonal: 13.3"
Native Resolution	1920 x 1080
Megapixels	2.07
Pixels per Inch (PPI)	166
Contrast Ratio (min)	600:1
Response Time (max)	35msec rise/fall
Refresh Rate	60 Hz
Horizontal View Angle	+/- 80 degrees
Vertical View Angle	+/- 80 degrees
Pixel Pitch	0.153 mm
Power Consumption (maximum)	5.2 W
Back Cover Variants	Magnesium Alloy or Narrow Border Carbon with WLAN and/or WWAN and HD/IR Cam with Mic variants

Dimensions and Weight

Table 7. Dimensions

Dimensions	Inches	Millimeter
Width	12.00	304.80
Depth	8.19	207.95
Height (front, full) for NT FHD and Touch FHD	0.64	16.33

Height (rear, full) for all configurations	0.66	16.86
--	------	-------

Table 8. Weight

Starting weight	Pounds	Kilograms
	2.59	1.17

Environmental specifications

Temperature	Specifications
Operating	0°C to 35°C (32°F to 95°F)
Storage	-40°C to 65°C (-40°F to 149°F)

Relative humidity —maximum	Specifications
Operating	10% to 90% (non-condensing)
Storage	5% to 95% (non-condensing)

Altitude— maximum	Specifications
Operating	0 to 3048 m (0 to 10,000 ft)
Storage	0 to 10668 m

System setup

System setup enables you to manage your tablet hardware and specify BIOS level options. From the System setup, you can:

- Change the NVRAM settings after you add or remove hardware
- View the system hardware configuration
- Enable or disable integrated devices
- Set performance and power management thresholds
- Manage your computer security

Topics:

- [Boot menu](#)
- [System setup options](#)

Boot menu

Press <F12> when the Dell™ logo appears to initiate a one-time boot menu with a list of the valid boot devices for the system. Diagnostics and BIOS Setup options are also included in this menu. The devices listed on the boot menu depend on the bootable devices in the system. This menu is useful when you are attempting to boot to a particular device or to bring up the diagnostics for the system. Using the boot menu does not make any changes to the boot order stored in the BIOS.

The options are:

- Legacy Boot:
 - Internal HDD
 - Onboard NIC
- UEFI Boot:
 - Windows Boot Manager
- Other Options:
 - BIOS Setup
 - BIOS Flash Update
 - Diagnostics
 - Change Boot Mode Settings

Navigation keys

NOTE: For most of the System Setup options, changes that you make are recorded but do not take effect until you restart the system.

Keys	Navigation
Up arrow	Moves to the previous field.
Down arrow	Moves to the next field.
Enter	Selects a value in the selected field (if applicable) or follow the link in the field.

Keys	Navigation
Spacebar	Expands or collapses a drop-down list, if applicable.
Tab	Moves to the next focus area.
	 NOTE: For the standard graphics browser only.
Esc	Moves to the previous page until you view the main screen. Pressing Esc in the main screen displays a message that prompts you to save any unsaved changes and restarts the system.

System setup options

 **NOTE: Depending on the tablet and its installed devices, the items listed in this section may or may not appear.**

General screen options

This section lists the primary hardware features of your computer.

Option	Description
System Information	<ul style="list-style-type: none"> System Information: Displays BIOS Version, Service Tag, Asset Tag, Ownership Tag, Ownership Date, Manufacture Date, and the Express Service Code. Memory Information: Displays Memory Installed, Memory Available, Memory Speed, Memory Channels Mode, Memory Technology, DIMM A Size, DIMM B Size. Processor Information: Displays Processor Type, Core Count, Processor ID, Current Clock Speed, Minimum Clock Speed, Maximum Clock Speed, Processor L2 Cache, Processor L3 Cache, HT Capable, and 64-Bit technology. Device Information: Displays Primary Hard Drive, MiniCard Device, ODD Device, Dock eSATA Device, LOM MAC Address, Video Controller, Video BIOS Version, Video Memory, Panel Type, Native Resolution, Audio Controller, Wi-Fi Device, WiGig Device, Cellular Device, Bluetooth Device.
Battery Information	Displays the battery status and the type of AC adapter connected to the computer.
Boot Sequence	<p>Boot Sequence Allows you to change the order in which the computer attempts to find an operating system. The options are:</p> <ul style="list-style-type: none"> Windows Boot Manager <p>By default, the options is checked.</p> <p>Boot List Options Allows you to change the boot list option:</p> <ul style="list-style-type: none"> Legacy UEFI (The option is enabled by default)
Advanced Boot Options	<p>Allows you the legacy option ROMs to load. By default, all the option are disabled.</p> <ul style="list-style-type: none"> Enable Legacy Option ROMs Enable Attempt Legacy Boot
UEFI Boot Path SecurityOptions	<p>Allows you to control whether or not the system will prompt to the user to enter the Admin password, when a user selects a UEFI boot path from the F12 boot Menu.</p> <ul style="list-style-type: none"> Always, Except Internal HDD. This option is enabled by default.

Option	Description
	<ul style="list-style-type: none"> · Always · Never <p>i NOTE: These options have no relevance if the Admin password is not set BIOS settings.</p>

Date/Time Allows you to change the date and time.

Video screen options

Option	Description
LCD Brightness	Allows you to set the display brightness depending up on the power source (On Battery and On AC).

i **NOTE:** The video setting will be visible only when a video card is installed into the system.

Security screen options

Option	Description
Admin Password	<p>Allows you to set, change, or delete the administrator (admin) password.</p> <p>i NOTE: You must set the admin password before you set the system or hard drive password. Deleting the admin password automatically deletes the system password and the hard drive password.</p> <p>i NOTE: Password changes take effect immediately.</p> <p>By default, the drive will not have a password set.</p>
System Password	<p>Allows you to set, change or delete the system password.</p> <p>i NOTE: Password changes take effect immediately.</p> <p>By default, the drive will not have a password set.</p>
Strong Password	<p>Allows you to enforce the option to always set strong passwords.</p> <p>Default Setting: Enable Strong Password is not selected.</p> <p>i NOTE: If user interface is enabled, Admin and System passwords must contain at least one uppercase character, one lowercase character and be at least 8 characters long.</p>
Password Configuration	Allows you to determine the minimum and maximum length of Administrator and System passwords.
Password Bypass	<p>Allows you to disable or enable the permission to bypass the System and the Internal hard drive password, when they are set. The options are:</p> <ul style="list-style-type: none"> · Disabled. This option is selected by default. · Reboot bypass
Password Change	<p>Allows you to enable or disable permission to the System and Hard Drive passwords when the admin password is set.</p> <p>Allow Non-Admin Password Changes This option is selected by default.</p>

Option	Description
Non-Admin Setup Changes	Allows you to determine whether changes to the setup options are allowed when an administrator password is set. If disabled the setup options are locked by the admin password.
UEFI Capsule Firmware Updates	<p>This option controls whether the system allows BIOS updates via UEFI capsule update packages.</p> <p>Enable UEFI Capsule Firmware Updates option is selected by default.</p> <p>NOTE: Disabling this option will block BIOS updates from services such as Microsoft Windows Update and Linux Vendor Firmware Service (LVFS).</p>
TPM 2.0 Security	<p>Allows you to enable the Trusted Platform Module (TPM) during POST.</p> <p>You can control whether the trusted platform module is visible to the operating system. The option is:</p> <ul style="list-style-type: none"> • TPM on This option is selected by default. • Clear • PPI Bypass for Enable Commands This option is selected by default. • Attestation Enable. This option is selected by default. • PPI Bypass for Disable Commands • Key Storage Enable. This option is selected by default. • SHA-256. This option is selected by default. <p>CAUTION: For the TPM upgrade/downgrade process, it is recommended to complete the process in an AC power with AC adapter plugged into the computer. The upgrade/downgrade process without the AC adapter plugged in might damage the computer or hard disk.</p> <p>NOTE: Disabling this option does not change any settings you have made to the TPM, nor does it delete or change any information or keys you may have stored in the TPM. Changes to this setting take effect immediately.</p>
Computrace (R)	<p>Allows you to activate or disable the optional Computrace Service from Absolute software. The options are:</p> <ul style="list-style-type: none"> • Deactivate • Disable • Activate <p>NOTE: The Activate and Disable options will permanently activate or disable the feature and no further changes will be allowed</p> <p>Default setting: Activate</p>
OROM Keyboard Access	<p>Allows you to set an option to enter the Option ROM Configuration screens using hotkeys during boot. The options are:</p> <ul style="list-style-type: none"> • Enabled. This option is selected by default. • One Time Enable • Disabled <p>Default setting: Enable</p>
Admin Setup Lockout	<p>Allows you to prevent users from entering the setup when an Administrator password is set.</p> <p>Enable Admin Setup Lockout This option is not selected by default.</p>
Master Password Lockout	<p>Allows you to prevent users from entering the setup when an Master password is set. Hard disk passwords need to be cleared before the setting can be changed.</p>

Option	Description
	Enable Master Password Lockout This option is not selected by default.
SSM Security Mitigation	Allows you to enable or disable additional UEFI SMM Security Mitigation protections. The OS can use the feature to help protect the secure environment created by virtualization based security. SSM Security Mitigation This option is disabled by default.

Secure Boot

Option	Description
Secure Boot Enable	This option enables or disables the Secure Boot feature. <ul style="list-style-type: none"> · Disabled · Enabled Default setting: Enabled.
Expert Key Management	Allows you to manipulate the security key databases only if the system is in Custom Mode. The Enable Custom Mode option is disabled by default.
Custom Mode Key Management	Allows you to manage the security key databases only if the system is in Custom Mode .The options are: <ul style="list-style-type: none"> · PK. This option is selected by default. · KEK · db · dbx <p> NOTE: If you disable the Enable Custom Mode, all the changes made will be erased and the keys will restore to default settings. Save to File will save the key to a user-selected file.</p>

Intel software Guard Extensions

Option	Description
Intel SGX Enable	This option enables or disables to provide a secured environment for running code/storing sensitive information in the context of the main OS. The options are: <ul style="list-style-type: none"> · Disabled · Enabled · Software Controlled.This option is selected by default.
Enclave Memory Size	Allows you to reserve the memory size. The memory size can be set from 32 MB to 128 MB, these options are disabled by default. The options are: <ul style="list-style-type: none"> · 32 MB · 64 MB · 128 MB

Performance screen options

Option	Description
Multi Core Support	<p>This field specifies whether the process has one or all cores enabled. The performance of some applications improves with the additional cores. This option is enabled by default. Allows you to enable or disable multi-core support for the processor.</p> <ul style="list-style-type: none">· AllThis option is enabled by default.· 1· 2· 3
Intel SpeedStep	<p>Allows you to enable or disable the Intel SpeedStep mode of the processor.</p> <ul style="list-style-type: none">· Enable Intel SpeedStep <p>Default setting: The option is enabled.</p>
C-States Control	<p>Allows you to enable or disable the additional processor sleep states.</p> <ul style="list-style-type: none">· C states <p>Default setting: The option is enabled.</p>
Intel TurboBoost	<p>Allows you to enable or disable the Intel TurboBoost mode of the processor.</p> <ul style="list-style-type: none">· Enable Intel TurboBoost <p>Default setting: The option is enabled.</p>
HyperThread Control	<p>Allows you to enable or disable the HyperThreading in the processor.</p> <ul style="list-style-type: none">· Disabled· EnabledThis option is enabled by default.

Power Management screen options

Option	Description
AC Behavior	<p>Allows you to enable or disable the computer from turning on automatically when an AC adapter is connected.</p> <p>Wake on AC This option is disabled by default.</p>
Enable Intel Speed Shift Technology	<p>Allows you to enable or disable the Intel speed Shift Technology support. Setting to enable option, allows the operating system to automatically select the required processor performance.</p> <p>Enable Intel Speed Shift Technology This option is enabled by default.</p>
Auto On Time	<p>Allows you to set the time at which the computer must turn on automatically. The options are:</p> <ul style="list-style-type: none">· Disabled This option is enabled by default.· Every Day

Option	Description
	<ul style="list-style-type: none"> · Weekdays · Select Days
USB Wake Support	<p>Allows you to enable USB devices to wake the system from Standby.</p> <p>i NOTE: This feature is only functional when the AC power adapter is connected. If the AC power adapter is removed during Standby, the system setup removes power from all the USB ports to conserve battery power.</p> <ul style="list-style-type: none"> · Enable USB Wake Support · Wake on Dell USB-C Dock The option is selected by default.
Wireless Radio Control	<p>Allows you to sense the connection of the system to a wired network and subsequently disable the selected wireless radios (WLAN and/or WWAN)</p> <p>Upon disconnection from the wired network, the selected wireless radios is re-enabled. By default none of the option is enabled. The options are:</p> <ul style="list-style-type: none"> · Control WLAN radio · Control WWAN radio
Wake on WLAN	<p>Allows you to enable or disable the feature that powers on the computer from the Off state when triggered by a LAN signal.</p> <ul style="list-style-type: none"> · Disabled This option is selected by default. · LAN Only · WLAN Only · LAN or WLAN
Block Sleep	<p>Allows you to block entering to sleep (S3 state) in OS environment. When enabled system wont go to sleep. Intel Rapid Start will be disabled automatically and OS Power option will be blank if it was set to Sleep (S3 state) . Block Sleep (S3 State) option is disabled by default.</p>
Peak Shift	<p>Allows you to minimize the AC power consumption during the peak power times of day. After you enable this option, your system runs only in battery even if the AC is attached.</p> <ul style="list-style-type: none"> · Enable Peak Shift This option is not selected by default.
Advanced Battery Charge Configuration	<p>This option enables you to maximize the battery health. By enabling this option, your system uses the standard charging algorithm and other techniques, during the non-work hours to improve the battery health.</p> <ul style="list-style-type: none"> · Enable Advanced Battery Charge Mode This option is not selected by default.
Primary Battery Charge Configuration	<p>Allows you to select the charging mode for the battery. The options are:</p> <ul style="list-style-type: none"> · Adaptive This option is enabled by default. · Standard Fully charges your battery at a standard rate. · ExpressCharge The battery charges over a shorter period of time using Dell's fast charging technology. · Primarily AC use · Custom <p>If Custom Charge is selected, you can also configure Custom Charge Start and Custom Charge Stop.</p> <p>i NOTE: All charging mode may not be available for all the batteries. To enable this option, disable the Advanced Battery Charge Configuration option.</p>

Option	Description
Type-C Connector Power	Allows you to set the maximum power the computer can draw from the Type-C connectors. The options are: 7.5 Watts 15 Watts This option is enabled by default.

POST Behavior

Option	Description
Adapter Warnings	Allows you to enable or disable the system setup (BIOS) warning messages when you use certain power adapters. Enable Adapter Warnings This option is selected by default.
Keypad (Embedded)	Allows you to choose one of two methods to enable the keypad that is embedded in the internal keyboard. <ul style="list-style-type: none"> Fn Key Only This option is enabled by default. By Numlock <p> NOTE: When setup is running, this option has no effect. Setup works in Fn Key Only mode.</p>
Fn Lock Options	Allows you to let hot key combinations Fn + Esc toggle the primary behavior of F1–F12, between their standard and secondary functions. If you disable this option, you cannot toggle dynamically the primary behavior of these keys. The available options are: <ul style="list-style-type: none"> Fn Lock This option is enabled by default. Lock Mode Disable/Standard This option is selected by default. Lock Mode Enable/Secondary
Fastboot	Allows you to speed up the boot process by bypassing some of the compatibility steps. The options are: <ul style="list-style-type: none"> Minimal This option is selected by default. Thorough Auto
Extended BIOS POST Time	Allows you to create an additional pre-boot delay. The options are: <ul style="list-style-type: none"> 0 seconds This option is enabled by default. 5 seconds 10 seconds
Full Screen Logo	Allows you display full screen logo if your image match screen resolution. The options are: <ul style="list-style-type: none"> Enable Full Screen Logo This option is disabled by default.
Sign of Life Indication	Allows you to illuminate the front panel tablet buttons (Rotation Lock, Volume Down, Volume Up, Windows, P1,P2, and P3) momentarily, when the power button is pressed to turn on the system. The options are: <ul style="list-style-type: none"> Enable Tablet Button LED Sign of Life This option is selected by default.
Warnings and Errors	Allows you to select in the BIOS setup options that cause the boot process to pause only, when warnings or errors are detected rather than stop, prompt and wait for user input. The options are:

Option	Description
	<p>Prompt on Warnings and Errors. This option is enabled by default.</p> <p>Continue on Warnings</p> <p>Continue on Warnings and Errors</p>
MAC Address Pass-Through	<p>Allows you to replace the external NIC MAC address in a supported dock or dongle with the selected MAC address from the system. The options are:</p> <p>System Unique MAC Address. This option is enabled by default.</p> <p>Integrated NIC1 MAC Address</p> <p>Disabled</p>

Manageability

Option	Description
USB Provision	<p>Allows you to enable or disable provisioning the Intel AMT from a USB storage device.</p> <p>Enable USB Provision This option is not selected by default.</p>
MEBx Hotkey	<p>Allows you to specify whether the MEBx Hotkey function should be enabled, during the system boot.</p> <p>Enable MEBx Hotkey. This option is selected by default.</p>

Virtualization Support options

Option	Description
Virtualization	<p>Allows you to enable or disable the Intel Virtualization Technology.</p> <p>Enable Intel Virtualization Technology This option is selected by default.</p>
VT for Direct I/O	<p>Enables or disables the Virtual Machine Monitor (VMM) from utilizing the additional hardware capabilities provided by Intel® Virtualization technology for direct I/O.</p> <p>Enable VT for Direct I/O This option is selected by default.</p>
Trusted Execution	<p>This option specifies whether a Measured Virtual Machine Monitor (MVMM) can utilize the additional hardware capabilities provided by Intel Trusted Execution Technology, The TPM Virtualization Technology, and Virtualization technology for direct I/O must be enabled to use this feature.</p> <p>Trusted Execution This option is disabled by default.</p>

Wireless screen options

Option	Description
Wireless Switch	<p>Allows to set the wireless devices that can be controlled by the wireless switch. The options are:</p>

Option	Description
	<ul style="list-style-type: none"> · WWAN · GPS (on WWAN Module) · WLAN · Bluetooth

All the options are enabled by default.

NOTE: For WLAN and WiGig enable or disable controls are tied together and they cannot be enabled or disabled independently.

Wireless Device Enable	<p>Allows you to enable or disable the internal wireless devices.</p> <ul style="list-style-type: none"> · WWAN/GPS · WLAN · Bluetooth
-------------------------------	--

All the options are enabled by default.

Maintenance

Option	Description
Service Tag	Displays the Service Tag of your computer.
Asset Tag	Allows you to create a system asset tag if an asset tag is not already set. This option is not set by default.
BIOS Downgrade	<p>Allows you to control flashing of the system firmware to previous revisions. The option are:</p> <p>Allows BIOS Downgrade This option is enabled by default.</p>
Data Wipe	<p>Allows you to securely erase data from all internal storage devices. The process adheres to Serial ATA Security Erase and eMMC JEDEC Sanitize specifications. The option are:</p> <p>Wipe on Next Boot This option is disabled by default.</p>
BIOS Recovery	<p>Allows you to recover from certain computed BIOS conditions from a recovery file on the user primary hard drive or an external USB key. When 'Enabled' is selected BIOS stores the recovery file on the user primary hard drive. The option are:</p> <p>BIOS Recovery from Hard Drive This option is enabled by default.</p> <p>BIOS Auto-Recovery</p> <p>Always Perform Integrity Check</p>

System Log

Option	Description
BIOS Events	Allows you to view and clear the System Setup (BIOS) POST events.
Thermal Events	Allows you to view and clear the System Setup (Thermal) events.
Power Events	Allows you to view and clear the System Setup (Power) events.

Software

This chapter details the supported operating systems along with instructions on how to install the drivers.

Topics:

- [Supported operating systems](#)
- [Downloading drivers](#)

Supported operating systems

Table 9. Operating systems

Windows	<ul style="list-style-type: none"> • Microsoft Windows 10 Pro 64 bit • Microsoft Windows 10 Home 64 bit
Other	<ul style="list-style-type: none"> • Ubuntu
OS media support	<ul style="list-style-type: none"> • Dell.com/support to download eligible Windows OS • USB media available as upsell

Downloading drivers

- 1 Turn on the notebook.
- 2 Go to **Dell.com/support**.
- 3 Click **Product Support**, enter the Service Tag of your notebook, and then click **Submit**.

 **NOTE: If you do not have the Service Tag, use the auto detect feature or manually browse for your notebook model.**

- 4 Click **Drivers and Downloads**.
- 5 Select the operating system installed on your notebook.
- 6 Scroll down the page and select the driver to install.
- 7 Click **Download File** to download the driver for your notebook.
- 8 After the download is complete, navigate to the folder where you saved the driver file.
- 9 Double-click the driver file icon and follow the instructions on the screen.

Chipset driver

The chipset driver helps the system identify the components and install necessary drivers accurately. Verify that the chipset was installed in the system by checking the below controllers. Many of the common devices are visible under Other Devices if no drivers are installed. The unknown devices disappear once you install the chipset driver.

Make sure to install the following drivers, some of them may exist by default.

- Intel HID Event Filter Driver
- Intel Dynamic Platform and Thermal Framework Driver

- Intel serial IO driver
- Intel Thunderbolt(TM) Controller driver
- Management Engine
- Realtek PCI-E memory card

ControlVault drivers

Verify if the ControlVault Device drivers are already installed in the computer.

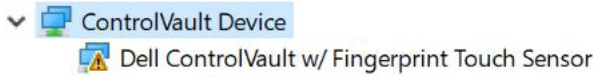

Human Interface Devices drivers













Verify if the Human Interface Devices drivers are already installed in the computer.



Network drivers



Install the WLAN and Bluetooth drivers from the Dell support site.

Verify if the Network drivers are already installed in the computer.

- ▼  Network adapters
 -  Bluetooth Device (Personal Area Network)
 -  Bluetooth Device (RFCOMM Protocol TDI)
 -  Intel(R) Dual Band Wireless-AC 8265
 -  Intel(R) Ethernet Connection (4) I219-LM
 -  WAN Miniport (IKEv2)
 -  WAN Miniport (IP)
 -  WAN Miniport (IPv6)
 -  WAN Miniport (L2TP)
 -  WAN Miniport (Network Monitor)
 -  WAN Miniport (PPPOE)
 -  WAN Miniport (PPTP)
 -  WAN Miniport (SSTP)



Audio drivers

Verify if the Realtek Audio drivers are already installed in the computer.

- ▼  Sound, video and game controllers
 -  Intel(R) Display Audio
 -  Realtek Audio

Disk drives

Verify if the Disk drives drivers are already installed in the computer.

- ▼  Disk drives
 -  NVMe PM961 NVMe SAMSU

Dynamic Platform and Thermal Framework Driver

Verify if the Dynamic Platform and Thermal Framework Driver are already installed in the computer.

- ▼  Intel(R) Dynamic Platform and Thermal Framework
 -  Intel(R) Dynamic Platform and Thermal Framework Generic Participant
 -  Intel(R) Dynamic Platform and Thermal Framework Generic Participant
 -  Intel(R) Dynamic Platform and Thermal Framework Generic Participant
 -  Intel(R) Dynamic Platform and Thermal Framework Manager
 -  Intel(R) Dynamic Platform and Thermal Framework Processor Participant

Management Engine Interface

Verify if the Intel Management Engine Interface drivers are already installed in the computer.

- System devices
 - ACPI Fixed Feature Button
 - ACPI Lid
 - ACPI Power Button
 - ACPI Processor Aggregator
 - ACPI Sleep Button
 - ACPI Thermal Zone
 - Charge Arbitration Driver
 - Composite Bus Enumerator
 - Dell Diag Control Device
 - Dell System Analyzer Control Device
 - High precision event timer
 - Intel(R) Management Engine Interface
 - Intel(R) Power Engine Plug-in
 - Intel(R) Serial IO I2C Host Controller - 9D60
 - Intel(R) Serial IO I2C Host Controller - 9D61
 - Intel(R) Serial IO I2C Host Controller - 9D62
 - Intel(R) Serial IO I2C Host Controller - 9D63
 - Intel(R) Serial IO I2C Host Controller - 9D64
 - Intel(R) Smart Sound Technology (Intel(R) SST) Audio Controller
 - Intel(R) Smart Sound Technology (Intel(R) SST) OED
 - Intel(R) Xeon(R) E3 - 1200 v6/7th Gen Intel(R) Core(TM) Host Bridge/DRAM Registers - 5914
 - Legacy device
 - Microsoft ACPI-Compliant Embedded Controller
 - Microsoft ACPI-Compliant System
 - Microsoft System Management BIOS Driver
 - Microsoft UEFI-Compliant System
 - Microsoft Virtual Drive Enumerator
 - Microsoft Windows Management Interface for ACPI
 - Microsoft Windows Management Interface for ACPI
 - Mobile 6th/7th Generation Intel(R) Processor Family I/O PCI Express Root Port #1 - 9D10

Serial IO driver

Verify if the drivers for Touchpad, and Portable Device are installed.

Figure 2. Serial IO driver

- 
 Human Interface Devices
 -  Converted Portable Device Control device
 -  Dell Touchpad
 -  HID-compliant consumer control device
 -  HID-compliant device
 -  HID-compliant system controller
 -  HID-compliant touch pad
 -  HID-compliant touch screen
 -  HID-compliant vendor-defined device
 -  HID-compliant vendor-defined device
 -  HID-compliant vendor-defined device
 -  HID-compliant wireless radio controls
 -  I2C HID Device
 -  Intel(R) HID Event Filter
 -  Microsoft Input Configuration Device
 -  Portable Device Control device
 -  USB Input Device

USB drivers

Verify if the USB drivers are already installed in the laptop.

- 
 Universal Serial Bus controllers
 -  Intel(R) USB 3.0 eXtensible Host Controller - 1.0 (Microsoft)
 -  UCSI USB Connector Manager
 -  USB Composite Device
 -  USB Composite Device
 -  USB Root Hub (USB 3.0)

Security drivers

This section lists the security devices in the Device Manager.

Security device drivers

Verify if the security device drivers are installed in the computer.

- 
 Security devices
 -  Trusted Platform Module 2.0

Fingerprint sensor drivers

Verify if the Fingerprint sensor drivers are installed in the computer.

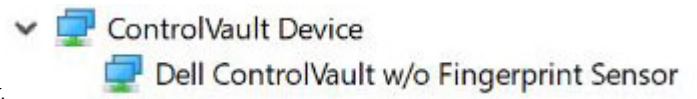

Troubleshooting

Dell Enhanced Pre-Boot System Assessment — ePSA Diagnostic 3.0

You can invoke the ePSA diagnostics by either of the following ways :

- Press the F12 key when the system posts and choose **ePSA or Diagnostics** option on One Time Boot Menu.
- Press and hold Fn(Function key on keyboard) and **Power On** (PWR) the system.

Diagnostic LED

This section details the diagnostic features of the battery LED in a notebook.

Instead of beep codes errors are indicated via the bicolor Battery Charge LED. A specific blink pattern is followed by flashing a pattern of flashes in amber, followed by white. The pattern then repeats.

NOTE: The diagnostic pattern will consist of a two digit number being represented by a first group of LED blinks (1 through 9) in amber, followed by a 1.5 second pause with the LED off, and then a second group of LED blinks (1 through 9) in white. This is then followed by a three second pause, with the LED off, before repeating over again. Each LED blink takes 0.5 seconds.

The system will not shutdown when displaying the Diagnostic Error Codes. Diagnostic Error Codes will always supersede any other use of the LED. For instance, on Notebooks, battery codes for Low Battery or Battery Failure situations will not be displayed when Diagnostic Error Codes are being displayed:

Table 10. LED pattern

Blinking pattern		Problem Description	Suggested Resolution
Amber	White		
2	1	processor	processor failure
2	2	system board, BIOS ROM	system board, covers BIOS corruption or ROM error
2	3	memory	no memory/no RAM detected
2	4	memory	memory failure/RAM failure
2	5	memory	invalid memory installed
2	6	system board; chipset	system board/ chipset error
2	7	display	display failure
3	1	RTC power failure	coin-cell battery failure
3	2	PCI/Video	PCI/Video card/chip failure
3	3	BIOS recovery 1	recovery image nor found
3	4	BIOS recovery 2	recovery image found but invalid

Real Time Clock reset

The Real Time Clock (RTC) reset function allows you to recover your Dell system from **No POST/No Boot/No Power** situations. To initiate the RTC reset on the system make sure system is in a power-off state and is connected to power source . Press and hold the power button for 25 seconds and then release the power button.

NOTE: If AC power is disconnected from the system during the process or the power button is held longer than 40 seconds, the RTC reset process is aborted.

The RTC reset will reset the BIOS to Defaults, un-provision Intel vPro and reset the system date and time. The following items are unaffected by the RTC reset:

- Service Tag
- Asset Tag
- Ownership Tag
- Admin Password
- System Password
- HDD Password
- Key Databases
- System Logs

The following items may or may not reset based on your custom BIOS setting selections:

- The Boot List
- Enable Legacy OROMs
- Secure Boot Enable
- Allow BIOS Downgrade

Contacting Dell

NOTE: If you do not have an active Internet connection, you can find contact information on your purchase invoice, packing slip, bill, or Dell product catalog.

Dell provides several online and telephone-based support and service options. Availability varies by country and product, and some services may not be available in your area. To contact Dell for sales, technical support, or customer service issues:

- 1 Go to **Dell.com/support**.
- 2 Select your support category.
- 3 Verify your country or region in the **Choose a Country/Region** drop-down list at the bottom of the page.
- 4 Select the appropriate service or support link based on your need.