

User's Guide

LTE3301 Series

LTE Indoor Gateway

Default Login Details

LAN IP Address	http://192.168.1.1
User Name	admin
Password	1234

Version 1.00 Edition 1, 10/2017

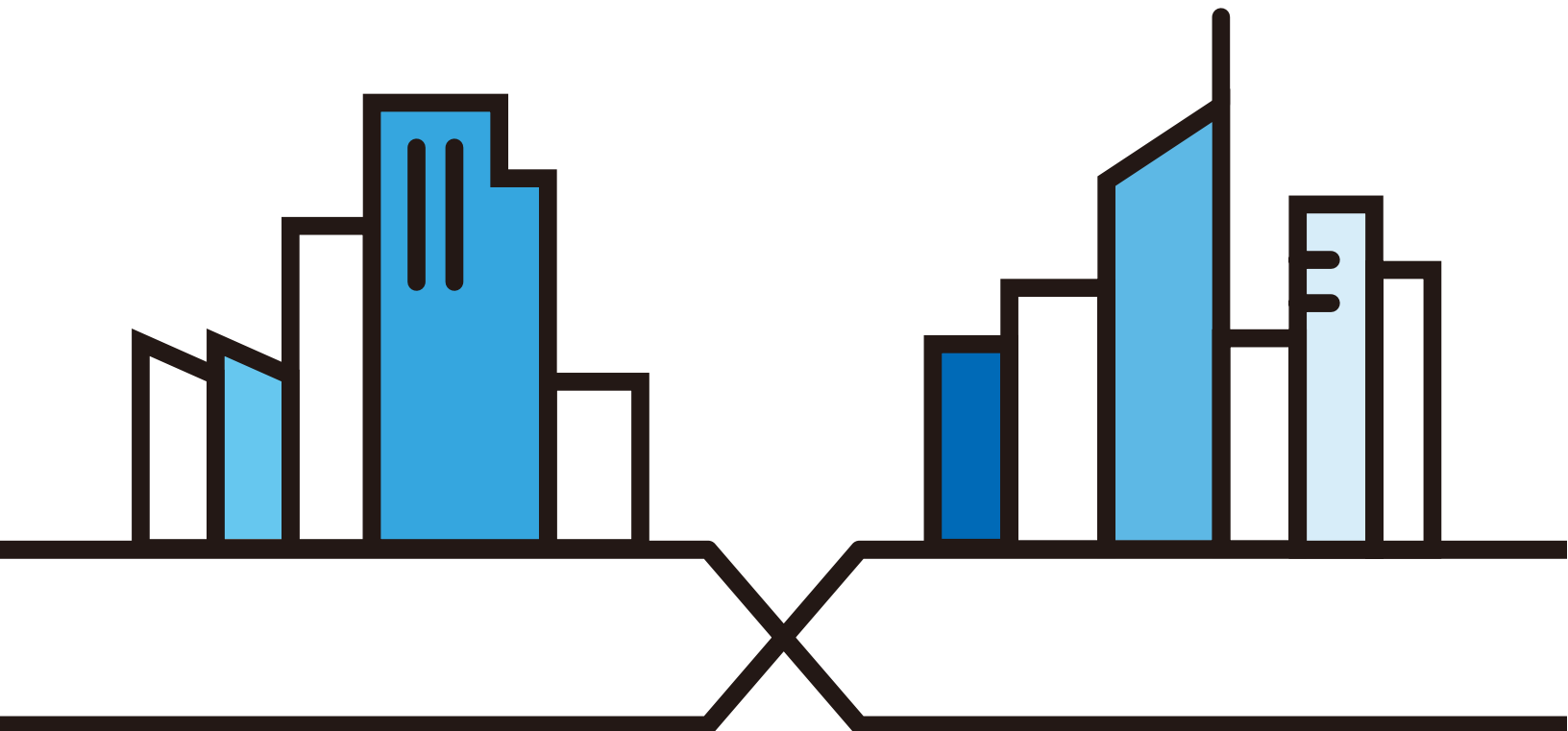

IMPORTANT!

READ CAREFULLY BEFORE USE.

KEEP THIS GUIDE FOR FUTURE REFERENCE.

Screenshots and graphics in this book may differ slightly from your product due to differences in your product firmware or your computer operating system. Every effort has been made to ensure that the information in this manual is accurate.

Related Documentation

- Quick Start Guide

The Quick Start Guide shows how to connect the LTE3301 and access the Web Configurator wizards. It contains information on setting up your network and configuring for Internet access.



Contents Overview

User's Guide	10
Introduction	11
Introducing the Web Configurator	16
Setup Wizard	25
Tutorials	30
Technical Reference	41
Monitor	42
WAN	49
Wireless LAN	60
LAN	80
DHCP Server	82
NAT	87
DDNS	96
Routing	98
Interface Group	101
Firewall	103
Content Filtering	108
IPv6 Firewall	111
Bandwidth Management	113
Universal Plug-and-Play (UPnP)	117
TR-069	123
Maintenance	125
Troubleshooting	133

Table of Contents

Contents Overview	3
Table of Contents	4
Part I: User's Guide.....	10
Chapter 1	
Introduction	11
1.1 Overview	11
1.2 Applications	11
1.3 Ways to Manage the LTE3301	12
1.4 Good Habits for Managing the LTE3301	12
1.5 Resetting the LTE3301	12
1.5.1 How to Use the RESET Button	12
1.6 The WPS Button	12
1.7 SIM Card Slot	13
1.8 LEDs	13
1.9 Wall Mounting	14
Chapter 2	
Introducing the Web Configurator	16
2.1 Overview	16
2.2 Accessing the Web Configurator	16
2.2.1 Login Screen	16
2.2.2 Password Screen	17
2.3 The Main Screen	18
2.3.1 Title Bar	19
2.3.2 Navigation Panel	19
2.4 Status Screen	21
Chapter 3	
Setup Wizard.....	25
3.1 Overview	25
3.2 Accessing the Wizard	25
3.3 Wizard Setup	25
Chapter 4	
Tutorials	30

4.1 Overview	30
4.2 Set Up a Wireless Network Using WPS	30
4.2.1 Push Button Configuration (PBC)	30
4.2.2 PIN Configuration	31
4.3 Connect to LTE3301 Wireless Network without WPS	32
4.3.1 Configure Your Notebook	34
4.4 Using Multiple SSIDs on the LTE3301	36
4.4.1 Configuring Security Settings of Multiple SSIDs	37
Part II: Technical Reference.....	41
Chapter 5	
Monitor.....	42
5.1 Overview	42
5.2 What You Can Do	42
5.3 The Log Screen	42
5.3.1 View Log	42
5.4 DHCP Table	43
5.5 Packet Statistics	44
5.6 WLAN Station Status	45
5.7 LTE Modem Status	46
Chapter 6	
WAN	49
6.1 Overview	49
6.2 What You Can Do	49
6.3 What You Need To Know	50
6.4 Management WAN	52
6.4.1 Management WAN Edit	53
6.5 Network Scan	56
6.6 IPv6	57
Chapter 7	
Wireless LAN	60
7.1 Overview	60
7.1.1 What You Can Do	60
7.1.2 What You Should Know	61
7.2 General Wireless LAN Screen	63
7.3 Wireless Security	65
7.3.1 No Security	65
7.3.2 WEP Encryption	66

7.3.3 WPA-PSK/WPA2-PSK	68
7.3.4 WPA/WPA2	69
7.4 More AP Screen	70
7.4.1 More AP Edit	71
7.5 MAC Filter Screen	72
7.6 Wireless LAN Advanced Screen	74
7.7 Quality of Service (QoS) Screen	75
7.8 WPS Screen	75
7.9 WPS Station Screen	77
7.10 Scheduling Screen	77
7.11 WDS Screen	78
Chapter 8	
LAN	80
8.1 Overview	80
8.2 What You Can Do	80
8.3 What You Need To Know	80
8.4 LAN IP Screen	81
Chapter 9	
DHCP Server.....	82
9.1 Overview	82
9.1.1 What You Can Do	82
9.1.2 What You Need To Know	82
9.2 DHCP Server General Screen	82
9.3 DHCP Server Advanced Screen	84
9.4 DHCP Client List Screen	86
Chapter 10	
NAT	87
10.1 Overview	87
10.1.1 What You Can Do	87
10.2 General Screen	88
10.3 Port Forwarding Screen	88
10.3.1 Port Forwarding Edit Screen	90
10.4 Port Trigger Screen	91
10.5 ALG Screen	92
10.6 Technical Reference	93
10.6.1 NATPort Forwarding: Services and Port Numbers	93
10.6.2 NAT Port Forwarding Example	94
10.6.3 Trigger Port Forwarding	94
10.6.4 Trigger Port Forwarding Example	94
10.6.5 Two Points To Remember About Trigger Ports	95

Chapter 11	
DDNS	96
11.1 Overview	96
11.2 General	96
Chapter 12	
Routing	98
12.1 Overview	98
12.2 Static Route Screen	98
12.2.1 Add/Edit Static Route	99
12.3 Dynamic Routing Screen	100
Chapter 13	
Interface Group	101
13.1 Overview	101
13.2 Interface Group Screen	101
13.2.1 Interface Group > Add Screen	102
Chapter 14	
Firewall	103
14.1 Overview	103
14.1.1 What You Can Do	103
14.1.2 What You Need To Know	103
14.2 General Screen	104
14.3 Services Screen	105
Chapter 15	
Content Filtering	108
15.1 Overview	108
15.2 Content Filter	108
Chapter 16	
IPv6 Firewall	111
16.1 Overview	111
16.2 IPv6 Firewall Screen	111
Chapter 17	
Bandwidth Management	113
17.1 Overview	113
17.2 What You Can Do	113
17.3 What You Need To Know	113
17.4 General Screen	114
17.5 Advanced Screen	114

17.5.1 Add Bandwidth management Rule	115
Chapter 18	
Universal Plug-and-Play (UPnP).....	117
18.1 Overview	117
18.2 What You Need to Know	117
18.2.1 NAT Traversal	117
18.2.2 Cautions with UPnP	117
18.3 UPnP Screen	118
18.4 Technical Reference	118
18.4.1 Using UPnP in Windows XP Example	118
18.4.2 Web Configurator Easy Access	120
Chapter 19	
TR-069.....	123
19.1 Overview	123
19.2 TR-069 Screen	123
Chapter 20	
Maintenance.....	125
20.1 Overview	125
20.2 What You Can Do	125
20.3 General Screen	125
20.4 Account Screen	126
20.4.1 Edit a User Account	126
20.5 Time Setting Screen	127
20.6 Firmware Upgrade Screen	129
20.7 Configuration Backup/Restore Screen	130
20.8 Restart Screen	132
Chapter 21	
Troubleshooting.....	133
21.1 Overview	133
21.2 Power, Hardware Connections, and LEDs	133
21.3 LTE3301 Access and Login	134
21.4 Internet Access	135
21.5 Wireless Connections	136
21.6 Getting More Troubleshooting Help	137
Appendix A Pop-up Windows, JavaScript and Java Permissions	138
Appendix B Setting Up Your Computer's IP Address.....	147
Appendix C Common Services	173

Appendix D Customer Support 176

Appendix E Legal Information 182

Index189

PART I

User's Guide

CHAPTER 1

Introduction

1.1 Overview

This chapter introduces the main features and applications of the LTE3301.

The LTE3301 is a wireless router, which can connect to a mobile network and the Internet through a wireless WAN connection and provide easy network access to mobile users without additional wiring. You can set up a wireless network with other IEEE 802.11b/g/n compatible devices.

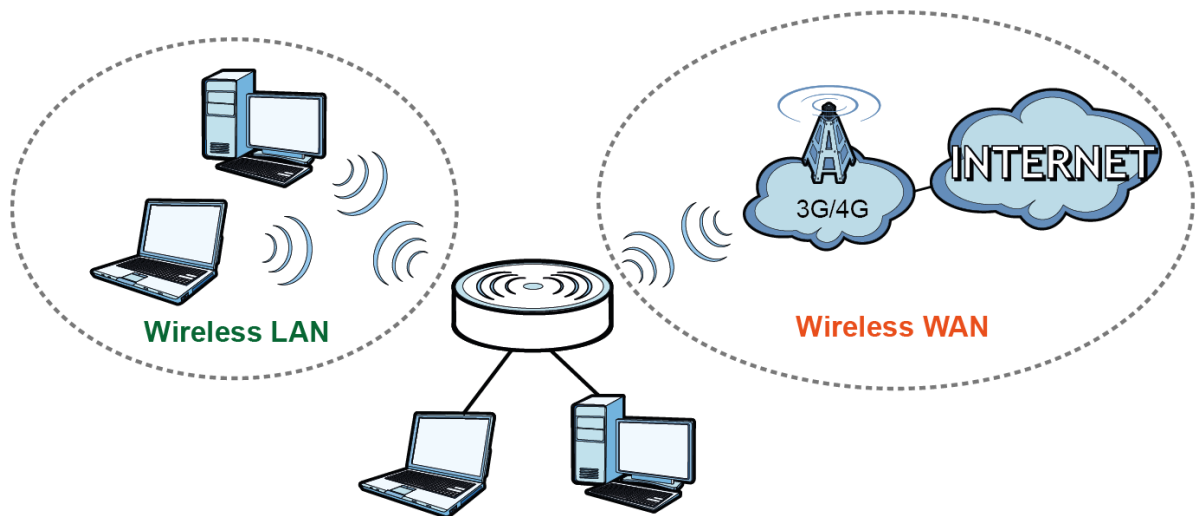

A range of services such as a firewall and content filtering are also available for secure Internet computing.

1.2 Applications

You can have the following networks with the LTE3301:

- **Wired.** You can connect network devices via the Ethernet ports of the LTE3301 so that they can communicate with each other and access the Internet.
- **Wireless LAN.** Wireless clients can connect to the LTE3301 to access network resources. You can use WPS (Wi-Fi Protected Setup) to create an instant network connection with another WPS-compatible device.
- **Wireless WAN.** Insert a 4G SIM card into the SIM card slot to connect to a mobile network for Internet access.

1.3 Ways to Manage the LTE3301

Use any of the following methods to manage the LTE3301.

- WPS (Wi-Fi Protected Setup). You can use the WPS button or the WPS section of the Web Configurator to set up a wireless network with your LTE3301.
- Web Configurator. This is recommended for everyday management of the LTE3301 using a (supported) web browser.

1.4 Good Habits for Managing the LTE3301

Do the following things regularly to make the LTE3301 more secure and to manage the LTE3301 more effectively.

- Change the password. Use a password that's not easy to guess and that consists of different types of characters, such as numbers and letters.
- Write down the password and put it in a safe place.
- Back up the configuration (and make sure you know how to restore it). See [Section 20.7 on page 130](#). Restoring an earlier working configuration may be useful if the device becomes unstable or even crashes. If you forget your password, you will have to reset the LTE3301 to its factory default settings. If you backed up an earlier configuration file, you would not have to totally re-configure the LTE3301. You could simply restore your last configuration.

1.5 Resetting the LTE3301

If you forget your password or IP address, or you cannot access the Web Configurator, you will need to use the **RESET** button at the back of the LTE3301 to reload the factory-default configuration file. This means that you will lose all configurations that you had previously saved, the password will be reset to "1234" (see [Section 20.4 on page 126](#)) and the IP address will be reset to "192.168.1.1".

1.5.1 How to Use the RESET Button

- 1 Make sure the power LED is on.
- 2 Press the **RESET** button for one to four seconds to restart/reboot the LTE3301.
- 3 Press the **RESET** button for longer than ten seconds to set the LTE3301 back to its factory-default configurations.

1.6 The WPS Button

Your LTE3301 supports Wi-Fi Protected Setup (WPS), which is an easy way to set up a secure wireless network. WPS is an industry standard specification, defined by the Wi-Fi Alliance.

WPS allows you to quickly set up a wireless network with strong security, without having to configure security settings manually. Each WPS connection works between two devices. Both devices must support WPS (check each device's documentation to make sure).

Depending on the devices you have, you can either press a button (on the device itself, or in its configuration utility) or enter a PIN (a unique Personal Identification Number that allows one device to authenticate the other) in each of the two devices. When WPS is activated on a device, it has two minutes to find another device that also has WPS activated. Then, the two devices connect and set up a secure network by themselves.

You can use the WPS button () on the top panel of the LTE3301 to activate WPS in order to quickly set up a wireless network with strong security.

- 1 Make sure the power LED is on (not blinking).
- 2 Press the WPS button for more than three seconds and release it. Press the WPS button on another WPS-enabled device within range of the LTE3301.

Note: You must activate WPS in the LTE3301 and in another wireless device within two minutes of each other.

For more information on using WPS, see [Section 4.2 on page 30](#).

1.7 SIM Card Slot

The LTE3301 comes with a built-in 4G LTE module for 4G connections. To set up a 4G connection using the built-in 4G LTE module, just insert a 4G SIM card into the SIM card slot at the back of the LTE3301.

Note: You must insert the 4G SIM card into the card slot before turning on the LTE3301.

1.8 LEDs

Figure 1 Front Panel

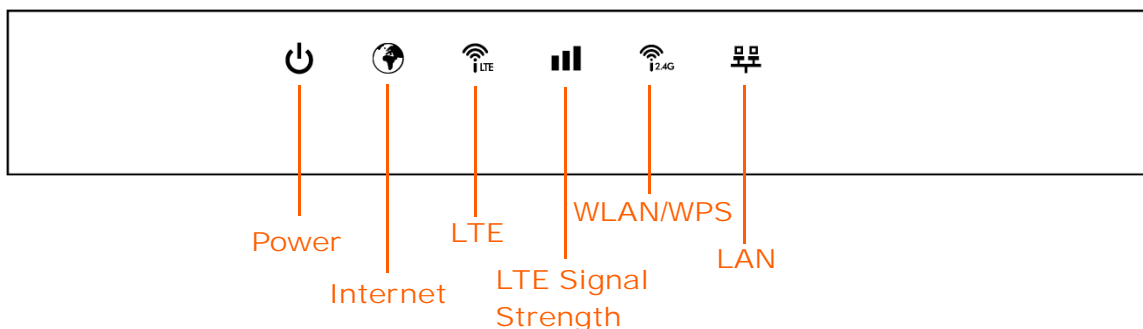

The following table describes the LEDs.

Table 1 Front panel LEDs

LED	COLOR	STATUS	DESCRIPTION
Power	Green	On	The LTE3301 is receiving power and functioning properly.
		Blinking	The LTE3301 is in the process of starting up or default restoring.
	Off		The LTE3301 is not receiving power.
Internet	Green	On	The LTE3301's WAN connection is ready.
		Blinking	The LTE3301 is sending/receiving data through the WAN.
	Off		The WAN connection is not ready, or has failed.
LTE	Green	On	The LTE3301 is registered and successfully connected to a 4G network.
		Blinking (slow)	The LTE3301 is registered and successfully connected to a 2G/3G network.
		Blinking (fast)	The LTE3301 Series is looking for an available 4G/3G/2G network.
	Off		There is no SIM card inserted, the SIM card is invalid, the PIN code is not correct or there is no service.
LTE Signal Strength	Green	On	A valid SIM card is inserted and the wireless WAN interface is enabled. Signal strength: Excellent RSRP (Reference Signal Receiving Power) ≥ -79 dBm
		Orange	On Signal strength: Fair -81 dBm \geq RSRP ≥ -95 dBm
	Red	On	Signal strength: Poor -97 dBm $>$ RSRP
		Blinking	There is no LTE signal because there is no valid SIM card inserted and/or the wireless WAN interface is disabled.
WLAN/WPS	Green	On	The LTE3301 is ready and the 2.4GHz wireless LAN is on, but is not sending/receiving data through the wireless LAN.
		Blinking (slow)	The LTE3301 is sending/receiving data through the wireless LAN.
		Blinking (fast)	The LTE3301 is negotiating a WPS connection with a wireless client.
	Off		The wireless LAN is not ready or has failed or WPS is disabled.
LAN	Green	On	The LTE3301's LAN connection is ready.
	Off		The LAN connection is not ready, or has failed.

1.9 Wall Mounting

You may need screw anchors if mounting on a concrete or brick wall.

Table 2 Wall Mounting Information

Distance between holes	11 cm
------------------------	-------

Table 2 Wall Mounting Information

M4 Screws	Two
Screw anchors (optional)	Two

- 1 Select a position free of obstructions on a wall strong enough to hold the weight of the device.
- 2 Mark two holes on the wall at the appropriate distance apart for the screws.

Be careful to avoid damaging pipes or cables located inside the wall when drilling holes for the screws.

- 3 If using screw anchors, drill two holes for the screw anchors into the wall. Push the anchors into the full depth of the holes, then insert the screws into the anchors. Do not insert the screws all the way in - leave a small gap of about 0.5 cm.

If not using screw anchors, use a screwdriver to insert the screws into the wall. Do not insert the screws all the way in - leave a gap of about 0.5 cm.

- 4 Make sure the screws are fastened well enough to hold the weight of the LTE3301 with the connection cables.
- 5 Align the holes on the back of the LTE3301 with the screws on the wall. Hang the LTE3301 on the screws.

Figure 2 Wall Mounting Example

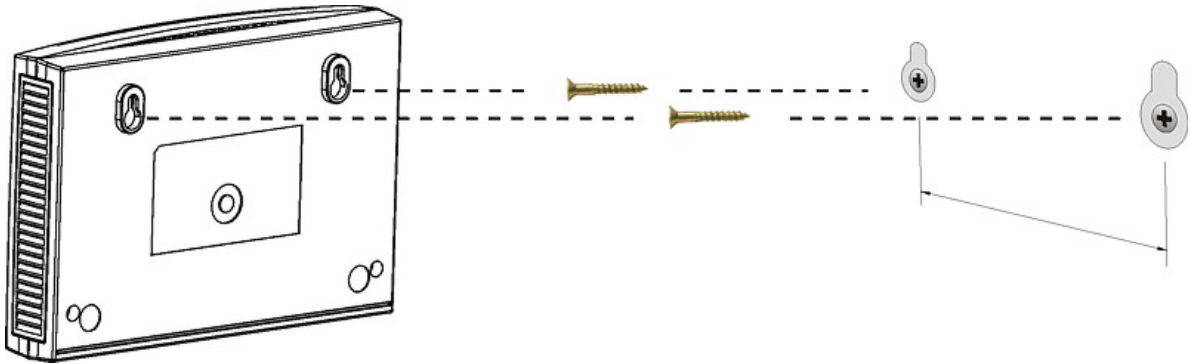

CHAPTER 2

Introducing the Web Configurator

2.1 Overview

This chapter describes how to access the LTE3301 Web Configurator and provides an overview of its screens.

The Web Configurator is an HTML-based management interface that allows easy setup and management of the LTE3301 via Internet browser. Use Internet Explorer 9.0 and later versions, Mozilla Firefox 21 and later versions, Safari 6.0 and later versions or Google Chrome 26.0 and later versions. The recommended screen resolution is 1024 by 768 pixels.

In order to use the Web Configurator you need to allow:

- Web browser pop-up windows from your device. Web pop-up blocking is enabled by default in Windows XP SP (Service Pack) 2.
- JavaScript (enabled by default).
- Java permissions (enabled by default).

Refer to the Troubleshooting chapter ([Chapter 21 on page 133](#)) to see how to make sure these functions are allowed in Internet Explorer.

2.2 Accessing the Web Configurator

- 1 Make sure your LTE3301 hardware is properly connected and prepare your computer or computer network to connect to the LTE3301 (refer to the Quick Start Guide).
- 2 Launch your web browser.
- 3 Type "http://192.168.1.1" as the website address.

Your computer must be in the same subnet in order to access this website address.

2.2.1 Login Screen

The Web Configurator initially displays the following login screen.

Figure 3 Login screen



The following table describes the labels in this screen.

Table 3 Login screen

LABEL	DESCRIPTION
User	Type "admin" (default) as the user name.
Password	Type "1234" (default) as the password. Click Login .

2.2.2 Password Screen

You should see a screen asking you to change your password (highly recommended) as shown next.

Figure 4 Change Password Screen



The following table describes the labels in this screen.

Table 4 Change Password Screen

LABEL	DESCRIPTION
New Password	Type a new password.
Retype to Confirm	Retype the password for confirmation.
Apply	Click Apply to save your changes back to the LTE3301.
Ignore	Click Ignore if you do not want to change the password this time.

Note: The management session automatically times out when the time period set in the **Administrator Inactivity Timer** field expires (default five minutes; go to [Chapter 20 on page 125](#) to change this). Simply log back into the LTE3301 if this happens.

2.3 The Main Screen

The Web Configurator's main screen is divided into these parts:

Figure 5 The Web Configurator's Main Screen

The screenshot shows the ZyXEL LTE3301 Web Configurator's main screen. The interface is divided into several sections:

- Top Bar:** Displays the ZyXEL logo and 'LTE3301'. On the right, there are navigation icons (Home, Help, Logout) and a 'Refresh Interval' dropdown set to 'None' with a 'Refresh Now' button.
- Left Sidebar:** Contains navigation icons for Home, Status, Configuration, and System.
- Main Content Area:**
 - Status Section:**
 - Device Information Table:**

Item	Data
Host Name:	LTE3301
Model Number:	LTE3301
Firmware Version:	V1.00(AAYE.0)C1
WAN Information	
- MAC Address:	90.EF.68.D3.A2.DC
- IP Address:	100.123.41.106
- IP Subnet Mask:	255.255.255.252
- Default Gateway:	100.123.41.105
- IPv6 Address:	
- Operation Band:	LTE 1800+
LAN Information:	
- MAC Address:	90.EF.68.D3.A2.DD
- IP Address:	192.168.1.1
- IP Subnet Mask:	255.255.255.0
- DHCP:	Server
- IPv6 Address:	
WLAN Information:	
- WLAN OP Mode:	Access Point Mode
- MAC Address:	90.EF.68.D3.A2.DD
- SSID:	ZyXEL_A2DD
- Channel:	3
- System:	B/G/N Mixed
- Security:	WPA2-PSK
Firewall:	Enable
 - System Status Table:**

Item	Data
System Up Time:	0day 1hr 14min 54sec
Current Date/Time:	2013-1-1/01:28:11
System Resource:	
- CPU Usage:	11%
- Memory Usage:	65%
 - Interface Status Table:**

Interface	Status	Rate
WAN	UP	150M
LAN 1	Down	
LAN 2	Down	
LAN 3	Down	
LAN 4	Down	
WLAN	UP	300M

- A - Title Bar
- B - Navigation Panel
- C - Main Window

2.3.1 Title Bar



The title bar provides some useful links that always appear over the screens below, regardless of how deep into the Web Configurator you navigate.

Figure 6 Title Bar



The icons provide the following functions.

Table 5 Title Bar: Web Configurator Icons

LABEL	DESCRIPTION
Wizard 	Click this icon to open the setup wizard for the LTE3301.
About 	Click this icon to open a screen where you can click a link to visit the ZyXEL web site to see detailed product information.
Logout 	Click this icon to log out of the Web Configurator.

2.3.2 Navigation Panel

Use the sub-menus on the navigation panel to configure LTE3301 features.

Figure 7 Navigation Panel

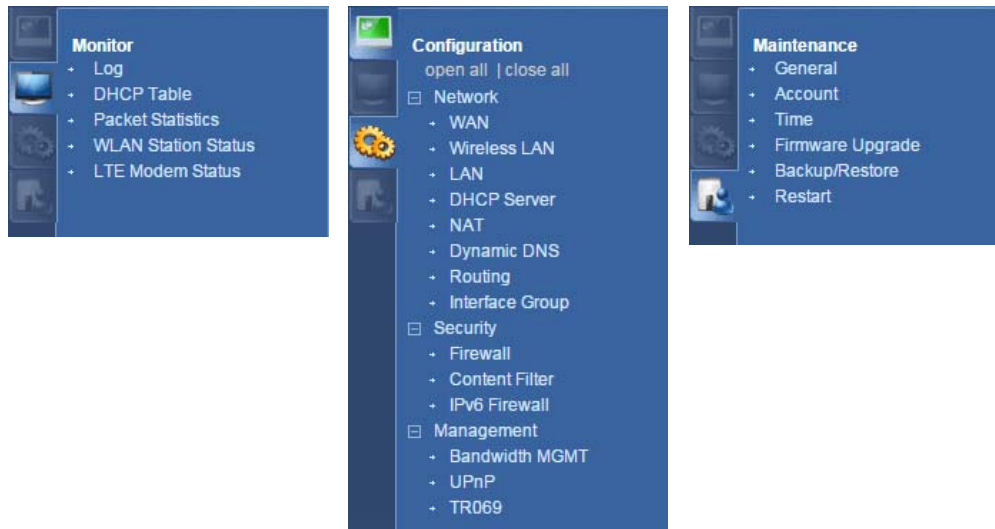

The following table describes the sub-menus.

Table 6 Navigation Panel

LINK	TAB	FUNCTION
Status		This screen shows the LTE3301's general device, system and interface status information. Use this screen to access the summary statistics tables.
Monitor		
Log		Use this screen to view the list of activities recorded by your LTE3301.
DHCP Table		Use this screen to view current DHCP client information.
Packet Statistics		Use this screen to view port status and packet specific statistics.
WLAN Station Status		Use this screen to view the wireless stations that are currently associated to the LTE3301's 2.4GHz wireless LAN.
LTE Modem Status		Use this screen to view the detailed information about the LTE module, cellular interface, and SIM card. You can also view the LTE connection status.
Configuration		
Network		
WAN	Management WAN	This screen allows you to configure ISP parameters, WAN IP address assignment, and DNS servers.
	Network Scan	Use this screen to specify the type of the mobile network to which the LTE3301 is connected and how you want the LTE3301 to connect to an available mobile network.
	IPv6	Use this screen to configure the LTE3301's IPv6 settings.
Wireless LAN	General	Use this screen to enable the wireless LAN and configure wireless LAN and wireless security settings.
	More AP	Use this screen to configure multiple BSSs on the LTE3301.
	MAC Filter	Use the MAC filter screen to allow or deny wireless stations based on their MAC addresses from connecting to the LTE3301.
	Advanced	This screen allows you to configure advanced wireless LAN settings.
	QoS	Use this screen to configure Wi-Fi Multimedia Quality of Service (WMM QoS). WMM QoS allows you to prioritize wireless traffic according to the delivery requirements of individual services.
	WPS	Use this screen to configure the WPS settings.
	WPS Station	Use this screen to add a wireless station using WPS.
	Scheduling	Use this screen to schedule the times the Wireless LAN is enabled.
WDS	Use this screen to enable and configure the WDS settings.	
LAN	IP	Use this screen to configure LAN IP address and subnet mask.
DHCP Server	General	Use this screen to enable the LTE3301's DHCP server.
	Advanced	Use this screen to assign IP addresses to specific individual computers based on their MAC addresses and to have DNS servers assigned by the DHCP server.
	Client List	Use this screen to view information related to your DHCP status.
NAT	General	Use this screen to enable NAT.
	Port Forwarding	Use this screen to configure servers behind the LTE3301 and forward incoming service requests to the server(s) on your local network.
	Port Trigger	Use this screen to change your LTE3301's port triggering settings.
	ALG	Use this screen to enable or disable SIP (VoIP) ALG (Application Layer Gateway) in the LTE3301.
Dynamic DNS	Dynamic DNS	Use this screen to set up dynamic DNS.

Table 6 Navigation Panel (continued)

LINK	TAB	FUNCTION
Routing	Static Route	Use this screen to configure IP static routes.
	Dynamic Routing	Use this screen to enable and configure RIP on the LTE3301.
Interface Group	Interface Group	Use this screen to create a new interface group.
Security		
Firewall	General	Use this screen to activate/deactivate the firewall.
	Services	This screen shows a summary of the firewall rules, and allows you to edit/add a firewall rule.
Content Filter	Content Filter	Use this screen to restrict web features and designate a trusted computer. You can also block certain web sites containing certain keywords in the URL.
IPv6 firewall	Services	Use this screen to configure IPv6 firewall rules.
Management		
Bandwidth Management	General	Use this screen to enable bandwidth management.
	Advanced	Use this screen to set the upstream bandwidth and edit a bandwidth management rule.
UPnP	UPnP	Use this screen to enable UPnP on the LTE3301.
TR069	TR069	Use this screen to configure your LTE3301 to be managed by an ACS.
Maintenance		
General	General	Use this screen to view and change administrative settings such as system and domain names.
Account	User Account	Use this screen to change the user name and password of your LTE3301.
Time	Time Setting	Use this screen to change your LTE3301's time and date.
Firmware Upgrade	Firmware Upgrade	Use this screen to upload firmware to your LTE3301.
Backup/Restore	Backup/Restore	Use this screen to backup and restore the configuration or reset the factory defaults to your LTE3301.
Restart	System Restart	This screen allows you to reboot the LTE3301 without turning the power off.

2.4 Status Screen





Click  to open the status screen.

Figure 8 Status Screen

The following table describes the icons shown in the **Status** screen.

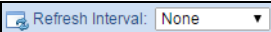
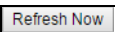
Table 7 Status Screen Icon Key

ICON	DESCRIPTION
	Select a number of seconds or None from the drop-down list box to refresh all screen statistics automatically at the end of every time interval or to not refresh the screen statistics.
	Click this button to refresh the status screen statistics.
	Click this icon to see the Status page. The information in this screen depends on the device mode you select.
	Click this icon to see the Monitor navigation menu.
	Click this icon to see the Configuration navigation menu.
	Click this icon to see the Maintenance navigation menu.

The following table describes the labels shown in the **Status** screen.

Table 8 Status Screen

LABEL	DESCRIPTION
Device Information	
Host Name	This is the System Name you enter in the Maintenance > General screen. It is for identification purposes.
Model Number	This is the model name of your device.
Firmware Version	This is the firmware version and the date created.
WAN Information	
MAC Address	This shows the WAN Ethernet adapter MAC Address of your device.
IP Address	This shows the WAN port's IP address.
IP Subnet Mask	This shows the WAN port's subnet mask.
Default Gateway	This shows the WAN port's gateway IP address.
IPv6 Address	This shows the IPv6 address of the LTE3301 on the WAN.
Operation Band	This shows the network type and the frequency band used by the mobile network to which the LTE3301 is connecting.
LAN Information	
MAC Address	This shows the LAN Ethernet adapter MAC Address of your device.
IP Address	This shows the LAN port's IP address.
IP Subnet Mask	This shows the LAN port's subnet mask.
DHCP	This shows the LAN port's DHCP role - Server or Disable .
IPv6 Address	This shows the IPv6 address of the LTE3301 on the LAN.
WLAN Information	
WLAN OP Mode	This is the device mode to which the LTE3301's wireless LAN is set - Access Point Mode .
MAC Address	This shows the 2.4GHz wireless adapter MAC Address of your device.
SSID	This shows a descriptive name used to identify the LTE3301 in the 2.4GHz wireless LAN.
Channel	This shows the channel number which you select manually.
System	This shows the wireless standards the LTE3301 supports.
Security	This shows the level of wireless security the LTE3301 is using.
Firewall	This shows whether the firewall is enabled or not.
Summary	
Packet Statistics	Click Details... to go to the Monitor > Packet Statistics screen (Section 5.5 on page 44). Use this screen to view port status and packet specific statistics.
WLAN Station Status	Click Details... to go to the Monitor > WLAN Station Status screen (Section 5.6 on page 45). Use this screen to view the wireless stations that are currently associated to the LTE3301's 2.4GHz wireless LAN.
LTE Modem Status	Click Details... to go to the Monitor > LTE Modem Status screen (Section 5.6 on page 45). Use this screen to view the detailed information about the LTE module, cellular interface, and SIM card. You can also view the LTE connection status.
System Status	
Item	This column shows the type of data the LTE3301 is recording.
Data	This column shows the actual data recorded by the LTE3301.
System Up Time	This is the total time the LTE3301 has been on.
Current Date/Time	This field displays your LTE3301's present date and time.
System Resource	

Table 8 Status Screen (continued)

LABEL	DESCRIPTION
- CPU Usage	This displays what percentage of the LTE3301's processing ability is currently used. When this percentage is close to 100%, the LTE3301 is running at full load, and the throughput is not going to improve anymore. If you want some applications to have more throughput, you should turn off other applications (for example, using bandwidth management.)
- Memory Usage	This shows what percentage of the heap memory the LTE3301 is using.
Interface Status	
Interface	This displays the LTE3301 port types. The port types are: WAN , LAN and WLAN .
Status	For the LAN and WAN ports, this field displays Down (line is down) or Up (line is up or connected). For the 2.4GHz WLAN, it displays Up when the 2.4GHz WLAN is enabled or Down when the 2.4G WLAN is disabled.
Rate	For the LAN ports, this displays the port speed or is left blank when the line is disconnected. For the WAN port, it always displays the maximum transmission rate. For the 2.4GHz WLAN, it displays the maximum transmission rate when the WLAN is enabled and is left blank when the WLAN is disabled.

CHAPTER 3

Setup Wizard

3.1 Overview

This chapter provides information on the wizard setup screens in the Web Configurator.

The Web Configurator's wizard helps you configure your device to access the Internet and change the wireless LAN settings. Refer to your ISP for your Internet account information. Leave a field blank if you don't have that information.

3.2 Accessing the Wizard

- 1 Launch your web browser and type "http://192.168.1.1" as the website address. Type "admin" (default) as the user name, "1234" (default) as the password and click **Login**.
- 2 Click the **Wizard** icon in the top right corner of the web configurator to open the Wizard screen.

Figure 9 Title Bar: Wizard icon

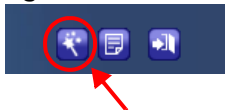

3.3 Wizard Setup

- 1 The first wizard screen displays showing the main steps in the wizard setup. Click **Next** to proceed with the time zone setup screen.

Figure 10 Wizard: Start

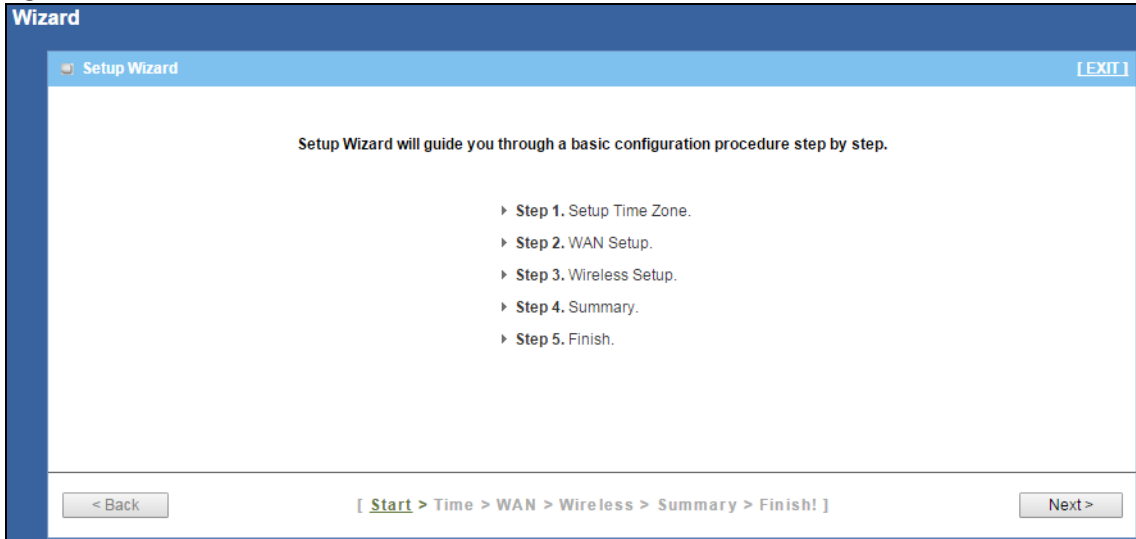

- 2 The LTE3301 automatically detects your location and displays the correct time zone. If the result is not correct, click **Detect Again** or manually select the time zone of LTE3301's location and click **Next**.

Figure 11 Wizard: Time

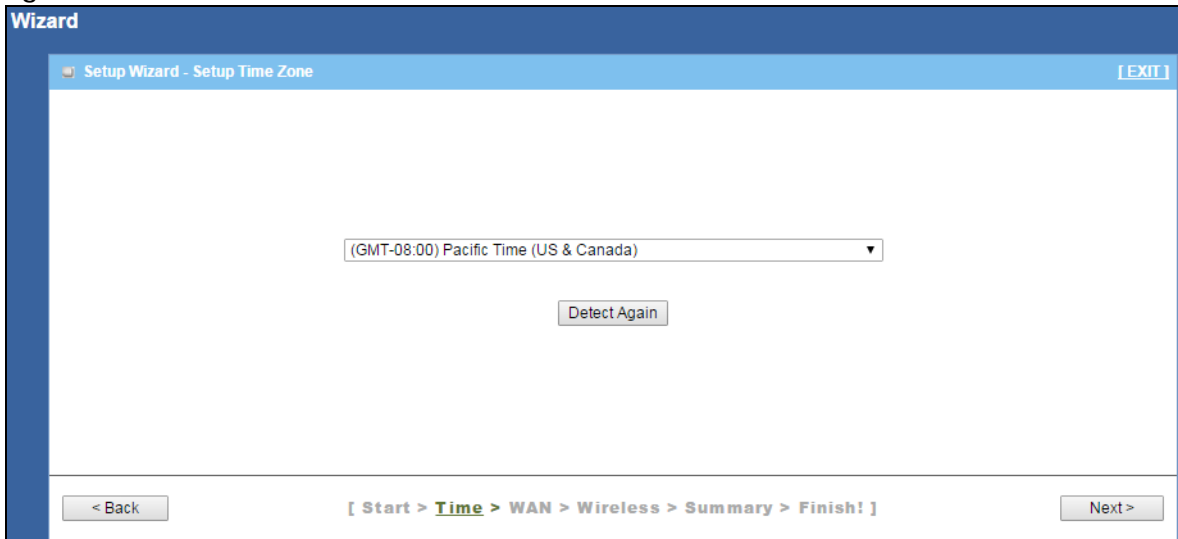

- 3 Enter your APN (Access Point Name) provided by your service provider. Select the country where the LTE3301 is located and your service provider name. Click **Next**.

Figure 12 Wizard: WAN

The screenshot shows a window titled "Wizard" with a sub-header "Setup Wizard - Internet Configuration" and an "[EXIT]" button in the top right. The main content area displays the text "The current connection type is set to LTE." followed by three configuration items: "APN Name" with a text box containing "internet", "Country" with a dropdown menu showing "Taiwan", and "Service Provider" with a dropdown menu showing "Chunghwa Telecom". At the bottom, there are three buttons: "< Back" on the left, a breadcrumb-style navigation bar "[Start > Time > WAN > Wireless > Summary > Finish!]" in the center, and "Next >" on the right.

- 4 Use this screen to enable or disable the LTE3301's wireless LAN, and enter the wireless network name (SSID). Select a channel or use **Auto** to have the LTE3301 automatically determine a channel to use. Click **Next**.

Figure 13 Wizard: Wireless Settings

The screenshot shows a window titled "Wizard" with a sub-header "Setup Wizard - Wireless settings" and an "[EXIT]" button in the top right. The main content area displays three configuration items: "Wireless Module" with radio buttons for "Enable" (selected) and "Disable", "Network ID(SSID)" with a text box containing "ZyXEL_A2DD", and "Channel" with a dropdown menu showing "Auto". At the bottom, there are three buttons: "< Back" on the left, a breadcrumb-style navigation bar "[Start > Time > WAN > Wireless > Summary > Finish!]" in the center, and "Next >" on the right.

- 5 Select **WPA2-PSK** and enter a pre-shared key from 8 to 63 case-sensitive characters for data encryption. The wireless clients which want to associate with this wireless network must have the same wireless security settings. Otherwise, select **No Security** to allow any client to associate with this network without any data encryption or authentication. Click **Next**.

Figure 14 Wizard: Wireless Security

Wizard

Setup Wizard - Wireless settings [EXIT]

▶ Security Mode WPA2-PSK ▼

▶ Pre-Shared Key 48A7B141263C1

< Back [Start > Time > WAN > **Wireless** > Summary > Finish!] Next >

- 6 Use the read-only summary table to check whether what you have configured is correct. Click **Apply Settings** to save your settings. Otherwise, click **Back** to go back to the previous screens.

Figure 15 Wizard: Summary

Wizard

Setup Wizard - Summary [EXIT]

Please confirm the information below

[WAN Setting]	
WAN Interface	WAN
WAN Type	3G/4G
APN	internet
[Wireless Setting]	
Wireless	Enable
SSID	ZyXEL_A2DD
Channel	Auto
Security Mode	WPA2-PSK
Pre-Shared Key	48A7B141263C1

Do you want to proceed the network testing?

< Back [Start > Time > WAN > Wireless > **Summary** > Finish!] Apply Settings

- 7 The system takes about 35 seconds to apply settings.

Figure 16 Wizard: Apply Settings

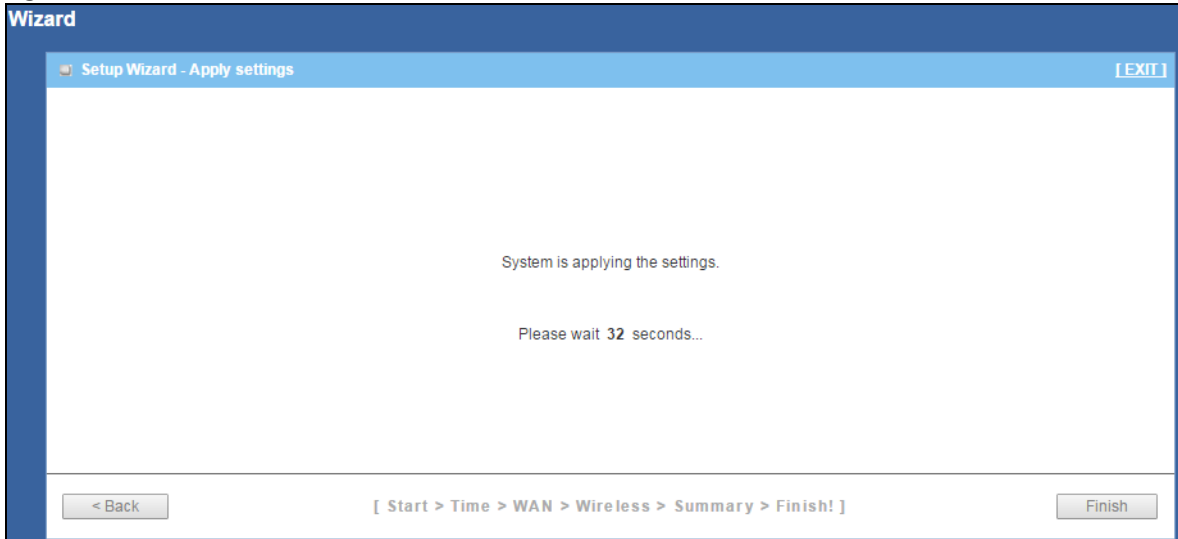

- 8 Click **Finish** to complete the wizard setup.

Figure 17 Wizard: Finish

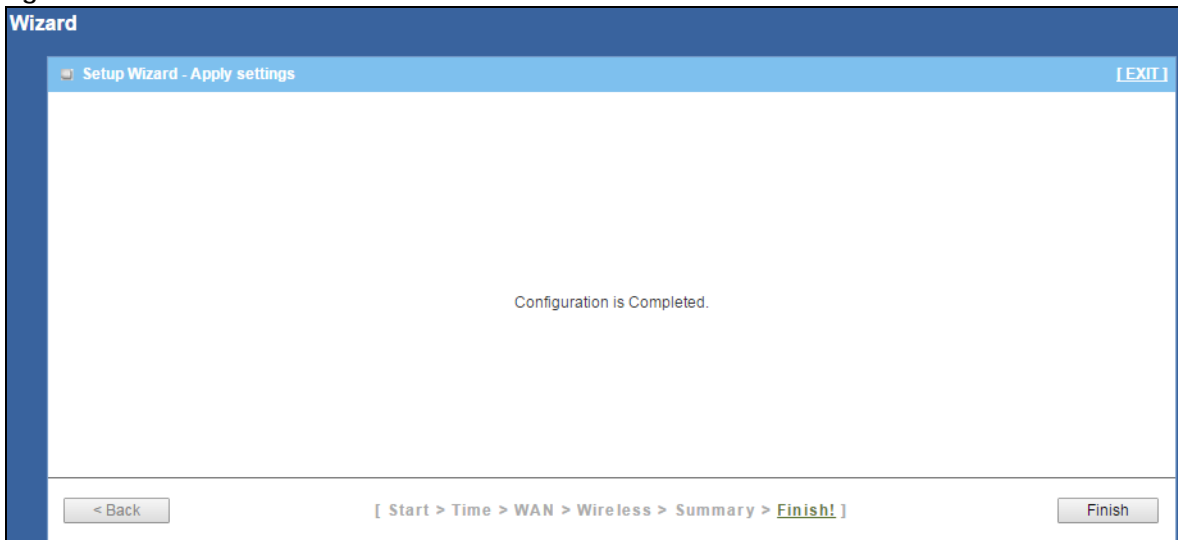

You are now ready to connect wirelessly to your LTE3301 and access the Internet.

CHAPTER 4

Tutorials

4.1 Overview

This chapter provides tutorials for setting up your LTE3301.

- [Set Up a Wireless Network Using WPS](#)
- [Connect to LTE3301 Wireless Network without WPS](#)
- [Using Multiple SSIDs on the LTE3301](#)

4.2 Set Up a Wireless Network Using WPS

This section gives you an example of how to set up wireless network using WPS. This example uses the LTE3301 as the AP and NWD210N as the wireless client which connects to a notebook.

Note: The wireless client must be a WPS-aware device (for example, a WPS USB adapter or PCI card).

There are two WPS methods for creating a secure connection via the web configurator or utility. This tutorial shows you how to do both.

- **Push Button Configuration (PBC)** - create a secure wireless network simply by pressing a button. See [Section 4.2.1 on page 30](#). This is the easier method.
- **PIN Configuration** - create a secure wireless network simply by entering a wireless client's PIN (Personal Identification Number) in the LTE3301's interface. See [Section 4.2.2 on page 31](#). This is the more secure method, since one device can authenticate the other.

4.2.1 Push Button Configuration (PBC)

- 1 Make sure that your LTE3301 is turned on. Make sure the **WIFI** button (at the back panel of the LTE3301) is pushed in, and that the device is placed within range of your notebook.
- 2 Make sure that you have installed the wireless client (this example uses the NWD210N) driver and utility in your notebook.
- 3 In the wireless client utility, find the WPS settings. Enable WPS and press the WPS button (**Start** or **WPS** button)
- 4 Log into LTE3301's Web Configurator and press the **Push Button** in the **Configuration > Network > Wireless LAN 2.4G > WPS Station** screen.

Note: Your LTE3301 has a WPS button located on its panel, as well as a WPS button in its configuration utility. Both buttons have exactly the same function; you can use one or the other.

Note: It doesn't matter which button is pressed first. You must press the second button within two minutes of pressing the first one.

The LTE3301 sends the proper configuration settings to the wireless client. This may take up to two minutes. Then the wireless client is able to communicate with the LTE3301 securely.

The following figure shows you an example to set up wireless network and security by pressing a button on both LTE3301 and wireless client (the NWD210N in this example).

Figure 18 Example WPS Process: PBC Method

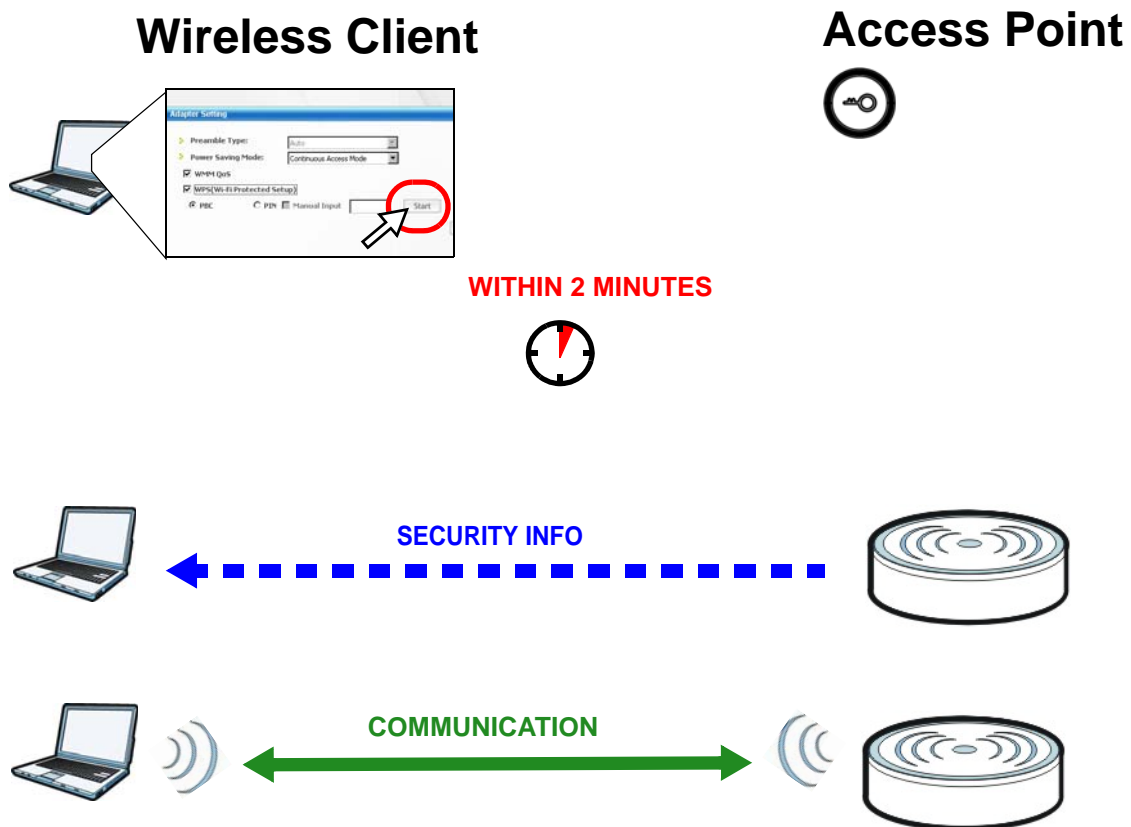

4.2.2 PIN Configuration

When you use the PIN configuration method, you need to use both LTE3301's configuration interface and the client's utilities.

- 1 Launch your wireless client's configuration utility. Go to the WPS settings and select the PIN method to get a PIN number.
- 2 Enter the PIN number to the **PIN** field in the **Configuration > Network > Wireless LAN > WPS Station** screen on the LTE3301.

- Click **Start** buttons (or button next to the PIN field) on both the wireless client utility screen and the LTE3301's **WPS Station** screen within two minutes.

The LTE3301 authenticates the wireless client and sends the proper configuration settings to the wireless client. This may take up to two minutes. Then the wireless client is able to communicate with the LTE3301 securely.

The following figure shows you the example to set up wireless network and security on LTE3301 and wireless client (ex. NWD210N in this example) by using PIN method.

Figure 19 Example WPS Process: PIN Method

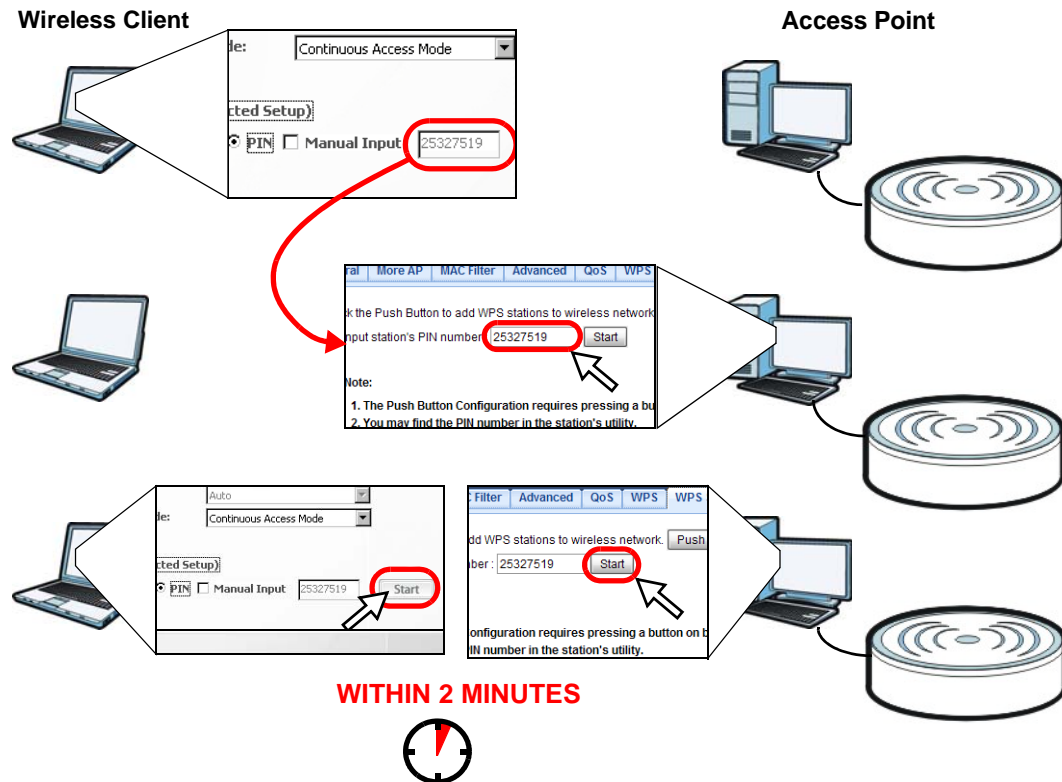

4.3 Connect to LTE3301 Wireless Network without WPS

This example shows you how to configure wireless security settings with the following parameters on your LTE3301 and connect your computer to the LTE3301 wireless network.

SSID	SSID_Example3
Channel	6
Security	WPA2-PSK (Pre-Shared Key: ThisismyWPA-PSKpre-sharedkey)

Follow the steps below to configure the wireless settings on your LTE3301.

The instructions require that your hardware is connected (see the Quick Start Guide) and you are logged into the Web Configurator through your LAN connection (see [Section 2.2 on page 16](#)).

- 1 Make sure the **WIFI** switch (at the back panel of the LTE3301) is set to **ON**.
- 2 Open the **Configuration > Network > Wireless LAN > General** screen in the AP's Web Configurator.
- 3 Confirm that the wireless LAN is enabled on the LTE3301.
- 4 Enter **SSID_Example3** as the SSID and select **Channel-06** as the channel. Set security mode to **WPA2-PSK** and enter **ThisismyWPA-PSKpre-sharedkey** in the **Pre-Shared Key** field. Click **Apply**.

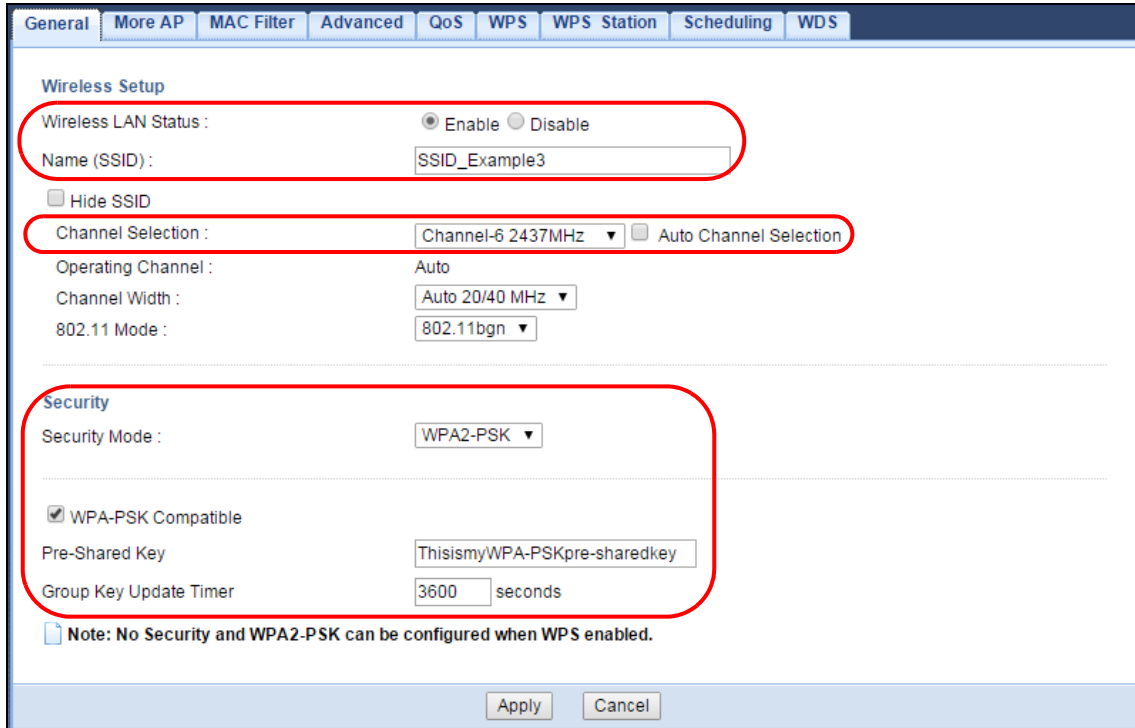

The screenshot displays the 'Wireless LAN > General' configuration page. The 'Wireless Setup' section includes:

- Wireless LAN Status:** Enable Disable
- Name (SSID):**
- Hide SSID
- Channel Selection:** Auto Channel Selection
- Operating Channel:** Auto
- Channel Width:**
- 802.11 Mode:**

The 'Security' section includes:

- Security Mode:**
- WPA-PSK Compatible
- Pre-Shared Key:**
- Group Key Update Timer:** seconds

A note at the bottom states: **Note: No Security and WPA2-PSK can be configured when WPS enabled.**

Buttons for **Apply** and **Cancel** are located at the bottom of the page.

- 5 Open the **Status** screen. Verify your wireless and wireless security settings under **Device Information** and check if the WLAN connection is up under **Interface Status**.

The screenshot displays the Status screen with the following sections:

- Device Information:**

Item	Data
Host Name:	LTE3301
Model Number:	LTE3301
Firmware Version:	V1.00(AAYE.0)C1
WAN Information	
- MAC Address:	90:EF:68:D3:A2:DC
- IP Address:	100.123.41.106
- IP Subnet Mask:	255.255.255.252
- Default Gateway:	100.123.41.105
- IPv6 Address:	
- Operation Band:	LTE 1800+
LAN Information:	
- MAC Address:	90:EF:68:D3:A2:DD
- IP Address:	192.168.1.1
- IP Subnet Mask:	255.255.255.0
- DHCP:	Server
- IPv6 Address:	
WLAN Information:	
- WLAN OP Mode:	Access Point Mode
- MAC Address:	90:EF:68:D3:A2:DD
- SSID:	ZyXEL_A2DD
- Channel:	4
- System:	B/G/N Mixed
- Security:	WPA2-PSK
Firewall:	Enable
- System Status:**

Item	Data
System Up Time:	0day 0hr 2min 12sec
Current Date/Time:	2012-12-31/16:03:18
System Resource:	
- CPU Usage:	13%
- Memory Usage:	63%
- Interface Status:**

Interface	Status	Rate
WAN	UP	150M
LAN 1	Down	
LAN 2	Down	
LAN 3	Down	
LAN 4	Down	
WLAN	UP	300M

Red circles highlight the WLAN OP Mode and SSID settings in the Device Information section, and the WLAN connection status in the Interface Status section.

4.3.1 Configure Your Notebook

Note: In this example, we use the ZyXEL NWD6505 wireless adapter as the wireless client and use the Windows built-in utility (Windows Zero Configuration (WZC)) to connect to the wireless network.

- 1 The LTE3301 supports IEEE 802.11b, IEEE 802.11g, and IEEE 802.11n wireless clients. Make sure that your notebook or computer's wireless adapter supports one of these standards.
- 2 Wireless adapters come with software sometimes called a "utility" that you install on your computer. See your wireless adapter's User's Guide for information on how to do that.

- After you've installed the driver and attached the NWD6505 to your computer's USB port, right-click the **Wireless Network Connection** icon in your computer's system tray, select and click **View Available Wireless Networks**.



- The **Wireless Network Connection** screen displays. Click **Refresh network list** to view the available wireless APs within range.
- Select **SSID_Example3** and click **Connect**.

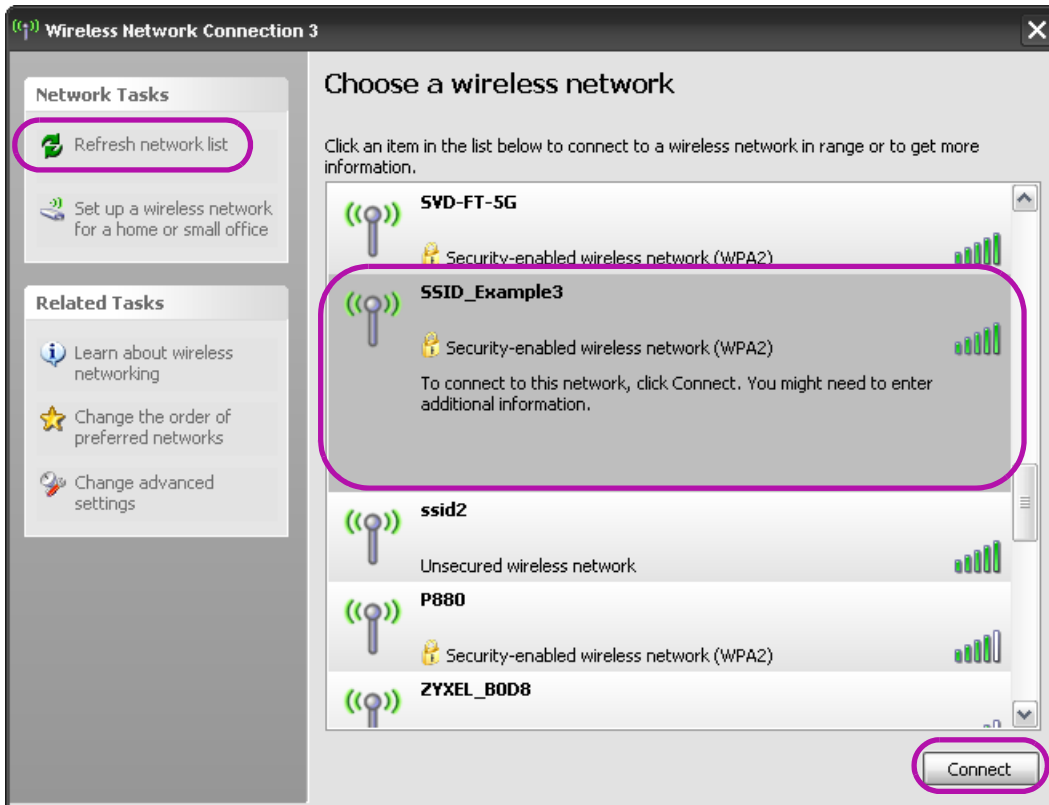

- Type the security key in the following screen. Click **Connect**.

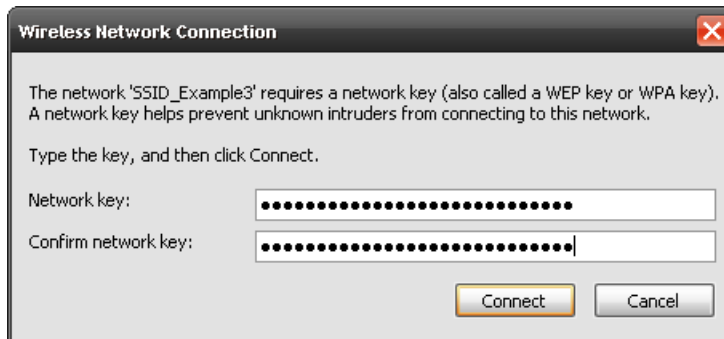

- 7 Check the status of your wireless connection in the screen below.

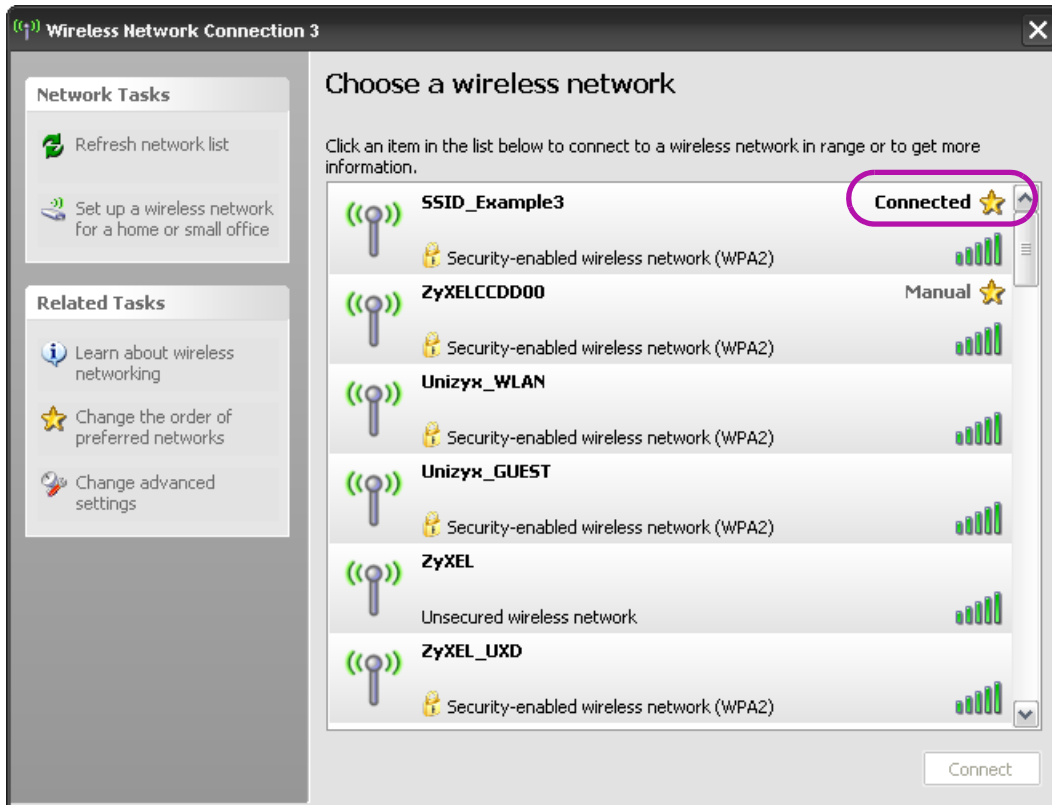

- 8 If the wireless client keeps trying to connect to or acquiring an IP address from the LTE3301, make sure you entered the correct security key.

If the connection has limited or no connectivity, make sure the DHCP server is enabled on the LTE3301.

If your connection is successful, open your Internet browser and enter <http://www.zyxel.com> or the URL of any other web site in the address bar. If you are able to access the web site, your wireless connection is successfully configured.

4.4 Using Multiple SSIDs on the LTE3301

You can configure more than one SSID on a LTE3301. See [Section 7.4 on page 70](#).

This allows you to configure multiple independent wireless networks on the LTE3301 as if there were multiple APs (virtual APs). Each virtual AP has its own SSID, and wireless security type. That is, each SSID on the LTE3301 represents a different access point/wireless network to wireless clients in the network.

Clients can associate only with the SSIDs for which they have the correct security settings. Clients using different SSIDs can access the Internet and the wired network behind the LTE3301 (such as a printer).

For example, you may set up three wireless networks (A, B and C) in your office. A is for workers, B is for guests and C is specific to a VoIP device in the meeting room.

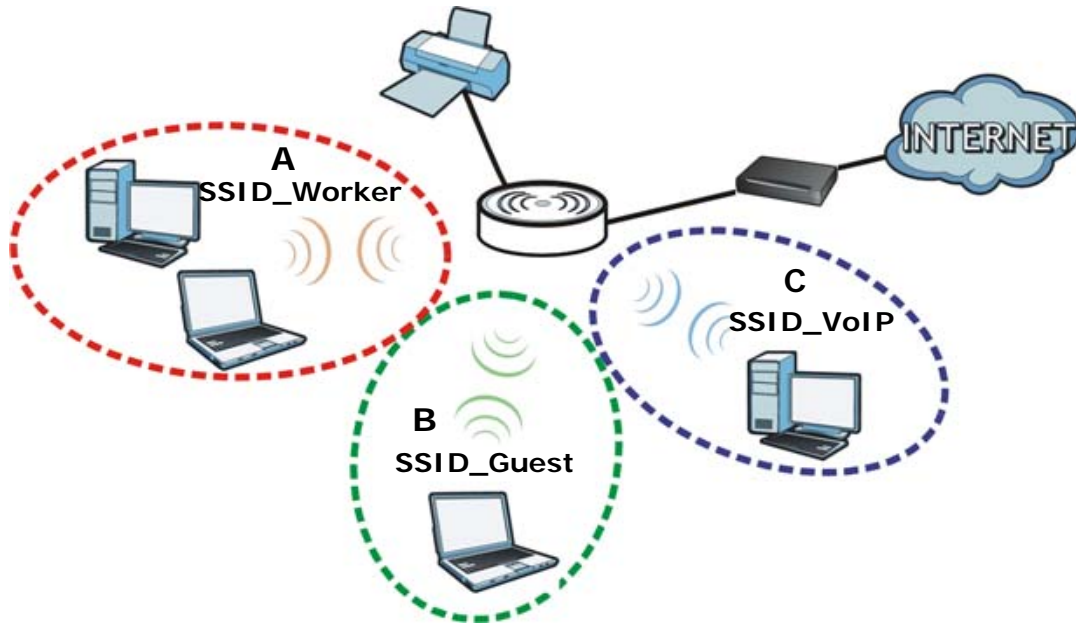

4.4.1 Configuring Security Settings of Multiple SSIDs

The LTE3301 is in router mode by default.

This example shows you how to configure the SSIDs with the following parameters on your LTE3301 .

SSID	SECURITY TYPE	KEY
SSID_Worker	WPA2-PSK WPA Compatible	DoNotStealMyWirelessNetwork
SSID_VoIP	WPA-PSK	VoIPOnly12345678
SSID_Guest	WPA-PSK	keyexample123

- 1 Connect your computer to the LAN port of the LTE3301 using an Ethernet cable.
- 2 The default IP address of the LTE3301 is "192.168.1.1". In this case, your computer must have an IP address in the range between "192.168.1.2" and "192.168.1.254".
- 3 Click **Start > Run** on your computer in Windows. Type "cmd" in the dialog box. Enter "ipconfig" to show your computer's IP address. If your computer's IP address is not in the correct range then see [Appendix B on page 147](#) for information on changing your computer's IP address.
- 4 After you've set your computer's IP address, open a web browser such as Internet Explorer and type "http://192.168.1.1" as the web address in your web browser.
- 5 Enter "admin" as the user name and "1234" (default) as the password and click **Login**.
- 6 Type a new password and retype it to confirm, then click **Apply**. Otherwise, click **Ignore**.

- 7 Go to **Configuration > Network > Wireless LAN > More AP**. Click the **Edit** icon of the first entry to configure wireless and security settings for **SSID_Worker**.

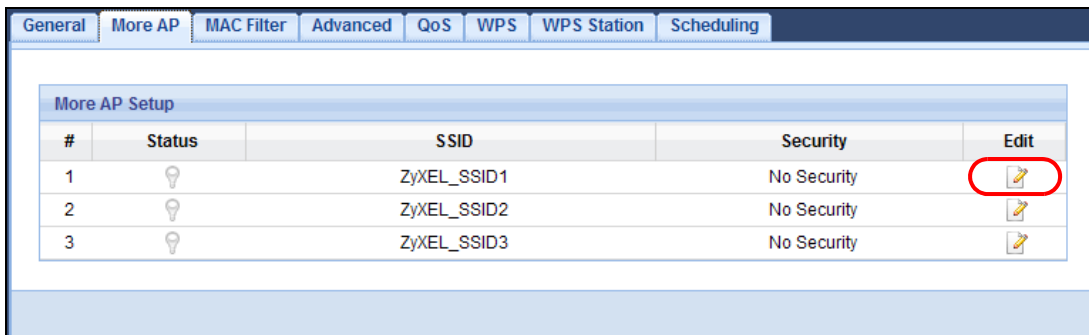

- 8 Configure the screen as follows. In this example, you enable **Intra-BSS Traffic** for **SSID_Worker** to allow wireless clients in the same wireless network to communicate with each other. Click **Apply**.

Wireless Setup

Active :

Name (SSID) :

Hide SSID

Intra-BSS Traffic

WMM QoS

Security

Security Mode :

WPA-PSK Compatible

Pre-Shared Key :

Group Key Update Timer : seconds

No Security and WPA2-PSK can be configured when WPS enabled.

- 9 Click the **Edit** icon of the second entry to configure wireless and security settings for **SSID_VoIP**.

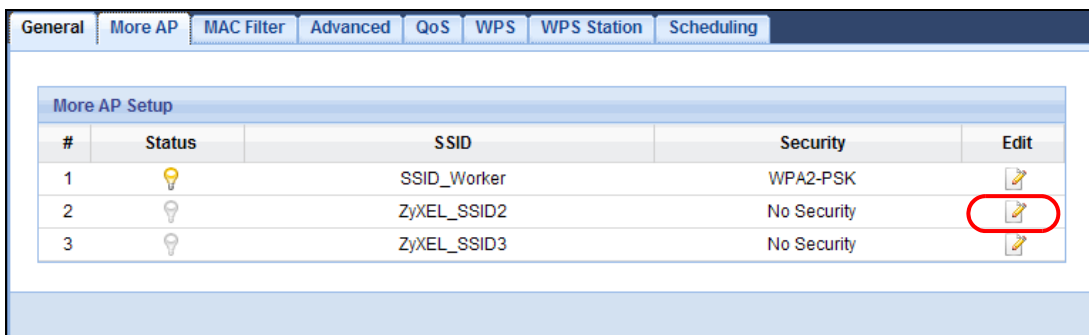

- 10 Configure the screen as follows. You do not enable **Intra-BSS Traffic** for **SSID_VoIP**. Click **Apply**.

Wireless Setup

Active :

Name (SSID) :

Hide SSID

Intra-BSS Traffic

WMM QoS

Security

Security Mode :

Pre-Shared Key

Group Key Update Timer seconds

No Security and WPA2-PSK can be configured when WPS enabled.

- 11 Click the **Edit** icon of the third entry to configure wireless and security settings for **SSID_Guest**.

General More AP MAC Filter Advanced QoS WPS WPS Station Scheduling

More AP Setup

#	Status	SSID	Security	Edit
1		SSID_Worker	WPA2-PSK	
2		SSID_VoIP	WPA-PSK	
3		ZyXEL_SSID3	No Security	

- 12 Configure the screen as follows. In this example, you enable **Intra-BSS Traffic** for **SSID_Guest** to allow wireless clients in the same wireless network to communicate with each other. Click **Apply**.

Wireless Setup

Active :

Name (SSID) :

Hide SSID

Intra-BSS Traffic

WMM QoS

Enable Guest WLAN

IP Address :

IP Subnet Mask :

Enable Bandwidth Management for Guest WLAN

Maximum Bandwidth (kbps)

Security

Security Mode :

Pre-Shared Key

Group Key Update Timer seconds

 No Security and WPA2-PSK can be configured when WPS enabled.

PART II

Technical Reference

CHAPTER 5

Monitor

5.1 Overview

This chapter discusses read-only information related to the device state of the LTE3301.

To access the Monitor screens, click  after login.

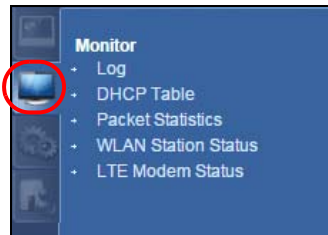

You can also click the links in the **Summary** table of the **Status** screen to view the packets sent/received as well as the status of wireless clients connected to the LTE3301.

5.2 What You Can Do

- Use the **Log** screen to see the logs for the activity on the LTE3301 ([Section 5.3 on page 42](#)).
- Use the **DHCP Table** screen to view information related to your DHCP status ([Section 5.4 on page 43](#)).
- use the **Packet Statistics** screen to view port status, packet specific statistics, the "system up time" and so on ([Section 5.5 on page 44](#)).
- Use the **WLAN Station Status** screen to view the wireless stations that are currently associated to the LTE3301 ([Section 5.6 on page 45](#)).
- Use the **LTE Modem Status** screen to view the detailed information about the LTE module, cellular interface, and SIM card. You can also check the LTE connection status ([Section 5.7 on page 46](#)).

5.3 The Log Screen

The Web Configurator allows you to look at all of the LTE3301's logs in one location.

5.3.1 View Log

Use the **View Log** screen to see the logged messages for the LTE3301. The log wraps around and deletes the old entries after it fills. Select what logs you want to see in the **Log Setting** screen. Click **Refresh** to renew the log screen. Click **Clear Log** to delete all the logs.

Figure 20 View Log

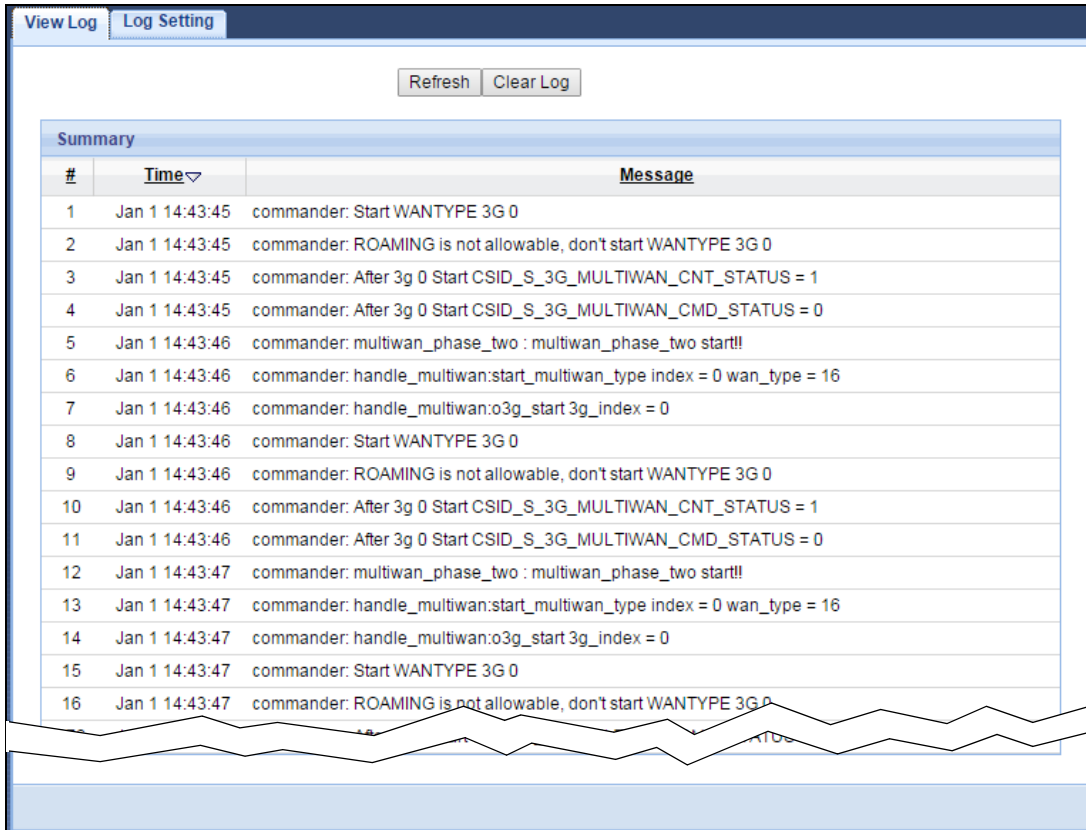

You can configure which logs to display in the **View Log** screen. Go to the **Log Setting** screen and select the logs you wish to display. Click **Apply** to save your settings. Click **Cancel** to start the screen afresh.

Figure 21 Log Settings

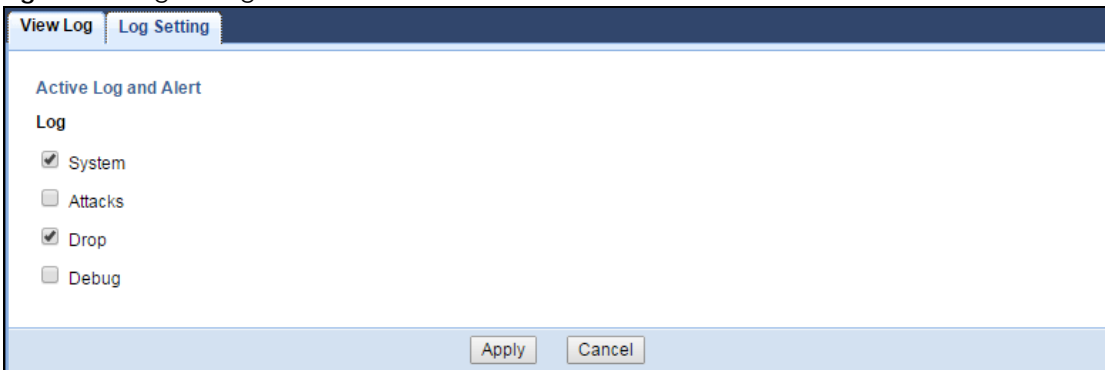

5.4 DHCP Table

DHCP (Dynamic Host Configuration Protocol, RFC 2131 and RFC 2132) allows individual clients to obtain TCP/IP configuration at start-up from a server. You can configure the LTE3301's LAN as a DHCP server or disable it. When configured as a server, the LTE3301 provides the TCP/IP configuration for the clients. If DHCP service is disabled, you must have another DHCP server on that network, or else the computer must be manually configured.

Click **Monitor > DHCP Table** or **Configuration > Network > DHCP Server > Client List**. Read-only information here relates to your DHCP status. The DHCP table shows current DHCP client information (including **MAC Address**, and **IP Address**) of all network clients using the LTE3301's DHCP server.

Figure 22 Monitor > DHCP Table

DHCP Table					
#	Status	Host Name	IP Address	MAC Address	Reserve
1		twpc	192.168.1.46	00:21:85:0c:44:4b	<input type="checkbox"/>

The following table describes the labels in this screen.

Table 9 Monitor > DHCP Table

LABEL	DESCRIPTION
#	This is the index number of the host computer.
Status	This field displays whether the connection to the host computer is up (a yellow bulb) or down (a gray bulb).
Host Name	This field displays the computer host name.
IP Address	This field displays the IP address relative to the # field listed above.
MAC Address	This field shows the MAC address of the computer with the name in the Host Name field. Every Ethernet device has a unique MAC (Media Access Control) address which uniquely identifies a device. The MAC address is assigned at the factory and consists of six pairs of hexadecimal characters, for example, 00:A0:C5:00:00:02.
Reserve	Select this if you want to reserve the IP address for this specific MAC address.
Apply	Click Apply to save your changes back to the LTE3301.
Cancel	Click Cancel to reload the previous configuration for this screen.

5.5 Packet Statistics

Click **Monitor > Packet Statistics** or the **Packet Statistics (Details...)** hyperlink in the **Status** screen. Read-only information here includes port status, packet specific statistics and the "system up time". The **Poll Interval(s)** field is configurable and is used for refreshing the screen.

Figure 23 Monitor > Packet Statistics

Port	Status	TxPkts	RxPkts	Collisions	Tx B/s	Rx B/s	Up Time
WAN	Down	0	0	N/A	N/A	N/A	23:3:21
LAN	Down	15406	67359	0	0	0	23:3:21
WLAN	300M	25641	27635	0	27	0	23:3:21

System Up Time : 23:3:21

Poll Interval(s) :

The following table describes the labels in this screen.

Table 10 Monitor > Packet Statistics

LABEL	DESCRIPTION
Port	This is the LTE3301's interface type.
Status	For the LAN ports, this displays the port speed and duplex setting or Down when the line is disconnected. For the WAN port, it displays Up when the mobile data connection is up, Connecting when the LTE3301 is trying to bring the mobile data connection up, and displays Down when the 3G/4G connection is down or not activated. For the WLAN, it displays the maximum transmission rate when the WLAN is enabled and Down when the WLAN is disabled.
TxPkts	This is the number of transmitted packets on this port.
RxPkts	This is the number of received packets on this port.
Collisions	This is the number of collisions on this port.
Tx B/s	This displays the transmission speed in bytes per second on this port.
Rx B/s	This displays the reception speed in bytes per second on this port.
Up Time	This is the total time the LTE3301 has been for each session.
System Up Time	This is the total time the LTE3301 has been on.
Poll Interval(s)	Enter the time interval in seconds for refreshing statistics in this field.
Set Interval	Click this button to apply the new poll interval you entered in the Poll Interval(s) field.
Stop	Click Stop to stop refreshing statistics.

5.6 WLAN Station Status

Click **Monitor > WLAN Station Status** or the **WLAN Station Status (Details...)** hyperlink in the **Status** screen. View the wireless stations that are currently associated to the LTE3301's 2.4GHz wireless network in the **Association List**. Association means that a wireless client (for example, your network or computer with a wireless network card) has connected successfully to the AP (or wireless router) using the same SSID, channel and security settings.

Figure 24 Monitor > WLAN Station Status

Association List		
#	MAC Address	Association Time
1	00:19:CB:32:BE:AC	11:36:18 2013/1/1

The following table describes the labels in this screen.

Table 11 Monitor > WLAN Station Status

LABEL	DESCRIPTION
#	This is the index number of an associated wireless station.
MAC Address	This field displays the MAC address of an associated wireless station.
Association Time	This field displays the time a wireless station first associated with the LTE3301's WLAN.

5.7 LTE Modem Status

Click **Monitor > LTE Modem Status** or the **LTE Modem Status (Details...)** hyperlink in the **Status** screen. Use this screen to view the detailed information about the LTE module, cellular interface, and SIM card. You can also check the LTE connection status.

Figure 25 Monitor > LTE Modem Status

Modem Information									
Physical Interface	Module Name	IMEI/MEID	HW Version	FW Version					
3G1	D18QC	351685060152082	20002	D18QC_v01.00.150631T 1 [Feb 10 2015 17:30:00]					
SIM Status									
SIM	PIN Code Status	PIN Code Remaining Times			PUK Code Remaining Times				
N/A	SIM card not insert	0			0				
Service Information									
Operator	Cell Broadcast	MCC	MNC	LAC	TAC	Physical Cell ID	Service Type	Operation Band	RSSI
N/A	N/A	N/A	N/A	10353	N/A	23198144	NONE	N/A	N/A
CS Register Status	Eclo	PS Register Status	PS Attached Status	Roaming Status	IMSI	SMSC	MSISDN		
Unregistered	-	Unregistered	Detached	Roaming	N/A	N/A	N/A		
RSRP	RSRQ	SINR	PLMN	MIMO	Support Band List				
N/A	N/A	N/A	N/A	1T2R	N/A				

The following table describes the labels in this screen.

Table 12 Monitor > LTE Modem Status

LABEL	DESCRIPTION
Modem Information	
Physical Interface	This displays the interface used for the mobile data connection.

Table 12 Monitor > LTE Modem Status (continued)

LABEL	DESCRIPTION
Module Name	This displays the name of the built-in LTE module.
IMEI/MEID	This displays the International Mobile Equipment Number (IMEI) or Mobile Equipment Identifier (MEID), which is the serial number of the built-in LTE module. It is a unique 15-digit number used to identify a mobile device.
HW Version	This displays the hardware version of the built-in LTE module.
FW Version	This displays the firmware version of the built-in LTE module.
SIM Status	
SIM	This displays the status of the inserted SIM card. N/A displays if there is no SIM card inserted.
PIN Code Status	This displays the status of PIN code authentication.
PIN Code Remaining Times	This displays how many times you can enter the PIN code.
PUK Code Remaining Times	This displays how many times you can enter the PUK code.
Service Information	
Operator	This displays the name of the service provider.
Cell Broadcast	This displays whether the one-to-many messaging service is available.
MCC	This displays the Mobile Country Code (MCC), which is used to identify the country of a mobile subscriber.
MNC	This displays the Mobile Network Code (MNC), which is used in combination with MCC to identify the public land mobile network (PLMN) of a mobile subscriber.
LAC	This displays the 2-octet Location Area Code (LAC), which is used to identify a location area within a PLMN.
TAC	This displays the Tracking Area Code (TAC), which is to identify a tracking area within a PLMN.
Physical Cell ID	This displays the ID of a cell at the physical layer.
Service Type	This displays the type of the mobile network to which the LTE3301 is connecting.
Operation Band	This displays the network type and the frequency band used by the mobile network to which the LTE3301 is connecting.
RSSI	This displays the received signal strength indicator (RSSI), that is, the received signal strength in dBm.
CS Register Status	This displays the Circuit Switched network registration status.
Eclo	This displays the ratio (in dB) of the received energy per chip and the interference level.
PS Register Status	This displays the packet switched network registration status.
PS Attached Status	This displays the Packet switched Domain Attachment status.
Roaming Status	This displays whether the LTE3301 is connected to another service provider's mobile network using roaming.
IMSI	This displays the International Mobile Subscriber Identity (IMSI) stored in the SIM (Subscriber Identity Module) card. The SIM card is installed in a mobile device and used for authenticating a customer to the carrier network. IMSI is a unique 15-digit number used to identify a user on a network.
SMSC	This displays the number for Short Message Service Center (SMSC), which stores, forwards and delivers SMS text message.
MSISDN	This displays the MSISDN (Mobile Subscriber ISDN) number, a phone number assigned to a mobile subscriber to call a mobile device.
RSRP	This displays the Reference Signal Receive Power (RSRP), which is the average received power of all Resource Elements (RE) that carry cell-specific Reference Signals (RS) within the specified bandwidth.

Table 12 Monitor > LTE Modem Status (continued)

LABEL	DESCRIPTION
RSRQ	This displays the Reference Signal Received Quality (RSRQ), which is the ratio of RSRP to the E-UTRA carrier RSSI and indicates the quality of the received reference signal.
SINR	This displays the Signal to Interference plus Noise Ratio (SINR). A negative value means more noise than signal.
PLMN	This displays the Public Land Mobile Network (PLMN) code of the mobile network.
MIMO	This displays the MIMO (Multi-input Multi-output) technology supported by the LTE3301, such as 1T2R (1 Transmit and 2 Receive paths/antennas) or TM1-TM4 (Transmission Mode 4).
Support Band List	This displays the frequency bands that are supported by the LTE3301.

CHAPTER 6

WAN

6.1 Overview

This chapter discusses the LTE3301's **WAN** screens. Use these screens to configure your LTE3301 for Internet access.

A WAN (Wide Area Network) connection is an outside connection to another network or the Internet. It connects your private networks such as a LAN (Local Area Network) and other networks, so that a computer in one location can communicate with computers in other locations.

3G and 4G standards for the sending and receiving of voice, video, and data in a mobile environment. You can insert a 4G SIM card and set the LTE3301 to use this 3G/4G connection as your WAN.

Figure 26 LAN/Wireless LAN and Wireless WAN

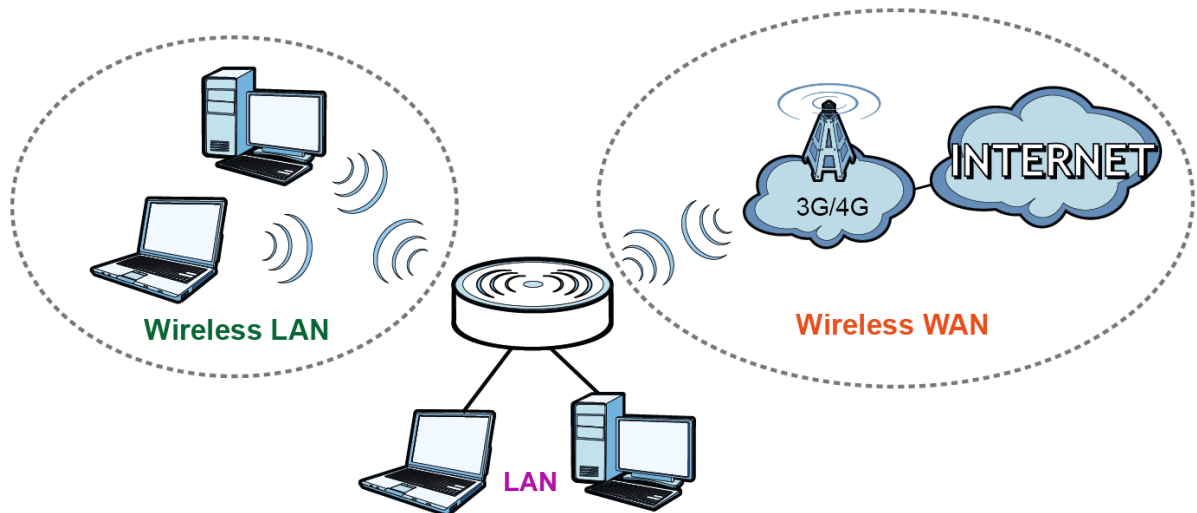

6.2 What You Can Do

- Use the **Management WAN** screen to configure 3G/4G WAN connection settings ([Section 6.4 on page 52](#)).
- Use the **Network Scan** screen to specify the type of the mobile network to which the LTE3301 is connected and how you want the LTE3301 to connect to an available mobile network ([Section 6.5 on page 56](#)).
- Use the **IPv6** screen to configure the LTE3301's IPv6 settings ([Section 6.6 on page 57](#)).

6.3 What You Need To Know

The information in this section can help you configure the screens for your WAN connection, as well as enable/disable some advanced features of your LTE3301.

3G

3G (Third Generation) is a digital, packet-switched wireless technology. Bandwidth usage is optimized as multiple users share the same channel and bandwidth is only allocated to users when they send data. It allows fast transfer of voice and non-voice data and provides broadband Internet access to mobile devices.

4G

4G is the fourth generation of the mobile telecommunications technology and a successor of 3G. Both the WiMAX and Long Term Evolution (LTE) standards are the 4G candidate systems. 4G only supports all-IP-based packet-switched telephony services and is required to offer gigabit speed access.

DNS Server Address Assignment

Use Domain Name System (DNS) to map a domain name to its corresponding IP address and vice versa, for instance, the IP address of `www.zyxel.com` is `204.217.0.2`. The DNS server is extremely important because without it, you must know the IP address of a computer before you can access it.

The LTE3301 can get the DNS server addresses in the following ways.

- 1 The ISP tells you the DNS server addresses, usually in the form of an information sheet, when you sign up. If your ISP gives you DNS server addresses, manually enter them in the DNS server fields.
- 2 If your ISP dynamically assigns the DNS server IP addresses (along with the LTE3301's WAN IP address), set the DNS server fields to get the DNS server address from the ISP.

Multicast

Traditionally, IP packets are transmitted in one of either two ways - Unicast (1 sender - 1 recipient) or Broadcast (1 sender - everybody on the network). Multicast delivers IP packets to a group of hosts on the network - not everybody and not just 1.

Figure 27 Multicast Example

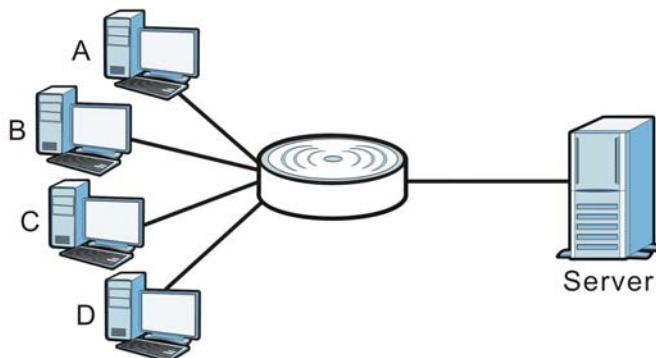

In the multicast example above, systems **A** and **D** comprise one multicast group. In multicasting, the server only needs to send one data stream and this is delivered to systems **A** and **D**.

IGMP (Internet Group Multicast Protocol) is a network-layer protocol used to establish membership in a multicast group - it is not used to carry user data. The LTE3301 supports both IGMP version 1 (**IGMP v1**), IGMP version 2 (**IGMP v2**) and IGMP version 3 (**IGMP v3**).

At start up, the LTE3301 queries all directly connected networks to gather group membership. After that, the LTE3301 periodically updates this information. IP multicasting can be enabled/disabled on the LTE3301 WAN interface in the Web Configurator.

IPv6 Introduction

IPv6 (Internet Protocol version 6), is designed to enhance IP address size and features. The increase in IPv6 address size to 128 bits (from the 32-bit IPv4 address) allows up to 3.4×10^{38} IP addresses. The LTE3301 can use IPv4/IPv6 dual stack to connect to IPv4 and IPv6 networks, and supports IPv6 rapid deployment (6RD).

IPv6 Addressing

The 128-bit IPv6 address is written as eight 16-bit hexadecimal blocks separated by colons (:). This is an example IPv6 address 2001:0db8:1a2b:0015:0000:0000:1a2f:0000.

IPv6 addresses can be abbreviated in two ways:

- Leading zeros in a block can be omitted. So 2001:0db8:1a2b:0015:0000:0000:1a2f:0000 can be written as 2001:db8:1a2b:15:0:0:1a2f:0.
- Any number of consecutive blocks of zeros can be replaced by a double colon. A double colon can only appear once in an IPv6 address. So 2001:0db8:0000:0000:1a2f:0000:0000:0015 can be written as 2001:0db8::1a2f:0000:0000:0015, 2001:0db8:0000:0000:1a2f::0015, 2001:db8::1a2f:0:0:15 or 2001:db8:0:0:1a2f::15.

IPv6 Prefix and Prefix Length

Similar to an IPv4 subnet mask, IPv6 uses an address prefix to represent the network address. An IPv6 prefix length specifies how many most significant bits (start from the left) in the address compose the network address. The prefix length is written as "/x" where x is a number. For example,

```
2001:db8:1a2b:15::1a2f:0/32
```

means that the first 32 bits (2001:db8) is the subnet prefix.

IPv6 Subnet Masking

Both an IPv6 address and IPv6 subnet mask compose of 128-bit binary digits, which are divided into eight 16-bit blocks and written in hexadecimal notation. Hexadecimal uses four bits for each character (1 ~ 10, A ~ F). Each block's 16 bits are then represented by four hexadecimal characters. For example, FFFF:FFFF:FFFF:FFFF:FC00:0000:0000:0000.

IPv6 Rapid Deployment

Use IPv6 Rapid Deployment (6rd) when the local network uses IPv6 and the ISP has an IPv4 network. When the LTE3301 has an IPv4 WAN address, you can enable 6rd to encapsulate IPv6 packets in IPv4 packets to cross the ISP's IPv4 network.

The LTE3301 generates a global IPv6 prefix from its IPv4 WAN address and tunnels IPv6 traffic to the ISP's Border Relay router (BR in the figure) to connect to the native IPv6 Internet. The local network can also use IPv4 services. The LTE3301 uses its configured IPv4 WAN IP to route IPv4 traffic to the IPv4 Internet.

Figure 28 IPv6 Rapid Deployment

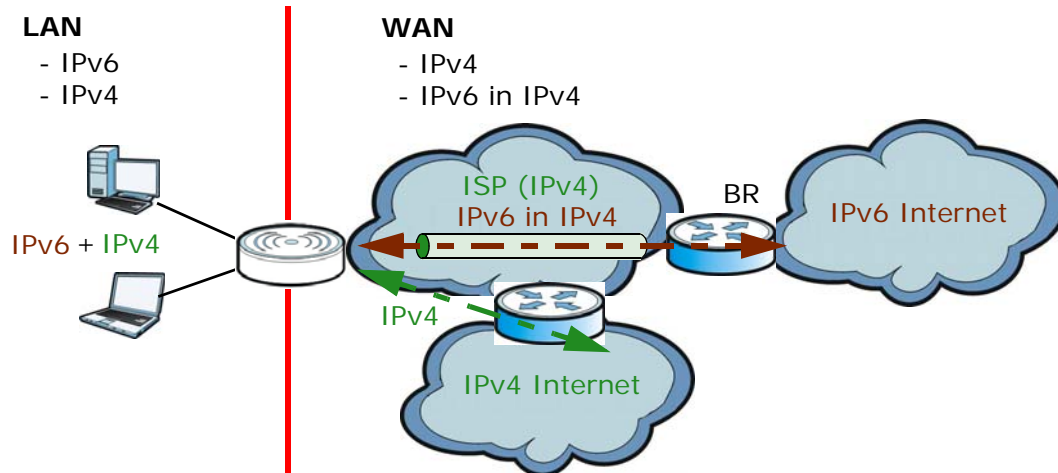

6.4 Management WAN

The summary table shows you the WAN connection configured on the LTE3301. Click **Network > WAN > Management WAN** from the **Configuration** menu.

Figure 29 Network > WAN > Management WAN

Management WAN				
Management WAN Entries				
Interface	Type	IP Address	Status	Modify
WAN 1	3G/4G	IPv4: 0.0.0.0 IPv6:	IPv4 Disconnected IPv6 Disconnected	

The following table describes the labels in this screen.

Table 13 Network > WAN > Management WAN

LABEL	DESCRIPTION
Interface	This field displays the name of the WAN interface for this connection.
Type	This field displays the type of the WAN connection.
IP Address	This field displays the IPv4 and IPv6 addresses of the WAN connection.

Table 13 Network > WAN > Management WAN (continued)

LABEL	DESCRIPTION
Status	This field indicates whether the IPv4 and IPv6 connectivity is available.
Modify	Click the Edit icon to configure the WAN connection settings.

6.4.1 Management WAN Edit

Use this screen to change your LTE3301's 3G/4G WAN connection settings. Click the Edit icon in the **Network > WAN > Management WAN** screen.

Figure 30 Network > WAN > Management WAN Edit

Management WAN | Network Scan | IPv6

ISP Parameters for Internet Access

Encapsulation : 3G/4G ▼

3G/4G Information

Dial-Up Profile : Auto-Detection Manual

Country : Taiwan ▼

Service Provider : Chunghwa Telecom ▼

APN : internet (optional)

PIN Code : (optional)

Dialed Number : *99#

Account : (optional)

Password : (optional)

Authentication : Auto ▼

Primary DNS : (optional)

Secondary DNS : (optional)

Roaming : Enable

Connection Control : Connect-on-Demand ▼

Maximum Idle Time : 600 seconds

MTU : 0 (0 is auto)

NAT : Enable

Network Monitoring : Enable

DNS Query ICMP Checking

Loading Check

Check Interval : 3 (seconds)

Check Timeout : 3 (seconds)

Latency Threshold : 3000 (ms)

Fail Threshold : 10 (Times)

Target1 : DNS1 ▼

Target2 : None ▼

Bridge : Enable

IGMP : Auto ▼

IGMP Proxy : Enable

Apply Cancel

The following table describes the labels in this screen.

Table 14 Network > WAN > Management WAN Edit

LABEL	DESCRIPTION
ISP Parameters for Internet Access	
Encapsulation	This shows the WAN connection type.
3G/4G Information	
Dial-Up Profile	<p>Select Auto-Detection to have the LTE3301 use the inserted SIM card's default settings to connect to any available mobile network.</p> <p>Select Manual and enter the information provided by your service provider to connect to the service provider's mobile network.</p>
Country	Select the country in which you use the LTE3301.
Service Provider	<p>Select the name of your service provider. The options vary depending on the country you selected.</p> <p>If your service provider is not in the list, select Others.</p>
APN	<p>Connections with different APNs (Access Point Names) may provide different services (such as Internet access or MMS (Multi-Media Messaging Service)) and charge method.</p> <p>The corresponding APN automatically displays when you select a pre-defined service provider.</p> <p>If you select Others in the Service Provider field, manually enter the APN provided by your service provider. You can enter up to 32 ASCII printable characters. Spaces are allowed.</p>
PIN Code	<p>A PIN (Personal Identification Number) code is a key to a SIM card. Without the PIN code, you cannot use the SIM card.</p> <p>If your service provider enabled PIN code authentication, enter the 4-digit PIN code (0000 for example) provided by your service provider. If you enter the PIN code incorrectly, the SIM card may be blocked by your service provider and you cannot use the account to access the Internet.</p> <p>If your service provider disabled PIN code authentication, leave this field blank.</p>
Dialed Number	<p>This is the phone number (dial string) used to dial up a connection to your service provider's base station. Your service provider should provide the phone number. For example, *99# is the dial string to establish a GPRS or 3G/4G connection in Taiwan.</p> <p>The corresponding phone number automatically displays when you select a pre-defined service provider.</p> <p>If you select Others in the Service Provider field, manually enter the phone number provided by your service provider.</p>
Account	Type the user name (of up to 64 ASCII printable characters) given to you by your service provider.
Password	Type the password (of up to 64 ASCII printable characters) associated with the user name above.
Authentication	<p>The LTE3301 supports PAP (Password Authentication Protocol) and CHAP (Challenge Handshake Authentication Protocol). CHAP is more secure than PAP; however, PAP is readily available on more platforms</p> <p>Select an authentication protocol (PAP, or CHAP) used by the service provider. Otherwise, select Auto to have the LTE3301 accept either CHAP or PAP.</p>
Primary DNS	Enter the first DNS server address assigned by the service provider.
Secondary DNS	Enter the second DNS server address assigned by the service provider.
Roaming	3G/4G roaming is to use your mobile device in an area which is not covered by your service provider. Enable roaming to ensure that your LTE3301 is kept connected to the Internet when you are traveling outside the geographical coverage area of the network to which you are registered.

Table 14 Network > WAN > Management WAN Edit (continued)

LABEL	DESCRIPTION
Connection Control	Select Auto Reconnect (always-on) if you do not want the connection to time out. Select Connect-on-Demand if you do not want the connection up all the time and specify an idle time-out in the Maximum Idle Time field.
Maximum Idle Time	Specify the time in minutes that elapses before the LTE3301 automatically disconnects from the service provider.
MTU	Enter the MTU (Maximum Transmission Unit) of each data packet, in bytes, that can move through the WAN connection.
NAT	Select this option to turn on Network Address Translation (NAT) for this connection.
Network Monitoring	Select this option to have the LTE3301 test the WAN connection by periodically sending DNS Query to a DNS server or sending a ping (ICMP Checking) to either the default gateway or the addresses you specify in the Target1 and Target2 fields.
Loading Check	Select this option to check how many packets have been transmitted or received through the WAN connection within a time period specified in the Check Interval field.
Check Interval	Type a number of seconds (0 to 99999) to set the time interval between checks. Allow more time if your destination IP address handles lots of traffic.
Check Timeout	Type the number of seconds (0 to 99999) for your LTE3301 to wait for a response to the ping or DNS query before considering the check to have failed. This setting must be less than the Check Interval . Use a higher value in this field if your network is busy or congested.
Latency Threshold	Type a number of milliseconds (0 to 99999) for the latency threshold. If the specified latency threshold is exceeded, the LTE3301 considers the check to have failed and makes a new connection after (Latency Threshold * Fail Threshold) seconds.
Fail Threshold	Type how many WAN connection checks can fail (0 to 99999) before the connection is considered "down" (not connected). The LTE3301 still checks a "down" connection to detect if it reconnects.
Target1/Target2	Select DNS1 to have the LTE3301 send a DNS query to the first DNS server address assigned by the service provider. Select DNS2 to have the LTE3301 send a DNS query to the second DNS server address assigned by the service provider. Select Gateway to have the LTE3301 ping the WAN interface's default gateway IP address. Select Other Host and enter a domain name or IP address of a reliable nearby computer to have the LTE3301 ping that address.
Bridge	Select this option to allow the computer connected to the first Ethernet LAN port to get an individual IP address from the ISP's DHCP server directly.
IGMP	Select IGMP v1 , IGMP v2 , IGMP v3 or Auto to enable multicasting. This applies to traffic routed from the WAN to the LAN. Select Disable to turn off this feature. This may cause incoming traffic to be dropped or sent to all connected network devices.
IGMP Proxy	This field is available only when IGMP is enabled. Select this option to have the LTE3301 act as an IGMP proxy on this connection. This allows the LTE3301 to get subscribing information and maintain a joined member list for each multicast group. It can reduce multicast traffic significantly.

6.5 Network Scan

Use this screen to set how you want the LTE3301 to connect to an available mobile network. Click **Network > WAN > Network Scan** from the **Configuration** menu.

Figure 31 Network > WAN > Network Scan

Provider Name	Mobile System	Network Status	Action
TWM	3G	Available	<input type="checkbox"/> Select
Chunghwa	3G	Available	<input type="checkbox"/> Select

The following table describes the labels in this screen.

Table 15 Network > WAN > Network Scan

LABEL	DESCRIPTION
Physical Interface	This shows the type of the interface used by the WAN connection.
Network Type	Select the type of the network (4G only , 3G only , or 3G/4G) to which you want the LTE3301 to connect when there is a SIM card inserted.
Scan Approach	Select Auto to have the LTE3301 connect to an available network using the default settings on the SIM card. If the currently registered mobile network is not available or the mobile network's signal strength is too low, the LTE3301 switches to another available mobile network. Select Manually to search for and select the mobile network(s) to which you want the LTE3301 to connect.
Network Provider List	This table is available only when you set Scan Approach to Manually . Click Scan to search for available mobile networks based on the network type you selected. Click Apply to save your changes in the Action field.
Provider Name	This shows the name of the service provider.
Mobile System	This shows the mobile telecommunications standard supported by the mobile network.
Network Status	This shows whether the mobile network is available.
Action	Click Select to have the LTE3301 establish a connection to the selected mobile network.
Apply	Click Apply to save your changes back to the LTE3301.
Cancel	Click Cancel to reload the previous configuration for this screen.
Refresh	Click Refresh to update this screen.

6.6 IPv6

Use this screen to configure the LTE3301's IPv6 settings. Click **Network > WAN > IPv6** from the **Configuration** menu.

Figure 32 Network > WAN > IPv6

The following table describes the labels in this screen.

Table 16 Network > WAN > IPv6

LABEL	DESCRIPTION
IPv6	Select Enable to allow the LTE3301 to run IPv6. Otherwise, select Disable .
IPv6 Connection	Select Static IPv6 if you have a fixed IPv6 address assigned by your ISP. Select DHCPv6 if you want to obtain an IPv6 address from a DHCPv6 server. Select PPPoE if your ISP requires you to use a PPPoE connection to the IPv6 Internet. This method of connection typically requires you to enter a Username and Password (provided by your ISP) to gain access to the IPv6 Internet. You need to ensure that any PPPoE client software on your computer is removed or disabled. Select 6RD to enable IPv6 rapid deployment to tunnel IPv6 traffic from the local network through the ISP's IPv4 network
(These fields appear when the IPv6 Connection is set to Static IPv6 .)	
IPv6 Address	Enter the IPv6 address on the WAN side in this field.
Subnet Prefix Length	Enter the address prefix length to specify how many most significant bits in an IPv6 address compose the network address.
Default Gateway	Enter the IP address of the next-hop gateway. The gateway is a router or switch on the same segment as your LTE3301's interface(s). The gateway helps forward packets to their destinations.
Primary DNS Address	Enter the first IPv6 DNS server address assigned by the ISP.
Secondary DNS Address	Enter the second IPv6 DNS server address assigned by the ISP.

Table 16 Network > WAN > IPv6 (continued)

LABEL	DESCRIPTION
(These fields appear when the IPv6 Connection is set to DHCPv6 .)	
DNS Setting	Select Obtain DNS Server address Automatically to have the LTE3301 get the IPv6 DNS server addresses from the ISP automatically. Select Use the following DNS address to have the LTE3301 use the IPv6 DNS server addresses you configure manually.
Primary DNS Address	Enter the first IPv6 DNS server address assigned by the ISP.
Secondary DNS Address	Enter the second IPv6 DNS server address assigned by the ISP.
(These fields appear when the IPv6 Connection is set to PPPoE .)	
Address Mode	Select Dynamic IP if you have a dynamic IP address. Select Static IP if the ISP assigned a fixed IP address.
IP Address	Enter the static IP address provided by your ISP.
Username	Enter a user name (of up to 31 printable characters) for login using PPPoE connection.
Password	Enter the password associated with the user name above.
Service Name	Enter the name of your PPPoE service here.
Reconnect Mode	Select Auto Reconnect (always-on) if you do not want the connection to time out. Select Connection-on-Demand if you want to connect for a certain amount of time before the router automatically disconnects from the PPPoE server. If you select this you will need to enter the number of minutes in the Maximum Idle Time field. Select Manually if want to make the connection manually.
Maximum Idle Time	Specify the time in minutes that elapses before the LTE3301 automatically disconnects from the PPPoE server.
(These fields appear when the IPv6 Connection is set to 6RD .)	
Remote IPv4 Address	Enter the IPv4 address of the relay server,
IPv4 Mask Length	Enter the IPv4 subnet mask number (1 to 32).
Remote Prefix	Enter an IPv6 prefix for tunneling IPv6 traffic to the ISP's Border Relay router and connecting to the native IPv6 Internet.
Prefix Length	Enter the address prefix length to specify how many most significant bits in an IPv6 address compose the network address.
Primary DNS Address	Enter the first IPv6 DNS server address assigned by the ISP.
Secondary DNS Address	Enter the second IPv6 DNS server address assigned by the ISP.
LAN IPv6 Address	Enter the IPv6 address for the LTE3301 LAN interface in this field.
LAN IPv6 Link-Local Address	This shows the IPv6 Link-local address in the LAN side. This is used by LTE3301 when communicating with neighboring devices on the same link. It allows IPv6-capable devices to communicate with each other in the LAN side.i
Autoconfiguration	Click Enable if you want the devices on your local area network to obtain network address that are not managed by a DHCPv6 server. Otherwise, select Disable .
Autoconfiguration Type	Select Stateless if you want the LTE3301 interface to automatically generate a link-local address via stateless autoconfiguration. Select Stateful (DHCPv6) when the devices connected to your LAN needs to have their TCP/IP configuration set to DHCPv6 or obtain an IPv6 address automatically.
IPv6 Address Range(Start)	If you select Stateful (DHCPv6) , specify the range of IPv6 addresses from which the DHCPv6 server assigns to the clients. Enter the smallest value of the last block of the IPv6 addresses which are to be allocated.

Table 16 Network > WAN > IPv6 (continued)

LABEL	DESCRIPTION
IPv6 Address Range(End)	If you select Stateful (DHCPv6) , specify the range of IPv6 addresses from which the DHCPv6 server assigns to the clients. Enter the largest value of the last block of the IPv6 addresses which are to be allocated.
IPv6 Address Lifetime	If you select Stateful (DHCPv6) , specify how long (in minutes) the IPv6 addresses remain valid.

CHAPTER 7

Wireless LAN

7.1 Overview

This chapter discusses how to configure the wireless network settings in your LTE3301.

See the appendices for more detailed information about wireless networks.

The following figure provides an example of a wireless network.

Figure 33 Example of a Wireless Network

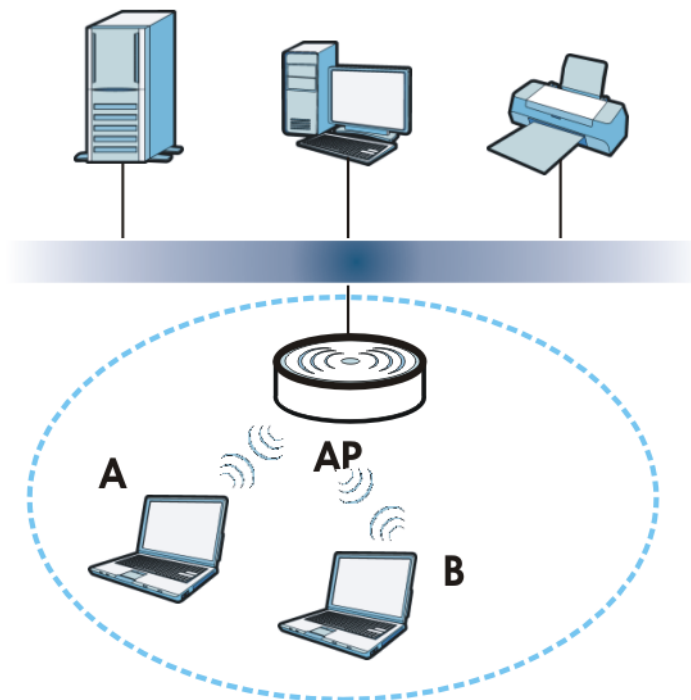

The wireless network is the part in the blue circle. In this wireless network, devices **A** and **B** are called wireless clients. The wireless clients use the access point (AP) to interact with other devices (such as the printer) or with the Internet. Your LTE3301 is the AP.

7.1.1 What You Can Do

- Use the **General** screen to turn the wireless connection on or off, set up wireless security between the LTE3301 and the wireless clients, and make other basic configuration changes ([Section 7.2 on page 63](#)).
- Use the **More AP** screen to set up multiple wireless networks on your LTE3301 ([Section 7.4 on page 70](#)).
- Use the **MAC Filter** screen to allow or deny wireless stations based on their MAC addresses from connecting to the LTE3301 ([Section 7.5 on page 72](#)).

- Use the **Advanced** screen to allow intra-BSS networking and set the RTS/CTS Threshold ([Section 7.6 on page 74](#)).
- Use the **QoS** screen to ensure Quality of Service (QoS) in your wireless network ([Section 7.7 on page 75](#)).
- Use the **WPS** screen to quickly set up a wireless network with strong security, without having to configure security settings manually ([Section 7.8 on page 75](#)).
- Use the **WPS Station** screen to add a wireless station using WPS ([Section 7.9 on page 77](#)).
- Use the **Scheduling** screen to set the times your wireless LAN is turned on and off ([Section 7.10 on page 77](#)).
- Use the **WDS** screen to configure the LTE3301's WDS settings ([Section 7.11 on page 78](#)).

7.1.2 What You Should Know

Every wireless network must follow these basic guidelines.

- Every wireless client in the same wireless network must use the same SSID.
The SSID is the name of the wireless network. It stands for Service Set IDentity.
- If two wireless networks overlap, they should use different channels.
Like radio stations or television channels, each wireless network uses a specific channel, or frequency, to send and receive information.
- Every wireless client in the same wireless network must use security compatible with the AP.
Security stops unauthorized devices from using the wireless network. It can also protect the information that is sent in the wireless network.

Wireless Security Overview

The following sections introduce different types of wireless security you can set up in the wireless network.

SSID

Normally, the AP acts like a beacon and regularly broadcasts the SSID in the area. You can hide the SSID instead, in which case the AP does not broadcast the SSID. In addition, you should change the default SSID to something that is difficult to guess.

This type of security is fairly weak, however, because there are ways for unauthorized devices to get the SSID. In addition, unauthorized devices can still see the information that is sent in the wireless network.

MAC Address Filter

Every wireless client has a unique identification number, called a MAC address.¹ A MAC address is usually written using twelve hexadecimal characters²; for example, 00A0C5000002 or 00:A0:C5:00:00:02. To get the MAC address for each wireless client, see the appropriate User's Guide or other documentation.

1. Some wireless devices, such as scanners, can detect wireless networks but cannot use wireless networks. These kinds of wireless devices might not have MAC addresses.

2. Hexadecimal characters are 0, 1, 2, 3, 4, 5, 6, 7, 8, 9, A, B, C, D, E, and F.

You can use the MAC address filter to tell the AP which wireless clients are allowed or not allowed to use the wireless network. If a wireless client is allowed to use the wireless network, it still has to have the correct settings (SSID, channel, and security). If a wireless client is not allowed to use the wireless network, it does not matter if it has the correct settings.

This type of security does not protect the information that is sent in the wireless network. Furthermore, there are ways for unauthorized devices to get the MAC address of an authorized wireless client. Then, they can use that MAC address to use the wireless network.

User Authentication

You can make every user log in to the wireless network before they can use it. This is called user authentication. However, every wireless client in the wireless network has to support IEEE 802.1x to do this.

For wireless networks, there are two typical places to store the user names and passwords for each user.

- In the AP: this feature is called a local user database or a local database.
- In a RADIUS server: this is a server used in businesses more than in homes.

If your AP does not provide a local user database and if you do not have a RADIUS server, you cannot set up user names and passwords for your users.

Unauthorized devices can still see the information that is sent in the wireless network, even if they cannot use the wireless network. Furthermore, there are ways for unauthorized wireless users to get a valid user name and password. Then, they can use that user name and password to use the wireless network.

Local user databases also have an additional limitation that is explained in the next section.

Encryption

Wireless networks can use encryption to protect the information that is sent in the wireless network. Encryption is like a secret code. If you do not know the secret code, you cannot understand the message.

The types of encryption you can choose depend on the type of user authentication. (See [page 62](#) for information about this.)

Table 17 Types of Encryption for Each Type of Authentication

	NO AUTHENTICATION	RADIUS SERVER
Weakest  Strongest	No Security	WPA
	Static WEP	
	WPA-PSK	
	WPA2-PSK	WPA2

For example, if the wireless network has a RADIUS server, you can choose **WPA** or **WPA2**. If users do not log in to the wireless network, you can choose no encryption, **Static WEP**, **WPA-PSK**, or **WPA2-PSK**.

Usually, you should set up the strongest encryption that every wireless client in the wireless network supports. For example, suppose the AP does not have a local user database, and you do not have a RADIUS server. Therefore, there is no user authentication. Suppose the wireless network has two wireless

clients. Device A only supports WEP, and device B supports WEP and WPA. Therefore, you should set up **Static WEP** in the wireless network.

Note: It is recommended that wireless networks use **WPA-PSK**, **WPA**, or stronger encryption. IEEE 802.1x and WEP encryption are better than none at all, but it is still possible for unauthorized devices to figure out the original information pretty quickly.

Note: It is not possible to use **WPA-PSK**, **WPA** or stronger encryption with a local user database. In this case, it is better to set up stronger encryption with no authentication than to set up weaker encryption with the local user database.

When you select **WPA2** or **WPA2-PSK** in your LTE3301, you can also select an option (**WPA/WPA-PSK Compatible**) to support WPA/WPA-PSK as well. In this case, if some wireless clients support WPA and some support WPA2, you should set up **WPA2-PSK** or **WPA2** (depending on the type of wireless network login) and select the **WPA/WPA-PSK Compatible** option in the LTE3301.

Many types of encryption use a key to protect the information in the wireless network. The longer the key, the stronger the encryption. Every wireless client in the wireless network must have the same key.

WPS

WiFi Protected Setup (WPS) is an industry standard specification, defined by the WiFi Alliance. WPS allows you to quickly set up a wireless network with strong security, without having to configure security settings manually. Depending on the devices in your network, you can either press a button (on the device itself, or in its configuration utility) or enter a PIN (Personal Identification Number) in the devices. Then, they connect and set up a secure network by themselves. See how to set up a secure wireless network using WPS in the [Section 4.2 on page 30](#).

7.2 General Wireless LAN Screen

Use this screen to configure the SSID and wireless security of the wireless LAN.

Note: If you are configuring the LTE3301 from a computer connected to the wireless LAN and you change the LTE3301's SSID, channel or security settings, you will lose your wireless connection when you press **Apply** to confirm. You must then change the wireless settings of your computer to match the LTE3301's new settings.

Click **Network > Wireless LAN** to open the **General** screen.

Figure 34 Network > Wireless LAN > General

The following table describes the general wireless LAN labels in this screen.

Table 18 Network > Wireless LAN > General

LABEL	DESCRIPTION
Wireless LAN Status	Select Enable to activate the 2.4GHz wireless LAN. Select Disable to turn it off. You can also enable or disable the 2.4GHz wireless LANs by using the WIFI button located on the back panel of the LTE3301.
Name (SSID)	The SSID (Service Set IDentity) identifies the Service Set with which a wireless client is associated. Enter a descriptive name (up to 32 printable characters found on a typical English language keyboard) for the wireless LAN.
Hide SSID	Select this check box to hide the SSID in the outgoing beacon frame so a station cannot obtain the SSID through scanning using a site survey tool.
Channel Selection	Set the operating frequency/channel depending on your particular region. Select a channel from the drop-down list box. The options vary depending on the frequency band and the country you are in. Refer to the Connection Wizard chapter for more information on channels. This option is only available if Auto Channel Selection is disabled.
Auto Channel Selection	Select this check box for the LTE3301 to automatically choose the channel with the least interference. Deselect this check box if you wish to manually select the channel using the Channel Selection field.
Operating Channel	This displays the channel the LTE3301 is currently using.

Table 18 Network > Wireless LAN > General (continued)

LABEL	DESCRIPTION
Channel Width	<p>Select the wireless channel width used by LTE3301.</p> <p>A standard 20MHz channel offers transfer speeds of up to 144Mbps (2.4GHz) whereas a 40MHz channel uses two standard channels and offers speeds of up to 300Mbps (2.4GHz).</p> <p>Because not all devices support 40 MHz channels, select Auto 20/40MHz to allow the LTE3301 to adjust the channel bandwidth automatically.</p> <p>40MHz (channel bonding or dual channel) bonds two adjacent radio channels to increase throughput. The wireless clients must also support 40 MHz. It is often better to use the 20 MHz setting in a location where the environment hinders the wireless signal.</p> <p>Select 20MHz if you want to lessen radio interference with other wireless devices in your neighborhood or the wireless clients do not support channel bonding.</p>
802.11 Mode	<p>You can select from the following:</p> <ul style="list-style-type: none"> • 802.11b: allows either IEEE 802.11b or IEEE 802.11g compliant WLAN devices to associate with the LTE3301. In this mode, all wireless devices can only transmit at the data rates supported by IEEE 802.11b. • 802.11g: allows IEEE 802.11g compliant WLAN devices to associate with the Device. IEEE 802.11b compliant WLAN devices can associate with the LTE3301 only when they use the short preamble type. • 802.11bg: allows either IEEE 802.11b or IEEE 802.11g compliant WLAN devices to associate with the LTE3301. The LTE3301 adjusts the transmission rate automatically according to the wireless standard supported by the wireless devices. • 802.11n: allows IEEE 802.11n compliant WLAN devices to associate with the LTE3301. This can increase transmission rates, although IEEE 802.11b or IEEE 802.11g clients will not be able to connect to the LTE3301. • 802.11gn: allows either IEEE 802.11g or IEEE 802.11n compliant WLAN devices to associate with the LTE3301. The transmission rate of your LTE3301 might be reduced. • 802.11bgn: allows IEEE802.11b, IEEE802.11g and IEEE802.11n compliant WLAN devices to associate with the LTE3301. The transmission rate of your LTE3301 might be reduced.
Security Mode	<p>Select Static WEP, WPA-PSK, WPA, WPA2-PSK or WPA2 to add security on this wireless network. The wireless clients which want to associate to this network must have same wireless security settings as this device. After you select to use a security, additional options appears in this screen. See Section 7.3 on page 65 for detailed information on different security modes. Or you can select No Security to allow any client to associate this network without authentication.</p> <p>Note: If the WPS function is enabled (default), only No Security and WPA2-PSK are available in this field.</p>
Apply	Click Apply to save your changes back to the LTE3301.
Cancel	Click Cancel to reload the previous configuration for this screen.

See the rest of this chapter for information on the other labels in this screen.

7.3 Wireless Security

The screen varies depending on what you select in the **Security Mode** field.

7.3.1 No Security

Select **No Security** to allow wireless clients to communicate with the access points without any data encryption.

Note: If you do not enable any wireless security on your LTE3301, your network is accessible to any wireless networking device that is within range.

Figure 35 Network > Wireless LAN > General: No Security

The following table describes the labels in this screen.

Table 19 Network > Wireless LAN > General: No Security

LABEL	DESCRIPTION
Security Mode	Choose No Security from the drop-down list box.
Apply	Click Apply to save your changes back to the LTE3301.
Cancel	Click Cancel to reload the previous configuration for this screen.

7.3.2 WEP Encryption

WEP encryption scrambles the data transmitted between the wireless stations and the access points to keep network communications private. It encrypts unicast and multicast communications in a network. Both the wireless stations and the access points must use the same WEP key.

Your LTE3301 allows you to configure up to four 64-bit or 128-bit WEP keys but only one key can be enabled at any one time.

Select **Static WEP** from the **Security Mode** list.

Figure 36 Network > Wireless LAN > General: Static WEP

Wireless Setup

Wireless LAN Status : Enable Disable

Name (SSID) :

Hide SSID

Channel Selection : Auto Channel Selection

Operating Channel :

Channel Width :

802.11 Mode :

Security

Security Mode :

WEP Encryption :

Authentication Method :

Note:

64-bit WEP: Enter 5 ASCII characters or 10 hexadecimal characters ("0-9", "A-F") for each Key (1-4).
 128-bit WEP: Enter 13 ASCII characters or 26 hexadecimal characters ("0-9", "A-F") for each Key (1-4).
 (Select one WEP key as an active key to encrypt wireless data transmission.)

ASCII Hex

Key 1

Key 2

Key 3

Key 4

Note: No Security and WPA2-PSK can be configured when WPS enabled.

The following table describes the wireless LAN security labels in this screen.

Table 20 Network > Wireless LAN > General: Static WEP

LABEL	DESCRIPTION
Security Mode	Select Static WEP to enable data encryption.
WEP Encryption	Select 64-bits or 128-bits . This dictates the length of the security key that the network is going to use.
Authentication Method	Select Auto or Shared Key from the drop-down list box. This field specifies whether the wireless clients have to provide the WEP key to log into the wireless network. Keep this setting at Auto unless you want to force a key verification before communication between the wireless client and the LTE3301 occurs. Select Shared Key to force the clients to provide the WEP key prior to communication.
ASCII	Select this option in order to enter ASCII characters as WEP key.
Hex	Select this option in order to enter hexadecimal characters as a WEP key. The preceding "0x", that identifies a hexadecimal key, is entered automatically.

Table 20 Network > Wireless LAN > General: Static WEP (continued)

LABEL	DESCRIPTION
Key 1 to Key 4	<p>The WEP keys are used to encrypt data. Both the LTE3301 and the wireless stations must use the same WEP key for data transmission.</p> <p>If you chose 64-bits, then enter any 5 ASCII characters or 10 hexadecimal characters ("0-9", "A-F").</p> <p>If you chose 128-bits, then enter 13 ASCII characters or 26 hexadecimal characters ("0-9", "A-F").</p> <p>You must configure at least one key, only one key can be activated at any one time. The default key is key 1.</p>
Apply	Click Apply to save your changes back to the LTE3301.
Cancel	Click Cancel to reload the previous configuration for this screen.

7.3.3 WPA-PSK/WPA2-PSK

Select **WPA-PSK** or **WPA2-PSK** from the **Security Mode** list.

Figure 37 Network > Wireless LAN > General: WPA-PSK/WPA2-PSK

The screenshot shows the configuration interface for WPA-PSK/WPA2-PSK. The 'General' tab is selected. Under 'Wireless Setup', 'Wireless LAN Status' is set to 'Enable'. The 'Name (SSID)' is 'ZyXEL_A2DD'. 'Channel Selection' is 'Channel-1 2412MHz' with 'Auto Channel Selection' checked. 'Operating Channel' is 'Auto' and 'Channel Width' is 'Auto 20/40 MHz'. '802.11 Mode' is '802.11bgn'. Under 'Security', 'Security Mode' is 'WPA2-PSK'. 'WPA-PSK Compatible' is unchecked. 'Pre-Shared Key' is '48A7B141263C1' and 'Group Key Update Timer' is '3600 seconds'. A note at the bottom states: 'Note: No Security and WPA2-PSK can be configured when WPS enabled.' 'Apply' and 'Cancel' buttons are at the bottom.

The following table describes the labels in this screen.

Table 21 Network > Wireless LAN > General: WPA-PSK/WPA2-PSK

LABEL	DESCRIPTION
Security Mode	Select WPA-PSK or WPA2-PSK to enable data encryption.
WPA-PSK Compatible	<p>This field appears when you choose WPA2-PSK as the Security Mode.</p> <p>Check this field to allow wireless devices using WPA-PSK security mode to connect to your LTE3301.</p>

Table 21 Network > Wireless LAN > General: WPA-PSK/WPA2-PSK (continued)

LABEL	DESCRIPTION
Pre-Shared Key	WPA-PSK/WPA2-PSK uses a simple common password for authentication. Type a pre-shared key from 8 to 63 case-sensitive keyboard characters.
Group Key Update Timer	The Group Key Update Timer is the rate at which the AP sends a new group key out to all clients. The default is 3600 seconds (60 minutes).
Apply	Click Apply to save your changes back to the LTE3301.
Cancel	Click Cancel to reload the previous configuration for this screen.

7.3.4 WPA/WPA2

Select **WPA** or **WPA2** from the **Security Mode** list.

Note: WPA or WPA2 is not available if you enable WPS before you configure WPA or WPA2 in the **Wireless LAN > General** screen.

Figure 38 Network > Wireless LAN > General: WPA/WPA2

The screenshot shows the configuration interface for the Wireless LAN > General settings. The 'Wireless Setup' section includes:

- Wireless LAN Status: Enable Disable
- Name (SSID): ZyXEL_A2DD
- Hide SSID:
- Channel Selection: Channel-1 2412MHz (dropdown), Auto Channel Selection
- Operating Channel: Auto
- Channel Width: Auto 20/40 MHz (dropdown)
- 802.11 Mode: 802.11bgn (dropdown)

 The 'Security' section includes:

- Security Mode: WPA2 (dropdown)
- WPA Compatible:
- Group Key Update Timer: 3600 seconds
- Authentication Server:
 - IP Address: 0.0.0.0
 - Port Number: 1812
 - Shared Secret: (empty text box)

 A note at the bottom states: "Note: No Security and WPA2-PSK can be configured when WPS enabled." Buttons for 'Apply' and 'Cancel' are at the bottom right.

The following table describes the labels in this screen.

Table 22 Network > Wireless LAN > General: WPA/WPA2

LABEL	DESCRIPTION
Security Mode	Select WPA or WPA2 to enable data encryption.
WPA Compatible	This check box is available only when you select WPA2-PSK or WPA2 in the Security Mode field. Select the check box to have both WPA2 and WPA wireless clients be able to communicate with the LTE3301 even when the LTE3301 is using WPA2-PSK or WPA2.
Group Key Update Timer	The Group Key Update Timer is the rate at which the AP (if using WPA-PSK/WPA2-PSK key management) or RADIUS server (if using WPA/WPA2 key management) sends a new group key out to all clients. The re-keying process is the WPA/WPA2 equivalent of automatically changing the WEP key for an AP and all stations in a WLAN on a periodic basis. Setting of the Group Key Update Timer is also supported in WPA-PSK/WPA2-PSK mode.
Authentication Server	
IP Address	Enter the IP address of the external authentication server in dotted decimal notation.
Port Number	Enter the port number of the external authentication server. You need not change this value unless your network administrator instructs you to do so with additional information.
Shared Secret	Enter a password (up to 127 alphanumeric characters) as the key to be shared between the external authentication server and the LTE3301. The key must be the same on the external authentication server and your LTE3301. The key is not sent over the network.
Apply	Click Apply to save your changes back to the LTE3301.
Cancel	Click Cancel to reload the previous configuration for this screen.

7.4 More AP Screen

This screen allows you to enable and configure multiple wireless networks and guest wireless network settings on the LTE3301.

You can configure up to four SSIDs to enable multiple BSSs (Basic Service Sets) on the LTE3301. This allows you to use one access point to provide several BSSs simultaneously. You can then assign varying security types to different SSIDs. Wireless clients can use different SSIDs to associate with the same access point.

Click **Network > Wireless LAN > More AP**. The following screen displays.

Figure 39 Network > Wireless LAN > More AP

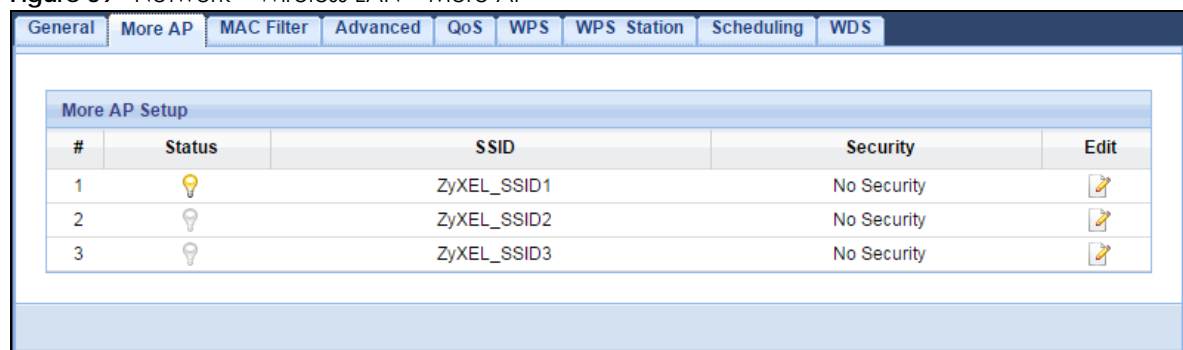

The following table describes the labels in this screen.

Table 23 Network > Wireless LAN > More AP

LABEL	DESCRIPTION
#	This is the index number of each SSID profile.
Status	This shows whether the SSID profile is active (a yellow bulb) or not (a gray bulb).
SSID	An SSID profile is the set of parameters relating to one of the LTE3301's BSSs. The SSID (Service Set Identifier) identifies the Service Set with which a wireless device is associated. This field displays the name of the wireless profile on the network. When a wireless client scans for an AP to associate with, this is the name that is broadcast and seen in the wireless client utility.
Security	This field indicates the security mode of the SSID profile.
Edit	Click the Edit icon to configure the SSID profile.

7.4.1 More AP Edit

Use this screen to edit an SSID profile. Click the **Edit** icon next to an SSID in the **More AP** screen. The following screen displays.

Figure 40 Network > Wireless LAN > More AP: Edit

The following table describes the labels in this screen.

Table 24 Network > Wireless LAN > More AP: Edit

LABEL	DESCRIPTION
Active	Select this to activate the SSID profile.
Name (SSID)	The SSID (Service Set IDentity) identifies the Service Set with which a wireless client is associated. Enter a descriptive name (up to 32 printable characters found on a typical English language keyboard) for the wireless LAN.
Hide SSID	Select this check box to hide the SSID in the outgoing beacon frame so a station cannot obtain the SSID through scanning using a site survey tool.

Table 24 Network > Wireless LAN > More AP: Edit (continued)

LABEL	DESCRIPTION
Intra-BSS Traffic	<p>A Basic Service Set (BSS) exists when all communications between wireless clients or between a wireless client and a wired network client go through one access point (AP).</p> <p>Intra-BSS traffic is traffic between wireless clients in the BSS. When Intra-BSS is enabled, wireless clients can access the wired network and communicate with each other. When Intra-BSS is disabled, wireless clients can still access the wired network but cannot communicate with each other.</p>
WMM QoS	<p>Check this to have the LTE3301 automatically give a service a priority level according to the ToS value in the IP header of packets it sends.</p> <p>WMM QoS (Wifi MultiMedia Quality of Service) gives high priority to voice and video, which makes them run more smoothly.</p>
Security Mode	<p>Select Static WEP, WPA-PSK, WPA, WPA2-PSK or WPA2 to add security on this wireless network. The wireless clients which want to associate to this network must have same wireless security settings as this device. After you select to use a security, additional options appears in this screen. See Section 7.3 on page 65 for detailed information on different security modes. Or you can select No Security to allow any client to associate this network without authentication.</p> <p>Note: If the WPS function is enabled (default), only No Security and WPA2-PSK are available in this field.</p>
Apply	Click Apply to save your changes back to the LTE3301.
Cancel	Click Cancel to reload the previous configuration for this screen.

7.5 MAC Filter Screen

The MAC filter screen allows you to configure the LTE3301 to give exclusive access to devices (**Allow**) or exclude devices from accessing the LTE3301 (**Deny**). Every Ethernet device has a unique MAC (Media Access Control) address. The MAC address is assigned at the factory and consists of six pairs of hexadecimal characters, for example, 00:A0:C5:00:00:02. You need to know the MAC address of the devices to configure this screen.

To change your LTE3301's MAC filter settings, click **Network > Wireless LAN > MAC Filter**. The screen appears as shown.

Figure 41 Network > Wireless LAN > MAC Filter

MAC Address Filter : Enable Disable

Filter Action : Allow Deny

MAC Filter Summary			
Set	MAC Address	Set	MAC Address
1	<input type="text"/>	17	<input type="text"/>
2	<input type="text"/>	18	<input type="text"/>
3	<input type="text"/>	19	<input type="text"/>
4	<input type="text"/>	20	<input type="text"/>
5	<input type="text"/>	21	<input type="text"/>
6	<input type="text"/>	22	<input type="text"/>
7	<input type="text"/>	23	<input type="text"/>
8	<input type="text"/>	24	<input type="text"/>
9	<input type="text"/>	25	<input type="text"/>
10	<input type="text"/>	26	<input type="text"/>
11	<input type="text"/>	27	<input type="text"/>
12	<input type="text"/>	28	<input type="text"/>
13	<input type="text"/>	29	<input type="text"/>
14	<input type="text"/>	30	<input type="text"/>
15	<input type="text"/>	31	<input type="text"/>
16	<input type="text"/>	32	<input type="text"/>

Apply Cancel

The following table describes the labels in this menu.

Table 25 Network > Wireless LAN > MAC Filter

LABEL	DESCRIPTION
MAC Address Filter	Select to turn on (Enable) or off (Disable) MAC address filtering.
Filter Action	Define the filter action for the list of MAC addresses in the MAC Filter Summary table. Select Allow to permit access to the LTE3301, MAC addresses not listed will be denied access to the LTE3301. Select Deny to block access to the LTE3301, MAC addresses not listed will be allowed to access the LTE3301.
MAC Filter Summary	
Set	This is the index number of the MAC address.
MAC Address	Enter the MAC address of the wireless station that are allowed or denied access to the LTE3301.
Apply	Click Apply to save your changes back to the LTE3301.
Cancel	Click Cancel to reload the previous configuration for this screen.

7.6 Wireless LAN Advanced Screen

Use this screen to allow wireless advanced features, such as the output power, RTS/CTS Threshold settings.

Click **Network > Wireless LAN > Advanced**. The screen appears as shown.

Figure 42 Network > Wireless LAN > Advanced

The screenshot shows the 'Advanced' tab of the 'Wireless LAN' settings. The 'Wireless Advanced Setup' section contains the following fields and options:

- RTS/CTS Threshold :** Input field with value 2347 and range (1~2347).
- Fragmentation Threshold :** Input field with value 2346 and range (256 ~ 2346).
- Intra-BSS Traffic :** Radio buttons for Enable (selected) and Disable.
- Green AP :** Radio buttons for Enable and Disable (selected).
- Tx Power :** Dropdown menu with 100% selected.
- Beacon Interval :** Input field with value 100 and range (msec, 100~1000).

Buttons for 'Apply' and 'Cancel' are located at the bottom of the screen.

The following table describes the labels in this screen.

Table 26 Network > Wireless LAN > Advanced

LABEL	DESCRIPTION
RTS/CTS Threshold	Data with its frame size larger than this value will perform the RTS (Request To Send)/CTS (Clear To Send) handshake. This field is not configurable and the LTE3301 automatically changes to use the maximum value if you select 802.11n , 802.11gn or 802.11bgn in the Wireless LAN > General screen.
Fragmentation Threshold	The threshold (number of bytes) for the fragmentation boundary for directed messages. It is the maximum data fragment size that can be sent. This field is not configurable and the LTE3301 automatically changes to use the maximum value if you select 802.11n , 802.11gn or 802.11bgn in the Wireless LAN > General screen.
Intra-BSS Traffic	A Basic Service Set (BSS) exists when all communications between wireless clients or between a wireless client and a wired network client go through one access point (AP). Intra-BSS traffic is traffic between wireless clients in the BSS. When Intra-BSS is enabled, wireless clients can access the wired network and communicate with each other. When Intra-BSS is disabled, wireless clients can still access the wired network but cannot communicate with each other.
Green AP	Select Enable to reduce the power consumption by adjusting the output power. The LTE3301 reduces the output power of the transmitter from about 260mA to 188mA when there is no IEEE 802.11 wireless clients associated with the LTE3301 wireless network.
Tx Power	Set the output power of the LTE3301 in this field. If there is a high density of APs in an area, decrease the output power of the LTE3301 to reduce interference with other APs. Select one of the following 100% , 90% , 75% , 50% , 25% or 10% .
Beacon Interval	When a wirelessly networked device sends a beacon, it includes with it a beacon interval. This specifies the time period before the device sends the beacon again. The interval tells receiving devices on the network how long they can wait in low-power mode before waking up to handle the beacon. A high value helps save current consumption of the access point.
Apply	Click Apply to save your changes back to the LTE3301.
Cancel	Click Cancel to reload the previous configuration for this screen.

7.7 Quality of Service (QoS) Screen

The QoS screen allows you to automatically give a service (such as VoIP and video) a priority level.

Click **Network > Wireless LAN > QoS**. The following screen appears.

Figure 43 Network > Wireless LAN > QoS

The following table describes the labels in this screen.

Table 27 Network > Wireless LAN > QoS

LABEL	DESCRIPTION
WMM QoS	Select Enable to have the LTE3301 automatically give a service a priority level according to the ToS value in the IP header of packets it sends. WMM QoS (Wifi MultiMedia Quality of Service) gives high priority to voice and video, which makes them run more smoothly. This field is not configurable and the LTE3301 automatically enables WMM QoS if you select 802.11n , 802.11gn or 802.11bgn in the Wireless LAN > General screen.
Apply	Click Apply to save your changes to the LTE3301.
Cancel	Click Cancel to reload the previous configuration for this screen.

7.8 WPS Screen

Use this screen to enable/disable WPS, view or generate a new PIN number and check current WPS status. To open this screen, click **Network > Wireless LAN > WPS**.

Note: With WPS, wireless clients can only connect to the wireless network using the first SSID on the LTE3301.

Figure 44 Network > Wireless LAN > WPS

The following table describes the labels in this screen.

Table 28 Network > Wireless LAN > WPS

LABEL	DESCRIPTION
WPS Setup	
WPS	Select Enable to turn on the WPS feature. Otherwise, select Disable .
PIN Code	Select Enable and click Apply to allow the PIN Configuration method. If you select Disable , you cannot create a new PIN number.
PIN Number	This is the WPS PIN (Personal Identification Number) of the LTE3301. Enter this PIN in the configuration utility of the device you want to connect to the LTE3301 using WPS. The PIN is not necessary when you use WPS push-button method. Click Generate to generate a new PIN number.
WPS Status	
Status	This displays Configured when the LTE3301 has connected to a wireless network using WPS or when WPS Enable is selected and wireless or wireless security settings have been changed. The current wireless and wireless security settings also appear in the screen. This displays Unconfigured if WPS is disabled and there are no wireless or wireless security changes on the LTE3301 or you click Release Configuration to remove the configured wireless and wireless security settings.
Release Configuration	This button is only available when the WPS status displays Configured . Click this button to remove all configured wireless and wireless security settings for WPS connections on the LTE3301.
802.11 Mode	This is the 802.11 mode used. Only compliant WLAN devices can associate with the LTE3301.
SSID	This is the name of the wireless network (the LTE3301's first SSID).
Security	This is the type of wireless security employed by the network.
Apply	Click Apply to save your changes back to the LTE3301.
Cancel	Click Cancel to reload the previous configuration for this screen.

7.9 WPS Station Screen

Use this screen when you want to add a wireless station using WPS. To open this screen, click **Network > Wireless LAN > WPS Station** tab.

Note: After you click **Push Button** on this screen, you have to press a similar button in the wireless station utility within 2 minutes. To add the second wireless station, you have to press these buttons on both device and the wireless station again after the first 2 minutes.

Figure 45 Network > Wireless LAN > WPS Station

The following table describes the labels in this screen.

Table 29 Network > Wireless LAN > WPS Station

LABEL	DESCRIPTION
Push Button	Use this button when you use the PBC (Push Button Configuration) method to configure wireless station's wireless settings. Click this to start WPS-aware wireless station scanning and the wireless security information synchronization.
Or input station's PIN number	Use this button when you use the PIN Configuration method to configure wireless station's wireless settings. Type the same PIN number generated in the wireless station's utility. Then click Start to associate to each other and perform the wireless security information synchronization.

7.10 Scheduling Screen

Use this screen to set the times your wireless LAN is turned on and off. Wireless LAN scheduling is disabled by default. The wireless LAN can be scheduled to turn on or off on certain days and at certain times. To open this screen, click **Network > Wireless LAN > Scheduling** tab.

Figure 46 Network > Wireless LAN > Scheduling

Wireless LAN Scheduling : Enable Disable

Policy : On Off

Day	For the following times (24-Hour Format)
<input type="checkbox"/> EveryDay	00 (hour) 00 (min) ~ 00 (hour) 00 (min)
<input type="checkbox"/> Mon	00 (hour) 00 (min) ~ 00 (hour) 00 (min)
<input type="checkbox"/> Tue	00 (hour) 00 (min) ~ 00 (hour) 00 (min)
<input type="checkbox"/> Wed	00 (hour) 00 (min) ~ 00 (hour) 00 (min)
<input type="checkbox"/> Thu	00 (hour) 00 (min) ~ 00 (hour) 00 (min)
<input type="checkbox"/> Fri	00 (hour) 00 (min) ~ 00 (hour) 00 (min)
<input type="checkbox"/> Sat	00 (hour) 00 (min) ~ 00 (hour) 00 (min)
<input type="checkbox"/> Sun	00 (hour) 00 (min) ~ 00 (hour) 00 (min)

Note:
Specify the same begin time and end time means the whole day schedule.

Apply Cancel

The following table describes the labels in this screen.

Table 30 Network > Wireless LAN > Scheduling

LABEL	DESCRIPTION
Wireless LAN Scheduling	Select Enable to activate the wireless LAN scheduling feature. Select Disable to turn it off.
Policy	Select On or Off to specify whether the Wireless LAN is turned on or off. This field works in conjunction with the Day and For the following times fields.
Scheduling	
Day	Select Everyday or the specific days to turn the Wireless LAN on or off. If you select Everyday you can not select any specific days. This field works in conjunction with the For the following times field.
For the following times (24-Hour Format)	Select a begin time using the first set of hour and minute (min) drop down boxes and select an end time using the second set of hour and minute (min) drop down boxes. If you have chosen On earlier for the WLAN Status the Wireless LAN will turn on between the two times you enter in these fields. If you have chosen Off earlier for the WLAN Status the Wireless LAN will turn off between the two times you enter in these fields.
Apply	Click Apply to save your changes back to the LTE3301.
Cancel	Click Cancel to reload the previous configuration for this screen.

7.11 WDS Screen

A Wireless Distribution System (WDS) is a wireless connection between two or more APs. Use this screen to configure the LTE3301's WDS settings. To open this screen, click **Network > Wireless LAN > WDS** tab.

Figure 47 Network > Wireless LAN > WDS

The screenshot shows the WDS Setup configuration page. It features a navigation bar with tabs: General, More AP, MAC Filter, Advanced, QoS, WPS, WPS Station, Scheduling, and WDS. The WDS Setup section contains the following fields:

- Basic Setting:** A dropdown menu set to "Bridge Only".
- Local MAC Address:** A text field containing "90:EF:68:D3:A2:DD".
- Phy Mode:** A dropdown menu set to "CCK".
- Remote MAC Address:** Three empty text input fields stacked vertically.
- Security:**
 - EncrypType:** A dropdown menu set to "AES".
 - Encryp Key:** A text field containing "48A7B141263C1".

At the bottom of the page, there are two buttons: "Apply" and "Reset".

The following table describes the labels in this screen.

Table 31 Network > Wireless LAN > WDS

LABEL	DESCRIPTION
WDS Setup	
Basic Setting	Select Disable to turn off the WDS function on the LTE3301. Select AP+Bridge to have the LTE3301 function as a bridge and access point simultaneously. Select Bridge Only to have the LTE3301 act as a wireless bridge only.
Local MAC Address	This shows the MAC address of the LTE3301.
Phy Mode	Select the physical mode supported by the LTE3301. You must also set the peer device to use the same physical mode.
Remote MAC Address	Type the MAC address of the peer device in a valid MAC address format, that is, six hexadecimal character pairs, for example, 12:34:56:78:9a:bc.
Security	
Encryp Type	Select the type of security you want to use (TKIP or AES) to secure traffic on your WDS. Otherwise, select No Security . Select TKIP to enable Temporal Key Integrity Protocol (TKIP) security on your WDS. This option is compatible with other ZyXEL access points that support WDS security. Use this if the other access points on your network support WDS security but do not have an AES option. AES provides superior security to TKIP. Use AES if the other access points on your network support it for the WDS.
Encryp Key	Type a pre-shared key from 8 to 63 case-sensitive ASCII characters (including spaces and symbols). You must also set the peer device to use the same pre-shared key.
Apply	Click Apply to save your changes back to the LTE3301.
Reset	Click Reset to reload the previous configuration for this screen.

CHAPTER 8

LAN

8.1 Overview

This chapter describes how to configure LAN settings.

A Local Area Network (LAN) is a shared communication system to which many computers are attached. A LAN is a computer network limited to the immediate area, usually the same building or floor of a building.

Figure 48 LAN Example

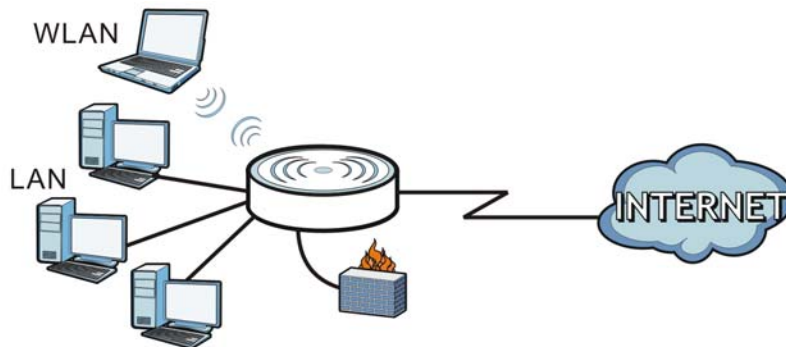

The LAN screens can help you configure a manage IP address, and partition your physical network into logical networks.

8.2 What You Can Do

- Use the **IP** screen to change the IP address for your LTE3301 ([Section 8.4 on page 81](#)).

8.3 What You Need To Know

The actual physical connection determines whether the LTE3301 ports are LAN or WAN ports. There are two separate IP networks, one inside the LAN network and the other outside the WAN network as shown next.

Figure 49 LAN and WAN IP Addresses

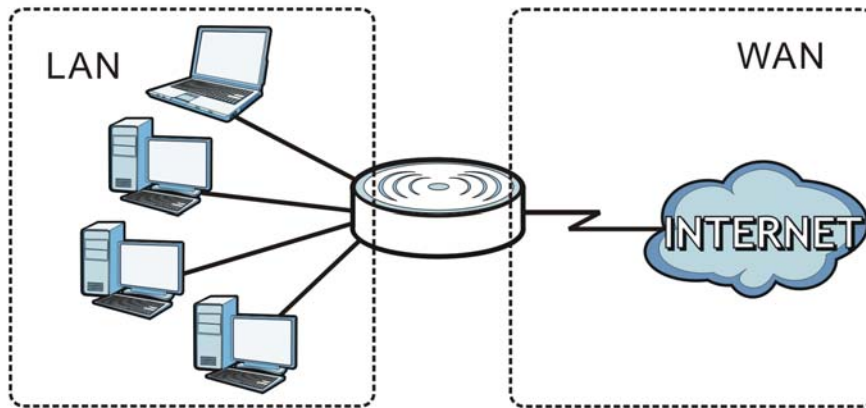

The LAN parameters of the LTE3301 are preset in the factory with the following values:

- IP address of 192.168.1.1 with subnet mask of 255.255.255.0 (24 bits)
- DHCP server enabled with 32 client IP addresses starting from 192.168.1.33.

These parameters should work for the majority of installations. If your ISP gives you explicit DNS server address(es), read the embedded Web Configurator help regarding what fields need to be configured.

8.4 LAN IP Screen

Use this screen to change the IP address for your LTE3301. Click **Network > LAN > IP**.

Figure 50 Network > LAN > IP

The following table describes the labels in this screen.

Table 32 Network > LAN > IP

LABEL	DESCRIPTION
IP Address	Type the IP address of your LTE3301 in dotted decimal notation.
IP Subnet Mask	The subnet mask specifies the network number portion of an IP address. Your LTE3301 will automatically calculate the subnet mask based on the IP address that you assign. Unless you are implementing subnetting, use the subnet mask computed by the LTE3301.
Apply	Click Apply to save your changes back to the LTE3301.
Cancel	Click Cancel to begin configuring this screen afresh.

CHAPTER 9

DHCP Server

9.1 Overview

DHCP (Dynamic Host Configuration Protocol, RFC 2131 and RFC 2132) allows individual clients to obtain TCP/IP configuration at start-up from a server. You can configure the LTE3301's LAN as a DHCP server or disable it. When configured as a server, the LTE3301 provides the TCP/IP configuration for the clients. If DHCP service is disabled, you must have another DHCP server on your LAN, or else the computer must be manually configured.

9.1.1 What You Can Do

- Use the **General** screen to enable the DHCP server ([Section 9.2 on page 82](#)).
- Use the **Advanced** screen to assign IP addresses on the LAN to specific individual computers based on their MAC Addresses ([Section 9.3 on page 84](#)).
- Use the **Client List** screen to view the current DHCP client information ([Section 9.4 on page 86](#)).

9.1.2 What You Need To Know

The following terms and concepts may help as you read through this chapter.

MAC Addresses

Every Ethernet device has a unique MAC (Media Access Control) address. The MAC address is assigned at the factory and consists of six pairs of hexadecimal characters, for example, 00:A0:C5:00:00:02. Find out the MAC addresses of your network devices if you intend to add them to the **DHCP Client List** screen.

IP Pool Setup

The LTE3301 is pre-configured with a pool of 32 IP addresses starting from 192.168.1.33 to 192.168.1.64. This configuration leaves 31 IP addresses (excluding the LTE3301 itself) in the lower range (192.168.1.2 to 192.168.1.32) for other server computers, for instance, servers for mail, FTP, TFTP, web, etc., that you may have.

9.2 DHCP Server General Screen

The LTE3301 has built-in DHCP server capability that assigns IP addresses to systems that support DHCP client capability. Use this screen to enable the DHCP server. Click **Network > DHCP Server**. The following screen displays.

Figure 51 Network > DHCP Server > General

General | **Advanced** | **Client List**

DHCP 1 Server:
 DHCP Server: Enable Disable
 IP Pool Starting Address:
 Pool Size:
 DHCP Relay
 DHCP Server IP:
 Lease Time: Seconds

VLAN DHCP 2 Server:
 DHCP Server: Enable Disable
 DHCP IP Address:
 First DNS Server:
 Second DNS Server:

VLAN DHCP 3 Server:
 DHCP Server: Enable Disable
 DHCP IP Address:
 First DNS Server:
 Second DNS Server:

VLAN DHCP 4 Server:
 DHCP Server: Enable Disable
 DHCP IP Address:
 First DNS Server:
 Second DNS Server:

The following table describes the labels in this screen.

Table 33 Network > DHCP Server > General

LABEL	DESCRIPTION
DHCP Server	Select Enable to activate DHCP for LAN. DHCP (Dynamic Host Configuration Protocol, RFC 2131 and RFC 2132) allows individual clients (computers) to obtain TCP/IP configuration at startup from a server. Enable the DHCP server unless your ISP instructs you to do otherwise. Select Disable to stop the LTE3301 acting as a DHCP server. When configured as a server, the LTE3301 provides TCP/IP configuration for the clients. If not, DHCP service is disabled and you must have another DHCP server on your LAN, or else the computers must be manually configured. When set as a server, fill in the following four fields.
IP Pool Starting Address	This field specifies the first of the contiguous addresses in the IP address pool for LAN.
Pool Size	This field specifies the size, or count of the IP address pool for LAN.
DHCP Relay	Select this option to have the LTE3301 forward DHCP requests to the DHCP server.

Table 33 Network > DHCP Server > General (continued)

LABEL	DESCRIPTION
DHCP Server IP	This field is configurable only when you select DHCP Relay . Enter the IP address of the actual remote DHCP server in this field.
Lease Time	This is the period of time DHCP-assigned addresses is used. DHCP automatically assigns IP addresses to clients when they log in. DHCP centralizes IP address management on central computers that run the DHCP server program. DHCP leases addresses, for a period of time, which means that past addresses are "recycled" and made available for future reassignment to other systems.
VLAN DHCP x Server This section is configurable only when you create a corresponding VLAN group in the Interface Group screen.	
DHCP Server	Select Enable to activate DHCP for the VLAN group.
DHCP IP Address	Enter the LAN IP address you want to assign to your LTE3301 in this VLAN group.
First DNS Server Second DNS Server	Specify the IP addresses up to two DNS servers for the DHCP clients to use. Select Obtained From ISP if your ISP dynamically assigns DNS server information (and the LTE3301's WAN IP address). The field to the right displays the (read-only) DNS server IP address that the ISP assigns. Select User-Defined if you have the IP address of a DNS server. Enter the DNS server's IP address in the field to the right. Select DNS Relay to have the LTE3301 act as a DNS proxy. The LTE3301's LAN IP address displays in the field to the right (read-only). The LTE3301 tells the DHCP clients on the LAN that the LTE3301 itself is the DNS server. When a computer on the LAN sends a DNS query to the LTE3301, the LTE3301 forwards the query to the LTE3301's system DNS server (configured in the WAN screen) and relays the response back to the computer.
Apply	Click Apply to save your changes back to the LTE3301.
Cancel	Click Cancel to begin configuring this screen afresh.

9.3 DHCP Server Advanced Screen

This screen allows you to assign IP addresses on the LAN to specific individual computers based on their MAC addresses. You can also use this screen to configure the DNS server information that the LTE3301 sends to the DHCP clients.

To change your LTE3301's static DHCP settings, click **Network > DHCP Server > Advanced**. The following screen displays.

Figure 52 Network > DHCP Server > Advanced

The following table describes the labels in this screen.

Table 34 Network > DHCP Server > Advanced

LABEL	DESCRIPTION
Static DHCP Table	
#	This is the index number of the static IP table entry (row).
MAC Address	Type the MAC address (with colons) of a computer on your LAN.
IP Address	Type the LAN IP address of a computer on your LAN.
DNS Server	
DNS Servers Assigned by DHCP Server	The LTE3301 passes a DNS (Domain Name System) server IP address (in the order you specify here) to the DHCP clients. The LTE3301 only passes this information to the LAN DHCP clients when you enable DHCP Server in the General screen. When you disable DHCP Server , DHCP service is disabled and you must have another DHCP sever on your LAN, or else the computers must have their DNS server addresses manually configured.
First DNS Server Second DNS Server	Select Obtained From ISP if your ISP dynamically assigns DNS server information (and the LTE3301's WAN IP address). The field to the right displays the (read-only) DNS server IP address that the ISP assigns. Select User-Defined if you have the IP address of a DNS server. Enter the DNS server's IP address in the field to the right. Select DNS Relay to have the LTE3301 act as a DNS proxy. The LTE3301's LAN IP address displays in the field to the right (read-only). The LTE3301 tells the DHCP clients on the LAN that the LTE3301 itself is the DNS server. When a computer on the LAN sends a DNS query to the LTE3301, the LTE3301 forwards the query to the LTE3301's system DNS server (configured in the WAN screen) and relays the response back to the computer.
Apply	Click Apply to save your changes back to the LTE3301.
Cancel	Click Cancel to begin configuring this screen afresh.

9.4 DHCP Client List Screen

The DHCP table shows current DHCP client information (including IP Address, Host Name and MAC Address) of network clients using the LTE3301's DHCP servers.

Configure this screen to always assign an IP address to a MAC address (and host name). Click **Network > DHCP Server > Client List**.

Note: You can also view a read-only client list by clicking **Monitor > DHCP Server**.

Figure 53 Network > DHCP Server > Client List

The screenshot shows a web interface with three tabs: 'General', 'Advanced', and 'Client List'. The 'Client List' tab is active. Below the tabs is a table titled 'DHCP Client Table' with the following data:

#	Status	Host Name	IP Address	MAC Address	Reserve
1		twpc	192.168.1.46	00:21:85:0c:44:4b	<input type="checkbox"/>

At the bottom of the screen are two buttons: 'Apply' and 'Cancel'.

The following table describes the labels in this screen.

Table 35 Network > DHCP Server > Client List

LABEL	DESCRIPTION
#	This is the index number of the host computer.
Status	This field displays whether the connection to the host computer is up (a yellow bulb) or down (a gray bulb).
Host Name	This field displays the computer host name.
IP Address	This field displays the IP address relative to the # field listed above.
MAC Address	This field shows the MAC address of the computer with the name in the Host Name field. Every Ethernet device has a unique MAC (Media Access Control) address which uniquely identifies a device. The MAC address is assigned at the factory and consists of six pairs of hexadecimal characters, for example, 00:A0:C5:00:00:02.
Reserve	Select this if you want to reserve the IP address for this specific MAC address.
Apply	Click Apply to save your changes back to the LTE3301.
Cancel	Click Cancel to reload the previous configuration for this screen.

CHAPTER 10

NAT

10.1 Overview

NAT (Network Address Translation - NAT, RFC 1631) is the translation of the IP address of a host in a packet. For example, the source address of an outgoing packet, used within one network is changed to a different IP address known within another network.

The figure below is a simple illustration of a NAT network. You want to assign ports 21-25 to one FTP, Telnet and SMTP server (**A** in the example), port 80 to another (**B** in the example) and assign a default server IP address of 192.168.1.35 to a third (**C** in the example).

You assign the LAN IP addresses to the devices (**A** to **D**) connected to your LTE3301. The ISP assigns the WAN IP address. The NAT network appears as a single host on the Internet. All traffic coming from **A** to **D** going out to the Internet use the IP address of the LTE3301, which is 192.168.1.1.

Figure 54 NAT Example

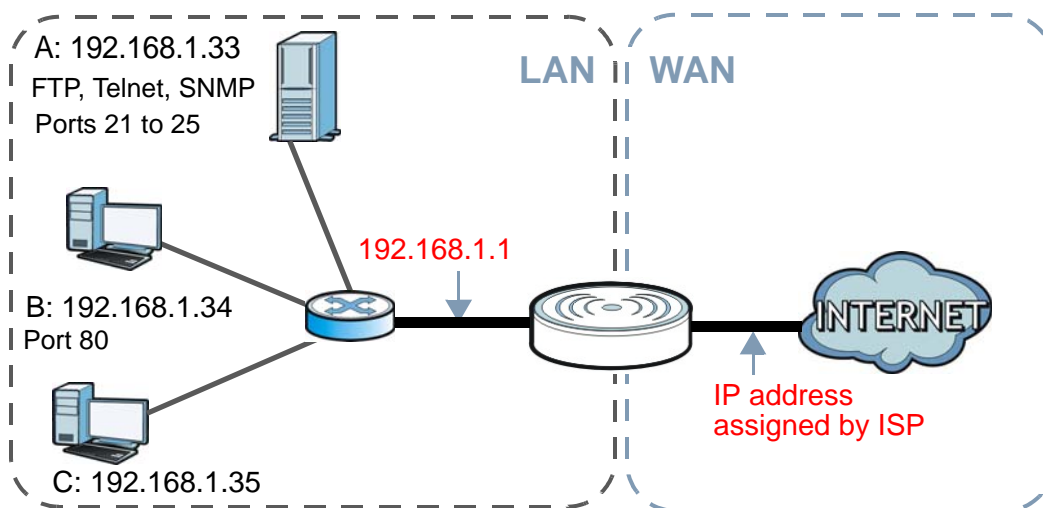

Note: You must create a firewall rule in addition to setting up NAT, to allow traffic from the WAN to be forwarded through the LTE3301.

10.1.1 What You Can Do

- Use the **General** screen to enable NAT ([Section 10.2 on page 88](#)).
- Use the **Port Forwarding** screen to set a default server and change your LTE3301's port forwarding settings to forward incoming service requests to the server(s) on your local network ([Section 10.3 on page 88](#)).
- Use the **Port Trigger** screen to change your LTE3301's trigger port settings ([Section 10.4 on page 91](#)).

- Use the **ALG** screen to enable or disable SIP (VoIP) ALG (Application Layer Gateway) in the LTE3301 (Section 10.5 on page 92).

10.2 General Screen

Use this screen to enable NAT and set a default server. Click **Network > NAT** to open the **General** screen.

Figure 55 Network > NAT > General

The following table describes the labels in this screen.

Table 36 Network > NAT > General

LABEL	DESCRIPTION
Network Address Translation (NAT)	Network Address Translation (NAT) allows the translation of an Internet protocol address used within one network (for example a private IP address used in a local network) to a different IP address known within another network (for example a public IP address used on the Internet). Select Enable to activate NAT. Select Disable to turn it off.
NAT Loopback	NAT loopback allows local users to use a domain name to access a server on the local network. A packet sent to the public (WAN) IP address is always forwarded to the default gateway (the LTE3301). With NAT loopback enabled, the LTE3301 uses the WAN interface's IP address as the packet's source address and treats the packet as if it came from the WAN interface. The packet then can be forwarded to the local server according to the port forwarding rule. Select Enable to activate NAT loopback. Select Disable to turn it off.
Apply	Click Apply to save your changes back to the LTE3301.
Cancel	Click Cancel to begin configuring this screen afresh.

10.3 Port Forwarding Screen

Use this screen to forward incoming service requests to the server(s) on your local network and set a default server. You may enter a single port number or a range of port numbers to be forwarded, and the local IP address of the desired server. The port number identifies a service; for example, web service is on port 80 and FTP on port 21. In some cases, such as for unknown services or where one server can support more than one service (for example both FTP and web service), it might be better to specify a range of port numbers.

In addition to the servers for specified services, NAT supports a default server. A service request that does not have a server explicitly designated for it is forwarded to the default server. If the default is not defined, the service request is simply discarded.

Note: Many residential broadband ISP accounts do not allow you to run any server processes (such as a Web or FTP server) from your location. Your ISP may periodically check for servers and may suspend your account if it discovers any active services at your location. If you are unsure, refer to your ISP.

Port forwarding allows you to define the local servers to which the incoming services will be forwarded. To change your LTE3301's port forwarding settings, click **Network > NAT > Port Forwarding**. The screen appears as shown.

Note: If you do not assign a **Default Server**, the LTE3301 discards all packets received for ports that are not specified in this screen or remote management.

Refer to [Appendix C on page 173](#) for port numbers commonly used for particular services.

Figure 56 Network > NAT > Port Forwarding

The following table describes the labels in this screen.

Table 37 Network > NAT > Port Forwarding

LABEL	DESCRIPTION
Default Server Setup	
Default Server	In addition to the servers for specified services, NAT supports a default server. A default server receives packets from ports that are not specified in the Port Forwarding screen. You can decide whether you want to use the default server or specify a server manually. Select this to use the default server.
Change to Server	Select this and manually enter the server's IP address.
Service Name	Select a pre-defined service from the drop-down list box. The pre-defined service port number(s) and protocol will be displayed in the port forwarding summary table. Otherwise, select User define to manually enter the service name and port number(s) and select the IP protocol.

Table 37 Network > NAT > Port Forwarding (continued)

LABEL	DESCRIPTION
Service Protocol	Select the transport layer protocol supported by this virtual server. Choices are TCP , UDP , or TCP_UDP . If you have chosen a pre-defined service in the Service Name field, the protocol will be configured automatically.
WAN Interface	Select the WAN interface on which the matched packets are received.
Port Range	Specify the first and last external port numbers that identify the service. If you have chosen a pre-defined service in the Service Name field, the port number(s) will be configured automatically.
Translation Port Range	Specify the first and last internal port numbers that identify the service. If you have chosen a pre-defined service in the Service Name field, the port number(s) will be configured automatically.
Server IP Address	Enter the inside IP address of the virtual server here and click Add to add it in the port forwarding summary table.
#	This is the number of an individual port forwarding server entry.
Status	This icon is turned on when the rule is enabled.
Name	This field displays a name to identify this rule.
Protocol	This is the transport layer protocol used for the service.
WAN Interface	This field displays the WAN interface on which the matched packets are received.
Port	This field displays the port number(s).
Port	This field displays the external port number(s) that identifies the service.
Translation Port	This field displays the internal port number(s) that identifies the service.
Server IP Address	This field displays the inside IP address of the server.
Modify	Click the Edit icon to open the edit screen where you can modify an existing rule. Click the Delete icon to remove a rule.
Apply	Click Apply to save your changes back to the LTE3301.
Cancel	Click Cancel to begin configuring this screen afresh.

10.3.1 Port Forwarding Edit Screen

This screen lets you edit a port forwarding rule. Click a rule's **Edit** icon in the **Port Forwarding** screen to open the following screen.

Figure 57 Network > NAT > Port Forwarding Edit

The following table describes the labels in this screen.

Table 38 Network > NAT > Port Forwarding Edit

LABEL	DESCRIPTION
Port Forwarding	Select Enable to turn on this rule and the requested service can be forwarded to the host with a specified internal IP address. Select Disable to disallow forwarding of these ports to an inside server without having to delete the entry.
Service Name	Select User define and type a name (of up to 31 printable characters) to identify this rule in the first field next to Service Name . Otherwise, select a predefined service in the second field next to Service Name . The predefined service name and port number(s) will display in the Service Name and Port Range fields.
Service Protocol	Select the transport layer protocol supported by this virtual server. Choices are TCP , UDP , or TCP_UDP . If you have chosen a pre-defined service in the Service Name field, the protocol will be configured automatically.
WAN Interface	Select the WAN interface on which the matched packets are received.
Port Range	Type a port number(s) to define the service to be forwarded to the specified server. To specify a range of ports, enter the first number and the last number of the range.
Translation Port Range	Enter a port number to which you want the incoming ports translated. For a range of ports, enter the first number and the last number of the range.
Server IP Address	Type the IP address of the server on your LAN that receives packets from the port(s) specified in the Port Range field.
Back	Click Back to return to the previous screen.
Apply	Click Apply to save your changes back to the LTE3301.
Cancel	Click Cancel to begin configuring this screen afresh.

10.4 Port Trigger Screen

To change your LTE3301's trigger port settings, click **Network > NAT > Port Trigger**. The screen appears as shown.

Note: Only one LAN computer can use a trigger port (range) at a time.

Figure 58 Network > NAT > Port Trigger

Application Rules Summary

#	Name	WAN Interface	Incoming Port		Trigger Port
			Start Port	End Port	
1		Default ▼			
2		Default ▼			
3		Default ▼			
4		Default ▼			
5		Default ▼			
6		Default ▼			
7		Default ▼			
8		Default ▼			
9		Default ▼			
10		Default ▼			
11		Default ▼			
12		Default ▼			

Apply Cancel

The following table describes the labels in this screen.

Table 39 Network > NAT > Port Trigger

LABEL	DESCRIPTION
#	This is the rule index number (read-only).
Name	Type a unique name (up to 15 characters) for identification purposes. All characters are permitted - including spaces.
WAN Interface	Select the WAN interface through which the matched packets are transmitted.
Incoming Port	Incoming Port is a port (or a range of ports) that a server on the WAN uses when it sends out a particular service. The LTE3301 forwards the traffic with this port (or range of ports) to the client computer on the LAN that requested the service.
Start Port	Type a port number or the starting port number in a range of port numbers.
End Port	Type a port number or the ending port number in a range of port numbers.
Trigger Port	The trigger port is a port that causes (or triggers) the LTE3301 to record the IP address of the LAN computer that sent the traffic to a server on the WAN.
Apply	Click Apply to save your changes back to the LTE3301.
Cancel	Click Cancel to begin configuring this screen afresh.

10.5 ALG Screen

Some NAT routers may include a SIP Application Layer Gateway (ALG). A SIP ALG allows SIP calls to pass through NAT by examining and translating IP addresses embedded in the data stream. When the LTE3301 registers with the SIP register server, the SIP ALG translates the LTE3301's private IP address inside the SIP data stream to a public IP address. You do not need to use STUN or an outbound proxy if your LTE3301 is behind a SIP ALG.

To enable and disable the SIP ALG in the LTE3301, click **Network > NAT > ALG**. The screen appears as shown.

Figure 59 Network > NAT > ALG

The screenshot shows a web interface with four tabs: 'General', 'Port Forwarding', 'Port Trigger', and 'ALG'. The 'ALG' tab is active. Below the tabs, there is a section labeled 'ALG-SIP' with two radio buttons: 'Enable' (which is selected) and 'Disable'. At the bottom of the screen, there are two buttons: 'Apply' and 'Cancel'.

The following table describes the labels in this screen.

Table 40 Network > NAT > ALG

LABEL	DESCRIPTION
ALG-SIP	Select Enable to make sure SIP (VoIP) works correctly with port-forwarding and address-mapping rules. Otherwise, select Disable to turn off the SIP ALG.
Apply	Click Apply to save your changes back to the LTE3301.
Cancel	Click Cancel to begin configuring this screen afresh.

10.6 Technical Reference

The following section contains additional technical information about the LTE3301 features described in this chapter.

10.6.1 NATPort Forwarding: Services and Port Numbers

A port forwarding set is a list of inside (behind NAT on the LAN) servers, for example, web or FTP, that you can make accessible to the outside world even though NAT makes your whole inside network appear as a single machine to the outside world.

Use the **Port Forwarding** screen to forward incoming service requests to the server(s) on your local network. You may enter a single port number or a range of port numbers to be forwarded, and the local IP address of the desired server. The port number identifies a service; for example, web service is on port 80 and FTP on port 21. In some cases, such as for unknown services or where one server can support more than one service (for example both FTP and web service), it might be better to specify a range of port numbers.

In addition to the servers for specified services, NAT supports a default server. A service request that does not have a server explicitly designated for it is forwarded to the default server. If the default is not defined, the service request is simply discarded.

Note: Many residential broadband ISP accounts do not allow you to run any server processes (such as a Web or FTP server) from your location. Your ISP may periodically check for servers and may suspend your account if it discovers any active services at your location. If you are unsure, refer to your ISP.

10.6.2 NAT Port Forwarding Example

Let's say you want to assign ports 21-25 to one FTP, Telnet and SMTP server (**A** in the example), port 80 to another (**B** in the example) and assign a default server IP address of 192.168.1.35 to a third (**C** in the example). You assign the LAN IP addresses and the ISP assigns the WAN IP address. The NAT network appears as a single host on the Internet.

Figure 60 Multiple Servers Behind NAT Example

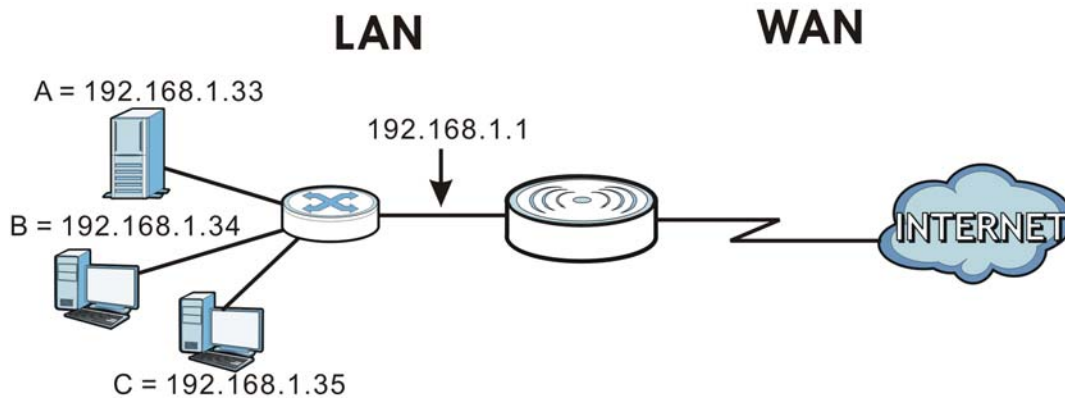

10.6.3 Trigger Port Forwarding

Some services use a dedicated range of ports on the client side and a dedicated range of ports on the server side. With regular port forwarding you set a forwarding port in NAT to forward a service (coming in from the server on the WAN) to the IP address of a computer on the client side (LAN). The problem is that port forwarding only forwards a service to a single LAN IP address. In order to use the same service on a different LAN computer, you have to manually replace the LAN computer's IP address in the forwarding port with another LAN computer's IP address.

Trigger port forwarding solves this problem by allowing computers on the LAN to dynamically take turns using the service. The LTE3301 records the IP address of a LAN computer that sends traffic to the WAN to request a service with a specific port number and protocol (a "trigger" port). When the LTE3301's WAN port receives a response with a specific port number and protocol ("incoming" port), the LTE3301 forwards the traffic to the LAN IP address of the computer that sent the request. After that computer's connection for that service closes, another computer on the LAN can use the service in the same manner. This way you do not need to configure a new IP address each time you want a different LAN computer to use the application.

10.6.4 Trigger Port Forwarding Example

The following is an example of trigger port forwarding.

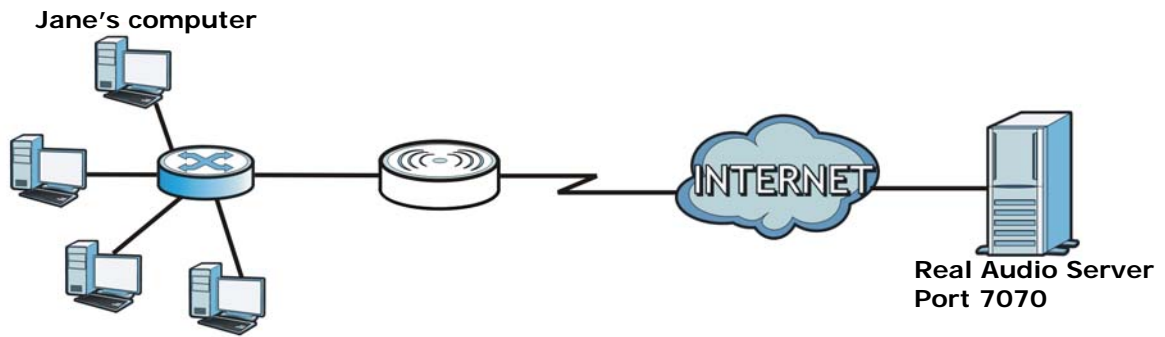
Figure 61 Trigger Port Forwarding Process: Example

- 1 Jane requests a file from the Real Audio server (port 7070).
- 2 Port 7070 is a "trigger" port and causes the LTE3301 to record Jane's computer IP address. The LTE3301 associates Jane's computer IP address with the "incoming" port range of 6970-7170.
- 3 The Real Audio server responds using a port number ranging between 6970-7170.
- 4 The LTE3301 forwards the traffic to Jane's computer IP address.
- 5 Only Jane can connect to the Real Audio server until the connection is closed or times out. The LTE3301 times out in three minutes with UDP (User Datagram Protocol), or two hours with TCP/IP (Transfer Control Protocol/Internet Protocol).

10.6.5 Two Points To Remember About Trigger Ports

- 1 Trigger events only happen on data that is coming from inside the LTE3301 and going to the outside.
- 2 If an application needs a continuous data stream, that port (range) will be tied up so that another computer on the LAN can't trigger it.

CHAPTER 11

DDNS

11.1 Overview

Dynamic Domain Name Service (DDNS) services let you use a fixed domain name with a dynamic IP address. Users can always use the same domain name instead of a different dynamic IP address that changes each time to connect to the LTE3301 or a server in your network.

Note: The LTE3301 must have a public global IP address and you should have your registered DDNS account information on hand.

11.2 General

To change your LTE3301's DDNS, click **Network > DDNS**. The screen appears as shown.

Figure 62 Dynamic DNS

The screenshot shows a web interface for configuring Dynamic DNS. It has a title bar 'Dynamic DNS'. Below it, there are two main sections: 'IPv4 Dynamic DNS Setup' and 'IPv6 Dynamic DNS Setup'. Each section has a 'Dynamic DNS' toggle (radio buttons for 'Enable' and 'Disable'), a 'Service Provider' dropdown menu, and input fields for 'Host Name', 'Username', and 'Password' (for IPv4) or 'Host Name' and 'Token' (for IPv6). At the bottom of the form are 'Apply' and 'Cancel' buttons.

The following table describes the labels in this screen.

Table 41 Dynamic DNS

LABEL	DESCRIPTION
IPv4 Dynamic DNS Setup	
Dynamic DNS	Select Enable to use dynamic DNS. Select Disable to turn this feature off.
Service Provider	Select the name of your Dynamic DNS service provider.

Table 41 Dynamic DNS (continued)

LABEL	DESCRIPTION
Host Name	The host name is the domain name that the DDNS service will map to your dynamic global IP address. Type the host name fully qualified, for example, "yourhost.mydomain.net". You can specify up to two host names in the field separated by a comma (",").
Username	Enter your user name.
Password	Enter the password assigned to you.
IPv6 Dynamic DNS Setup	
Dynamic DNS	Select Enable to use dynamic DNS. Select Disable to turn this feature off.
Service Provider	Select the name of your Dynamic DNS service provider.
Host Name	The host name is the domain name that the DDNS service will map to your dynamic global IP address. Type the host name fully qualified, for example, "yourhost.mydomain.net". You can specify up to two host names in the field separated by a comma (",").
Token	This is the token authentication provided by the hosting provider (i.e. FreeDDNS). When the host name is registered, the hosting server provides the token identifier.
Apply	Click Apply to save your changes back to the LTE3301.
Cancel	Click Cancel to begin configuring this screen afresh.

CHAPTER 12

Routing

12.1 Overview

This chapter shows you how to configure static routes for your LTE3301.

The LTE3301 usually uses the default gateway to route outbound traffic from computers on the LAN to the Internet. To have the LTE3301 send data to devices not reachable through the default gateway, use static routes.

For example, the next figure shows a computer (**A**) connected to the LTE3301's LAN interface. The LTE3301 routes most traffic from **A** to the Internet through the LTE3301's default gateway (**R1**). You create one static route to connect to services offered by your ISP behind router **R2**. You create another static route to communicate with a separate network behind a router **R3** connected to the LAN.

Figure 63 Example of Static Routing Topology

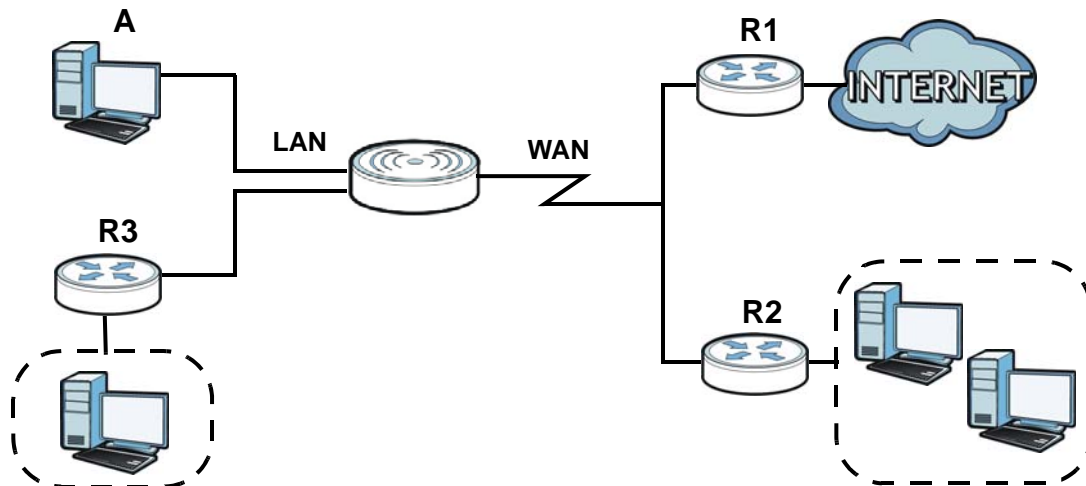

12.2 Static Route Screen

Click **Network > Routing > Static Route** to open the **Static Route** screen.

Figure 64 Network > Routing > Static Route

#	Status	Destination	Subnet Mask	Gateway	Modify
---	--------	-------------	-------------	---------	--------

The following table describes the labels in this screen.

Table 42 Network > Routing > Static Route

LABEL	DESCRIPTION
Add Static Route	Click this to create a new rule.
#	This is the number of an individual static route.
Status	This field indicates whether the rule is active (yellow bulb) or not (gray bulb).
Destination	This parameter specifies the IP network address of the final destination. Routing is always based on network number.
Subnet Mask	This parameter specifies the IP network subnet mask of the final destination.
Gateway	This is the IP address of the gateway. The gateway is a router or switch on the same network segment as the device's LAN or WAN port. The gateway helps forward packets to their destinations.
Modify	Click the Edit icon to open a screen where you can modify an existing rule. Click the Delete icon to remove a rule from the LTE3301.

12.2.1 Add/Edit Static Route

Click the **Add Static Route** button or a rule's **Edit** icon in the **Static Route** screen. Use this screen to configure the required information for a static route.

Figure 65 Network > Routing > Static Route: Add/Edit

The following table describes the labels in this screen.

Table 43 Network > Routing > Static Route: Add/Edit

LABEL	DESCRIPTION
Static Route	Select to enable or disable this rule.
Destination IP Address	This parameter specifies the IP network address of the final destination. Routing is always based on network number. If you need to specify a route to a single host, use a subnet mask of 255.255.255.255 in the subnet mask field to force the network number to be identical to the host ID.

Table 43 Network > Routing > Static Route: Add/Edit

LABEL	DESCRIPTION
IP Subnet Mask	Enter the IP subnet mask here.
Gateway IP Address	Enter the IP address of the next-hop gateway. The gateway is a router or switch on the same segment as your LTE3301's interface(s). The gateway helps forward packets to their destinations.
Back	Click Back to return to the previous screen without saving.
Apply	Click Apply to save your changes back to the LTE3301.
Cancel	Click Cancel to set every field in this screen to its last-saved value.

12.3 Dynamic Routing Screen

Use this screen to enable and configure RIP on the LTE3301. Click **Network > Routing > Dynamic Routing** to open the **Dynamic Routing** screen.

Figure 66 Network > Routing > Dynamic Routing

The following table describes the labels in this screen.

Table 44 Network > Routing > Dynamic Routing

LABEL	DESCRIPTION
Dynamic Routing	RIP (Routing Information Protocol) allows a router to exchange routing information with other routers. The RIP version controls the format and the broadcasting method of the RIP packets that the LTE3301 sends (it recognizes both formats when receiving). RIP version 1 is universally supported but RIP version 2 carries more information. RIP version 1 is probably adequate for most networks, unless you have an unusual network topology. Select the RIP version from RIPv1 and RIPv2 . Otherwise, select Disable to turn it off.
Apply	Click Apply to save your changes back to the LTE3301.
Cancel	Click Cancel to begin configuring this screen afresh.

CHAPTER 13

Interface Group

13.1 Overview

By default, the four LAN interfaces on the LTE3301 are in the same group and can communicate with each other. Creating a new interface will create a new LAN bridge interface (subnet) (for example, 192.168.2.0/24) that acts as a dependent LAN network, and is a different subnet from default LAN subnet (192.168.1.0/24).

13.2 Interface Group Screen

You can manually add a LAN/WLAN interface to a new group.

Use the **DHCP** screen to configure the private IP addresses the DHCP server on the LTE3301 assigns to the clients in the default and/or user-defined groups. See [Chapter 9 on page 82](#) for more information.

Use the **Interface Group** screen to create a new interface group, which is a new LAN bridge interface (subnet). Click **Network > Interface Group** to open the following screen.

Figure 67 Network > Interface Group

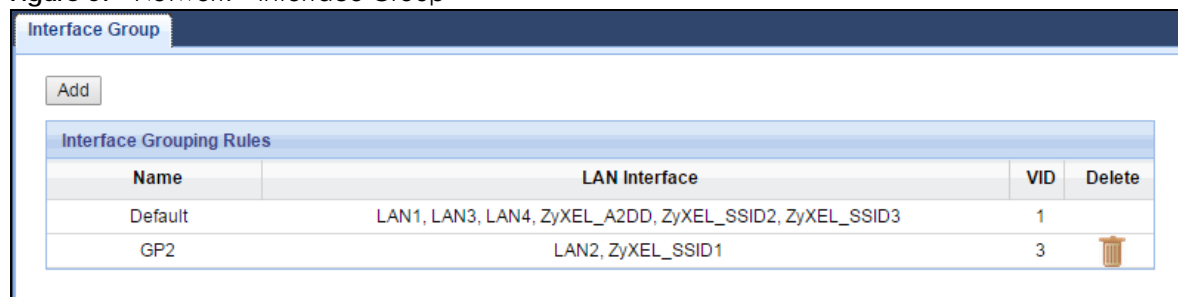

The following table describes the fields in this screen.

Table 45 Network > Interface Group

LABEL	DESCRIPTION
Add	Click this button to create a new interface group.
Name	This shows the descriptive name of the group.
LAN Interface	This shows the interface group.
VID	This shows the VLAN ID number (from 0 to 4094) of the interface group.
Modify	Click the Delete icon to remove the user-defined group.

13.2.1 Interface Group > Add Screen

Click the **Add** button in the **Interface Group** screen to open the following screen. Use this screen to create a new interface group.

Note: An interface can belong to only one group at a time.

Figure 68 Network > Interface Group > Add

The following table describes the fields in this screen.

Table 46 Network > Interface Group > Add

LABEL	DESCRIPTION
Group Name	Enter a name to identify this group. You can enter up to 30 characters. You can use letters, numbers, hyphens (-) and underscores (_). Spaces are not allowed.
Enable Tx TAG	Click the check box to set the port to tag or not to tag all outgoing traffic with the VLAN ID.
VID	This shows the VLAN ID number (from 0 to 4094) for traffic through the interfaces in this group. This field is not configurable and the VLAN ID is assigned automatically by the system.
Grouped LAN Interfaces	This shows the LAN port(s) or WLAN interface(s) as a member of the VLAN interface group. Select any interfaces that you don't want and click the right arrow button to remove them from this group.
Available LAN Interfaces	This shows the available LAN interface(s) (Ethernet LAN or Wireless LAN) that can be selected to form a VLAN interface group. Select the interfaces that you want and click the left arrow button to add them to this group.
Back	Click Back to quit and return to the previous screen.
Apply	Click Apply to save your changes back to the LTE3301.
Cancel	Click Cancel to exit this screen without saving.

CHAPTER 14

Firewall

14.1 Overview

Use these screens to enable and configure the firewall that protects your LTE3301 and your LAN from unwanted or malicious traffic.

Enable the firewall to protect your LAN computers from attacks by hackers on the Internet and control access between the LAN and WAN. By default the firewall:

- allows traffic that originates from your LAN computers to go to all of the networks.
- blocks traffic that originates on the other networks from going to the LAN.

The following figure illustrates the default firewall action. User **A** can initiate an IM (Instant Messaging) session from the LAN to the WAN (1). Return traffic for this session is also allowed (2). However other traffic initiated from the WAN is blocked (3 and 4).

Figure 69 Default Firewall Action

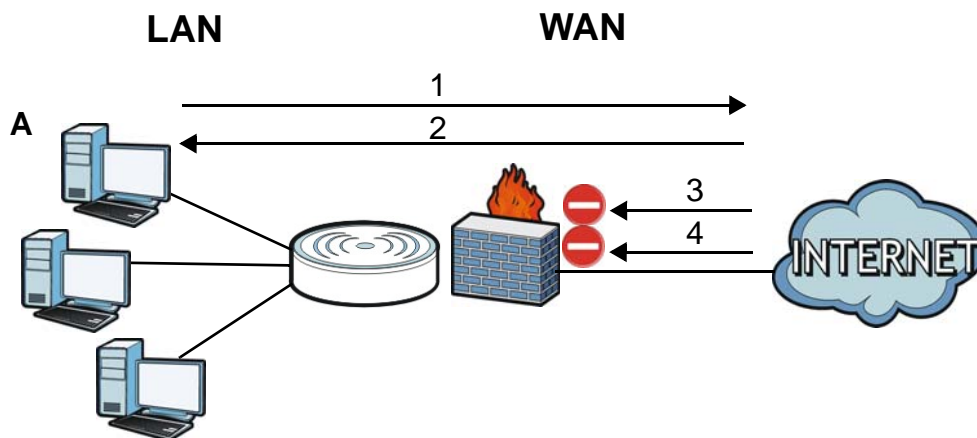

14.1.1 What You Can Do

- Use the **General** screen to enable or disable the LTE3301's firewall ([Section 14.2 on page 104](#)).
- Use the **Services** screen enable service blocking, enter/delete/modify the services you want to block and the date/time you want to block them ([Section 14.3 on page 105](#)).

14.1.2 What You Need To Know

The following terms and concepts may help as you read through this chapter.

About the LTE3301 Firewall

The LTE3301's firewall feature physically separates the LAN and the WAN and acts as a secure gateway for all data passing between the networks.

It is a stateful inspection firewall and is designed to protect against Denial of Service attacks when activated (click the **General** tab under **Firewall** and then click the **Enable Firewall** check box). The LTE3301's purpose is to allow a private Local Area Network (LAN) to be securely connected to the Internet. The LTE3301 can be used to prevent theft, destruction and modification of data, as well as log events, which may be important to the security of your network.

The LTE3301 is installed between the LAN and a broadband modem connecting to the Internet. This allows it to act as a secure gateway for all data passing between the Internet and the LAN.

The LTE3301 has one Ethernet WAN port and four Ethernet LAN ports, which are used to physically separate the network into two areas. The WAN (Wide Area Network) port attaches to the broadband (cable or DSL) modem to the Internet.

The LAN (Local Area Network) port attaches to a network of computers, which needs security from the outside world. These computers will have access to Internet services such as e-mail, FTP and the World Wide Web. However, "inbound access" is not allowed (by default) unless the remote host is authorized to use a specific service.

Guidelines For Enhancing Security With Your Firewall

- 1 Change the default password via Web Configurator.
- 2 Think about access control before you connect to the network in any way, including attaching a modem to the port.
- 3 Limit who can access your router.
- 4 Don't enable any local service (such as NTP) that you don't use. Any enabled service could present a potential security risk. A determined hacker might be able to find creative ways to misuse the enabled services to access the firewall or the network.
- 5 For local services that are enabled, protect against misuse. Protect by configuring the services to communicate only with specific peers, and protect by configuring rules to block packets for the services at specific interfaces.
- 6 Protect against IP spoofing by making sure the firewall is active.
- 7 Keep the firewall in a secured (locked) room.

14.2 General Screen

Use this screen to enable or disable the LTE3301's firewall, and set up firewall logs. Click **Security > Firewall** to open the **General** screen.

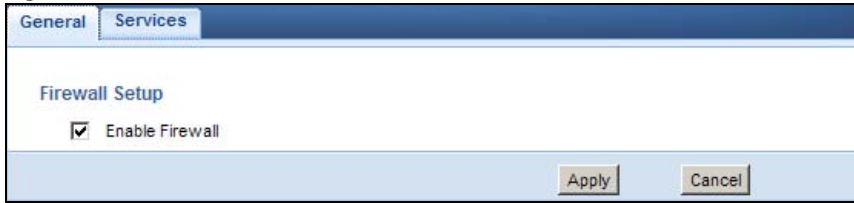
Figure 70 Security > Firewall > General I

The following table describes the labels in this screen.

Table 47 Security > Firewall > General

LABEL	DESCRIPTION
Enable Firewall	Select this check box to activate the firewall. The LTE3301 performs access control and protects against Denial of Service (DoS) attacks when the firewall is activated.
Apply	Click Apply to save the settings.
Cancel	Click Cancel to start configuring this screen again.

14.3 Services Screen

If an outside user attempts to probe an unsupported port on your LTE3301, an ICMP response packet is automatically returned. This allows the outside user to know the LTE3301 exists. Use this screen to prevent the ICMP response packet from being sent. This keeps outsiders from discovering your LTE3301 when unsupported ports are probed.

You can also use this screen to enable service blocking, enter/delete/modify the services you want to block and the date/time you want to block them.

Click **Security > Firewall > Services**. The screen appears as shown next.

Figure 71 Security > Firewall > Services I

The following table describes the labels in this screen.

Table 48 Security > Firewall > Services

LABEL	DESCRIPTION
ICMP	Internet Control Message Protocol is a message control and error-reporting protocol between a host server and a gateway to the Internet. ICMP uses Internet Protocol (IP) datagrams, but the messages are processed by the TCP/IP software and directly apparent to the application user.
Respond to Ping on	The LTE3301 will not respond to any incoming Ping requests when Disable is selected. Select LAN to reply to incoming LAN Ping requests. Select WAN to reply to incoming WAN Ping requests. Otherwise select LAN&WAN to reply to all incoming LAN and WAN Ping requests.
Apply	Click Apply to save the settings.
WAN Stealth Mode	
Enable WAN Stealth Mode	Select this check box to silently discard the matched packets without sending a TCP reset packet or an ICMP destination-unreachable message to the sender.
Apply	Click Apply to save the settings.
Enable Firewall Rule	
Enable Firewall Rule	Select this check box to activate the firewall rules that you define (see Add Firewall Rule below).
Apply	Click Apply to save the settings.
Add Firewall Rule	
Service Name	Enter a name that identifies or describes the firewall rule.
MAC Address	Enter the MAC address of the computer for which the firewall rule applies.
Dest IP Address	Enter the IP address of the computer to which traffic for the application or service is entering. The LTE3301 applies the firewall rule to traffic initiating from this computer.

Table 48 Security > Firewall > Services (continued)

LABEL	DESCRIPTION
Source IP Address	Enter the IP address of the computer that initializes traffic for the application or service. The LTE3301 applies the firewall rule to traffic initiating from this computer.
Protocol	Select the protocol (TCP , UDP or ICMP) used to transport the packets for which you want to apply the firewall rule.
Dest Port Range	Enter the port number/range of the destination that define the traffic type, for example TCP port 80 defines web traffic.
Source Port Range	Enter the port number/range of the source that define the traffic type, for example TCP port 80 defines web traffic.
Add Rule	Click Add to save the firewall rule.
Firewall Rule	
#	This is your firewall rule number. The ordering of your rules is important as rules are applied in turn.
Service Name	This is a name that identifies or describes the firewall rule.
MAC address	This is the MAC address of the computer for which the firewall rule applies.
Dest IP	This is the IP address of the computer to which traffic for the application or service is entering.
Source IP	This is the IP address of the computer from which traffic for the application or service is initialized.
Protocol	This is the protocol (TCP , UDP or ICMP) used to transport the packets for which you want to apply the firewall rule.
Dest Port Range	This is the port number/range of the destination that define the traffic type, for example TCP port 80 defines web traffic.
Source Port Range	This is the port number/range of the source that define the traffic type, for example TCP port 80 defines web traffic.
Action	DROP - Traffic matching the conditions of the firewall rule are stopped.
Delete	Click Delete to remove the firewall rule.
Cancel	Click Cancel to start configuring this screen again.

See [Appendix C on page 173](#) for commonly used services and port numbers.

CHAPTER 15

Content Filtering

15.1 Overview

This chapter shows you how to configure content filtering. Content filtering is the ability to block certain web features and specific URLs.

Keyword Blocking URL Checking

The LTE3301 checks the URL's domain name (or IP address) and file path separately when performing keyword blocking.

The URL's domain name or IP address is the characters that come before the first slash in the URL. For example, with the URL www.zyxel.com.tw/news/pressroom.php, the domain name is www.zyxel.com.tw.

The file path is the characters that come after the first slash in the URL. For example, with the URL www.zyxel.com.tw/news/pressroom.php, the file path is [news/pressroom.php](http://www.zyxel.com.tw/news/pressroom.php).

Since the LTE3301 checks the URL's domain name (or IP address) and file path separately, it will not find items that go across the two. For example, with the URL www.zyxel.com.tw/news/pressroom.php, the LTE3301 would find "tw" in the domain name (www.zyxel.com.tw). It would also find "news" in the file path ([news/pressroom.php](http://www.zyxel.com.tw/news/pressroom.php)) but it would not find "tw/news".

15.2 Content Filter

Use this screen to restrict web features, and designate a trusted computer. You can also use this screen to configure URL filtering settings to block the users on your network from accessing certain web sites. Click **Security > Content Filter** to open the **Content Filter** screen.

Figure 72 Security > Content Filter

The following table describes the labels in this screen.

Table 49 Security > Content Filter

LABEL	DESCRIPTION
Trusted IP Setup	To enable this feature, type an IP address of any one of the computers in your network that you want to have as a trusted computer. This allows the trusted computer to have full access to all features that are configured to be blocked by content filtering. Leave this field blank to have no trusted computers.
Restrict Web Features	Select the box(es) to restrict a feature. When you download a page containing a restricted feature, that part of the web page will appear blank or grayed out.
ActiveX	A tool for building dynamic and active Web pages and distributed object applications. When you visit an ActiveX Web site, ActiveX controls are downloaded to your browser, where they remain in case you visit the site again.
Java	A programming language and development environment for building downloadable Web components or Internet and intranet business applications of all kinds.
Cookies	Used by Web servers to track usage and provide service based on ID.
Web Proxy	A server that acts as an intermediary between a user and the Internet to provide security, administrative control, and caching service. When a proxy server is located on the WAN it is possible for LAN users to circumvent content filtering by pointing to this proxy server.
Enable URL Keyword Blocking	The LTE3301 can block Web sites with URLs that contain certain keywords in the domain name or IP address. For example, if the keyword "bad" was enabled, all sites containing this keyword in the domain name or IP address will be blocked, e.g., URL <code>http://www.website.com/bad.html</code> would be blocked. Select this check box to enable this feature.
Keyword	Type a keyword in this field. You may use any character (up to 64 characters). Wildcards are not allowed. You can also enter a numerical IP address.
Keyword List	This list displays the keywords already added.

Table 49 Security > Content Filter (continued)

LABEL	DESCRIPTION
Add	<p>Click Add after you have typed a keyword.</p> <p>Repeat this procedure to add other keywords. Up to 64 keywords are allowed.</p> <p>When you try to access a web page containing a keyword, you will get a message telling you that the content filter is blocking this request.</p>
Delete	<p>Highlight a keyword in the lower box and click Delete to remove it. The keyword disappears from the text box after you click Apply.</p>
Clear All	<p>Click this button to remove all of the listed keywords.</p>
Apply	<p>Click Apply to save your changes.</p>
Reset	<p>Click Reset to begin configuring this screen afresh</p>

CHAPTER 16

IPv6 Firewall

16.1 Overview

This chapter shows you how to enable and create IPv6 firewall rules to block unwanted IPv6 traffic.

16.2 IPv6 Firewall Screen

Click **Configuration > Security > IPv6 Firewall**. The **Service** screen appears as shown.

Figure 73 Configuration > Security > IPv6 Firewall

The following table describes the labels in this screen.

Table 50 Configuration > Security > IPv6 Firewall

LABEL	DESCRIPTION
Enable Firewall Rule	
Enable Firewall Rule	Select this check box to activate the firewall rules that you define (see Add Firewall Rule below).
Apply	Click Apply to save the settings.
Add Firewall Rule	
Service Name	Enter a name that identifies or describes the firewall rule.
MAC Address	Enter the MAC address of the computer for which the firewall rule applies.

Table 50 Configuration > Security > IPv6 Firewall (continued)

LABEL	DESCRIPTION
Dest IP Address	Enter the IPv6 address of the computer to which traffic for the application or service is entering. The LTE3301 applies the firewall rule to traffic destined for this computer.
Source IP Address	Enter the IPv6 address of the computer that initializes traffic for the application or service. The LTE3301 applies the firewall rule to traffic initiating from this computer.
Protocol	Select the protocol (TCP , UDP or ICMP) used to transport the packets for which you want to apply the firewall rule.
Dest Port Range	Enter the port number/range of the destination that defines the traffic type, for example TCP port 80 defines web traffic.
Source Port Range	Enter the port number/range of the source that defines the traffic type, for example TCP port 80 defines web traffic.
Add Rule	Click Add Rule to save the firewall rule.
Firewall Rule	
#	This is your firewall rule number. The ordering of your rules is important as rules are applied in turn.
ServiceName	This is a name that identifies or describes the firewall rule.
MACAddress	This is the MAC address of the computer for which the firewall rule applies.
DestIP	This is the IP address of the computer to which traffic for the application or service is entering.
SourceIP	This is the IP address of the computer to which traffic for the application or service is initialized.
Protocol	This is the protocol (TCP , UDP or ICMP) used to transport the packets for which you want to apply the firewall rule.
DestPortRange	This is the port number/range of the destination that defines the traffic type, for example TCP port 80 defines web traffic.
SourcePortRange	This is the port number/range of the source that defines the traffic type, for example TCP port 80 defines web traffic.
Action	DROP - Traffic matching the conditions of the firewall rule is stopped.
Delete	Click Delete to remove the firewall rule.
Cancel	Click Cancel to restore your previously saved settings.

CHAPTER 17

Bandwidth Management

17.1 Overview

This chapter contains information about configuring bandwidth management and editing rules.

ZyXEL's Bandwidth Management allows you to specify bandwidth management rules based on an application.

In the figure below, uplink traffic goes from the LAN device (A) to the WAN device (B). Bandwidth management is applied before sending the packets out to the WAN. Downlink traffic comes back from the WAN device (B) to the LAN device (A). Bandwidth management is applied before sending the traffic out to LAN.

Figure 74 Bandwidth Management Example

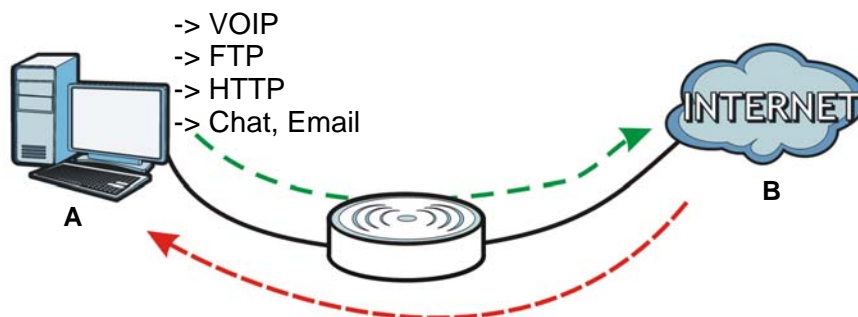

You can allocate specific amounts of bandwidth capacity (bandwidth budgets) to individual applications (like VoIP, Web, FTP, and E-mail for example).

17.2 What You Can Do

- Use the **General** screen to enable bandwidth management and assign bandwidth values ([Section 17.4 on page 114](#)).
- Use the **Advanced** screen to configure bandwidth managements rule for the services and applications ([Section 17.5 on page 114](#)).

17.3 What You Need To Know

The sum of the bandwidth allotments that apply to the WAN interface (LAN to WAN, WLAN to WAN) must be less than or equal to the upstream bandwidth that you configure in the **Bandwidth Management > General** screen ([Section 17.5 on page 114](#)).

The sum of the bandwidth allotments that apply to the LAN interface (WAN to LAN, WAN to WLAN) must be less than or equal to the downstream bandwidth that you configure in the **Bandwidth Management > General** screen [Section 17.5 on page 114](#).

17.4 General Screen

Use this screen to have the LTE3301 apply bandwidth management.

Click **Management > Bandwidth MGMT** to open the bandwidth management **General** screen.

Figure 75 Management > Bandwidth Management > General

The following table describes the labels in this screen.

Table 51 Management > Bandwidth Management > General

LABEL	DESCRIPTION
Enable Bandwidth Management	This field allows you to have LTE3301 apply bandwidth management. Enable bandwidth management to give traffic that matches a bandwidth rule priority over traffic that does not match a bandwidth rule. Enabling bandwidth management also allows you to control the maximum or minimum amounts of bandwidth that can be used by traffic that matches a bandwidth rule.
Bandwidth of Upstream	Specify the total amount of bandwidth that you want to dedicate to uplink traffic. The recommendation is to set this to match the actual upstream data rate. This is traffic from LAN/WLAN to WAN.
Bandwidth of Downstream	Specify the total amount of bandwidth that you want to dedicate to downlink traffic. The recommendation is to set this to match the actual downstream data rate. This is traffic from WAN to LAN/WLAN.
Flexible Bandwidth Management	Select Enable to use up to 100% of the configured bandwidth. If you select Disable , you can only use up to 33% of the configured bandwidth.
Apply	Click Apply to save your customized settings.
Cancel	Click Cancel to begin configuring this screen afresh.

17.5 Advanced Screen

Use this screen to configure bandwidth management rules for the pre-defined services or applications.

You can also use this screen to configure bandwidth management rule for other services or applications that are not on the pre-defined list of LTE3301. Additionally, you can define the IP addresses and port for a service or application.

Click **Management > Bandwidth MGMT > Advanced** to open the bandwidth management **Advanced** screen.

Figure 76 Management > Bandwidth Management > Advanced

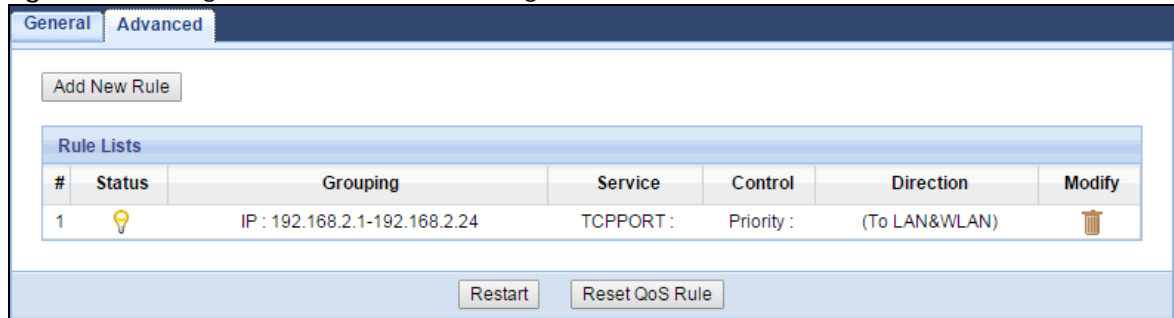

The following table describes the labels in this screen.

Table 52 Management > Bandwidth Management > Advanced

LABEL	DESCRIPTION
Add New Rule	Click this to open a screen where you can create a new bandwidth management rule for a service or application.
#	This is the number of an individual bandwidth management rule.
Status	This field indicates whether the rule is active (yellow bulb) or not (gray bulb).
Grouping	This field displays the IP address or a range of IP addresses of the destination computer for whom this rule applies.
Service	This field displays the protocol and port used for the service.
Control	This field displays whether the maximum/minimum bandwidth allowed or a priority level is specified in the rule.
Direction	These read-only labels represent the physical interfaces. Bandwidth management applies to all traffic flowing out of the router through the interface, regardless of the traffic's source.
Modify	Click the remove icon to delete the rule.
Restart	Click this button to begin configuring this screen afresh.
Reset QoS Rule	Click this button to remove all bandwidth management rules.

17.5.1 Add Bandwidth management Rule

If you want to create a new bandwidth management rule for a service or application, click the **Add New Rule** icon in the **Advanced** screen. The following screen displays.

Figure 77 Bandwidth Management Rule Configuration: Application List

Rule :	<input type="radio"/> Enable <input checked="" type="radio"/> Disable
IP Address :	<input type="text"/> - <input type="text"/>
Service :	Pre-defined Application profiles ▼
	Service Type POP3(TCP:110) ▼
Control :	Maximum Bandwidth ▼ <input type="text"/>
Direction :	To LAN&WLAN ▼
Sharing Method :	Grouping ▼
<input type="button" value="Apply"/> <input type="button" value="Cancel"/>	

The following table describes the labels in this screen.

Table 53 Bandwidth Management Rule Configuration: Application List

LABEL	DESCRIPTION
Rule	Select Enable to turn on the bandwidth management rule. Otherwise, select Disable .
IP Address	Enter the IP address or a range of IP addresses of the destination computer for whom this rule applies.
Service	Select Service Port and manually enter the port number(s) that defines the traffic type, for example TCP port 80 defines web traffic. Select Pre-defined Application profiles to configure a bandwidth management rule for a pre-defined service or application.
Protocol	If you set Service to Service Port , select the protocol (TCP , or UDP) used for the service.
Service Type	If you set Service to Pre-defined Application profiles , select the name of the service to which the LTE3301 applies the bandwidth management rule.
Control	Select Maximum Bandwidth or Minimum Bandwidth and specify the maximum or minimum bandwidth allowed for the rule in KBps (kilobytes per second) or MBps (megabytes per second). Otherwise, select Priority and enter a priority level (from 1 to 7) for traffic that matches this rule.
Direction	Select To LAN&WLAN to apply the rule to traffic from WAN to LAN and WLAN. Select To WAN to apply the rule to traffic from LAN/WLAN to WAN. Select Both to apply the rule to traffic traveling in either direction.
Sharing Method	This field is available only when you set Control to Maximum Bandwidth or Minimum Bandwidth . Select Grouping to Select Single to
Apply	Click Apply to save your customized settings.
Cancel	Click Cancel to exit this screen without saving.

See [Appendix C on page 173](#) for commonly used services and port numbers.

CHAPTER 18

Universal Plug-and-Play (UPnP)

18.1 Overview

This chapter introduces the UPnP feature in the web configurator.

Universal Plug and Play (UPnP) is a distributed, open networking standard that uses TCP/IP for simple peer-to-peer network connectivity between devices. A UPnP device can dynamically join a network, obtain an IP address, convey its capabilities and learn about other devices on the network. In turn, a device can leave a network smoothly and automatically when it is no longer in use.

18.2 What You Need to Know

UPnP hardware is identified as an icon in the Network Connections folder (Windows XP). Each UPnP compatible device installed on your network will appear as a separate icon. Selecting the icon of a UPnP device will allow you to access the information and properties of that device.

18.2.1 NAT Traversal

UPnP NAT traversal automates the process of allowing an application to operate through NAT. UPnP network devices can automatically configure network addressing, announce their presence in the network to other UPnP devices and enable exchange of simple product and service descriptions. NAT traversal allows the following:

- Dynamic port mapping
- Learning public IP addresses
- Assigning lease times to mappings

Windows Messenger is an example of an application that supports NAT traversal and UPnP.

See the NAT chapter for more information on NAT.

18.2.2 Cautions with UPnP

The automated nature of NAT traversal applications in establishing their own services and opening firewall ports may present network security issues. Network information and configuration may also be obtained and modified by users in some network environments.

When a UPnP device joins a network, it announces its presence with a multicast message. For security reasons, the LTE3301 allows multicast messages on the LAN only.

All UPnP-enabled devices may communicate freely with each other without additional configuration. Disable UPnP if this is not your intention.

18.3 UPnP Screen

Use this screen to enable UPnP on your LTE3301.

Click **Management > UPnP** to display the screen shown next.

Figure 78 Management > UPnP

The following table describes the fields in this screen.

Table 54 Management > UPnP

LABEL	DESCRIPTION
UPnP	Select Enable to activate UPnP. Be aware that anyone could use a UPnP application to open the web configurator's login screen without entering the LTE3301's IP address (although you must still enter the password to access the web configurator).
Apply	Click Apply to save the setting to the LTE3301.
Cancel	Click Cancel to return to the previously saved settings.

18.4 Technical Reference

The sections show examples of using UPnP.

18.4.1 Using UPnP in Windows XP Example

This section shows you how to use the UPnP feature in Windows XP. You must already have UPnP installed in Windows XP and UPnP activated on the LTE3301.

Make sure the computer is connected to a LAN port of the LTE3301. Turn on your computer and the LTE3301.

18.4.1.1 Auto-discover Your UPnP-enabled Network Device

- 1 Click **start** and **Control Panel**. Double-click **Network Connections**. An icon displays under Internet Gateway.
- 2 Right-click the icon and select **Properties**.

Figure 79 Network Connections



- 3 In the **Internet Connection Properties** window, click **Settings** to see the port mappings there were automatically created.

Figure 80 Internet Connection Properties



- 4 You may edit or delete the port mappings or click **Add** to manually add port mappings.

Figure 81 Internet Connection Properties: Advanced Settings

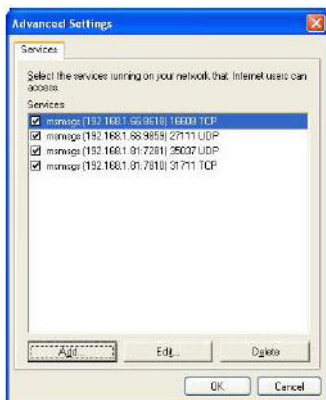
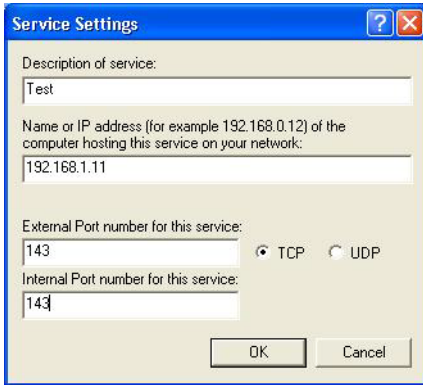
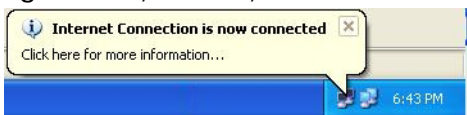

Figure 82 Internet Connection Properties: Advanced Settings: Add

Note: When the UPnP-enabled device is disconnected from your computer, all port mappings will be deleted automatically.

- 5 Select **Show icon in notification area when connected** option and click **OK**. An icon displays in the system tray.

Figure 83 System Tray Icon

- 6 Double-click on the icon to display your current Internet connection status.

Figure 84 Internet Connection Status

18.4.2 Web Configurator Easy Access

With UPnP, you can access the web-based configurator on the LTE3301 without finding out the IP address of the LTE3301 first. This comes helpful if you do not know the IP address of the LTE3301.

Follow the steps below to access the web configurator.

- 1 Click **Start** and then **Control Panel**.
- 2 Double-click **Network Connections**.

- 3 Select **My Network Places** under **Other Places**.

Figure 85 Network Connections



- 4 An icon with the description for each UPnP-enabled device displays under **Local Network**.
- 5 Right-click on the icon for your LTE3301 and select **Invoke**. The web configurator login screen displays.

Figure 86 Network Connections: My Network Places



- 6 Right-click on the icon for your LTE3301 and select **Properties**. A properties window displays with basic information about the LTE3301.

Figure 87 Network Connections: My Network Places: Properties: Example



CHAPTER 19

TR-069

19.1 Overview

This chapter explains how to configure the LTE3301's TR-069 auto-configuration settings.

19.2 TR-069 Screen

TR-069 defines how Customer Premise Equipment (CPE), for example your LTE3301, can be managed over the WAN by an Auto Configuration Server (ACS). TR-069 is based on sending Remote Procedure Calls (RPCs) between an ACS and a client device. RPCs are sent in Extensible Markup Language (XML) format over HTTP or HTTPS.

An administrator can use an ACS to remotely set up the LTE3301, modify settings, perform firmware upgrades as well as monitor and diagnose the LTE3301. You have to enable the device to be managed by the ACS and specify the ACS IP address or domain name and username and password.

Click **Management > TR-069** to open the following screen. Use this screen to configure your LTE3301 to be managed by an ACS.

Figure 88 Management > TR-069

The screenshot shows the TR-069 configuration interface. It includes the following fields and controls:

- Inform :** Radio buttons for Enable and Disable.
- Inform Interval :** Text input field containing the value 900.
- ACS URL :** Text input field.
- ACS Username :** Text input field.
- ACS Password :** Text input field.
- ConnectionRequest Port :** Text input field containing the value 8099.
- Connection Request Username :** Text input field.
- Connection Request Password :** Text input field.
- Interface :** Dropdown menu currently set to WAN.
- Buttons:** Apply and Cancel buttons at the bottom.

The following table describes the fields in this screen.

Table 55 Maintenance > TR-069 Client

LABEL	DESCRIPTION
Inform	Select Enable for the LTE3301 to send periodic inform via TR-069 on the WAN. Otherwise, select Disable .
Inform Interval	Enter the time interval (in seconds) at which the LTE3301 sends information to the auto-configuration server.
ACS URL	Enter the URL or IP address of the auto-configuration server.
ACS User Name	Enter the TR-069 user name for authentication with the auto-configuration server.
ACS Password	Enter the TR-069 password for authentication with the auto-configuration server.
Connection Request Port	Enter the port number for TR-069 connection requests.
Connection Request User Name	Enter the connection request user name. When the ACS makes a connection request to the LTE3301, this user name is used to authenticate the ACS.
Connection Request Password	Enter the connection request password. When the ACS makes a connection request to the LTE3301, this password is used to authenticate the ACS.
Interface	Select a WAN interface through which the TR-069 traffic passes.
Apply	Click Apply to save your changes.
Cancel	Click Cancel to exit this screen without saving.

CHAPTER 20

Maintenance

20.1 Overview

This chapter provides information on the **Maintenance** screens.

20.2 What You Can Do

- Use the **General** screen to set the timeout period of the management session ([Section 20.3 on page 125](#)).
- Use the **Account** screen to change your LTE3301's system password ([Section 20.4 on page 126](#)).
- Use the **Time** screen to change your LTE3301's time and date ([Section 20.5 on page 127](#)).
- Use the **Firmware Upgrade** screen to upload firmware to your LTE3301 ([Section 20.6 on page 129](#)).
- Use the **Backup/Restore** screen to view information related to factory defaults, backup configuration, and restoring configuration ([Section 20.7 on page 130](#)).
- Use the **Restart** screen to reboot the LTE3301 without turning the power off ([Section 20.8 on page 132](#)).

20.3 General Screen

Use this screen to set the management session timeout period. Click **Maintenance > General**. The following screen displays.

Figure 89 Maintenance > General

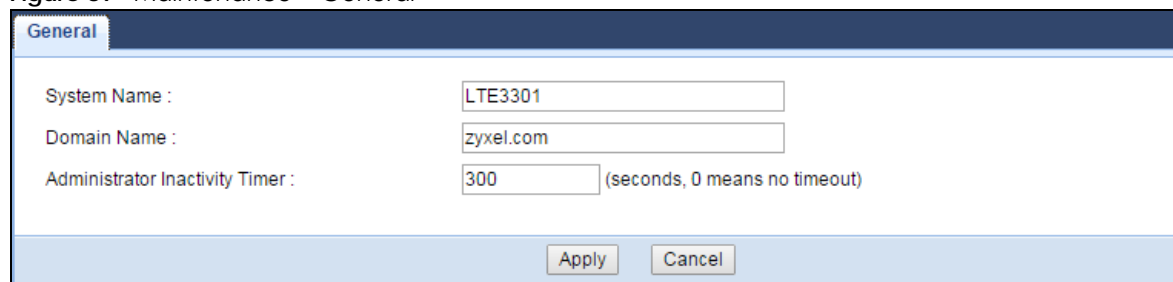

The screenshot shows the 'General' configuration screen. It has a dark blue header with the word 'General' in white. Below the header, there are three rows of configuration fields. The first row is 'System Name' with a text input field containing 'LTE3301'. The second row is 'Domain Name' with a text input field containing 'zyxel.com'. The third row is 'Administrator Inactivity Timer' with a numeric input field containing '300' and a label '(seconds, 0 means no timeout)'. At the bottom of the screen, there are two buttons: 'Apply' and 'Cancel'.

The following table describes the labels in this screen.

Table 56 Maintenance > General

LABEL	DESCRIPTION
System Name	System Name is a unique name to identify the LTE3301 in an Ethernet network.
Domain Name	Enter the domain name you want to give to the LTE3301.

Table 56 Maintenance > General (continued)

LABEL	DESCRIPTION
Administrator Inactivity Timer	Type how many minutes a management session can be left idle before the session times out. The default is 300 seconds. After it times out you have to log in with your password again. Very long idle timeouts may have security risks. A value of "0" means a management session never times out, no matter how long it has been left idle (not recommended).
Apply	Click Apply to save your changes back to the LTE3301.
Cancel	Click Cancel to begin configuring this screen afresh.

20.4 Account Screen

It is strongly recommended that you change your LTE3301's system password.

If you forget your LTE3301's password (or IP address), you will need to reset the device. See [Section 20.8 on page 132](#) for details.

Click **Account > Account**. The screen appears as shown.

Figure 90 Maintenance > Account

The screenshot shows a web interface titled "User Account". Below the title is a table labeled "User Account Entries". The table has four columns: "#", "User Name", "Group", and "Modify". There is one row of data with the following values: "# 1", "User Name admin", "Group User", and "Modify" (represented by a pencil icon).

#	User Name	Group	Modify
1	admin	User	

The following table describes the labels in this screen.

Table 57 Maintenance > Account

LABEL	DESCRIPTION
#	This is the index number of the entry.
User Name	This field displays the name of the user.
Group	This field displays the login account type of the user.
Modify	Click the Edit icon to edit this user account.

20.4.1 Edit a User Account

Use this screen to edit a users account. Click the **Edit** icon next to the user account you want to configure. The screen shown next appears.

Figure 91 Maintenance > Account > Edit

The screenshot shows a web interface titled "Account Setup". It contains the following fields and controls:

- Username :** A text input field containing the value "admin".
- Old Password :** An empty text input field.
- New Password :** An empty text input field.
- Retype to Confirm :** An empty text input field.
- Group :** A dropdown menu with "User" selected.

At the bottom of the form, there are two buttons: "Apply" and "Cancel".

The following table describes the labels in this screen.

Table 58 Maintenance > Account > Edit

LABEL	DESCRIPTION
Username	Enter a descriptive name for the user account. The user name can be up to 15 alphanumeric characters (0-9, A-Z, a-z, -, _ with no spaces).
Old Password	Type the default password or the existing password you use to access the system in this field.
New Password	Type your new system password (up to 30 characters). Note that as you type a password, the screen displays an asterisk (*) for each character you type.
Retype to Confirm	Type the new password again in this field.
Group	This shows the type of login account.
Apply	Click Apply to save your changes back to the LTE3301.
Cancel	Click Cancel to begin configuring this screen afresh.

20.5 Time Setting Screen

Use this screen to configure the LTE3301's time based on your local time zone. To change your LTE3301's time and date, click **Maintenance > Time**. The screen appears as shown.

Figure 92 Maintenance > Time

The following table describes the labels in this screen.

Table 59 Maintenance > Time

LABEL	DESCRIPTION
Current Time and Date	
Current Time	This field displays the time of your LTE3301. Each time you reload this page, the LTE3301 synchronizes the time with the time server.
Current Date	This field displays the date of your LTE3301. Each time you reload this page, the LTE3301 synchronizes the date with the time server.
Current Time and Date	
Manual	Select this radio button to enter the time and date manually. If you configure a new time and date, Time Zone and Daylight Saving at the same time, the new time and date you entered has priority and the Time Zone and Daylight Saving settings do not affect it.
New Time (hh:mm:ss)	This field displays the last updated time from the time server or the last time configured manually. When you select Manual , enter the new time in this field and then click Apply .
New Date (yyyy/mm/dd)	This field displays the last updated date from the time server or the last date configured manually. When you select Manual , enter the new date in this field and then click Apply .
Get from Time Server	Select this radio button to have the LTE3301 get the time and date from the time server you specified below.
User Defined Time Server Address	Select User Defined Time Server Address and enter the IP address or URL (up to 20 extended ASCII characters in length) of your time server. Check with your ISP/network administrator if you are unsure of this information.
Time Zone Setup	

Table 59 Maintenance > Time (continued)

LABEL	DESCRIPTION
Time Zone	Choose the time zone of your location. This will set the time difference between your time zone and Greenwich Mean Time (GMT).
Daylight Savings	Daylight saving is a period from late spring to early fall when many countries set their clocks ahead of normal local time by one hour to give more daytime light in the evening. Select this option if you use Daylight Saving Time.
Start Date	Configure the day and time when Daylight Saving Time starts if you selected Daylight Savings . The at field uses the 24 hour format. Here are a couple of examples: Daylight Saving Time starts in most parts of the United States on the second Sunday of March. Each time zone in the United States starts using Daylight Saving Time at 2 A.M. local time. So in the United States you would select Second, Sunday, March and select 2 in the at field. Daylight Saving Time starts in the European Union on the last Sunday of March. All of the time zones in the European Union start using Daylight Saving Time at the same moment (1 A.M. GMT or UTC). So in the European Union you would select Last, Sunday, March . The time you select in the at field depends on your time zone. In Germany for instance, you would select 2 because Germany's time zone is one hour ahead of GMT or UTC (GMT+1).
End Date	Configure the day and time when Daylight Saving Time ends if you selected Daylight Savings . The at field uses the 24 hour format. Here are a couple of examples: Daylight Saving Time ends in the United States on the first Sunday of November. Each time zone in the United States stops using Daylight Saving Time at 2 A.M. local time. So in the United States you would select First, Sunday, November and select 2 in the at field. Daylight Saving Time ends in the European Union on the last Sunday of October. All of the time zones in the European Union stop using Daylight Saving Time at the same moment (1 A.M. GMT or UTC). So in the European Union you would select Last, Sunday, October . The time you select in the at field depends on your time zone. In Germany for instance, you would select 2 because Germany's time zone is one hour ahead of GMT or UTC (GMT+1).
Apply	Click Apply to save your changes back to the LTE3301.
Cancel	Click Cancel to begin configuring this screen afresh.

20.6 Firmware Upgrade Screen

Find firmware at www.zyxel.com in a file that uses the version number and project code with a "*.bin" extension, e.g., "V1.00(AAYE.0).bin". The upload process uses HTTP (Hypertext Transfer Protocol) and may take up to two minutes. After a successful upload, the system will reboot.

Click **Maintenance > Firmware Upgrade**. Follow the instructions in this screen to upload firmware to your LTE3301.

Figure 93 Maintenance > Firmware Upgrade

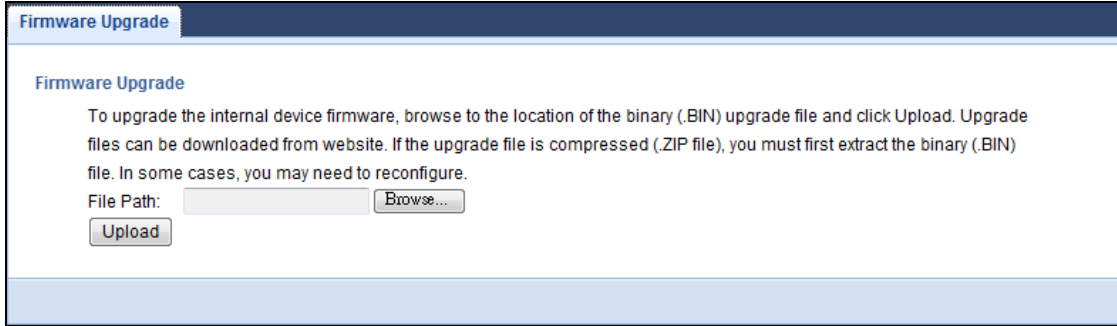

The following table describes the labels in this screen.

Table 60 Maintenance > Firmware Upgrade

LABEL	DESCRIPTION
File Path	Type in the location of the file you want to upload in this field or click Browse... to find it.
Browse...	Click Browse... to find the .bin file you want to upload. Remember that you must decompress compressed (.zip) files before you can upload them.
Upload	Click Upload to begin the upload process. This process may take up to two minutes.

Note: Do not turn off the LTE3301 while firmware upload is in progress!

After you see the **Firmware Upload In Process** screen, wait two minutes before logging into the LTE3301 again.

The LTE3301 automatically restarts in this time causing a temporary network disconnect. In some operating systems, you may see the following icon on your desktop.

Figure 94 Network Temporarily Disconnected

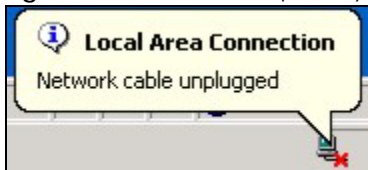

After two minutes, log in again and check your new firmware version in the **Status** screen.

If the upload was not successful, an error message appears. Click **Return** to go back to the **Firmware Upgrade** screen.

20.7 Configuration Backup/Restore Screen

Backup configuration allows you to back up (save) the LTE3301's current configuration to a file on your computer. Once your LTE3301 is configured and functioning properly, it is highly recommended that you back up your configuration file before making configuration changes. The backup configuration file will be useful in case you need to return to your previous settings.

Restore configuration allows you to upload a new or previously saved configuration file from your computer to your LTE3301.

Click **Maintenance > Backup/Restore**. Information related to factory defaults, backup configuration, and restoring configuration appears as shown next.

Figure 95 Maintenance > Backup/Restore

Backup/Restore

Backup Configuration
Click Backup to save the current configuration of your system to your computer. **Backup**

Restore Configuration
To restore a previously saved configuration file to your system, browse to the location of the configuration file and click Upload.
File Path : **Browse...** **Upload**

Back to Factory Defaults
Click Reset to clear all user-entered configuration information and return to factory defaults. After resetting, the

- User will be admin
- Password will be 1234
- LAN IP address will be 192.168.1.1
- DHCP will be reset to server

Reset

The following table describes the labels in this screen.

Table 61 Maintenance > Backup/Restore

LABEL	DESCRIPTION
Backup	Click Backup to save the LTE3301's current configuration to your computer.
File Path	Type in the location of the file you want to upload in this field or click Browse... to find it.
Browse...	Click Browse... to find the file you want to upload. Remember that you must decompress compressed (.ZIP) files before you can upload them.
Upload	Click Upload to begin the upload process. Note: Do not turn off the LTE3301 while configuration file upload is in progress. After you see a "configuration upload successful" screen, you must then wait one minute before logging into the LTE3301 again. The LTE3301 automatically restarts in this time causing a temporary network disconnect. If you see an error screen, click Back to return to the Backup/Restore screen.
Reset	Pressing the Reset button in this section clears all user-entered configuration information and returns the LTE3301 to its factory defaults. You can also press the RESET button on the rear panel to reset the factory defaults of your LTE3301. Refer to the chapter about introducing the Web Configurator for more information on the RESET button.

Note: If you uploaded the default configuration file you may need to change the IP address of your computer to be in the same subnet as that of the default LTE3301 IP address (192.168.1.1). See [Appendix B on page 147](#) for details on how to set up your computer's IP address.

20.8 Restart Screen

System restart allows you to reboot the LTE3301 without turning the power off.

Click **Maintenance > Restart** to open the following screen.

Figure 96 Maintenance > Restart

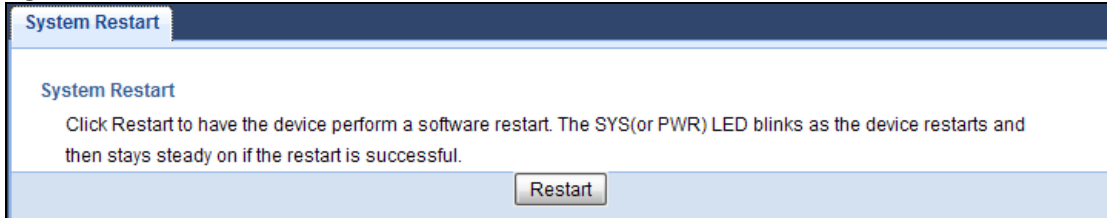

Click **Restart** to have the LTE3301 reboot. This does not affect the LTE3301's configuration.

CHAPTER 21

Troubleshooting

21.1 Overview

This chapter offers some suggestions to solve problems you might encounter. The potential problems are divided into the following categories.

- [Power, Hardware Connections, and LEDs](#)
- [LTE3301 Access and Login](#)
- [Internet Access](#)
- [Wireless Connections](#)

21.2 Power, Hardware Connections, and LEDs

[The LTE3301 does not turn on. None of the LEDs turn on.](#)

- 1 Make sure you are using the power adaptor or cord included with the LTE3301.
- 2 Make sure the power adaptor or cord is connected to the LTE3301 and plugged in to an appropriate power source. Make sure the power source is turned on.
- 3 Disconnect and re-connect the power adaptor or cord to the LTE3301.
- 4 If the problem continues, contact the vendor.

[One of the LEDs does not behave as expected.](#)

- 1 Make sure you understand the normal behavior of the LED. See [Section 1.8 on page 13](#).
- 2 Check the hardware connections. See the Quick Start Guide.
- 3 Inspect your cables for damage. Contact the vendor to replace any damaged cables.
- 4 Disconnect and re-connect the power adaptor to the LTE3301.
- 5 If the problem continues, contact the vendor.

21.3 LTE3301 Access and Login

I don't know the IP address of my LTE3301.

- 1 The default IP address of the LTE3301 is **192.168.1.1**.
- 2 If you changed the IP address and have forgotten it, you might get the IP address of the LTE3301 by looking up the IP address of the default gateway for your computer. To do this in most Windows computers, click **Start > Run**, enter **cmd**, and then enter **ipconfig**. The IP address of the **Default Gateway** might be the IP address of the LTE3301 (it depends on the network), so enter this IP address in your Internet browser.
- 3 Reset your LTE3301 to change all settings back to their default. This means your current settings are lost. See [Section 1.5 on page 12](#) for information on resetting your LTE3301.

I forgot the password.

- 1 The default password is **1234**.
- 2 If this does not work, you have to reset the device to its factory defaults. See [Section 1.5 on page 12](#).

I cannot see or access the **Login** screen in the Web Configurator.

- 1 Make sure you are using the correct IP address.
 - The default IP address of the LTE3301 is **192.168.1.1**.
 - If you changed the IP address ([Section 8.4 on page 81](#)), use the new IP address.
 - If you changed the IP address and have forgotten it, see the troubleshooting suggestions for [I don't know the IP address of my LTE3301](#).
- 2 Check the hardware connections, and make sure the LEDs are behaving as expected. See the Quick Start Guide.
- 3 Make sure your Internet browser does not block pop-up windows and has JavaScript and Java enabled. See [Appendix A on page 138](#).
- 4 Make sure your computer is in the same subnet as the LTE3301. (If you know that there are routers between your computer and the LTE3301, skip this step.)
 - If there is a DHCP server on your network, make sure your computer is using a dynamic IP address. See [Section 8.4 on page 81](#).
 - If there is no DHCP server on your network, make sure your computer's IP address is in the same subnet as the LTE3301. See [Section 8.4 on page 81](#).

- 5 Reset the device to its factory defaults, and try to access the LTE3301 with the default IP address. See [Section 1.5 on page 12](#).
- 6 If the problem continues, contact the network administrator or vendor, or try one of the advanced suggestions.

Advanced Suggestions

- Try to access the LTE3301 using another service, such as Telnet. If you can access the LTE3301, check the firewall rules to find out why the LTE3301 does not respond to HTTP.
- If your computer is connected to the **WAN** port or is connected wirelessly, use a computer that is connected to a **LAN/ETHERNET** port.

I can see the [Login](#) screen, but I cannot log in to the LTE3301.

- 1 Make sure you have entered the user name and password correctly. The default user name is **admin** and the default password is **1234**. This field is case-sensitive, so make sure [Caps Lock] is not on.
- 2 This can happen when you fail to log out properly from your last session. Try logging in again after 5 minutes.
- 3 Disconnect and re-connect the power adaptor or cord to the LTE3301.
- 4 If this does not work, you have to reset the device to its factory defaults. See [Section 1.5 on page 12](#).

21.4 Internet Access

I cannot access the Internet.

- 1 Check the hardware connections, and make sure the LEDs are behaving as expected. See the Quick Start Guide.
- 2 Make sure your mobile access information (such as APN) is entered correctly in the wizard or the WAN screen. These fields are case-sensitive, so make sure [Caps Lock] is not on.
- 3 Make sure your SIM card's account is valid and has an active data plan. Check your service contract or contact your service provider directly.
- 4 If the problem continues, contact your ISP.

I cannot access the Internet anymore. I had access to the Internet (with the LTE3301), but my Internet connection is not available anymore.

- 1 Check the hardware connections, and make sure the LEDs are behaving as expected. See the Quick Start Guide and [Section 1.8 on page 13](#).
- 2 Reboot the LTE3301.
- 3 If the problem continues, contact your ISP.

The Internet connection is slow or intermittent.

- 1 There might be a lot of traffic on the network. Look at the LEDs, and check [Section 1.8 on page 13](#). If the LTE3301 is sending or receiving a lot of information, try closing some programs that use the Internet, especially peer-to-peer applications.
- 2 Check the signal strength. If the signal strength is low, try moving the LTE3301 closer to the ISP's base station if possible, and look around to see if there are any devices that might be interfering with the wireless network (for example, microwaves, other wireless networks, and so on).
- 3 Reboot the LTE3301.
- 4 If the problem continues, contact the network administrator or vendor, or try one of the advanced suggestions.

Advanced Suggestion

- Check the settings for QoS. If it is disabled, you might consider activating it.

21.5 Wireless Connections

I cannot access the LTE3301 or ping any computer from the WLAN.

- 1 Make sure the wireless LAN is enabled on the LTE3301.
- 2 Make sure the wireless adapter on your computer is working properly.
- 3 Make sure the wireless adapter installed on your computer is IEEE 802.11 compatible and supports the same wireless standard as the LTE3301.
- 4 Make sure your computer (with a wireless adapter installed) is within the transmission range of the LTE3301.
- 5 Check that both the LTE3301 and the wireless adapter on your computer are using the same wireless and wireless security settings.

I set up URL keyword blocking, but I can still access a website that should be blocked.

Make sure that the keywords that you type are listed in the rule's **Keyword List**.

What factors may cause intermittent or unstabled wireless connection? How can I solve this problem?

The following factors may cause interference:

- Obstacles: walls, ceilings, furniture, and so on.
- Building Materials: metal doors, aluminum studs.
- Electrical devices: microwaves, monitors, electric motors, cordless phones, and other wireless devices.

To optimize the speed and quality of your wireless connection, you can:

- Move your wireless device closer to the AP if the signal strength is low.
- Reduce wireless interference that may be caused by other wireless networks or surrounding wireless electronics such as cordless phones.
- Place the AP where there are minimum obstacles (such as walls and ceilings) between the AP and the wireless client.
- Reduce the number of wireless clients connecting to the same AP simultaneously, or add additional APs if necessary.
- Try closing some programs that use the Internet, especially peer-to-peer applications. If the wireless client is sending or receiving a lot of information, it may have too many programs open that use the Internet.
- Position the antennas for best reception. If the AP is placed on a table or floor, point the antennas upwards. If the AP is placed at a high position, point the antennas downwards. Try pointing the antennas in different directions and check which provides the strongest signal to the wireless clients.

21.6 Getting More Troubleshooting Help

Search for support information for your model at www.zyxel.com for more troubleshooting suggestions.

APPENDIX A

Pop-up Windows, JavaScript and Java Permissions

In order to use the web configurator you need to allow:

- Web browser pop-up windows from your device.
- JavaScript (enabled by default).
- Java permissions (enabled by default).

Note: The screens used below belong to Internet Explorer version 6, 7 and 8. Screens for other Internet Explorer versions may vary.

Internet Explorer Pop-up Blockers

You may have to disable pop-up blocking to log into your device.

Either disable pop-up blocking (enabled by default in Windows XP SP (Service Pack) 2) or allow pop-up blocking and create an exception for your device's IP address.

Disable Pop-up Blockers

- 1 In Internet Explorer, select **Tools, Pop-up Blocker** and then select **Turn Off Pop-up Blocker**.

Figure 97 Pop-up Blocker

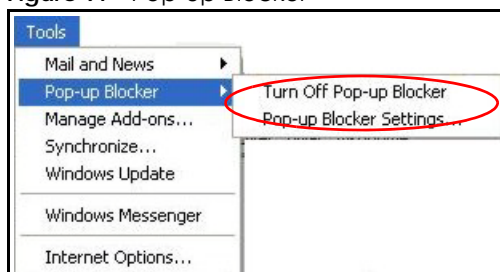

You can also check if pop-up blocking is disabled in the **Pop-up Blocker** section in the **Privacy** tab.

- 1 In Internet Explorer, select **Tools, Internet Options, Privacy**.
- 2 Clear the **Block pop-ups** check box in the **Pop-up Blocker** section of the screen. This disables any web pop-up blockers you may have enabled.

Figure 98 Internet Options: Privacy



- 3 Click **Apply** to save this setting.

Enable Pop-up Blockers with Exceptions

Alternatively, if you only want to allow pop-up windows from your device, see the following steps.

- 1 In Internet Explorer, select **Tools, Internet Options** and then the **Privacy** tab.
- 2 Select **Settings...** to open the **Pop-up Blocker Settings** screen.

Figure 99 Internet Options: Privacy

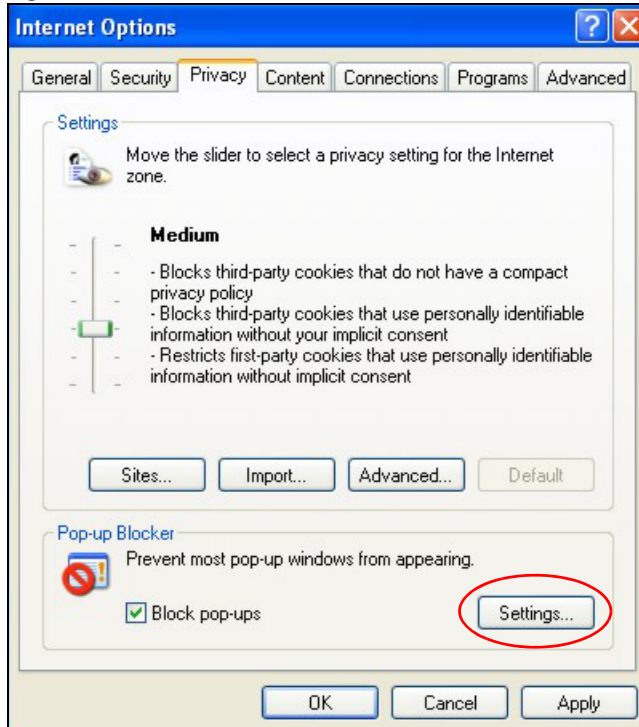

- 3 Type the IP address of your device (the web page that you do not want to have blocked) with the prefix "http://". For example, http://192.168.167.1.
- 4 Click **Add** to move the IP address to the list of **Allowed sites**.

Figure 100 Pop-up Blocker Settings



- 5 Click **Close** to return to the **Privacy** screen.
- 6 Click **Apply** to save this setting.

JavaScript

If pages of the web configurator do not display properly in Internet Explorer, check that JavaScript are allowed.

- 1 In Internet Explorer, click **Tools**, **Internet Options** and then the **Security** tab.

Figure 101 Internet Options: Security

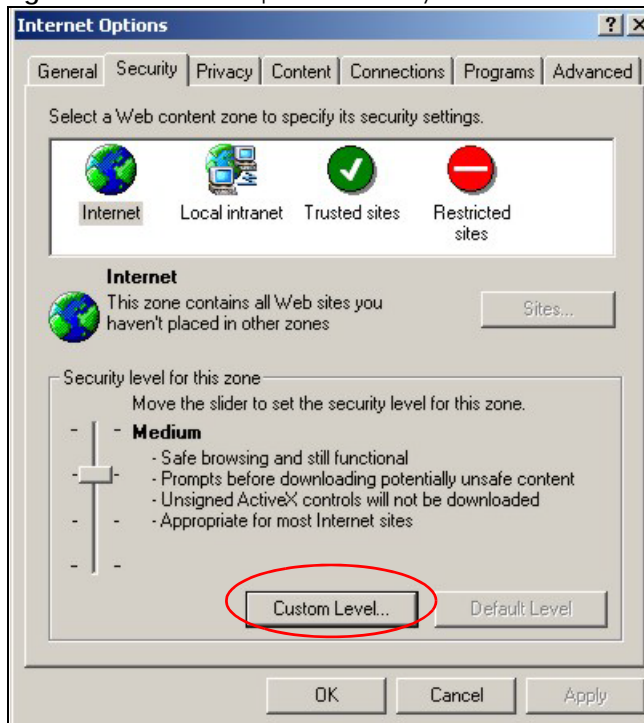

- 2 Click the **Custom Level...** button.
- 3 Scroll down to **Scripting**.
- 4 Under **Active scripting** make sure that **Enable** is selected (the default).
- 5 Under **Scripting of Java applets** make sure that **Enable** is selected (the default).
- 6 Click **OK** to close the window.

Figure 102 Security Settings - Java Scripting

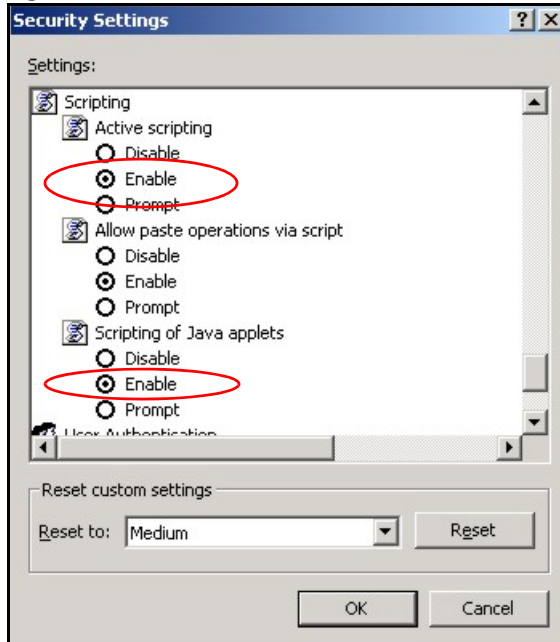

Java Permissions

- 1 From Internet Explorer, click **Tools, Internet Options** and then the **Security** tab.
- 2 Click the **Custom Level...** button.
- 3 Scroll down to **Microsoft VM**.
- 4 Under **Java permissions** make sure that a safety level is selected.
- 5 Click **OK** to close the window.

Figure 103 Security Settings - Java

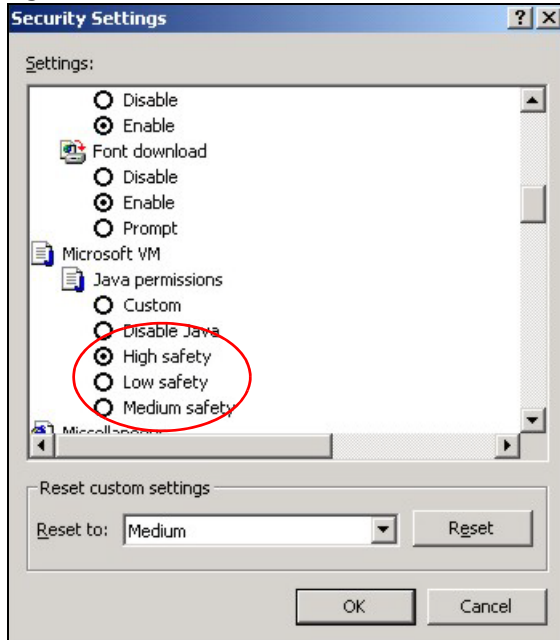

JAVA (Sun)

- 1 From Internet Explorer, click **Tools, Internet Options** and then the **Advanced** tab.
- 2 Make sure that **Use Java 2 for <applet>** under **Java (Sun)** is selected.
- 3 Click **OK** to close the window.

Figure 104 Java (Sun)

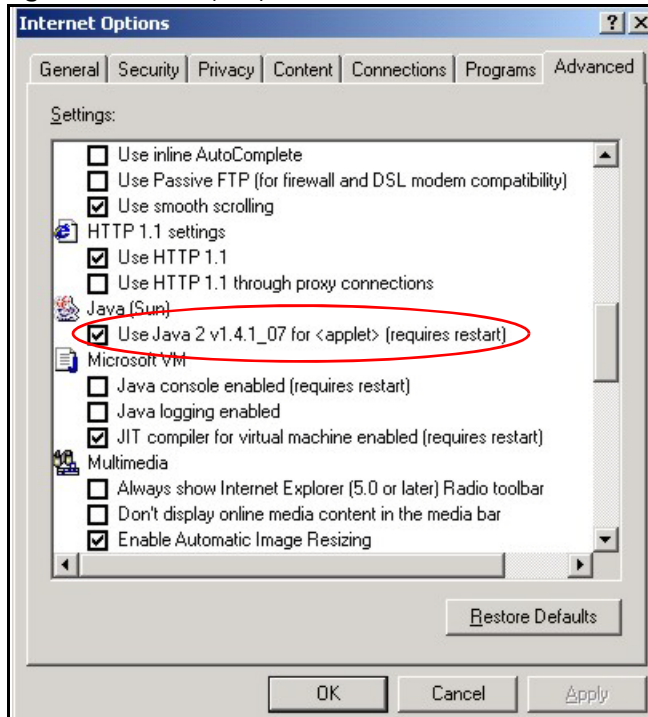

Mozilla Firefox

Mozilla Firefox 2.0 screens are used here. Screens for other versions may vary slightly. The steps below apply to Mozilla Firefox 3.0 as well.

You can enable Java, Javascript and pop-ups in one screen. Click **Tools**, then click **Options** in the screen that appears.

Figure 105 Mozilla Firefox: TOOLS > Options

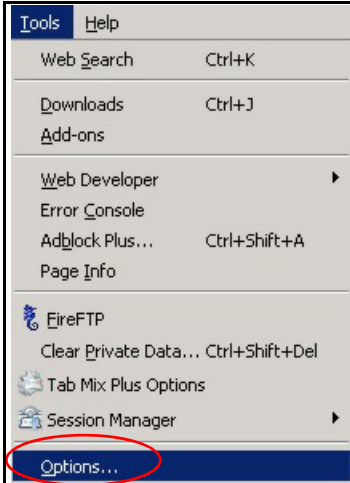

Click **Content** to show the screen below. Select the check boxes as shown in the following screen.

Figure 106 Mozilla Firefox Content Security

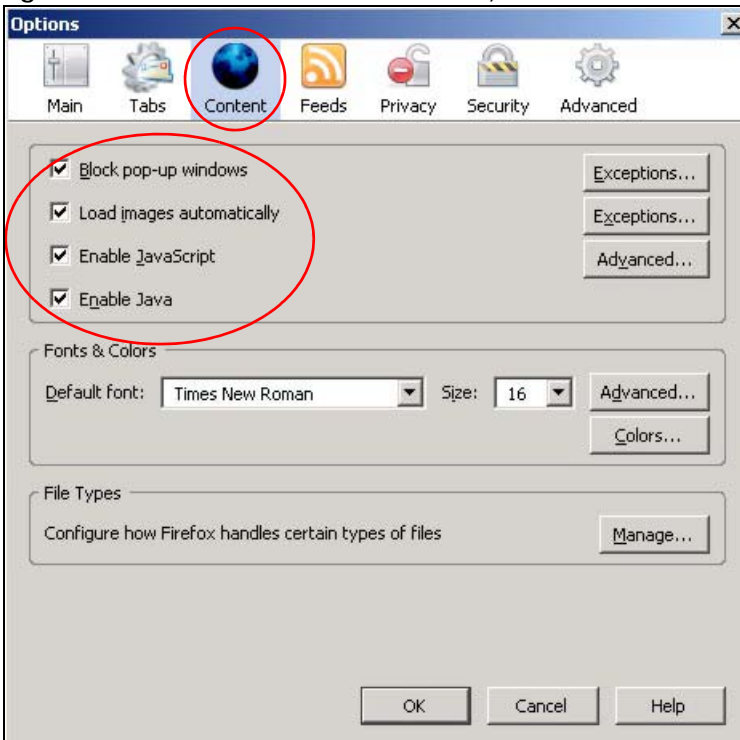

Opera

Opera 10 screens are used here. Screens for other versions may vary slightly.

Allowing Pop-Ups

From Opera, click **Tools**, then **Preferences**. In the **General** tab, go to **Choose how you prefer to handle pop-ups** and select **Open all pop-ups**.

Figure 107 Opera: Allowing Pop-Ups

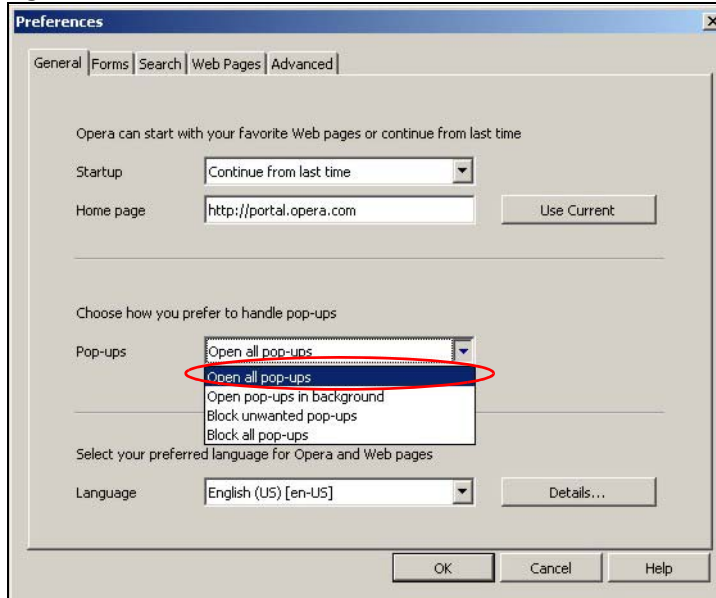

Enabling Java

From Opera, click **Tools**, then **Preferences**. In the **Advanced** tab, select **Content** from the left-side menu. Select the check boxes as shown in the following screen.

Figure 108 Opera: Enabling Java

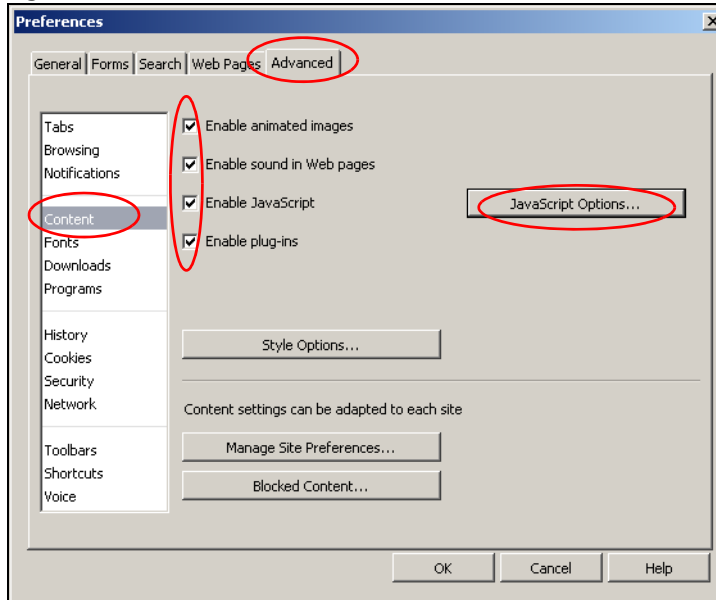

To customize JavaScript behavior in the Opera browser, click **JavaScript Options**.

Figure 109 Opera: JavaScript Options

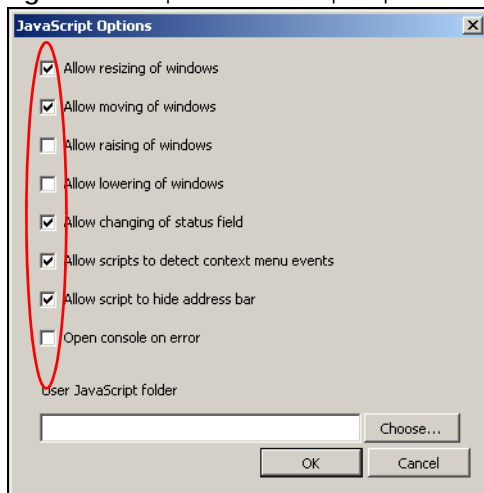

Select the items you want Opera's JavaScript to apply.

APPENDIX B

Setting Up Your Computer's IP Address

Note: Your specific LTE3301 may not support all of the operating systems described in this appendix. See the product specifications for more information about which operating systems are supported.

This appendix shows you how to configure the IP settings on your computer in order for it to be able to communicate with the other devices on your network. Windows Vista/XP/2000, Mac OS 9/OS X, and all versions of UNIX/LINUX include the software components you need to use TCP/IP on your computer.

If you manually assign IP information instead of using a dynamic IP, make sure that your network's computers have IP addresses that place them in the same subnet.

In this appendix, you can set up an IP address for:

- [Windows XP/NT/2000 on page 147](#)
- [Windows Vista on page 150](#)
- [Windows 7 on page 153](#)
- [Mac OS X: 10.3 and 10.4 on page 157](#)
- [Mac OS X: 10.5 and 10.6 on page 160](#)
- [Linux: Ubuntu 8 \(GNOME\) on page 163](#)
- [Linux: openSUSE 10.3 \(KDE\) on page 167](#)

Windows XP/NT/2000

The following example uses the default Windows XP display theme but can also apply to Windows 2000 and Windows NT.

- 1 Click **Start > Control Panel**.

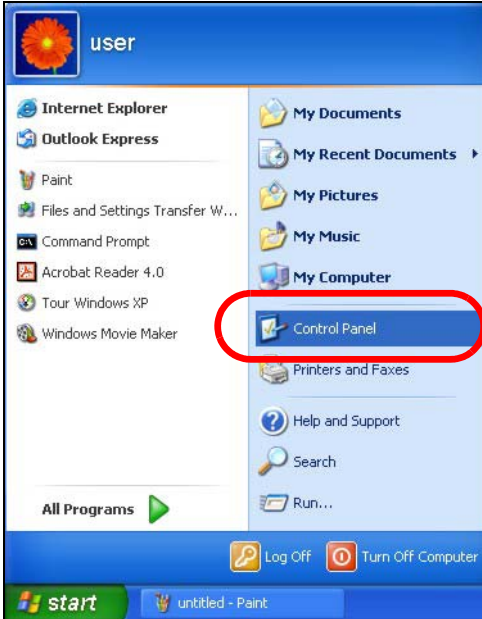

- 2 In the **Control Panel**, click the **Network Connections** icon.



- 3 Right-click **Local Area Connection** and then select **Properties**.

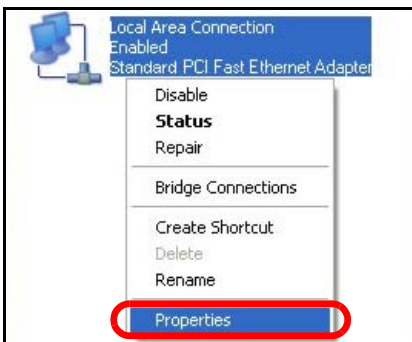

- 4 On the **General** tab, select **Internet Protocol (TCP/IP)** and then click **Properties**.

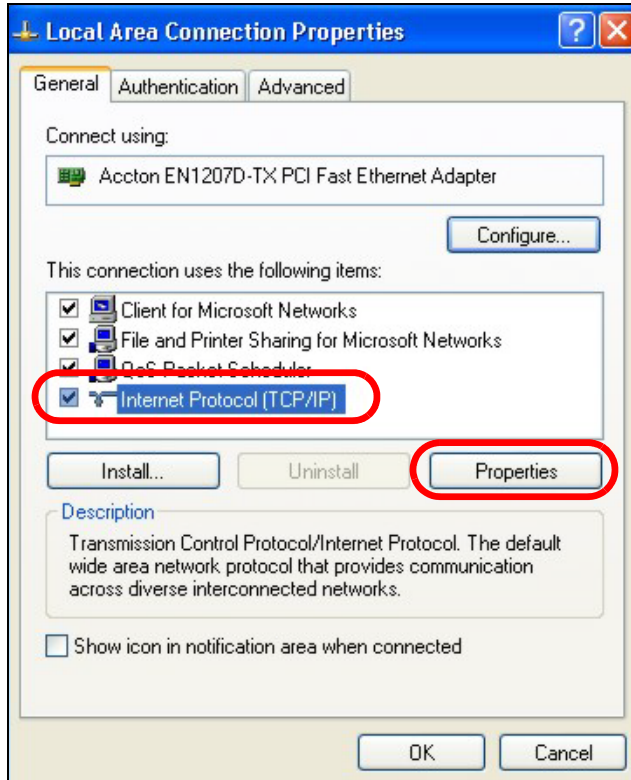

- 5 The Internet Protocol TCP/IP Properties window opens.

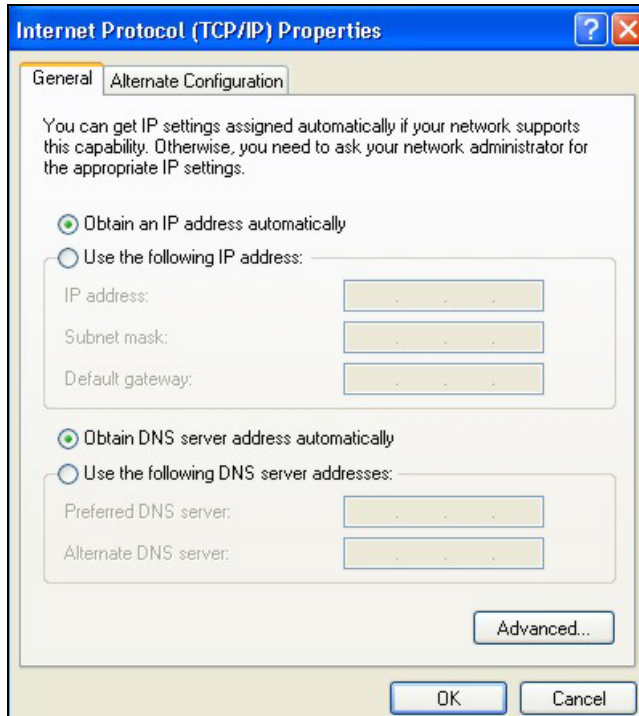

- 6 Select **Obtain an IP address automatically** if your network administrator or ISP assigns your IP address dynamically.
Select **Use the following IP Address** and fill in the **IP address**, **Subnet mask**, and **Default gateway** fields if you have a static IP address that was assigned to you by your network administrator or ISP. You may also have to enter a **Preferred DNS server** and an **Alternate DNS server**, if that information was provided.
- 7 Click **OK** to close the **Internet Protocol (TCP/IP) Properties** window.
- 8 Click **OK** to close the **Local Area Connection Properties** window.

Verifying Settings

- 1 Click **Start > All Programs > Accessories > Command Prompt**.
- 2 In the **Command Prompt** window, type "ipconfig" and then press [ENTER].
You can also go to **Start > Control Panel > Network Connections**, right-click a network connection, click **Status** and then click the **Support** tab to view your IP address and connection information.

Windows Vista

This section shows screens from Windows Vista Professional.

- 1 Click **Start > Control Panel**.

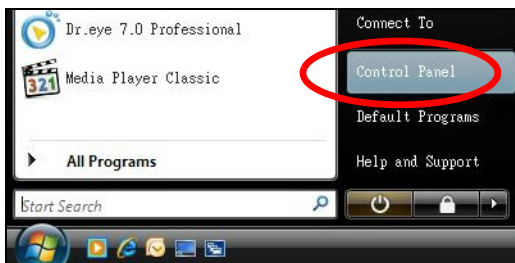

- 2 In the **Control Panel**, click the **Network and Internet** icon.

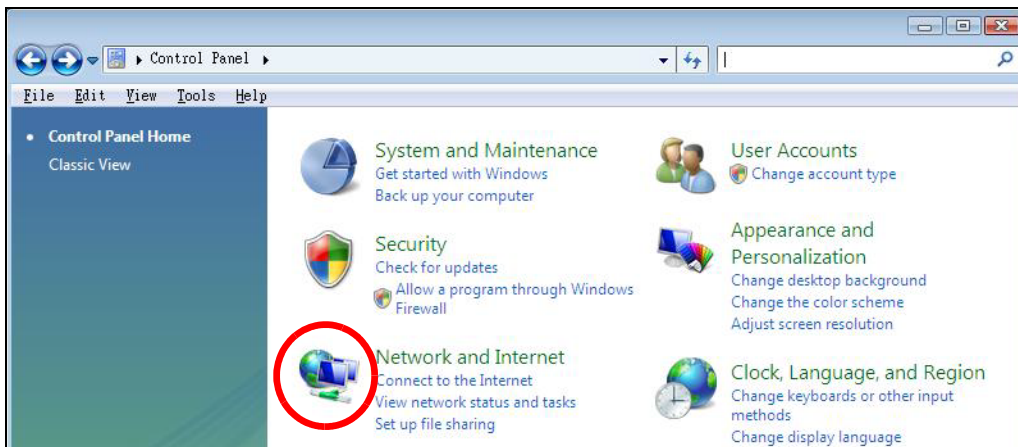

- 3 Click the **Network and Sharing Center** icon.

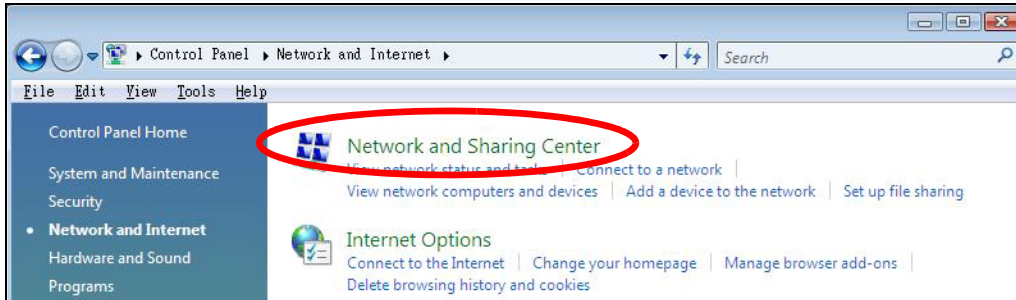

- 4 Click **Manage network connections**.

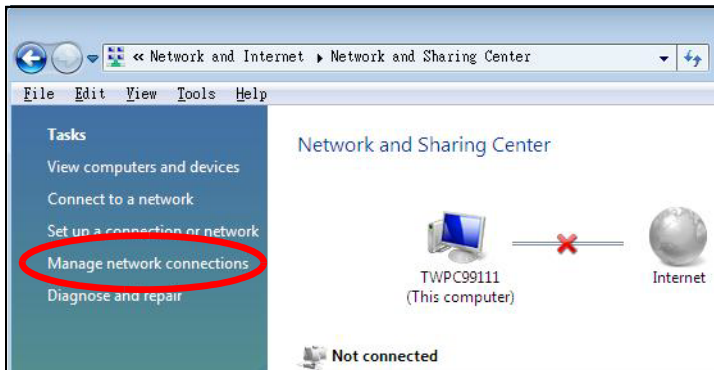

- 5 Right-click **Local Area Connection** and then select **Properties**.

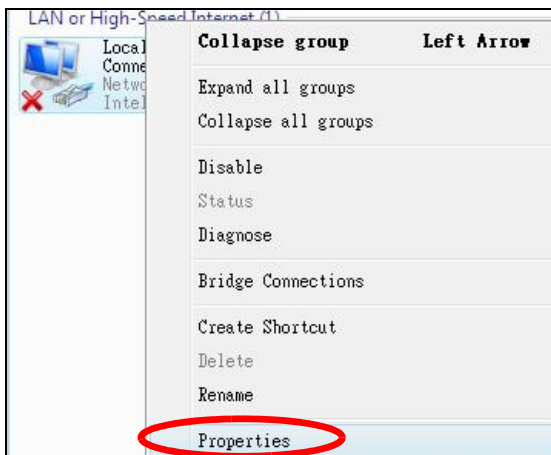

Note: During this procedure, click **Continue** whenever Windows displays a screen saying that it needs your permission to continue.

- 6 Select **Internet Protocol Version 4 (TCP/IPv4)** and then select **Properties**.

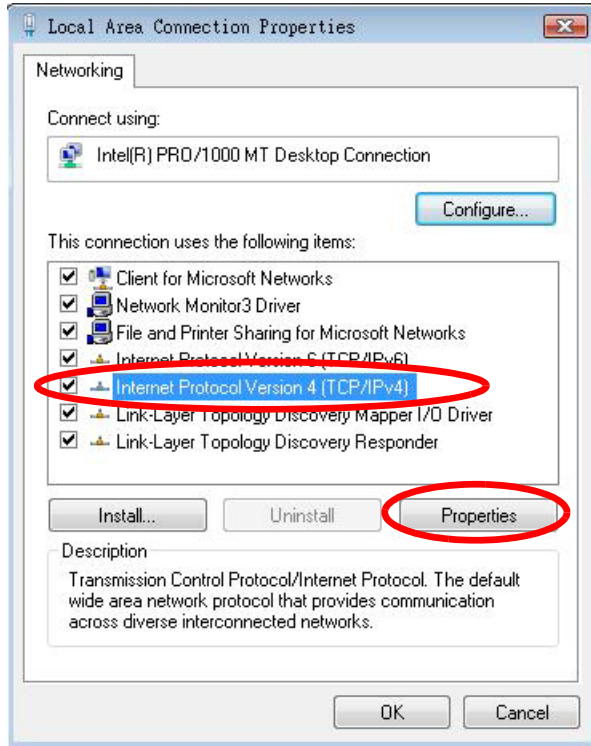

7 The Internet Protocol Version 4 (TCP/IPv4) Properties window opens.

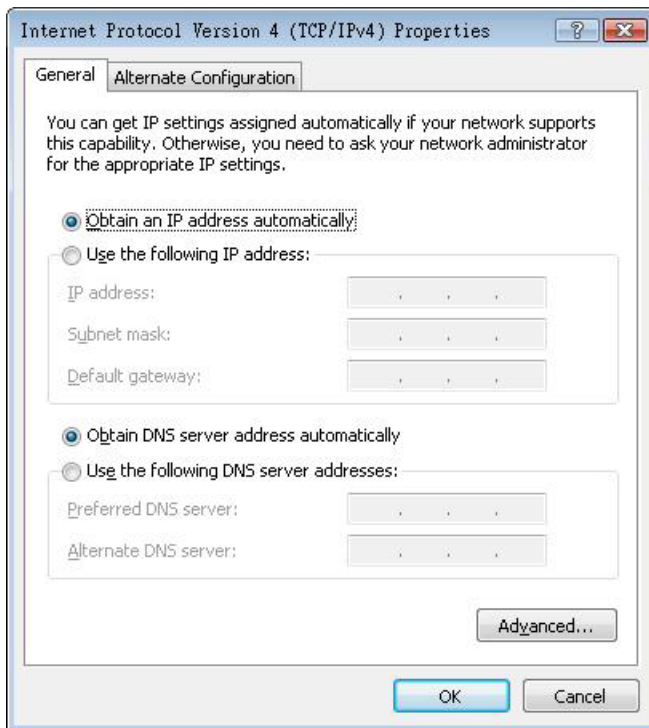

- 8 Select **Obtain an IP address automatically** if your network administrator or ISP assigns your IP address dynamically.

Select **Use the following IP Address** and fill in the **IP address**, **Subnet mask**, and **Default gateway** fields if you have a static IP address that was assigned to you by your network administrator or ISP. You may also have to enter a **Preferred DNS server** and an **Alternate DNS server**, if that information was provided. Click **Advanced**.

- 9 Click **OK** to close the **Internet Protocol (TCP/IP) Properties** window.
- 10 Click **OK** to close the **Local Area Connection Properties** window.

Verifying Settings

- 1 Click **Start > All Programs > Accessories > Command Prompt**.
- 2 In the **Command Prompt** window, type "ipconfig" and then press [ENTER].
You can also go to **Start > Control Panel > Network Connections**, right-click a network connection, click **Status** and then click the **Support** tab to view your IP address and connection information.

Windows 7

This section shows screens from Windows 7 Enterprise.

- 1 Click **Start > Control Panel**.

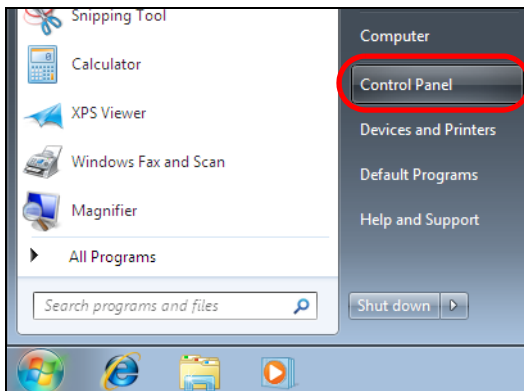

- 2 In the **Control Panel**, click **View network status and tasks** under the **Network and Internet** category.



3 Click **Change adapter settings**.

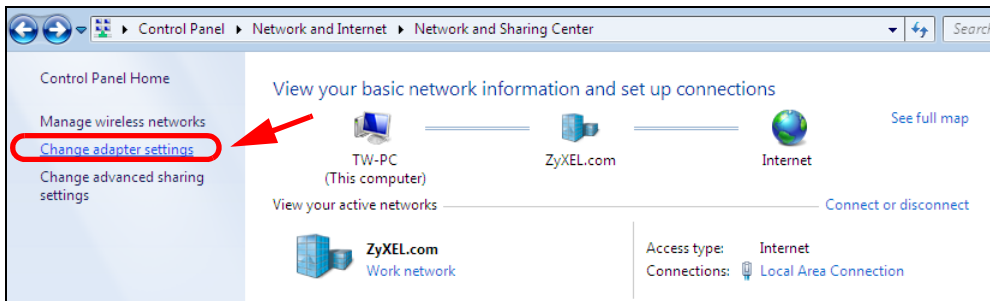

4 Double click **Local Area Connection** and then select **Properties**.

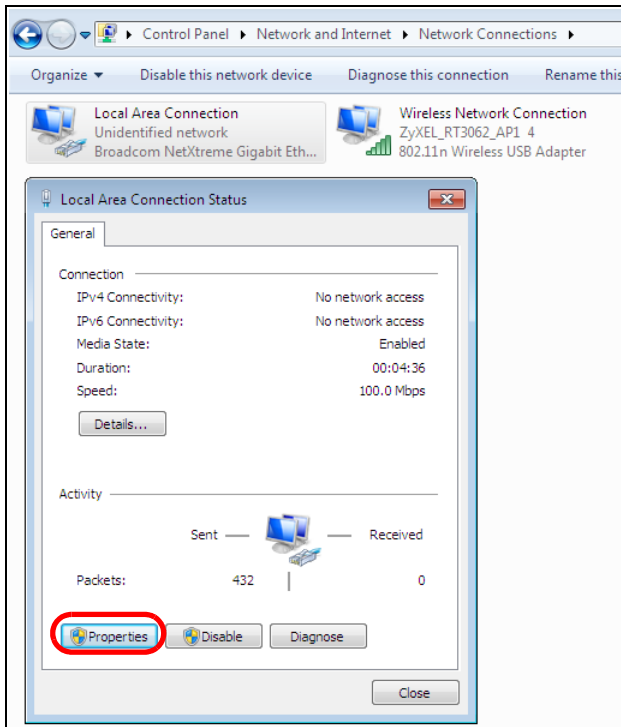

Note: During this procedure, click **Continue** whenever Windows displays a screen saying that it needs your permission to continue.

- 5 Select **Internet Protocol Version 4 (TCP/IPv4)** and then select **Properties**.

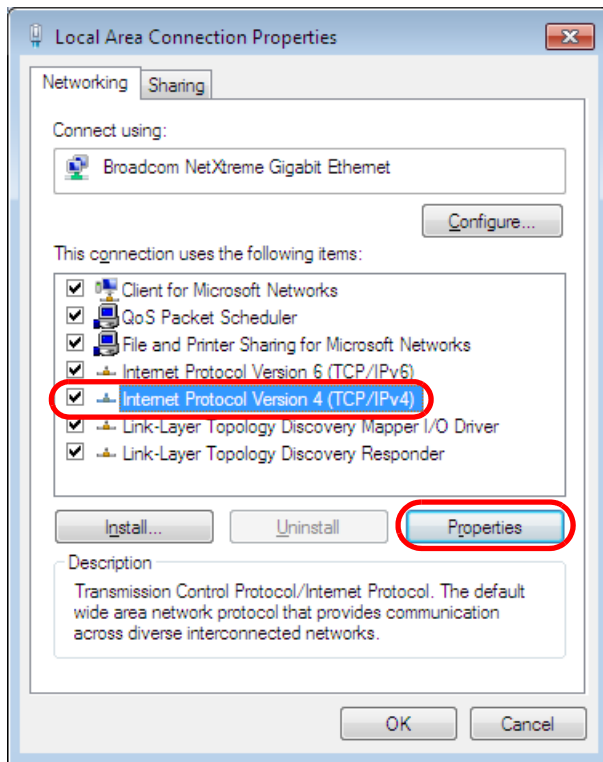

- 6 The **Internet Protocol Version 4 (TCP/IPv4) Properties** window opens.

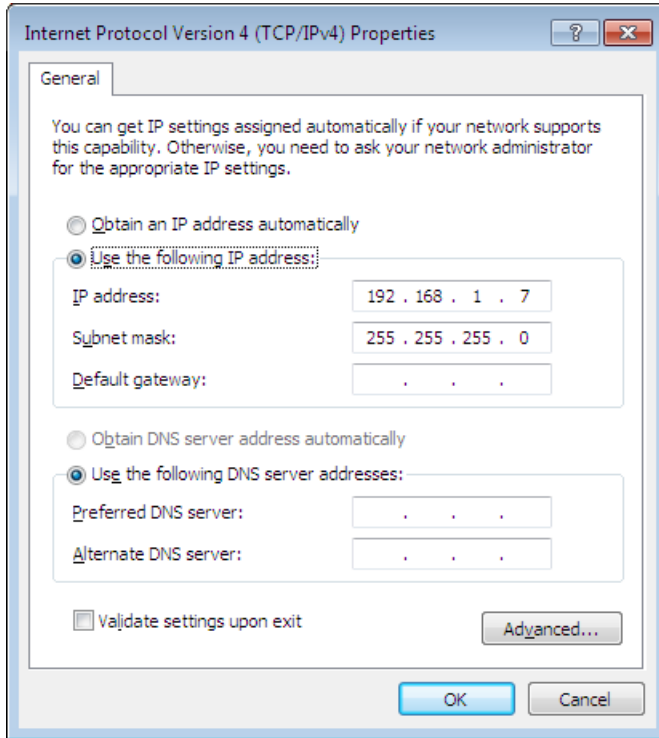

- 7 Select **Obtain an IP address automatically** if your network administrator or ISP assigns your IP address dynamically.

Select **Use the following IP Address** and fill in the **IP address**, **Subnet mask**, and **Default gateway** fields if you have a static IP address that was assigned to you by your network administrator or ISP. You may also have to enter a **Preferred DNS server** and an **Alternate DNS server**, if that information was provided. Click **Advanced** if you want to configure advanced settings for IP, DNS and WINS.

- 8 Click **OK** to close the **Internet Protocol (TCP/IP) Properties** window.
- 9 Click **OK** to close the **Local Area Connection Properties** window.

Verifying Settings

- 1 Click **Start > All Programs > Accessories > Command Prompt**.
- 2 In the **Command Prompt** window, type "ipconfig" and then press [ENTER].
- 3 The IP settings are displayed as follows.

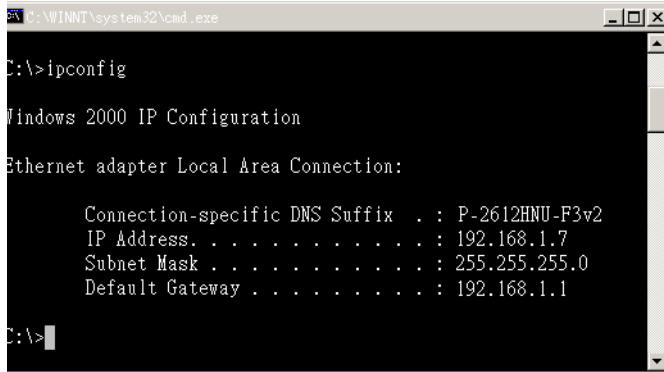

```
C:\WINNT\system32\cmd.exe
C:\>ipconfig

Windows 2000 IP Configuration

Ethernet adapter Local Area Connection:

    Connection-specific DNS Suffix  . : P-2612HNU-F3v2
    IP Address. . . . . : 192.168.1.7
    Subnet Mask . . . . . : 255.255.255.0
    Default Gateway . . . . . : 192.168.1.1

C:\>
```

Mac OS X: 10.3 and 10.4

The screens in this section are from Mac OS X 10.4 but can also apply to 10.3.

- 1 Click **Apple > System Preferences**.

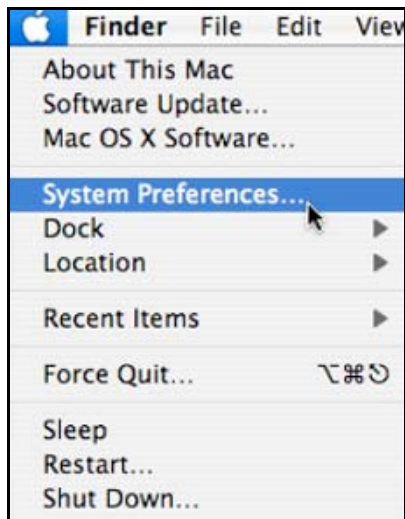

- 2 In the **System Preferences** window, click the **Network** icon.



- 3 When the **Network** preferences pane opens, select **Built-in Ethernet** from the network connection type list, and then click **Configure**.

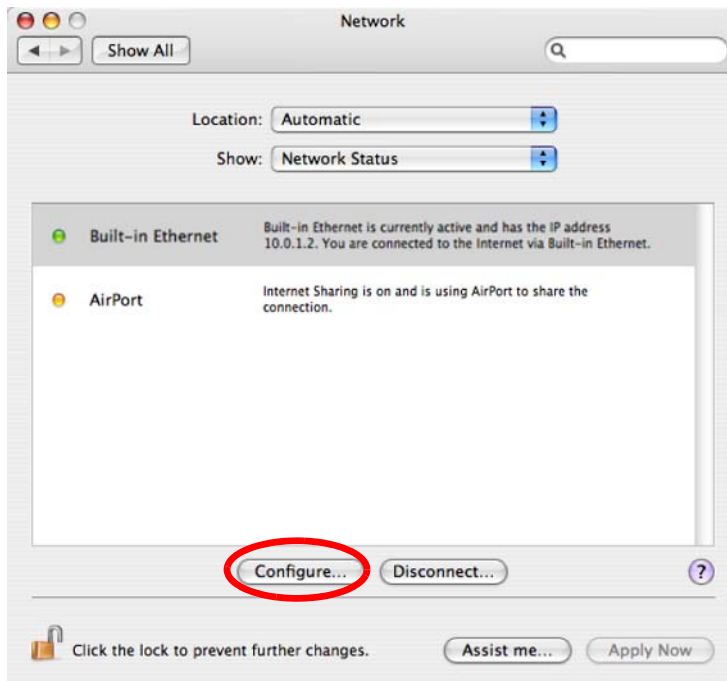

- 4 For dynamically assigned settings, select **Using DHCP** from the **Configure IPv4** list in the **TCP/IP** tab.

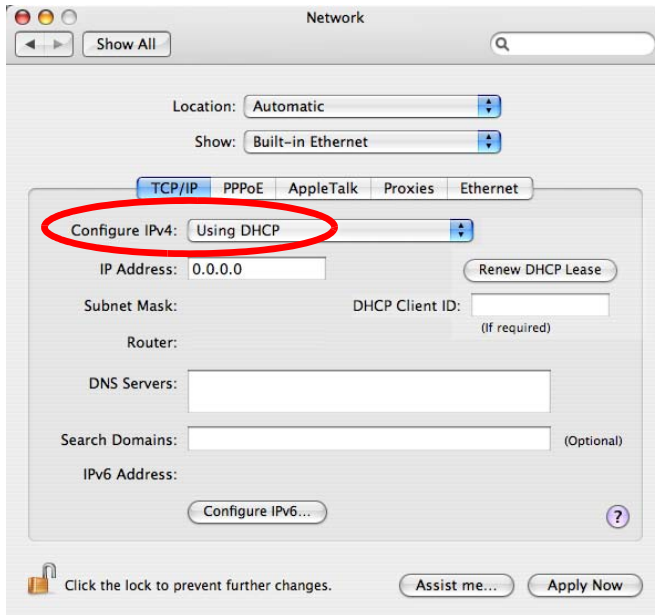

- 5 For statically assigned settings, do the following:
- From the **Configure IPv4** list, select **Manually**.
 - In the **IP Address** field, type your IP address.
 - In the **Subnet Mask** field, type your subnet mask.
 - In the **Router** field, type the IP address of your device.

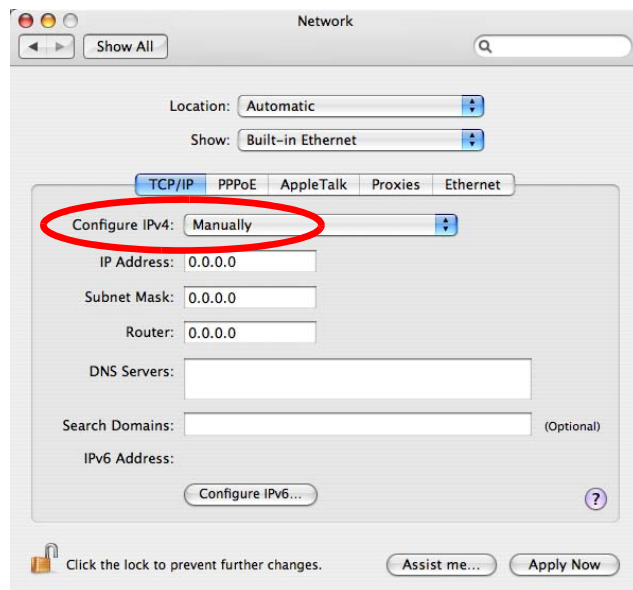

- 6 Click **Apply Now** and close the window.

Verifying Settings

Check your TCP/IP properties by clicking **Applications > Utilities > Network Utilities**, and then selecting the appropriate **Network Interface** from the **Info** tab.

Figure 110 Mac OS X 10.4: Network Utility

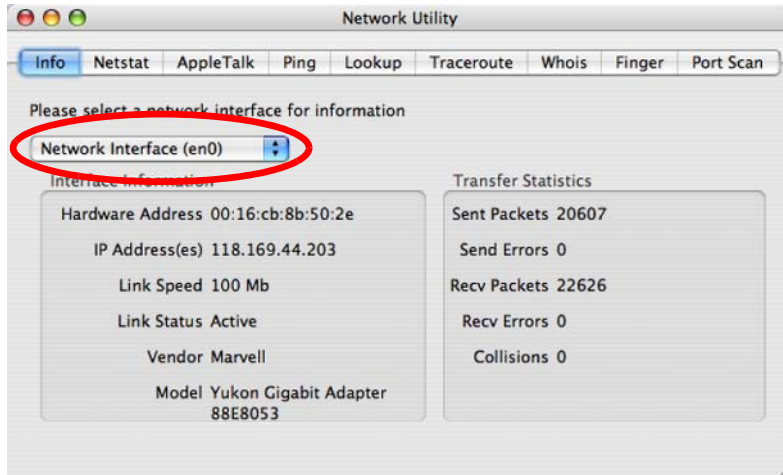

Mac OS X: 10.5 and 10.6

The screens in this section are from Mac OS X 10.5 but can also apply to 10.6.

- 1 Click **Apple > System Preferences**.

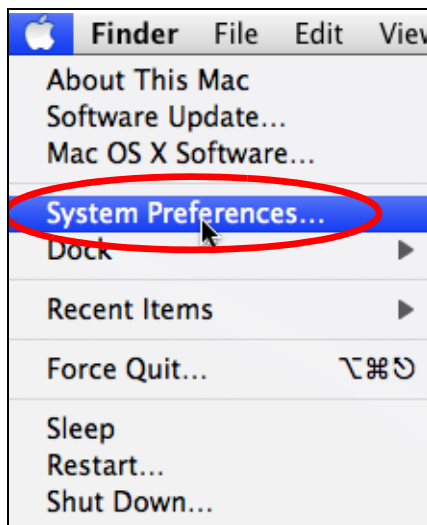

- 2 In System Preferences, click the **Network** icon.



- 3 When the **Network** preferences pane opens, select **Ethernet** from the list of available connection types.

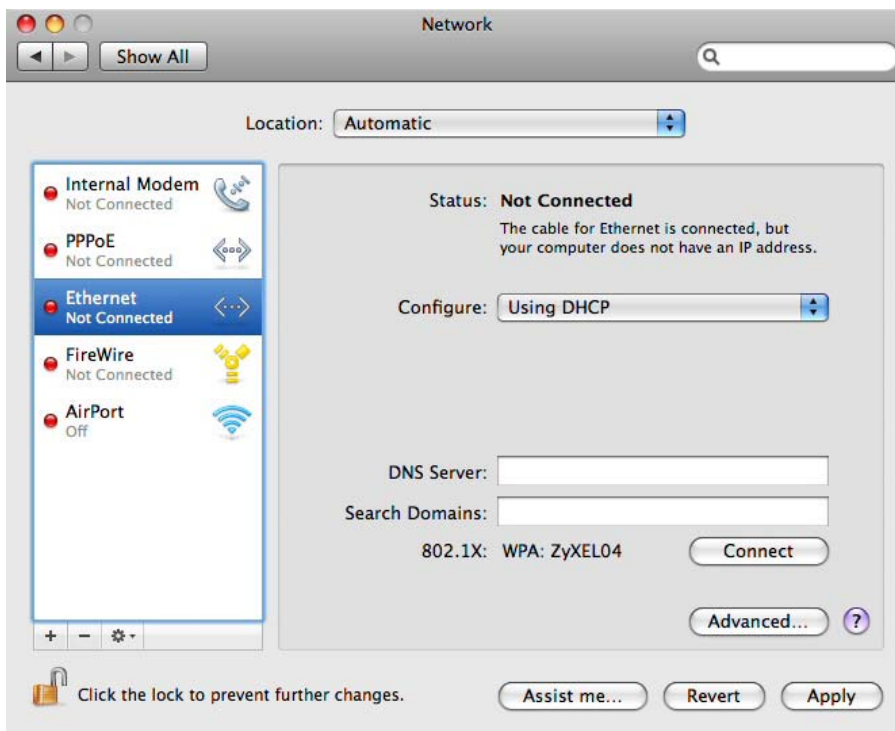

- 4 From the **Configure** list, select **Using DHCP** for dynamically assigned settings.

- 5 For statically assigned settings, do the following:
 - From the **Configure** list, select **Manually**.
 - In the **IP Address** field, enter your IP address.
 - In the **Subnet Mask** field, enter your subnet mask.
 - In the **Router** field, enter the IP address of your LTE3301.

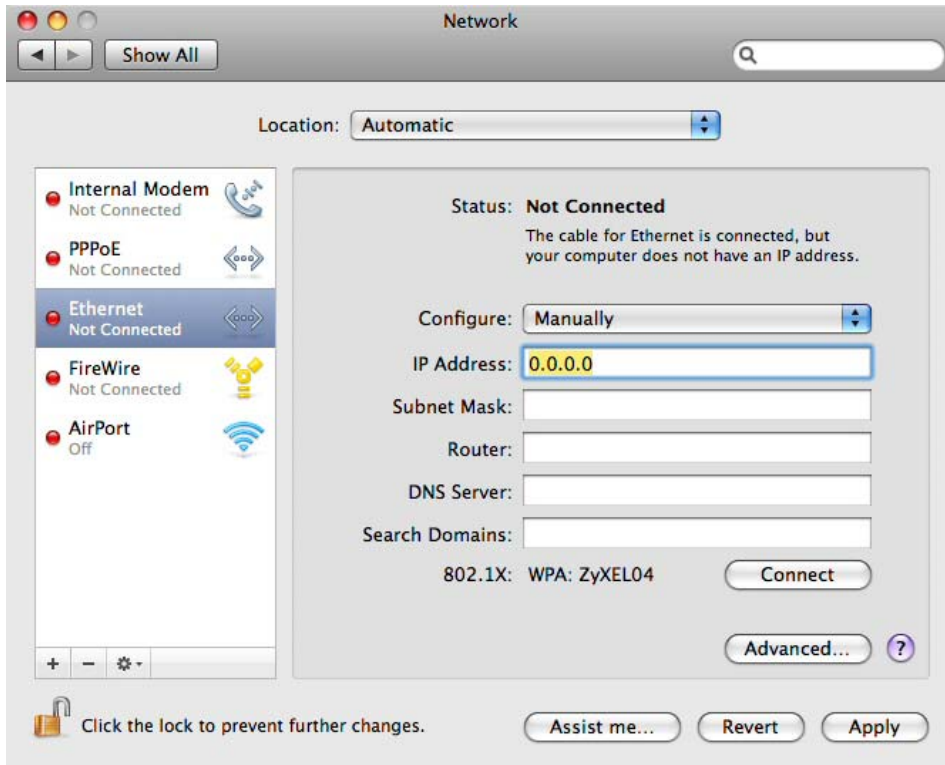

- 6 Click **Apply** and close the window.

Verifying Settings

Check your TCP/IP properties by clicking **Applications > Utilities > Network Utilities**, and then selecting the appropriate **Network interface** from the **Info** tab.

Figure 111 Mac OS X 10.5: Network Utility

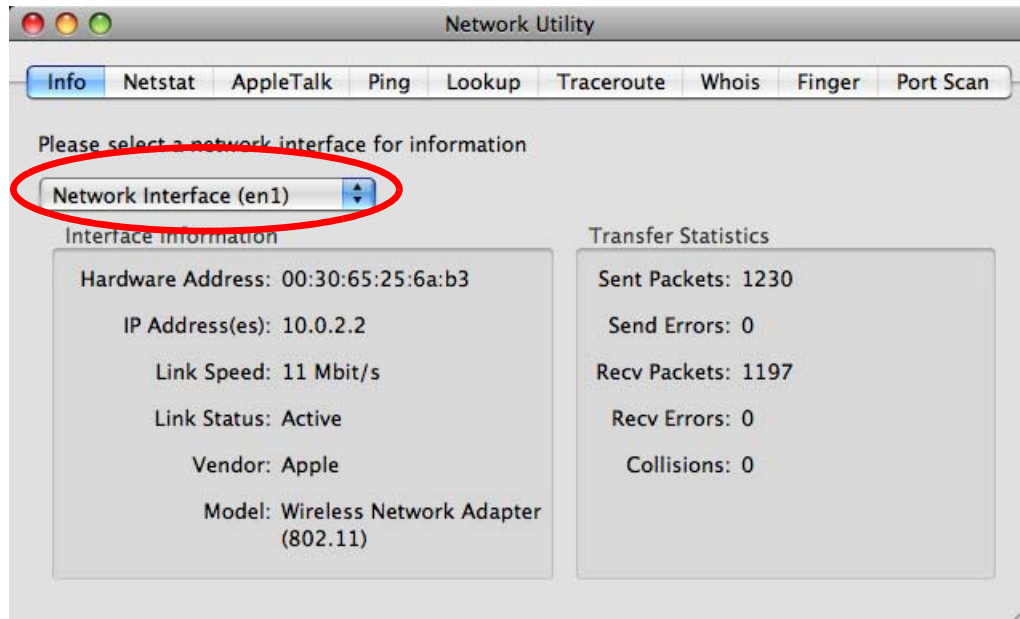

Linux: Ubuntu 8 (GNOME)

This section shows you how to configure your computer's TCP/IP settings in the GNU Object Model Environment (GNOME) using the Ubuntu 8 Linux distribution. The procedure, screens and file locations may vary depending on your specific distribution, release version, and individual configuration. The following screens use the default Ubuntu 8 installation.

Note: Make sure you are logged in as the root administrator.

Follow the steps below to configure your computer IP address in GNOME:

- 1 Click **System > Administration > Network**.

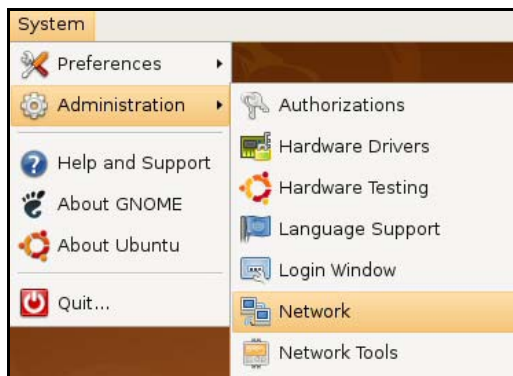

- 2 When the **Network Settings** window opens, click **Unlock** to open the **Authenticate** window. (By default, the **Unlock** button is greyed out until clicked.) You cannot make changes to your configuration unless you first enter your admin password.

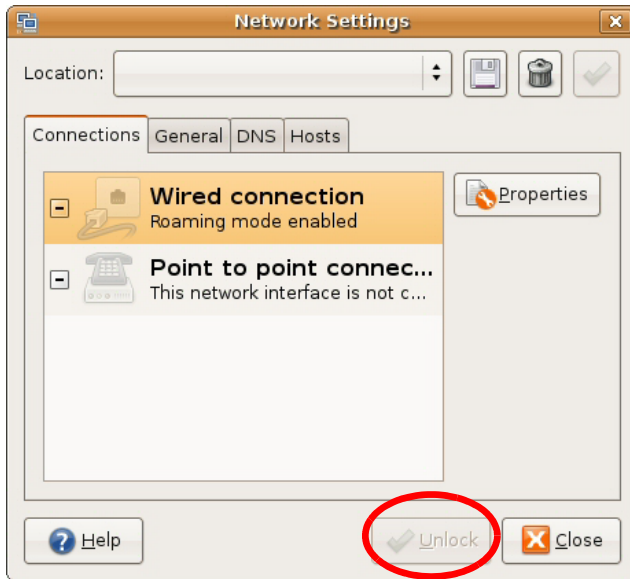

- 3 In the **Authenticate** window, enter your admin account name and password then click the **Authenticate** button.



- 4 In the **Network Settings** window, select the connection that you want to configure, then click **Properties**.

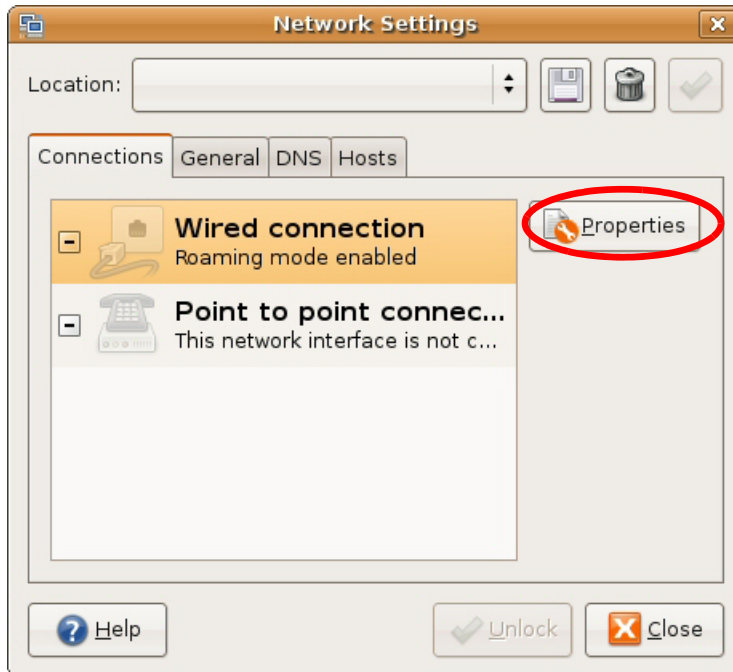

- 5 The **Properties** dialog box opens.



- In the **Configuration** list, select **Automatic Configuration (DHCP)** if you have a dynamic IP address.
 - In the **Configuration** list, select **Static IP address** if you have a static IP address. Fill in the **IP address**, **Subnet mask**, and **Gateway address** fields.
- 6 Click **OK** to save the changes and close the **Properties** dialog box and return to the **Network Settings** screen.
 - 7 If you know your DNS server IP address(es), click the **DNS** tab in the **Network Settings** window and then enter the DNS server information in the fields provided.



- 8 Click the **Close** button to apply the changes.

Verifying Settings

Check your TCP/IP properties by clicking **System > Administration > Network Tools**, and then selecting the appropriate **Network device** from the **Devices** tab. The **Interface Statistics** column shows data if your connection is working properly.

Figure 112 Ubuntu 8: Network Tools

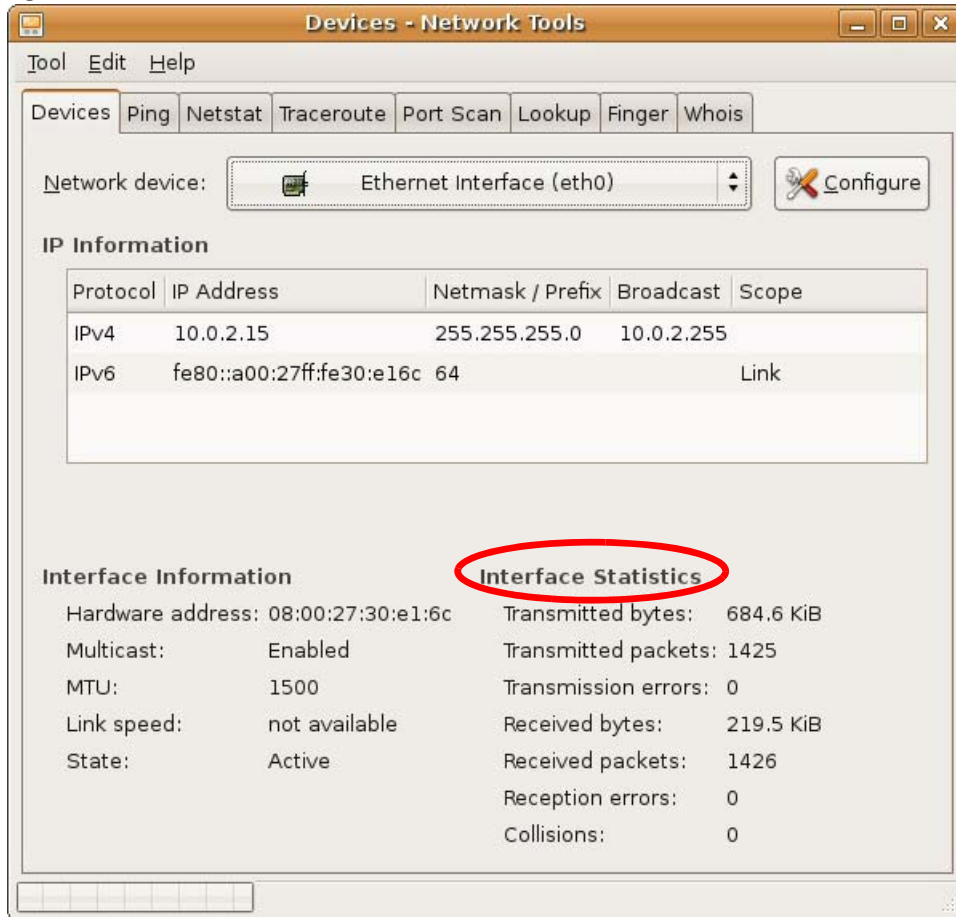

Linux: openSUSE 10.3 (KDE)

This section shows you how to configure your computer's TCP/IP settings in the K Desktop Environment (KDE) using the openSUSE 10.3 Linux distribution. The procedure, screens and file locations may vary depending on your specific distribution, release version, and individual configuration. The following screens use the default openSUSE 10.3 installation.

Note: Make sure you are logged in as the root administrator.

Follow the steps below to configure your computer IP address in the KDE:

- 1 Click **K Menu > Computer > Administrator Settings (YaST)**.

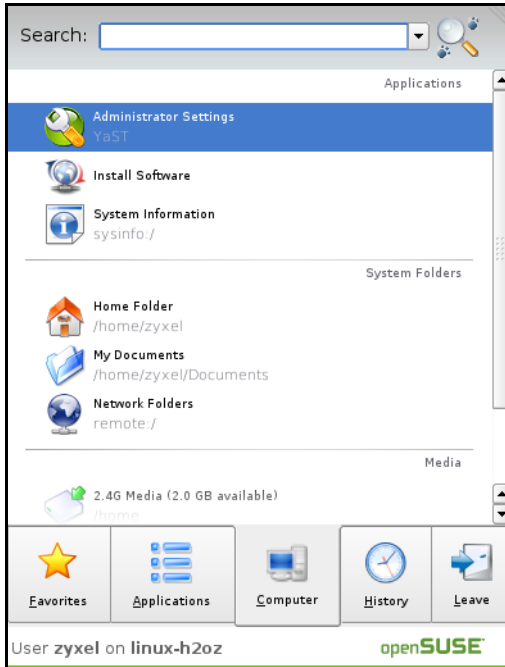

- 2 When the **Run as Root - KDE su** dialog opens, enter the admin password and click **OK**.



- 3 When the **YaST Control Center** window opens, select **Network Devices** and then click the **Network Card** icon.

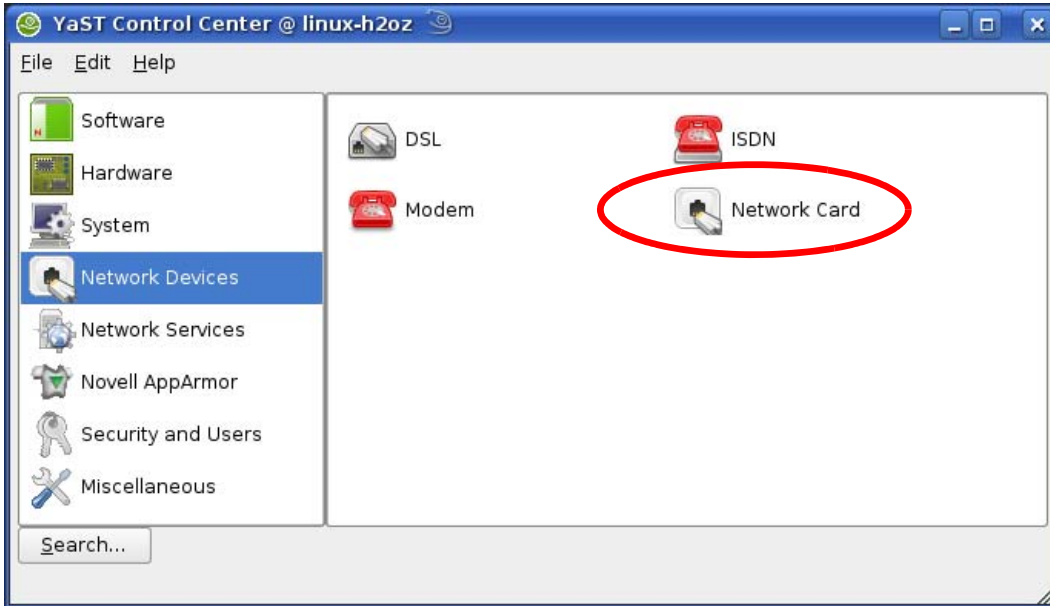

- 4 When the **Network Settings** window opens, click the **Overview** tab, select the appropriate connection **Name** from the list, and then click the **Configure** button.

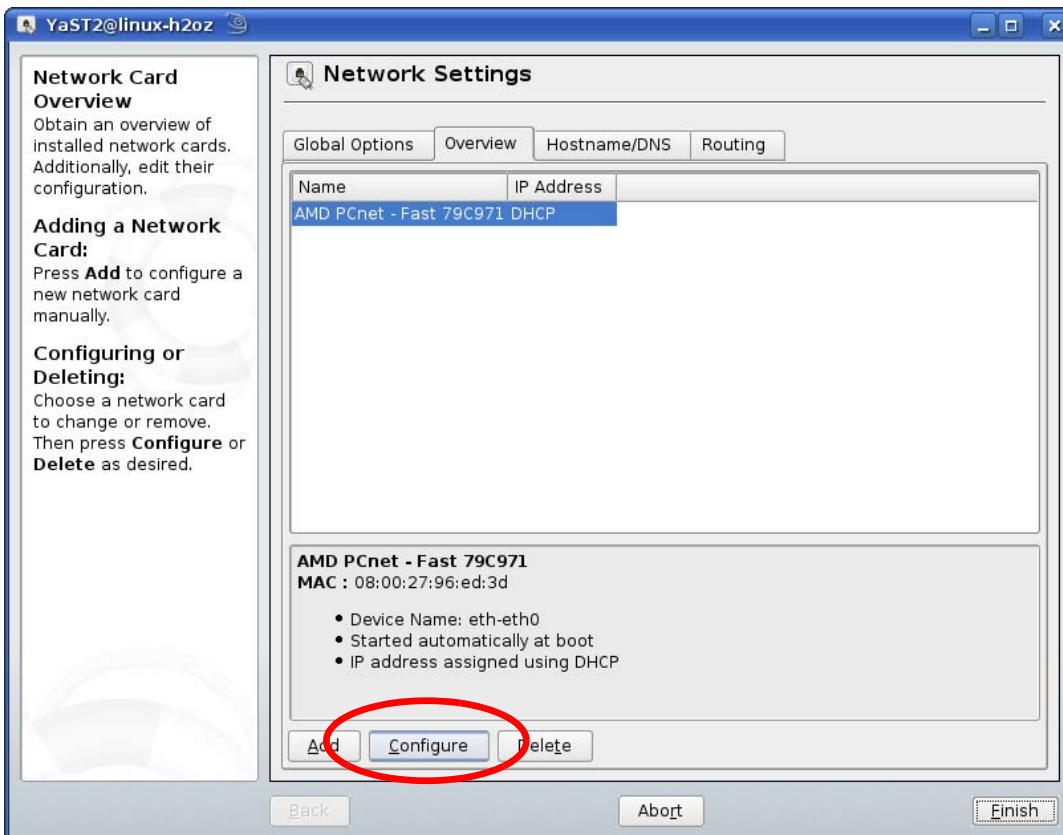

- 5 When the **Network Card Setup** window opens, click the **Address** tab

Figure 113 openSUSE 10.3: Network Card Setup

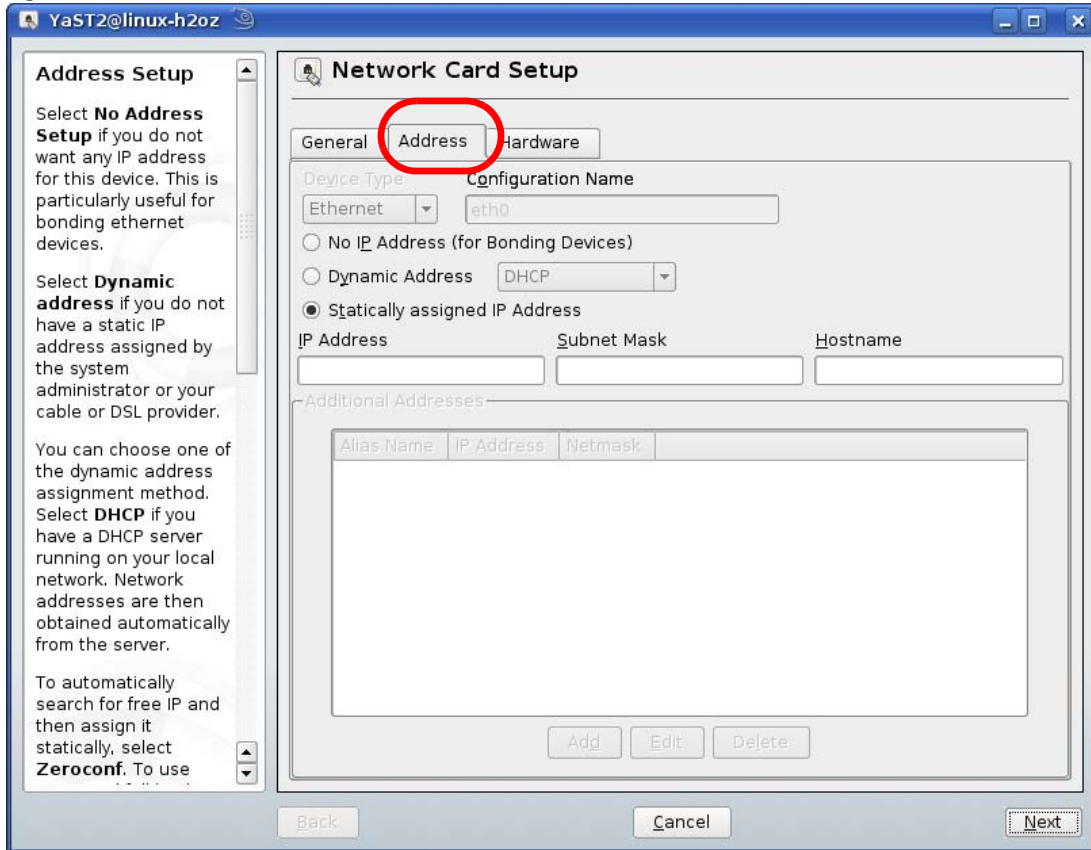

- 6 Select **Dynamic Address (DHCP)** if you have a dynamic IP address.
Select **Statically assigned IP Address** if you have a static IP address. Fill in the **IP address**, **Subnet mask**, and **Hostname** fields.
- 7 Click **Next** to save the changes and close the **Network Card Setup** window.
- 8 If you know your DNS server IP address(es), click the **Hostname/DNS** tab in **Network Settings** and then enter the DNS server information in the fields provided.

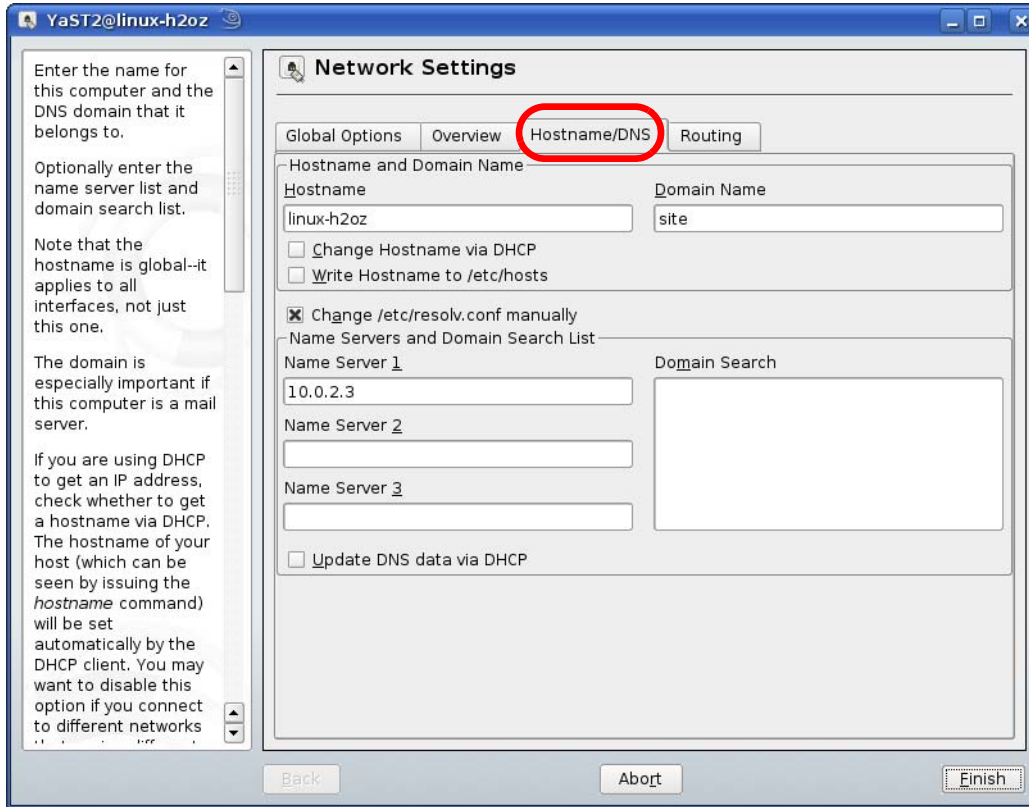

- 9 Click **Finish** to save your settings and close the window.

Verifying Settings

Click the **KNetwork Manager** icon on the **Task bar** to check your TCP/IP properties. From the **Options** sub-menu, select **Show Connection Information**.

Figure 114 openSUSE 10.3: KNetwork Manager

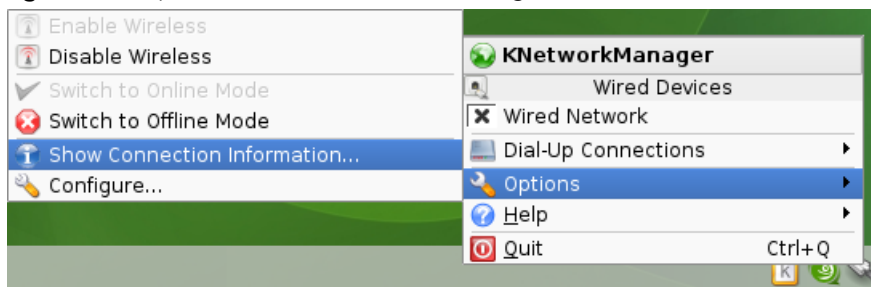

When the **Connection Status - KNetwork Manager** window opens, click the **Statistics** tab to see if your connection is working properly.

Figure 115 openSUSE: Connection Status - KNetwork Manager

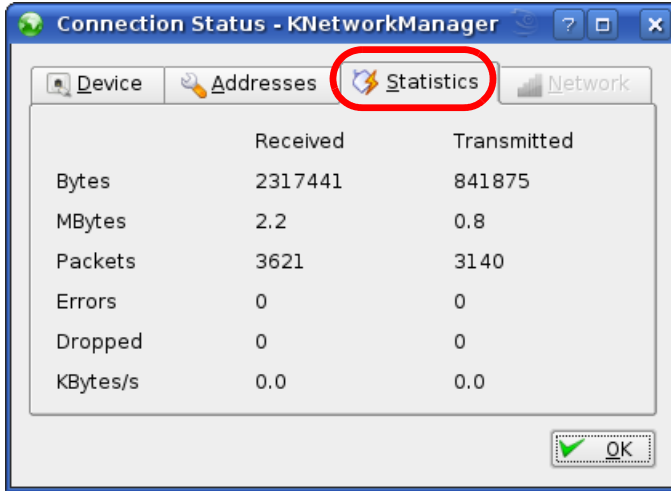

APPENDIX C

Common Services

The following table lists some commonly-used services and their associated protocols and port numbers. For a comprehensive list of port numbers, ICMP type/code numbers and services, visit the IANA (Internet Assigned Number Authority) web site.

- **Name:** This is a short, descriptive name for the service. You can use this one or create a different one, if you like.
- **Protocol:** This is the type of IP protocol used by the service. If this is **TCP/UDP**, then the service uses the same port number with TCP and UDP. If this is **USER-DEFINED**, the **Port(s)** is the IP protocol number, not the port number.
- **Port(s):** This value depends on the **Protocol**. Please refer to RFC 1700 for further information about port numbers.
 - If the **Protocol** is **TCP, UDP, or TCP/UDP**, this is the IP port number.
 - If the **Protocol** is **USER**, this is the IP protocol number.
- **Description:** This is a brief explanation of the applications that use this service or the situations in which this service is used.

Table 62 Commonly Used Services

NAME	PROTOCOL	PORT(S)	DESCRIPTION
AH (IPSEC_TUNNEL)	User-Defined	51	The IPSEC AH (Authentication Header) tunneling protocol uses this service.
AIM/New-ICQ	TCP	5190	AOL's Internet Messenger service. It is also used as a listening port by ICQ.
AUTH	TCP	113	Authentication protocol used by some servers.
BGP	TCP	179	Border Gateway Protocol.
BOOTP_CLIENT	UDP	68	DHCP Client.
BOOTP_SERVER	UDP	67	DHCP Server.
CU-SEEME	TCP UDP	7648 24032	A popular videoconferencing solution from White Pines Software.
DNS	TCP/UDP	53	Domain Name Server, a service that matches web names (for example www.zyxel.com) to IP numbers.
ESP (IPSEC_TUNNEL)	User-Defined	50	The IPSEC ESP (Encapsulation Security Protocol) tunneling protocol uses this service.
FINGER	TCP	79	Finger is a UNIX or Internet related command that can be used to find out if a user is logged on.
FTP	TCP TCP	20 21	File Transfer Program, a program to enable fast transfer of files, including large files that may not be possible by e-mail.
H.323	TCP	1720	NetMeeting uses this protocol.
HTTP	TCP	80	Hyper Text Transfer Protocol - a client/server protocol for the world wide web.
HTTPS	TCP	443	HTTPS is a secured http session often used in e-commerce.

Table 62 Commonly Used Services (continued)

NAME	PROTOCOL	PORT(S)	DESCRIPTION
ICMP	User-Defined	1	Internet Control Message Protocol is often used for diagnostic or routing purposes.
ICQ	UDP	4000	This is a popular Internet chat program.
IGMP (MULTICAST)	User-Defined	2	Internet Group Management Protocol is used when sending packets to a specific group of hosts.
IKE	UDP	500	The Internet Key Exchange algorithm is used for key distribution and management.
IRC	TCP/UDP	6667	This is another popular Internet chat program.
MSN Messenger	TCP	1863	Microsoft Networks' messenger service uses this protocol.
NEW-ICQ	TCP	5190	An Internet chat program.
NEWS	TCP	144	A protocol for news groups.
NFS	UDP	2049	Network File System - NFS is a client/server distributed file service that provides transparent file sharing for network environments.
NNTP	TCP	119	Network News Transport Protocol is the delivery mechanism for the USENET newsgroup service.
PING	User-Defined	1	Packet INternet Groper is a protocol that sends out ICMP echo requests to test whether or not a remote host is reachable.
POP3	TCP	110	Post Office Protocol version 3 lets a client computer get e-mail from a POP3 server through a temporary connection (TCP/IP or other).
PPTP	TCP	1723	Point-to-Point Tunneling Protocol enables secure transfer of data over public networks. This is the control channel.
PPTP_TUNNEL (GRE)	User-Defined	47	PPTP (Point-to-Point Tunneling Protocol) enables secure transfer of data over public networks. This is the data channel.
RCMD	TCP	512	Remote Command Service.
REAL_AUDIO	TCP	7070	A streaming audio service that enables real time sound over the web.
REXEC	TCP	514	Remote Execution Daemon.
RLOGIN	TCP	513	Remote Login.
RTELNET	TCP	107	Remote Telnet.
RTSP	TCP/UDP	554	The Real Time Streaming (media control) Protocol (RTSP) is a remote control for multimedia on the Internet.
SFTP	TCP	115	Simple File Transfer Protocol.
SMTP	TCP	25	Simple Mail Transfer Protocol is the message-exchange standard for the Internet. SMTP enables you to move messages from one e-mail server to another.
SNMP	TCP/UDP	161	Simple Network Management Program.
SNMP-TRAPS	TCP/UDP	162	Traps for use with the SNMP (RFC:1215).
SQL-NET	TCP	1521	Structured Query Language is an interface to access data on many different types of database systems, including mainframes, midrange systems, UNIX systems and network servers.
SSH	TCP/UDP	22	Secure Shell Remote Login Program.

Table 62 Commonly Used Services (continued)

NAME	PROTOCOL	PORT(S)	DESCRIPTION
STRM WORKS	UDP	1558	Stream Works Protocol.
SYSLOG	UDP	514	Syslog allows you to send system logs to a UNIX server.
TACACS	UDP	49	Login Host Protocol used for (Terminal Access Controller Access Control System).
TELNET	TCP	23	Telnet is the login and terminal emulation protocol common on the Internet and in UNIX environments. It operates over TCP/IP networks. Its primary function is to allow users to log into remote host systems.
TFTP	UDP	69	Trivial File Transfer Protocol is an Internet file transfer protocol similar to FTP, but uses the UDP (User Datagram Protocol) rather than TCP (Transmission Control Protocol).
VDOLIVE	TCP	7000	Another videoconferencing solution.

APPENDIX D

Customer Support

In the event of problems that cannot be solved by using this manual, you should contact your vendor. If you cannot contact your vendor, then contact a Zyxel office for the region in which you bought the device.

See <http://www.zyxel.com/homepage.shtml> and also http://www.zyxel.com/about_zyxel/zyxel_worldwide.shtml for the latest information.

Please have the following information ready when you contact an office.

Required Information

- Product model and serial number.
- Warranty Information.
- Date that you received your device.
- Brief description of the problem and the steps you took to solve it.

Corporate Headquarters (Worldwide)

Taiwan

- Zyxel Communications Corporation
- <http://www.zyxel.com>

Asia

China

- Zyxel Communications (Shanghai) Corp.
- Zyxel Communications (Beijing) Corp.
- Zyxel Communications (Tianjin) Corp.
- <http://www.zyxel.cn>

India

- Zyxel Technology India Pvt Ltd
- <http://www.zyxel.in>

Kazakhstan

- Zyxel Kazakhstan
- <http://www.zyxel.kz>

Korea

- Zyxel Korea Corp.
- <http://www.zyxel.kr>

Malaysia

- Zyxel Malaysia Sdn Bhd.
- <http://www.zyxel.com.my>

Pakistan

- Zyxel Pakistan (Pvt.) Ltd.
- <http://www.zyxel.com.pk>

Philippines

- Zyxel Philippines
- <http://www.zyxel.com.ph>

Singapore

- Zyxel Singapore Pte Ltd.
- <http://www.zyxel.com.sg>

Taiwan

- Zyxel Communications Corporation
- <http://www.zyxel.com/tw/zh/>

Thailand

- Zyxel Thailand Co., Ltd
- <http://www.zyxel.co.th>

Vietnam

- Zyxel Communications Corporation-Vietnam Office
- <http://www.zyxel.com/vn/vi>

Europe

Austria

- Zyxel Deutschland GmbH
- <http://www.zyxel.de>

Belarus

- Zyxel BY
- <http://www.zyxel.by>

Belgium

- Zyxel Communications B.V.
- <http://www.zyxel.com/be/nl/>
- <http://www.zyxel.com/be/fr/>

Bulgaria

- Zyxel България
- <http://www.zyxel.com/bg/bg/>

Czech Republic

- Zyxel Communications Czech s.r.o
- <http://www.zyxel.cz>

Denmark

- Zyxel Communications A/S
- <http://www.zyxel.dk>

Estonia

- Zyxel Estonia
- <http://www.zyxel.com/ee/et/>

Finland

- Zyxel Communications
- <http://www.zyxel.fi>

France

- Zyxel France
- <http://www.zyxel.fr>

Germany

- Zyxel Deutschland GmbH
- <http://www.zyxel.de>

Hungary

- Zyxel Hungary & SEE
- <http://www.zyxel.hu>

Italy

- Zyxel Communications Italy
- <http://www.zyxel.it/>

Latvia

- Zyxel Latvia
- <http://www.zyxel.com/lv/lv/homepage.shtml>

Lithuania

- Zyxel Lithuania
- <http://www.zyxel.com/lt/lt/homepage.shtml>

Netherlands

- Zyxel Benelux
- <http://www.zyxel.nl>

Norway

- Zyxel Communications
- <http://www.zyxel.no>

Poland

- Zyxel Communications Poland
- <http://www.zyxel.pl>

Romania

- Zyxel Romania
- <http://www.zyxel.com/ro/ro>

Russia

- Zyxel Russia
- <http://www.zyxel.ru>

Slovakia

- Zyxel Communications Czech s.r.o. organizacna zlozka
- <http://www.zyxel.sk>

Spain

- Zyxel Communications ES Ltd
- <http://www.zyxel.es>

Sweden

- Zyxel Communications
- <http://www.zyxel.se>

Switzerland

- Studerus AG

- <http://www.zyxel.ch/>

Turkey

- Zyxel Turkey A.S.
- <http://www.zyxel.com.tr>

UK

- Zyxel Communications UK Ltd.
- <http://www.zyxel.co.uk>

Ukraine

- Zyxel Ukraine
- <http://www.ua.zyxel.com>

Latin America

Argentina

- Zyxel Communication Corporation
- <http://www.zyxel.com/ec/es/>

Brazil

- Zyxel Communications Brasil Ltda.
- <https://www.zyxel.com/br/pt/>

Ecuador

- Zyxel Communication Corporation
- <http://www.zyxel.com/ec/es/>

Middle East

Israel

- Zyxel Communication Corporation
- <http://il.zyxel.com/homepage.shtml>

Middle East

- Zyxel Communication Corporation
- <http://www.zyxel.com/me/en/>

North America

USA

- Zyxel Communications, Inc. - North America Headquarters
- <http://www.zyxel.com/us/en/>

Oceania

Australia

- Zyxel Communications Corporation
- <http://www.zyxel.com/au/en/>

Africa

South Africa

- Nology (Pty) Ltd.
- <http://www.zyxel.co.za>

APPENDIX E

Legal Information

Copyright

Copyright © 2017 by Zyxel Communications Corporation.

The contents of this publication may not be reproduced in any part or as a whole, transcribed, stored in a retrieval system, translated into any language, or transmitted in any form or by any means, electronic, mechanical, magnetic, optical, chemical, photocopying, manual, or otherwise, without the prior written permission of Zyxel Communications Corporation.

Published by Zyxel Communications Corporation. All rights reserved.

Disclaimer

Zyxel does not assume any liability arising out of the application or use of any products, or software described herein. Neither does it convey any license under its patent rights nor the patent rights of others. Zyxel further reserves the right to make changes in any products described herein without notice. This publication is subject to change without notice.

Regulatory Notice and Statement

UNITED STATES of AMERICA



The following information applies if you use the product within USA area.

FCC EMC Statement

- The device complies with Part 15 of FCC rules. Operation is subject to the following two conditions:
 - (1) This device may not cause harmful interference, and
 - (2) This device must accept any interference received, including interference that may cause undesired operation.
- Changes or modifications not expressly approved by the party responsible for compliance could void the user's authority to operate the device.
- This product has been tested and complies with the specifications for a Class B digital device, pursuant to Part 15 of the FCC Rules. These limits are designed to provide reasonable protection against harmful interference in a residential installation. This device generates, uses, and can radiate radio frequency energy and, if not installed and used according to the instructions, may cause harmful interference to radio communications. However, there is no guarantee that interference will not occur in a particular installation.
- If this device does cause harmful interference to radio or television reception, which is found by turning the device off and on, the user is encouraged to try to correct the interference by one or more of the following measures:
 - Reorient or relocate the receiving antenna
 - Increase the separation between the devices
 - Connect the equipment to an outlet other than the receiver's
 - Consult a dealer or an experienced radio/TV technician for assistance

The following information applies if you use the product with RF function within USA area.

FCC Radiation Exposure Statement

- This device complies with FCC RF radiation exposure limits set forth for an uncontrolled environment.
- This transmitter must be at least 20 cm from the user and must not be co-located or operating in conjunction with any other antenna or transmitter.

CANADA

The following information applies if you use the product within Canada area.

Industry Canada ICES Statement

CAN ICES-3 (B)/NMB-3(B)

Industry Canada RSS-GEN & RSS-247 statement

- This device complies with Industry Canada license-exempt RSS standard(s). Operation is subject to the following two conditions: (1) this device may not cause interference, and (2) this device must accept any interference, including interference that may cause undesired operation of the device.

- This radio transmitter has been approved by Industry Canada to operate with the antenna types listed below with the maximum permissible gain and required antenna impedance for each antenna type indicated. Antenna types not included in this list, having a gain greater than the maximum gain indicated for that type, are strictly prohibited for use with this device.

If the product with 5G wireless function operating in 5150-5250 MHz and 5725-5850 MHz, the following attention must be paid,

- The device for operation in the band 5150-5250 MHz is only for indoor use to reduce the potential for harmful interference to co-channel mobile satellite systems.
- For devices with detachable antenna(s), the maximum antenna gain permitted for devices in the band 5725-5850 MHz shall be such that the equipment still complies with the e.i.r.p. limits specified for point-to-point and non-point-to-point operation as appropriate; and
- The worst-case tilt angle(s) necessary to remain compliant with the e.i.r.p. elevation mask requirement set forth in Section 6.2.2(3) of RSS 247 shall be clearly indicated.

If the product with 5G wireless function operating in 5250-5350 MHz and 5470-5725 MHz, the following attention must be paid.

- For devices with detachable antenna(s), the maximum antenna gain permitted for devices in the bands 5250-5350 MHz and 5470-5725 MHz shall be such that the equipment still complies with the e.i.r.p. limit.
- Le présent appareil est conforme aux CNR d'Industrie Canada applicables aux appareils radio exempts de licence. L'exploitation est autorisée aux deux conditions suivantes : (1) l'appareil ne doit pas produire de brouillage, et (2) l'utilisateur de l'appareil doit accepter tout brouillage radioélectrique subi, même si le brouillage est susceptible d'en compromettre le fonctionnement.
- Le présent émetteur radio de modèle s'il fait partie du matériel de catégorie I) a été approuvé par Industrie Canada pour fonctionner avec les types d'antenne énumérés ci-dessous et ayant un gain admissible maximal et l'impédance requise pour chaque type d'antenne. Les types d'antenne non inclus dans cette liste, ou dont le gain est supérieur au gain maximal indiqué, sont strictement interdits pour l'exploitation de l'émetteur.

Lorsque la fonction sans fil 5G fonctionnant en 5150-5250 MHz and 5725-5850 MHz est activée pour ce produit, il est nécessaire de porter une attention particulière aux choses suivantes

- Les dispositifs fonctionnant dans la bande 5150-5250 MHz sont réservés uniquement pour une utilisation à l'intérieur afin de réduire les risques de brouillage préjudiciable aux systèmes de satellites mobiles utilisant les mêmes canaux;
- Pour les dispositifs munis d'antennes amovibles, le gain maximal d'antenne permis (pour les dispositifs utilisant la bande de 5 725 à 5 850 MHz) doit être conforme à la limite de la p.i.r.e. spécifiée pour l'exploitation point à point et l'exploitation non point à point, selon le cas;
- Les pires angles d'inclinaison nécessaires pour rester conforme à l'exigence de la p.i.r.e. applicable au masque d'élevation, et énoncée à la section 6.2.2 3) du CNR-247, doivent être clairement indiqués.

Lorsque la fonction sans fil 5G fonctionnant en 5250-5350 MHz et 5470-5725 MHz est activée pour ce produit, il est nécessaire de porter une attention particulière aux choses suivantes.

- Pour les dispositifs munis d'antennes amovibles, le gain maximal d'antenne permis pour les dispositifs utilisant les bandes de 5 250 à 5 350 MHz et de 5 470 à 5 725 MHz doit être conforme à la limite de la p.i.r.e.

Industry Canada radiation exposure statement

This device complies with IC radiation exposure limits set forth for an uncontrolled environment. This device should be installed and operated with a minimum distance of 20 cm between the radiator and your body.

Déclaration d'exposition aux radiations:

Cet équipement est conforme aux limites d'exposition aux rayonnements IC établies pour un environnement non contrôlé. Cet équipement doit être installé et utilisé avec un minimum de 20 cm de distance entre la source de rayonnement et votre corps.

EUROPEAN UNION



The following information applies if you use the product within the European Union.

Declaration of Conformity with Regard to EU Directive 2014/53/EU (Radio Equipment Directive, RED)

- Compliance information for 2.4GHz and/or 5GHz wireless products relevant to the EU and other Countries following the EU Directive 2014/53/ EU (RED). And this product may be used in all EU countries (and other countries following the EU Directive 2014/53/EU) without any limitation except for the countries mentioned below table:
- In the majority of the EU and other European countries, the 5GHz bands have been made available for the use of wireless local area networks (LANs). Later in this document you will find an overview of countries in which additional restrictions or requirements or both are applicable. The requirements for any country may evolve. Zyxel recommends that you check with the local authorities for the latest status of their national regulations for the 5GHz wireless LANs.
- If this device for operation in the band 5150-5350 MHz, it is for indoor use only.
- This equipment should be installed and operated with a minimum distance of 20cm between the radio equipment and your body.
- The maximum RF power operating for each band as follows:
 - the LTE band 1 is 255.94 mW,
 - the LTE band 3 is 244.91 mW,
 - the LTE band 7 is 176.60 mW,
 - the LTE band 8 is 195.43 mW,
 - the LTE band 20 is 193.20 mW,
 - the LTE band 28 is 177.01 mW,
 - the LTE band 38 is 328.85 mW,
 - the LTE band 40 is 234.96 mW,
 - the WCDMA band 1 is 220.80 mW
 - the WCDMA band 8 is 173.38 mW
 - the GSM900 is 831.86 mW

- the GSM1800 is 588.84 mW
- WiFi 2.4GHz is 80.17 mW

Български (Bulgarian)	<p>С настоящото Zyxel декларира, че това оборудване е в съответствие със съществените изисквания и другите приложими разпоредбите на Директива 2014/53/ЕС.</p> <p>National Restrictions</p> <ul style="list-style-type: none"> • The Belgian Institute for Postal Services and Telecommunications (BIPT) must be notified of any outdoor wireless link having a range exceeding 300 meters. Please check http://www.bipt.be for more details. • Draadloze verbindingen voor buitengebruik en met een reikwijdte van meer dan 300 meter dienen aangemeld te worden bij het Belgisch Instituut voor postdiensten en telecommunicatie (BIPT). Zie http://www.bipt.be voor meer gegevens. • Les liaisons sans fil pour une utilisation en extérieur d'une distance supérieure à 300 mètres doivent être notifiées à l'Institut Belge des services Postaux et des Télécommunications (IBPT). Visitez http://www.ibpt.be pour de plus amples détails.
Español (Spanish)	<p>Por medio de la presente Zyxel declara que el equipo cumple con los requisitos esenciales y cualesquiera otras disposiciones aplicables o exigibles de la Directiva 2014/53/UE.</p>
Čeština (Czech)	<p>Zyxel tímto prohlašuje, že tento zařazení je ve shodě se základními požadavky a dalšími příslušnými ustanoveními směrnice 2014/53/EU.</p>
Dansk (Danish)	<p>Undertegnede Zyxel erklærer herved, at følgende udstyr overholder de væsentlige krav og øvrige relevante krav i direktiv 2014/53/EU.</p> <p>National Restrictions</p> <ul style="list-style-type: none"> • In Denmark, the band 5150 - 5350 MHz is also allowed for outdoor usage. • I Danmark må frekvensbåndet 5150 - 5350 også anvendes udendørs.
Deutsch (German)	<p>Hiermit erklärt Zyxel, dass sich das Gerät Ausstattung in Übereinstimmung mit den grundlegenden Anforderungen und den übrigen einschlägigen Bestimmungen der Richtlinie 2014/53/EU befindet.</p>
Eesti keel (Estonian)	<p>Käesolevaga kinnitab Zyxel seadme seadme vastavust direktiivi 2014/53/EU põhinõuetele ja nimetatud direktiivist tulenevatele teistele asjakohastele sätetele.</p>
Ελληνικά (Greek)	<p>ΜΕ ΤΗΝ ΠΑΡΟΥΣΙΑ Ζyxel ΔΗΛΩΝΕΙ ΟΤΙ ΕΞΟΤΙΣΜΟΣ ΣΥΜΜΟΡΦΩΝΕΤΑΙ ΠΡΟΣ ΤΙΣ ΟΥΣΙΩΔΕΙΣ ΑΠΑΙΤΗΣΕΙΣ ΚΑΙ ΤΙΣ ΛΟΙΠΕΣ ΣΧΕΤΙΚΕΣ ΔΙΑΤΑΞΕΙΣ ΤΗΣ ΟΔΗΓΙΑΣ 2014/53/EU.</p>
English	<p>Hereby, Zyxel declares that this device is in compliance with the essential requirements and other relevant provisions of Directive 2014/53/EU.</p>
Français (French)	<p>Par la présente Zyxel déclare que l'appareil équipements est conforme aux exigences essentielles et aux autres dispositions pertinentes de la directive 2014/53/UE.</p>
Hrvatski (Croatian)	<p>Zyxel ovime izjavljuje da je radijska oprema tipa u skladu s Direktivom 2014/53/EU.</p>
Íslenska (Icelandic)	<p>Hér með lýsir, Zyxel því yfir að þessi búnaður er í samræmi við grunnkröfur og önnur viðeigandi ákvæði tilskipunar 2014/53/EU.</p>
Italiano (Italian)	<p>Con la presente Zyxel dichiara che questo attrezzatura è conforme ai requisiti essenziali ed alle altre disposizioni pertinenti stabilite dalla direttiva 2014/53/EU.</p> <p>National Restrictions</p> <ul style="list-style-type: none"> • This product meets the National Radio Interface and the requirements specified in the National Frequency Allocation Table for Italy. Unless this wireless LAN product is operating within the boundaries of the owner's property, its use requires a "general authorization." Please check http://www.sviluppoeconomico.gov.it/ for more details. • Questo prodotto è conforme alla specifiche di Interfaccia Radio Nazionali e rispetta il Piano Nazionale di ripartizione delle frequenze in Italia. Se non viene installato all'interno del proprio fondo, l'utilizzo di prodotti Wireless LAN richiede una "Autorizzazione Generale". Consultare http://www.sviluppoeconomico.gov.it/ per maggiori dettagli.
Latviešu valoda (Latvian)	<p>Ar šo Zyxel deklarē, ka iekārtas atbilst Direktīvas 2014/53/EU būtiskajām prasībām un citiem ar to saistītajiem noteikumiem.</p> <p>National Restrictions</p> <ul style="list-style-type: none"> • The outdoor usage of the 2.4 GHz band requires an authorization from the Electronic Communications Office. Please check http://www.esd.lv for more details. • 2.4 GHz frekvenču joslas izmantošanai ārpus telpām nepieciešama atļauja no Elektronisko sakaru direkcijas. Vairāk informācijas: http://www.esd.lv.
Lietuvių kalba (Lithuanian)	<p>Šiuo Zyxel deklaruoja, kad šis įranga atitinka esminius reikalavimus ir kitas 2014/53/EU Direktyvos nuostatas.</p>
Magyar (Hungarian)	<p>Alulírott, Zyxel nyilatkozom, hogy a berendezés megfelel a vonatkozó alapvető követelményeknek és az 2014/53/EU irányelv egyéb előírásainak.</p>
Malti (Maltese)	<p>Hawnhekk, Zyxel, jiddikjara li dan tagħmir jikkonforma mal-ftiġġiet essenzjali u ma provvedimenti oħrajn relevanti li hemm fid-Direttiva 2014/53/EU.</p>
Nederlands (Dutch)	<p>Hierbij verklaart Zyxel dat het toestel uitrusting in overeenstemming is met de essentiële eisen en de andere relevante bepalingen van richtlijn 2014/53/EU.</p>
Polski (Polish)	<p>Niniejszym Zyxel oświadcza, że sprzęt jest zgodny z zasadniczymi wymogami oraz pozostałymi stosownymi postanowieniami Dyrektywy 2014/53/EU.</p>
Português (Portuguese)	<p>Zyxel declara que este equipamento está conforme com os requisitos essenciais e outras disposições da Directiva 2014/53/UE.</p>

Română (Romanian)	Prin prezenta, Zyxel declară că acest echipament este în conformitate cu cerințele esențiale și alte prevederi relevante ale Directivei 2014/53/EU.
Slovenčina (Slovak)	Zyxel týmto vyhlasuje, že zariadenia spĺňa základné požiadavky a všetky príslušné ustanovenia Smernice 2014/53/EU.
Slovenščina (Slovene)	Zyxel izjavlja, da je ta oprema v skladu z bistvenimi zahtevami in ostalimi relevantnimi določili direktive 2014/53/EU.
Suomi (Finnish)	Zyxel vakuuttaa täten että laitteen tyyppinen laite on direktiivin 2014/53/EU oleellisten vaatimusten ja sitä koskevien direktiivin muiden ehtojen mukainen.
Svenska (Swedish)	Härmed intygar Zyxel att denna utrustning står i överensstämmelse med de väsentliga egenskapskrav och övriga relevanta bestämmelser som framgår av direktiv 2014/53/EU.
Norsk (Norwegian)	Erklærer herved Zyxel at dette utstyret er i samsvar med de grunnleggende kravene og andre relevante bestemmelser i direktiv 2014/53/EU.

Notes:

1. Although Norway, Switzerland and Liechtenstein are not EU member states, the EU Directive 2014/53/EU has also been implemented in those countries.
2. The regulatory limits for maximum output power are specified in EIRP. The EIRP level (in dBm) of a device can be calculated by adding the gain of the antenna used (specified in dBi) to the output power available at the connector (specified in dBm).

List of national codes

COUNTRY	ISO 3166 2 LETTER CODE	COUNTRY	ISO 3166 2 LETTER CODE
Austria	AT	Liechtenstein	LI
Belgium	BE	Lithuania	LT
Bulgaria	BG	Luxembourg	LU
Croatia	HR	Malta	MT
Cyprus	CY	Netherlands	NL
Czech Republic	CZ	Norway	NO
Denmark	DK	Poland	PL
Estonia	EE	Portugal	PT
Finland	FI	Romania	RO
France	FR	Serbia	RS
Germany	DE	Slovakia	SK
Greece	GR	Slovenia	SI
Hungary	HU	Spain	ES
Iceland	IS	Switzerland	CH
Ireland	IE	Sweden	SE
Italy	IT	Turkey	TR
Latvia	LV	United Kingdom	GB

Safety Warnings

- Do not use this product near water, for example, in a wet basement or near a swimming pool.
- Do not expose your device to dampness, dust or corrosive liquids.
- Do not store things on the device.
- Do not obstruct the device ventilation slots as insufficient airflow may harm your device. For example, do not place the device in an enclosed space such as a box or on a very soft surface such as a bed or sofa.
- Do not install, use, or service this device during a thunderstorm. There is a remote risk of electric shock from lightning.
- Connect ONLY suitable accessories to the device.
- Do not open the device or unit. Opening or removing covers can expose you to dangerous high voltage points or other risks.
- Only qualified service personnel should service or disassemble this device. Please contact your vendor for further information.
- Make sure to connect the cables to the correct ports.
- Place connecting cables carefully so that no one will step on them or stumble over them.
- Always disconnect all cables from this device before servicing or disassembling.
- Do not remove the plug and connect it to a power outlet by itself; always attach the plug to the power adaptor first before connecting it to a power outlet.
- Do not allow anything to rest on the power adaptor or cord and do NOT place the product where anyone can walk on the power adaptor or cord.
- Please use the provided or designated connection cables/power cables/ adaptors. Connect it to the right supply voltage (for example, 110V AC in North America or 230V AC in Europe). If the power adaptor or cord is damaged, it might cause electrocution. Remove it from the device and the power source, repairing the power adapter or cord is prohibited. Contact your local vendor to order a new one.
- Do not use the device outside, and make sure all the connections are indoors. There is a remote risk of electric shock from lightning.

- CAUTION: Risk of explosion if battery is replaced by an incorrect type, dispose of used batteries according to the instruction. Dispose them at the applicable collection point for the recycling of electrical and electronic devices. For detailed information about recycling of this product, please contact your local city office, your household waste disposal service or the store where you purchased the product.
- The following warning statements apply, where the disconnect device is not incorporated in the device or where the plug on the power supply cord is intended to serve as the disconnect device.
 - For permanently connected devices, a readily accessible disconnect device shall be incorporated external to the device;
 - For pluggable devices, the socket-outlet shall be installed near the device and shall be easily accessible.

Environment Statement

ErP (Energy-related Products)

Zyxel products put on the EU market in compliance with the requirement of the European Parliament and the Council published Directive 2009/125/EC establishing a framework for the setting of ecodesign requirements for energy-related products (recast), so called as "ErP Directive (Energy-related Products directive)" as well as ecodesign requirement laid down in applicable implementing measures, power consumption has satisfied regulation requirements which are:

- Network standby power consumption < 8W, and/or
- Off mode power consumption < 0.5W, and/or
- Standby mode power consumption < 0.5W.

(Wireless setting, please refer to "Wireless" chapter for more detail.)

European Union - Disposal and Recycling Information

The symbol below means that according to local regulations your product and/or its battery shall be disposed of separately from domestic waste. If this product is end of life, take it to a recycling station designated by local authorities. At the time of disposal, the separate collection of your product and/or its battery will help save natural resources and ensure that the environment is sustainable development.

Die folgende Symbol bedeutet, dass Ihr Produkt und/oder seine Batterie gemäß den örtlichen Bestimmungen getrennt vom Hausmüll entsorgt werden muss. Wenden Sie sich an eine Recyclingstation, wenn dieses Produkt das Ende seiner Lebensdauer erreicht hat. Zum Zeitpunkt der Entsorgung wird die getrennte Sammlung von Produkt und/oder seiner Batterie dazu beitragen, natürliche Ressourcen zu sparen und die Umwelt und die menschliche Gesundheit zu schützen.

El símbolo de abajo indica que según las regulaciones locales, su producto y/o su batería deberán depositarse como basura separada de la doméstica. Cuando este producto alcance el final de su vida útil, llévelo a un punto limpio. Cuando llegue el momento de desechar el producto, la recogida por separado éste y/o su batería ayudará a salvar los recursos naturales y a proteger la salud humana y medioambiental.

Le symbole ci-dessous signifie que selon les réglementations locales votre produit et/ou sa batterie doivent être éliminés séparément des ordures ménagères. Lorsque ce produit atteint sa fin de vie, amenez-le à un centre de recyclage. Au moment de la mise au rebut, la collecte séparée de votre produit et/ou de sa batterie aidera à économiser les ressources naturelles et protéger l'environnement et la santé humaine.

Il simbolo sotto significa che secondo i regolamenti locali il vostro prodotto e/o batteria deve essere smaltito separatamente dai rifiuti domestici. Quando questo prodotto raggiunge la fine della vita di servizio portarlo a una stazione di riciclaggio. Al momento dello smaltimento, la raccolta separata del vostro prodotto e/o della sua batteria aiuta a risparmiare risorse naturali e a proteggere l'ambiente e la salute umana.

Symbolen innebär att enligt lokal lagstiftning ska produkten och/eller dess batteri kastas separat från hushållsavfallet. När den här produkten når slutet av sin livslängd ska du ta den till en återvinningsstation. Vid tiden för kasseringen bidrar du till en bättre miljö och mänsklig hälsa genom att göra dig av med den på ett återvinningsställe.



台灣



以下訊息僅適用於產品具有無線功能且銷售至台灣地區

- 第十二條 經型式認證合格之低功率射頻電機，非經許可，公司，商號或使用者均不得擅自變更頻率、加大功率或變更原設計之特性及功能。
- 第十四條 低功率射頻電機之使用不得影響飛航安全及干擾合法通信；經發現有干擾現象時，應立即停用，並改善至無干擾時方得繼續使用。前項合法通信，指依電信法規定作業之無線電通信。低功率射頻電機須忍受合法通信或工業、科學及醫療用電波輻射性電機設備之干擾。
- 無線資訊傳輸設備忍受合法通信之干擾且不得干擾合法通信；如造成干擾，應立即停用，俟無干擾之虞，始得繼續使用。
- 無線資訊傳輸設備的製造廠商應確保頻率穩定性，如依製造廠商使用手冊上所述正常操作，發射的信號應維持於操作頻帶中

以下訊息僅適用於產品操作於 5.25-5.35 兆赫頻帶內並銷售至台灣地區

- 在 5.25-5.35 兆赫頻帶內操作之無線資訊傳輸設備，限於室內使用。

以下訊息僅適用於產品屬於專業安裝並銷售至台灣地區

- 本器材須經專業工程人員安裝及設定，始得設置使用，且不得直接販售給一般消費者。





安全警告 - 為了您的安全，請先閱讀以下警告及指示：

- 請勿將此產品接近水、火焰或放置在高溫的環境。
- 避免設備接觸：
 - 任何液體 - 切勿讓設備接觸水、雨水、高濕度、污水腐蝕性的液體或其他水份。
 - 灰塵及污物 - 切勿接觸灰塵、污物、沙土、食物或其他不合適的材料。
- 雷雨天氣時，不要安裝，使用或維修此設備。有遭受電擊的風險。
- 切勿重摔或撞擊設備，並勿使用不正確的電源變壓器。
- 若接上不正確的電源變壓器會有爆炸的風險。
- 請勿隨意更換產品內的電池。
- 如果更換不正確之電池型式，會有爆炸的風險，請依製造商說明書處理使用過之電池。
- 請將廢電池丟棄在適當的電器或電子設備回收處。
- 請勿將設備解體。
- 請勿阻礙設備的散熱孔，空氣對流不足將會造成設備損害。
- 請插在正確的電壓供給插座（如：北美 / 台灣電壓 110V AC，歐洲是 230V AC）。
- 假若電源變壓器或電源變壓器的纜線損壞，請從插座拔除，若您還繼續插電使用，會有觸電死亡的風險。
- 請勿試圖修理電源變壓器或電源變壓器的纜線，若有毀損，請直接聯絡您購買的店家，購買一個新的電源變壓器。
- 請勿將此設備安裝於室外，此設備僅適合放置於室內。
- 請勿隨一般垃圾丟棄。
- 請參閱產品背貼上的設備額定功率。
- 請參考產品型錄或是彩盒上的作業溫度。
- 產品沒有斷電裝置或者採用電源線的插頭視為斷電裝置的一部分，以下警語將適用：
 - 對永久連接之設備，在設備外部須安裝可觸及之斷電裝置；
 - 對插接式之設備，插座必須接近安裝之地點而且是易於觸及的。

About the Symbols

Various symbols are used in this product to ensure correct usage, to prevent danger to the user and others, and to prevent property damage. The meaning of these symbols are described below. It is important that you read these descriptions thoroughly and fully understand the contents.

Explanation of the Symbols

SYMBOL	EXPLANATION
	Alternating current (AC): AC is an electric current in which the flow of electric charge periodically reverses direction.
	Direct current (DC): DC if the unidirectional flow or movement of electric charge carriers.
	Earth; ground: A wiring terminal intended for connection of a Protective Earthing Conductor.
	Class II equipment: The method of protection against electric shock in the case of class II equipment is either double insulation or reinforced insulation.

Viewing Certifications

Go to <http://www.zyxel.com> to view this product's documentation and certifications.

Zyxel Limited Warranty

Zyxel warrants to the original end user (purchaser) that this product is free from any defects in material or workmanship for a specific period (the Warranty Period) from the date of purchase. The Warranty Period varies by region. Check with your vendor and/or the authorized Zyxel local distributor for details about the Warranty Period of this product. During the warranty period, and upon proof of purchase, should the product have indications of failure due to faulty workmanship and/or materials, Zyxel will, at its discretion, repair or replace the defective products or components without charge for either parts or labor, and to whatever extent it shall deem necessary to restore the product or components to

proper operating condition. Any replacement will consist of a new or re-manufactured functionally equivalent product of equal or higher value, and will be solely at the discretion of Zyxel. This warranty shall not apply if the product has been modified, misused, tampered with, damaged by an act of God, or subjected to abnormal working conditions.

Note

Repair or replacement, as provided under this warranty, is the exclusive remedy of the purchaser. This warranty is in lieu of all other warranties, express or implied, including any implied warranty of merchantability or fitness for a particular use or purpose. Zyxel shall in no event be held liable for indirect or consequential damages of any kind to the purchaser.

To obtain the services of this warranty, contact your vendor. You may also refer to the warranty policy for the region in which you bought the device at http://www.zyxel.com/web/support_warranty_info.php.

Registration

Register your product online to receive e-mail notices of firmware upgrades and information at www.zyxel.com for global products, or at www.us.zyxel.com for North American products.

Open Source Licenses

This product contains in part some free software distributed under GPL license terms and/or GPL like licenses. Open source licenses are provided with the firmware package. You can download the latest firmware at www.zyxel.com. To obtain the source code covered under those Licenses, please contact support@zyxel.com.tw to get it.

Index

A

- ACS [123](#)
- ActiveX [109](#)
- Address Assignment [50](#)
- Auto Configuration Server, see ACS [123](#)

B

- Bandwidth management
 - overview [113](#)
 - priority [115](#)

C

- certifications [185](#)
 - viewing [187](#)
- Channel [23](#)
- channel [61](#)
- Configuration
 - restore [131](#)
- configuration
 - static route [126](#)
- contact information [176](#)
- content filtering
 - by keyword (in URL) [108](#)
- Cookies [109](#)
- copyright [182](#)
- CPU usage [24](#)
- customer support [176](#)

D

- Daylight saving [129](#)
- DDNS [96](#)
 - see also Dynamic DNS

- service providers [96, 111](#)
- DHCP [43, 82](#)
 - DHCP server
 - see also Dynamic Host Configuration Protocol
 - DHCP server [81, 82](#)
 - disclaimer [182](#)
 - DNS [85](#)
 - DNS Server [50](#)
 - DNS server [85](#)
 - Domain Name System [85](#)
 - Domain Name System. See DNS.
 - Dynamic DNS [96](#)
 - Dynamic Host Configuration Protocol [82](#)
 - DynDNS [96, 111](#)
 - DynDNS see also DDNS [96, 111](#)

E

- encryption [62](#)
 - and local (user) database [63](#)
 - key [63](#)
 - WPA compatible [63](#)
- ESSID [136](#)

F

- Firewall
 - guidelines [104](#)
 - ICMP packets [105](#)
- firewall
 - stateful inspection [103](#)
- Firmware upload [129](#)
 - file extension
 - using HTTP
- firmware version [23](#)

G

General wireless LAN screen [63](#)

I

IGMP [50](#)
see also Internet Group Multicast Protocol
version
IGMP version [50](#)
interface group [101](#)
Internet Group Multicast Protocol [50](#)
Internet Protocol version 6 [51](#)
IP Address [81, 89](#)
IP Pool [83](#)
IPv6 [51](#)
addressing [51](#)
prefix [51](#)
prefix length [51](#)

J

Java [109](#)

L

LAN [80](#)
IP pool setup [82](#)
LAN overview [80](#)
LAN setup [80](#)
Language [132](#)
Link type [24](#)
local (user) database [62](#)
and encryption [63](#)
Local Area Network [80](#)
logout
Web Configurator [19](#)

M

MAC [72](#)
MAC address [61](#)
MAC address filter [61](#)
MAC address filtering [72](#)
MAC filter [72](#)
managing the device
good habits [12](#)
using the web configurator. See web configurator.
using the WPS. See WPS.
Media access control [72](#)
Memory usage [24](#)
Multicast [50](#)
IGMP [50](#)

N

NAT [87, 88](#)
overview [87](#)
port forwarding [93](#)
see also Network Address Translation
server sets [93](#)
NAT Traversal [117](#)
Navigation Panel [19](#)
navigation panel [19](#)
Network Address Translation [87, 88](#)

P

Pool Size [83](#)
Port forwarding [89, 93](#)
default server [88, 93](#)
example [94](#)
local server [89](#)
port numbers
services
port speed [24](#)

Q

Quality of Service (QoS) [75](#)

R

RADIUS server [62](#)
 remote management
 TR-069 [123](#)
 Remote Procedure Calls, see RPCs [123](#)
 Reset button [12](#)
 Reset the device [12](#)
 Restore configuration [131](#)
 Roaming [74](#)
 RPPCs [123](#)
 RTS/CTS Threshold [61, 74](#)

S

Scheduling [77](#)
 Service and port numbers [107, 116](#)
 Service Set [64, 71](#)
 Service Set IDentification [64, 71](#)
 Service Set IDentity. See SSID.
 setup
 static route [126](#)
 SSID [23, 61, 64, 71](#)
 stateful inspection firewall [103](#)
 Static DHCP [84](#)
 Static Route [98](#)
 static route
 configuration [126](#)
 Status [21](#)
 Subnet Mask [81](#)
 Summary
 DHCP table [43](#)
 Packet statistics [44, 46](#)
 Wireless station status [45](#)
 System General Setup [125](#)
 System restart [132](#)

T

TCP/IP configuration [82](#)
 Time setting [127](#)
 TR-069 [123](#)

 ACS setup [123](#)
 trigger port [94](#)
 Trigger port forwarding [94](#)
 example [94](#)
 process [94](#)

U

Universal Plug and Play [117](#)
 Application [117](#)
 Security issues [117](#)
 UPnP [117](#)
 URL Keyword Blocking [109](#)
 user authentication [62](#)
 local (user) database [62](#)
 RADIUS server [62](#)
 User Name [97](#)

W

WAN (Wide Area Network) [49](#)
 warranty [187](#)
 note [188](#)
 Web Configurator
 how to access [16](#)
 Overview [16](#)
 web configurator [12](#)
 Web Proxy [109](#)
 WEP Encryption [67, 68](#)
 WEP encryption [66](#)
 WEP key [66](#)
 Wireless association list [45](#)
 wireless channel [136](#)
 wireless LAN [136](#)
 wireless LAN scheduling [77](#)
 Wireless network
 basic guidelines [60](#)
 channel [61](#)
 encryption [62](#)
 example [60](#)
 MAC address filter [61](#)
 overview [60](#)
 security [61](#)

SSID [61](#)
Wireless security [61](#)
 overview [61](#)
 type [61](#)
wireless security [136](#)
Wireless tutorial [30](#)
Wizard setup [25](#)
WLAN button [13](#)
WPA compatible [63](#)
WPS [12](#)