

# INTERLINE

## INTERLINE BALI FILTERHOUSE STANDARD

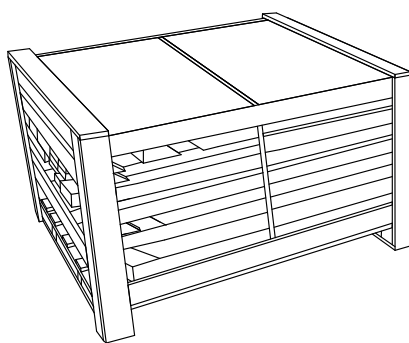
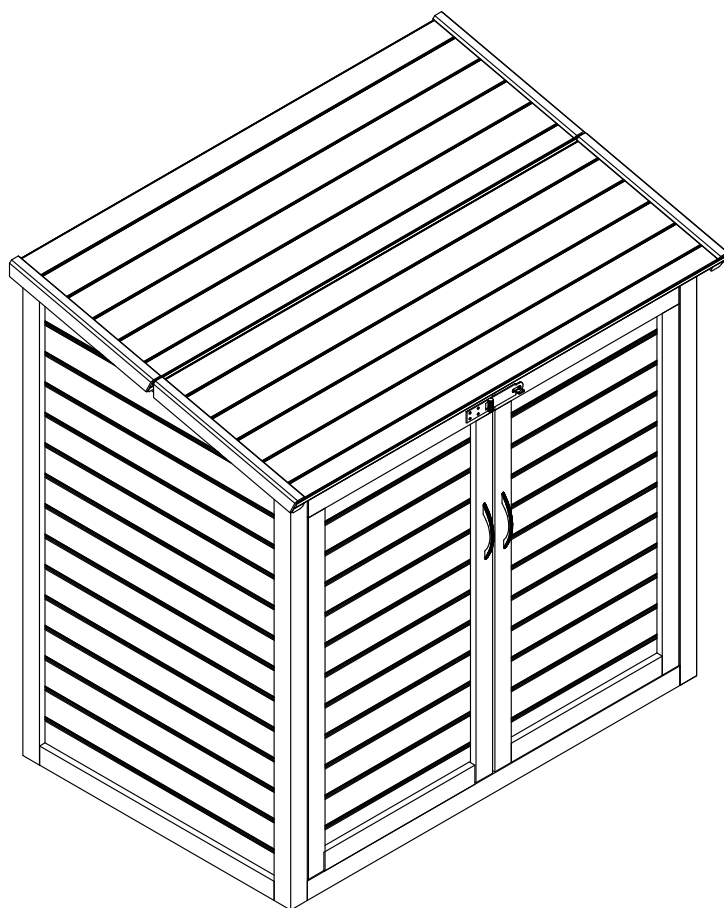

- PL Instrukcja montażu
- FR Notice de montage
- GB Assembly instructions
- IT Istruzioni di montaggio
- DE Montageanleitung
- NL Montage-instructies

**(PL)** Instrukcja montażu

**(GB)** Assembly instructions

**(DE)** Montageanleitung

**(FR)** Notice de montage

**(IT)** Istruzioni di montaggio

**(NL)** Montage-instructies



**(PL)** Przed przystąpieniem do montażu zapoznaj się z instrukcją.

**(FR)** Avant le montage lisez attentivement la notice.

**(GB)** Read carefully assembly manual before the installation.

**(IT)** Prima del montaggio è necessario consultare il manuale.

**(DE)** Vor der Montage machen Sie sich bitte mit der Bedienungsanleitung bekannt.

**(NL)** Lees aandachtig de montage instructie van het zwembad voor de installatie.

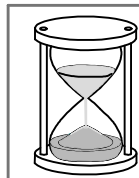

3 h

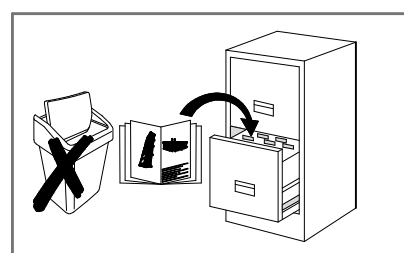
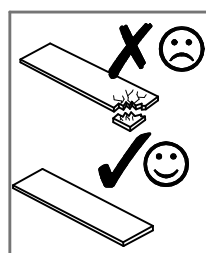
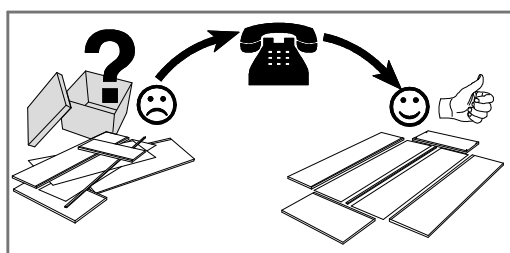
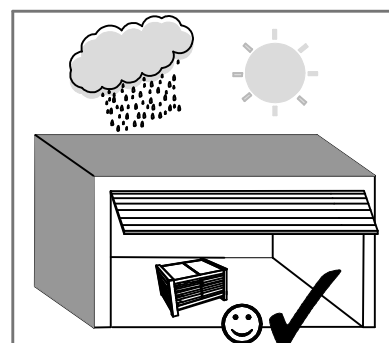
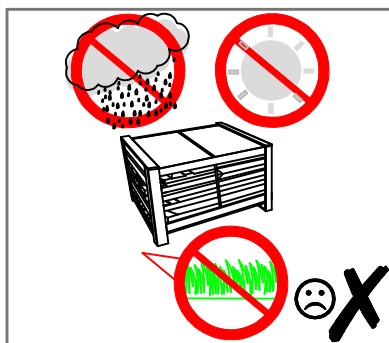
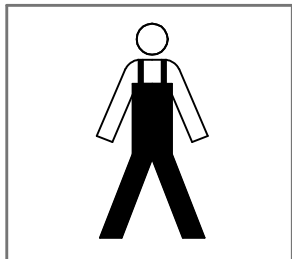

**UWAGA / ATTENTION / NOTE / ATENZIONE / HINWEIS / LETOP**

**(PL)** Montaż wykonać w przeciągu 3 dni od rozpakowania struktury.

**(FR)** Il faut monter la structure au cours de 3 jours de l'ouverture du colis.

**(GB)** Installation should be finished within 3 days from opening the package.

**(IT)** Il montaggio effettuare entro 3 giorni dal disimballo della struttura.

**(DE)** Die Montage ist innerhalb von 3 Tagen zu machen, nachdem die Konstruktion geöffnet wird.

**(NL)** De installatie moet worden afgewerkt binnen 3 dagen na het openen van de verpakking.

**UWAGA / ATTENTION / NOTE / ATENZIONE / HINWEIS / LETOP**

**(PL)** Brak corocznej konserwacji struktury powoduje utratę gwarancji.

**(FR)** Le manque de la conseravtion annuelle de la structure cause la perte de la garantie.

**(GB)** Lack of once a year conservation of the structure causes loss of warranty.

**(IT)** Mancanza della manutenzione annuale causa la perdita di garanzia.

**(DE)** Keine jährliche Wartung der Konstruktion macht das, das die Garantie verloren geht.

**(NL)** Behandel elk jaar de buitenkant van het zwembad met een beits, anders vervalt de garantie.

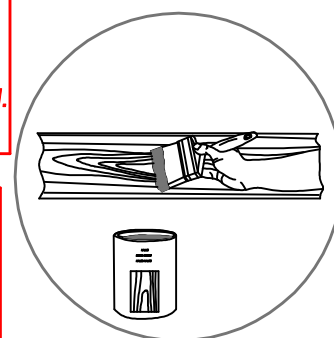

**UWAGA / ATTENTION / NOTE / ATENZIONE / HINWEIS / LETOP**

**(PL)** Nie pozostawiać dzieci bez nadzoru!

**(FR)** Ne laissez pas les enfants sans surveillance!

**(GB)** Do not leave children unattended!

**(IT)** Non lasciare bambini incustoditi!

**(DE)** Lassen Sie Kinder nicht unbeaufsichtigt!

**(NL)** Laat kinderen niet zonder toezicht!

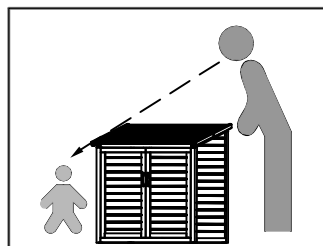

**PL** Elementy

**GB** Elements

**DE** Elemente

**FR** Les éléments

**IT** Elementi

**NL** Balken



- PL** Sprawdź ilość oraz czy elementy nie są uszkodzone.
- FR** Vérifiez la quantité et si les éléments ne sont pas abîmés.
- GB** Check quantity of elements and if they are not faulty.
- IT** Controllare la quantità e se gli elementi non sono danneggiati.
- DE** Überprüfen Sie die Menge, und ob die Elemente nicht beschädigt sind.
- NL** Controleer de aantal balken, en op eventuele beschadigingen.

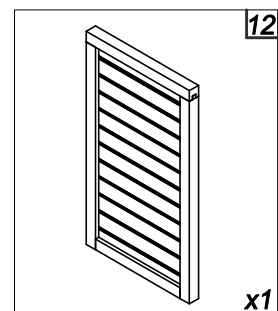
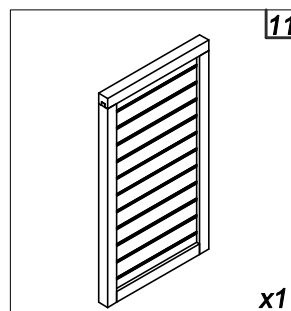
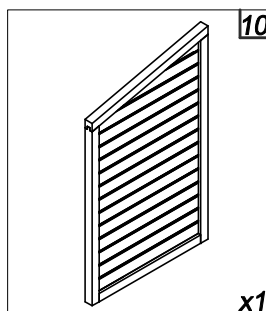
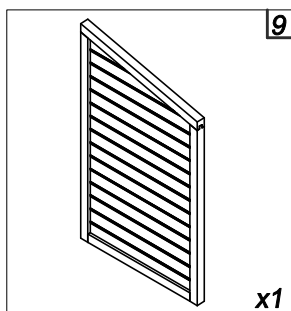
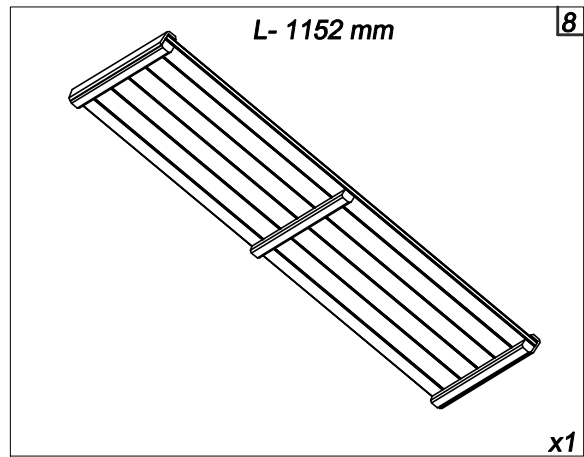
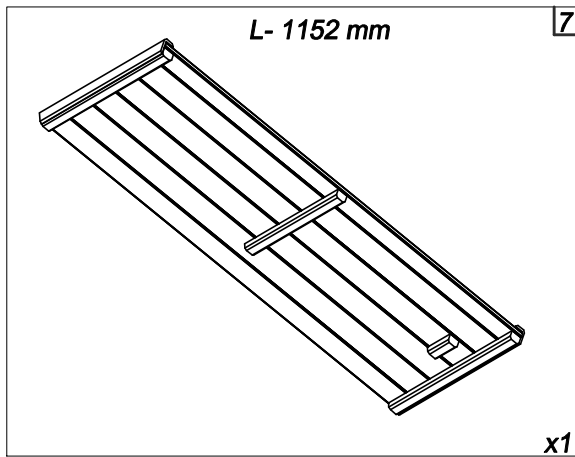
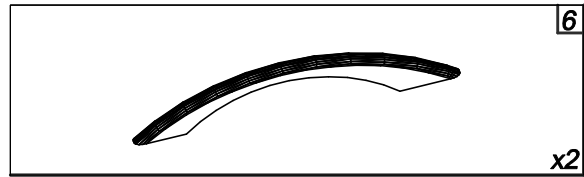
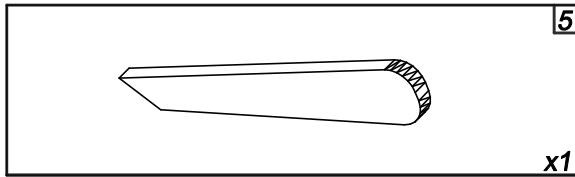
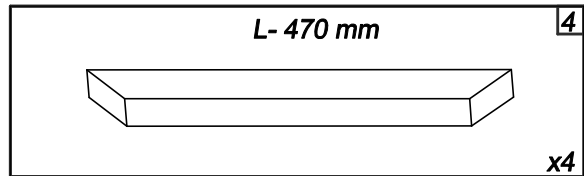
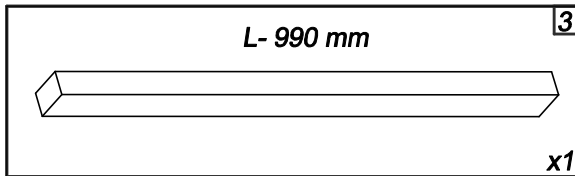
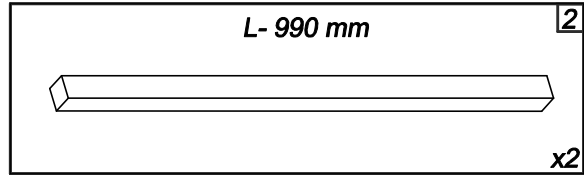
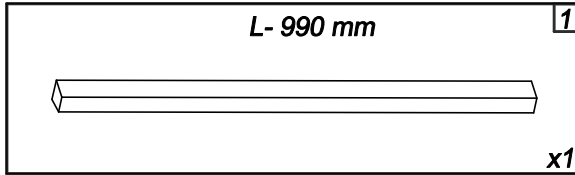
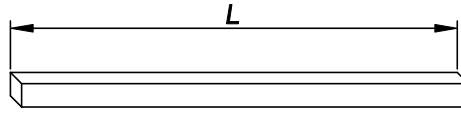

**PL** Okucia i osprzęt

**GB** Fittings and equipment

**DE** Beschläge und Ausrüstung

**FR** Quincaillerie et l'équipement

**IT** Ferramenti e accessori

**NL** Bouwmaterialen



**PL** Sprawdź ilość.

**FR** Vérifiez la quantité.

**GB** Check quantity.

**IT** Controllare la quantità.

**DE** Überprüfen Sie die Menge.

**NL** Controleer het aantal.

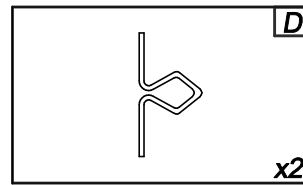
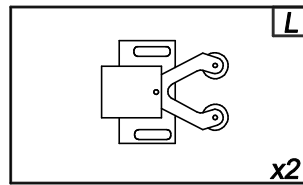
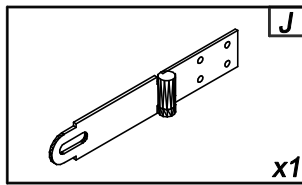
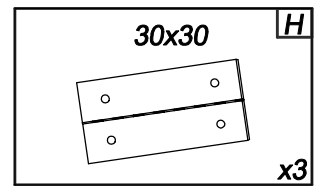
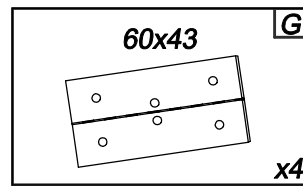
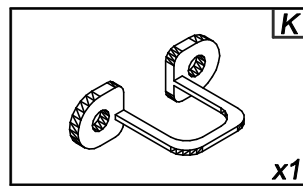
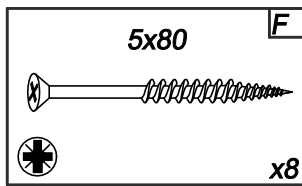
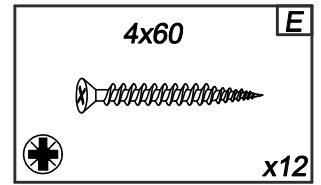
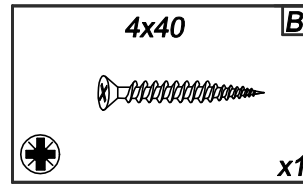
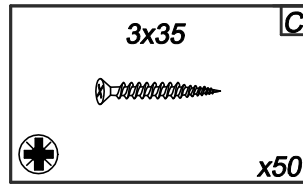
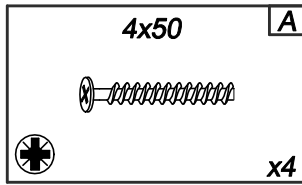

**PL** Przygotuj niezbędne narzędzia - niezawarte w zestawie

**IT** Preparare gli strumenti necessari - non inclusi nel set.

**FR** Préparez les outils nécessaires - pas inclus.

**DE** Bereiten Sie notwendiges, nicht im Satz enthaltenes Werkzeug vor.

**GB** Prepare essential tools - not included.

**NL** Benodigd gereedschap - niet inbegrepen.

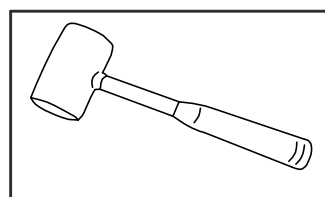
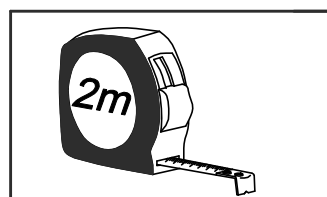
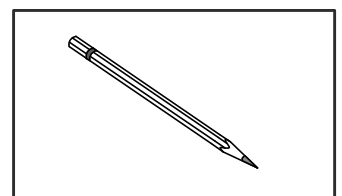
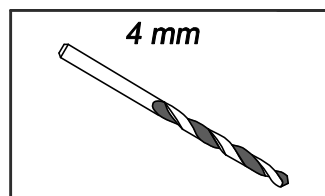
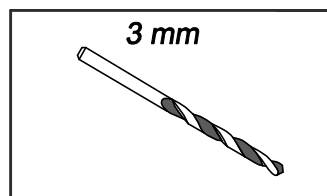
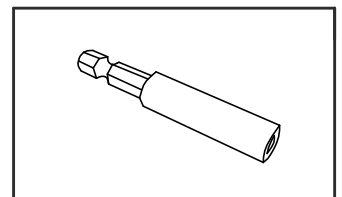
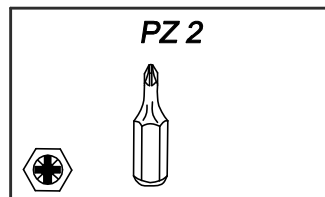
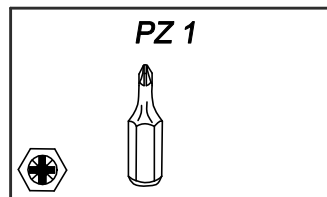
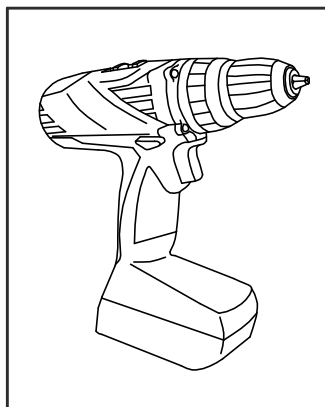

**(PL)** Struktura drewniana

**(GB)** Wooden structure

**(DE)** Holzstruktur

**(FR)** La structure bois

**(IT)** Struttura in legno

**(NL)** Houten structuur

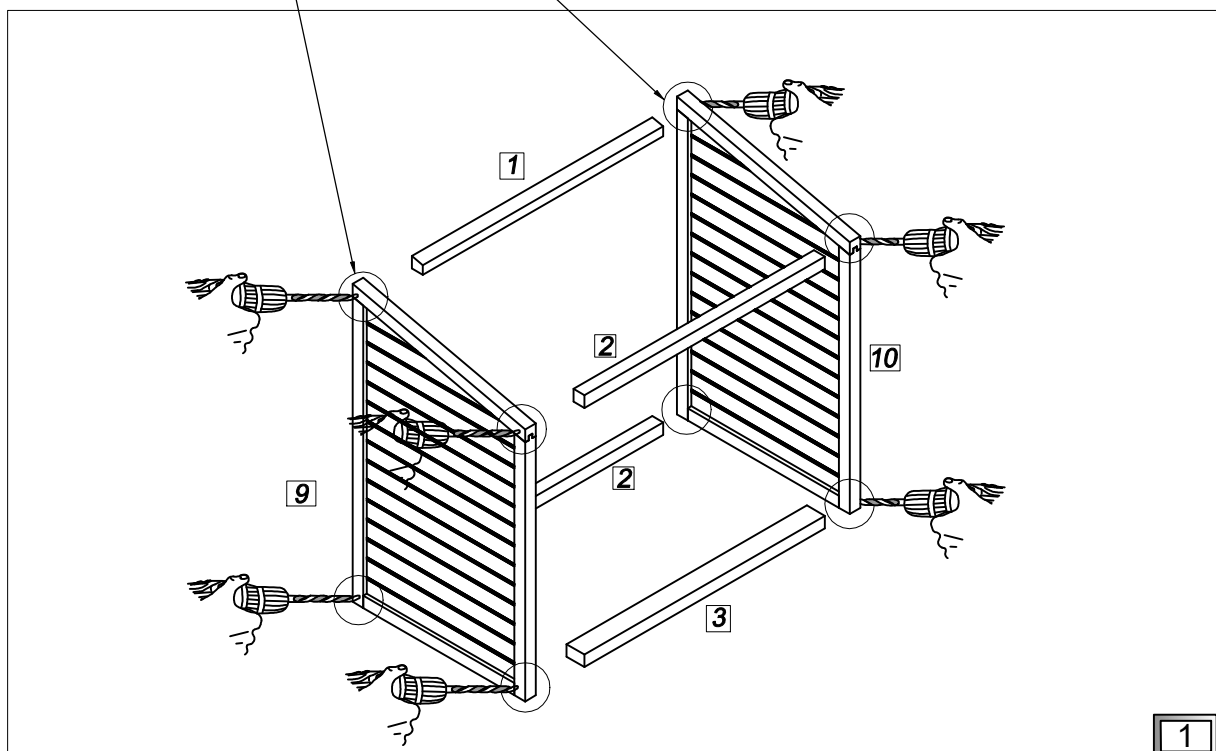
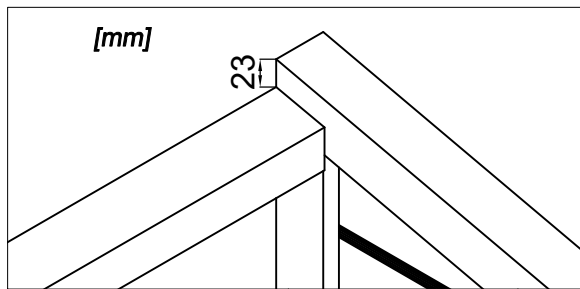
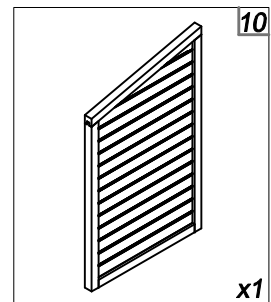
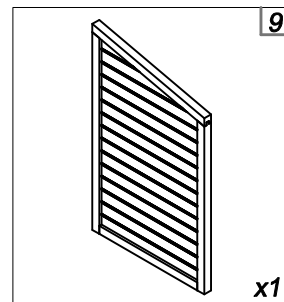
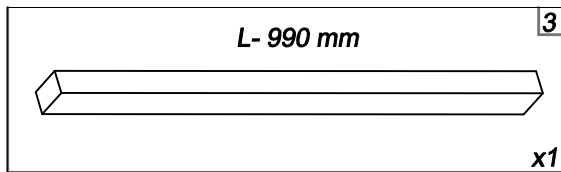
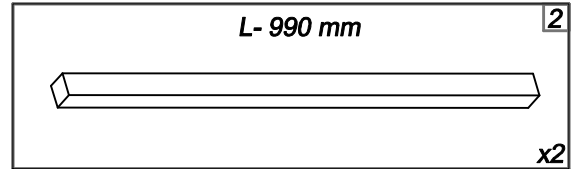
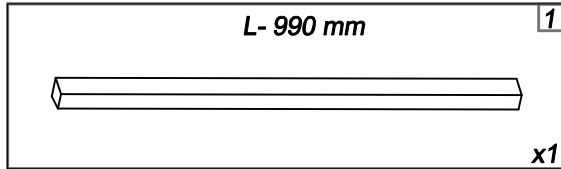
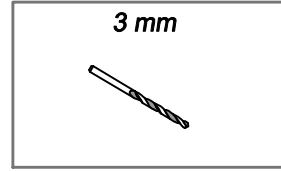
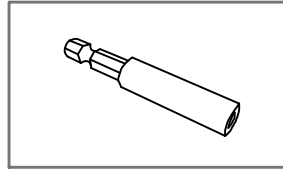
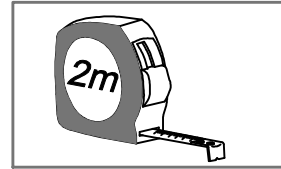
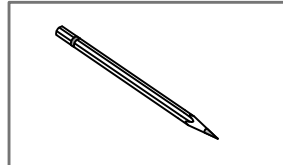
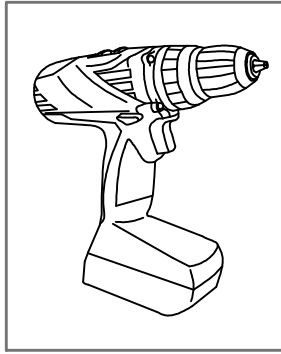

**(PL)** Struktura drewniana

**(GB)** Wooden structure

**(DE)** Holzstruktur

**(FR)** La structure bois

**(IT)** Struttura in legno

**(NL)** Houten structuur

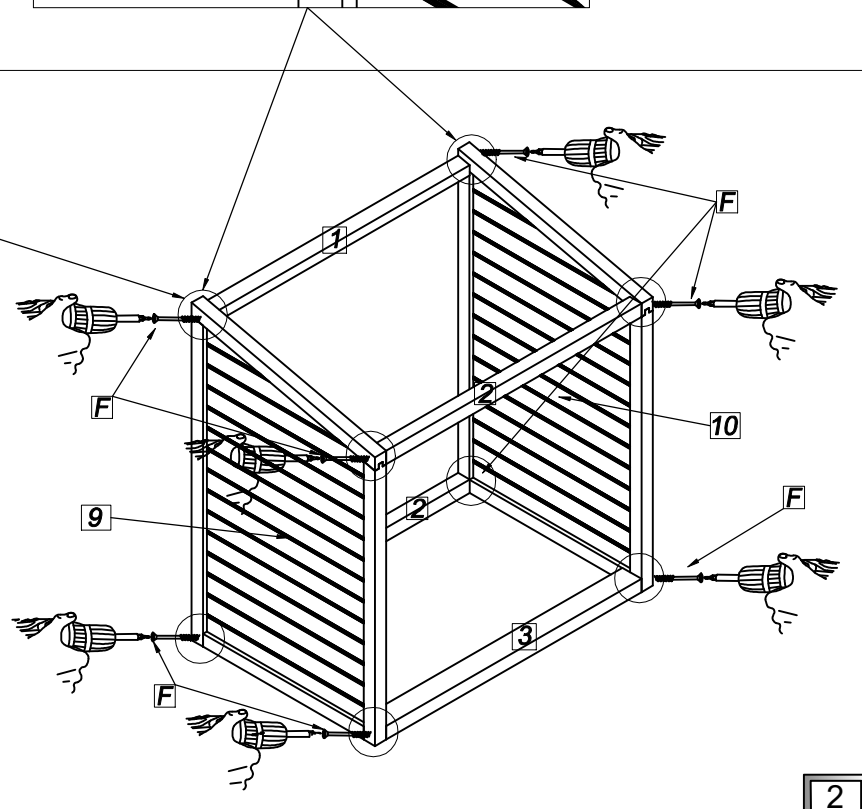
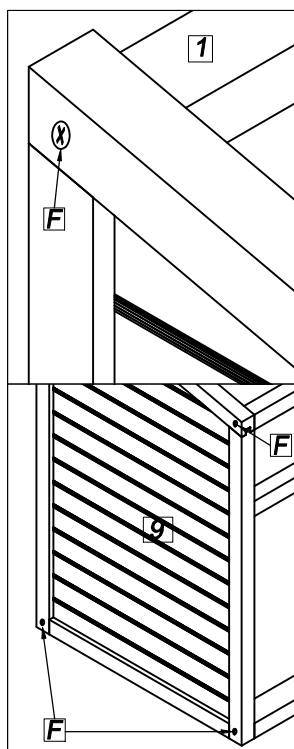
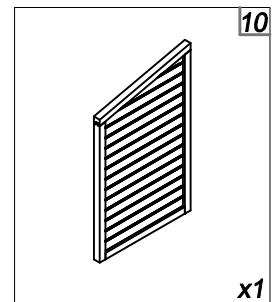
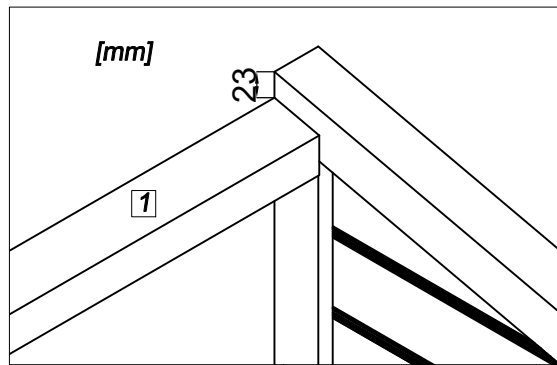
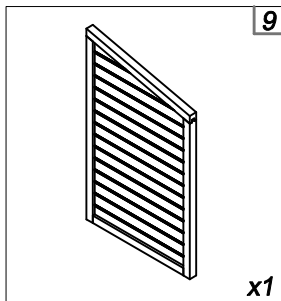
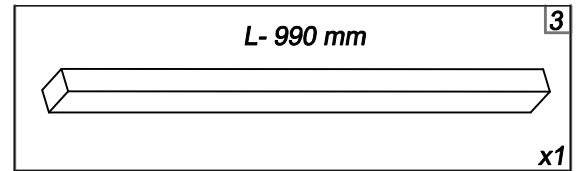
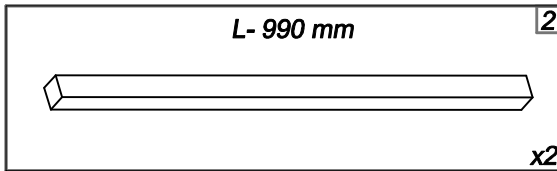
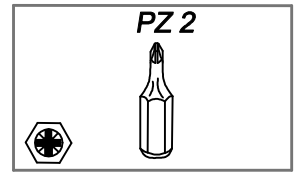
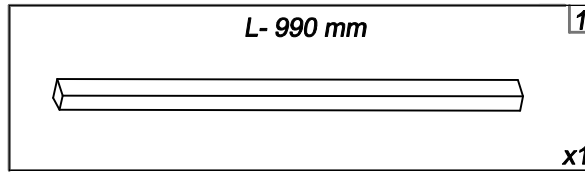
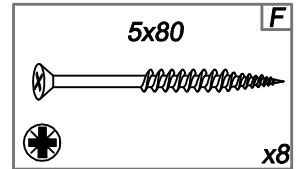
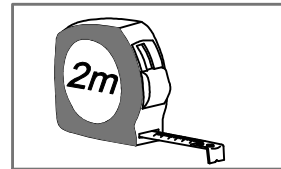
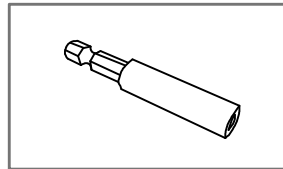
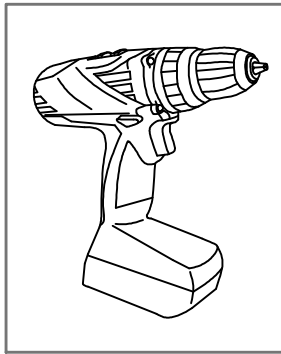

**PL** Struktura drewniana

**GB** Wooden structure

**DE** Holzstruktur

**FR** La structure bois

**IT** Struttura in legno

**NL** Houten structuur

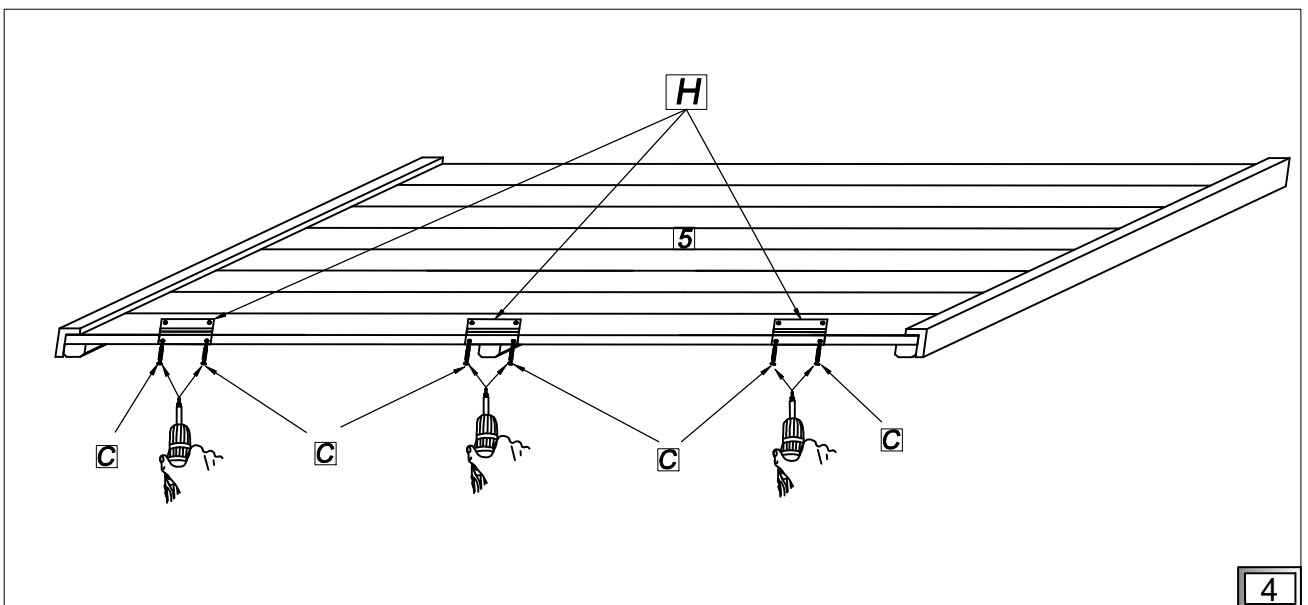
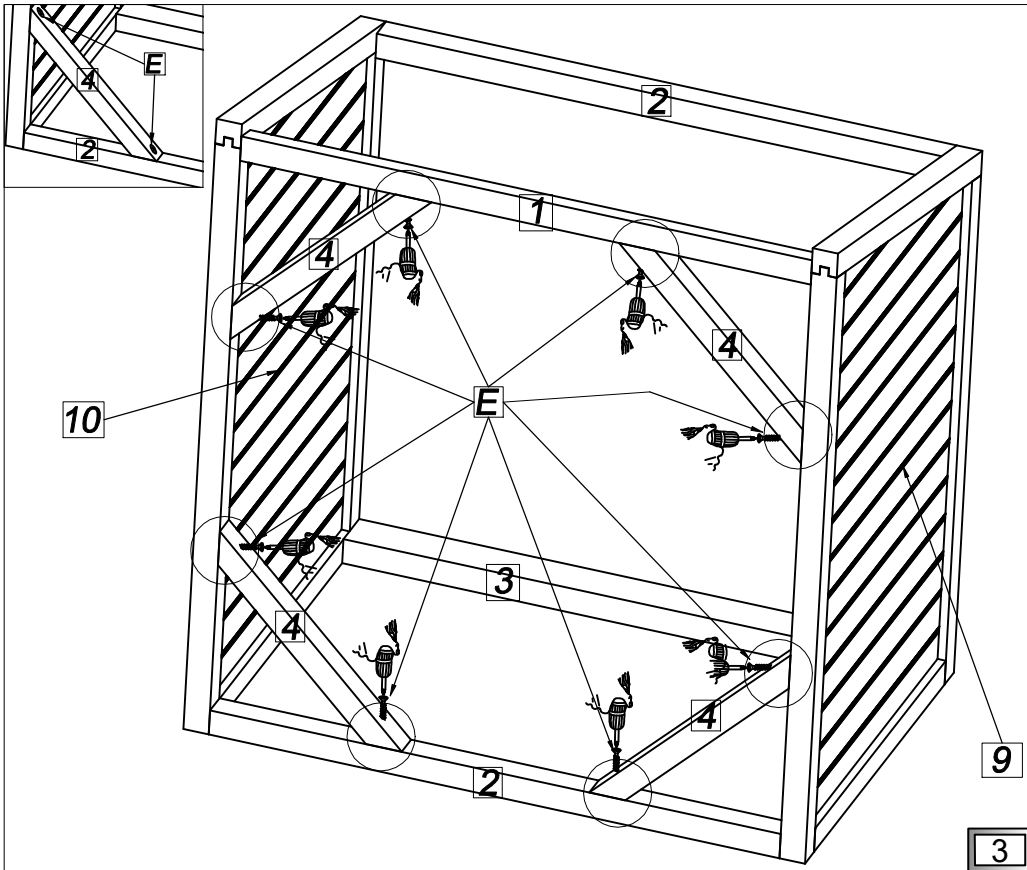
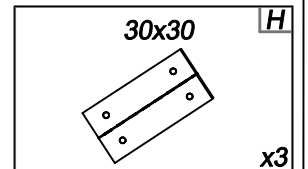
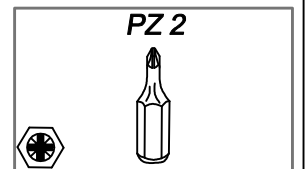
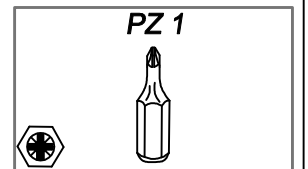
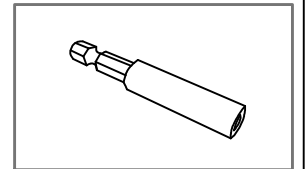
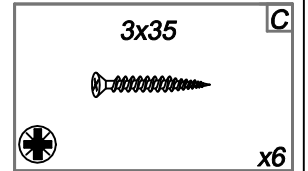
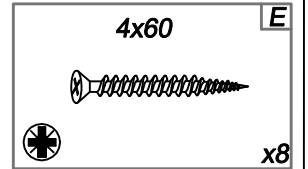
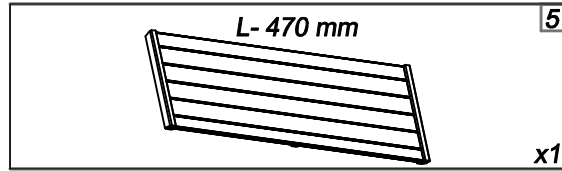
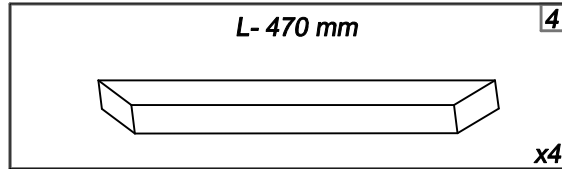
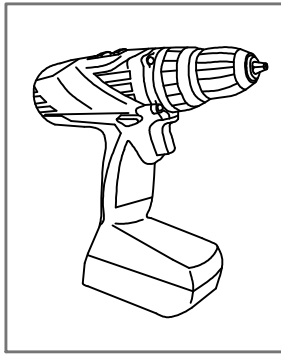

**PL** Struktura drewniana

**GB** Wooden structure

**DE** Holzstruktur

**FR** La structure bois

**IT** Struttura in legno

**NL** Houten structuur

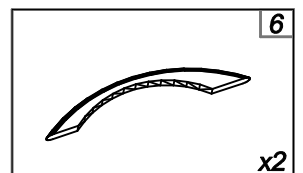
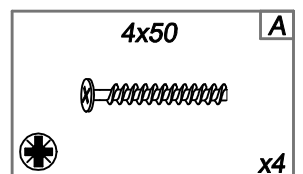
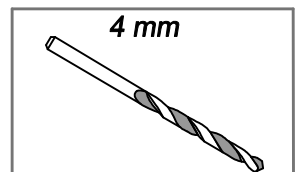
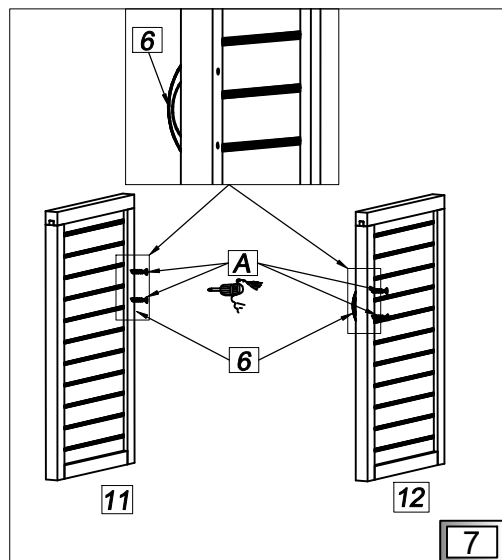
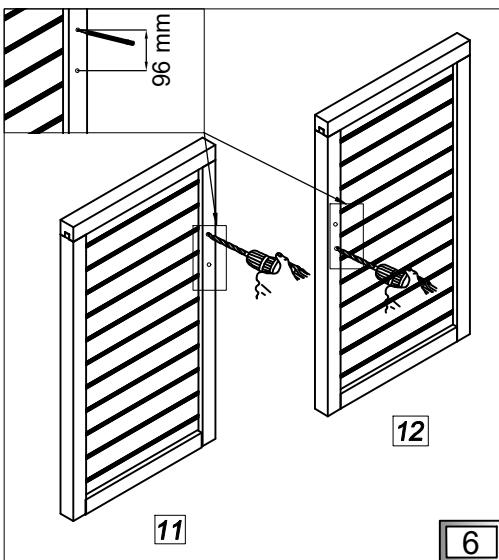
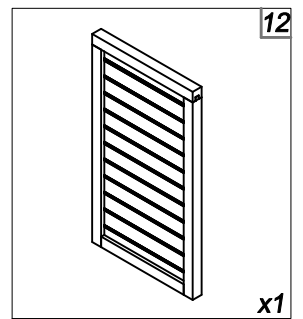
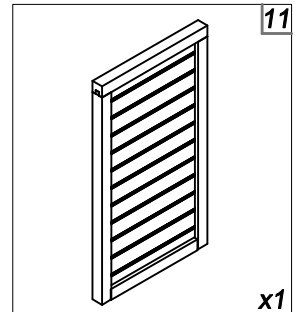
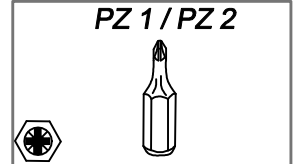
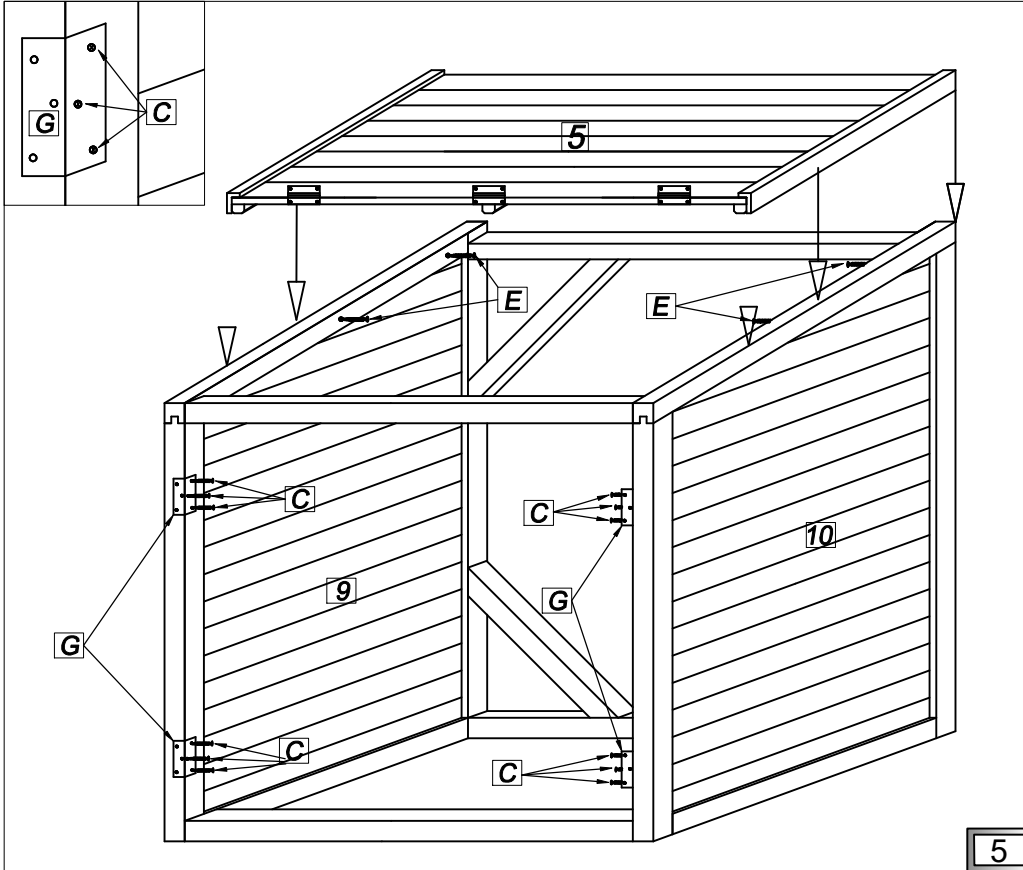
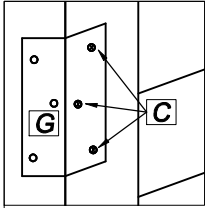
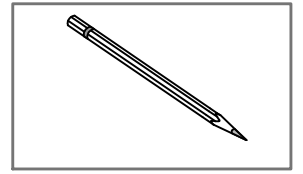
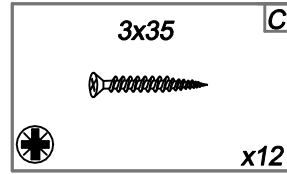
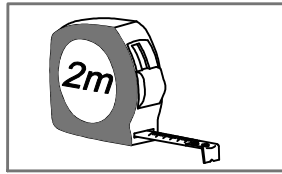
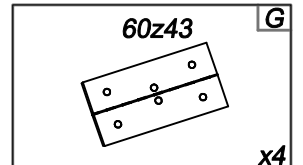
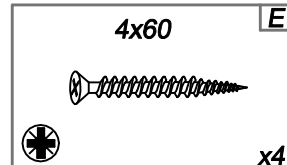
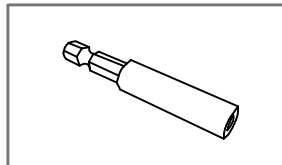
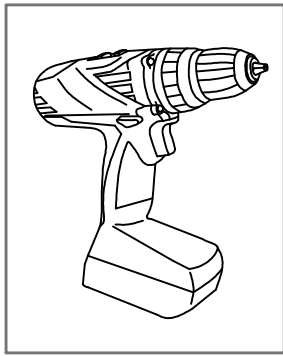



**(PL)** Struktura drewniana

**(GB)** Wooden structure

**(DE)** Holzstruktur

**(FR)** La structure bois

**(IT)** Struttura in legno

**(NL)** Houten structuur

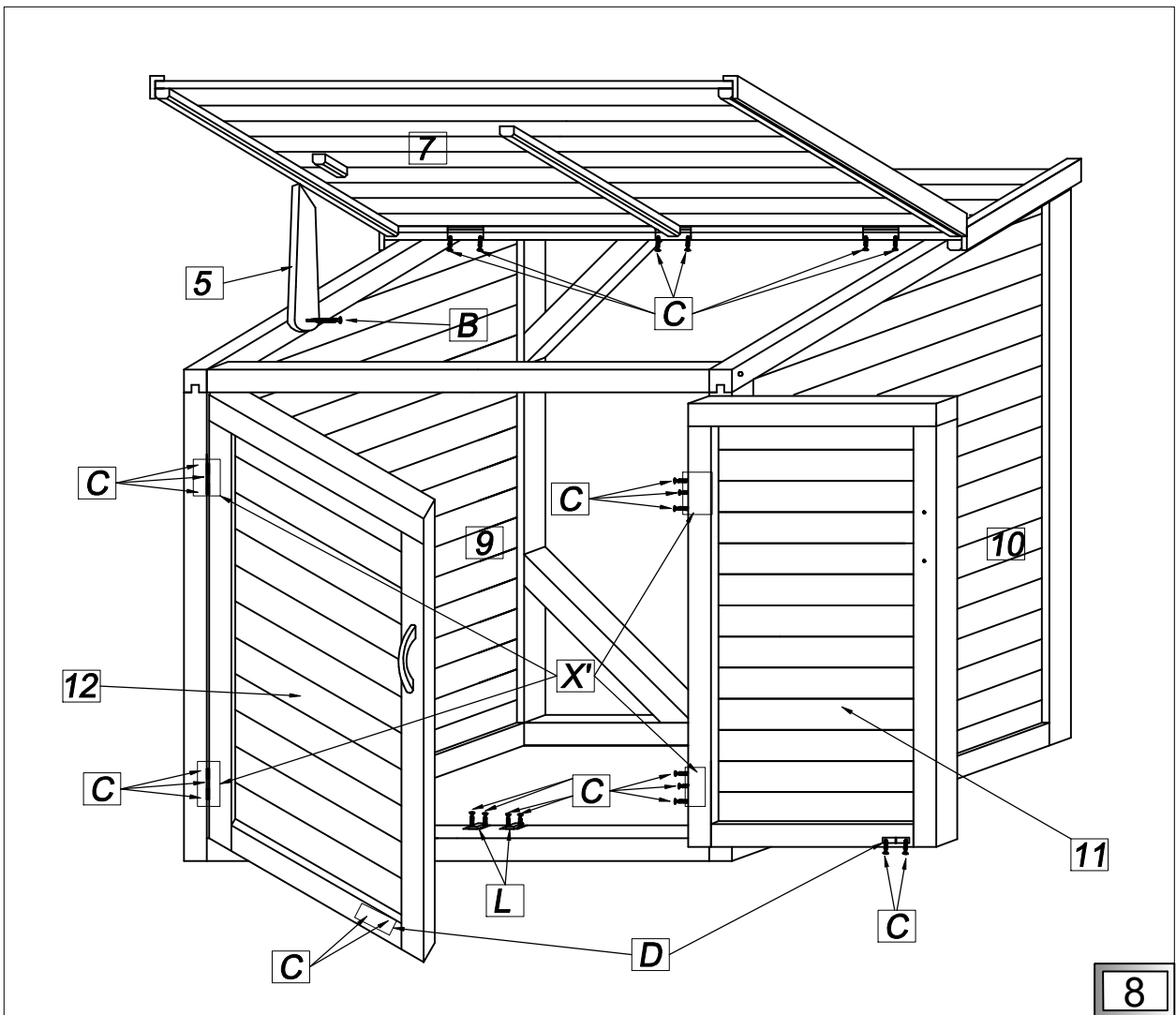
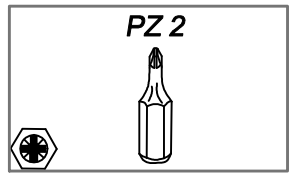
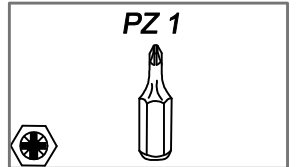
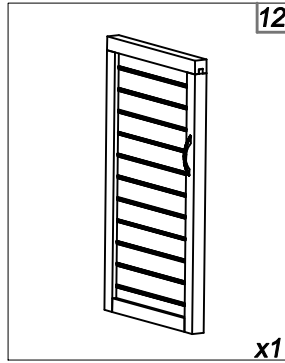
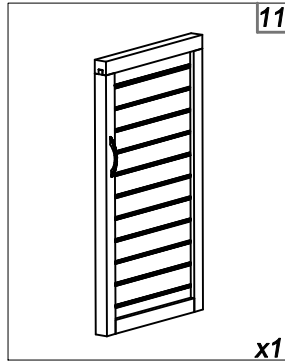
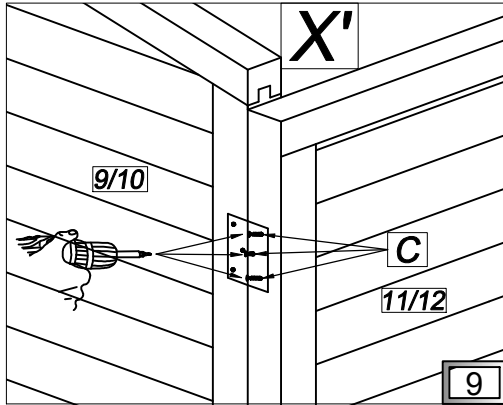
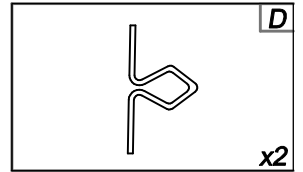
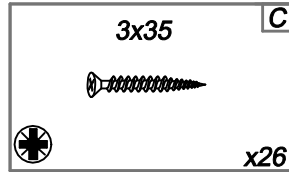
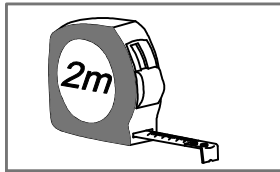
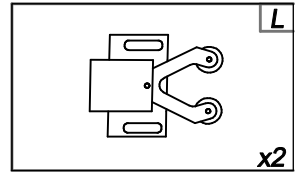
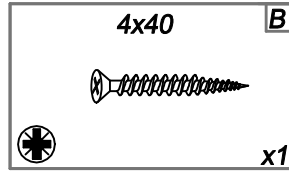
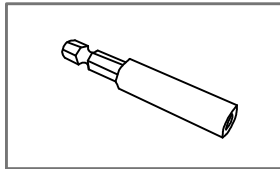
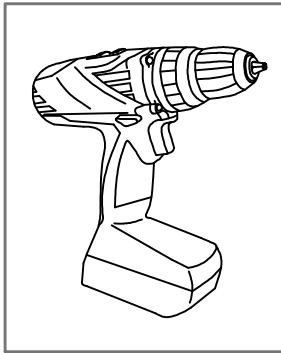

**(PL)** Struktura drewniana

**(GB)** Wooden structure

**(DE)** Holzstruktur

**(FR)** La structure bois

**(IT)** Struttura in legno

**(NL)** Houten structuur

