

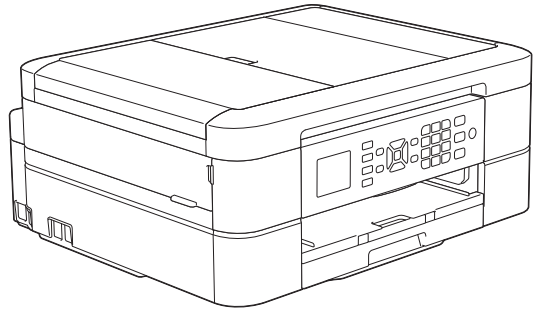

Reference Guide

Brief explanations for routine operations

MFC-J491DW
MFC-J497DW



Brother recommends keeping this guide next to your Brother machine for quick reference.



Online User's Guide

For more advanced instructions, information, and product specifications, see the *Online User's Guide* at support.brother.com/manuals



User's Guides and Where to Find Them

Which Guide?	What's in It?	Where Is It?
Product Safety Guide	Read this guide first. Please read the Safety Instructions before you set up your machine. See this guide for trademarks and legal limitations.	Printed / In the box
Quick Setup Guide	Follow the instructions for setting up your machine, and installing the Full Driver & Software Package for the operating system and connection type you are using.	Printed / In the box
Reference Guide	Learn the basic PC-Print, Scan, Copy and Fax operations and basic machine maintenance. See troubleshooting tips.	Printed or on Brother Installation Disc / In the Box
Online User's Guide	This guide includes the additional contents of the <i>Reference Guide</i> . In addition to information about the PC-Print, Scan, Copy, Fax, Internet services, Mobile Functions and Brother ControlCenter operations, useful information is included about using the machine on a network.	Brother Solutions Center ¹

¹ Visit support.brother.com/manuals.

For the Latest Driver Updates

Go to your model's **Downloads** page on the Brother Solutions Center at support.brother.com to download drivers. To keep your machine's performance up-to-date, check there for the latest firmware upgrades.

©2018 Brother Industries, Ltd. All rights reserved.

Questions or Problems? Take a Look at our FAQs, Solutions, and Videos Online.

Go to your model's **FAQs & Troubleshooting** page on the Brother Solutions Center at support.brother.com.

- Provides several ways to search
- Displays related questions for more information
- Receives regular updates based on customer feedback

Control Panel Overview

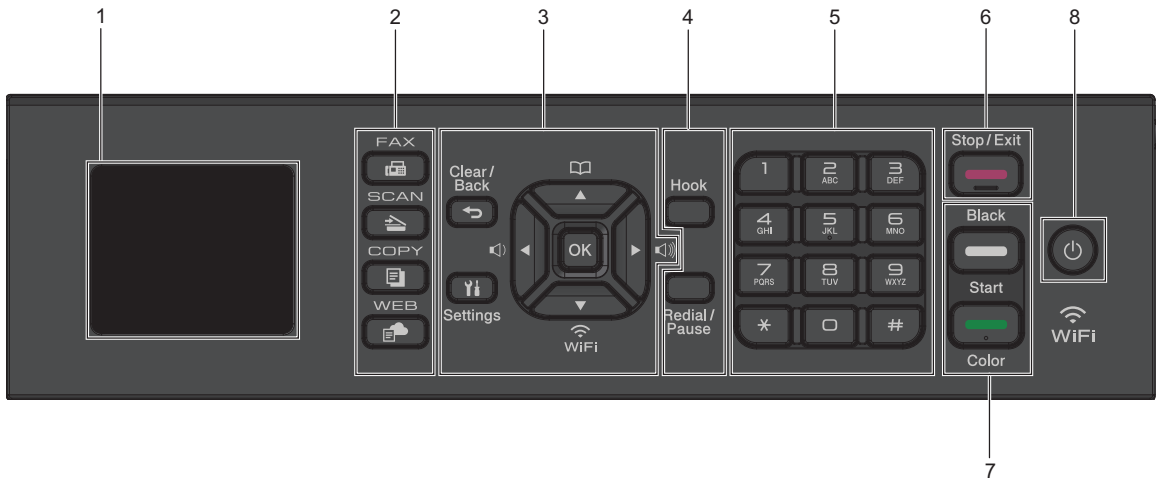

1. 1.8" Liquid Crystal Display (LCD)

Displays messages to help you set up and use the machine.

2. Mode buttons



Press to switch the machine to Fax mode.



Press to switch the machine to Scan mode.



Press to switch the machine to Copy mode.



Press to switch the machine to Web mode.

3. Settings buttons



Press to go back to the previous menu level.



Press to access the main menu.



Press to select a setting.



Press to adjust the ring volume while the machine is idle.



- Press to store Speed Dial and Group numbers in the machine's memory.
- Press to look up and dial numbers that are stored in the machine's memory.



Press to configure the wireless settings while the machine is idle.



Press to scroll through the menus and options.



- Press to move the cursor left or right on the LCD.
- Press to either confirm or cancel a procedure which is in progress.

4. Telephone buttons

Hook

Press before dialing to ensure a fax machine answers, and then press **Black Start** or **Color Start**.

If the machine is in Fax/Tel (F/T) mode and you pick up the handset of an external telephone during the F/T ring (pseudo/double-ring), press **Hook** to talk.

Redial/Pause

- Press to redial the last number you called.
- Press to select and redial the numbers from the Outgoing Call history or Caller ID history.
- Press to insert a pause when dialing numbers.

5. Dial Pad

- Use to dial fax and telephone numbers.
- Use as a keyboard to enter text or characters.

6. Stop/Exit

- Press to stop an operation.
- Press to exit from a menu.

7. Start buttons

Black Start

- Press to start sending faxes in black and white.
- Press to start making copies in black and white.
- Press to start scanning documents (in color or black and white depending on the scan setting).

Color Start

- Press to start sending faxes in full color.
- Press to start making copies in full color.
- Press to start scanning documents (in color or black and white depending on the scan setting).

8. **Power On/Off**

Press  to turn on the machine.

Press and hold down  to turn off the machine. The LCD displays [Shutting Down] and stays on for a few seconds before turning itself off. If you have connected an external telephone or TAD, it is always available.

If you turn off the machine using , it will still clean the print head periodically to maintain print quality. To prolong print head life, provide better ink efficiency, and maintain print quality, keep your machine connected to a power source at all times.

LCD Overview

This screen shows the machine's status when the machine is idle. When displayed, this indicates that your machine is ready for the next command.

Home Screen



1. Quiet Mode



This icon appears when the [Quiet Mode] setting is set to [On].

The Quiet Mode setting can reduce printing noise. When Quiet Mode is turned on, the print speed becomes slower.

For more detailed information, see the *Online User's Guide*.

2. Wireless Status

Each icon in the following table shows the wireless network status:

	The wireless network is connected. A three-level indicator in the Home screen displays the current wireless signal strength.
	The wireless access point cannot be detected.
	The wireless setting is disabled.

3. [Ink]

Displays the approximate available ink volume.

When an ink cartridge is near the end of its life or having a problem, an error icon is displayed on the ink color.

4. **Date and Time**

Displays the date and time set on the machine.

5. **Faxes in Memory**

Displays how many received faxes are in the machine's memory.

6. **Receive Mode**

Displays the current Receive Mode.



When the Distinctive Ring feature is turned on, the LCD displays [D/R].

2

Paper Handling

Load Paper

1 Load the paper in the paper tray as follows.

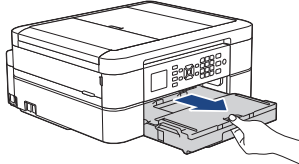
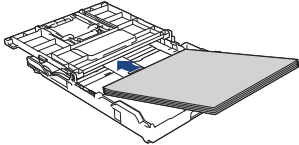
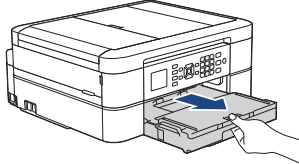
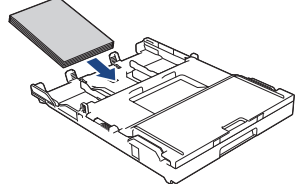

Fan the stack of paper well.

Tray #1	How to Load Paper	
Letter/A4 Legal Executive A5/A6 Photo 2L Index card Envelopes	 Adjust the paper guides.	 Printing surface: Face down
Photo	 Adjust the paper guides.	 Printing surface: Face down

For more detailed information, see the *Online User's Guide: Load Paper*.

2 Unfold the paper support flap. Change the paper size setting in the machine's menu, if needed.

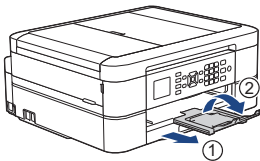

Load Documents

Place the document in the ADF or on the scanner glass as shown in the illustration.

Automatic Document Feeder (ADF)

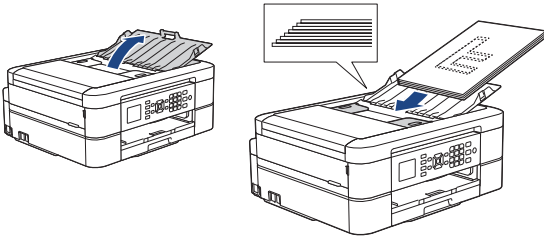

Place your document face down in the ADF.

Scanner Glass

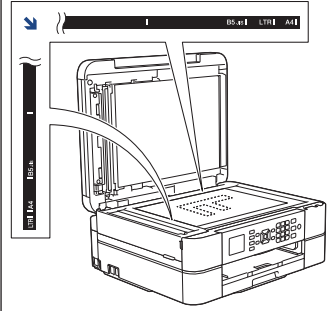

Place the document face down in the upper left corner of the scanner glass.

Print from Your Computer

Before attempting any printing operation, confirm the following:

- Make sure you have installed the Brother software and drivers.
- Make sure the USB cable is connected correctly, or that you are connected to the network using your wireless access point/router.

Print a Document (Windows®)

- 1 Select the print command in your application.
- 2 Select **Brother MFC-XXXX Printer** (where XXXX is the name of your model).
- 3 Click **Print**.
- 4 Complete your print operation.

Print a Document (Mac)

- 1 From an application, such as Apple TextEdit, click the **File** menu, and then select **Print**.
- 2 Select **Brother MFC-XXXX** (where XXXX is the name of your model).
- 3 Click **Print**.
- 4 Complete your print operation.

Various Printing

To use the various printing features, click the printing properties or preferences button to change the printer setting.

Print on Both Sides of the Paper Automatically



Print More Than One Page on a Single Sheet of Paper (N in 1)



For Windows®:

For more detailed information, see the *Online User's Guide: Print from Your Computer (Windows®)*.

For Mac:

For more detailed information, see the *Online User's Guide: Print from Your Computer (Mac)*.

Copy a Document

1 Make sure you have loaded the correct size paper in the paper tray.

2 Load your document.

3 Press  (**COPY**).

The LCD displays:

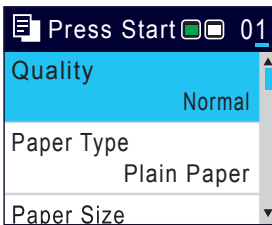

4 Enter the number of copies in one of the following ways:

- Press **-** or **+** on the control panel.
- Enter the number of copies using the dial pad.

5 Change the copy settings, if needed.

Press **▲** or **▼** to scroll through the copy settings. When the setting you want is highlighted, press **OK**.



- When you load paper other than Letter size Plain Paper, you must change the [Paper Size] and [Paper Type] settings.

6 When finished, press **Black Start** or **Color Start**.



To stop copying, press **Stop/Exit**.

Other Copy Options

You can use various copy features by changing copy settings.

Enlarge or Reduce Copied Images

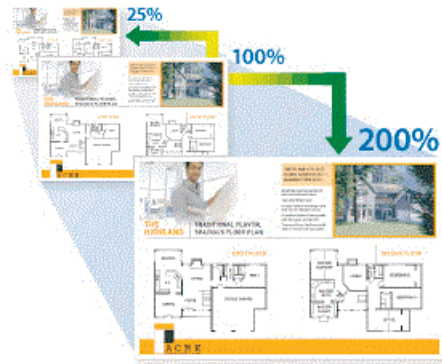

2-sided Copy

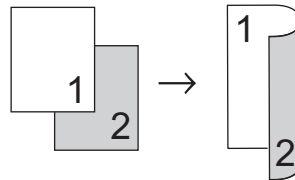

For more detailed information, see the *Online User's Guide: Copy*.

Before Scanning

Before attempting to scan, confirm the following:

- Make sure you have installed the Brother software and drivers.
- Make sure the USB cable is connected correctly, or that you are connected to the network using your wireless access point/router.

Scan from Your Computer

There are several ways you can use your computer to scan photos and documents on your Brother machine. Use the software applications provided by Brother, or use your favorite scanning application.

For more detailed information, see the *Online User's Guide: Scan from Your Computer (Windows®)* or *Scan from Your Computer (Mac)*.

Scan Using the Scan Button on the Machine

- 1 Load your document.
- 2 Press  (SCAN).
- 3 Press ▲ or ▼ to select the [to PC] option, and then press **OK**.
- 4 Press ▲ or ▼ to select the [to File] option, and then press **OK**.
- 5 If the machine is connected over the network, press ▲ or ▼ to select the

computer where you want to send data, and then press **OK**.



If the LCD prompts you to enter a PIN, use the control panel to enter the four-digit PIN for the computer, and then press **OK**.

6

Do one of the following:

- To change the settings, go to the next step.
- To use the default settings, press **Black Start** or **Color Start**.



[Scan Type] depends on the default settings. Pressing **Black Start** or **Color Start** does not allow you to change the settings.

7

Press ▲ or ▼ to select the [Scan Settings] setting, and then press **OK**.



To use the [Scan Settings] option, a computer with either ControlCenter4 (Windows®) or Brother iPrint&Scan (Mac) software installed must be connected to the machine.

8

Press ▲ or ▼ to select the [Set at Device] setting, and then press **OK**.

9

Change the scan settings you want to change, such as scan type, resolution, file type and document size, if needed. When finished press **OK**.

10

Press **Black Start** or **Color Start**.

Before Faxing

Telephone Line Interference/ VoIP

If you are having problems sending or receiving a fax due to possible interference on the telephone line or if you are using a VoIP system, we recommend changing the modem speed to minimize errors in fax operations.

- 1 Press **Settings**.
- 2 Press **▲** or **▼** to select the following:
 - a. Select [Initial Setup]. Press **OK**.
 - b. Select [Compatibility]. Press **OK**.
 - c. Select [Normal] or [Basic (for VoIP)]. Press **OK**.
 - [Basic (for VoIP)] reduces the modem speed to 9,600 bps and turns off color fax receiving and Error Correction Mode (ECM), except for color fax-sending. Unless interference is a recurring problem on your telephone line, you may prefer to use it only when needed.
To improve compatibility with most VoIP services, Brother recommends changing the compatibility setting to [Basic (for VoIP)].
 - [Normal] sets the modem speed at 14,400 bps.

- 3 Press **Stop/Exit**.



- VoIP (Voice over IP) is a type of phone system that uses an Internet connection, rather than a traditional phone line.

Send a Fax

- 1 Load your document in the ADF or place it on the scanner glass.

- 2 Press  (**FAX**).

The LCD displays:

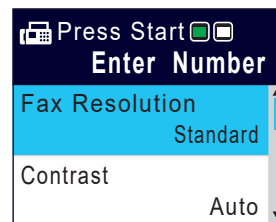

- 3 Enter the fax number in one of the following ways:
 - Dial Pad (Enter the fax number manually.)
Press all digits of the number using the dial pad.
 - Redial (Redial the last number you dialed.)
Press **Redial/Pause**.
 - Outgoing call (Select a number from the Outgoing Call history.)
Press **▲** or **▼** to select the following:
 - a. Select [Call History]. Press **OK**.
 - b. Select [Outgoing Call]. Press **OK**.
 - c. Select the number you want, and then press **OK**.
 - d. Press **▶** to select [Apply].

- Caller ID (Select a number from the Caller ID history.)

Press ▲ or ▼ to select the following:

- Select [Call History]. Press **OK**.
- Select [Caller ID History]. Press **OK**.
- Select the number you want, and then press **OK**.
- Press ► to select [Apply].

- [Address Book] (Select a number from the Address Book.)

Press ▲ or ▼ to select the following:

- Select [Address Book]. Press **OK**.
- Select [Search]. Press **OK**.
- Do one of the following:
 - Enter the two-digit Speed Dial number using the dial pad.
 - Select a number from the list in the following ways:
 - Select [Alphabetical Order] or [Numerical Order]. Press **OK**.
 - Select the number you want. Press **OK**.
 - Press ► to select [Apply].

4 To change the fax settings, press ▲ or ▼ to select the setting you want to change, and then press **OK**.

5 When finished, press **Black Start** or **Color Start**.

6 Do one of the following:

- If you are using the ADF, the machine starts scanning and sending the document.
- If you are using the scanner glass and pressed **Black Start**, the machine starts scanning the first page.

Go to the next step.

- If you are using the scanner glass and pressed **Color Start**, the LCD asks if you want to send a color fax.

Press ► to confirm. The machine starts dialing and sending the document.

7 When the LCD displays [Next page?], do one of the following:

- Press ► to scan another page. Place the next page on the scanner glass, and then press ►. The machine starts scanning the page.
Repeat this step for each additional page.
- Press ◀ to send the fax when finished scanning pages. The machine starts sending the document.

Choose the Correct Receive Mode

The correct Receive Mode for you is determined by the external devices and telephone subscriber services (Voice Mail, Distinctive Ring and so on) you will be using on the same line as the Brother machine.

Will you be using a Distinctive Ring number for receiving faxes? (USA and Canada only)

Brother uses the term "Distinctive Ring" but different telephone companies may have other names for this service.

Will you be using Voice Mail on the same telephone line as your Brother machine?

If you have Voice Mail on the same telephone line as your Brother machine, there is a strong possibility that Voice Mail and the Brother machine will conflict with each other when receiving incoming calls. Select Manual Mode as your Receive Mode.



If you do not want to answer every call manually to determine whether it's a voice call or a fax, contact your telephone provider and ask about Distinctive Ring services.

Will you be using a Telephone Answering Device on the same telephone line as your Brother machine?

Your external telephone answering device (TAD) will answer every call automatically. Voice messages are stored on the external TAD and fax messages are printed. Select [External TAD] as your Receive Mode.

Will you be using your Brother machine on a dedicated fax line?

Your machine automatically answers every call as a fax. Select [Fax Only] as your Receive Mode.

Will you be using your Brother machine on the same line as your telephone?

- **Do you want to receive voice calls and faxes automatically?**

Select [Fax/Tel] mode when your Brother machine and your telephones share the same line.

Important Note: You cannot receive voice messages on either Voice Mail or an answering machine if you select [Fax/Tel] mode.

- **Do you expect to receive very few faxes?**

Select [Manual] as your Receive Mode. You control the telephone line and must answer every call yourself.

1 Press **Settings**.

2 Press **▲** or **▼** to select the following:

- a. Select [Fax]. Press **OK**.
- b. Select [Setup Receive]. Press **OK**.
- c. Select [Receive Mode]. Press **OK**.



If you cannot change the [Receive Mode] option, make sure the Distinctive Ring feature is set to [Off].

3 Press **▲** or **▼** to select the [Fax Only], [Fax/Tel], [External TAD], or [Manual] option, and then press **OK**.

4 Press **Stop/Exit**.

Check the Print Quality

If faded or streaked colors and text appear or if text is missing on your printouts, the print head nozzles may be clogged. Print the Print Quality Check Sheet and look at the nozzle check pattern.

- 1 Press **Settings**.
- 2 Press **▲** or **▼** to select the following:
 - a. Select [General Setup]. Press **OK**.
 - b. Select [Maintenance]. Press **OK**.
 - c. Select [Impr. PrintQuality]. Press **OK**.
 - d. Select [Impr. PrintQuality] again. Press **OK**.
- 3 Press **▶**.
The machine prints the Print Quality Check Sheet.
- 4 Check the quality of the four color blocks on the sheet.
- 5 The LCD asks about the print quality. Do one of the following:
 - If all lines are clear and visible, press **◀** to select [No].
The Print Quality check finishes.
 - If lines are missing (see **Poor**, below), press **▶** to select [Yes].

OK

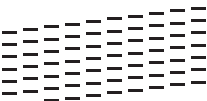

Poor

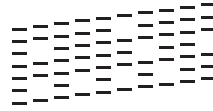

- 6 The LCD asks you to check the print quality of each color. Press **◀** or **▶** to select the pattern (1–4) that most closely matches the printing result, and then press **OK**.
- 7 Do one of the following:
 - If print head cleaning is needed, press **▶** to start the cleaning procedure.
 - If print head cleaning is not needed, the Ink or Maintenance screen reappears on the LCD.
- 8 After the cleaning procedure is finished, the LCD asks if you want to check the print quality again.
Press **▶** [Yes] to start the print quality check.
- 9 Press **▶** again.
The machine prints the Print Quality Check Sheet again. Check the quality of the four color blocks on the sheet again.

If you clean the print head and the print has not improved, try installing a new Genuine Brother Brand replacement ink cartridge for each problem color. Try cleaning the print head again. If the print has not improved, contact Brother Customer Service.

IMPORTANT

DO NOT touch the print head. Touching the print head may cause permanent damage and may void the print head's warranty.



When a print head nozzle is clogged, the printed sample looks like this.



After the print head nozzle is cleaned, the horizontal lines are gone.



For more detailed information, see the *Online User's Guide: If You Are Having Difficulty with Your Machine.*

Check the Print Alignment from Your Brother Machine

If your printed text becomes blurred or images become faded after transporting the machine, adjust the print alignment.

- 1 Press **Settings**.
- 2 Press **▲** or **▼** to select the following:
 - a. Select [General Setup]. Press **OK**.
 - b. Select [Maintenance]. Press **OK**.
 - c. Select [Impr. PrintQuality]. Press **OK**.
 - d. Select [Alignment]. Press **OK**.
- 3 Press **▶**.

- 4 Press **▶** again.

The machine starts printing the Alignment Check Sheet.

(A)

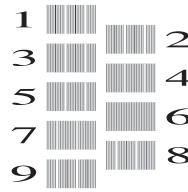

- 5 For pattern (A), press **◀** or **▶** to select the number of the test print that has the fewest visible vertical stripes (1-9), and then press **OK**.

In the example above, row number 6 is the best choice.

Repeat this step for the rest of the patterns.



When the print alignment is not adjusted correctly, text looks blurry or crooked, like this.

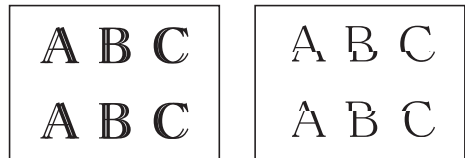

After the print alignment is adjusted correctly, text looks like this.



- 6 Press **Stop/Exit**.

Use this section to resolve problems you may encounter when using your Brother machine.

Identify the Problem

Even if there seems to be a problem with your machine, you can correct most problems yourself.

First, check the following:

- The machine's power cord is connected correctly and the machine's power is on.
- All of the machine's orange protective parts have been removed.
- The ink cartridges are installed correctly.
- The Scanner Cover and the Jam Clear Cover are fully closed.
- Paper is inserted correctly in the paper tray.
- The interface cables are securely connected to the machine and the computer, or the wireless connection is set up on both the machine and your computer.
- (For network models) The access point (for wireless), router, or hub is turned on and its link button is blinking.

To find the error and the solution, check the LCD or the machine's status in **Status Monitor** on your computer.

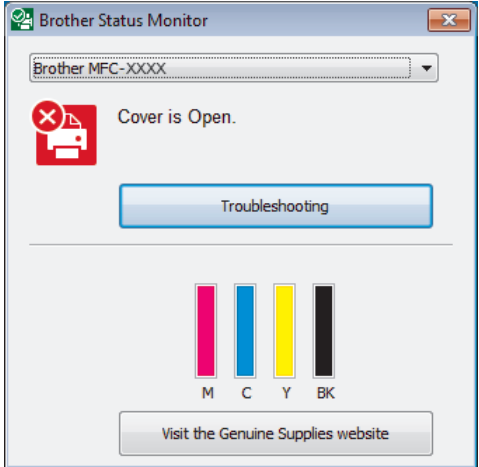
Using the LCD	Using the Status Monitor
<ol style="list-style-type: none"> 1. Follow the messages on the LCD. 2. See the instructions in the following Error and Maintenance Messages table. 3. If you cannot resolve the error, see the <i>Online User's Guide: Error and Maintenance Messages</i>. 	<ul style="list-style-type: none"> • Double-click the  icon in the task tray. • Each color of the icon indicates the machine's status. • Click the Troubleshooting button to access Brother's troubleshooting website.  <p>The screenshot shows the 'Brother Status Monitor' window. At the top, there is a dropdown menu showing 'Brother MFC-XXXX'. Below that, a red icon with a white 'X' is next to the text 'Cover is Open.'. A blue button labeled 'Troubleshooting' is positioned below the error message. At the bottom of the window, there are four vertical bars representing ink levels: Magenta (M), Cyan (C), Yellow (Y), and Black (BK). Below these bars is a button labeled 'Visit the Genuine Supplies website'.</p>

Error and Maintenance Messages

The most common error and maintenance messages are shown in the table. For more detailed information, see the *Online User's Guide*.

You can correct most errors and perform routine maintenance yourself. If you need more tips, go to your model's **FAQs & Troubleshooting** page on the Brother Solutions Center at support.brother.com.

Error Message	Action
Absorber NearFull	<p>The ink absorber box must be replaced soon. Call Brother Customer Service or a Brother Authorized Service Center to have your machine serviced.</p> <ul style="list-style-type: none"> The ink absorber box absorbs the small amount of ink emitted during print head cleaning.
B&W Print Only Replace Ink	<p>One or more of the color ink cartridges have reached the end of their lives.</p> <p>Replace the ink cartridges.</p> <p>For more detailed information, see the <i>Online User's Guide: Replace the Ink Cartridges</i>.</p> <p>The machine will stop all print operations and you will not be able to use the machine until you change to a new ink cartridge in the following cases:</p> <ul style="list-style-type: none"> If you unplug the machine or take out the ink cartridge. If you select the Slow Drying Paper option on the machine or in the printer driver.
Cannot Detect	Remove the used ink cartridge and install a new one.
	Use a new Genuine Brother Ink Cartridge. If the error is not cleared, call Brother Customer Service.
	Take out the new ink cartridge and reinstall it slowly and firmly until it locks into place.
	For more detailed information, see the <i>Online User's Guide: Replace the Ink Cartridges</i> .
	Slowly turn the ink cartridge so that the ink supply port is pointing downward, and then reinstall the cartridge.
	Check the model numbers of the ink cartridges and install the correct ink cartridges. See <i>Related Information: Supply Specifications</i> at the end of this section.
Cannot Detect Ink	Use a new Genuine Brother Ink Cartridge. If the error is not cleared, call Brother Customer Service.
Data Remaining	Press Stop/Exit . The machine will cancel the job and clear it from the memory. Try to print again.

Error Message	Action
Disconnected	<p>Try to send or receive again.</p> <p>If calls are stopped repeatedly and you are using a VoIP (Voice over IP) system, try changing the Compatibility to Basic (for VoIP).</p> <p>See <i>Related Information: Telephone Line Interference/VoIP</i> at the end of this section.</p>
Document Jam	<p>The document was not inserted or fed correctly, or the document scanned from the ADF was too long.</p> <p>For more detailed information, see the <i>Online User's Guide: Document Jams</i>.</p>
DR Mode in Use	<p>The machine is in Distinctive Ring mode. You cannot change the Receive Mode from Manual to another mode.</p> <p>Set Distinctive Ring to Off.</p> <p>For more detailed information, see the <i>Online User's Guide: Turn off Distinctive Ring</i>.</p>
High Temperature	<p>After cooling the room, allow the machine to cool down to room temperature. Try again when the machine has cooled down.</p>
Ink Absorber Full	<p>The ink absorber box must be replaced. Call Brother Customer Service or a Brother Authorized Service Center to have your machine serviced.</p>
Ink Low	<p>One or more of the ink cartridges are near the end of their lives.</p> <p>Order a new ink cartridge. You can continue printing until the LCD displays <i>Replace Ink</i>.</p> <p>For more detailed information, see the <i>Online User's Guide: Replace the Ink Cartridges</i>.</p> <ul style="list-style-type: none"> You can still scan even if the ink is low or needs to be replaced.
Jam A Inside/ Front Repeat Jam A	<p>Remove the jammed paper.</p> <p>For more detailed information, see the <i>Online User's Guide: Printer Jam or Paper Jam</i>.</p> <p>Make sure the paper guides are set to the correct paper size.</p> <p>DO NOT extend the paper tray when you load A5 or smaller size paper.</p>
Jam B Front Repeat Jam B Front	<p>Remove the jammed paper.</p> <p>For more detailed information, see the <i>Online User's Guide: Printer Jam or Paper Jam</i>.</p> <p>Make sure the paper guides are set to the correct paper size.</p> <p>DO NOT extend the paper tray when you load A5 or smaller size paper.</p>

Error Message	Action
Jam C Rear	<p>Remove the jammed paper.</p> <p>For more detailed information, see the <i>Online User's Guide: Printer Jam or Paper Jam</i>.</p>
	<p>Make sure the paper guides are set to the correct paper size.</p> <p>DO NOT extend the paper tray when you load A5 or smaller size paper.</p>
	<p>Clean the paper pick-up rollers.</p> <p>For more detailed information, see the <i>Online User's Guide: Clean the Paper Pick-up Rollers</i>.</p>
Low Temperature	<p>After warming the room, allow the machine to warm up to room temperature. Try again when the machine has warmed up.</p>
No Caller ID	<p>There is no incoming call history. You did not receive calls or you have not subscribed to the Caller ID service from your telephone company.</p> <p>To use the Caller ID feature, call your telephone company.</p> <p>For more detailed information, see the <i>Online User's Guide: Caller ID</i>.</p>
No Ink Cartridge	<p>Remove the new ink cartridge and re-install it slowly and firmly until it locks into place.</p> <p>For more detailed information, see the <i>Online User's Guide: Replace the Ink Cartridges</i>.</p>
No Paper Fed	<p>Do one of the following:</p> <ul style="list-style-type: none"> • Refill the paper tray, and then press ►. • Remove and reload the paper, and then press ►.
	<p>The Jam Clear Cover is not closed correctly.</p>
No Paper Fed Again	<p>Clean the paper pick-up rollers.</p> <p>For more detailed information, see the <i>Online User's Guide: Clean the Paper Pick-up Rollers</i>.</p>
Not Registered	<p>You tried to access a Speed Dial number that has not been stored in the machine.</p> <p>Set up the Speed Dial number.</p>
Out of Fax Memory	<p>Print the faxes stored in the memory. For more detailed information, see the <i>Online User's Guide: Print a Fax Stored in the Machine's Memory</i>.</p>
Out of Memory	<p>If a fax-sending or copy operation is in progress:</p> <ul style="list-style-type: none"> • Press Stop/Exit and wait until the other operations that are in progress finish, and then try again. • Press ► to select Partial Print to copy the pages scanned so far. • Print the faxes stored in the memory. <p>For more detailed information, see the <i>Online User's Guide: Print a Fax Stored in the Machine's Memory</i>.</p>

Error Message	Action
Paper Size Mismatch	<ol style="list-style-type: none"> 1. Check that the paper size you selected on the machine's display matches the size of the paper in the tray. For more detailed information, see the <i>Online User's Guide: Change the Paper Size and Paper Type</i>. 2. Make sure you loaded the paper in a Portrait position, by setting the paper guides at the indicators for your paper size. For more detailed information, see the <i>Online User's Guide: Load Paper</i>. 3. After you have checked the paper size and the paper position, follow the LCD instructions. <p>If printing from your computer, make sure the paper size you selected in the printer driver matches the size of paper in the tray. For more detailed information, see the <i>Online User's Guide: Print Settings (Windows®) or Print Options (Mac)</i>.</p>
Replace Ink	<p>One or more of the ink cartridges have reached the end of their lives. Replace the ink cartridges.</p> <p>For more detailed information, see the <i>Online User's Guide: Replace the Ink Cartridges</i>.</p> <ul style="list-style-type: none"> • You can still scan even if the ink is low or needs to be replaced.
Tray not detected	<p>Slowly push the paper tray completely into the machine.</p> <p>Paper or a foreign object has prevented the paper tray from being inserted correctly.</p> <p>Pull the paper tray out of the machine, and remove the jammed paper or foreign object. If you cannot find or remove the jammed paper, see the <i>Online User's Guide: Printer Jam or Paper Jam</i>.</p>
Tray Settings	<p>This message is displayed when the setting to confirm the paper type and size is enabled.</p> <p>To not display this confirmation message, change the setting to Off.</p> <p>For more detailed information, see the <i>Online User's Guide: Change the Check Paper Size Setting</i>.</p>
Unable to Clean XX Unable to Init. XX Unable to Print XX	<p>A foreign object, such as a paper clip or a piece of ripped paper, is in the machine.</p> <p>Open the scanner cover and remove any foreign objects and paper scraps from inside the machine.</p> <p>If the error message continues:</p> <ul style="list-style-type: none"> • Transfer your faxes to another fax machine or your computer before disconnecting the machine so you will not lose any important messages. Then, disconnect the machine from the power for several minutes and reconnect it. <p>For more detailed information, see the <i>Online User's Guide: Transfer Your Faxes or Fax Journal Report</i>.</p>

Error Message	Action
Unable to Scan XX	<ul style="list-style-type: none"> • Transfer your faxes to another fax machine or your computer before disconnecting the machine so you will not lose any important messages. Then, disconnect the machine from the power for several minutes and reconnect it. <p>For more detailed information, see the <i>Online User's Guide: Transfer Your Faxes or Fax Journal Report</i>.</p>
Wrong Ink Cartridge	<p>The ink cartridge model number is not compatible with your machine.</p> <p>Verify whether the cartridge model number will work with your machine.</p> <p>See <i>Related Information: Supply Specifications</i> at the end of this section.</p>
Wrong Ink Color	<p>Check which ink cartridges are not matched by color to their ink cartridge positions and move them to their correct positions.</p>

Related Information

- Telephone Line Interference/VoIP on page 11
 - Supply Specifications on page 23
-

Enter Text on Your Brother Machine

- The characters that are available may differ depending on your country.

When you are setting certain menu selections, such as the Station ID, you may need to enter text into the machine. Most dial pad buttons have three or four letters printed on the buttons. The buttons for **0**, **#** and ***** do not have printed letters because they are used for special characters.

Press the appropriate dial pad button the number of times shown in this reference table to access the character you want.

Press Button	One Time	Two Times	Three Times	Four Times	Five Times	Six Times	Seven Times	Eight Times	Nine Times
2	A	B	C	a	b	c	2	A	B
3	D	E	F	d	e	f	3	D	E
4	G	H	I	g	h	i	4	G	H
5	J	K	L	j	k	l	5	J	K
6	M	N	O	m	n	o	6	M	N
7	P	Q	R	S	p	q	r	s	7
8	T	U	V	t	u	v	8	T	U
9	W	X	Y	Z	w	x	y	z	9

- To move the cursor to the left or right, press **▲**, **▼**, **◀** or **▶** to select or , and then press **OK**.

Inserting spaces

- To enter a space, press **▲**, **▼**, **◀** or **▶** to select , and then press **OK**.

Making corrections

- If you entered an incorrect number or letter and want to change it, press **▲**, **▼**, **◀** or **▶** to select or . Press **OK** several times to move the cursor under the incorrect character. Then press **▲**, **▼**, **◀** or **▶** to select , and press **OK**. Re-enter the correct letter.

Special characters and symbols

Press *****, **#** or **0** repeatedly until you see the special character or symbol you want.

Press *****

(space)! " # \$ % & ' () * + , - . / €

Press #	:: ; < = > ? @ [] ^ _
Press 0	English: Á Â Ã Ä Ç È É Ê Ë Ì Í Î Ï Ó Ô Õ Ö Ù Ú French: À Â Ç È É Ê Ë Ì Ô Ú Û Spanish: Á É Í Ñ Ó Ú

Supply Specifications

Ink	The machine uses individual Black, Yellow, Cyan and Magenta ink cartridges that are separate from the print head assembly.
Service Life of Ink Cartridge	The first time you install the ink cartridges, the machine will use extra ink to fill the ink delivery tubes. This is a one-time process that enables high-quality printing. Replacement ink cartridges will print the number of pages specified later in this table. Starter cartridge yield is approximately the same as that of the LC3011 replacement cartridges.
Replacement Supplies	<Standard Yield Black> LC3011BK <Standard Yield Yellow> LC3011Y <Standard Yield Cyan> LC3011C <Standard Yield Magenta> LC3011M Black, Yellow, Cyan and Magenta - Approximately 200 pages ¹
	<High Yield Black> LC3013BK <High Yield Yellow> LC3013Y <High Yield Cyan> LC3013C <High Yield Magenta> LC3013M Black, Yellow, Cyan and Magenta - Approximately 400 pages ¹
	For more information about replacement supplies, visit us at www.brother.com/pageyield
What is Innobella? 	Innobella is a range of genuine supplies offered by Brother. The name "Innobella" derives from the words "Innovation" and "Bella" (meaning "Beautiful" in Italian) and is a representation of the "innovative" technology providing you with "beautiful" and "long lasting" print results. When you print photo images, Brother recommends Innobella glossy photo paper (BP71 series) for high quality. Brilliant prints are made easier with Innobella Ink and paper.

¹ Approx. cartridge yield is declared in accordance with ISO/IEC 24711



If using Windows[®], double-click the **Brother Creative Center** icon  on your desktop to access our **FREE** website designed as a resource to help you easily create and print customized materials for business and home use with photos, text and creativity.

Mac users can access Brother CreativeCenter at this web address:
www.brother.com/creativecenter

Brother International Corporation
200 Crossing Boulevard
P.O. Box 6911
Bridgewater, NJ 08807-0911 USA

Brother International Corporation (Canada) Ltd.
1 rue Hôtel de Ville,
Dollard-des-Ormeaux, QC, Canada H9B 3H6

brother

Visit us on the World Wide Web
www.brother.com

These machines are approved for use in the country of purchase only. Local Brother companies or their dealers will support only machines purchased in their own countries.

Made from 100% recycled paper
(excludes cover)



D00Z9R001-00
USA/CAN
Version 0